



**CFR 47 FCC PART 15 SUBPART E  
ISED RSS-247 ISSUE 2**

**TEST REPORT**

*For*

**BE11000 Whole Home Mesh Wi-Fi 7 System**

**MODEL NUMBER: Deco BE65**

**REPORT NUMBER: 4790733861-1-RF-2**

**ISSUE DATE: March 10, 2023**

**FCC ID: 2AXJ4BE65**

**IC: 26583-BE65**

*Prepared for*

**TP-Link Corporation Limited**

**Room 901, 9/F. , New East Ocean Centre, 9 Science Museum Road, Tsim Sha Tsui,  
Kowloon, Hong Kong**

*Prepared by*

**UL Verification Services (Guangzhou) Co., Ltd, Song Shan Lake Branch**

**Building 10, Innovation Technology Park, No. 1, Li Bin Road, Song Shan Lake Hi-  
Tech Development Zone Dongguan, 523808, People's Republic of China**

**Tel: +86 769 22038881**

**Fax: +86 769 33244054**

**Website: [www.ul.com](http://www.ul.com)**

The results reported herein have been performed in accordance with the laboratory's terms of accreditation. This report shall not be reproduced except in full without the written approval of the Laboratory. The results in this report apply to the test sample(s) mentioned above at the time of the testing period only and are not to be used to indicate applicability to other similar products.



Revision History

Rev.	Issue Date	Revisions	Revised By
V0	March 10, 2023	Initial Issue	

**Summary of Test Results**

Test Item	Clause	Limit/Requirement	Result
ON TIME AND DUTY CYCLE	ANSI C63.10-2013, Clause 12.2	None; for reporting purposes only.	Pass
6dB AND 26dB EMISSION BANDWIDTH AND 99% OCCUPIED BANDWIDTH	KDB 789033 D02 v02r01 Section C.1	FCC Part 15.407 (a)/(e), RSS-247 Issue 2, Clause 6.2.1.2 RSS-Gen Clause 6.7	Pass
CONDUCTED OUTPUT POWER	KDB 789033 D02 v02r01 Section E.3.a (Method PM)	FCC 15.407 (a) RSS-247 Clause 6.2	Pass
POWER SPECTRAL DENSITY	KDB 789033 D02 v02r01 Section F	FCC 15.407 (a) RSS-247 Clause 6.2	Pass
AC Power Line Conducted Emission	ANSI C63.10-2013, Clause 6.2.	FCC 15.207 RSS-GEN Clause 8.8	Pass
Radiated Emissions and Band Edge Measurement	KDB 789033 D02 v02r01 Section G.3, G.4, G.5, and G.6	FCC 15.407 (b) FCC 15.209 FCC 15.205 RSS-247 Clause 6.2 RSS-GEN Clause 8.9	Pass
FREQUENCY STABILITY	N/A	FCC 15.407 (g)	Pass
Dynamic Frequency Selection (Slave)	KDB 905462 D03 Client Without DFS New Rules v01r02	FCC Part 15.407 (h), RSS-247 Issue 2 Clause 6.3	N/A
Antenna Requirement	N/A	FCC 47 CFR Part 15.203/ 15.407(a)(1) (2), RSS-Gen Issue 5, Clause 6.8	Pass

**Note:**

1. N/A: In this whole report not applicable.

\*This test report is only published to and used by the applicant, and it is not for evidence purpose in China.

\*The measurement result for the sample received is <Pass> according to <CFR 47 FCC PART 15 SUBPART E><ISED RSS-247 ISSUE 2> when <Accuracy Method> decision rule is applied.

## CONTENTS

<b>1. ATTESTATION OF TEST RESULTS.....</b>	<b>6</b>
<b>2. TEST METHODOLOGY.....</b>	<b>7</b>
<b>3. FACILITIES AND ACCREDITATION.....</b>	<b>7</b>
<b>4. CALIBRATION AND UNCERTAINTY .....</b>	<b>8</b>
4.1. <i>MEASURING INSTRUMENT CALIBRATION .....</i>	<i>8</i>
4.2. <i>MEASUREMENT UNCERTAINTY.....</i>	<i>8</i>
<b>5. EQUIPMENT UNDER TEST .....</b>	<b>9</b>
5.1. <i>DESCRIPTION OF EUT .....</i>	<i>9</i>
5.2. <i>CHANNEL LIST .....</i>	<i>10</i>
5.3. <i>MAXIMUM EIRP .....</i>	<i>11</i>
5.4. <i>TEST CHANNEL CONFIGURATION.....</i>	<i>12</i>
5.5. <i>THE WORSE CASE POWER SETTING PARAMETER.....</i>	<i>13</i>
5.6. <i>WORSE CASE CONFIGURATIONS.....</i>	<i>16</i>
5.7. <i>DESCRIPTION OF AVAILABLE ANTENNAS .....</i>	<i>17</i>
5.8. <i>SUPPORT UNITS FOR SYSTEM TEST.....</i>	<i>19</i>
<b>6. MEASURING EQUIPMENT AND SOFTWARE USED.....</b>	<b>20</b>
<b>7. ANTENNA PORT TEST RESULTS .....</b>	<b>23</b>
7.1. <i>ON TIME AND DUTY CYCLE.....</i>	<i>23</i>
7.2. <i>6DB AND 26DB EMISSION BANDWIDTH AND 99% OCCUPIED BANDWIDTH ...</i>	<i>24</i>
7.3. <i>CONDUCTED OUTPUT POWER.....</i>	<i>26</i>
7.4. <i>POWER SPECTRAL DENSITY .....</i>	<i>28</i>
7.5. <i>FREQUENCY STABILITY.....</i>	<i>30</i>
<b>8. RADIATED TEST RESULTS.....</b>	<b>32</b>
8.1. <i>RESTRICTED BANDEDGE .....</i>	<i>42</i>
8.2. <i>SPURIOUS EMISSIONS(1 GHZ~7 GHZ) .....</i>	<i>76</i>
8.3. <i>SPURIOUS EMISSIONS(7 GHZ~18 GHZ) .....</i>	<i>88</i>
8.4. <i>SPURIOUS EMISSIONS(9 KHZ~30 MHZ) .....</i>	<i>146</i>
8.5. <i>SPURIOUS EMISSIONS(18 GHZ~26 GHZ) .....</i>	<i>149</i>
8.6. <i>SPURIOUS EMISSIONS(26 GHZ~40 GHZ) .....</i>	<i>151</i>
8.7. <i>SPURIOUS EMISSIONS(30 MHZ~1 GHZ).....</i>	<i>153</i>
<b>9. AC POWER LINE CONDUCTED EMISSION .....</b>	<b>155</b>
<b>10. ANTENNA REQUIREMENT .....</b>	<b>159</b>



<b>11.</b>	<b>TEST DATA.....</b>	<b>160</b>
11.1.	<i>APPENDIX A: EMISSION BANDWIDTH.....</i>	<i>160</i>
11.1.1.	Test Result.....	160
11.1.2.	Test Graphs.....	162
11.2.	<i>APPENDIX B: OCCUPIED CHANNEL BANDWIDTH.....</i>	<i>183</i>
11.2.1.	Test Result.....	183
11.2.2.	Test Graphs.....	185
11.3.	<i>APPENDIX C: MIN EMISSION BANDWIDTH.....</i>	<i>210</i>
11.3.1.	Test Result.....	210
11.3.2.	Test Graphs.....	211
11.4.	<i>APPENDIX D: MAXIMUM CONDUCTED OUTPUT POWER.....</i>	<i>222</i>
11.4.1.	Test Result.....	222
11.5.	<i>APPENDIX E: MAXIMUM POWER SPECTRAL DENSITY.....</i>	<i>225</i>
11.5.1.	Test Result.....	225
11.5.2.	Test Result.....	227
11.5.3.	Test Graphs.....	228
11.5.4.	Test Graphs.....	250
11.6.	<i>APPENDIX F: DUTY CYCLE.....</i>	<i>260</i>
11.6.1.	Test Result.....	260
11.6.2.	Test Graphs.....	261
11.7.	<i>APPENDIX G: FREQUENCY STABILITY.....</i>	<i>264</i>
11.7.1.	Test Result.....	264



# 1. ATTESTATION OF TEST RESULTS

## Applicant Information

Company Name: TP-Link Corporation Limited  
Address: Room 901, 9/F. , New East Ocean Centre, 9 Science Museum Road, Tsim Sha Tsui, Kowloon, Hong Kong

## Manufacturer Information

Company Name: TP-Link Corporation Limited  
Address: Room 901, 9/F. , New East Ocean Centre, 9 Science Museum Road, Tsim Sha Tsui, Kowloon, Hong Kong

## EUT Information

EUT Name: BE11000 Whole Home Mesh Wi-Fi 7 System  
Model: Deco BE65  
Brand: tp-link  
Sample Received Date: February 9, 2023  
Sample Status: Normal  
Sample ID: 5776030  
Date of Tested: February 20, 2023 to March 10, 2023

APPLICABLE STANDARDS	
STANDARD	TEST RESULTS
CFR 47 FCC PART 15 SUBPART E ISED RSS-247 ISSUE 2	Pass

Prepared By:

Kebo Zhang  
Senior Project Engineer

Checked By:

Denny Huang  
Senior Project Engineer

Approved By:

Stephen Guo  
Operations Manager



## 2. TEST METHODOLOGY

All tests were performed in accordance with the standard CFR 47 FCC PART 15 SUBPART E ISED RSS-247 ISSUE 2, ANSI C63.10-2013, CFR 47 FCC Part 2, CFR 47 FCC Part 15, KDB 789033 D02 v02r01, RSS-GEN Issue 5, RSS-247 Issue 2, KDB414788 D01 Radiated Test Site v01, KDB 662911 D01 Multiple Transmitter Output v02r01.

## 3. FACILITIES AND ACCREDITATION

Accreditation Certificate	<p><b>A2LA (Certificate No.: 4102.01)</b> UL Verification Services (Guangzhou) Co., Ltd. Song Shan Lake Branch. has been assessed and proved to be in compliance with A2LA.</p> <p><b>FCC (FCC Designation No.: CN1187)</b> UL Verification Services (Guangzhou) Co., Ltd. Song Shan Lake Branch. Has been recognized to perform compliance testing on equipment subject to the Commission's Declaration of Conformity (DoC) and Certification rules</p> <p><b>ISED (Company No.: 21320)</b> UL Verification Services (Guangzhou) Co., Ltd. Song Shan Lake Branch. has been registered and fully described in a report filed with ISED. The Company Number is 21320 and the test lab Conformity Assessment Body Identifier (CABID) is CN0046.</p> <p><b>VCCI (Registration No.: G-20019, R-20004, C-20012 and T-20011)</b> UL Verification Services (Guangzhou) Co., Ltd. Song Shan Lake Branch. has been assessed and proved to be in compliance with VCCI, the Membership No. is 3793. Facility Name: Chamber D, the VCCI registration No. is G-20019 and R-20004 Shielding Room B , the VCCI registration No. is C-20012 and T-20011</p>
---------------------------	---

### Note1:

All tests measurement facilities use to collect the measurement data are located at Building 10, Innovation Technology Park, No. 1, Li Bin Road, Song Shan Lake Hi-Tech Development Zone Dongguan, 523808, People's Republic of China.

### Note2:

The test anechoic chamber in UL Verification Services (Guangzhou) Co., Ltd. Song Shan Lake Branch had been calibrated and compared to the open field sites and the test anechoic chamber is shown to be equivalent to or worst case from the open field site.

### Note3:

For below 30 MHz, lab had performed measurements at test anechoic chamber and comparing to measurements obtained on an open field site. And these measurements below 30 MHz had been correlated to measurements performed on an OFS.



## 4. CALIBRATION AND UNCERTAINTY

### 4.1. MEASURING INSTRUMENT CALIBRATION

The measuring equipment utilized to perform the tests documented in this report has been calibrated in accordance with the manufacturer's recommendations and is traceable to recognized national standards.

### 4.2. MEASUREMENT UNCERTAINTY

Where relevant, the following measurement uncertainty levels have been estimated for tests performed on the apparatus:

Test Item	Uncertainty
Conduction emission	3.62 dB
Radiated Emission (Included Fundamental Emission) (9 kHz ~ 30 MHz)	2.2 dB
Radiated Emission (Included Fundamental Emission) (30 MHz ~ 1 GHz)	4.00 dB
Radiated Emission (Included Fundamental Emission) (1 GHz to 26 GHz)	5.78 dB (1 GHz ~ 18 GHz)
	5.23 dB (18 GHz ~ 26 GHz)
	5.37 dB (26 GHz ~ 40 GHz)
Duty Cycle	±0.028%
Emission Bandwidth and 99% Occupied Bandwidth	±0.0196%
Maximum Conducted Output Power	±0.766 dB
Maximum Power Spectral Density Level	±1.22 dB
Frequency Stability	±2.76%
Conducted Band-edge Compliance	±1.328 dB
Conducted Unwanted Emissions In Non-restricted Frequency Bands	±0.746 dB (9 kHz ~ 1 GHz)
	±1.328dB (1 GHz ~ 26 GHz)
Note: This uncertainty represents an expanded uncertainty expressed at approximately the 95% confidence level using a coverage factor of k=2.	





## 5. EQUIPMENT UNDER TEST

### 5.1. DESCRIPTION OF EUT

EUT Name/PMN:	BE11000 Whole Home Mesh Wi-Fi 7 System
Model/HVIN:	Deco BE65
Frequency Band:	5150 MHz to 5250 MHz (U-NII-1) 5725 MHz to 5850 MHz (U-NII-3)
Frequency Range:	5180 MHz to 5240 MHz 5745 MHz to 5825 MHz
TPC Function:	Support
Type of Modulation:	IEEE 802.11a: OFDM(64QAM, 16QAM, QPSK, BPSK) IEEE 802.11n: OFDM(64QAM, 16QAM, QPSK, BPSK) IEEE 802.11ac: OFDM(256QAM, 64QAM, 16QAM, QPSK, BPSK) IEEE 802.11ax: OFDMA(1024QAM, 256QAM, 64QAM, 16QAM, QPSK, BPSK) IEEE 802.11be: OFDMA(4096QAM, 1024QAM, 256QAM, 64QAM, 16QAM, QPSK, BPSK)
Radio Technology:	IEEE802.11a/n HT20/n HT40/ ac VHT20/ac VHT40/ac VHT80 / ax HE20/ax HE40/ax HE80 / be EHT20/be EHT40/ax HE80
FVIN:	V1.0
Normal Test Voltage:	DC 12 V

**5.2. CHANNEL LIST**

UNII-1 (For Bandwidth=20MHz)		UNII-1 (For Bandwidth=40MHz)		UNII-1 (For Bandwidth=80MHz)	
Channel	Frequency (MHz)	Channel	Frequency (MHz)	Channel	Frequency (MHz)
36	5180	38	5190	42	5210
40	5200	46	5230		
44	5220				
48	5240				

UNII-3 (For Bandwidth=20MHz)		UNII-3 (For Bandwidth=40MHz)		UNII-3 (For Bandwidth=80MHz)	
Channel	Frequency (MHz)	Channel	Frequency (MHz)	Channel	Frequency (MHz)
149	5745	151	5755	155	5775
153	5765	159	5795		
157	5785				
161	5805				
165	5825				

**5.3. MAXIMUM EIRP****UNII-1 BAND(FCC)**

IEEE Std. 802.11	Frequency (MHz)	Maximum Average Conducted Power (dBm)
a	5150 ~ 5250	25.97
ax HE20		25.86
ax HE40		23.11
ax HE80		23.51
be EHT20		25.90
be EHT40		25.80
be EHT80		23.38

**UNII-1 BAND(ISED)**

IEEE Std. 802.11	Frequency (MHz)	Maximum Average Conducted Power (dBm)	Max Average EIRP (dBm)
a	5150 ~ 5250	14.48	17.48
ax HE20		15.53	18.53
ax HE40		18.39	21.39
ax HE80		19.30	22.30
be EHT20		14.03	17.03
be EHT40		17.13	20.13
be EHT80		19.46	22.46

**UNII-3 BAND(FCC&ISED)**

IEEE Std. 802.11	Frequency (MHz)	Maximum Average Conducted Power (dBm)
a	5725 ~ 5850	25.68
ax HE20		25.61
ax HE40		25.67
ax HE80		23.76
be EHT20		25.23
be EHT40		25.26
be EHT80		23.10

**5.4. TEST CHANNEL CONFIGURATION**

UNII-1 Test Channel Configuration		
IEEE Std.	Test Channel Number	Frequency
802.11a	CH 36(Low Channel), CH 40(MID Channel), CH 48(High Channel)	5180 MHz, 5200 MHz, 5240 MHz
802.11ax HE20	CH 36(Low Channel), CH 40(MID Channel), CH 48(High Channel)	5180 MHz, 5200 MHz, 5240 MHz
802.11ax HE40	CH 38(Low Channel), CH 46(High Channel)	5190 MHz, 5230 MHz
802.11ax HE80	CH 42(Low Channel)	5210 MHz
802.11be EHT20	CH 36(Low Channel), CH 40(MID Channel), CH 48(High Channel)	5180 MHz, 5200 MHz, 5240 MHz
802.11be EHT40	CH 38(Low Channel), CH 46(High Channel)	5190 MHz, 5230 MHz
802.11be EHT80	CH 42(Low Channel)	5210 MHz

UNII-3 Test Channel Configuration		
IEEE Std.	Test Channel Number	Frequency
802.11a	CH 149(Low Channel), CH 157(MID Channel), CH 165(High Channel)	5745 MHz, 5785 MHz, 5825 MHz
802.11ax HE20	CH 149(Low Channel), CH 157(MID Channel), CH 165(High Channel)	5745 MHz, 5785 MHz, 5825 MHz
802.11ax HE40	CH 151(Low Channel), CH 159(High Channel)	5755MHz, 5795MHz
802.11ax HE80	CH 155(Low Channel)	5775 MHz
802.11be EHT20	CH 149(Low Channel), CH 157(MID Channel), CH 165(High Channel)	5745 MHz, 5785 MHz, 5825 MHz
802.11be EHT40	CH 151(Low Channel), CH 159(High Channel)	5755MHz, 5795MHz
802.11be EHT80	CH 155(Low Channel)	5775 MHz



### 5.5. THE WORSE CASE POWER SETTING PARAMETER

The Worse Case Power Setting Parameter				
Test Software	QSPR			
UNII-1(FCC)				
Mode	Rate	Channel	Soft set value	
			ANT 1	ANT 3
11a	6M	36	24	24
		40	24	24
		48	22	22
11n HT20	MCS0	36	Cover by 11ax HE20	
		40		
		48		
11n HT40	MCS0	38	Cover by 11ax HE40	
		46		
11ac VHT20	MCS0	36	Cover by 11ax HE20	
		40		
		48		
11ac VHT40	MCS0	38	Cover by 11ax HE40	
		46		
11ac VHT80	MCS0	42	Cover by 11ax HE80	
11ax HE20	MCS0	36	23	23
		40	24	24
		48	22	22
11ax HE40	MCS0	38	21	21
		46	21	21
11ax HE80	MCS0	42	22	22
11be EHT20	MCS0	36	24	24
		40	24	24
		48	22	22
11be EHT40	MCS0	38	22	22
		46	24	24
11be EHT80	MCS0	42	22	22



## UNII-1(ISED)

Mode	Rate	Channel	Soft set value	
			ANT 1	ANT 3
11a	6M	36	12	12
		40	12	12
		48	12	12
11n HT20	MCS0	36	Cover by 11ax HE20	
		40		
		48		
11n HT40	MCS0	38	Cover by 11ax HE40	
		46		
11ac VHT20	MCS0	36	Cover by 11ax HE20	
		40		
		48		
11ac VHT40	MCS0	38	Cover by 11ax HE40	
		46		
11ac VHT80	MCS0	42	Cover by 11ax HE80	
11ax HE20	MCS0	36	13	13
		40	13	13
		48	13	13
11ax HE40	MCS0	38	15	15
		46	16	16
11ax HE80	MCS0	42	17	17
11be EHT20	MCS0	36	11	11
		40	11	11
		48	11	11
11be EHT40	MCS0	38	14	22
		46	14	24
11be EHT80	MCS0	42	17	22



## UNII-3

Mode	Rate	Channel	Soft set value	
			ANT1	ANT 3
11a	6M	149	24	24
		157	24	24
		165	24	24
11n HT20	MCS0	149	Cover by 11ax HE20	
		157		
		165		
11n HT40	MCS0	151	Cover by 11ax HE40	
		159		
11ac VHT20	MCS0	149	Cover by 11ax HE20	
		157		
		165		
11ac VHT40	MCS0	151	Cover by 11ax HE40	
		159		
11ac VHT80	MCS0	155	Cover by 11ax HE80	
11ax HE20	MCS0	149	24	24
		157	24	24
		165	24	24
11ax HE40	MCS0	151	24	24
		159	23	23
11ax HE80	MCS0	155	22	22
11be EHT20	MCS0	149	24	24
		157	24	24
		165	24	24
11be EHT40	MCS0	151	24	24
		159	24	24
11be EHT80	MCS0	155	22	22

## 5.6. WORSE CASE CONFIGURATIONS

The EUT was tested in the following configuration(s):

Controlled in test mode using a software application on the EUT supplied by customer. The application was used to enable a continuous transmission and to select the mode, test channels, bandwidth, data rates as required.

Test channels referring to section 5.4.

Maximum power setting referring to section 5.5.

Worst case Data Rates declared by the customer:

802.11a 20 CDD mode : 6 Mbps  
802.11n HT20 CDD mode : MCS0  
802.11n HT40 CDD mode : MCS0  
802.11ac VHT20 CDD mode : MCS0  
802.11ac VHT40 CDD mode : MCS0  
802.11ac VHT80 CDD mode : MCS0  
802.11ax HE20 CDD mode : MCS0  
802.11ax HE40 CDD mode : MCS0  
802.11ax HE80 CDD mode : MCS0  
802.11ax HE80 CDD mode : MCS0  
802.11ax HE160 CDD mode : MCS0  
802.11be EHT20 CDD mode : MCS0  
802.11be EHT40 CDD mode : MCS0  
802.11be EHT80 CDD mode : MCS0

All modes support CDD mode.

802.11n HT20/HT40/ac VHT20/VHT40/VHT80 and 802.11ax HE20/HE40/HE80 were performed on the worst case (802.11ax HE20/HE40/HE80) mode and only the worst data was recorded in this report.

The EUT has 4 separate antennas which correspond to 4 separate antenna ports. Core 1 and Core 3 correspond to antenna 1 and antenna 3 respectively and they support WLAN 2.4G and RLAN 5G. Core 2 and Core 4 correspond to antenna 2 and antenna 4 respectively and they support RLAN 6G, but it's not check in this device, and they have been disabled by software.

The measured additional path loss was included in any path loss calculations for all RF cable used during tested.



## 5.7. DESCRIPTION OF AVAILABLE ANTENNAS

Antenna No.	Frequency Band	Antenna Type	Max Antenna Gain (dBi)
1	5150-5850	PCB Antenna	3
3	5150-5850	PCB Antenna	3

The EUT support Cyclic Shift Diversity(CDD) mode.

MIMO output power port and MIMO PSD port summing were performed in accordance with KDB 662911 D01. For the CDD results the Directional Gain was calculated in accordance with the following method.

For output power measurements:

Directional gain=  $G_{ANT} + \text{Array Gain} = 3 \text{ dBi}$

$G_{ANT}$  : equal to the gain of the antenna having the highest gain

Array Gain = 0 dB (i.e., no array gain) for  $N_{ANT} \leq 4$

For power spectral density (PSD) measurements:

Directional gain=  $G_{ANT} + \text{Array Gain} = 6.01 \text{ dBi}$

Array Gain =  $10 \log(N_{ANT}/N_{SS}) \text{ dB}$ .

$N_{ANT}$  : number of transmit antennas

$N_{SS}$  : number of spatial streams, The worst case directional gain will occur when  $N_{SS} = 1$



IEE Std. 802.11	Transmit and Receive Mode	Description
802.11a	☒2TX, 2RX	ANT 1 and ANT 3 can be used as transmitting/receiving antenna.
802.11n HT20	☒2TX, 2RX	ANT 1 and ANT 3 can be used as transmitting/receiving antenna.
802.11n HT40	☒2TX, 2RX	ANT 1 and ANT 3 can be used as transmitting/receiving antenna.
802.11ac VHT20	☒2TX, 2RX	ANT 1 and ANT 3 can be used as transmitting/receiving antenna.
802.11ac VHT40	☒2TX, 2RX	ANT 1 and ANT 3 can be used as transmitting/receiving antenna.
802.11ac VHT80	☒2TX, 2RX	ANT 1 and ANT 3 can be used as transmitting/receiving antenna.
802.11ax HE20	☒2TX, 2RX	ANT 1 and ANT 3 can be used as transmitting/receiving antenna.
802.11ax HE40	☒2TX, 2RX	ANT 1 and ANT 3 can be used as transmitting/receiving antenna.
802.11ax HE80	☒2TX, 2RX	ANT 1 and ANT 3 can be used as transmitting/receiving antenna.
802.11be EHT20	☒2TX, 2RX	ANT 1 and ANT 3 can be used as transmitting/receiving antenna.
802.11be EHT40	☒2TX, 2RX	ANT 1 and ANT 3 can be used as transmitting/receiving antenna.
802.11be EHT80	☒2TX, 2RX	ANT 1 and ANT 3 can be used as transmitting/receiving antenna.

Note: The value of the antenna gain was declared by customer.

### 5.8. SUPPORT UNITS FOR SYSTEM TEST

#### SUPPORT EQUIPMENT

Item	Equipment	Brand Name	Model Name	Remarks
1	Laptop	ThinkPad	X230i	/

#### I/O CABLES

Cable No	Port	Connector Type	Cable Type	Cable Length(m)	Remarks
1	Network Cable	RJ45	Unshielded	1.0 m	/

#### ACCESSORIES

Item	Accessory	Brand Name	Model Name	Description
1	I.T.E. POWER SUPPLY	tp-link	T120330-2B4	Input: AC 100-240 V, 50 / 60 Hz, 1 A Output: DC 12.0 V, 3.3 A

#### TEST SETUP

The EUT can work in engineering mode with a software through a laptop.

#### SETUP DIAGRAM FOR TESTS

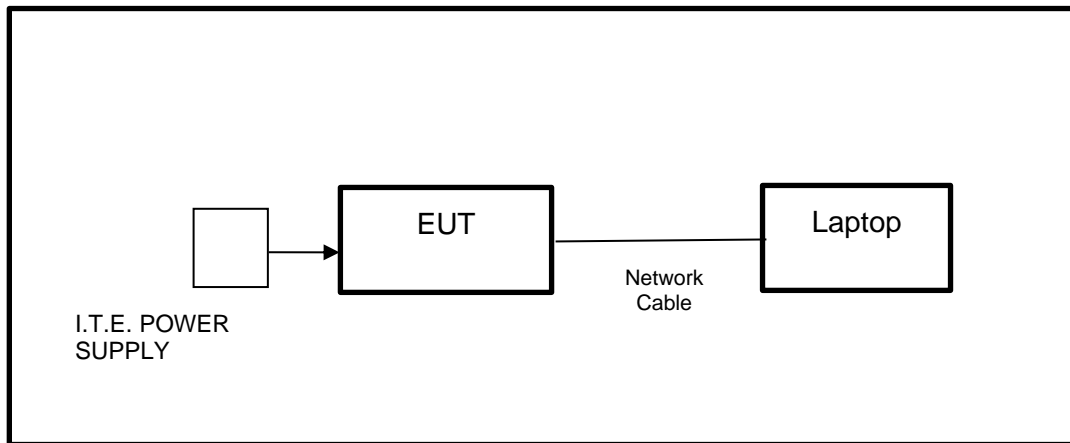

**6. MEASURING EQUIPMENT AND SOFTWARE USED**

<b>R&amp;S TS 8997 Test System</b>					
Equipment	Manufacturer	Model No.	Serial No.	Last Cal.	Due. Date
Power sensor, Power Meter	R&S	OSP120	100921	Apr.02,2022	Apr.01,2023
Vector Signal Generator	R&S	SMBV100A	261637	Oct.17, 2022	Oct.16, 2023
Signal Generator	R&S	SMB100A	178553	Oct.17, 2022	Oct.16, 2023
Signal Analyzer	R&S	FSV40	101118	Oct.17, 2022	Oct.16, 2023
<b>Software</b>					
Description	Manufacturer	Name		Version	
For R&S TS 8997 Test System	Rohde & Schwarz	EMC 32		10.60.10	
<b>Tonsend RF Test System</b>					
Equipment	Manufacturer	Model No.	Serial No.	Last Cal.	Due. Date
Wideband Radio Communication Tester	R&S	CMW500	155523	Oct.17, 2022	Oct.16, 2023
Wireless Connectivity Tester	R&S	CMW270	1201.0002N75-102	Sep.28, 2022	Sep.27, 2023
PXA Signal Analyzer	Keysight	N9030A	MY55410512	Oct.17, 2022	Oct.16, 2023
MXG Vector Signal Generator	Keysight	N5182B	MY56200284	Oct.17, 2022	Oct.16, 2023
MXG Vector Signal Generator	Keysight	N5172B	MY56200301	Oct.17, 2022	Oct.16, 2023
DC power supply	Keysight	E3642A	MY55159130	Oct.17, 2022	Oct.16, 2023
Temperature & Humidity Chamber	SANMOOD	SG-80-CC-2	2088	Oct.17, 2022	Oct.16, 2023
<b>Software</b>					
Description	Manufacturer	Name		Version	
Tonsend SRD Test System	Tonsend	JS1120-3 RF Test System		2.6.77.0518	



Conducted Emissions					
Equipment	Manufacturer	Model No.	Serial No.	Last Cal.	Due Date
EMI Test Receiver	R&S	ESR3	101961	Oct.17, 2022	Oct.16, 2023
Two-Line V-Network	R&S	ENV216	101983	Oct.17, 2022	Oct.16, 2023
Artificial Mains Networks	Schwarzbeck	NSLK 8126	8126465	Oct.17, 2022	Oct.16, 2023
Software					
Description			Manufacturer	Name	Version
Test Software for Conducted Emissions			Farad	EZ-EMC	Ver. UL-3A1

Radiated Emissions					
Equipment	Manufacturer	Model No.	Serial No.	Last Cal.	Due Date
MXE EMI Receiver	KESIGHT	N9038A	MY56400036	Oct.17, 2022	Oct.16, 2023
Hybrid Log Periodic Antenna	TDK	HLP-3003C	130959	Aug.02, 2021	Aug.01, 2024
Preamplifier	HP	8447D	2944A09099	Oct.17, 2022	Oct.16, 2023
EMI Measurement Receiver	R&S	ESR26	101377	Oct.17, 2022	Oct.16, 2023
Horn Antenna	TDK	HRN-0118	130940	July 20, 2021	July 19, 2024
Preamplifier	TDK	PA-02-0118	TRS-305-00067	Oct.17, 2022	Oct.16, 2023
Horn Antenna	Schwarzbeck	BBHA9170	697	July 20, 2021	July 19, 2024
Preamplifier	TDK	PA-02-2	TRS-307-00003	Oct.17, 2022	Oct.16, 2023
Preamplifier	TDK	PA-02-3	TRS-308-00002	Oct.17, 2022	Oct.16, 2023
Loop antenna	Schwarzbeck	1519B	00008	Dec.14, 2021	Dec.13, 2024
Preamplifier	TDK	PA-02-001-3000	TRS-302-00050	Oct.17, 2022	Oct.16, 2023
Preamplifier	Mini-Circuits	ZX60-83LN-S+	SUP01202035	Oct.17, 2022	Oct.16, 2023
High Pass Filter	Wi	WHKX10-2700-3000-18000-40SS	23	/	/
Highpass Filter	Wainwright	WHKX10-5850-6500-1800-40SS	4	/	/
Band Reject Filter	Wainwright	WRCJV12-5695-5725-5850-5880-40SS	4	/	/
Band Reject Filter	Wainwright	WRCJV20-5120-5150-	2	/	/



		5350-5380-60SS			
Band Reject Filter	Wainwright	WRCJV20-5440-5470-5725-5755-60SS	1	/	/
Band Reject Filter	Wainwright	WRCJV8-2350-2400-2483.5-2533.5-40SS	4	/	/
Band Reject Filter	Wainwright	WRCD5-1879-1879.85-1880.15-1881-40SS	1	/	/
Notch Filter	Wainwright	WHJ10-882-980-7000-40SS	1	/	/
Software					
Description			Manufacturer	Name	Version
Test Software for Radiated Emissions			Farad	EZ-EMC	Ver. UL-3A1

Other Instrument					
Equipment	Manufacturer	Model No.	Serial No.	Last Cal.	Due Date
Temperature humidity probe	OMEGA	ITHX-SD-5	18470007	Oct.22, 2022	Oct.21, 2023
Barometer	Yiyi	Baro	N/A	Oct.24, 2022	Oct.23, 2023
Attenuator	Agilent	8495B	2814a12853	Oct.18, 2022	Oct.17, 2023

## 7. ANTENNA PORT TEST RESULTS

### 7.1. ON TIME AND DUTY CYCLE

#### LIMITS

None; for reporting purposes only.

#### TEST PROCEDURE

Refer to KDB 789033 D02 General U-NII Test Procedures New Rules v02r01 section II.B.

The zero-span mode on a spectrum analyzer or EMI receiver, if the response time and spacing between bins on the sweep are sufficient to permit accurate measurements of the on and off times of the transmitted signal. Set the center frequency of the instrument to the center frequency of the transmission. Set  $RBW \geq EBW$  if possible; otherwise, set RBW to the largest available value. Set  $VBW \geq RBW$ . Set detector = peak or average. The zero-span measurement method shall not be used unless both RBW and VBW are  $> 50/T$ , where T is defined in II.B.1.a), and the number of sweep points across duration T exceeds 100. (For example, if VBW and/or RBW are limited to 3 MHz, then the zero-span method of measuring duty cycle shall not be used if  $T \leq 16.7$  microseconds.)

#### TEST SETUP

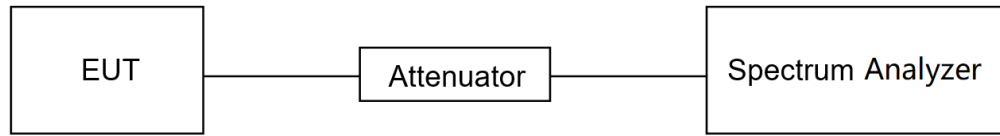

#### TEST ENVIRONMENT

Temperature	25.8°C	Relative Humidity	57.2%
Atmosphere Pressure	101kPa	Test Voltage	DC 12 V

#### TEST DATE / ENGINEER

Test Date	February 23, 2023	Test By	Johnson Liu
-----------	-------------------	---------	-------------

#### TEST RESULTS

Please refer to section "Test Data" - Appendix F



## 7.2. 6DB AND 26DB EMISSION BANDWIDTH AND 99% OCCUPIED BANDWIDTH

### LIMITS

CFR 47 FCC Part15, Subpart E ISED RSS-247 ISSUE 2		
Test Item	Limit	Frequency Range (MHz)
26 dB Emission Bandwidth	For reporting purposes only.	5150 ~ 5250
26 dB Emission Bandwidth	For reporting purposes only.	5250 ~ 5350
26 dB Emission Bandwidth	For reporting purposes only.	5470 ~ 5725 (For FCC) 5470 ~ 5600 (For ISED) 5650 ~ 5725 (For ISED)
6 dB Emission Bandwidth	The minimum 6 dB emission bandwidth shall be 500 kHz.	5725 ~ 5850
99 % Occupied Bandwidth	For reporting purposes only.	5150 ~ 5825 (For ISED)

### TEST PROCEDURE

Refer to KDB 789033 D02 General U-NII Test Procedures New Rules v02r01 section II.C1. for 26 dB Emission Bandwidth; section II.C2. for 6 dB Emission Bandwidth; section II.D. for 99 % Occupied Bandwidth.

Connect the EUT to the spectrum analyser and use the following settings:

Center Frequency	The center frequency of the channel under test
Detector	Peak
RBW	For 6 dB Emission Bandwidth: RBW=100 kHz For 26 dB Emission bandwidth: approximately 1 % of the EBW. For 99 % Occupied Bandwidth: approximately 1 % ~ 5 % of the OBW.
VBW	For 6 dB Bandwidth: $\geq 3 \times \text{RBW}$ For 26 dB Bandwidth: $> 3 \times \text{RBW}$ For 99 % Bandwidth: $> 3 \times \text{RBW}$
Trace	Max hold
Sweep	Auto couple

- Use the 99 % power bandwidth function of the instrument, allow the trace to stabilize and report the measured bandwidth.
- Allow the trace to stabilize and measure the maximum width of the emission that is constrained by the frequencies associated with the two outermost amplitude points (upper and lower frequencies) that are attenuated by 6/26 dB relative to the maximum level measured in the fundamental emission.

### Calculation for 99 % Bandwidth of UNII-2C and UNII-3 Straddle Channel:

For Example: Fundamental Frequency: 5720 MHz

99 % OBW: 21.00 MHz

Turning Frequency: 5725 MHz

99 % Bandwidth of UNII-2C Band Portion =  $(5725 - (5720 - (21.00/2))) = 15.50$  MHz

99 % Bandwidth of UNII-3 Band Portion =  $(5720 + (21.00/2) - 5725) = 5.50$  MHz





**Calculation for 26 dB Bandwidth of UNII-2C Straddle Channel:**

For Example: Fundamental frequency: 5720 MHz

26 dB BW: 20.00 MHz

FL: 5710.16 MHz

FH: 5730.16 MHz

Turning Frequency: 5725 MHz

26 dB Bandwidth of UNII-2C Band Portion = 5725-5710.16=14.84 MHz

**Calculation for 6dB Bandwidth of UNII-3 Straddle Channel:**

For Example: Fundamental frequency: 5720 MHz

6 dB BW: 16.44 MHz

FL: 5711.76 MHz

FH: 5728.2 MHz

Turning Frequency: 5725 MHz

6 dB Bandwidth of UNII-3 band Portion = 5728.2-5725=3.2 MHz

**TEST SETUP**

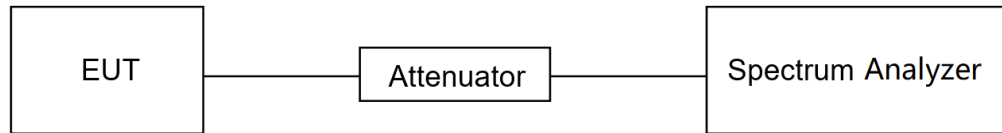

**TEST ENVIRONMENT**

Temperature	25.8°C	Relative Humidity	57.2%
Atmosphere Pressure	101kPa	Test Voltage	DC 12 V

**TEST DATE / ENGINEER**

Test Date	February 23, 2023	Test By	Johnson Liu
-----------	-------------------	---------	-------------

**TEST RESULTS**

Please refer to section "Test Data" - Appendix A&B&C

### 7.3. CONDUCTED OUTPUT POWER

#### LIMITS

CFR 47 FCC Part15, Subpart E		
Test Item	Limit	Frequency Range (MHz)
Conducted Output Power	<input type="checkbox"/> Outdoor Access Point: 1 W (30 dBm) <input checked="" type="checkbox"/> Indoor Access Point: 1 W (30 dBm) <input type="checkbox"/> Fixed Point-To-Point Access Points: 1 W (30 dBm) <input type="checkbox"/> Client Devices: 250 mW (24 dBm)	5150 ~ 5250
	Shall not exceed the lesser of 250 mW (24dBm) or 11 dBm + 10 log B, where B is the 26 dB emission bandwidth in megahertz.	5250 ~ 5350 5470 ~ 5725
	Shall not exceed 1 Watt (30 dBm).	5725 ~ 5850

ISED RSS-247 ISSUE 2		
Test Item	Limit	Frequency Range (MHz)
Conducted Output Power or e.i.r.p.	The maximum e.i.r.p. shall not exceed 200 mW (23 dBm) or 10 + 10 log <sub>10</sub> B, dBm, whichever power is less. B is the 99 % emission bandwidth in megahertz.	5150 ~ 5250
	a. The maximum conducted output power shall not exceed 250 mW (24 dBm) or 11 + 10 log <sub>10</sub> B dBm, whichever is less.  b. The maximum e.i.r.p. shall not exceed 1.0 W (30 dBm) or 17 + 10 log <sub>10</sub> B dBm, whichever is less. B is the 99 % emission bandwidth in megahertz. Note that devices with a maximum e.i.r.p. greater than 500 mW shall implement TPC in order to have the capability to operate at least 6 dB below the maximum permitted e.i.r.p. of 1 W.	5250 ~ 5350 5470 ~ 5600 5650 ~ 5725
	Shall not exceed 1 Watt (30 dBm). The e.i.r.p. shall not exceed 4 W	5725 ~ 5850

#### Note:

The above limits are based upon the maximum antenna gain does not exceed 6 dBi. If transmitting antennas of directional gain greater than 6 dBi are used, the maximum conducted output power shall be reduced by the amount in dB that the directional gain of the antenna exceeds 6 dBi.

#### TEST PROCEDURE

Refer to KDB 789033 D02 General U-NII Test Procedures New Rules v02r01 section II.E.

#### Method SA-1 (trace averaging with the EUT transmitting at full power throughout each sweep):

- (i) Set span to encompass the entire emission bandwidth (EBW) (or, alternatively, the entire 99% occupied bandwidth) of the signal.
- (ii) Set RBW = 1 MHz.
- (iii) Set VBW ≥ 3 MHz.

- (iv) Number of points in sweep  $\geq 2 \times \text{span} / \text{RBW}$ . (This ensures that bin-to-bin spacing is  $\leq \text{RBW}/2$ , so that narrowband signals are not lost between frequency bins.)
- (v) Sweep time = auto.
- (vi) Detector = power averaging (rms), if available. Otherwise, use sample detector mode.
- (vii) If transmit duty cycle  $< 98\%$ , use a video trigger with the trigger level set to enable triggering only on full power pulses. Transmitter must operate at maximum power control level for the entire duration of every sweep. If the EUT transmits continuously (i.e., with no off intervals) or at duty cycle  $\geq 98\%$ , and if each transmission is entirely at the maximum power control level, then the trigger shall be set to "free run."
- (viii) Trace average at least 100 traces in power averaging (rms) mode.
- (ix) Compute power by integrating the spectrum across the EBW (or, alternatively, the entire 99% occupied bandwidth) of the signal using the instrument's band power measurement function with band limits set equal to the EBW (or occupied bandwidth) band edges. If the instrument does not have a band power function, sum the spectrum levels (in power units) at 1 MHz intervals extending across the EBW (or, alternatively, the entire 99% occupied bandwidth) of the spectrum.

**Method PM (Measurement using an RF average power meter):**

- (i) Measurements may be performed using a wideband RF power meter with a thermocouple detector or equivalent if all of the following conditions are satisfied:
  - a. The EUT is configured to transmit continuously or to transmit with a constant duty cycle.
  - b. At all times when the EUT is transmitting, it must be transmitting at its maximum power control level.
  - c. The integration period of the power meter exceeds the repetition period of the transmitted signal by at least a factor of five.
- (ii) If the transmitter does not transmit continuously, measure the duty cycle,  $x$ , of the transmitter output signal as described in II.B.
- (iii) Measure the average power of the transmitter. This measurement is an average over both the on and off periods of the transmitter.
- (iv) Adjust the measurement in dBm by adding  $10 \log (1/x)$  where  $x$  is the duty cycle (e.g.,  $10 \log (1/0.25)$  if the duty cycle is 25 %).

**TEST SETUP**

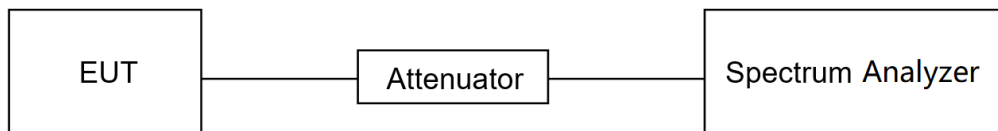

**TEST ENVIRONMENT**

Temperature	25.8°C	Relative Humidity	57.2%
Atmosphere Pressure	101kPa	Test Voltage	DC 12 V

**TEST DATE / ENGINEER**

Test Date	February 23, 2023	Test By	Johnson Liu
-----------	-------------------	---------	-------------

**TEST RESULTS**

Please refer to section "Test Data" - Appendix D

## 7.4. POWER SPECTRAL DENSITY

### LIMITS

CFR 47 FCC Part15, Subpart E		
Test Item	Limit	Frequency Range (MHz)
Power Spectral Density	<input type="checkbox"/> Outdoor Access Point: 17 dBm/MHz <input checked="" type="checkbox"/> Indoor Access Point: 17 dBm/MHz <input type="checkbox"/> Fixed Point-To-Point Access Points: 17 dBm/MHz <input type="checkbox"/> Client Devices: 11 dBm/MHz	5150 ~ 5250
	11 dBm/MHz	5250 ~ 5350 5470 ~ 5725
	30 dBm/500kHz	5725 ~ 5850

ISED RSS-247 ISSUE 2		
Test Item	Limit	Frequency Range (MHz)
Power Spectral Density	The e.i.r.p. spectral density shall not exceed 10 dBm in any 1.0 MHz band.	5150 ~ 5250
	The power spectral density shall not exceed 11 dBm in any 1.0 MHz band.	5250 ~ 5350 5470 ~ 5600 5650 ~ 5725
	30 dBm / 500 kHz	5725 ~ 5850

#### Note:

The above limits are based upon the maximum antenna gain does not exceed 6 dBi. If transmitting antennas of directional gain greater than 6 dBi are used, maximum power spectral density shall be reduced by the amount in dB that the directional gain of the antenna exceeds 6 dBi.

### TEST PROCEDURE

Refer to KDB 789033 D02 General U-NII Test Procedures New Rules v02r01 section II.F.

Connect the EUT to the spectrum analyser and use the following settings:

For U-NII-1, U-NII-2A and U-NII-2C band:

Center Frequency	The center frequency of the channel under test
Detector	RMS
RBW	1 MHz
VBW	$\geq 3 \times \text{RBW}$
Span	Encompass the entire emissions bandwidth (EBW) of the signal
Trace	Max hold
Sweep time	Auto

For U-NII-3:



Center Frequency	The center frequency of the channel under test
Detector	RMS
RBW	500 kHz
VBW	$\geq 3 \times \text{RBW}$
Span	Encompass the entire emissions bandwidth (EBW) of the signal
Trace	Max hold
Sweep time	Auto

Allow trace to fully stabilize and Use the peak search function on the instrument to find the peak of the spectrum and record its value.

Add  $10 \log(1/x)$ , where  $x$  is the duty cycle, to the peak of the spectrum, the result is the Maximum PSD over 1 MHz / 500 kHz reference bandwidth.

### **TEST SETUP**

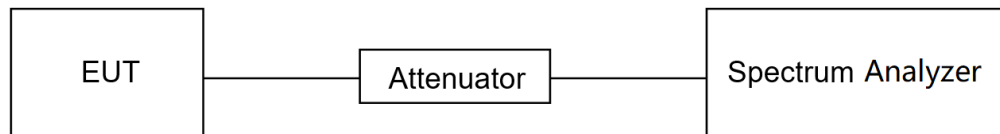

### **TEST ENVIRONMENT**

Temperature	25.8°C	Relative Humidity	57.2%
Atmosphere Pressure	101kPa	Test Voltage	DC 12 V

### **TEST DATE / ENGINEER**

Test Date	February 23, 2023	Test By	Johnson Liu
-----------	-------------------	---------	-------------

### **TEST RESULTS**

Please refer to section "Test Data" - Appendix E

## 7.5. FREQUENCY STABILITY

### LIMITS

The frequency of the carrier signal shall be maintained within band of operation.

### TEST PROCEDURE

1. The EUT was placed inside an environmental chamber as the temperature in the chamber was varied between 0 °C ~ 40 °C (declared by customer).
2. The temperature was incremented by 10 °C intervals and the unit allowed to stabilize at each temperature before each measurement. The center frequency of the transmitting channel was evaluated at each temperature and the frequency deviation from the channel's center frequency was recorded.
3. The primary supply voltage is varied from 85 % to 115 % of the nominal value for non hand-carried battery and AC powered equipment. For hand-carried, battery-powered equipment, primary supply voltage is reduced to the battery operating end point which shall be specified by the manufacturer.

Connect the EUT to the spectrum analyser and use the following settings:

Center Frequency	The center frequency of the channel under test
Detector	Peak
RBW	10 kHz
VBW	$\geq 3 \times \text{RBW}$
Span	Encompass the entire emissions bandwidth (EBW) of the signal
Trace	Max hold
Sweep time	Auto

4. While maintaining a constant temperature inside the environmental chamber, turn the EUT on and record the operating frequency at startup, and at 2 minutes, 5minutes, and 10 minutes after the EUT is energized.
5. Allow the trace to stabilize, find the peak value of the power envelope and record the frequency, then calculated the frequency drift.

### TEST ENVIRONMENT

	Normal Test Conditions	Extreme Test Conditions
Relative Humidity	20 % - 75 %	/
Atmospheric Pressure	100 kPa ~102 kPa	/
Temperature	T <sub>N</sub> (Normal Temperature): 25.1 °C	T <sub>L</sub> (Low Temperature): 0 °C
		T <sub>H</sub> (High Temperature): 40 °C
Supply Voltage	V <sub>N</sub> (Normal Voltage): AC 120 V, 60 Hz	V <sub>L</sub> (Low Voltage): AC102 V
		V <sub>H</sub> (High Voltage): AC 138 V



**TEST SETUP**

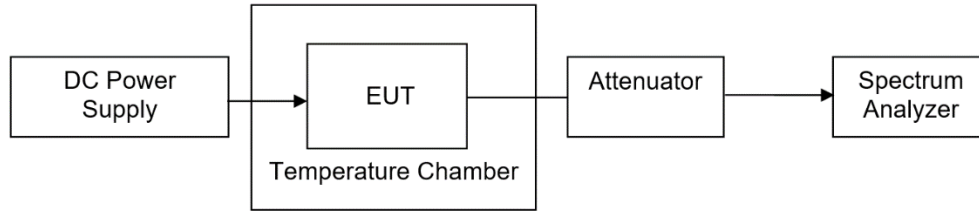

**TEST ENVIRONMENT**

Temperature	25.8°C	Relative Humidity	57.2%
Atmosphere Pressure	101kPa	Test Voltage	AC 120 V, 60 Hz

**TEST DATE / ENGINEER**

Test Date	February 23, 2023	Test By	Johnson Liu
-----------	-------------------	---------	-------------

**TEST RESULTS**

Please refer to section "Test Data" - Appendix G

## 8. RADIATED TEST RESULTS

### LIMITS

Refer to CFR 47 FCC §15.205, §15.209 and §15.407 (b).

Refer to ISED RSS-GEN Clause 8.9, Clause 8.10 and ISED RSS-247 6.2.

Radiation Disturbance Test Limit for FCC (Class B) (9 kHz ~ 1 GHz)

Emissions radiated outside of the specified frequency bands above 30 MHz			
Frequency Range (MHz)	Field Strength Limit (uV/m) at 3 m	Field Strength Limit (dBuV/m) at 3 m	
		Quasi-Peak	
30 - 88	100	40	
88 - 216	150	43.5	
216 - 960	200	46	
Above 960	500	54	
Above 1000	500	Peak	Average
		74	54

FCC Emissions radiated outside of the specified frequency bands below 30 MHz		
Frequency (MHz)	Field strength (microvolts/meter)	Measurement distance (meters)
0.009-0.490	2400/F(kHz)	300
0.490-1.705	24000/F(kHz)	30
1.705-30.0	30	30

ISED General field strength limits at frequencies below 30 MHz

Table 6 – General field strength limits at frequencies below 30 MHz		
Frequency	Magnetic field strength (H-Field) (µA/m)	Measurement distance (m)
9 - 490 kHz <sup>Note 1</sup>	6.37/F (F in kHz)	300
490 - 1705 kHz	63.7/F (F in kHz)	30
1.705 - 30 MHz	0.08	30

**Note 1:** The emission limits for the ranges 9-90 kHz and 110-490 kHz are based on measurements employing a linear average detector.

ISED Restricted bands refer to ISED RSS-GEN Clause 8.10





Table 7 – Restricted frequency bands <sup>Note 1</sup>		
MHz	MHz	GHz
0.090 - 0.110	149.9 - 150.05	9.0 - 9.2
0.495 - 0.505	156.52475 - 156.52525	9.3 - 9.5
2.1735 - 2.1905	156.7 - 156.9	10.6 - 12.7
3.020 - 3.026	162.0125 - 167.17	13.25 - 13.4
4.125 - 4.128	167.72 - 173.2	14.47 - 14.5
4.17725 - 4.17775	240 - 285	15.35 - 16.2
4.20725 - 4.20775	322 - 335.4	17.7 - 21.4
5.677 - 5.683	399.9 - 410	22.01 - 23.12
6.215 - 6.218	608 - 614	23.6 - 24.0
6.26775 - 6.26825	960 - 1427	31.2 - 31.8
6.31175 - 6.31225	1435 - 1626.5	36.43 - 36.5
8.291 - 8.294	1645.5 - 1646.5	Above 38.6
8.362 - 8.366	1660 - 1710	
8.37625 - 8.38675	1718.8 - 1722.2	
8.41425 - 8.41475	2200 - 2300	
12.29 - 12.293	2310 - 2390	
12.51975 - 12.52025	2483.5 - 2500	
12.57675 - 12.57725	2655 - 2900	
13.36 - 13.41	3260 - 3267	
16.42 - 16.423	3332 - 3339	
16.69475 - 16.69525	3345.8 - 3358	
16.80425 - 16.80475	3500 - 4400	
25.5 - 25.67	4500 - 5150	
37.5 - 38.25	5350 - 5480	
73 - 74.6	7250 - 7750	
74.8 - 75.2	8025 - 8500	
108 - 138		

**Note 1:** Certain frequency bands listed in table 7 and in bands above 38.6 GHz are designated for licence-exempt applications. These frequency bands and the requirements that apply to related devices are set out in the 200 and 300 series of RSSs.

FCC Restricted bands of operation refer to FCC §15.205 (a):

MHz	MHz	MHz	GHz
0.090-0.110	16.42-16.423	399.9-410	4.5-5.15
<sup>1</sup> 0.495-0.505	16.69475-16.69525	608-614	5.35-5.46
2.1735-2.1905	16.80425-16.80475	960-1240	7.25-7.75
4.125-4.128	25.5-25.67	1300-1427	8.025-8.5
4.17725-4.17775	37.5-38.25	1435-1626.5	9.0-9.2
4.20725-4.20775	73-74.6	1645.5-1646.5	9.3-9.5
6.215-6.218	74.8-75.2	1660-1710	10.6-12.7
6.26775-6.26825	108-121.94	1718.8-1722.2	13.25-13.4
6.31175-6.31225	123-138	2200-2300	14.47-14.5
8.291-8.294	149.9-150.05	2310-2390	15.35-16.2
8.362-8.366	156.52475-156.52525	2483.5-2500	17.7-21.4
8.37625-8.38675	156.7-156.9	2690-2900	22.01-23.12
8.41425-8.41475	162.0125-167.17	3260-3267	23.6-24.0
12.29-12.293	167.72-173.2	3332-3339	31.2-31.8
12.51975-12.52025	240-285	3345.8-3358	36.43-36.5
12.57675-12.57725	322-335.4	3600-4400	( <sup>2</sup> )
13.36-13.41			

Note: <sup>1</sup>Until February 1, 1999, this restricted band shall be 0.490-0.510 MHz.

<sup>2</sup>Above 38.6c

Limits of unwanted/undesirable emission out of the restricted bands refer to CFR 47 FCC §15.407 (b) and ISED RSS-247 6.2.

LIMITS OF RADIATED EMISSION MEASUREMENT (Above 1GHz)		
Frequency Range (MHz)	EIRP Limit	Field Strength Limit (dBuV/m) at 3 m
5150~5250 MHz	PK: -27 (dBm/MHz)	PK:68.2(dBμV/m)
5250~5350 MHz		
5470~5725 MHz		
5725~5850 MHz	PK: -27 (dBm/MHz) *1 PK: 10 (dBm/MHz) *2 PK: 15.6 (dBm/MHz) *3 PK: 27 (dBm/MHz) *4	PK: 68.2(dBμV/m) *1 PK: 105.2 (dBμV/m) *2 PK: 110.8(dBμV/m) *3 PK: 122.2 (dBμV/m) *4
Note: *1 beyond 75 MHz or more above of the band edge. *2 below the band edge increasing linearly to 10 dBm/MHz at 25 MHz above. *3 below the band edge increasing linearly to a level of 15.6 dBm/MHz at 5 MHz above. *4 from 5 MHz above or below the band edge increasing linearly to a level of 27 dBm/MHz at the band edge.		

## TEST PROCEDURE

Below 30 MHz

The setting of the spectrum analyser

RBW	200 Hz (From 9 kHz to 0.15 MHz)/ 9 kHz (From 0.15 MHz to 30 MHz)
VBW	200 Hz (From 9 kHz to 0.15 MHz)/ 9 kHz (From 0.15 MHz to 30 MHz)
Sweep	Auto

1. The testing follows the guidelines in ANSI C63.10-2013 clause 6.4.
2. The EUT was arranged to its worst case and then turntable (from 0 degree to 360 degrees) to find the maximum reading. A pre-amp and a high pass filter are used for the test in order to get better signal level. Both Horizontal, Face-on and Face-off polarizations of the antenna are set to make the measurement.
3. The EUT was placed on a turntable with 80 cm above ground.
4. The EUT was set 3 meters from the interference receiving antenna, which was mounted on the top of a 1 m height antenna tower.
5. The radiated emission limits are based on measurements employing a CISPR quasi-peak detector except for the frequency bands 9-90 kHz, 110-490 kHz and above 1000 MHz Radiated emission limits in these three bands are based on measurements employing an average detector.
6. For measurement below 1 GHz, the initial step in collecting conducted emission data is a spectrum analyzer peak detector mode pre-scanning the measurement frequency range. Significant peaks are then marked and then Quasi Peak and average detector mode re-measured. If the emission level of the EUT measured by the peak detector is 3 dB lower than the applicable limit, the peak emission level will be reported. Otherwise, the emission measurement will be repeated using the quasi-peak and average detector and reported.
7. Although these tests were performed other than open field site, adequate comparison measurements were confirmed against 30m open field site. Therefore sufficient tests were made



to demonstrate that the alternative site produces results that correlate with the ones of tests made in an open field site based on KDB 414788.

8. The limits in CFR 47, Part 15, Subpart C, paragraph 15.209 (a), are identical to those in RSS-GEN Section 8.9, Table 6, since the measurements are performed in terms of magnetic field strength and converted to electric field strength levels (as reported in the table) using the free space impedance of  $377\Omega$ . For example, the measurement frequency X KHz resulted in a level of Y dBuV/m, which is equivalent to  $Y-51.5 = Z$  dBuA/m, which has the same margin, W dB, to the corresponding RSS-GEN Table 6 limit as it has to be 15.209(a) limit.



Below 1 GHz and above 30 MHz

The setting of the spectrum analyser

RBW	120 kHz
VBW	300 kHz
Sweep	Auto
Detector	Peak/QP
Trace	Max hold

1. The testing follows the guidelines in ANSI C63.10-2013 clause 6.5.
2. The EUT was arranged to its worst case and then tune the antenna tower (from 1 m to 4 m) and turntable (from 0 degree to 360 degrees) to find the maximum reading. A pre-amp and a high pass filter are used for the test in order to get better signal level. Both horizontal and vertical polarizations of the antenna are set to make the measurement.
3. The EUT was placed on a turntable with 80 cm above ground.
4. The EUT was set 3 meters from the interference receiving antenna, which was mounted on the top of a variable height antenna tower.
5. For measurement below 1 GHz, the initial step in collecting conducted emission data is a spectrum analyzer peak detector mode pre-scanning the measurement frequency range. Significant peaks are then marked and then Quasi Peak detector mode re-measured. If the emission level of the EUT measured by the peak detector is 3 dB lower than the applicable limit, the peak emission level will be reported. Otherwise, the emission measurement will be repeated using the quasi-peak detector and reported.

Above 1 GHz

The setting of the spectrum analyser

RBW	1 MHz
VBW	PEAK: 3 MHz AVG: see note 6
Sweep	Auto
Detector	Peak
Trace	Max hold

1. The testing follows the guidelines in KDB 789033 D02 General U-NII Test Procedures New Rules v02r01 section II.G.3 ~ II.G.6.
2. The EUT was arranged to its worst case and then tune the antenna tower (from 1 m to 4 m) and turntable (from 0 degree to 360 degrees) to find the maximum reading. A pre-amp and a high pass filter are used for the test in order to get better signal level. Both horizontal and vertical polarizations of the antenna are set to make the measurement.
3. The EUT was placed on a turntable with 1.5 m above ground.
4. The EUT was set 3 meters from the interference receiving antenna, which was mounted on the top of a variable height antenna tower.
5. For measurement above 1 GHz, the emission measurement will be measured by the peak detector. This peak level, once corrected, must comply with the limit specified in Section 15.209.
6. For measurements above 1 GHz the resolution bandwidth is set to 1 MHz, then the video bandwidth is set to 3 MHz for peak measurements and 1 MHz resolution bandwidth with 1/T video bandwidth with peak detector for average measurements. For the Duty Cycle please refer to clause 7.1 ON TIME AND DUTY CYCLE.

X axis, Y axis, Z axis positions :

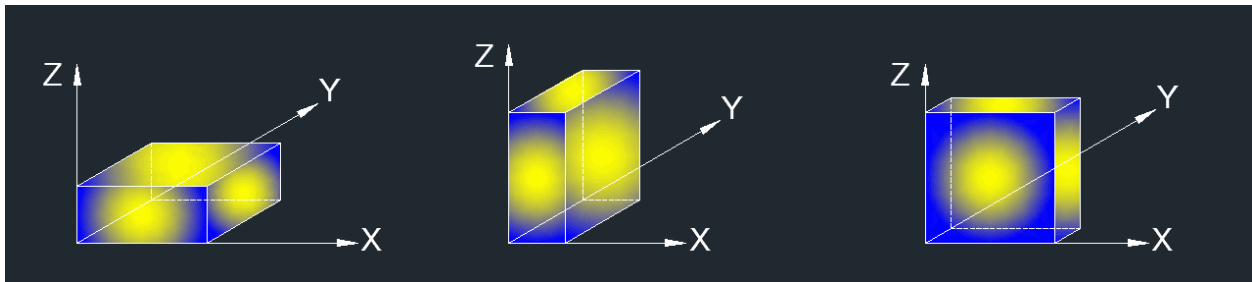

Note 1: For all radiated test, EUT in each of three orthogonal axis emissions had been tested, but only the worst case (X axis) data recorded in the report.

For Band edge note:

1. Measurement = Reading Level + Correct Factor.
2. If the Peak values are less than the Average limit of 54 dBuV/m, the Average result is deemed to comply with Average limit.
3. Peak: Peak detector.
4. AVG:  $VBW=1/Ton$ , where: Ton is the transmitting duration.
5. For the transmitting duration, please refer to clause 7.1.
6. Only the worst data was recorded, if it complies with the limit, the other emissions deemed to comply with the limit.
7. Horizontal and Vertical have been tested, only the worst data was recorded in the report.
8. All modes, channels and antennas have been tested, only the worst data was recorded in the report.

For Radiate Spurious emission 1GHz-7GHz note:

- Note:
1. Measurement = Reading Level + Correct Factor.
  2. If the Peak values are less than the Average limit of 54 dBuV/m, the Average result is deemed to comply with Average limit.
  3. Peak: Peak detector.
  4. AVG:  $VBW=1/Ton$ , where: Ton is the transmitting duration.
  5. For the transmitting duration, please refer to clause 7.1.
  6. Filter losses were only considered in the spurious frequency bands and the authorized band was not corrected for Band reject filter losses.
  7. Proper operation of the transmitter prior to adding the filter to the measurement chain.
  8. Since non-restricted band peak emissions are less than the average limit, they also comply with the -27dBm/MHz (68.2dBuV/m) limit.
  9. All modes, channels and antennas have been tested, only the worst data was recorded in the report.

For Radiate Spurious emission 7GHz-18GHz note:

- Note:
1. Measurement = Reading Level + Correct Factor.
  2. If the Peak values are less than the Average limit of 54 dBuV/m, the Average result is deemed to comply with Average limit.
  3. Peak: Peak detector.
  4. AVG:  $VBW=1/Ton$ , where: Ton is the transmitting duration.
  5. For the transmitting duration, please refer to clause 7.1.
  6. Filter losses were only considered in the spurious frequency bands and the authorized band was not corrected for High Pass Filter losses.
  7. Proper operation of the transmitter prior to adding the filter to the measurement chain.
  8. Since non-restricted band peak emissions are less than the average limit, they also comply with the -27dBm/MHz (68.2dBuV/m) limit.
  9. All modes, channels and antennas have been tested, only the worst data was recorded in the report.

For Radiate Spurious emission 9kHz-30MHz note:

Note: 1. Measurement = Reading Level + Correct Factor (dBuA/m= dBuV/m- 20Log10[120π] = dBuV/m- 51.5).

2. If the Peak values are less than the QP limit, the QP result is deemed to comply with QP limit.

3. All 3 polarizations (Horizontal, Face-on and Face-off) of the loop antenna had been tested, but only the worst data recorded in the report.

4. All modes, channels and antennas have been tested, only the worst data was recorded in the report.

For Radiate Spurious emission 18GHz-26GHz note:

Note: 1. Measurement = Reading Level + Correct Factor.

2. If the Peak values are less than the Average limit of 54 dBuV/m, the Average result is deemed to comply with Average limit.

3. Peak: Peak detector.

4. All modes, channels and antennas have been tested, only the worst data was recorded in the report.

For Radiate Spurious emission 26GHz-40GHz note:

Note: 1. Measurement = Reading Level + Correct Factor.

2. If the Peak values are less than the Average limit of 54 dBuV/m, the Average result is deemed to comply with Average limit.

3. Peak: Peak detector.

4. All modes, channels and antennas have been tested, only the worst data was recorded in the report.

For Radiate Spurious emission 30MHz-1GHz note:

1. Result Level = Read Level + Correct Factor.

2. If the Peak values are less than the QP limit, the QP result is deemed to comply with QP limit.

3. Test setup: RBW: 120 kHz, VBW: 300 kHz, Sweep time: auto.

4. All modes, channels and antennas have been tested, only the worst data was recorded in the report.

**TEST SETUP**

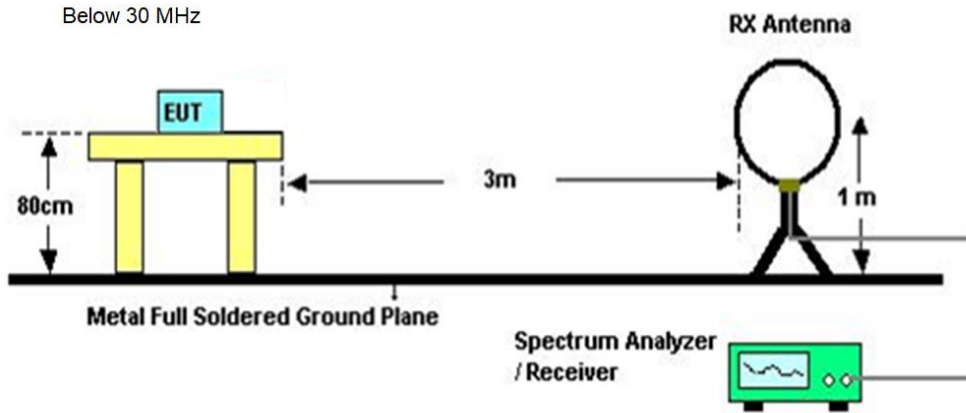

Below 1 GHz and above 30 MHz

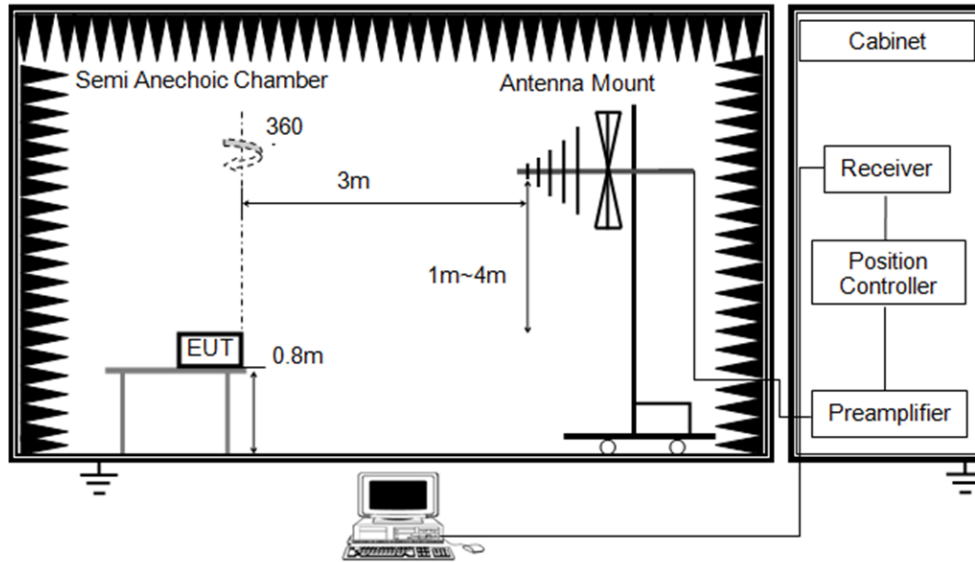

Above 1 GHz

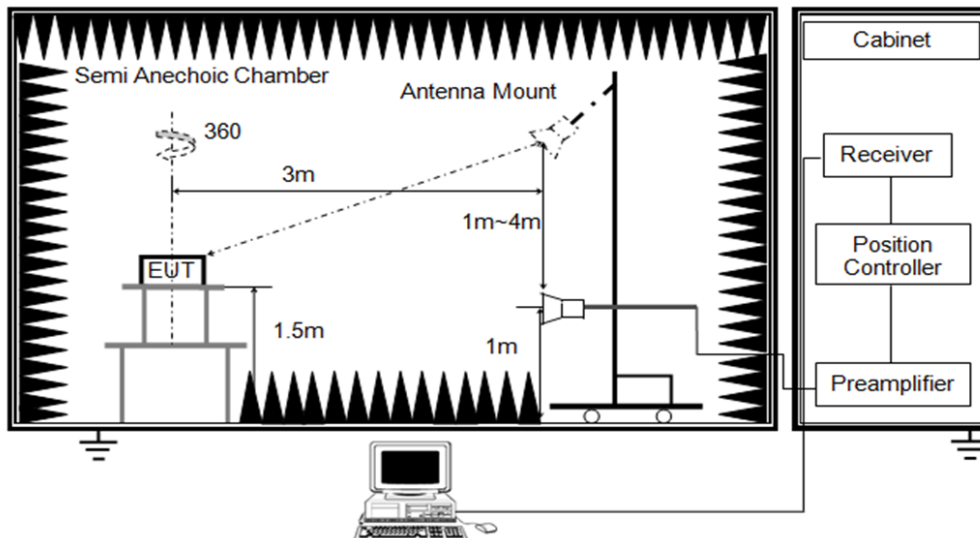





**TEST ENVIRONMENT**

Temperature	25.3°C	Relative Humidity	62%
Atmosphere Pressure	101kPa	Test Voltage	DC 12 V

**TEST DATE / ENGINEER**

Test Date	February 22, 2023	Test By	Rex Huang
-----------	-------------------	---------	-----------

**TEST RESULTS**



### 8.1. RESTRICTED BANDEDGE

Test Mode:	802.11a 20 PK	Channel:	5180
Polarity:	Vertical	Test Voltage:	DC 12 V

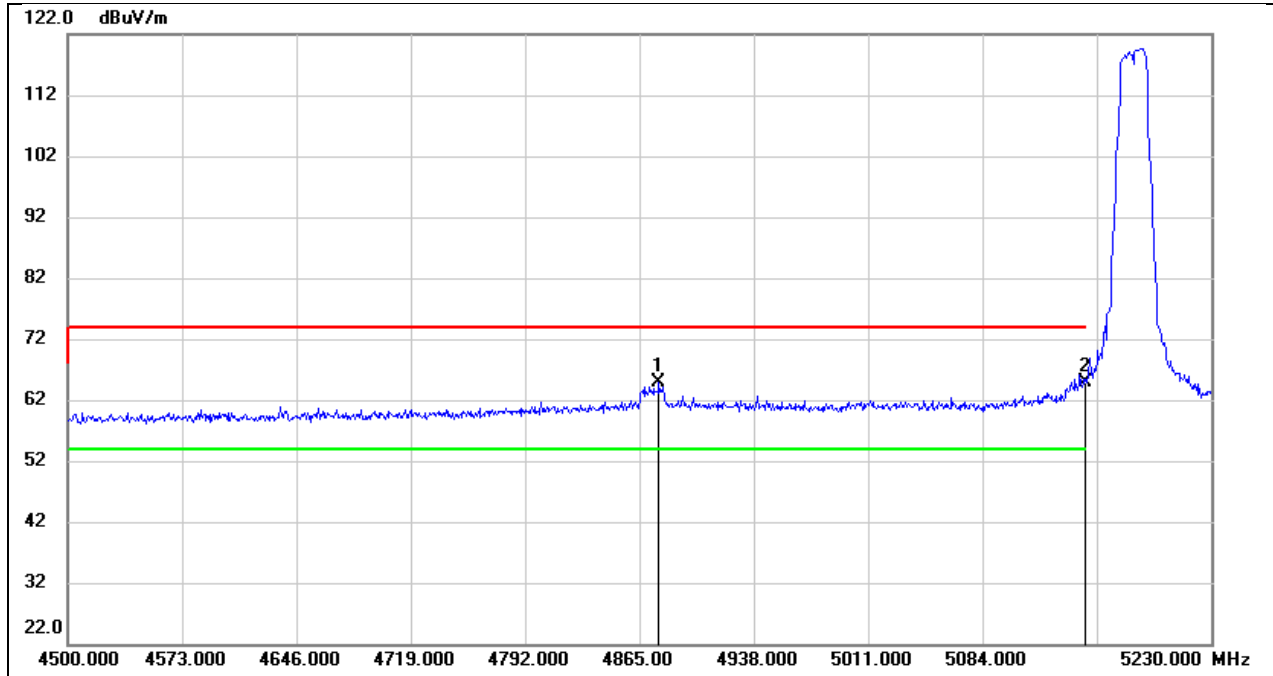

No.	Frequency (MHz)	Reading (dBuV)	Correct (dB/m)	Result (dBuV/m)	Limit (dBuV/m)	Margin (dB)	Remark
1	4877.410	25.13	39.65	64.78	74.00	-9.22	peak
2	5150.000	24.65	40.27	64.92	74.00	-9.08	peak



Test Mode:	802.11a 20 AV	Channel:	5180
Polarity:	Vertical	Test Voltage:	DC 12 V

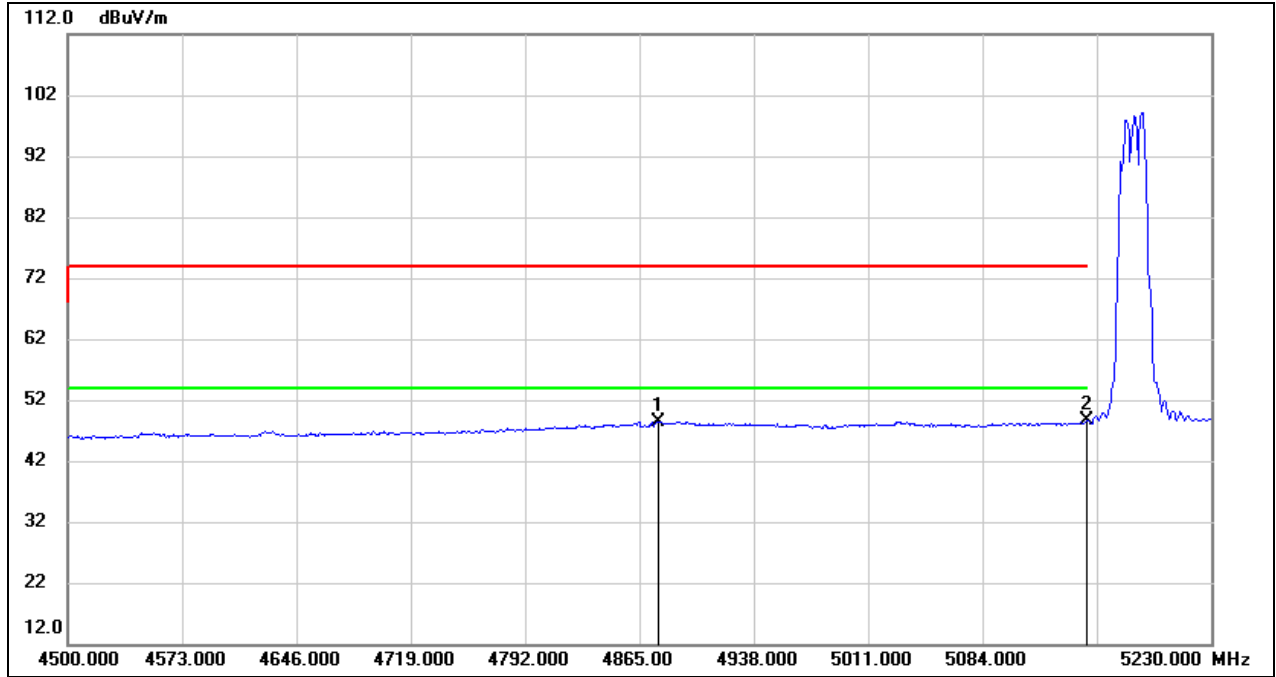

No.	Frequency (MHz)	Reading (dBuV)	Correct (dB/m)	Result (dBuV/m)	Limit (dBuV/m)	Margin (dB)	Remark
1	4877.410	8.79	39.65	48.44	54.00	-5.56	AVG
2	5150.000	8.24	40.27	48.51	54.00	-5.49	AVG



Test Mode:	802.11a 20 PK	Channel:	5240
Polarity:	Vertical	Test Voltage:	DC 12 V

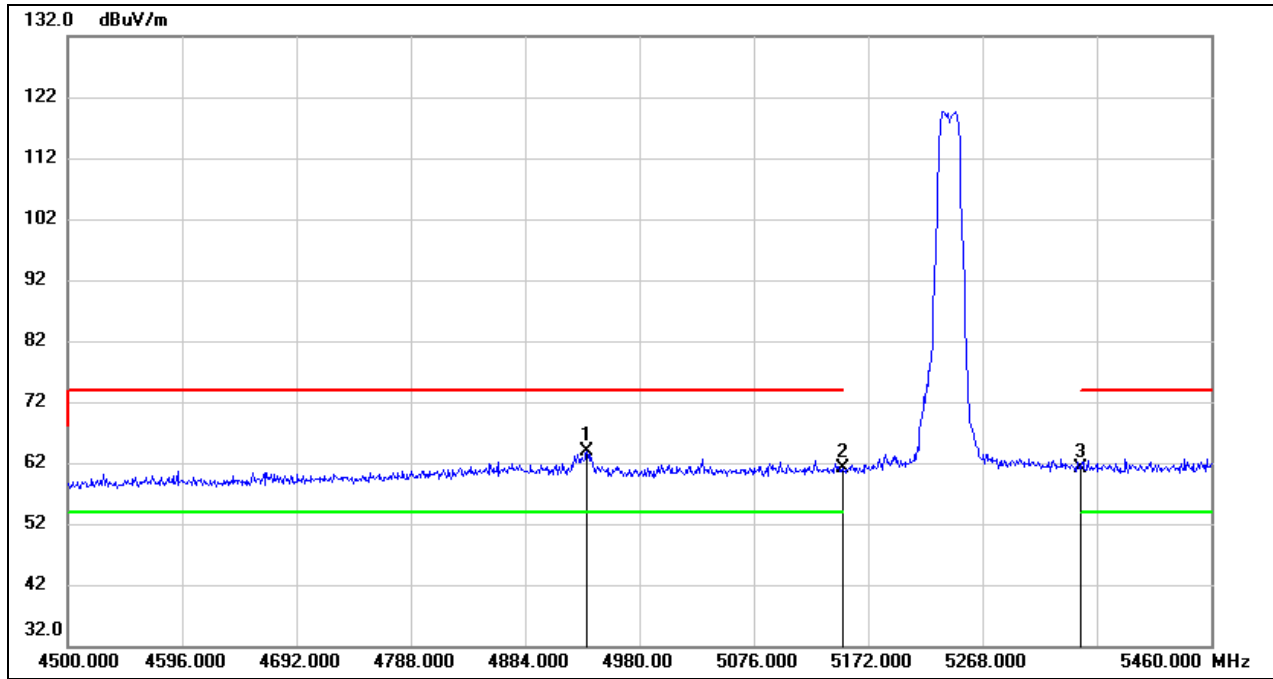

No.	Frequency (MHz)	Reading (dBuV)	Correct (dB/m)	Result (dBuV/m)	Limit (dBuV/m)	Margin (dB)	Remark
1	4935.840	23.90	39.87	63.77	74.00	-10.23	peak
2	5150.000	20.86	40.27	61.13	74.00	-12.87	peak
3	5350.000	20.66	40.49	61.15	74.00	-12.85	peak



Test Mode:	802.11a 20 AV	Channel:	5240
Polarity:	Vertical	Test Voltage:	DC 12 V

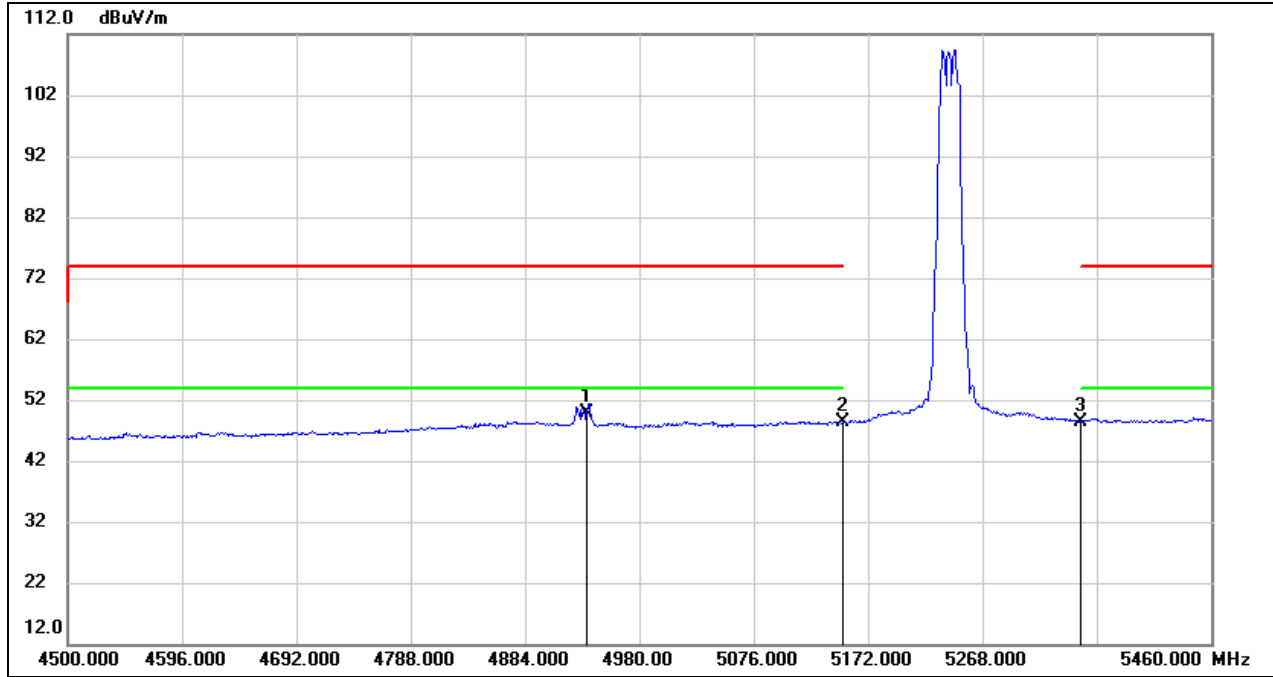

No.	Frequency (MHz)	Reading (dBuV)	Correct (dB/m)	Result (dBuV/m)	Limit (dBuV/m)	Margin (dB)	Remark
1	4935.840	9.90	39.87	49.77	54.00	-4.23	AVG
2	5150.000	8.03	40.27	48.30	54.00	-5.70	AVG
3	5350.000	7.99	40.49	48.48	54.00	-5.52	AVG



Test Mode:	802.11a 20 PK	Channel:	5745
Polarity:	Vertical	Test Voltage:	DC 12 V

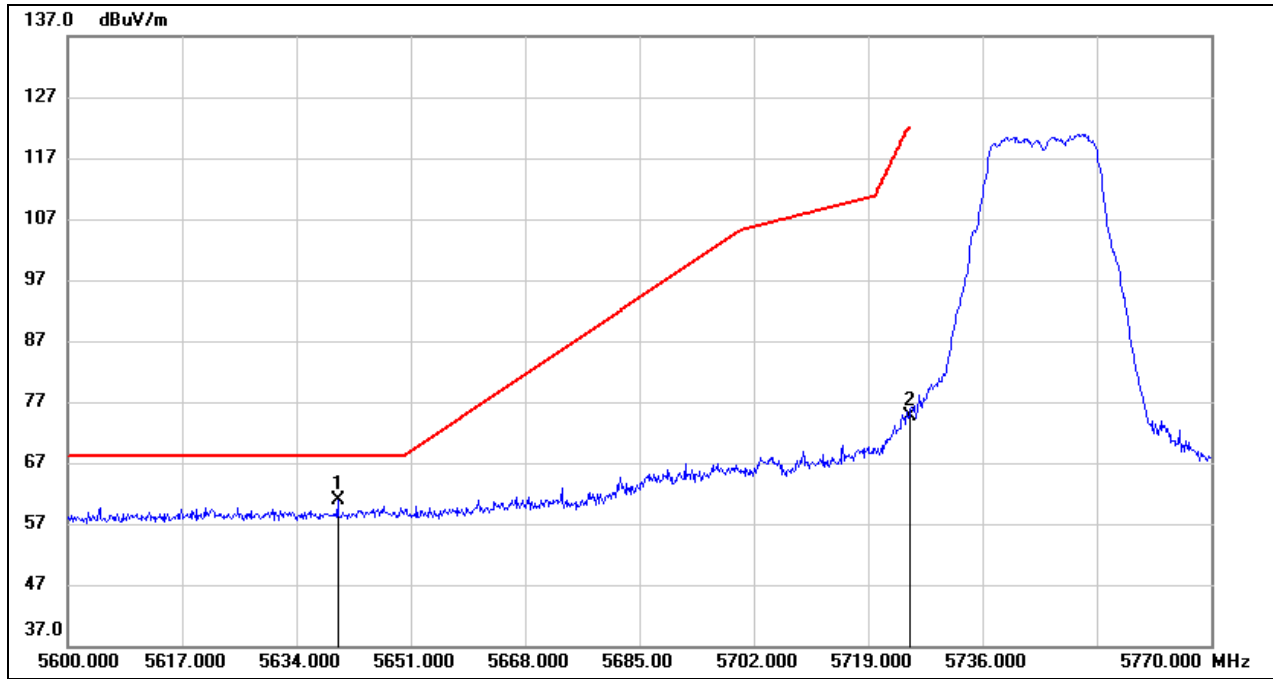

No.	Frequency (MHz)	Reading (dBuV)	Correct (dB/m)	Result (dBuV/m)	Limit (dBuV/m)	Margin (dB)	Remark
1	5640.120	19.73	41.04	60.77	68.20	-7.43	peak
2	5725.000	33.40	41.27	74.67	122.20	-47.53	peak



Test Mode:	802.11a 20 PK	Channel:	5825
Polarity:	Vertical	Test Voltage:	DC 12 V

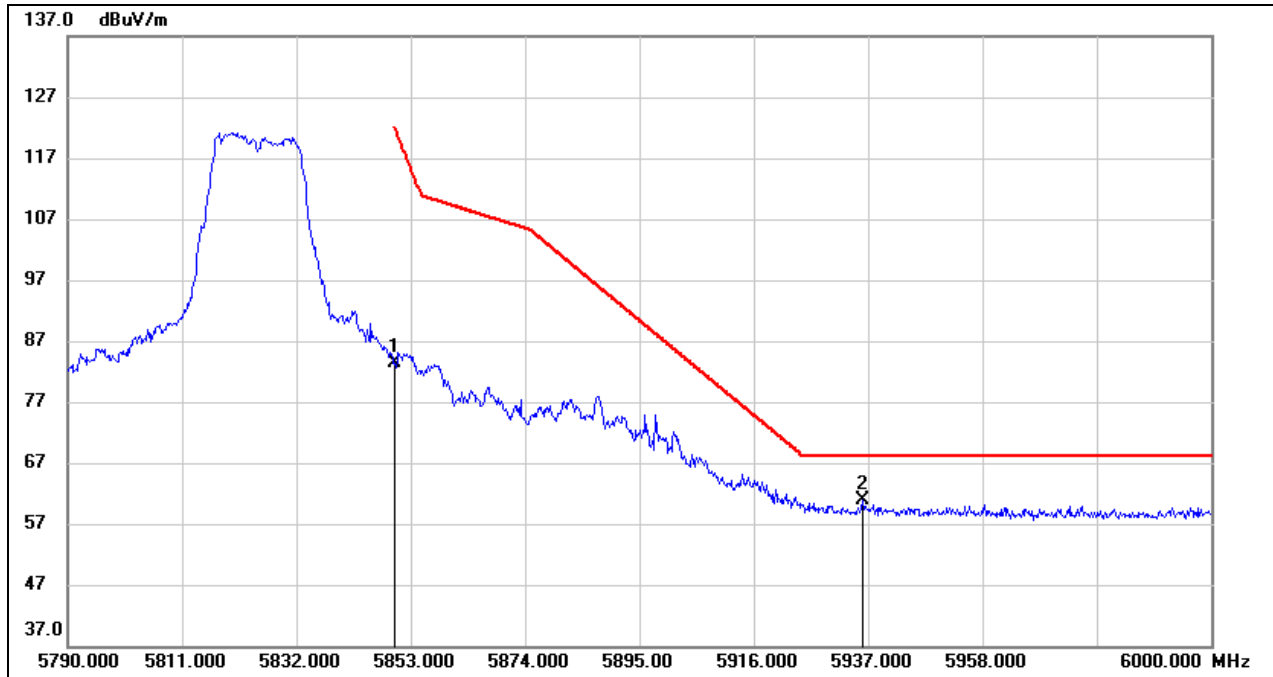

No.	Frequency (MHz)	Reading (dBuV)	Correct (dB/m)	Result (dBuV/m)	Limit (dBuV/m)	Margin (dB)	Remark
1	5850.000	41.87	41.60	83.47	122.20	-38.73	peak
2	5935.950	18.96	41.83	60.79	68.20	-7.41	peak



Test Mode:	802.11ax HE20 PK	Channel:	5180
Polarity:	Vertical	Test Voltage:	DC 12 V

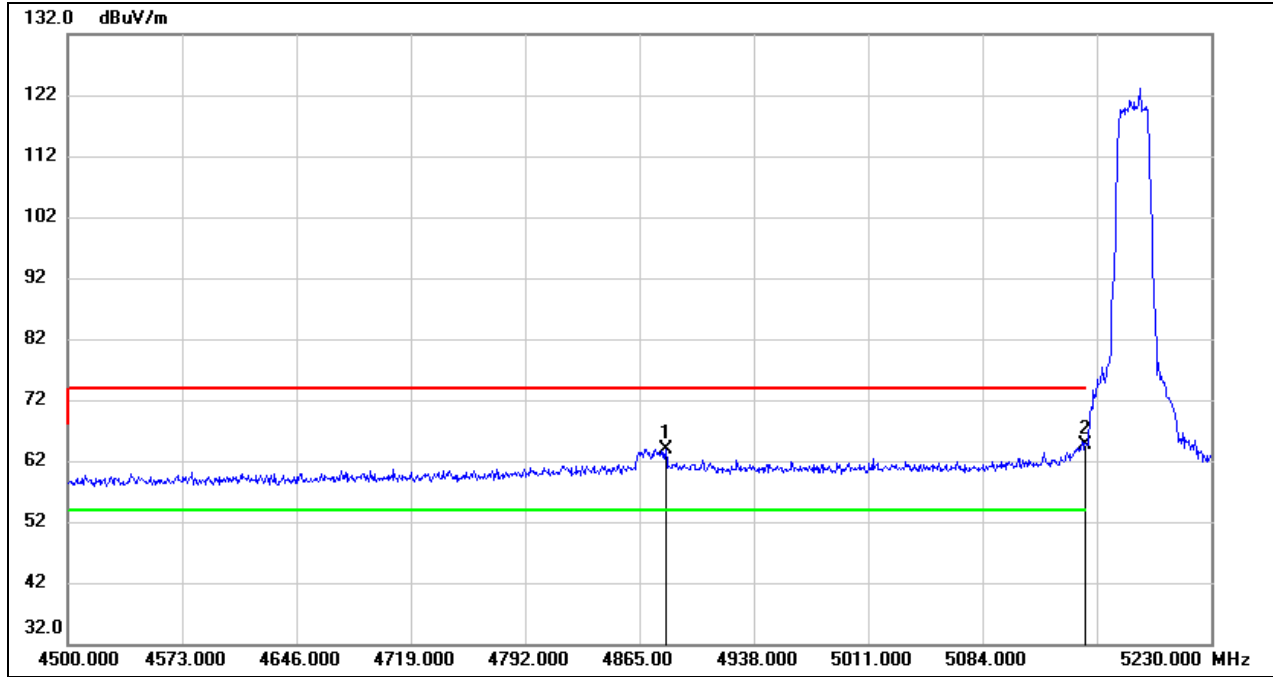

No.	Frequency (MHz)	Reading (dBuV)	Correct (dB/m)	Result (dBuV/m)	Limit (dBuV/m)	Margin (dB)	Remark
1	4881.790	24.28	39.66	63.94	74.00	-10.06	peak
2	5150.000	24.27	40.27	64.54	74.00	-9.46	peak





Test Mode:	802.11ax HE20 AV	Channel:	5180
Polarity:	Vertical	Test Voltage:	DC 12 V

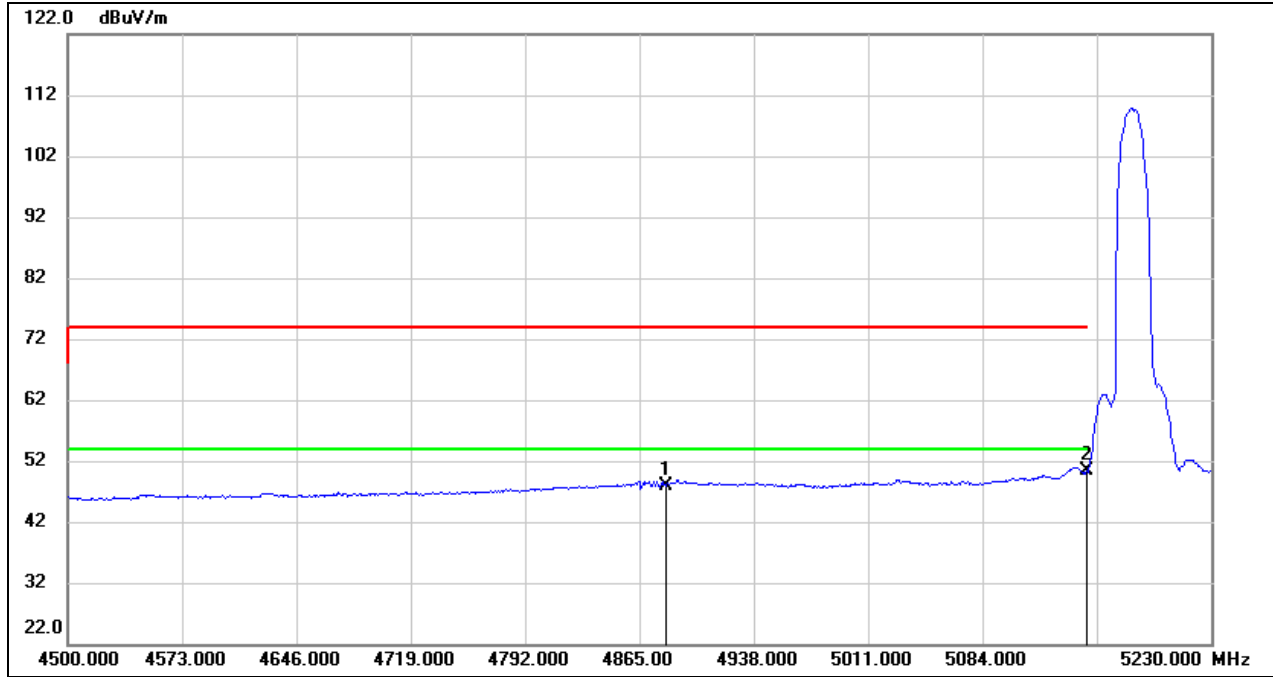

No.	Frequency (MHz)	Reading (dBuV)	Correct (dB/m)	Result (dBuV/m)	Limit (dBuV/m)	Margin (dB)	Remark
1	4881.790	8.12	39.66	47.78	54.00	-6.22	AVG
2	5150.000	10.11	40.27	50.38	54.00	-3.62	AVG



Test Mode:	802.11ax HE20 PK	Channel:	5240
Polarity:	Vertical	Test Voltage:	DC 12 V

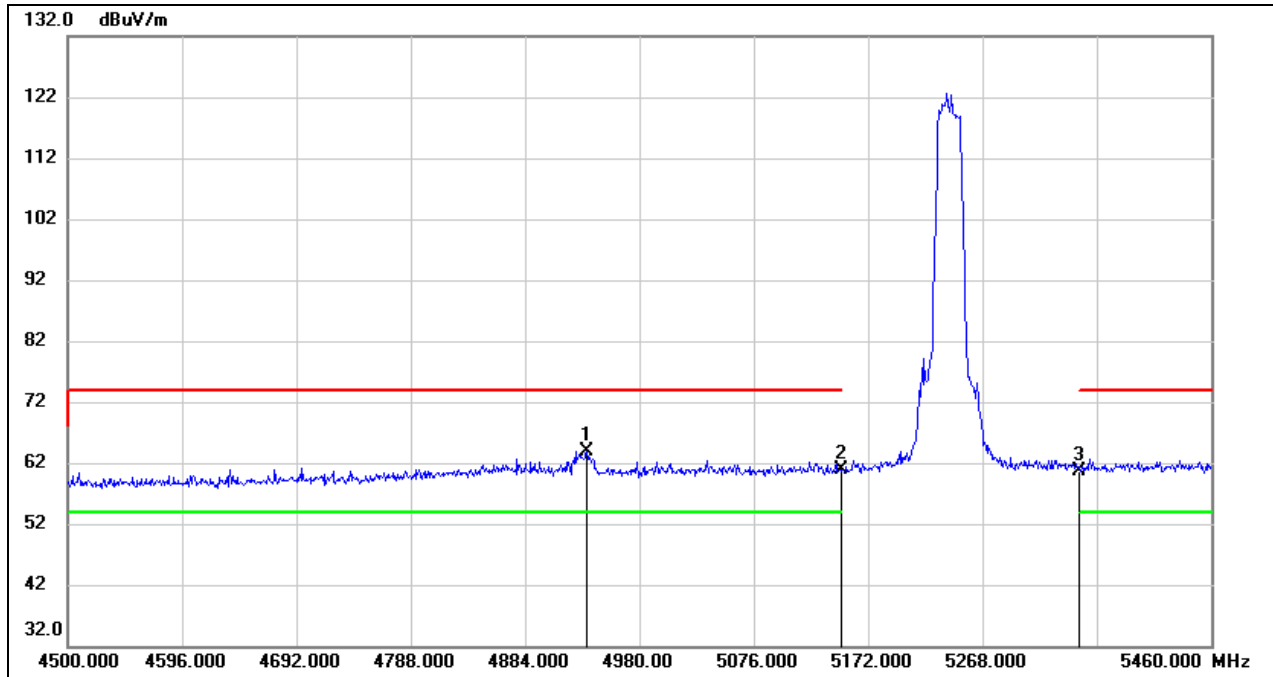

No.	Frequency (MHz)	Reading (dBuV)	Correct (dB/m)	Result (dBuV/m)	Limit (dBuV/m)	Margin (dB)	Remark
1	4935.840	24.12	39.87	63.99	74.00	-10.01	peak
2	5150.000	20.60	40.27	60.87	74.00	-13.13	peak
3	5350.000	20.18	40.49	60.67	74.00	-13.33	peak



Test Mode:	802.11ax HE20 AV	Channel:	5240
Polarity:	Vertical	Test Voltage:	DC 12 V

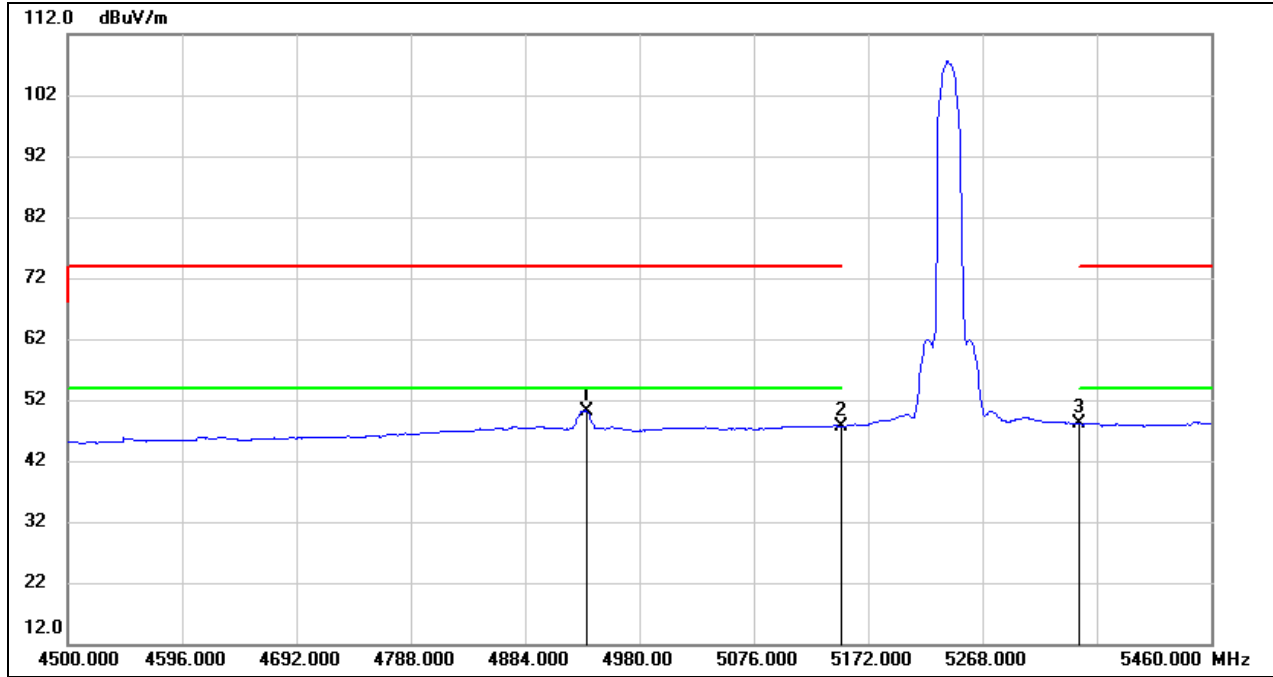

No.	Frequency (MHz)	Reading (dBuV)	Correct (dB/m)	Result (dBuV/m)	Limit (dBuV/m)	Margin (dB)	Remark
1	4935.840	10.27	39.87	50.14	54.00	-3.86	AVG
2	5150.000	7.45	40.27	47.72	54.00	-6.28	AVG
3	5350.000	7.53	40.49	48.02	54.00	-5.98	AVG



Test Mode:	802.11ax HE20 PK	Channel:	5745
Polarity:	Vertical	Test Voltage:	DC 12 V

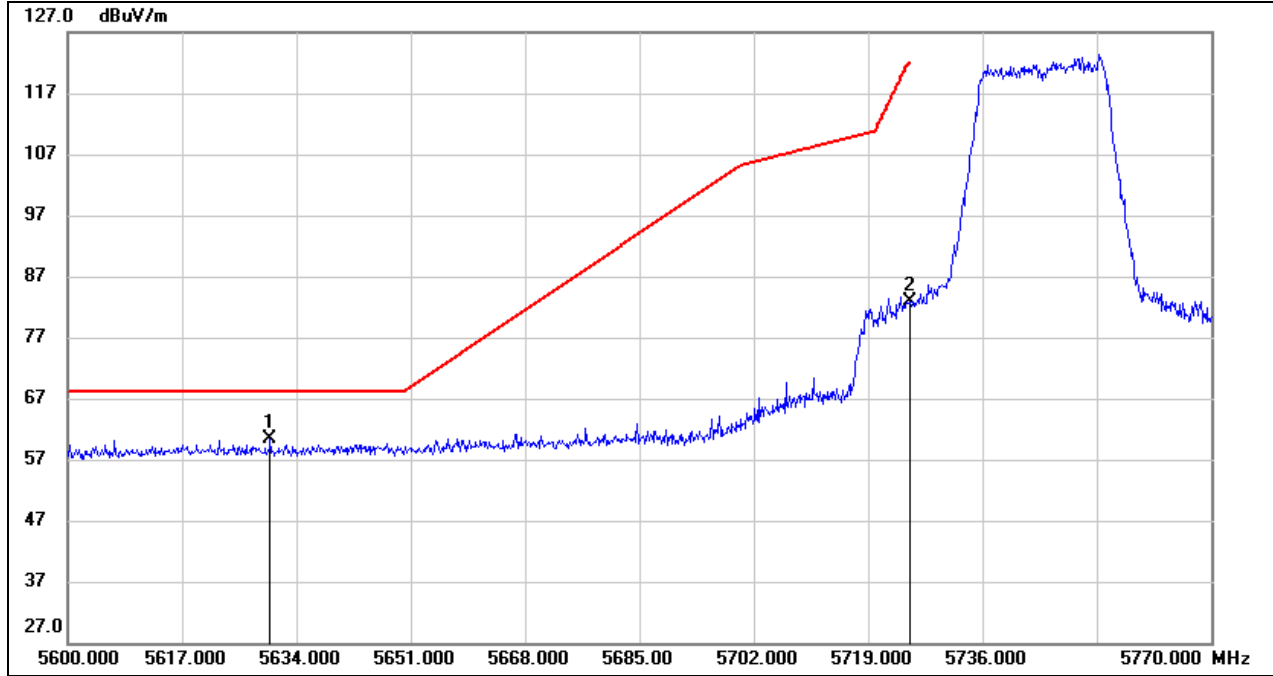

No.	Frequency (MHz)	Reading (dBuV)	Correct (dB/m)	Result (dBuV/m)	Limit (dBuV/m)	Margin (dB)	Remark
1	5630.090	19.38	41.01	60.39	68.20	-7.81	peak
2	5725.000	41.69	41.27	82.96	122.20	-39.24	peak



Test Mode:	802.11ax HE20 PK	Channel:	5825
Polarity:	Vertical	Test Voltage:	DC 12 V

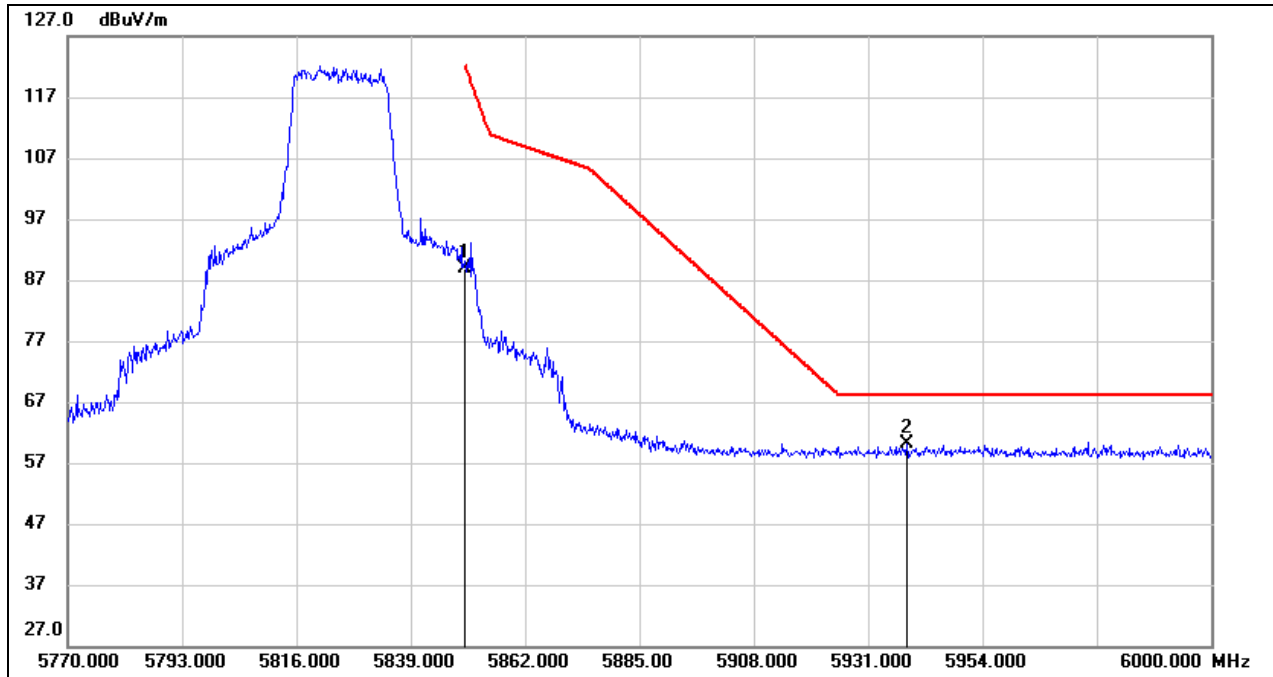

No.	Frequency (MHz)	Reading (dBuV)	Correct (dB/m)	Result (dBuV/m)	Limit (dBuV/m)	Margin (dB)	Remark
1	5850.000	47.27	41.60	88.87	122.20	-33.33	peak
2	5938.820	18.32	41.84	60.16	68.20	-8.04	peak



Test Mode:	802.11ax HE40 PK	Channel:	5190
Polarity:	Vertical	Test Voltage:	DC 12 V

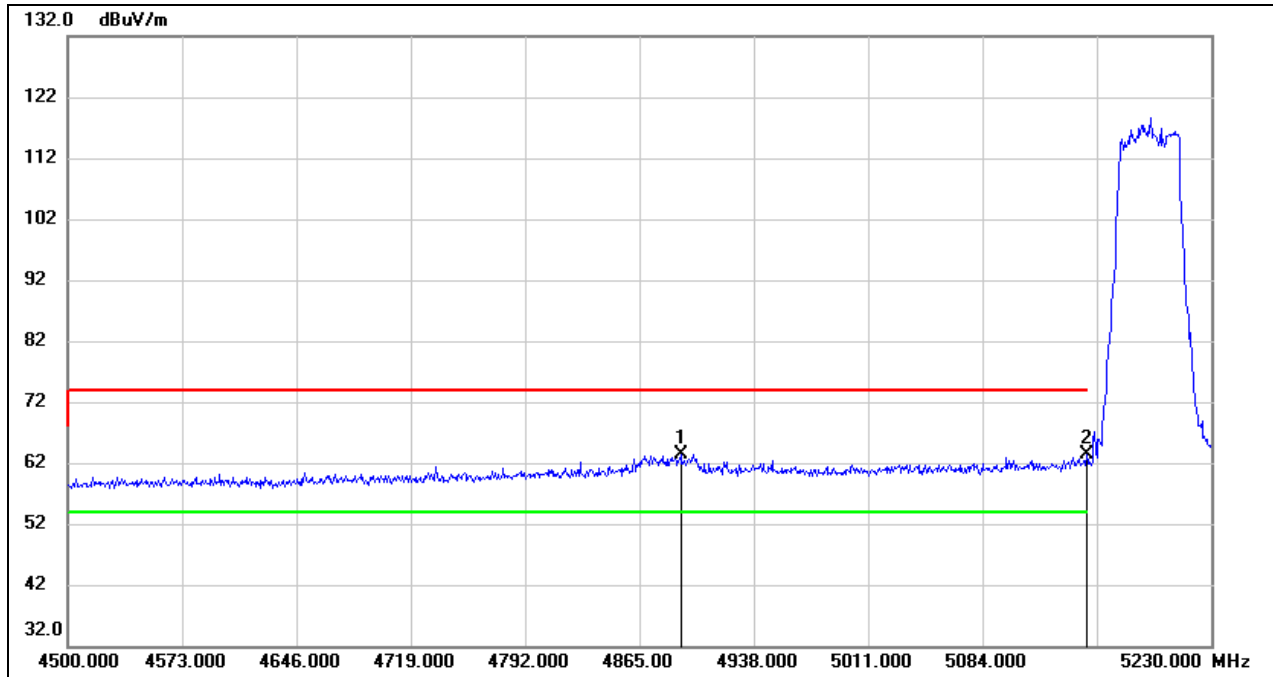

No.	Frequency (MHz)	Reading (dBuV)	Correct (dB/m)	Result (dBuV/m)	Limit (dBuV/m)	Margin (dB)	Remark
1	4891.280	23.77	39.70	63.47	74.00	-10.53	peak
2	5150.000	23.11	40.27	63.38	74.00	-10.62	peak



Test Mode:	802.11ax HE40 PK	Channel:	5190
Polarity:	Vertical	Test Voltage:	DC 12 V

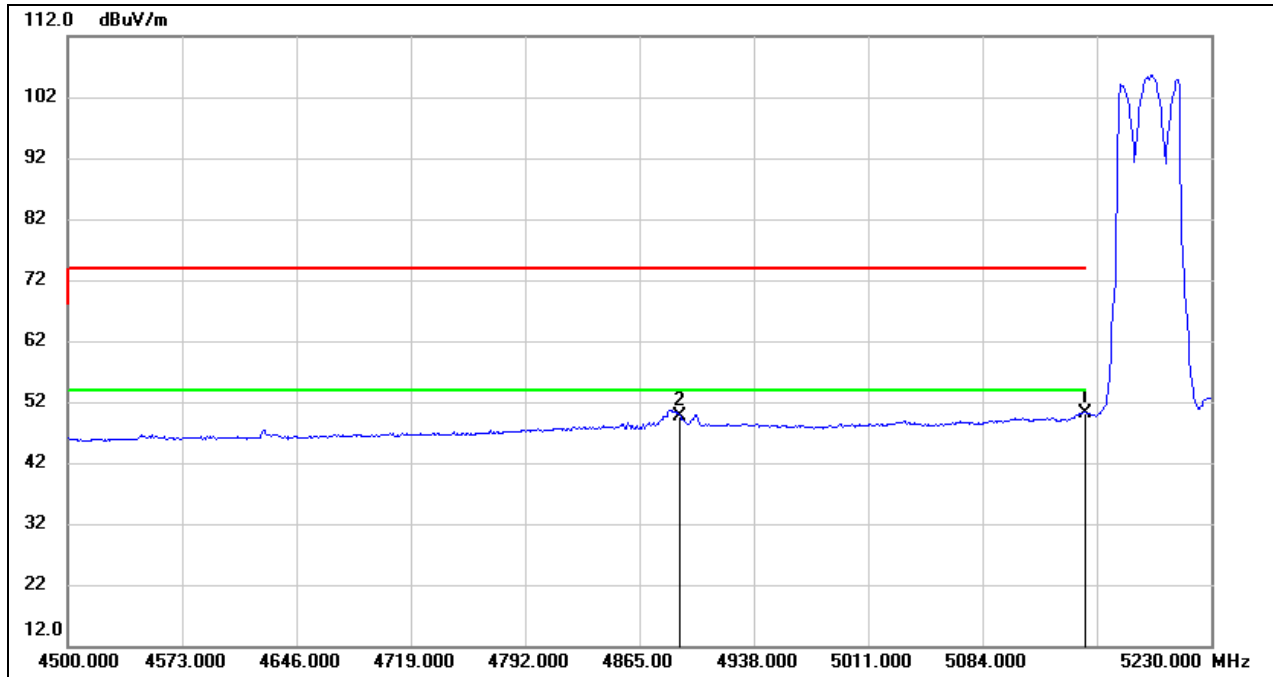

No.	Frequency (MHz)	Reading (dBuV)	Correct (dB/m)	Result (dBuV/m)	Limit (dBuV/m)	Margin (dB)	Remark
1	5150.000	9.97	40.27	50.24	54.00	-3.76	AVG
2	4891.280	9.86	39.70	49.56	54.00	-4.44	AVG



Test Mode:	802.11ax HE40 PK	Channel:	5230
Polarity:	Vertical	Test Voltage:	DC 12 V

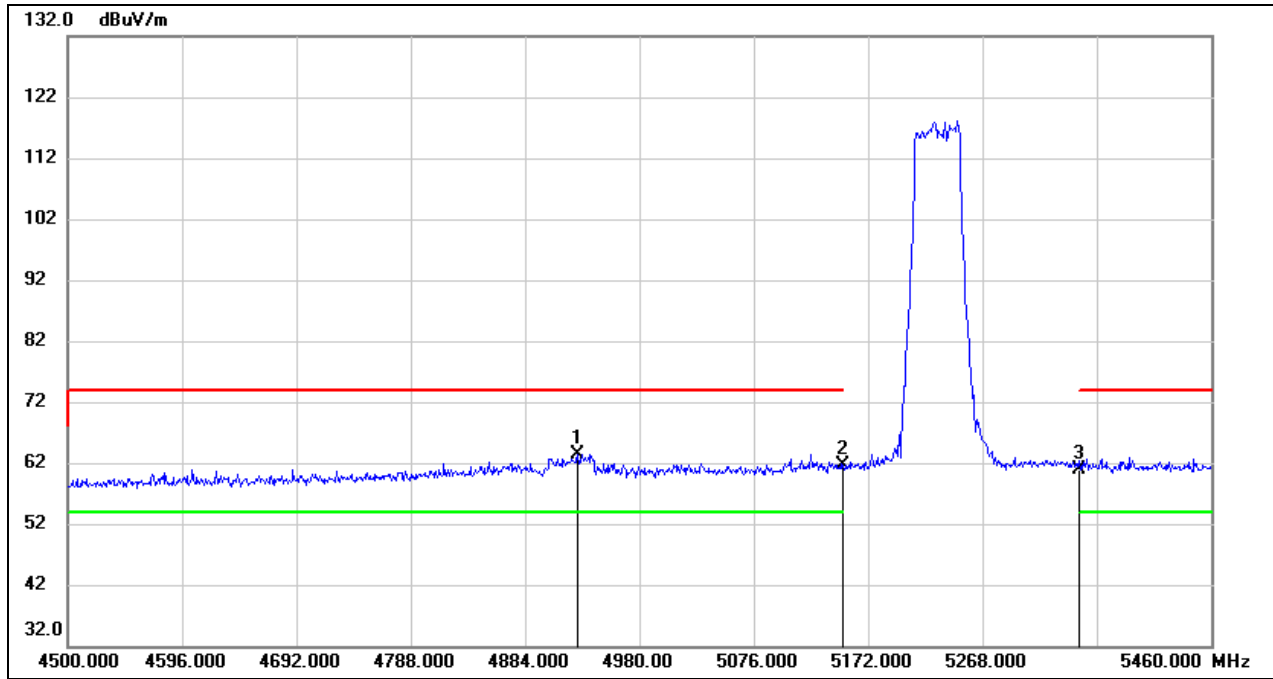

No.	Frequency (MHz)	Reading (dBuV)	Correct (dB/m)	Result (dBuV/m)	Limit (dBuV/m)	Margin (dB)	Remark
1	4928.160	23.64	39.84	63.48	74.00	-10.52	peak
2	5150.000	21.32	40.27	61.59	74.00	-12.41	peak
3	5350.000	20.41	40.49	60.90	74.00	-13.10	peak





Test Mode:	802.11ax HE40 AV	Channel:	5230
Polarity:	Vertical	Test Voltage:	DC 12 V

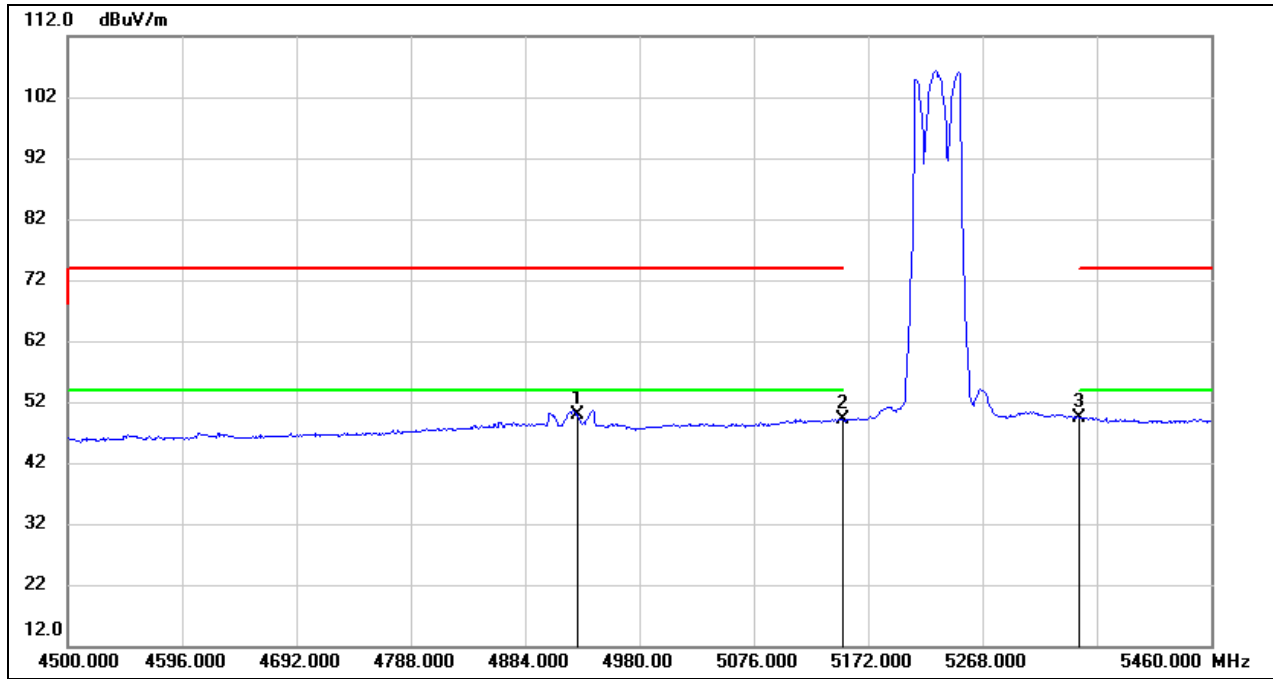

No.	Frequency (MHz)	Reading (dBuV)	Correct (dB/m)	Result (dBuV/m)	Limit (dBuV/m)	Margin (dB)	Remark
1	4928.160	10.08	39.84	49.92	54.00	-4.08	AVG
2	5150.000	8.74	40.27	49.01	54.00	-4.99	AVG
3	5350.000	8.90	40.49	49.39	54.00	-4.61	AVG



Test Mode:	802.11ax HE40 PK	Channel:	5755
Polarity:	Vertical	Test Voltage:	DC 12 V

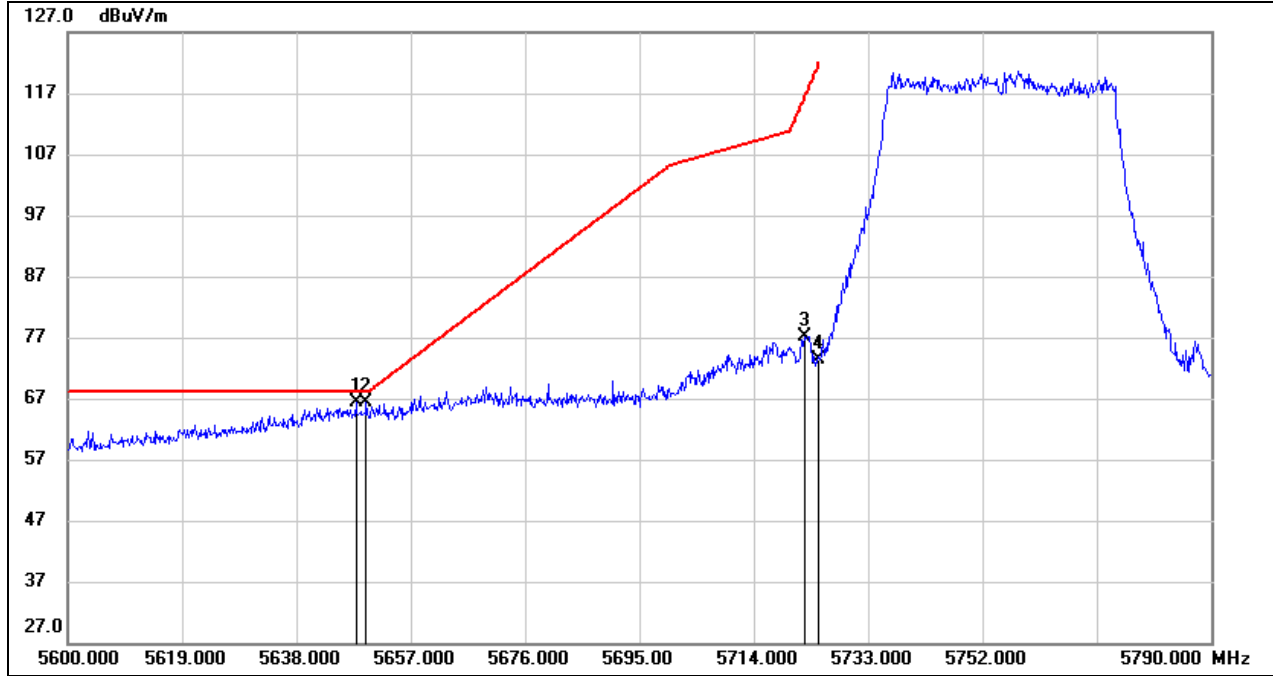

No.	Frequency (MHz)	Reading (dBuV)	Correct (dB/m)	Result (dBuV/m)	Limit (dBuV/m)	Margin (dB)	Remark
1	5647.880	25.26	41.06	66.32	68.20	-1.88	peak
2	5649.590	25.37	41.06	66.43	68.20	-1.77	peak
3	5722.360	35.96	41.25	77.21	116.18	-38.97	peak
4	5725.000	32.18	41.27	73.45	122.20	-48.75	peak



Test Mode:	802.11ax HE40 PK	Channel:	5795
Polarity:	Vertical	Test Voltage:	DC 12 V

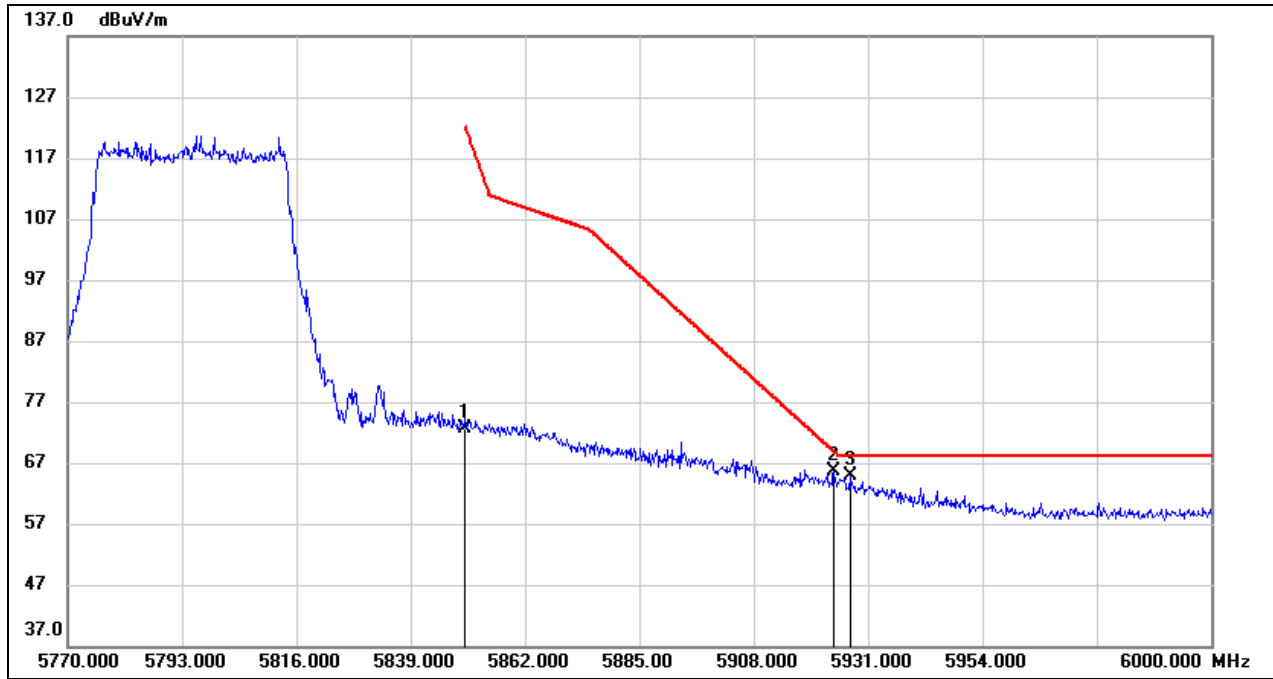

No.	Frequency (MHz)	Reading (dBuV)	Correct (dB/m)	Result (dBuV/m)	Limit (dBuV/m)	Margin (dB)	Remark
1	5850.000	31.10	41.60	72.70	122.20	-49.50	peak
2	5924.100	23.84	41.79	65.63	68.86	-3.23	peak
3	5927.320	23.16	41.81	64.97	68.20	-3.23	peak



Test Mode:	802.11ax HE80 PK	Channel:	5210
Polarity:	Vertical	Test Voltage:	DC 12 V

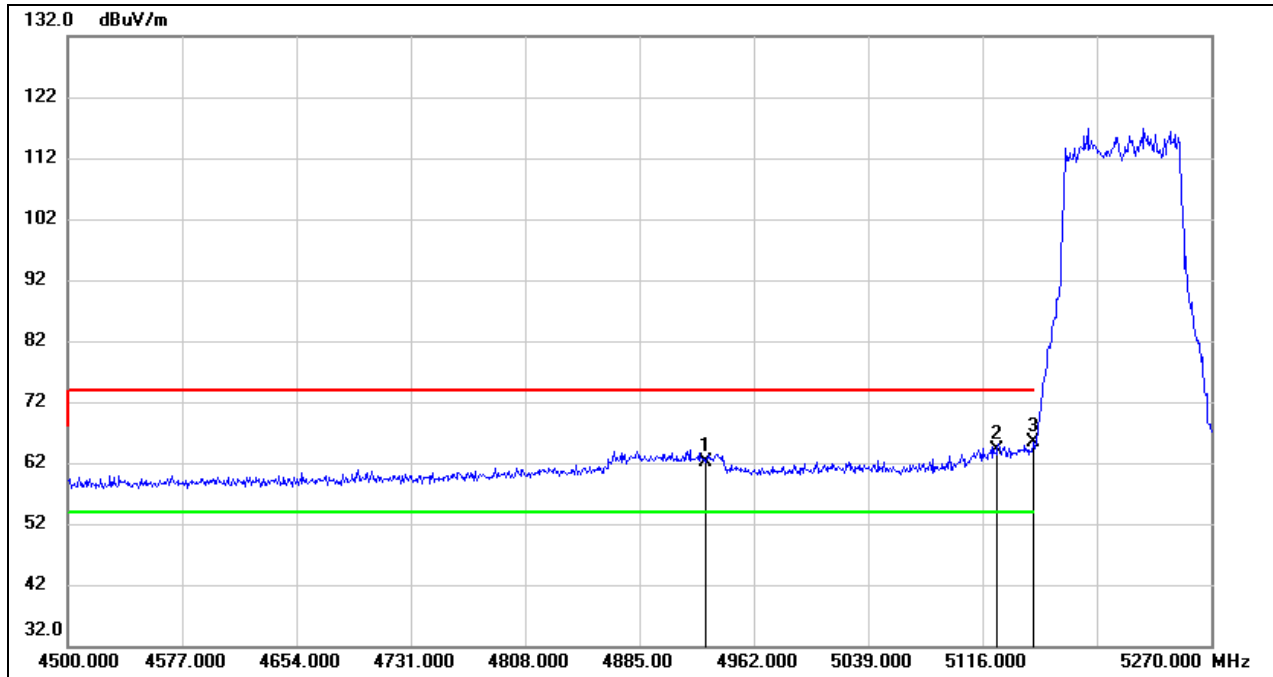

No.	Frequency (MHz)	Reading (dBuV)	Correct (dB/m)	Result (dBuV/m)	Limit (dBuV/m)	Margin (dB)	Remark
1	4929.660	22.25	39.84	62.09	74.00	-11.91	peak
2	5126.010	24.00	40.25	64.25	74.00	-9.75	peak
3	5150.000	24.99	40.27	65.26	74.00	-8.74	peak



Test Mode:	802.11ax HE80 AV	Channel:	5210
Polarity:	Vertical	Test Voltage:	DC 12 V

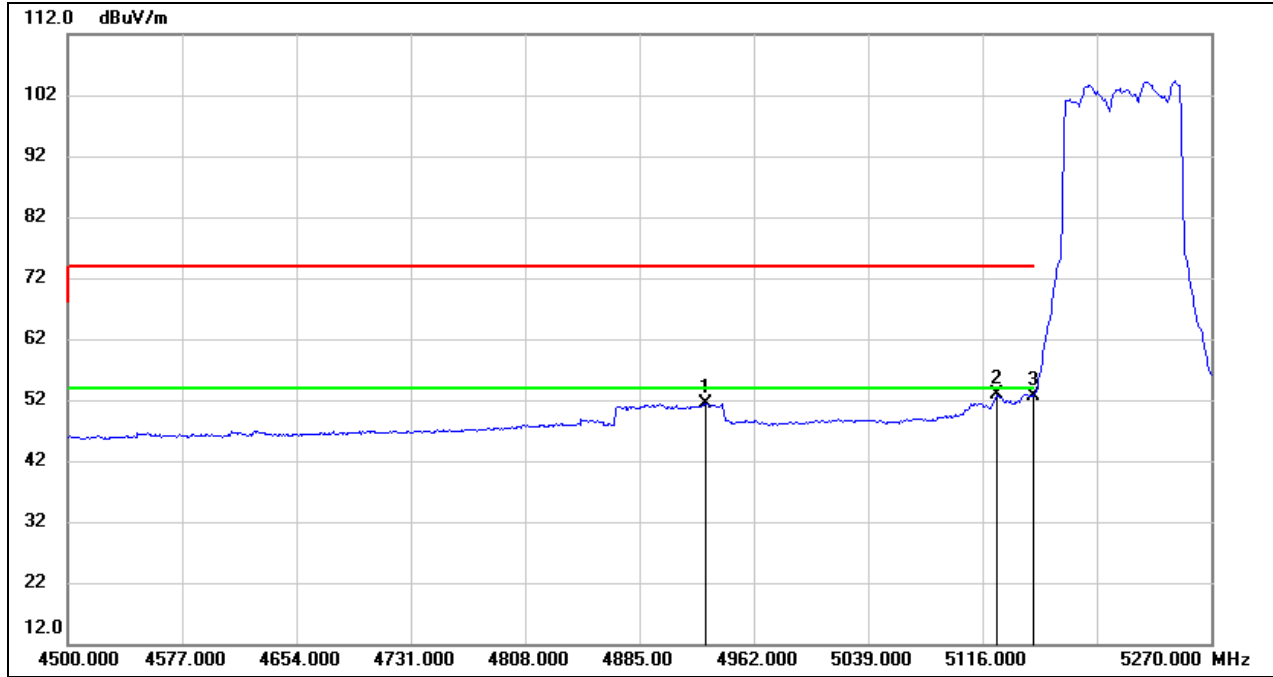

No.	Frequency (MHz)	Reading (dBuV)	Correct (dB/m)	Result (dBuV/m)	Limit (dBuV/m)	Margin (dB)	Remark
1	4929.660	11.59	39.84	51.43	54.00	-2.57	AVG
2	5126.010	12.55	40.25	52.80	54.00	-1.20	AVG
3	5150.000	12.42	40.27	52.69	54.00	-1.31	AVG



Test Mode:	802.11ax HE80 PK	Channel:	5775
Polarity:	Vertical	Test Voltage:	DC 12 V

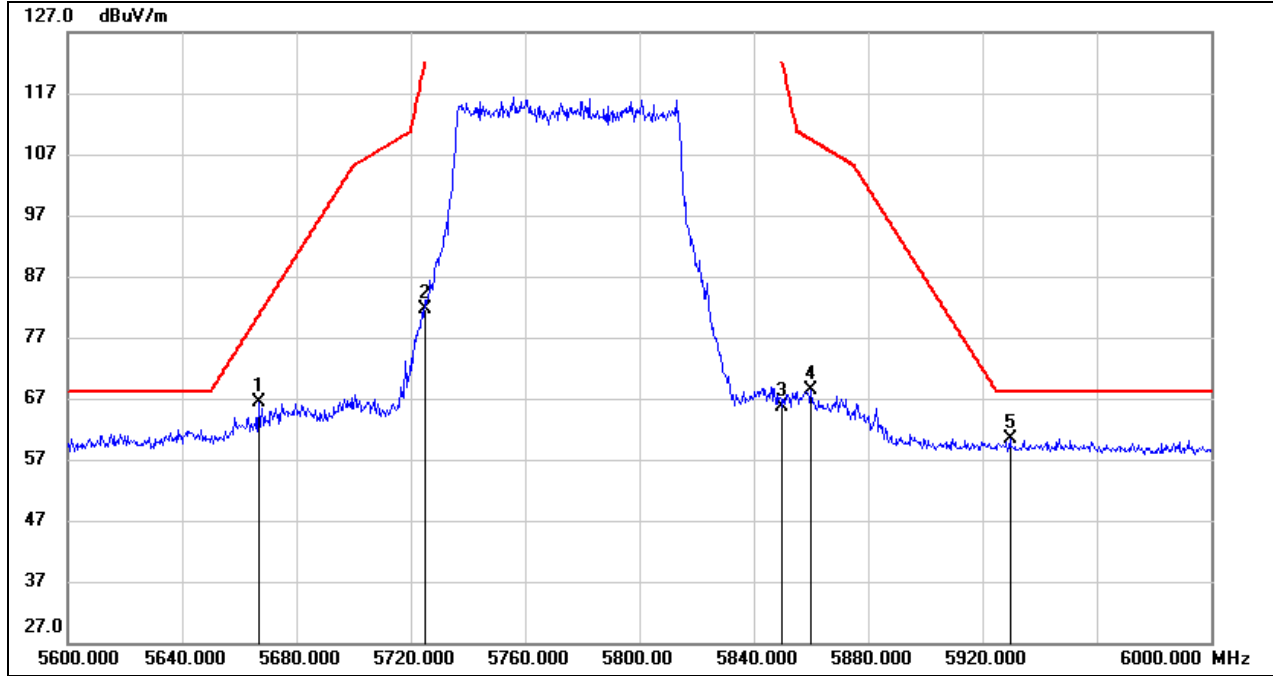

No.	Frequency (MHz)	Reading (dBuV)	Correct (dB/m)	Result (dBuV/m)	Limit (dBuV/m)	Margin (dB)	Remark
1	5666.800	25.18	41.11	66.29	80.67	-14.38	peak
2	5725.000	40.48	41.27	81.75	122.20	-40.45	peak
3	5850.000	24.00	41.60	65.60	122.20	-56.60	peak
4	5860.000	26.70	41.62	68.32	109.40	-41.08	peak
5	5929.600	18.54	41.81	60.35	68.20	-7.85	peak



Test Mode:	802.11be EHT20 PK	Channel:	5180
Polarity:	Vertical	Test Voltage:	DC 12 V

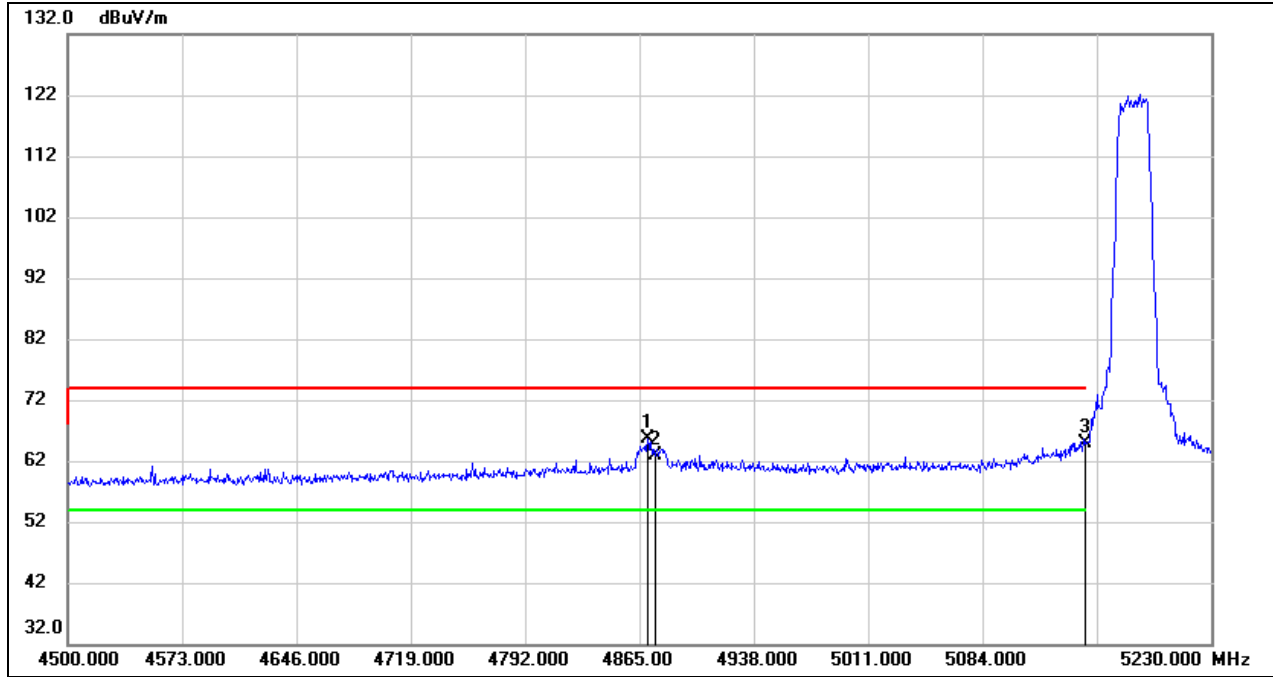

No.	Frequency (MHz)	Reading (dBuV)	Correct (dB/m)	Result (dBuV/m)	Limit (dBuV/m)	Margin (dB)	Remark
1	4870.110	26.04	39.62	65.66	74.00	-8.34	peak
2	4875.220	23.23	39.65	62.88	74.00	-11.12	peak
3	5150.000	24.55	40.27	64.82	74.00	-9.18	peak



Test Mode:	802.11be EHT20 AV	Channel:	5180
Polarity:	Vertical	Test Voltage:	DC 12 V

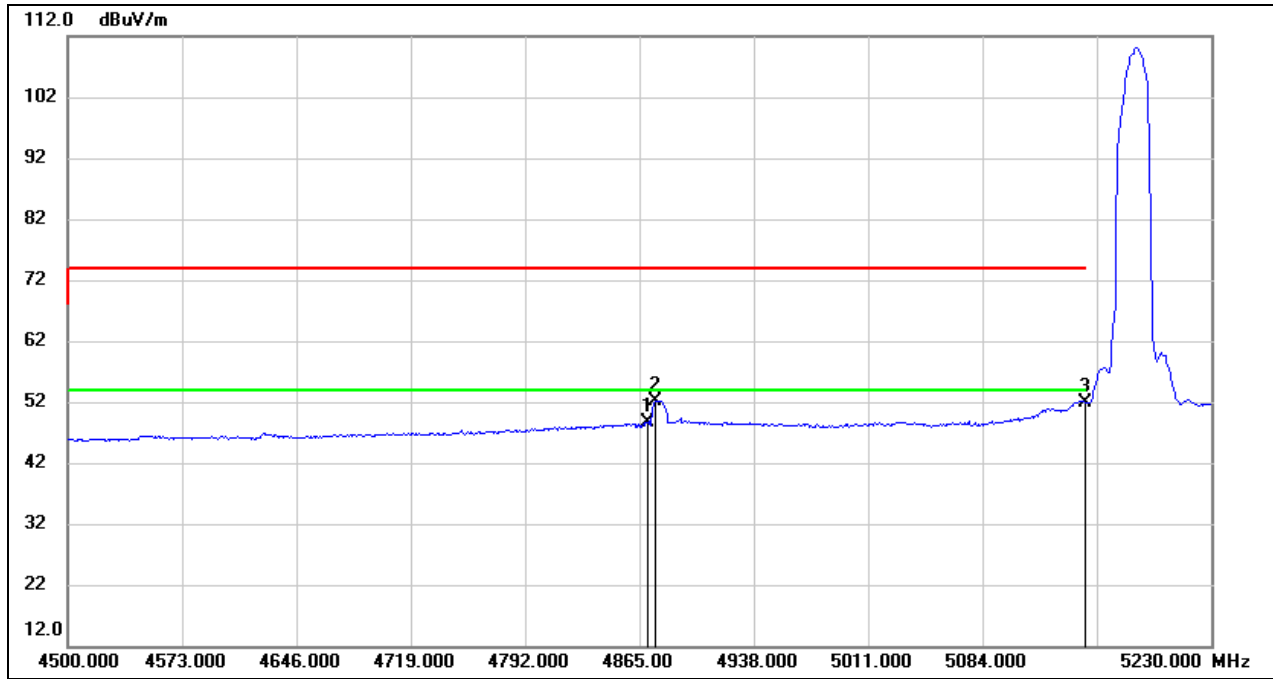

No.	Frequency (MHz)	Reading (dBuV)	Correct (dB/m)	Result (dBuV/m)	Limit (dBuV/m)	Margin (dB)	Remark
1	4870.110	8.89	39.62	48.51	54.00	-5.49	AVG
2	4875.220	12.57	39.65	52.22	54.00	-1.78	AVG
3	5150.000	11.52	40.27	51.79	54.00	-2.21	AVG





Test Mode:	802.11be EHT20 PK	Channel:	5240
Polarity:	Vertical	Test Voltage:	DC 12 V

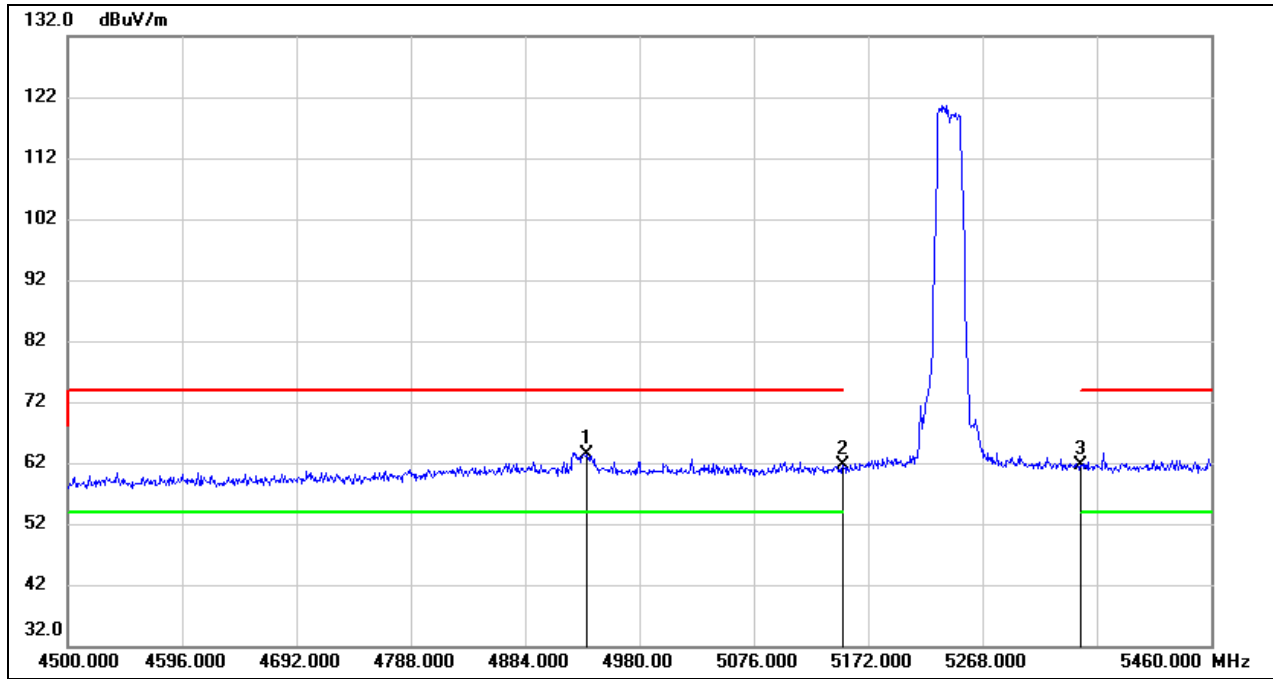

No.	Frequency (MHz)	Reading (dBuV)	Correct (dB/m)	Result (dBuV/m)	Limit (dBuV/m)	Margin (dB)	Remark
1	4935.840	23.45	39.87	63.32	74.00	-10.68	peak
2	5150.000	21.33	40.27	61.60	74.00	-12.40	peak
3	5350.000	21.08	40.49	61.57	74.00	-12.43	peak



Test Mode:	802.11be EHT20 AV	Channel:	5240
Polarity:	Vertical	Test Voltage:	DC 12 V

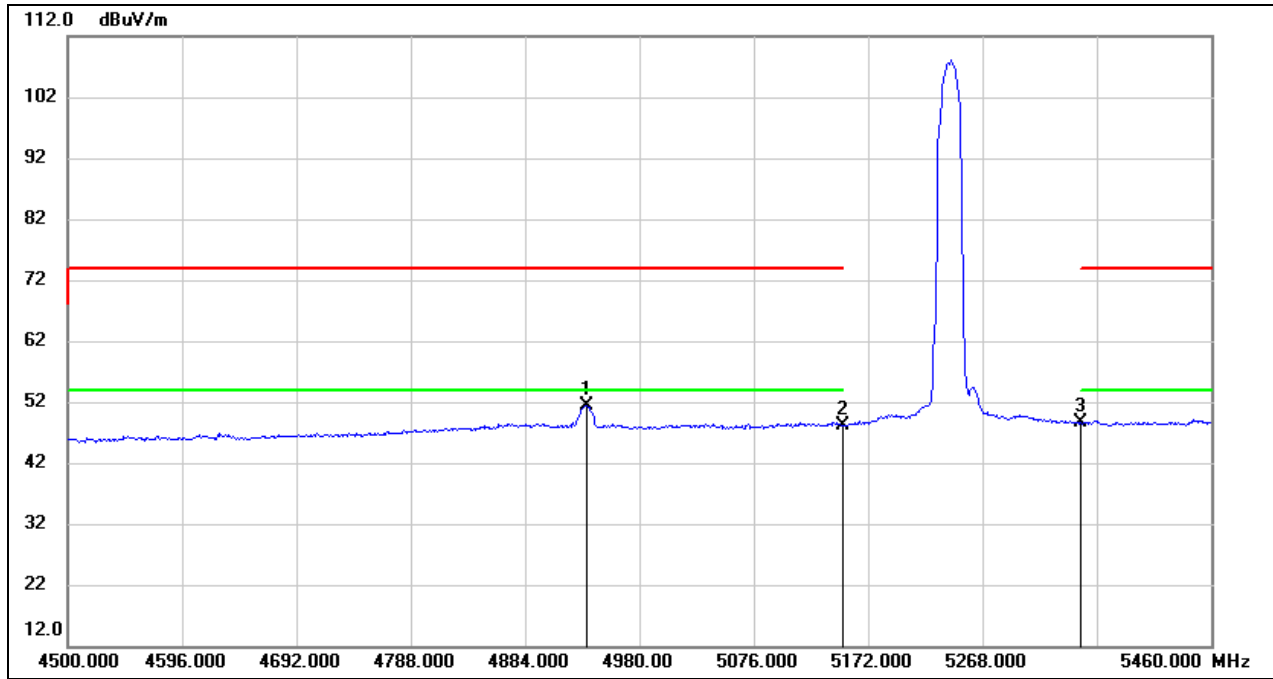

No.	Frequency (MHz)	Reading (dBuV)	Correct (dB/m)	Result (dBuV/m)	Limit (dBuV/m)	Margin (dB)	Remark
1	4935.840	11.53	39.87	51.40	54.00	-2.60	AVG
2	5150.000	7.88	40.27	48.15	54.00	-5.85	AVG
3	5350.000	8.03	40.49	48.52	54.00	-5.48	AVG



Test Mode:	802.11be EHT20 PK	Channel:	5745
Polarity:	Vertical	Test Voltage:	DC 12 V

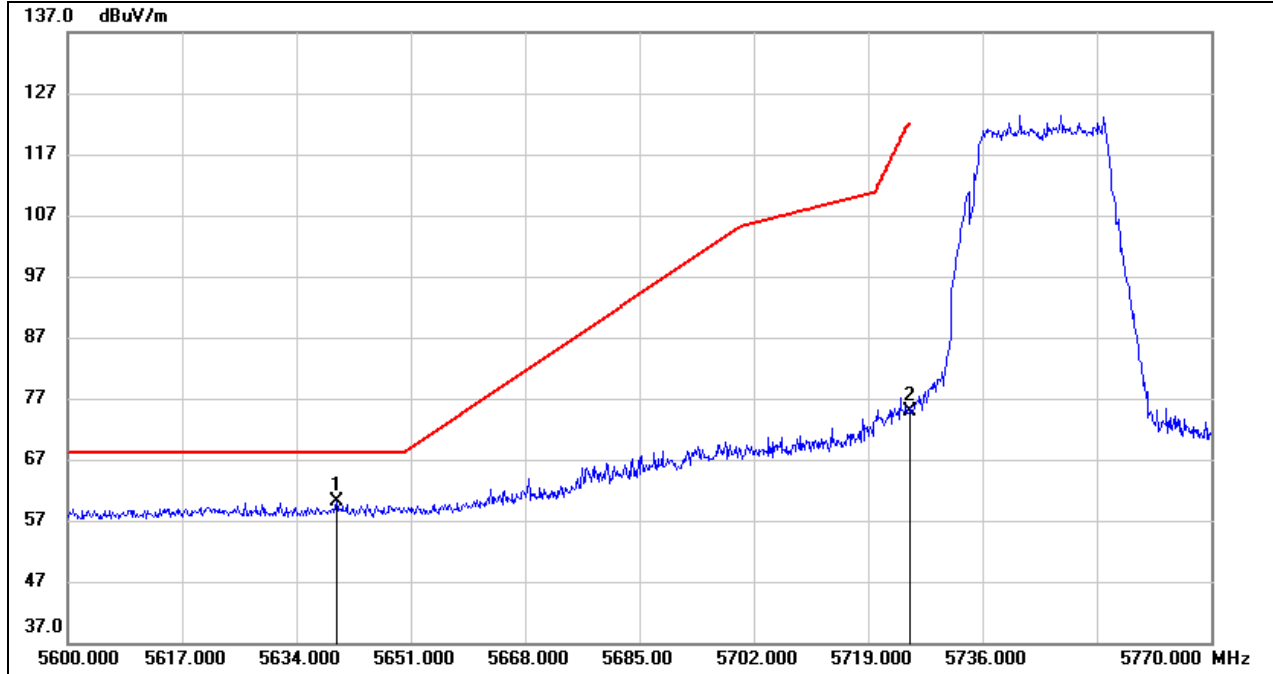

No.	Frequency (MHz)	Reading (dBuV)	Correct (dB/m)	Result (dBuV/m)	Limit (dBuV/m)	Margin (dB)	Remark
1	5639.950	19.14	41.04	60.18	68.20	-8.02	peak
2	5725.000	33.53	41.27	74.80	122.20	-47.40	peak



Test Mode:	802.11be EHT20 PK	Channel:	5825
Polarity:	Vertical	Test Voltage:	DC 12 V

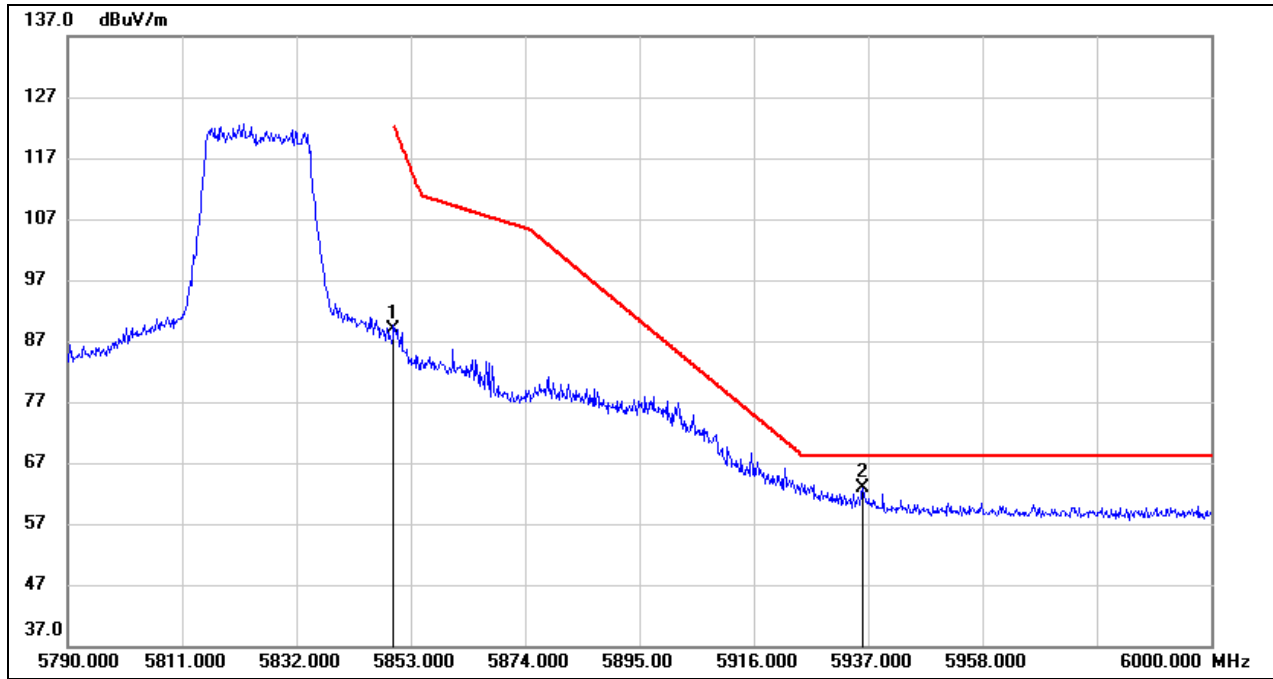

No.	Frequency (MHz)	Reading (dBuV)	Correct (dB/m)	Result (dBuV/m)	Limit (dBuV/m)	Margin (dB)	Remark
1	5850.000	47.30	41.60	88.90	122.20	-33.30	peak
2	5935.950	21.11	41.83	62.94	68.20	-5.26	peak



Test Mode:	802.11be EHT40 PK	Channel:	5190
Polarity:	Vertical	Test Voltage:	DC 12 V

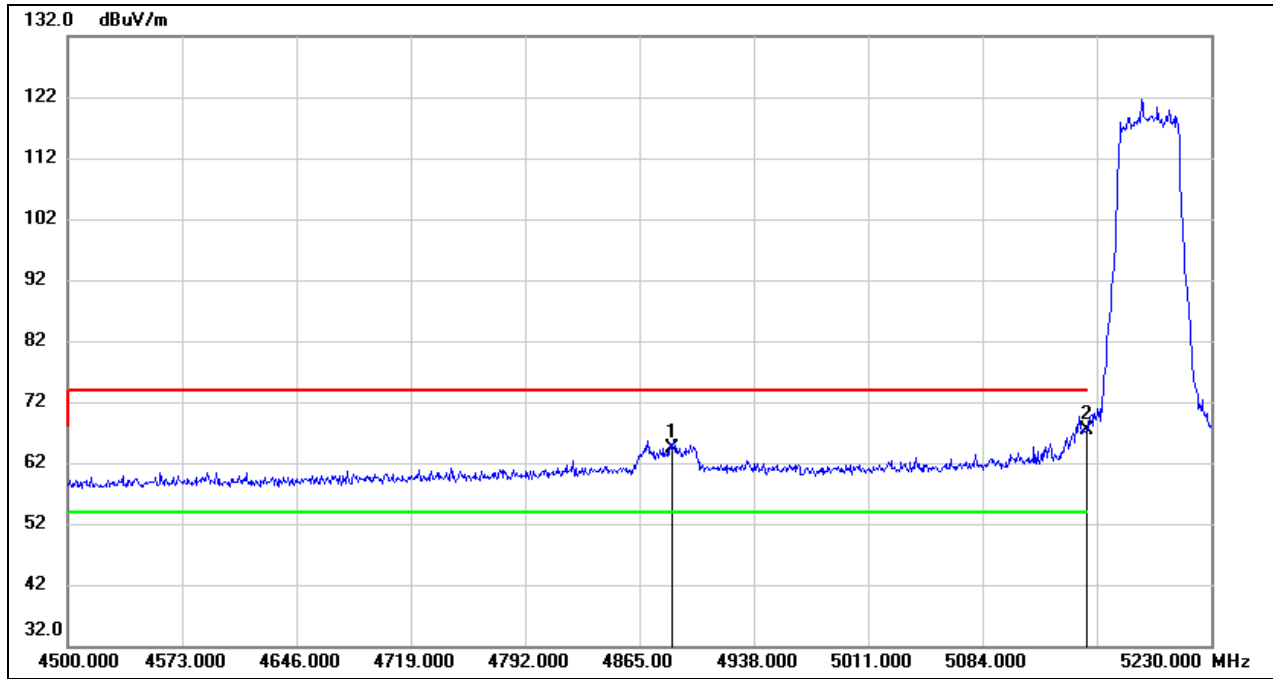

No.	Frequency (MHz)	Reading (dBuV)	Correct (dB/m)	Result (dBuV/m)	Limit (dBuV/m)	Margin (dB)	Remark
1	4886.170	24.80	39.68	64.48	74.00	-9.52	peak
2	5150.000	27.14	40.27	67.41	74.00	-6.59	peak



Test Mode:	802.11be EHT40 AV	Channel:	5190
Polarity:	Vertical	Test Voltage:	DC 12 V

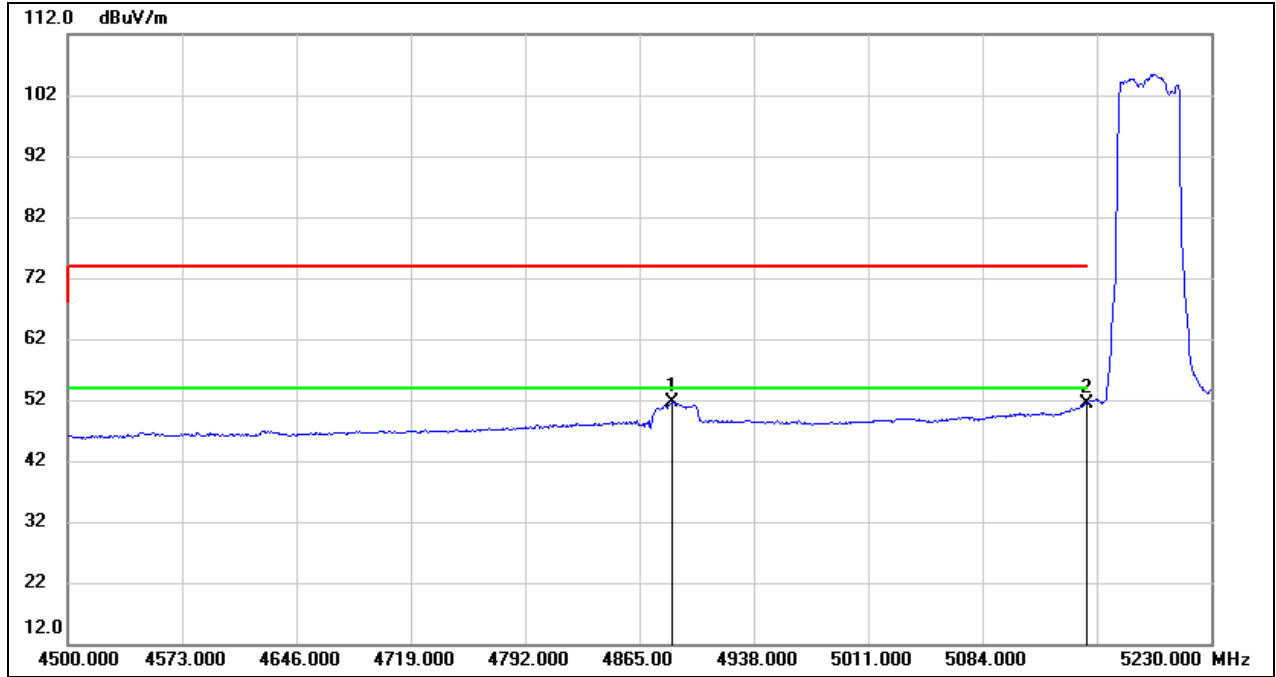

No.	Frequency (MHz)	Reading (dBuV)	Correct (dB/m)	Result (dBuV/m)	Limit (dBuV/m)	Margin (dB)	Remark
1	4886.170	11.85	39.68	51.53	54.00	-2.47	AVG
2	5150.000	11.16	40.27	51.43	54.00	-2.57	AVG



Test Mode:	802.11be EHT40 PK	Channel:	5755
Polarity:	Vertical	Test Voltage:	DC 12 V

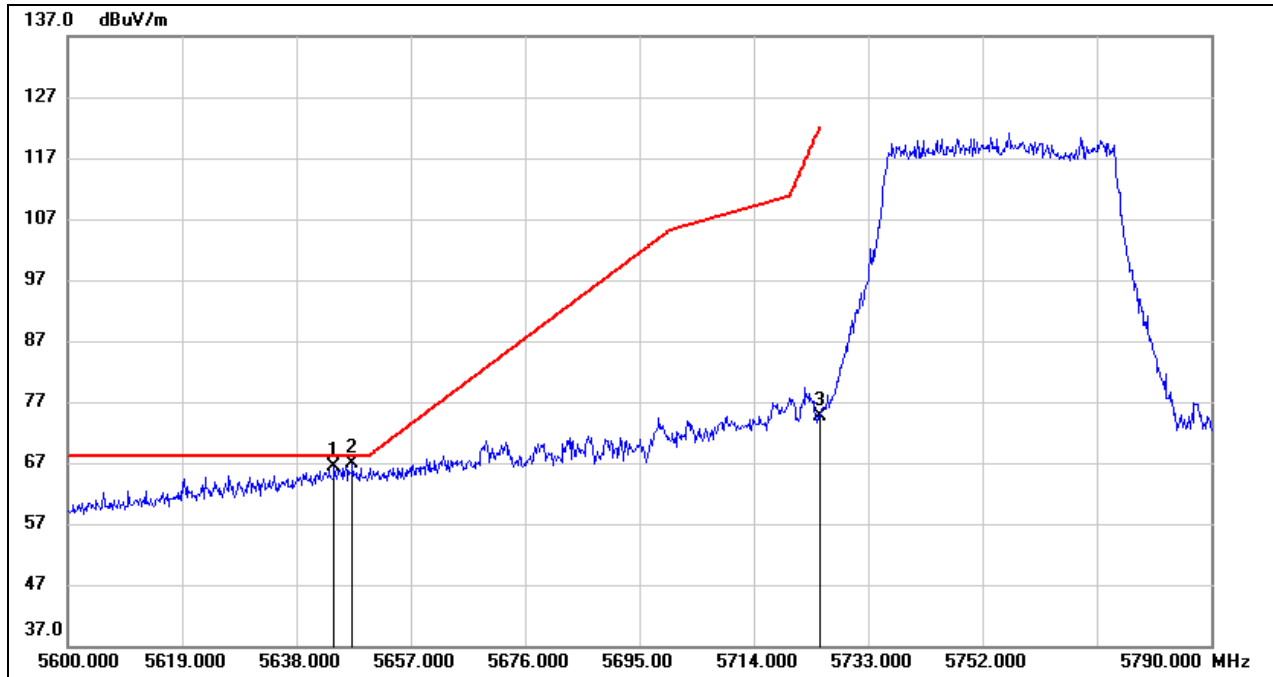

No.	Frequency (MHz)	Reading (dBuV)	Correct (dB/m)	Result (dBuV/m)	Limit (dBuV/m)	Margin (dB)	Remark
1	5644.270	25.44	41.04	66.48	68.20	-1.72	peak
2	5647.310	25.78	41.06	66.84	68.20	-1.36	peak
3	5725.000	33.45	41.27	74.72	122.20	-47.48	peak



Test Mode:	802.11be EHT40 PK	Channel:	5795
Polarity:	Vertical	Test Voltage:	DC 12 V

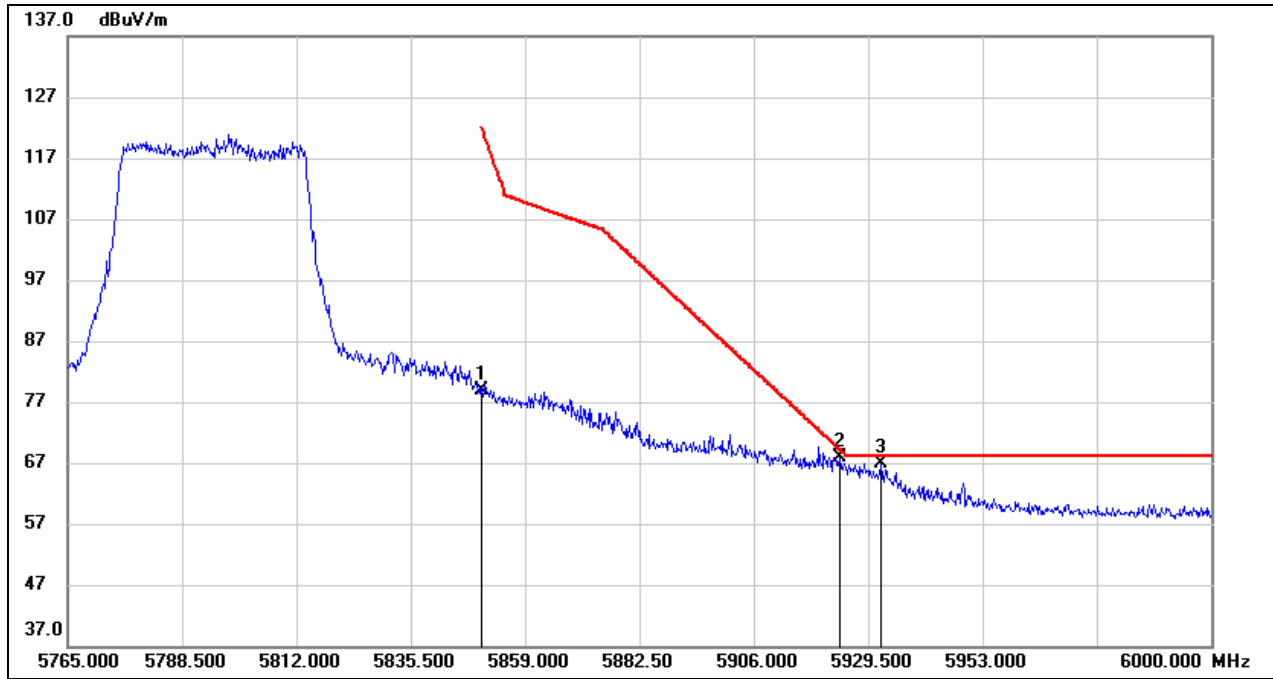

No.	Frequency (MHz)	Reading (dBuV)	Correct (dB/m)	Result (dBuV/m)	Limit (dBuV/m)	Margin (dB)	Remark
1	5850.000	37.31	41.60	78.91	122.20	-43.29	peak
2	5923.625	26.09	41.79	67.88	69.21	-1.33	peak
3	5932.085	25.07	41.82	66.89	68.20	-1.31	peak





Test Mode:	802.11be EHT80 PK	Channel:	5210
Polarity:	Vertical	Test Voltage:	DC 12 V

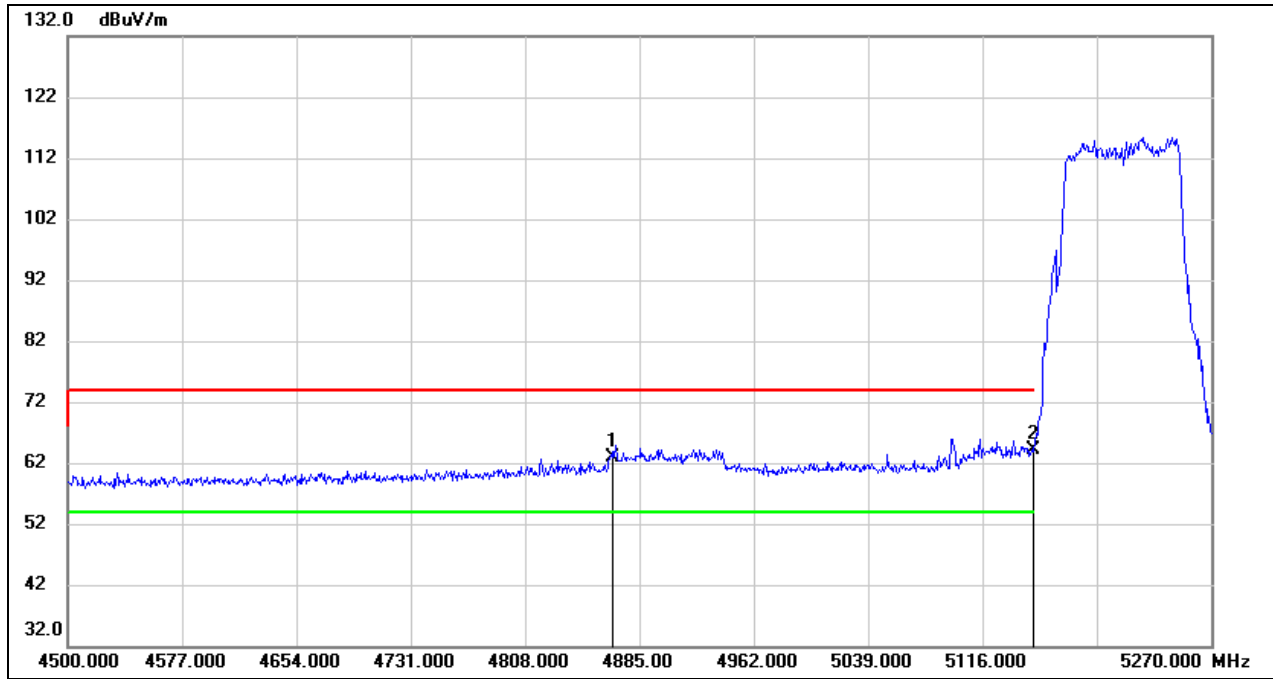

No.	Frequency (MHz)	Reading (dBuV)	Correct (dB/m)	Result (dBuV/m)	Limit (dBuV/m)	Margin (dB)	Remark
1	4867.290	23.19	39.61	62.80	74.00	-11.20	peak
2	5150.000	23.95	40.27	64.22	74.00	-9.78	peak



Test Mode:	802.11be EHT80 AV	Channel:	5210
Polarity:	Vertical	Test Voltage:	DC 12 V

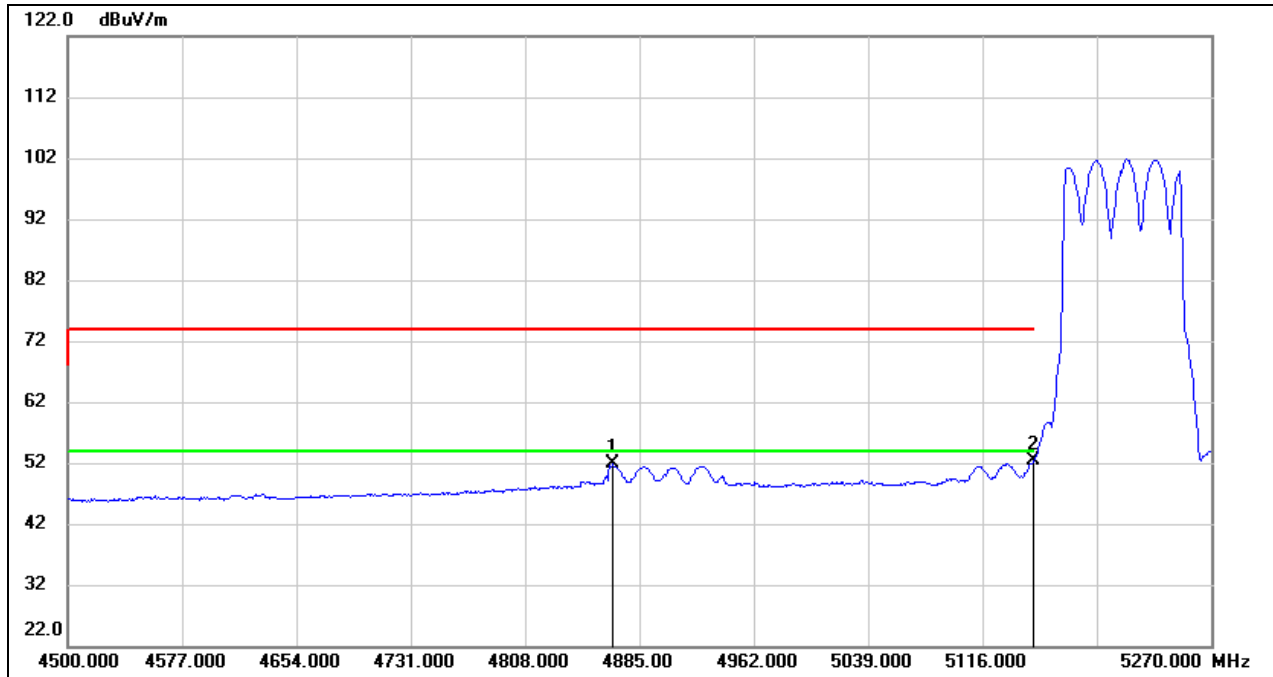

No.	Frequency (MHz)	Reading (dBuV)	Correct (dB/m)	Result (dBuV/m)	Limit (dBuV/m)	Margin (dB)	Remark
1	4867.290	12.22	39.61	51.83	54.00	-2.17	AVG
2	5150.000	12.03	40.27	52.30	54.00	-1.70	AVG



Test Mode:	802.11be EHT80 PK	Channel:	5775
Polarity:	Vertical	Test Voltage:	DC 12 V

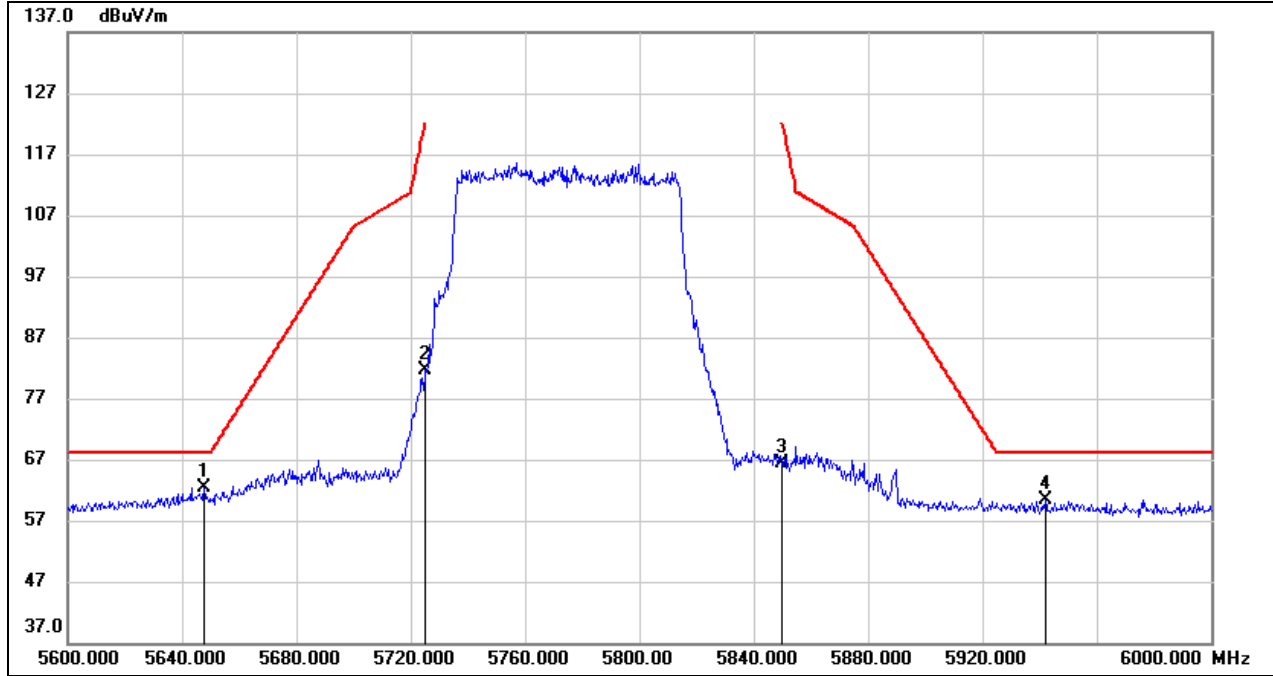

No.	Frequency (MHz)	Reading (dBuV)	Correct (dB/m)	Result (dBuV/m)	Limit (dBuV/m)	Margin (dB)	Remark
1	5647.600	21.38	41.06	62.44	68.20	-5.76	peak
2	5725.000	40.26	41.27	81.53	122.20	-40.67	peak
3	5850.000	24.88	41.60	66.48	122.20	-55.72	peak
4	5942.000	18.53	41.84	60.37	68.20	-7.83	peak

**8.2. SPURIOUS EMISSIONS(1 GHZ~7 GHZ)**

Test Mode:	802.11a 20	Channel:	5180
Polarity:	Horizontal	Test Voltage:	DC 12 V

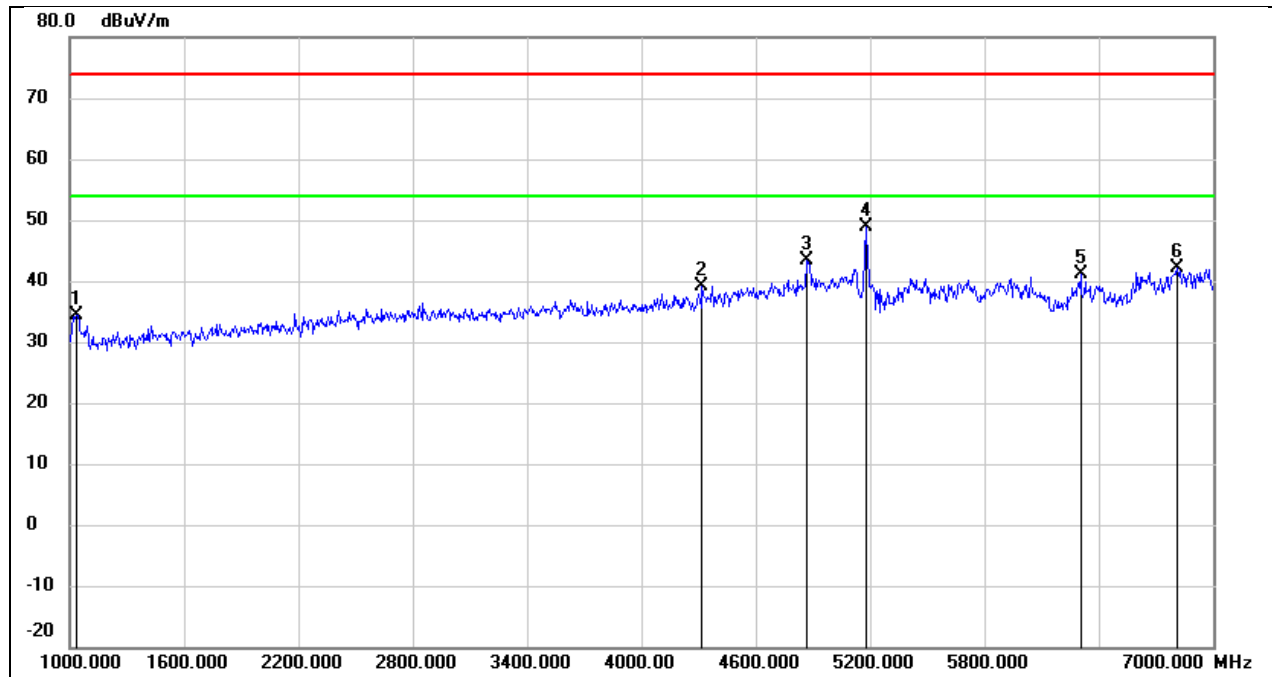

No.	Frequency (MHz)	Reading (dBuV)	Correct (dB/m)	Result (dBuV/m)	Limit (dBuV/m)	Margin (dB)	Remark
1	1036.000	49.18	-14.87	34.31	74.00	-39.69	peak
2	4318.000	42.06	-2.99	39.07	74.00	-34.93	peak
3	4870.000	44.13	-0.66	43.47	74.00	-30.53	peak
4	5176.000	48.85	0.05	48.90	74.00	-25.10	peak
5	6304.000	38.09	2.99	41.08	74.00	-32.92	peak
6	6814.000	36.90	5.28	42.18	74.00	-31.82	peak



Test Mode:	802.11a 20	Channel:	5180
Polarity:	Vertical	Test Voltage:	DC 12 V

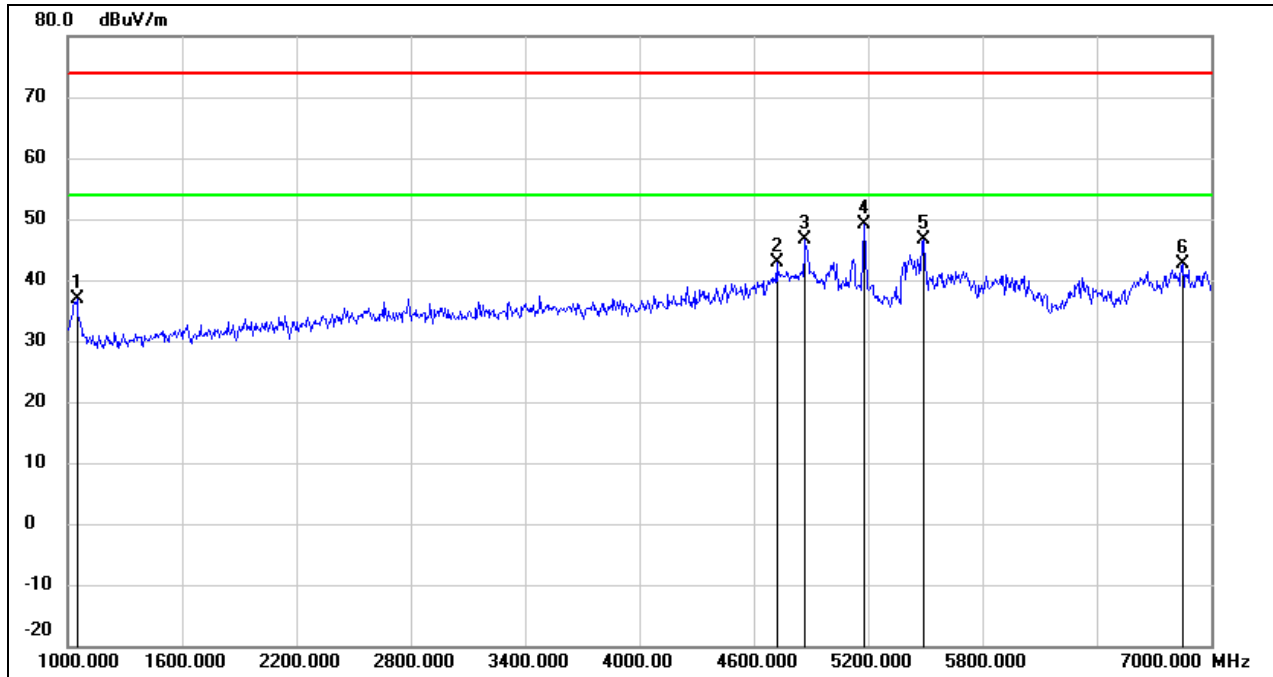

No.	Frequency (MHz)	Reading (dBuV)	Correct (dB/m)	Result (dBuV/m)	Limit (dBuV/m)	Margin (dB)	Remark
1	1048.000	51.61	-14.81	36.80	74.00	-37.20	peak
2	4720.000	44.19	-1.27	42.92	74.00	-31.08	peak
3	4870.000	47.32	-0.66	46.66	74.00	-27.34	peak
4	5176.000	49.04	0.05	49.09	74.00	-24.91	peak
5	5488.000	46.22	0.41	46.63	74.00	-27.37	peak
6	6850.000	37.05	5.46	42.51	74.00	-31.49	peak



Test Mode:	802.11a 20	Channel:	5200
Polarity:	Horizontal	Test Voltage:	DC 12 V

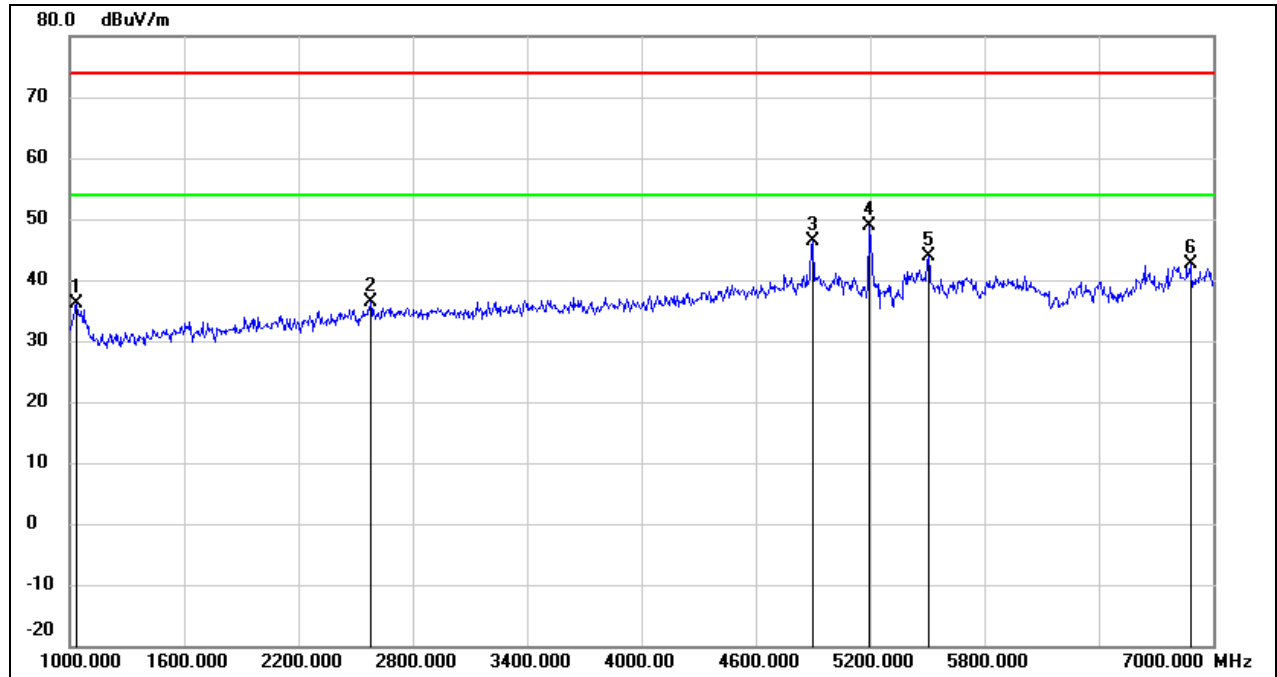

No.	Frequency (MHz)	Reading (dBuV)	Correct (dB/m)	Result (dBuV/m)	Limit (dBuV/m)	Margin (dB)	Remark
1	1036.000	50.95	-14.87	36.08	74.00	-37.92	peak
2	2578.000	44.58	-8.26	36.32	74.00	-37.68	peak
3	4900.000	46.84	-0.55	46.29	74.00	-27.71	peak
4	5194.000	48.92	0.07	48.99	74.00	-25.01	peak
5	5506.000	43.38	0.44	43.82	74.00	-30.18	peak
6	6880.000	37.04	5.60	42.64	74.00	-31.36	peak



Test Mode:	802.11a 20	Channel:	5200
Polarity:	Vertical	Test Voltage:	DC 12 V

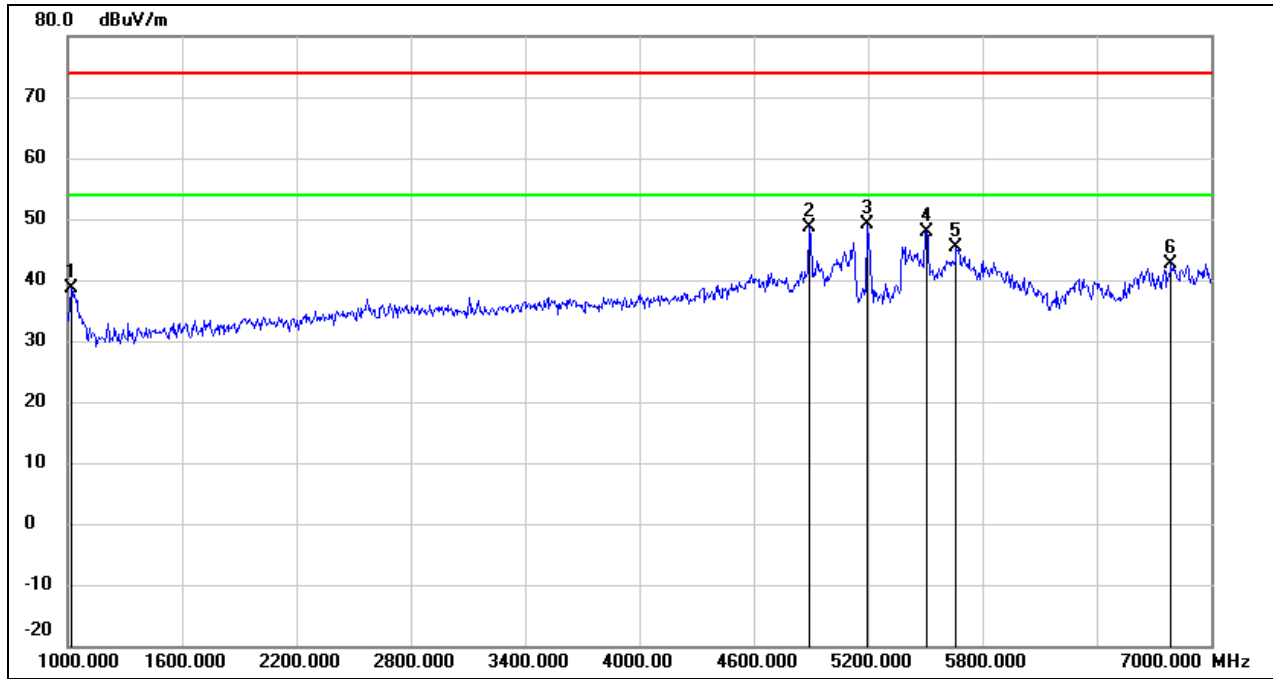

No.	Frequency (MHz)	Reading (dBuV)	Correct (dB/m)	Result (dBuV/m)	Limit (dBuV/m)	Margin (dB)	Remark
1	1018.000	53.55	-14.95	38.60	74.00	-35.40	peak
2	4888.000	49.19	-0.60	48.59	74.00	-25.41	peak
3	5194.000	48.97	0.07	49.04	74.00	-24.96	peak
4	5506.000	47.50	0.44	47.94	74.00	-26.06	peak
5	5662.000	44.42	0.89	45.31	74.00	-28.69	peak
6	6790.000	37.37	5.15	42.52	74.00	-31.48	peak



Test Mode:	802.11a 20	Channel:	5240
Polarity:	Horizontal	Test Voltage:	DC 12 V

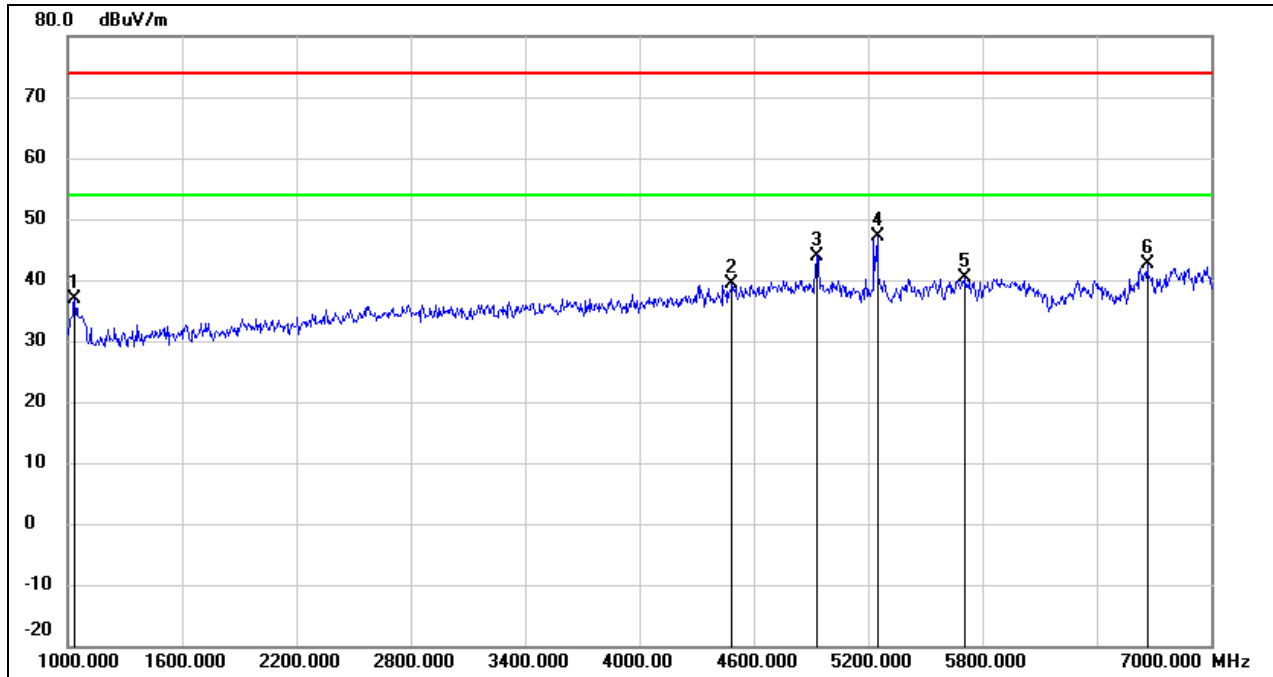

No.	Frequency (MHz)	Reading (dBuV)	Correct (dB/m)	Result (dBuV/m)	Limit (dBuV/m)	Margin (dB)	Remark
1	1036.000	51.85	-14.87	36.98	74.00	-37.02	peak
2	4486.000	41.69	-2.21	39.48	74.00	-34.52	peak
3	4930.000	44.43	-0.43	44.00	74.00	-30.00	peak
4	5248.000	47.04	0.13	47.17	74.00	-26.83	peak
5	5710.000	39.32	1.02	40.34	74.00	-33.66	peak
6	6664.000	38.07	4.54	42.61	74.00	-31.39	peak





Test Mode:	802.11a 20	Channel:	5240
Polarity:	Vertical	Test Voltage:	DC 12 V

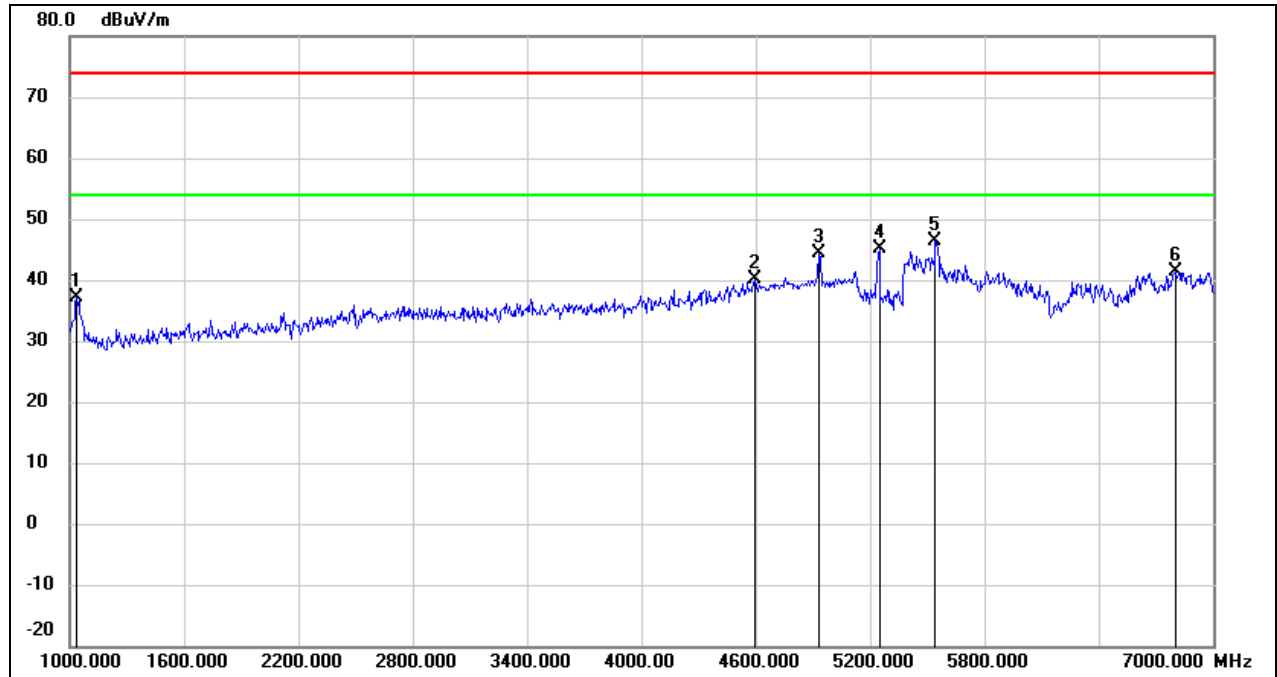

No.	Frequency (MHz)	Reading (dBuV)	Correct (dB/m)	Result (dBuV/m)	Limit (dBuV/m)	Margin (dB)	Remark
1	1036.000	52.12	-14.87	37.25	74.00	-36.75	peak
2	4594.000	41.82	-1.76	40.06	74.00	-33.94	peak
3	4930.000	44.83	-0.43	44.40	74.00	-29.60	peak
4	5248.000	45.11	0.13	45.24	74.00	-28.76	peak
5	5542.000	45.94	0.53	46.47	74.00	-27.53	peak
6	6802.000	36.15	5.21	41.36	74.00	-32.64	peak



Test Mode:	802.11a 20	Channel:	5745
Polarity:	Horizontal	Test Voltage:	DC 12 V

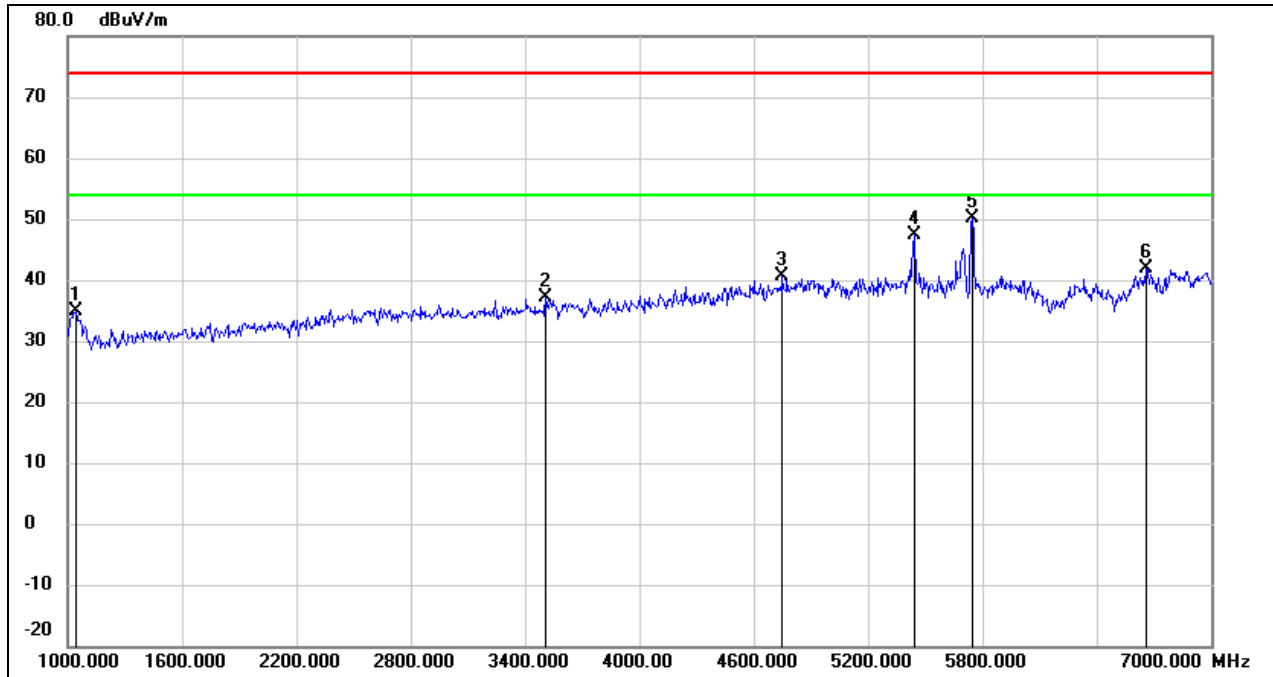

No.	Frequency (MHz)	Reading (dBuV)	Correct (dB/m)	Result (dBuV/m)	Limit (dBuV/m)	Margin (dB)	Remark
1	1042.000	49.62	-14.84	34.78	74.00	-39.22	peak
2	3508.000	42.95	-5.82	37.13	74.00	-36.87	peak
3	4750.000	41.73	-1.14	40.59	74.00	-33.41	peak
4	5446.000	46.96	0.35	47.31	74.00	-26.69	peak
5	5746.000	49.10	1.12	50.22	74.00	-23.78	peak
6	6658.000	37.39	4.49	41.88	74.00	-32.12	peak



Test Mode:	802.11a 20	Channel:	5745
Polarity:	Vertical	Test Voltage:	DC 12 V

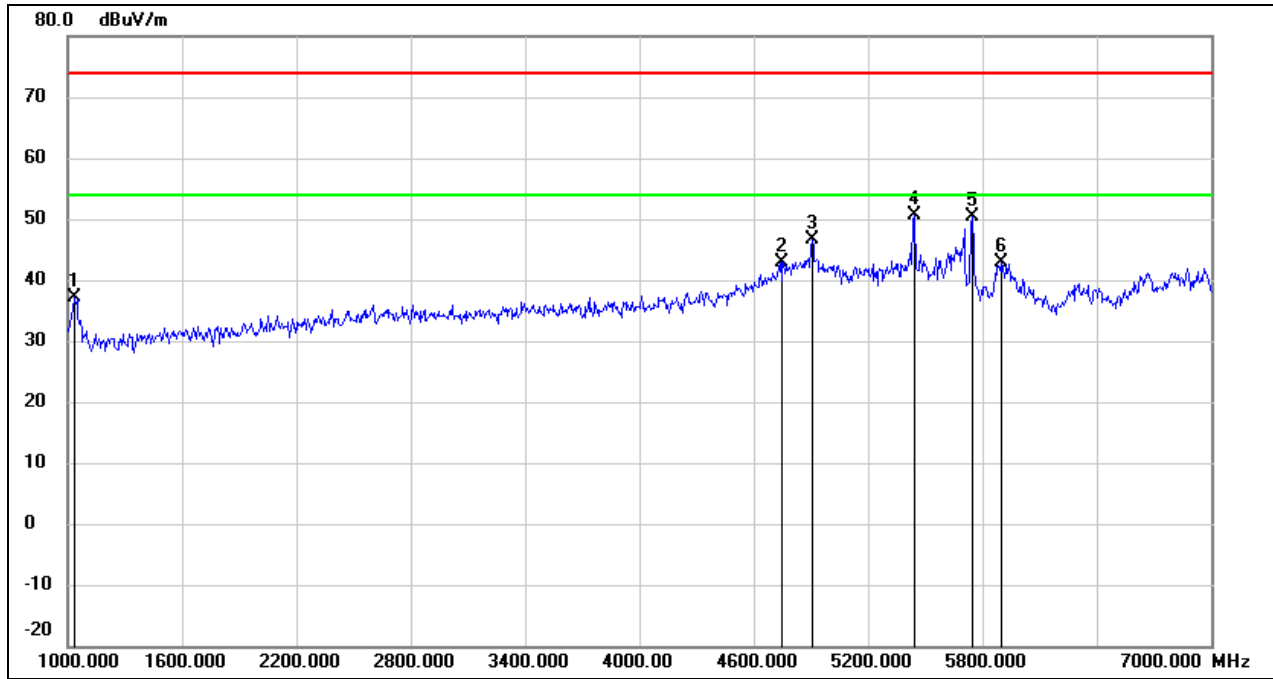

No.	Frequency (MHz)	Reading (dBuV)	Correct (dB/m)	Result (dBuV/m)	Limit (dBuV/m)	Margin (dB)	Remark
1	1036.000	51.97	-14.87	37.10	74.00	-36.90	peak
2	4750.000	44.06	-1.14	42.92	74.00	-31.08	peak
3	4906.000	47.27	-0.53	46.74	74.00	-27.26	peak
4	5440.000	50.17	0.35	50.52	74.00	-23.48	peak
5	5746.000	49.36	1.12	50.48	74.00	-23.52	peak
6	5896.000	41.36	1.56	42.92	74.00	-31.08	peak



Test Mode:	802.11a 20	Channel:	5785
Polarity:	Horizontal	Test Voltage:	DC 12 V

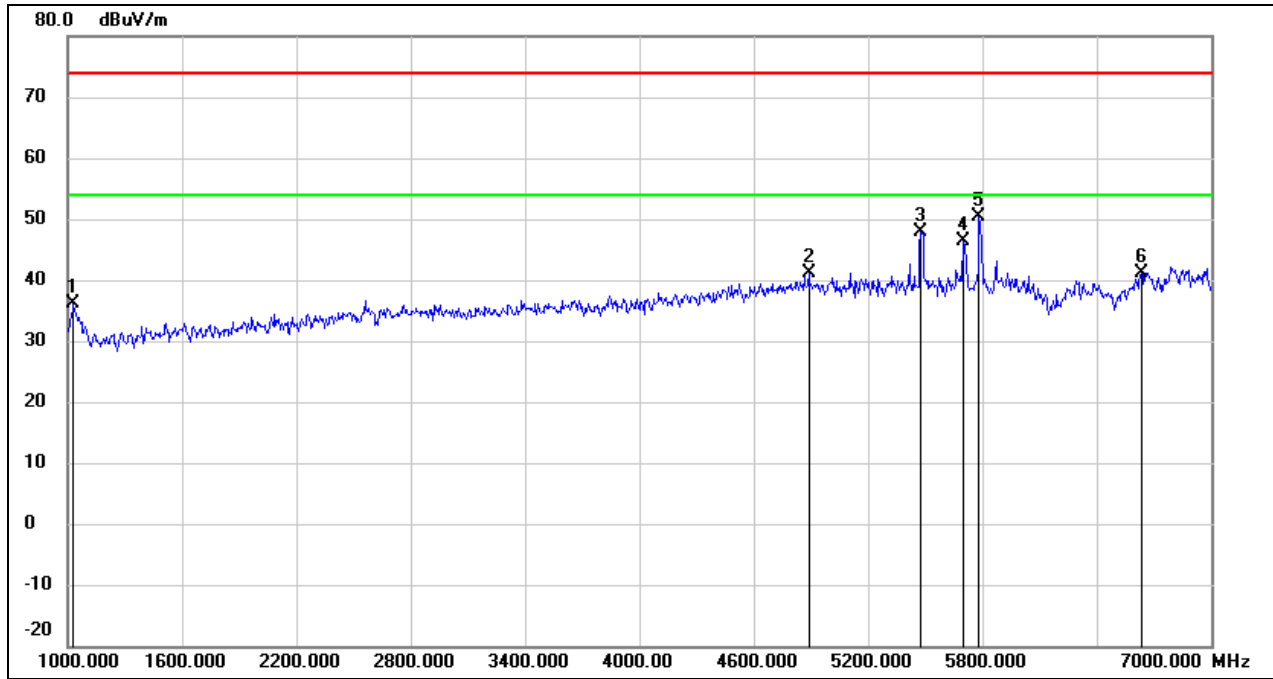

No.	Frequency (MHz)	Reading (dBuV)	Correct (dB/m)	Result (dBuV/m)	Limit (dBuV/m)	Margin (dB)	Remark
1	1030.000	50.94	-14.89	36.05	74.00	-37.95	peak
2	4888.000	41.64	-0.60	41.04	74.00	-32.96	peak
3	5476.000	47.42	0.39	47.81	74.00	-26.19	peak
4	5698.000	45.48	0.99	46.47	74.00	-27.53	peak
5	5782.000	49.22	1.23	50.45	74.00	-23.55	peak
6	6634.000	36.87	4.38	41.25	74.00	-32.75	peak



Test Mode:	802.11a 20	Channel:	5785
Polarity:	Vertical	Test Voltage:	DC 12 V

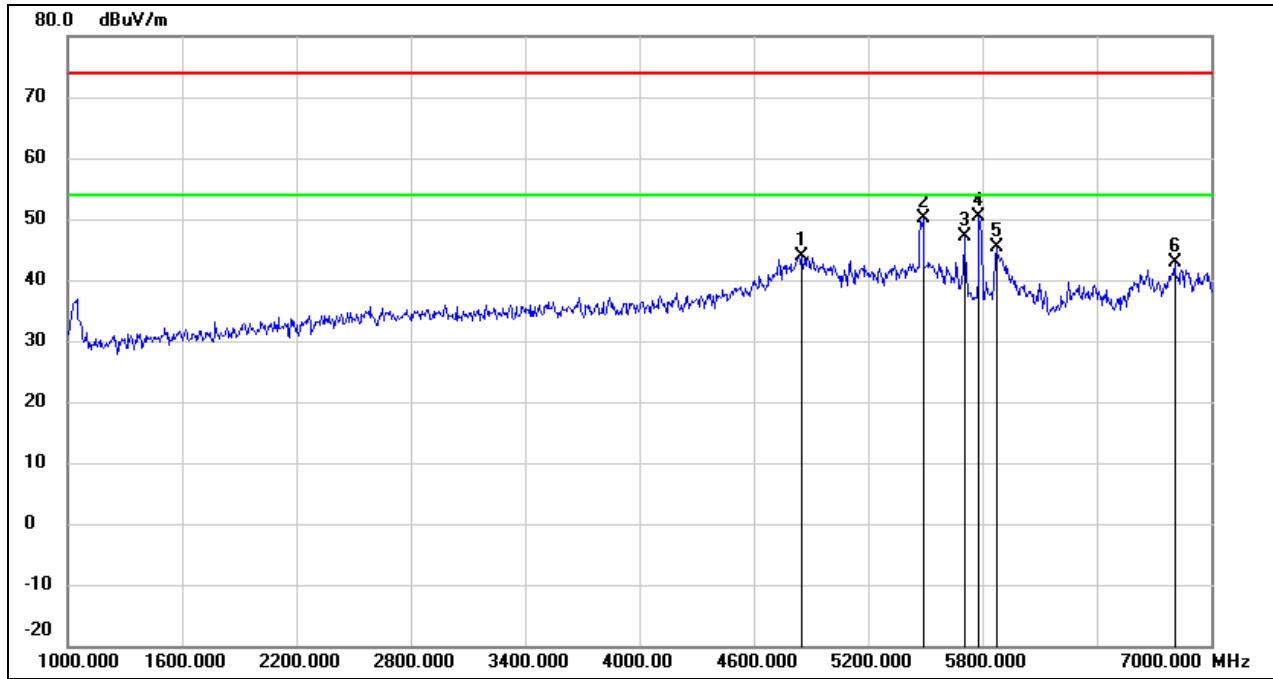

No.	Frequency (MHz)	Reading (dBuV)	Correct (dB/m)	Result (dBuV/m)	Limit (dBuV/m)	Margin (dB)	Remark
1	4852.000	44.67	-0.74	43.93	74.00	-30.07	peak
2	5488.000	49.66	0.41	50.07	74.00	-23.93	peak
3	5704.000	46.23	1.00	47.23	74.00	-26.77	peak
4	5782.000	49.24	1.23	50.47	74.00	-23.53	peak
5	5872.000	43.78	1.48	45.26	74.00	-28.74	peak
6	6808.000	37.52	5.24	42.76	74.00	-31.24	peak



Test Mode:	802.11a 20	Channel:	5825
Polarity:	Horizontal	Test Voltage:	DC 12 V

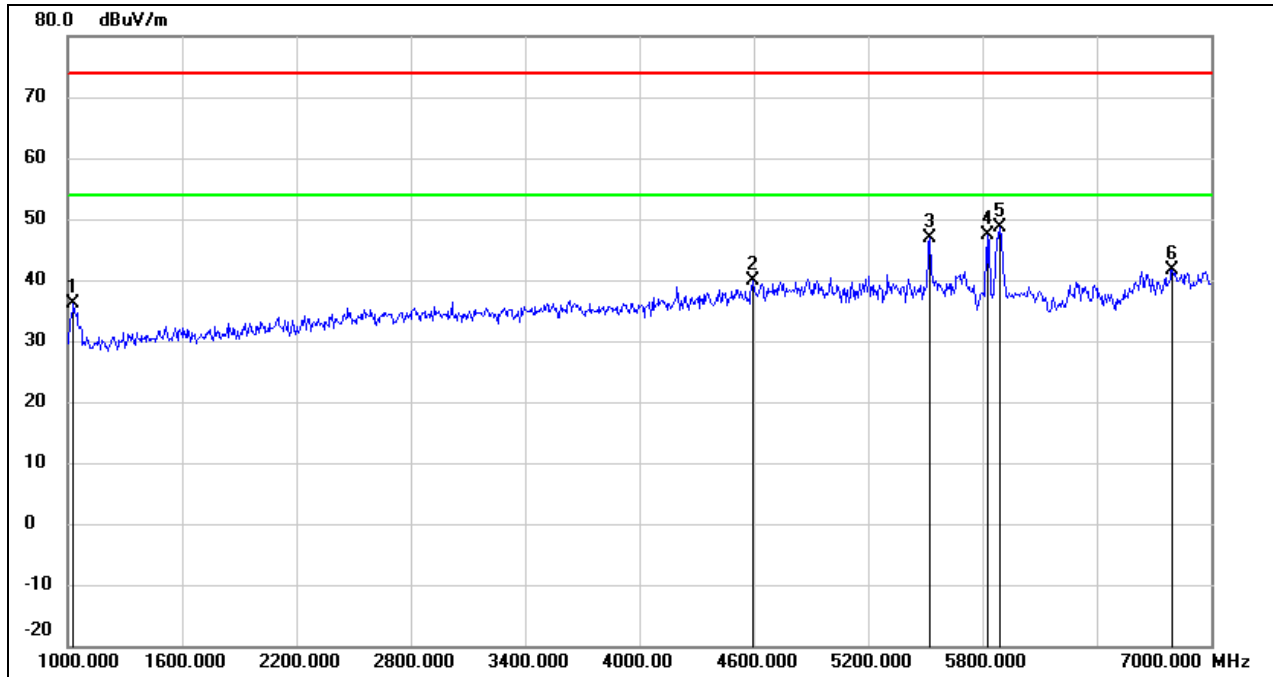

No.	Frequency (MHz)	Reading (dBuV)	Correct (dB/m)	Result (dBuV/m)	Limit (dBuV/m)	Margin (dB)	Remark
1	1030.000	51.09	-14.89	36.20	74.00	-37.80	peak
2	4594.000	41.64	-1.76	39.88	74.00	-34.12	peak
3	5524.000	46.39	0.48	46.87	74.00	-27.13	peak
4	5830.000	45.97	1.36	47.33	74.00	-26.67	peak
5	5890.000	47.17	1.54	48.71	74.00	-25.29	peak
6	6796.000	36.47	5.19	41.66	74.00	-32.34	peak



Test Mode:	802.11a 20	Channel:	5825
Polarity:	Vertical	Test Voltage:	DC 12 V

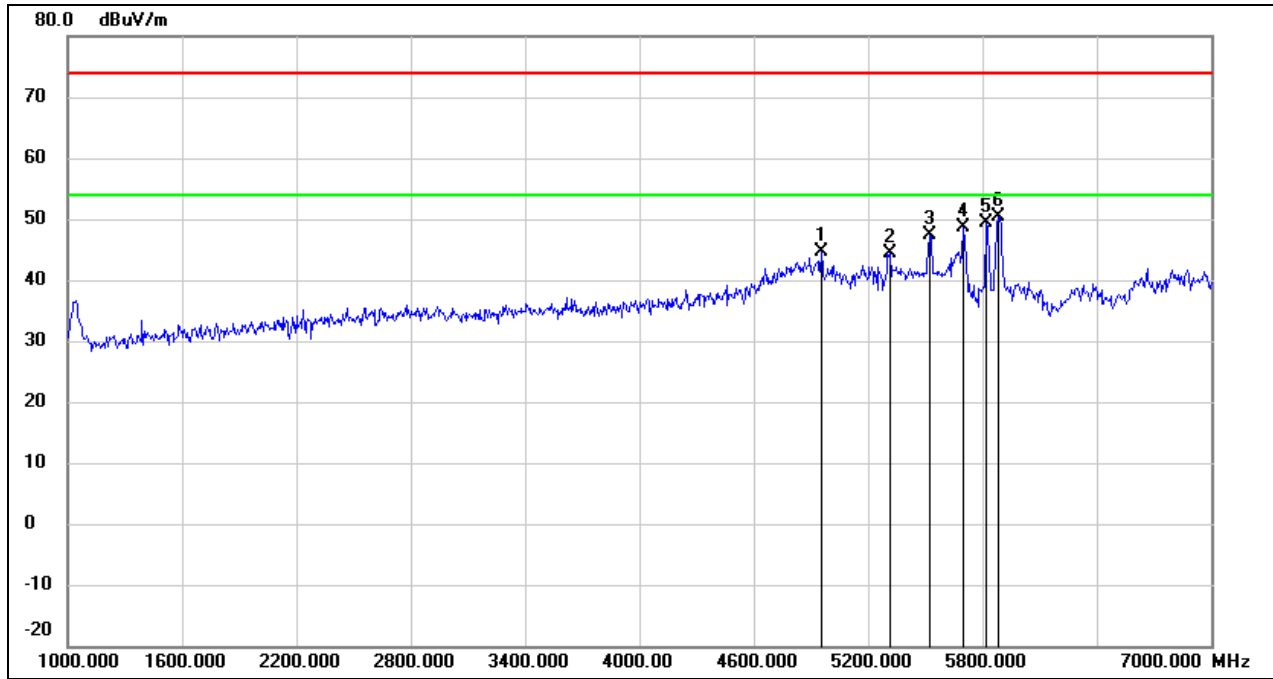

No.	Frequency (MHz)	Reading (dBuV)	Correct (dB/m)	Result (dBuV/m)	Limit (dBuV/m)	Margin (dB)	Remark
1	4954.000	44.86	-0.33	44.53	74.00	-29.47	peak
2	5314.000	44.28	0.21	44.49	74.00	-29.51	peak
3	5524.000	46.79	0.48	47.27	74.00	-26.73	peak
4	5698.000	47.54	0.99	48.53	74.00	-25.47	peak
5	5818.000	48.01	1.33	49.34	74.00	-24.66	peak
6	5884.000	48.88	1.52	50.40	74.00	-23.60	peak

**8.3. SPURIOUS EMISSIONS(7 GHZ~18 GHZ)**

Test Mode:	802.11a 20	Channel:	5180
Polarity:	Horizontal	Test Voltage:	DC 12 V

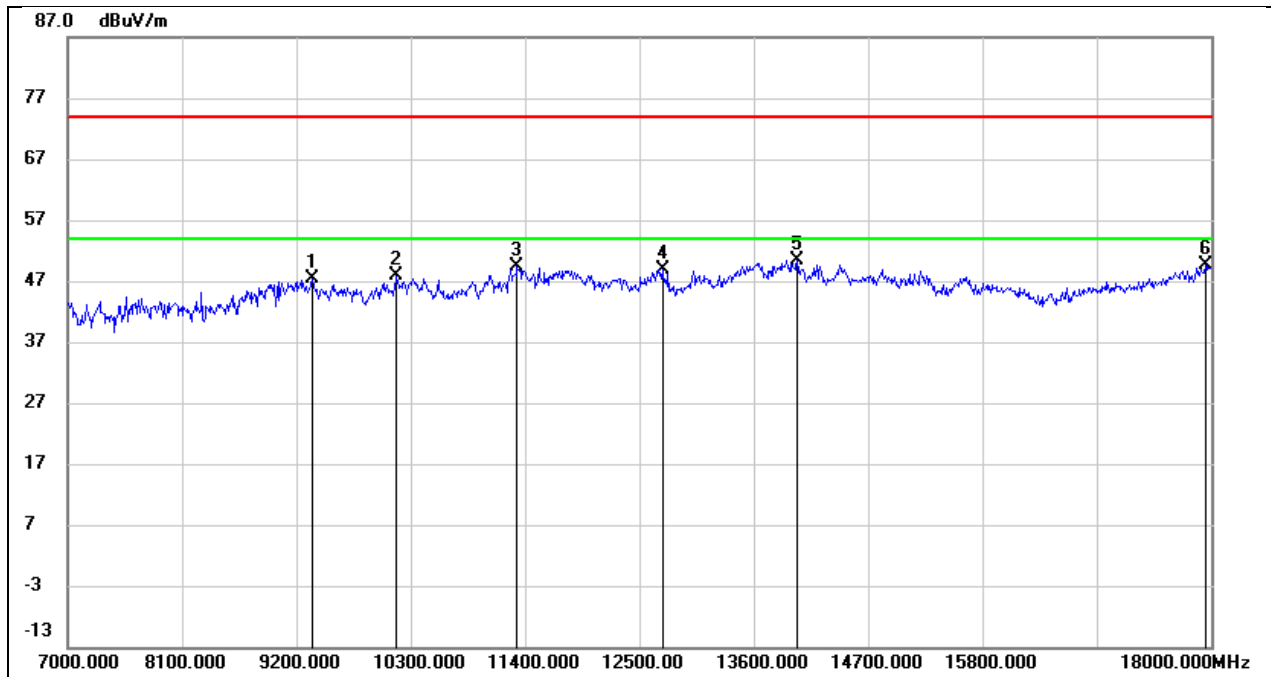

No.	Frequency (MHz)	Reading (dBuV)	Correct (dB/m)	Result (dBuV/m)	Limit (dBuV/m)	Margin (dB)	Remark
1	9354.000	36.73	10.56	47.29	74.00	-26.71	peak
2	10157.000	35.74	12.10	47.84	74.00	-26.16	peak
3	11323.000	33.25	16.05	49.30	74.00	-24.70	peak
4	12720.000	30.84	18.09	48.93	74.00	-25.07	peak
5	14018.000	28.67	21.80	50.47	74.00	-23.53	peak
6	17945.000	23.97	25.75	49.72	74.00	-24.28	peak





Test Mode:	802.11a 20	Channel:	5180
Polarity:	Vertical	Test Voltage:	DC 12 V

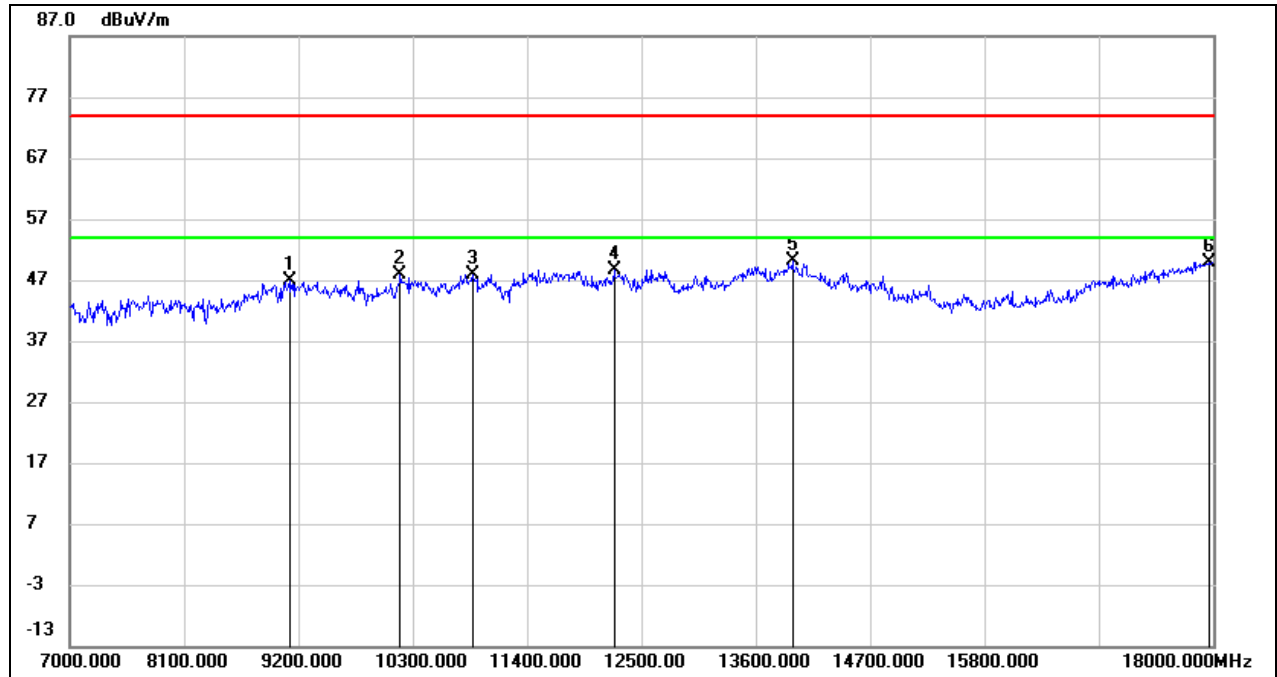

No.	Frequency (MHz)	Reading (dBuV)	Correct (dB/m)	Result (dBuV/m)	Limit (dBuV/m)	Margin (dB)	Remark
1	9112.000	36.49	10.41	46.90	74.00	-27.10	peak
2	10179.000	35.62	12.14	47.76	74.00	-26.24	peak
3	10872.000	33.74	14.23	47.97	74.00	-26.03	peak
4	12236.000	30.84	17.76	48.60	74.00	-25.40	peak
5	13952.000	28.46	21.76	50.22	74.00	-23.78	peak
6	17956.000	24.02	25.82	49.84	74.00	-24.16	peak



Test Mode:	802.11a 20	Channel:	5200
Polarity:	Horizontal	Test Voltage:	DC 12 V

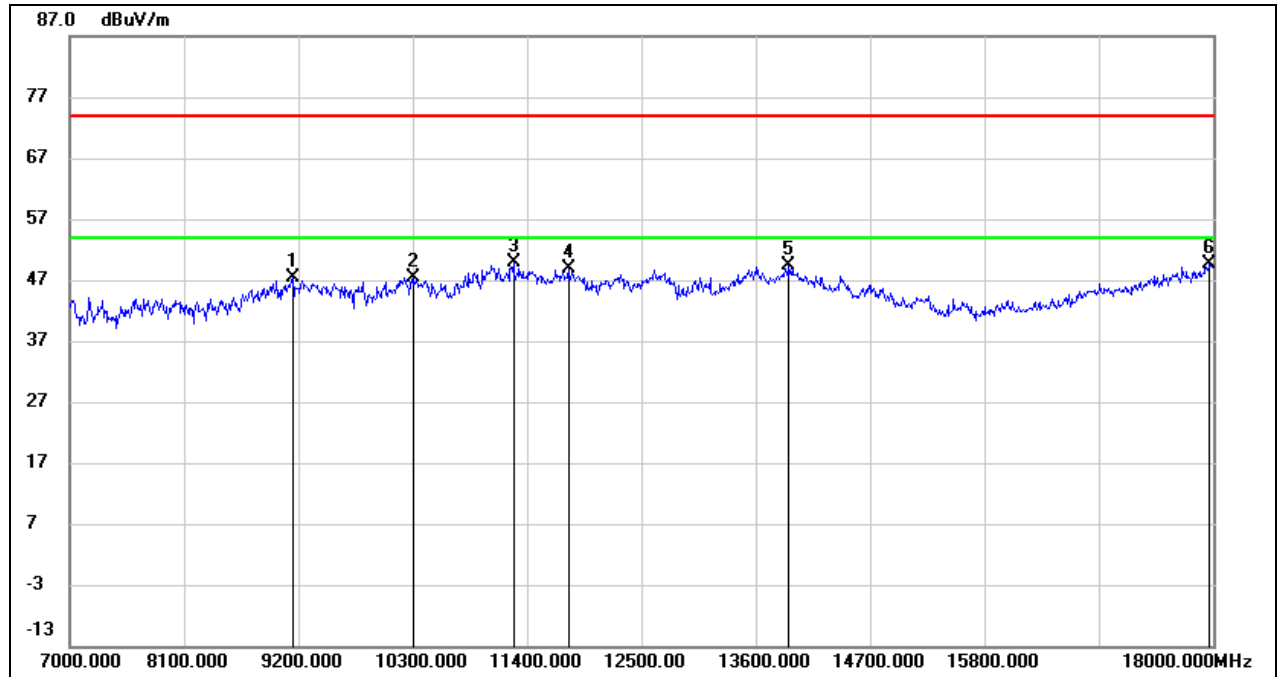

No.	Frequency (MHz)	Reading (dBuV)	Correct (dB/m)	Result (dBuV/m)	Limit (dBuV/m)	Margin (dB)	Remark
1	9145.000	37.01	10.43	47.44	74.00	-26.56	peak
2	10311.000	35.02	12.42	47.44	74.00	-26.56	peak
3	11268.000	34.07	15.83	49.90	74.00	-24.10	peak
4	11796.000	31.55	17.32	48.87	74.00	-25.13	peak
5	13919.000	27.66	21.68	49.34	74.00	-24.66	peak
6	17967.000	23.79	25.89	49.68	74.00	-24.32	peak



Test Mode:	802.11a 20	Channel:	5200
Polarity:	Vertical	Test Voltage:	DC 12 V

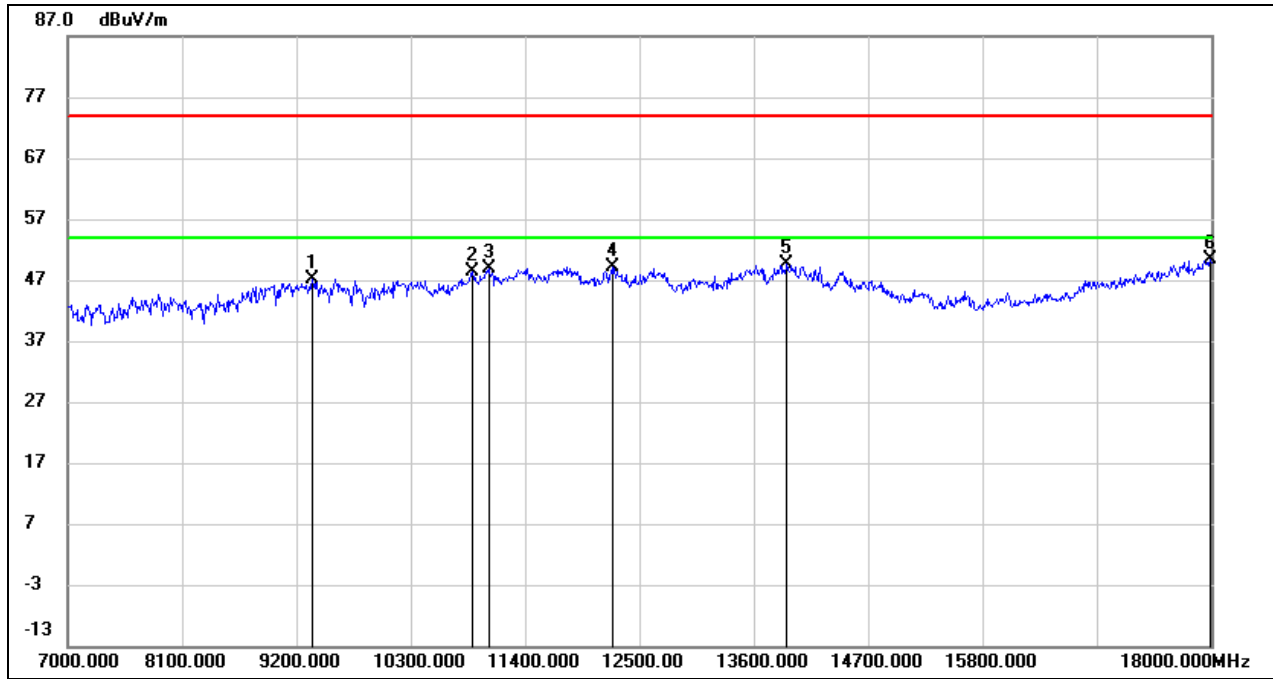

No.	Frequency (MHz)	Reading (dBuV)	Correct (dB/m)	Result (dBuV/m)	Limit (dBuV/m)	Margin (dB)	Remark
1	9354.000	36.65	10.56	47.21	74.00	-26.79	peak
2	10894.000	33.96	14.32	48.28	74.00	-25.72	peak
3	11048.000	33.99	14.91	48.90	74.00	-25.10	peak
4	12247.000	31.24	17.77	49.01	74.00	-24.99	peak
5	13919.000	27.85	21.68	49.53	74.00	-24.47	peak
6	17989.000	24.35	26.04	50.39	74.00	-23.61	peak



Test Mode:	802.11a 20	Channel:	5240
Polarity:	Horizontal	Test Voltage:	DC 12 V

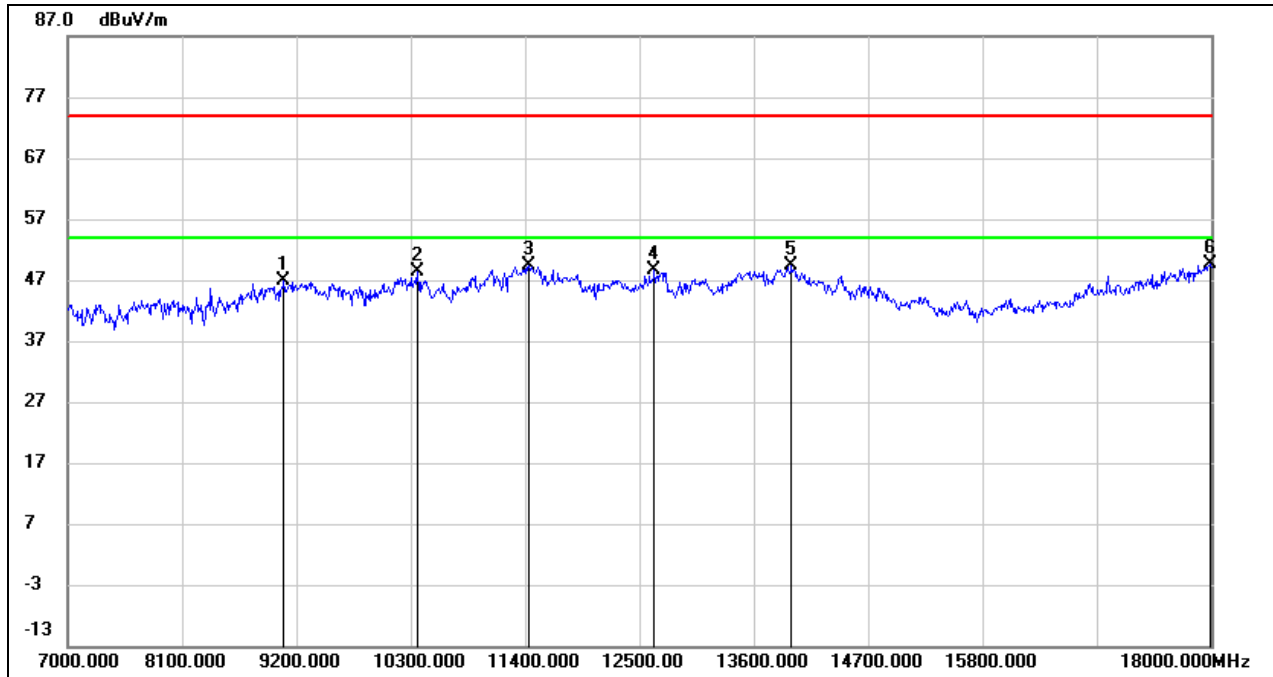

No.	Frequency (MHz)	Reading (dBuV)	Correct (dB/m)	Result (dBuV/m)	Limit (dBuV/m)	Margin (dB)	Remark
1	9079.000	36.46	10.39	46.85	74.00	-27.15	peak
2	10366.000	35.83	12.54	48.37	74.00	-25.63	peak
3	11433.000	32.91	16.50	49.41	74.00	-24.59	peak
4	12643.000	30.68	18.01	48.69	74.00	-25.31	peak
5	13963.000	27.65	21.78	49.43	74.00	-24.57	peak
6	17989.000	23.59	26.04	49.63	74.00	-24.37	peak



Test Mode:	802.11a 20	Channel:	5240
Polarity:	Vertical	Test Voltage:	DC 12 V

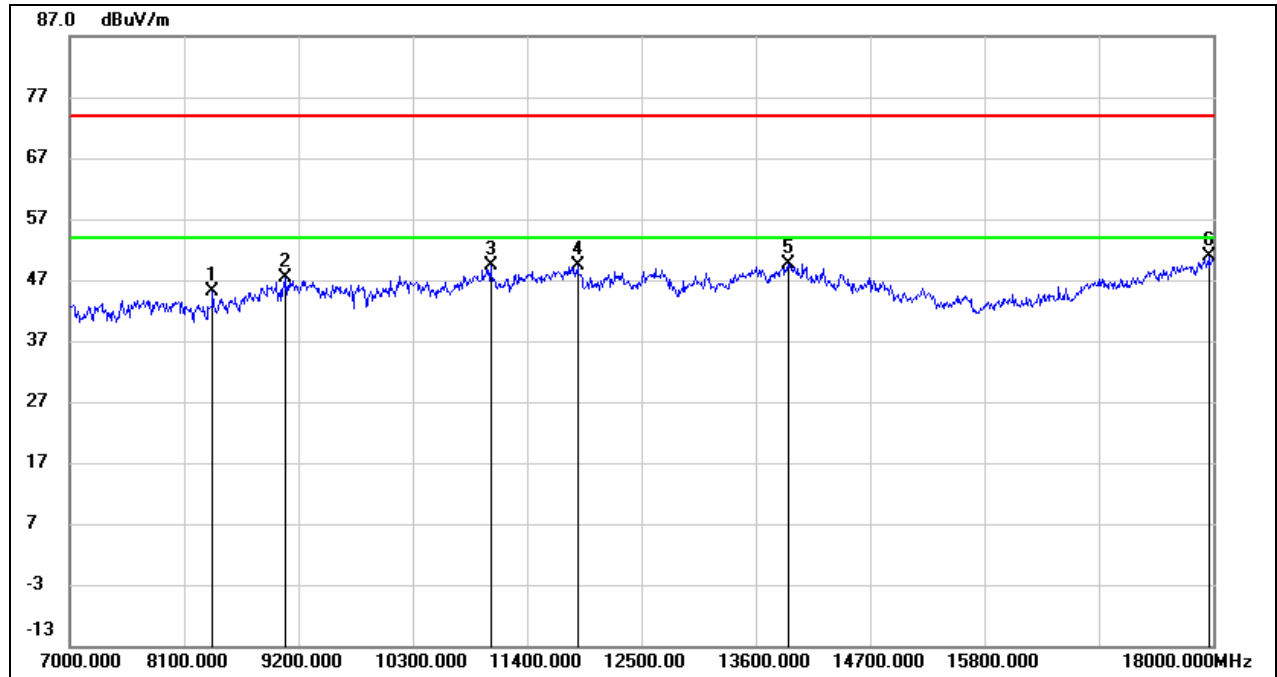

No.	Frequency (MHz)	Reading (dBuV)	Correct (dB/m)	Result (dBuV/m)	Limit (dBuV/m)	Margin (dB)	Remark
1	8375.000	38.37	6.77	45.14	74.00	-28.86	peak
2	9079.000	36.96	10.39	47.35	74.00	-26.65	peak
3	11048.000	34.53	14.91	49.44	74.00	-24.56	peak
4	11884.000	31.92	17.48	49.40	74.00	-24.60	peak
5	13908.000	28.04	21.66	49.70	74.00	-24.30	peak
6	17956.000	25.00	25.82	50.82	74.00	-23.18	peak



Test Mode:	802.11a 20	Channel:	5745
Polarity:	Horizontal	Test Voltage:	DC 12 V

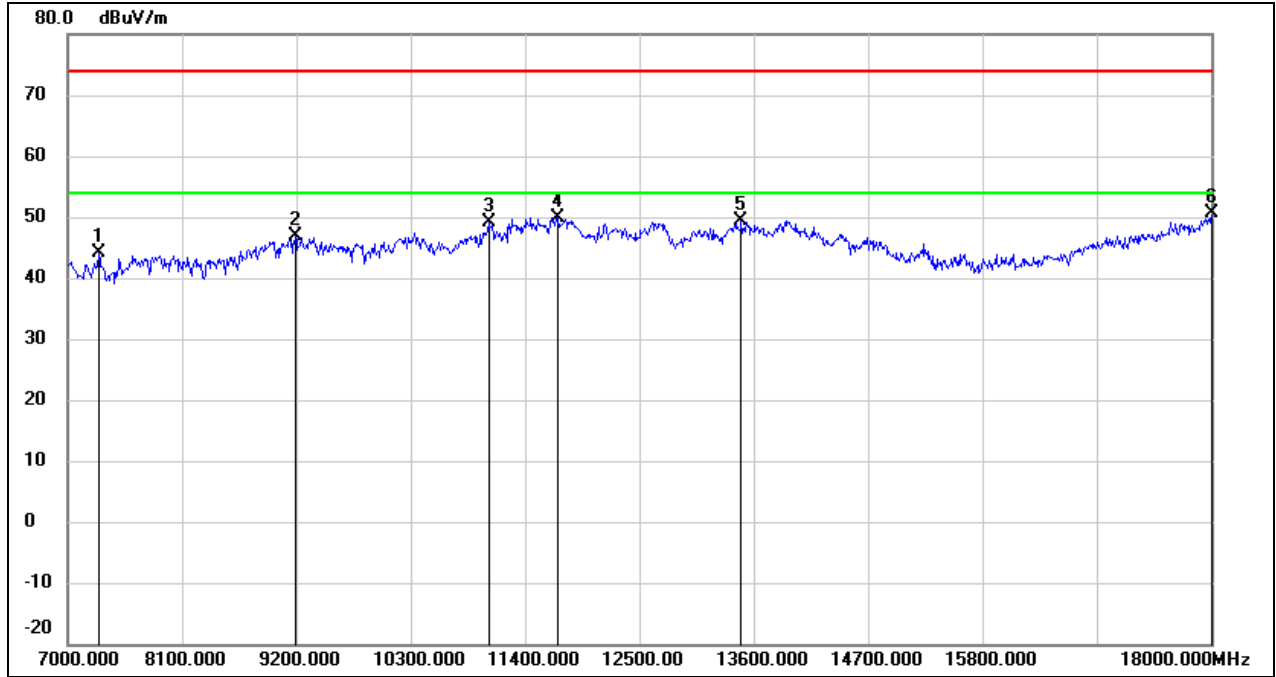

No.	Frequency (MHz)	Reading (dBuV)	Correct (dB/m)	Result (dBuV/m)	Limit (dBuV/m)	Margin (dB)	Remark
1	7297.000	37.27	6.95	44.22	74.00	-29.78	peak
2	9189.000	36.36	10.46	46.82	74.00	-27.18	peak
3	11048.000	34.10	14.91	49.01	74.00	-24.99	peak
4	11719.000	32.80	17.18	49.98	74.00	-24.02	peak
5	13479.000	28.93	20.55	49.48	74.00	-24.52	peak
6	18000.000	24.50	26.12	50.62	74.00	-23.38	peak



Test Mode:	802.11a 20	Channel:	5745
Polarity:	Vertical	Test Voltage:	DC 12 V

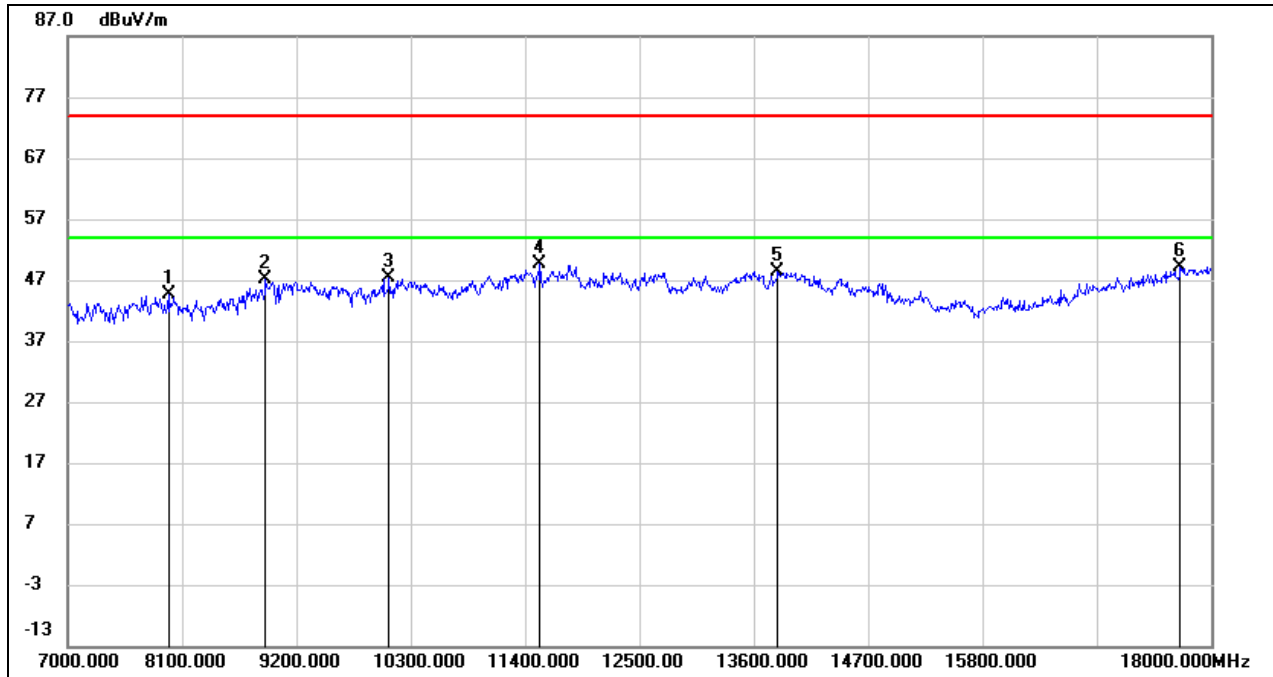

No.	Frequency (MHz)	Reading (dBuV)	Correct (dB/m)	Result (dBuV/m)	Limit (dBuV/m)	Margin (dB)	Remark
1	7968.000	38.07	6.45	44.52	74.00	-29.48	peak
2	8903.000	37.41	9.66	47.07	74.00	-26.93	peak
3	10091.000	35.42	11.97	47.39	74.00	-26.61	peak
4	11543.000	32.76	16.84	49.60	74.00	-24.40	peak
5	13831.000	27.02	21.47	48.49	74.00	-25.51	peak
6	17703.000	25.03	24.09	49.12	74.00	-24.88	peak



Test Mode:	802.11a 20	Channel:	5785
Polarity:	Horizontal	Test Voltage:	DC 12 V

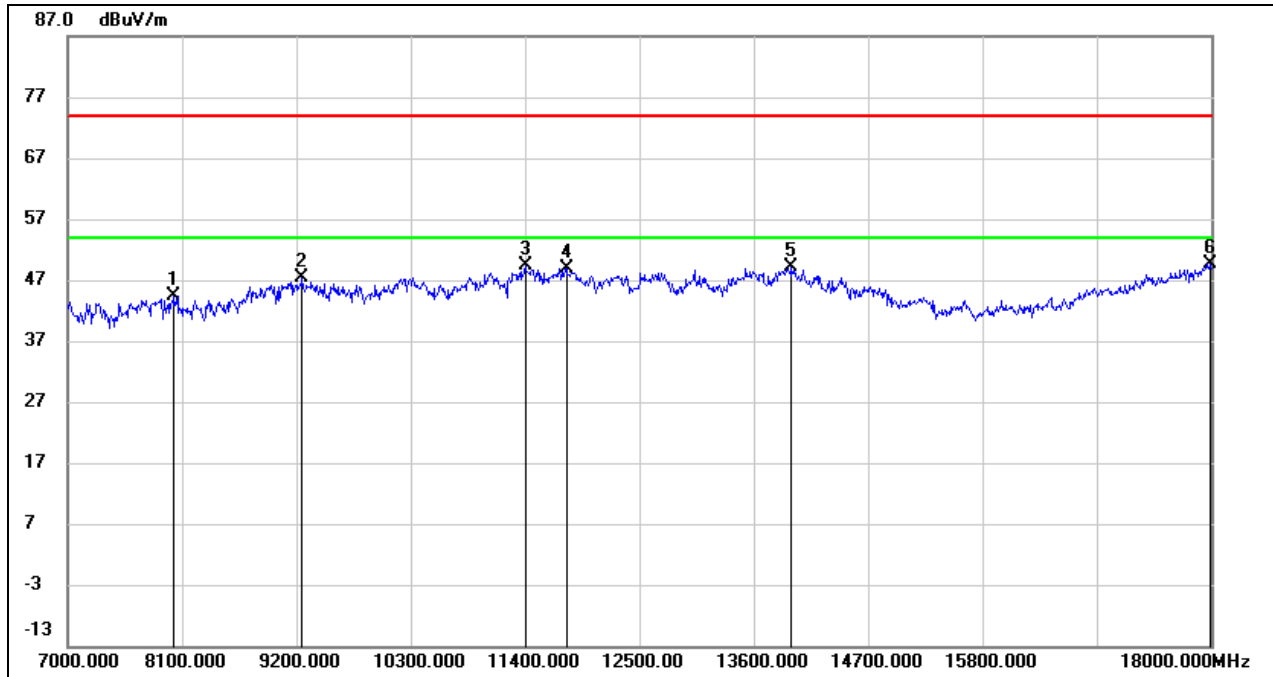

No.	Frequency (MHz)	Reading (dBuV)	Correct (dB/m)	Result (dBuV/m)	Limit (dBuV/m)	Margin (dB)	Remark
1	8023.000	37.87	6.45	44.32	74.00	-29.68	peak
2	9255.000	36.91	10.51	47.42	74.00	-26.58	peak
3	11400.000	32.94	16.36	49.30	74.00	-24.70	peak
4	11796.000	31.62	17.32	48.94	74.00	-25.06	peak
5	13963.000	27.43	21.78	49.21	74.00	-24.79	peak
6	17989.000	23.52	26.04	49.56	74.00	-24.44	peak





Test Mode:	802.11a 20	Channel:	5785
Polarity:	Vertical	Test Voltage:	DC 12 V

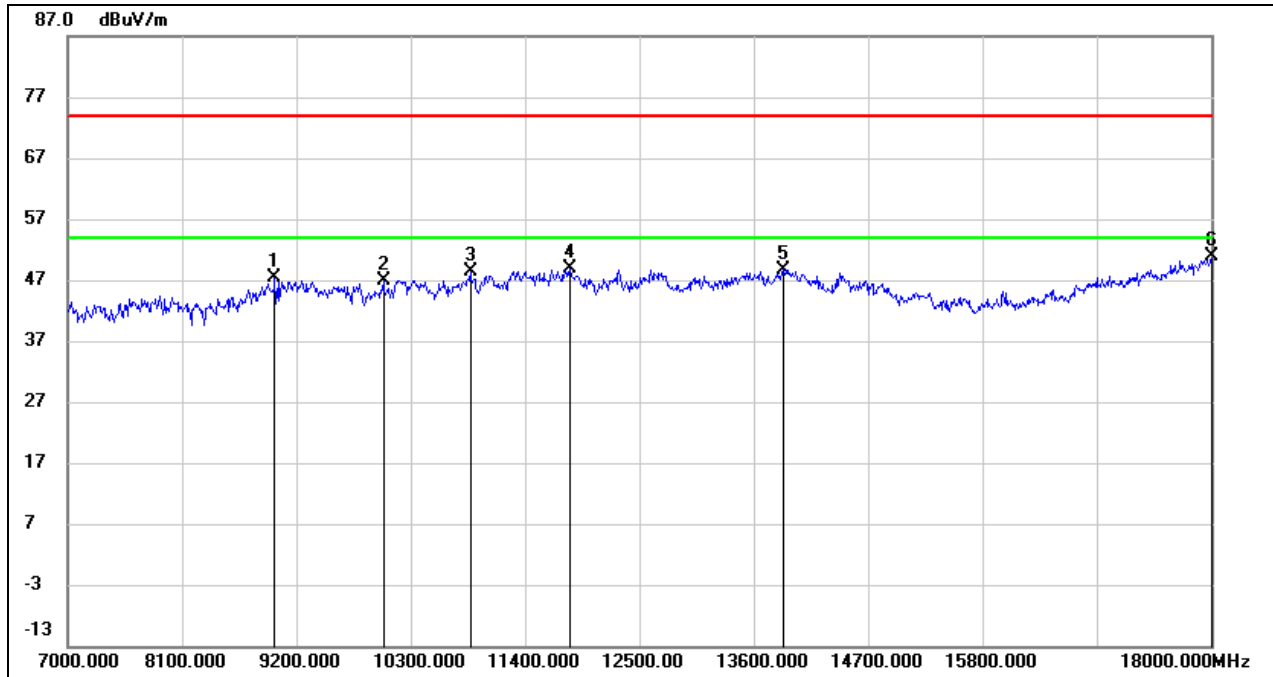

No.	Frequency (MHz)	Reading (dBuV)	Correct (dB/m)	Result (dBuV/m)	Limit (dBuV/m)	Margin (dB)	Remark
1	8991.000	37.12	10.28	47.40	74.00	-26.60	peak
2	10036.000	35.12	11.84	46.96	74.00	-27.04	peak
3	10872.000	34.15	14.23	48.38	74.00	-25.62	peak
4	11829.000	31.50	17.38	48.88	74.00	-25.12	peak
5	13886.000	27.15	21.60	48.75	74.00	-25.25	peak
6	18000.000	24.69	26.12	50.81	74.00	-23.19	peak



Test Mode:	802.11a 20	Channel:	5825
Polarity:	Horizontal	Test Voltage:	DC 12 V

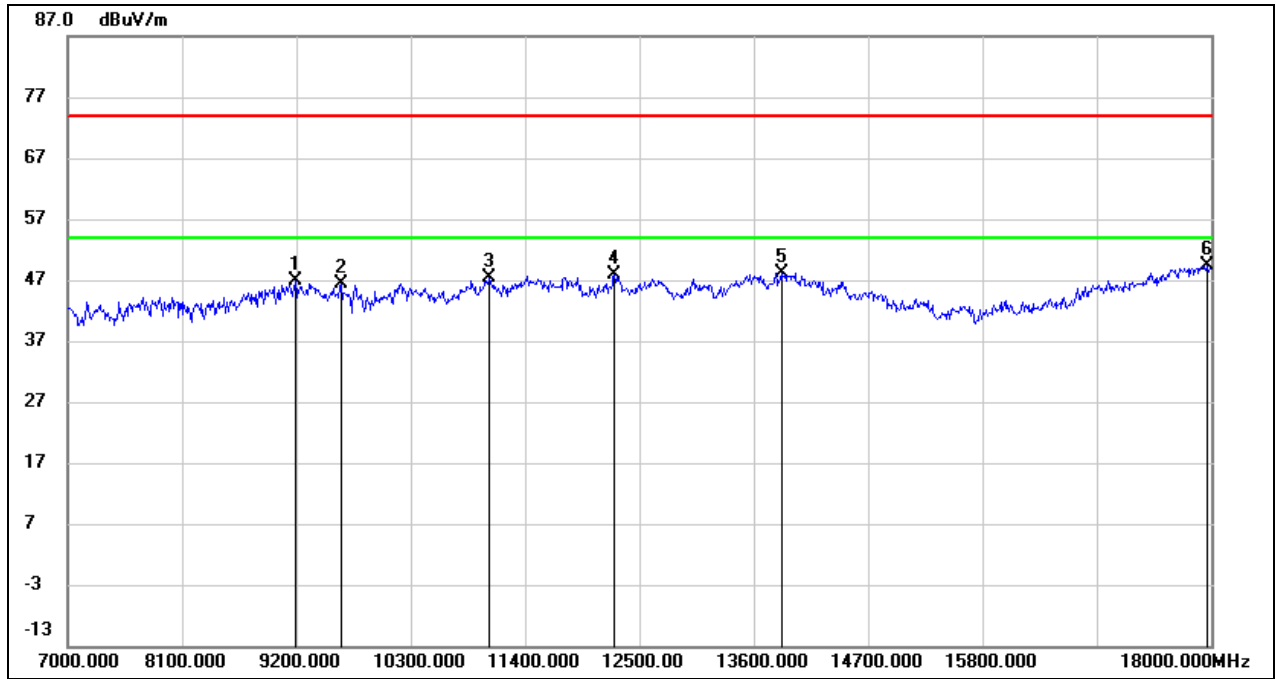

No.	Frequency (MHz)	Reading (dBuV)	Correct (dB/m)	Result (dBuV/m)	Limit (dBuV/m)	Margin (dB)	Remark
1	9189.000	36.35	10.46	46.81	74.00	-27.19	peak
2	9629.000	35.42	10.94	46.36	74.00	-27.64	peak
3	11059.000	32.32	14.96	47.28	74.00	-26.72	peak
4	12258.000	30.14	17.77	47.91	74.00	-26.09	peak
5	13864.000	26.67	21.53	48.20	74.00	-25.80	peak
6	17956.000	23.49	25.82	49.31	74.00	-24.69	peak



Test Mode:	802.11a 20	Channel:	5825
Polarity:	Vertical	Test Voltage:	DC 12 V

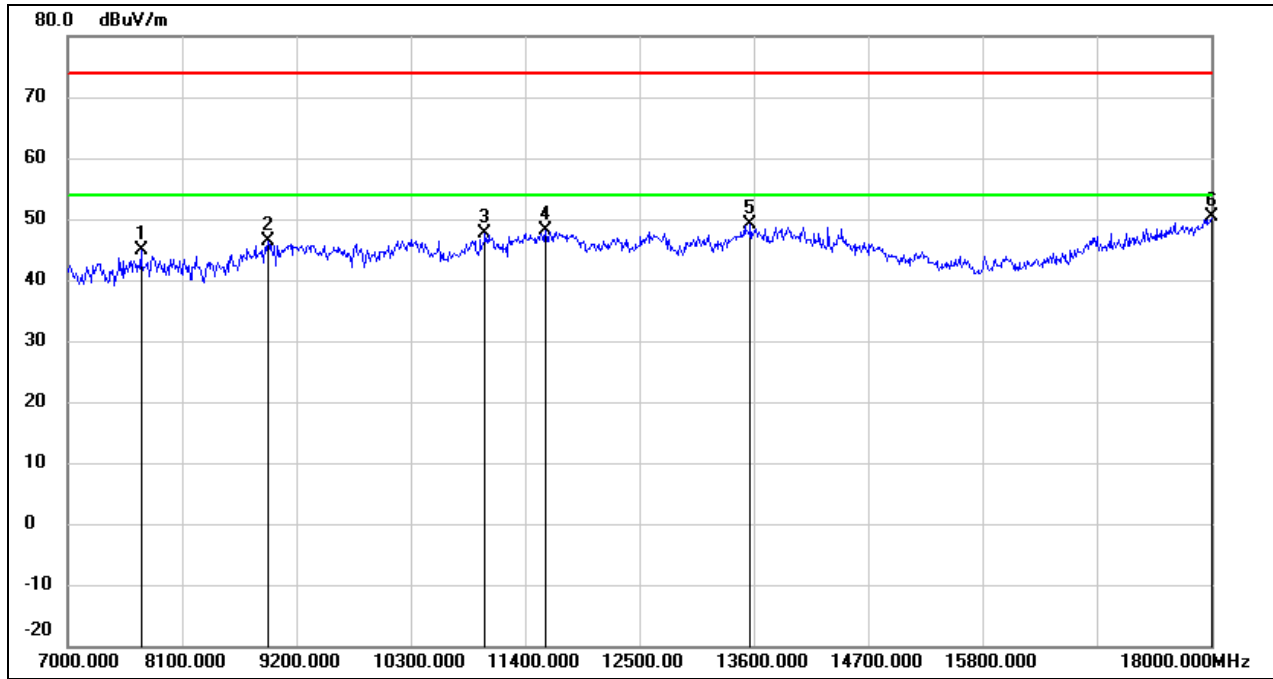

No.	Frequency (MHz)	Reading (dBuV)	Correct (dB/m)	Result (dBuV/m)	Limit (dBuV/m)	Margin (dB)	Remark
1	7704.000	38.27	6.69	44.96	74.00	-29.04	peak
2	8925.000	36.53	9.82	46.35	74.00	-27.65	peak
3	11015.000	32.92	14.79	47.71	74.00	-26.29	peak
4	11598.000	31.09	16.96	48.05	74.00	-25.95	peak
5	13567.000	28.27	20.80	49.07	74.00	-24.93	peak
6	18000.000	24.18	26.12	50.30	74.00	-23.70	peak



Test Mode:	802.11ax HE20	Channel:	5180
Polarity:	Horizontal	Test Voltage:	DC 12 V

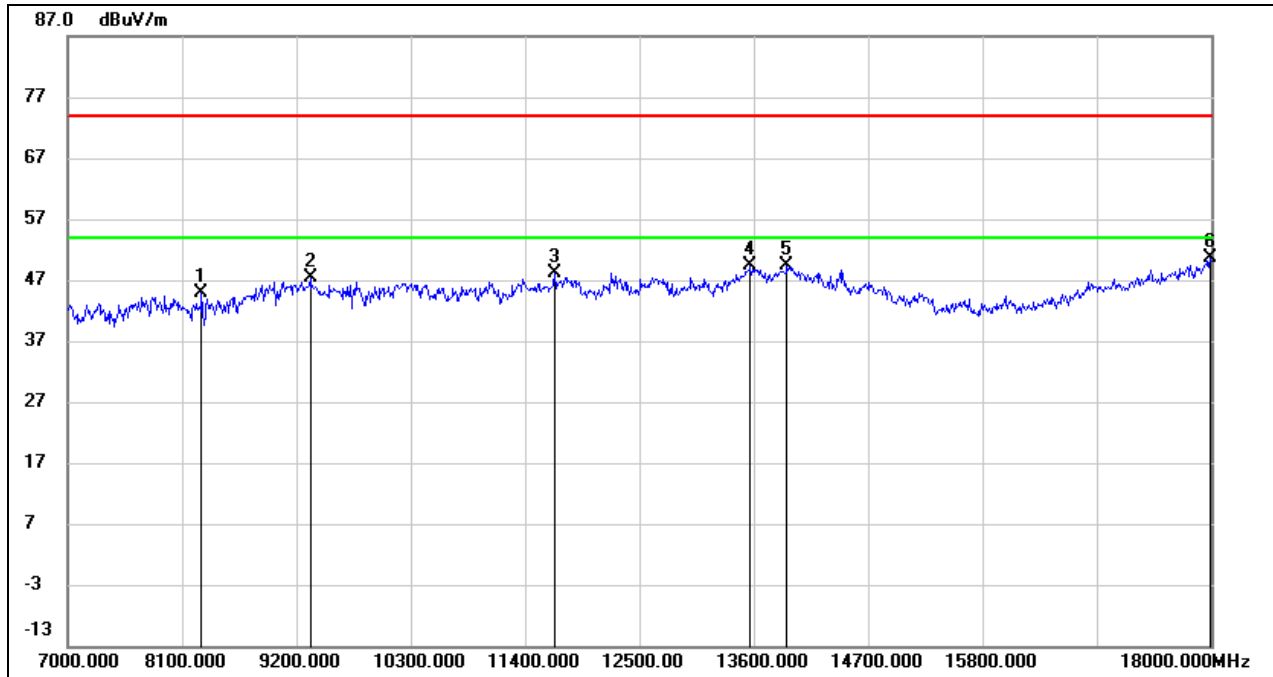

No.	Frequency (MHz)	Reading (dBuV)	Correct (dB/m)	Result (dBuV/m)	Limit (dBuV/m)	Margin (dB)	Remark
1	8287.000	38.20	6.70	44.90	74.00	-29.10	peak
2	9332.000	36.77	10.54	47.31	74.00	-26.69	peak
3	11686.000	30.93	17.12	48.05	74.00	-25.95	peak
4	13567.000	28.49	20.80	49.29	74.00	-24.71	peak
5	13919.000	27.69	21.68	49.37	74.00	-24.63	peak
6	17989.000	24.64	26.04	50.68	74.00	-23.32	peak



Test Mode:	802.11ax HE20	Channel:	5180
Polarity:	Vertical	Test Voltage:	DC 12 V

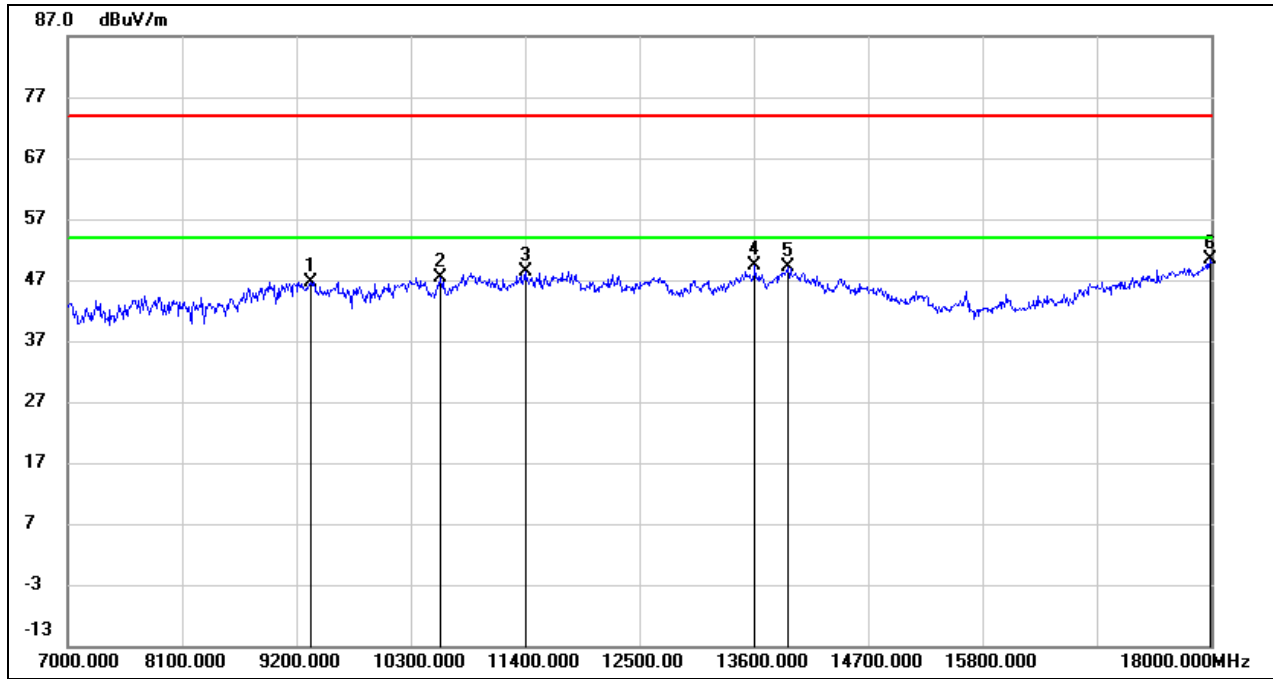

No.	Frequency (MHz)	Reading (dBuV)	Correct (dB/m)	Result (dBuV/m)	Limit (dBuV/m)	Margin (dB)	Remark
1	9332.000	36.20	10.54	46.74	74.00	-27.26	peak
2	10586.000	34.26	13.15	47.41	74.00	-26.59	peak
3	11400.000	32.12	16.36	48.48	74.00	-25.52	peak
4	13611.000	28.35	20.92	49.27	74.00	-24.73	peak
5	13930.000	27.44	21.71	49.15	74.00	-24.85	peak
6	17989.000	24.22	26.04	50.26	74.00	-23.74	peak



Test Mode:	802.11ax HE20	Channel:	5200
Polarity:	Horizontal	Test Voltage:	DC 12 V

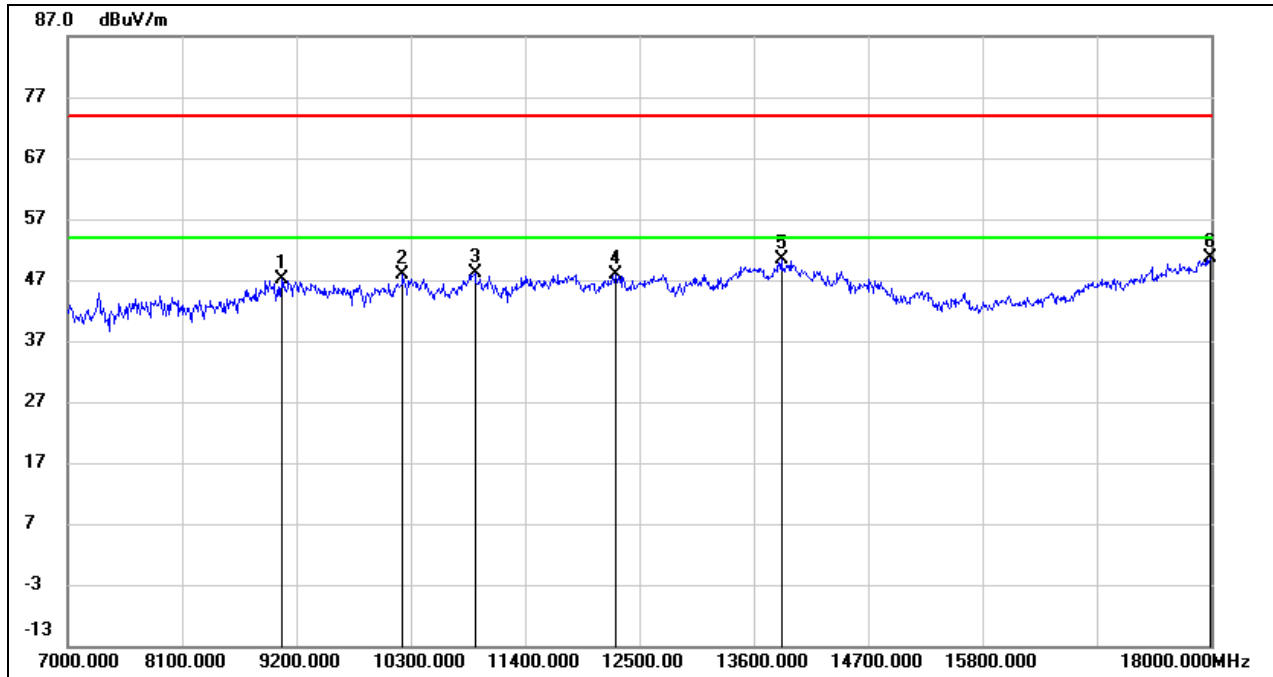

No.	Frequency (MHz)	Reading (dBuV)	Correct (dB/m)	Result (dBuV/m)	Limit (dBuV/m)	Margin (dB)	Remark
1	9057.000	36.85	10.38	47.23	74.00	-26.77	peak
2	10223.000	35.66	12.24	47.90	74.00	-26.10	peak
3	10916.000	33.67	14.39	48.06	74.00	-25.94	peak
4	12269.000	30.17	17.77	47.94	74.00	-26.06	peak
5	13864.000	28.78	21.53	50.31	74.00	-23.69	peak
6	17989.000	24.62	26.04	50.66	74.00	-23.34	peak



Test Mode:	802.11ax HE20	Channel:	5200
Polarity:	Vertical	Test Voltage:	DC 12 V

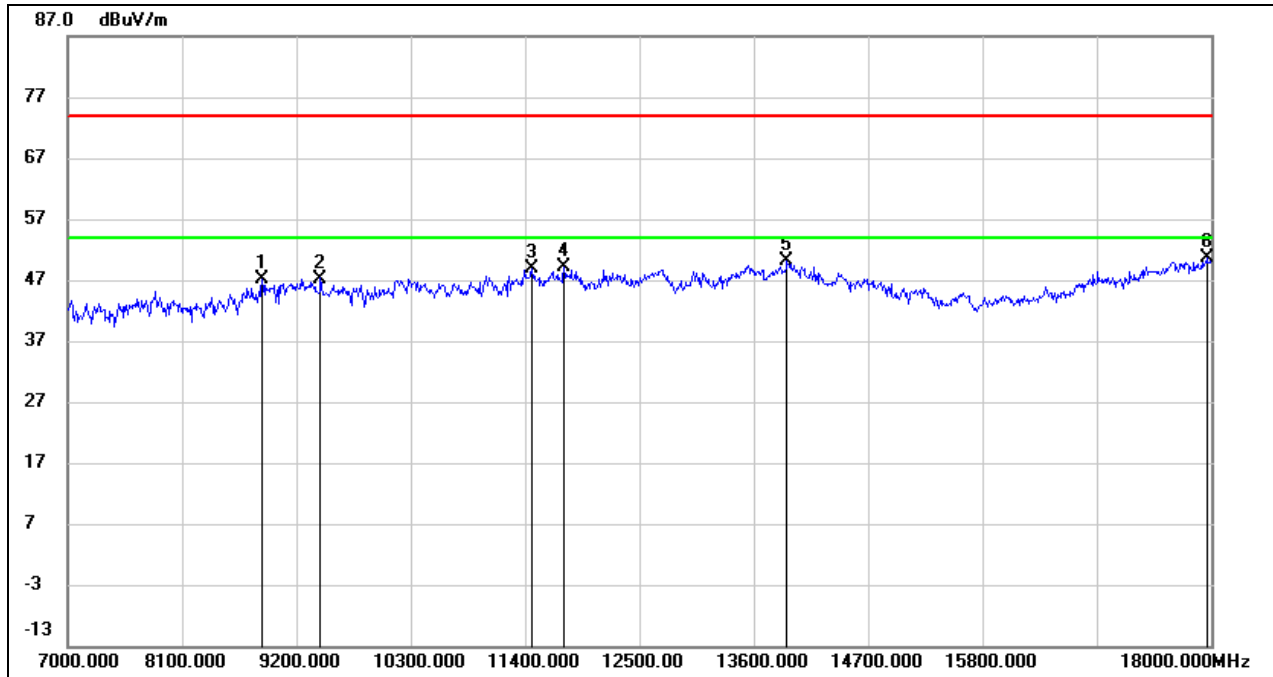

No.	Frequency (MHz)	Reading (dBuV)	Correct (dB/m)	Result (dBuV/m)	Limit (dBuV/m)	Margin (dB)	Remark
1	8870.000	37.69	9.44	47.13	74.00	-26.87	peak
2	9431.000	36.64	10.61	47.25	74.00	-26.75	peak
3	11466.000	32.21	16.63	48.84	74.00	-25.16	peak
4	11774.000	31.74	17.28	49.02	74.00	-24.98	peak
5	13919.000	28.39	21.68	50.07	74.00	-23.93	peak
6	17956.000	24.87	25.82	50.69	74.00	-23.31	peak



Test Mode:	802.11ax HE20	Channel:	5240
Polarity:	Horizontal	Test Voltage:	DC 12 V

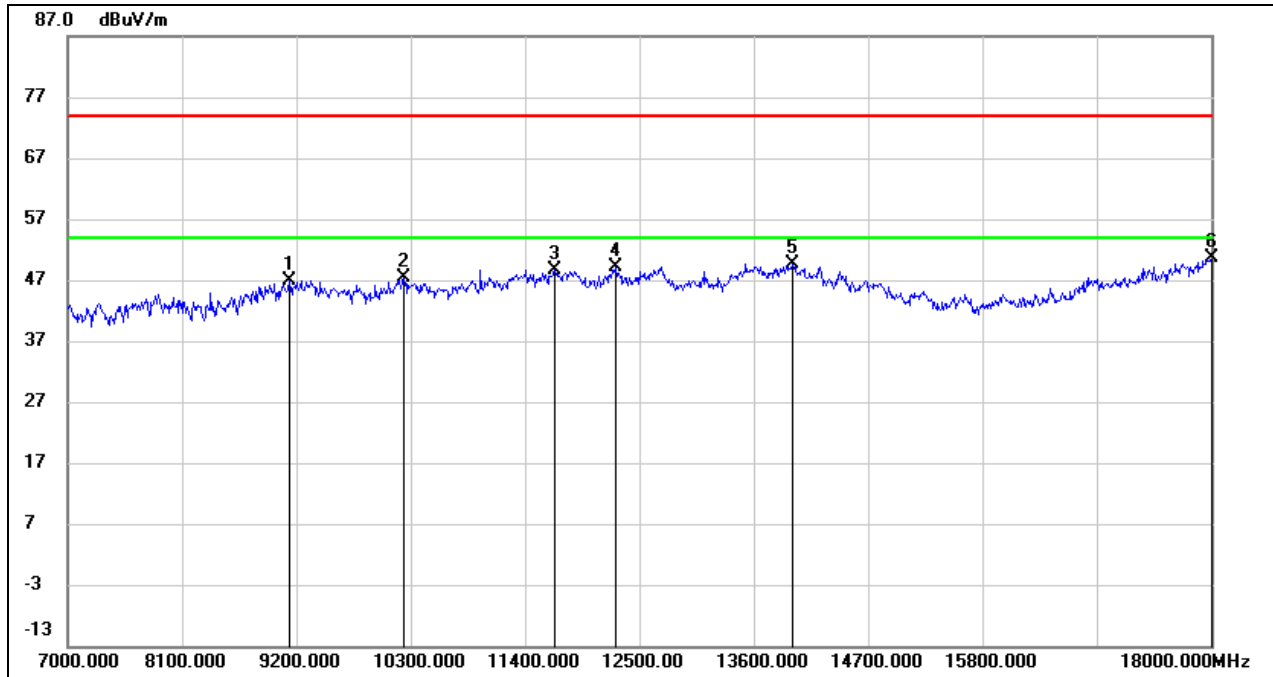

No.	Frequency (MHz)	Reading (dBuV)	Correct (dB/m)	Result (dBuV/m)	Limit (dBuV/m)	Margin (dB)	Remark
1	9134.000	36.43	10.41	46.84	74.00	-27.16	peak
2	10234.000	35.14	12.26	47.40	74.00	-26.60	peak
3	11686.000	31.60	17.12	48.72	74.00	-25.28	peak
4	12269.000	31.44	17.77	49.21	74.00	-24.79	peak
5	13974.000	27.84	21.82	49.66	74.00	-24.34	peak
6	18000.000	24.42	26.12	50.54	74.00	-23.46	peak





Test Mode:	802.11ax HE20	Channel:	5240
Polarity:	Vertical	Test Voltage:	DC 12 V

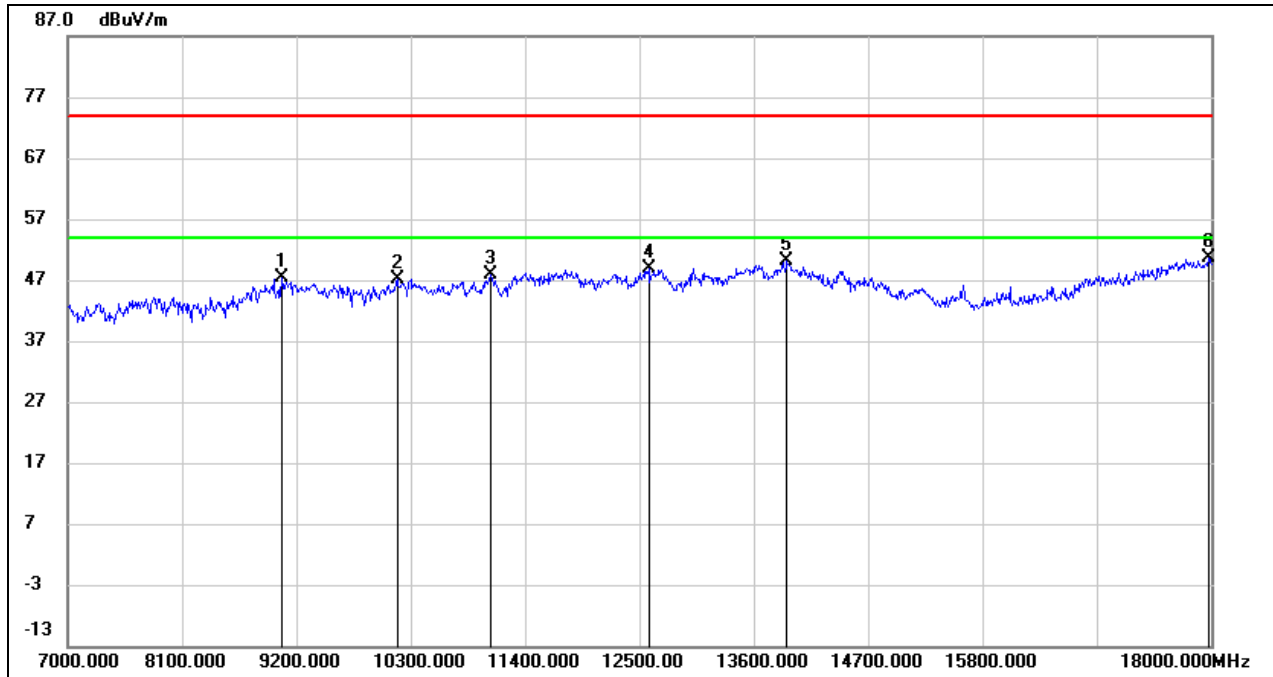

No.	Frequency (MHz)	Reading (dBuV)	Correct (dB/m)	Result (dBuV/m)	Limit (dBuV/m)	Margin (dB)	Remark
1	9057.000	36.94	10.38	47.32	74.00	-26.68	peak
2	10168.000	35.10	12.13	47.23	74.00	-26.77	peak
3	11070.000	32.75	15.01	47.76	74.00	-26.24	peak
4	12588.000	30.86	17.94	48.80	74.00	-25.20	peak
5	13919.000	28.54	21.68	50.22	74.00	-23.78	peak
6	17978.000	24.57	25.97	50.54	74.00	-23.46	peak



Test Mode:	802.11ax HE20	Channel:	5745
Polarity:	Horizontal	Test Voltage:	DC 12 V

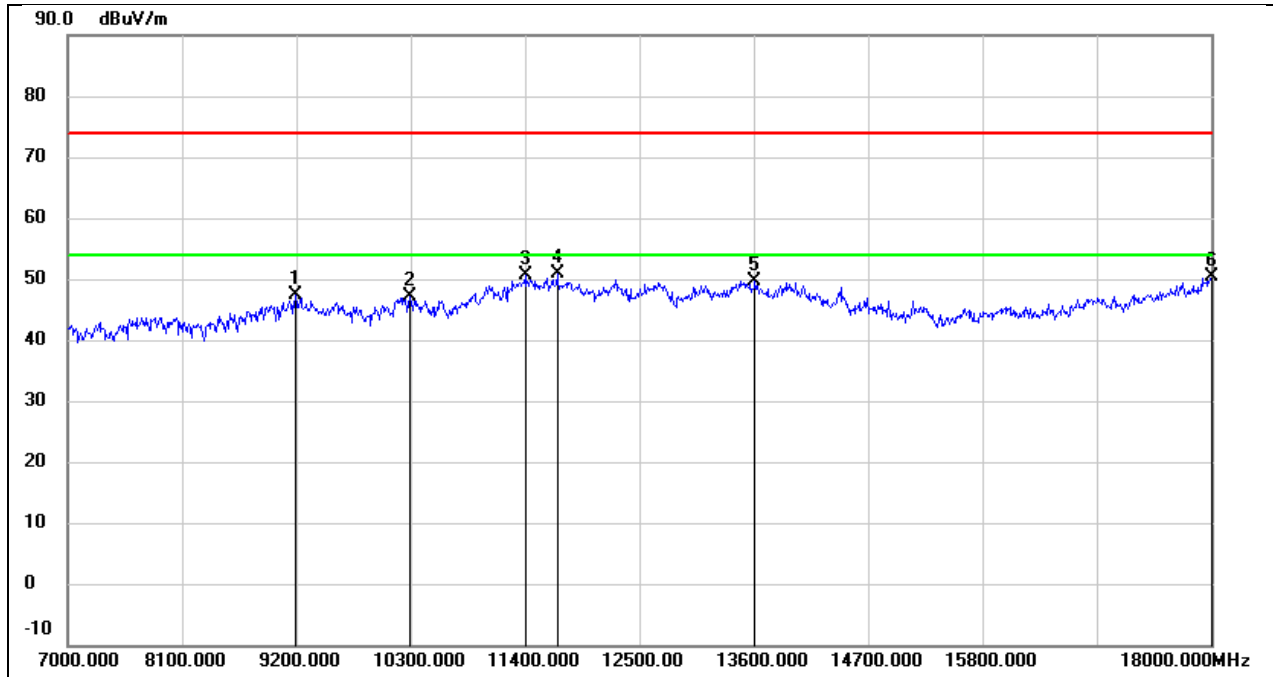

No.	Frequency (MHz)	Reading (dBuV)	Correct (dB/m)	Result (dBuV/m)	Limit (dBuV/m)	Margin (dB)	Remark
1	9189.000	36.84	10.46	47.30	74.00	-26.70	peak
2	10289.000	34.86	12.38	47.24	74.00	-26.76	peak
3	11400.000	34.30	16.36	50.66	74.00	-23.34	peak
4	11708.000	33.71	17.16	50.87	74.00	-23.13	peak
5	13611.000	28.65	20.92	49.57	74.00	-24.43	peak
6	18000.000	24.22	26.12	50.34	74.00	-23.66	peak



Test Mode:	802.11ax HE20	Channel:	5745
Polarity:	Vertical	Test Voltage:	DC 12 V

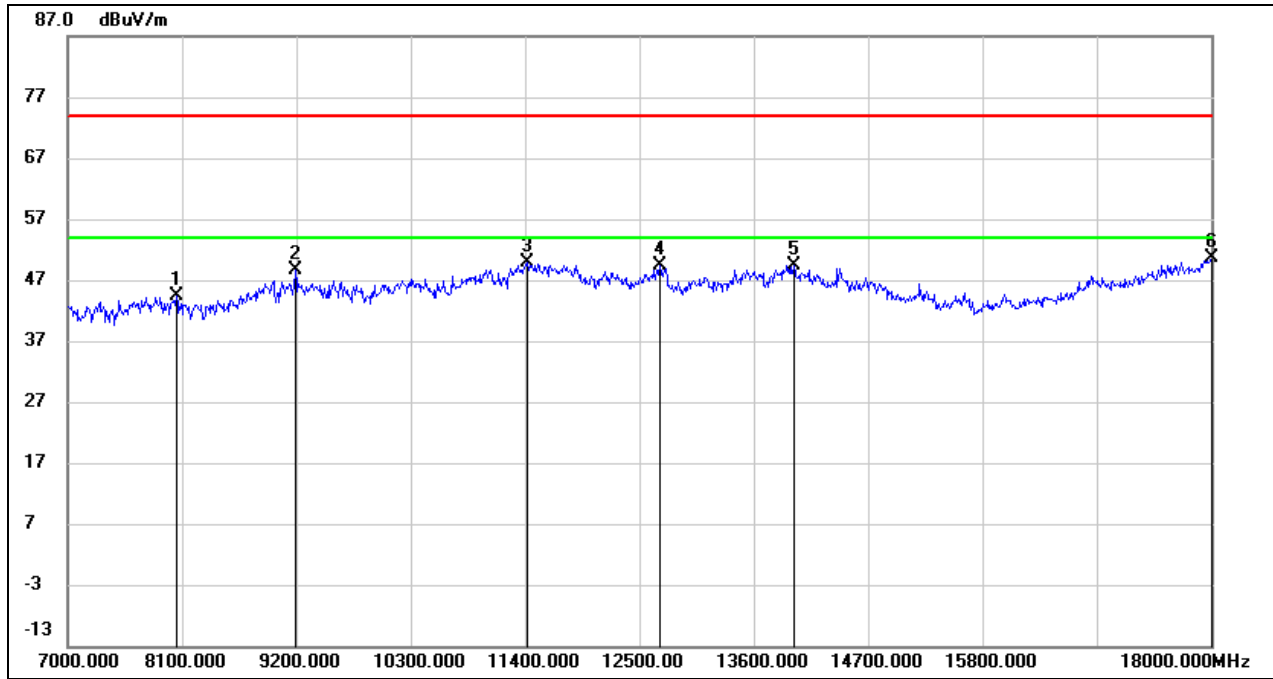

No.	Frequency (MHz)	Reading (dBuV)	Correct (dB/m)	Result (dBuV/m)	Limit (dBuV/m)	Margin (dB)	Remark
1	8045.000	37.83	6.47	44.30	74.00	-29.70	peak
2	9189.000	38.16	10.46	48.62	74.00	-25.38	peak
3	11422.000	33.31	16.46	49.77	74.00	-24.23	peak
4	12698.000	31.28	18.08	49.36	74.00	-24.64	peak
5	13985.000	27.47	21.85	49.32	74.00	-24.68	peak
6	18000.000	24.53	26.12	50.65	74.00	-23.35	peak



Test Mode:	802.11ax HE20	Channel:	5785
Polarity:	Horizontal	Test Voltage:	DC 12 V

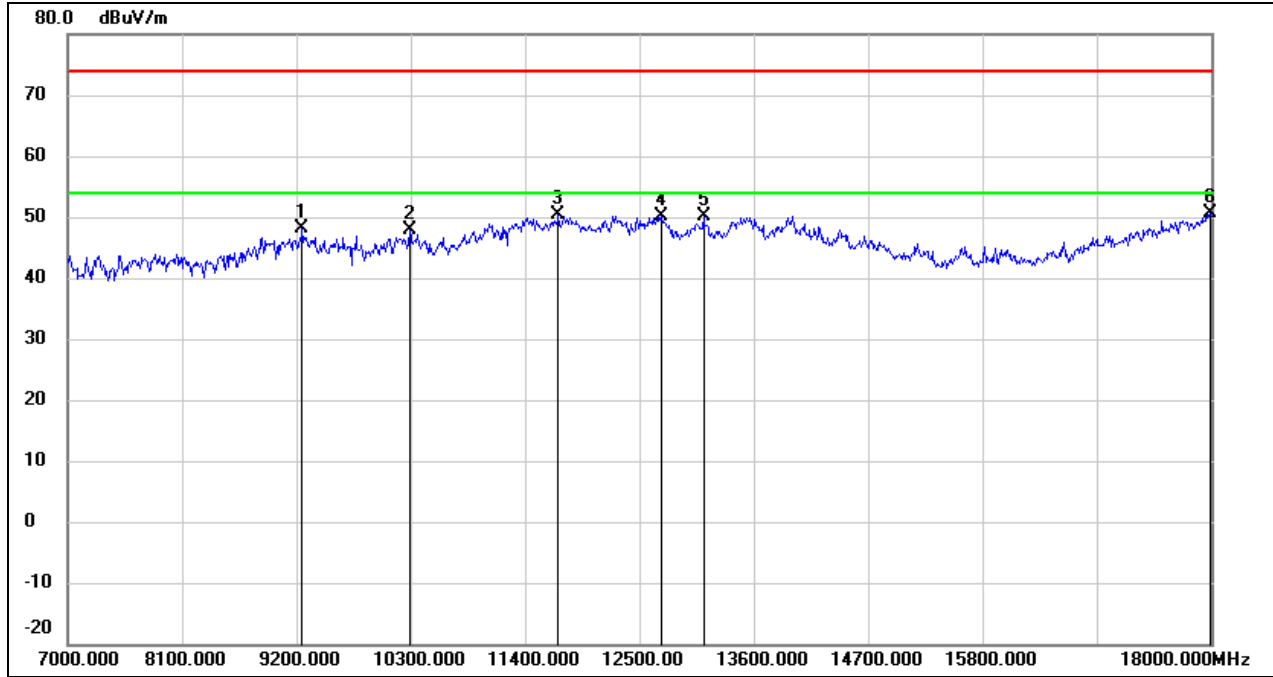

No.	Frequency (MHz)	Reading (dBuV)	Correct (dB/m)	Result (dBuV/m)	Limit (dBuV/m)	Margin (dB)	Remark
1	9255.000	37.57	10.51	48.08	74.00	-25.92	peak
2	10289.000	35.62	12.38	48.00	74.00	-26.00	peak
3	11719.000	33.11	17.18	50.29	74.00	-23.71	peak
4	12709.000	32.16	18.09	50.25	74.00	-23.75	peak
5	13116.000	31.26	18.96	50.22	74.00	-23.78	peak
6	17989.000	24.55	26.04	50.59	74.00	-23.41	peak



Test Mode:	802.11ax HE20	Channel:	5785
Polarity:	Vertical	Test Voltage:	DC 12 V

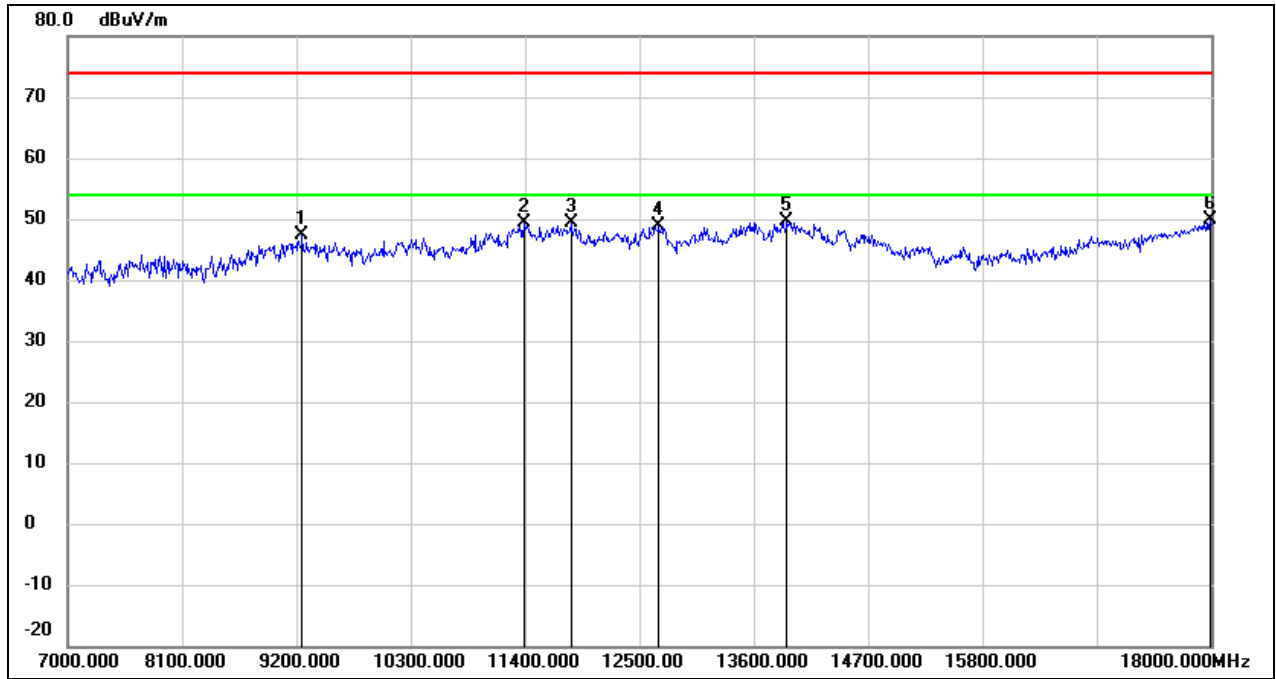

No.	Frequency (MHz)	Reading (dBuV)	Correct (dB/m)	Result (dBuV/m)	Limit (dBuV/m)	Margin (dB)	Remark
1	9255.000	36.88	10.51	47.39	74.00	-26.61	peak
2	11389.000	32.95	16.31	49.26	74.00	-24.74	peak
3	11840.000	31.91	17.40	49.31	74.00	-24.69	peak
4	12687.000	30.75	18.05	48.80	74.00	-25.20	peak
5	13919.000	28.07	21.68	49.75	74.00	-24.25	peak
6	17989.000	23.87	26.04	49.91	74.00	-24.09	peak



Test Mode:	802.11ax HE20	Channel:	5825
Polarity:	Horizontal	Test Voltage:	DC 12 V

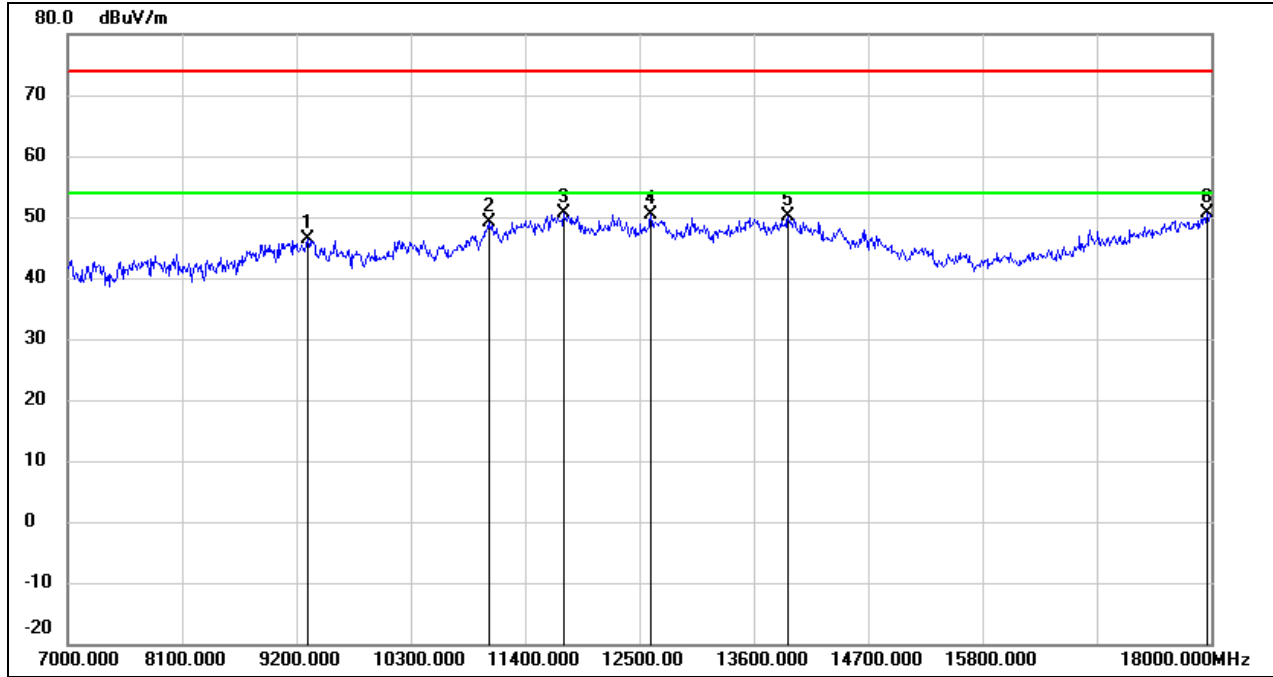

No.	Frequency (MHz)	Reading (dBuV)	Correct (dB/m)	Result (dBuV/m)	Limit (dBuV/m)	Margin (dB)	Remark
1	9310.000	35.85	10.54	46.39	74.00	-27.61	peak
2	11048.000	34.27	14.91	49.18	74.00	-24.82	peak
3	11774.000	33.25	17.28	50.53	74.00	-23.47	peak
4	12610.000	32.43	17.97	50.40	74.00	-23.60	peak
5	13930.000	28.30	21.71	50.01	74.00	-23.99	peak
6	17967.000	24.69	25.89	50.58	74.00	-23.42	peak



Test Mode:	802.11ax HE20	Channel:	5825
Polarity:	Vertical	Test Voltage:	DC 12 V

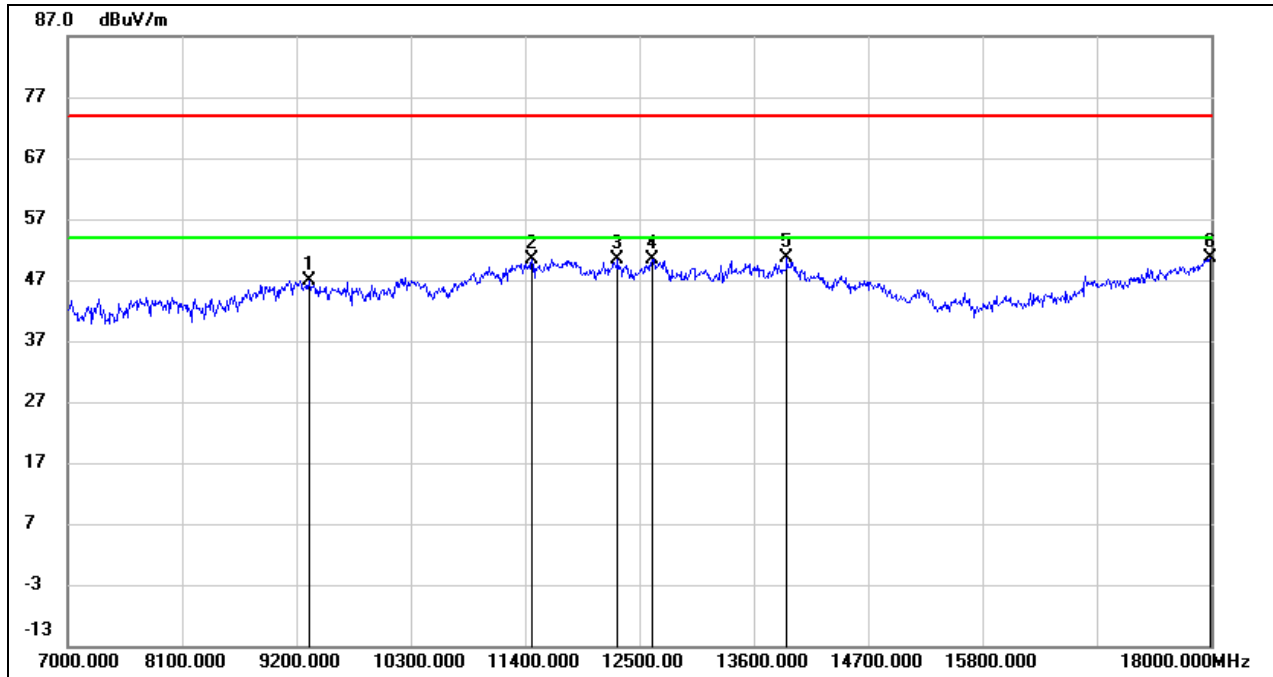

No.	Frequency (MHz)	Reading (dBuV)	Correct (dB/m)	Result (dBuV/m)	Limit (dBuV/m)	Margin (dB)	Remark
1	9321.000	36.40	10.53	46.93	74.00	-27.07	peak
2	11466.000	33.65	16.63	50.28	74.00	-23.72	peak
3	12291.000	32.71	17.78	50.49	74.00	-23.51	peak
4	12621.000	32.35	17.98	50.33	74.00	-23.67	peak
5	13919.000	28.99	21.68	50.67	74.00	-23.33	peak
6	17989.000	24.60	26.04	50.64	74.00	-23.36	peak



Test Mode:	802.11ax HE40	Channel:	5190
Polarity:	Horizontal	Test Voltage:	DC 12 V

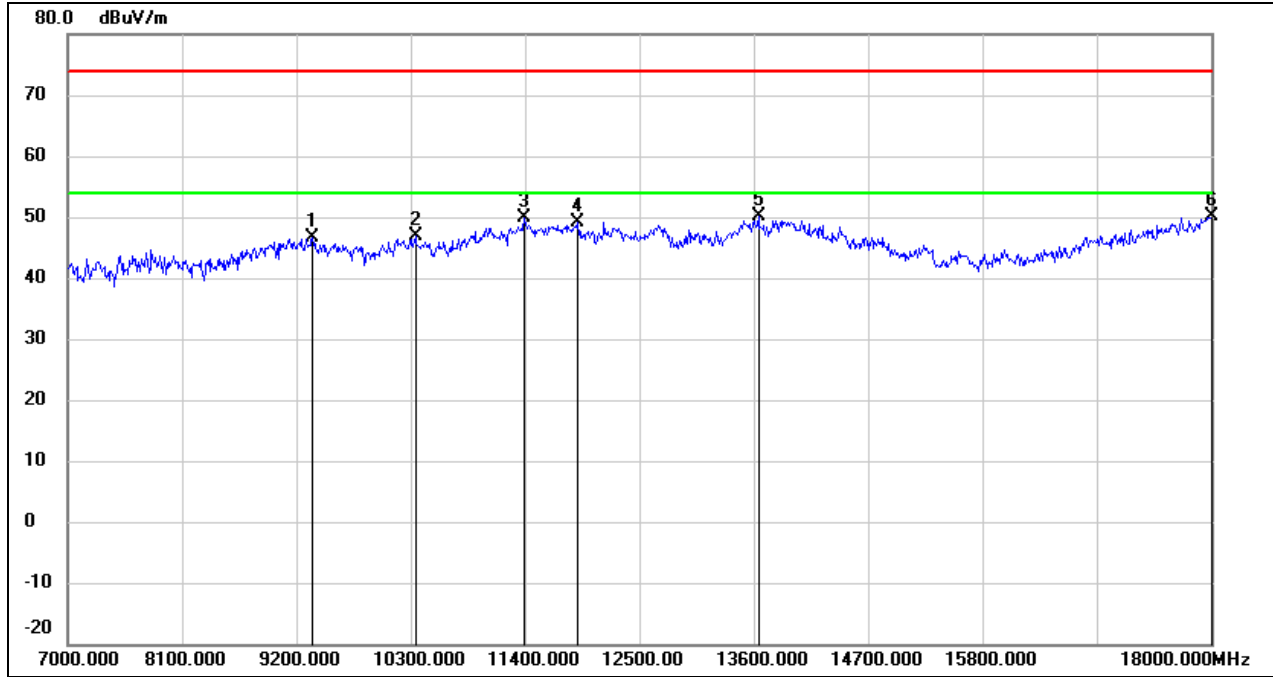

No.	Frequency (MHz)	Reading (dBuV)	Correct (dB/m)	Result (dBuV/m)	Limit (dBuV/m)	Margin (dB)	Remark
1	9354.000	36.06	10.56	46.62	74.00	-27.38	peak
2	10344.000	34.36	12.49	46.85	74.00	-27.15	peak
3	11389.000	33.61	16.31	49.92	74.00	-24.08	peak
4	11906.000	31.58	17.52	49.10	74.00	-24.90	peak
5	13644.000	29.05	20.99	50.04	74.00	-23.96	peak
6	18000.000	23.95	26.12	50.07	74.00	-23.93	peak





Test Mode:	802.11ax HE40	Channel:	5190
Polarity:	Vertical	Test Voltage:	DC 12 V

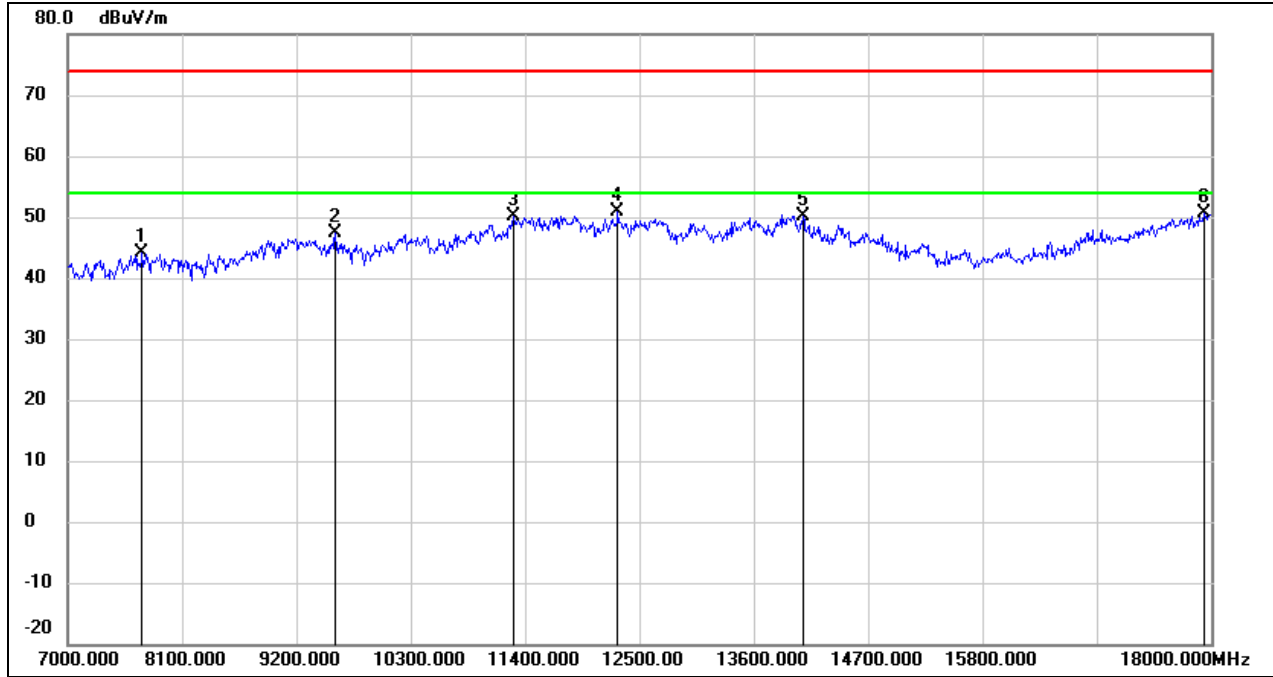

No.	Frequency (MHz)	Reading (dBuV)	Correct (dB/m)	Result (dBuV/m)	Limit (dBuV/m)	Margin (dB)	Remark
1	7715.000	37.37	6.68	44.05	74.00	-29.95	peak
2	9574.000	36.45	10.81	47.26	74.00	-26.74	peak
3	11290.000	34.32	15.90	50.22	74.00	-23.78	peak
4	12291.000	33.03	17.78	50.81	74.00	-23.19	peak
5	14073.000	28.63	21.57	50.20	74.00	-23.80	peak
6	17934.000	24.88	25.67	50.55	74.00	-23.45	peak



Test Mode:	802.11ax HE40	Channel:	5230
Polarity:	Horizontal	Test Voltage:	DC 12 V

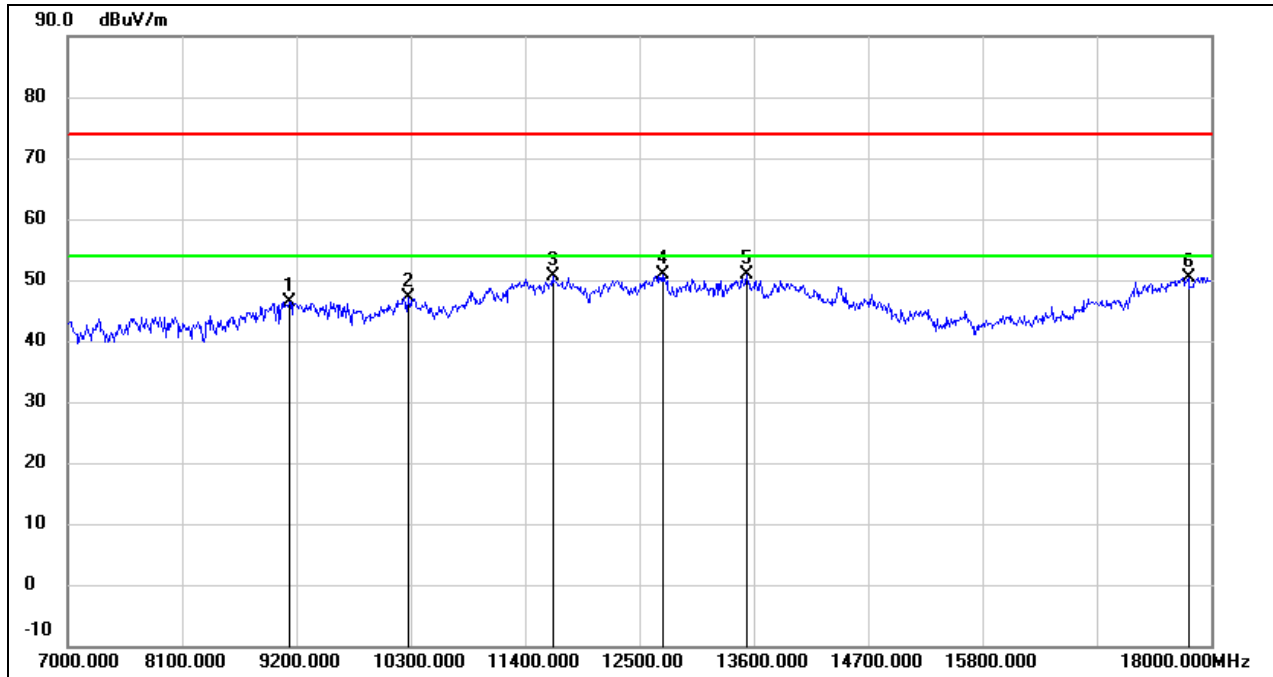

No.	Frequency (MHz)	Reading (dBuV)	Correct (dB/m)	Result (dBuV/m)	Limit (dBuV/m)	Margin (dB)	Remark
1	9134.000	36.02	10.41	46.43	74.00	-27.57	peak
2	10278.000	34.70	12.35	47.05	74.00	-26.95	peak
3	11664.000	33.44	17.08	50.52	74.00	-23.48	peak
4	12720.000	32.73	18.09	50.82	74.00	-23.18	peak
5	13534.000	30.19	20.73	50.92	74.00	-23.08	peak
6	17780.000	25.83	24.61	50.44	74.00	-23.56	peak



Test Mode:	802.11ax HE40	Channel:	5230
Polarity:	Vertical	Test Voltage:	DC 12 V

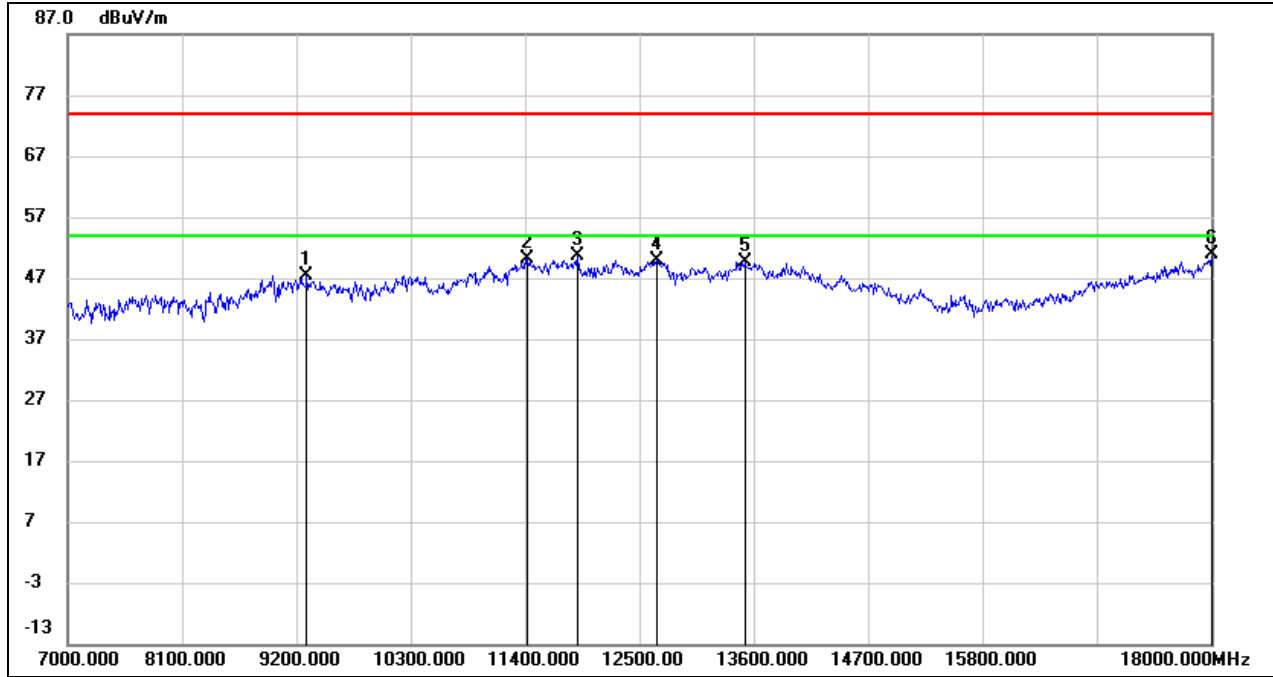

No.	Frequency (MHz)	Reading (dBuV)	Correct (dB/m)	Result (dBuV/m)	Limit (dBuV/m)	Margin (dB)	Remark
1	9299.000	36.95	10.53	47.48	74.00	-26.52	peak
2	11422.000	33.66	16.46	50.12	74.00	-23.88	peak
3	11906.000	33.02	17.52	50.54	74.00	-23.46	peak
4	12665.000	31.77	18.04	49.81	74.00	-24.19	peak
5	13512.000	28.97	20.68	49.65	74.00	-24.35	peak
6	18000.000	24.83	26.12	50.95	74.00	-23.05	peak



Test Mode:	802.11ax HE40	Channel:	5755
Polarity:	Horizontal	Test Voltage:	DC 12 V

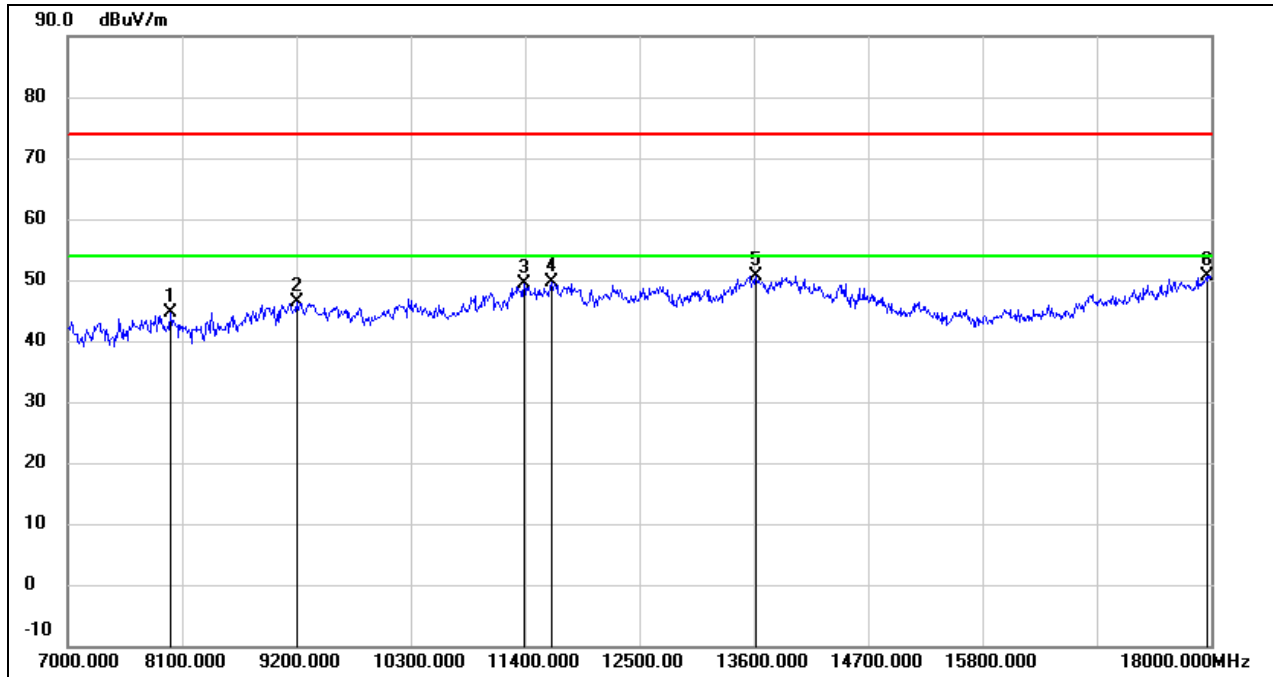

No.	Frequency (MHz)	Reading (dBuV)	Correct (dB/m)	Result (dBuV/m)	Limit (dBuV/m)	Margin (dB)	Remark
1	7990.000	38.10	6.43	44.53	74.00	-29.47	peak
2	9200.000	35.98	10.46	46.44	74.00	-27.56	peak
3	11389.000	32.99	16.31	49.30	74.00	-24.70	peak
4	11653.000	32.69	17.05	49.74	74.00	-24.26	peak
5	13622.000	29.62	20.95	50.57	74.00	-23.43	peak
6	17956.000	24.90	25.82	50.72	74.00	-23.28	peak



Test Mode:	802.11ax HE40	Channel:	5755
Polarity:	Vertical	Test Voltage:	DC 12 V

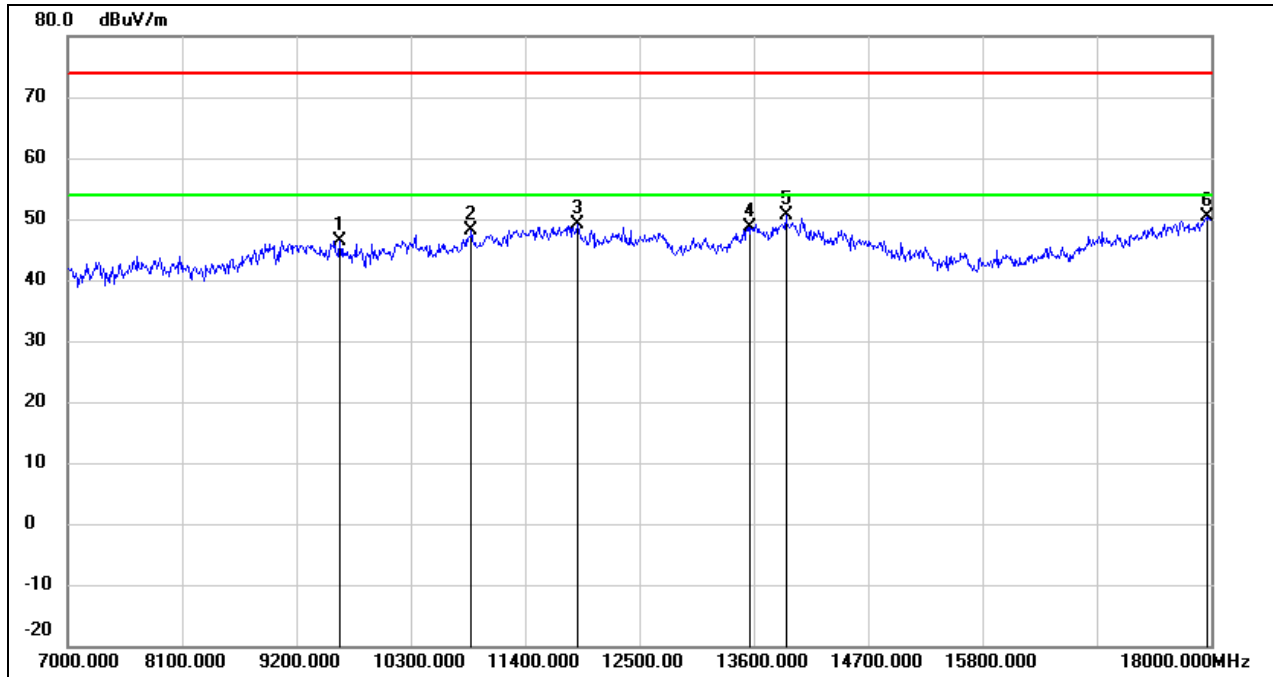

No.	Frequency (MHz)	Reading (dBuV)	Correct (dB/m)	Result (dBuV/m)	Limit (dBuV/m)	Margin (dB)	Remark
1	9618.000	35.48	10.92	46.40	74.00	-27.60	peak
2	10883.000	33.82	14.27	48.09	74.00	-25.91	peak
3	11906.000	31.53	17.52	49.05	74.00	-24.95	peak
4	13567.000	27.87	20.80	48.67	74.00	-25.33	peak
5	13908.000	29.07	21.66	50.73	74.00	-23.27	peak
6	17956.000	24.55	25.82	50.37	74.00	-23.63	peak



Test Mode:	802.11ax HE40	Channel:	5795
Polarity:	Horizontal	Test Voltage:	DC 12 V

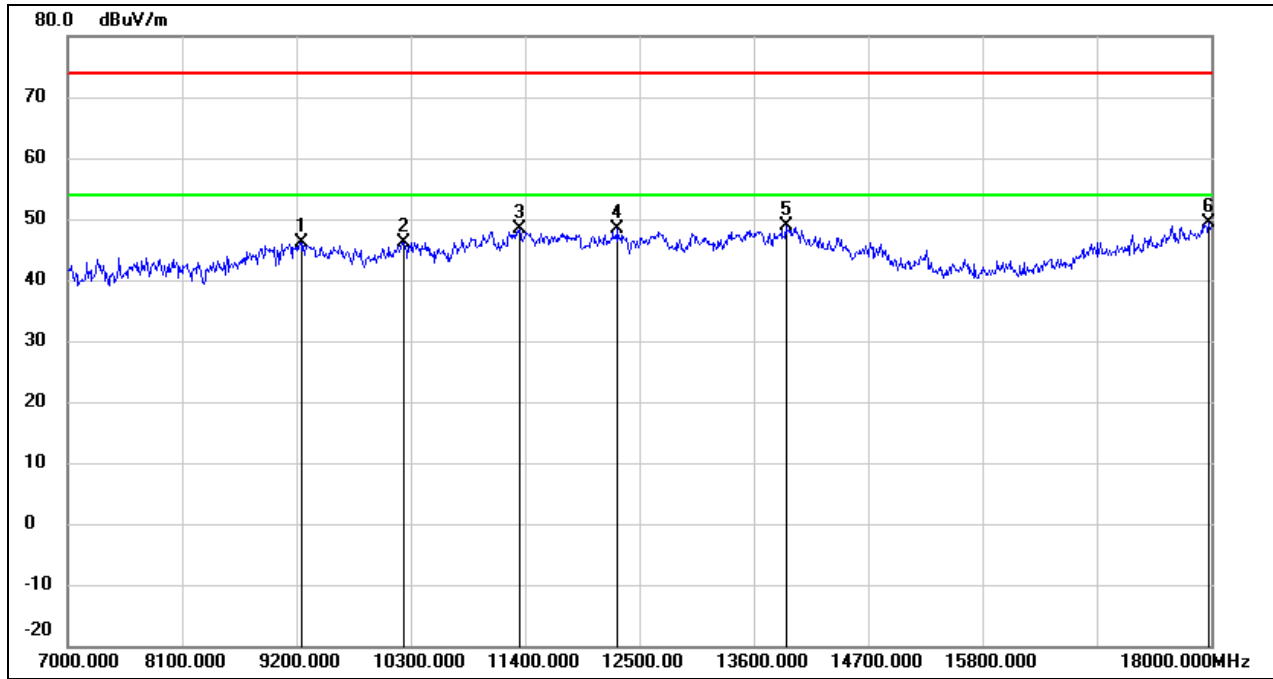

No.	Frequency (MHz)	Reading (dBuV)	Correct (dB/m)	Result (dBuV/m)	Limit (dBuV/m)	Margin (dB)	Remark
1	9244.000	35.71	10.49	46.20	74.00	-27.80	peak
2	10234.000	33.98	12.26	46.24	74.00	-27.76	peak
3	11345.000	32.12	16.14	48.26	74.00	-25.74	peak
4	12291.000	30.67	17.78	48.45	74.00	-25.55	peak
5	13908.000	27.16	21.66	48.82	74.00	-25.18	peak
6	17978.000	23.29	25.97	49.26	74.00	-24.74	peak



Test Mode:	802.11ax HE40	Channel:	5795
Polarity:	Vertical	Test Voltage:	DC 12 V

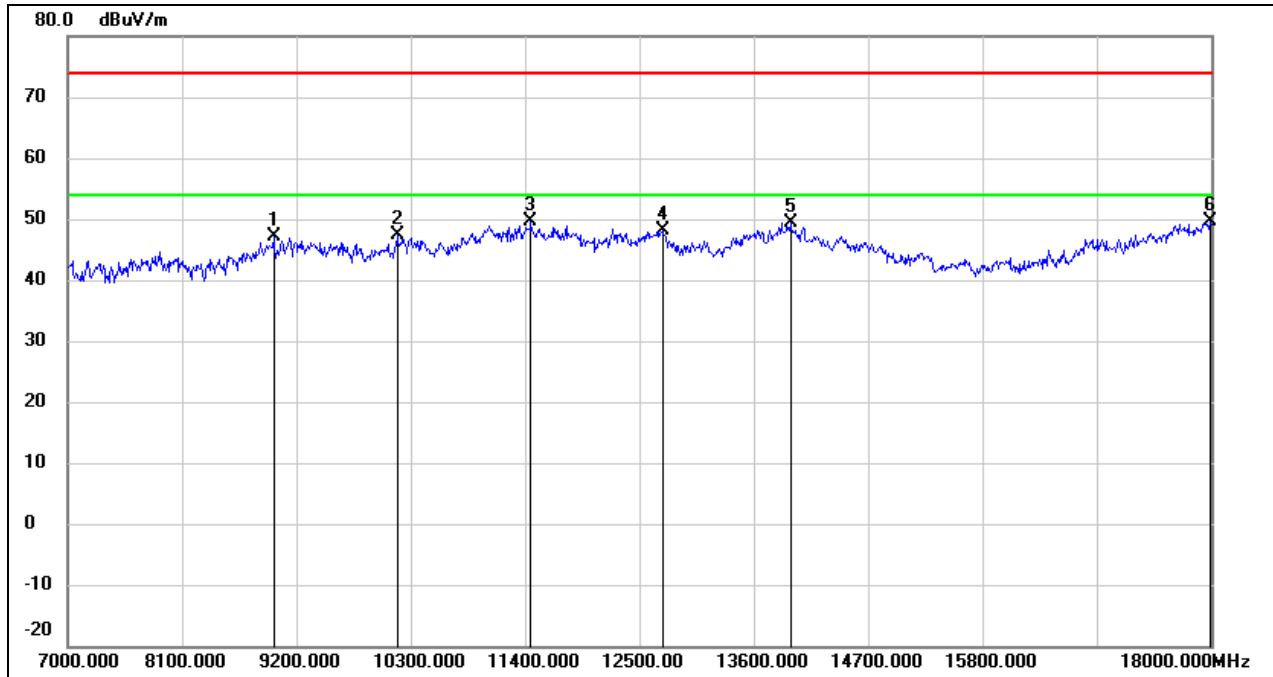

No.	Frequency (MHz)	Reading (dBuV)	Correct (dB/m)	Result (dBuV/m)	Limit (dBuV/m)	Margin (dB)	Remark
1	8980.000	36.80	10.21	47.01	74.00	-26.99	peak
2	10168.000	35.18	12.13	47.31	74.00	-26.69	peak
3	11455.000	32.99	16.58	49.57	74.00	-24.43	peak
4	12720.000	30.09	18.09	48.18	74.00	-25.82	peak
5	13952.000	27.66	21.76	49.42	74.00	-24.58	peak
6	17989.000	23.56	26.04	49.60	74.00	-24.40	peak



Test Mode:	802.11ax HE80	Channel:	5210
Polarity:	Horizontal	Test Voltage:	DC 12 V

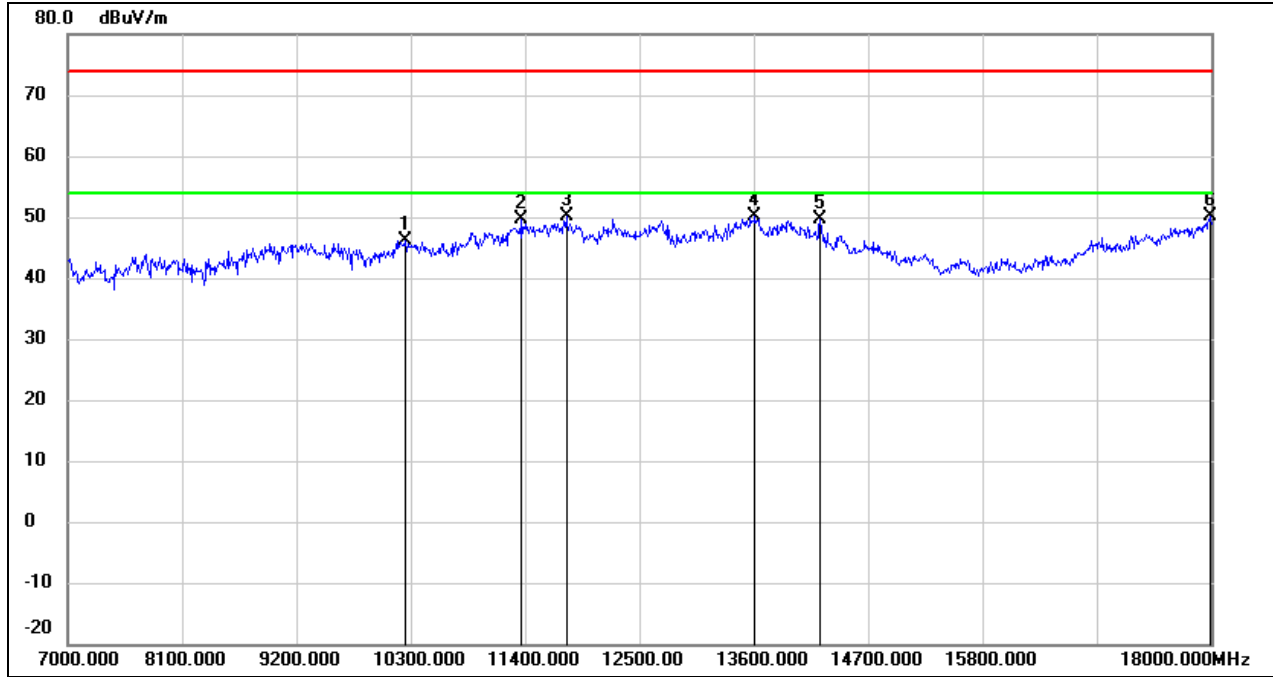

No.	Frequency (MHz)	Reading (dBuV)	Correct (dB/m)	Result (dBuV/m)	Limit (dBuV/m)	Margin (dB)	Remark
1	10245.000	33.84	12.28	46.12	74.00	-27.88	peak
2	11367.000	33.41	16.22	49.63	74.00	-24.37	peak
3	11796.000	32.81	17.32	50.13	74.00	-23.87	peak
4	13611.000	29.13	20.92	50.05	74.00	-23.95	peak
5	14238.000	28.73	20.88	49.61	74.00	-24.39	peak
6	17989.000	24.03	26.04	50.07	74.00	-23.93	peak





Test Mode:	802.11ax HE80	Channel:	5210
Polarity:	Vertical	Test Voltage:	DC 12 V

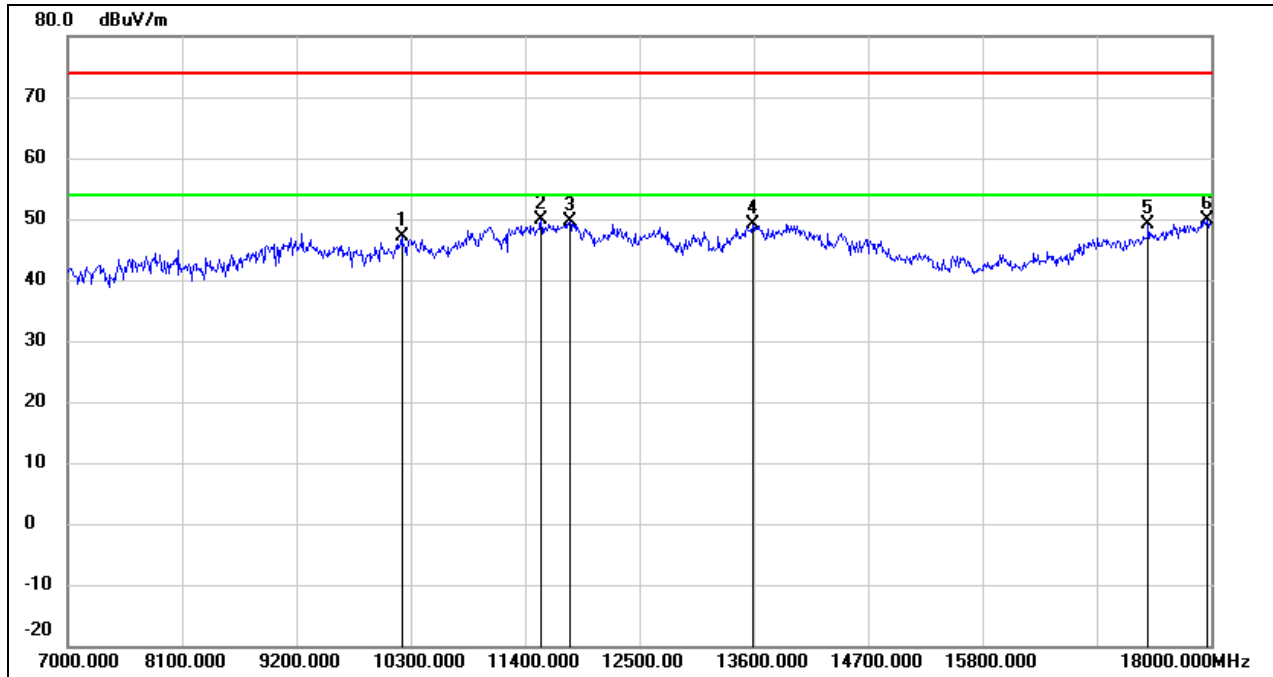

No.	Frequency (MHz)	Reading (dBuV)	Correct (dB/m)	Result (dBuV/m)	Limit (dBuV/m)	Margin (dB)	Remark
1	10212.000	35.04	12.21	47.25	74.00	-26.75	peak
2	11554.000	32.98	16.87	49.85	74.00	-24.15	peak
3	11829.000	32.16	17.38	49.54	74.00	-24.46	peak
4	13589.000	28.38	20.86	49.24	74.00	-24.76	peak
5	17395.000	26.96	22.26	49.22	74.00	-24.78	peak
6	17967.000	24.07	25.89	49.96	74.00	-24.04	peak



Test Mode:	802.11ax HE80	Channel:	5775
Polarity:	Horizontal	Test Voltage:	DC 12 V

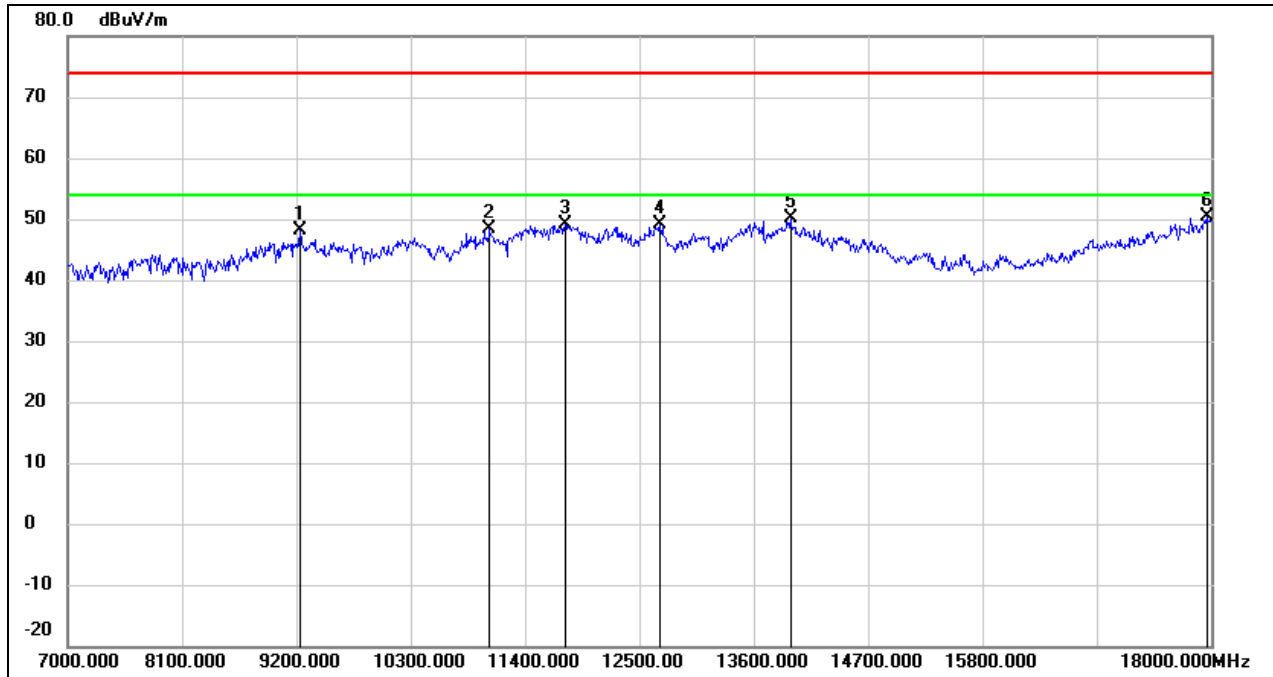

No.	Frequency (MHz)	Reading (dBuV)	Correct (dB/m)	Result (dBuV/m)	Limit (dBuV/m)	Margin (dB)	Remark
1	9233.000	37.75	10.48	48.23	74.00	-25.77	peak
2	11059.000	33.43	14.96	48.39	74.00	-25.61	peak
3	11785.000	31.77	17.30	49.07	74.00	-24.93	peak
4	12698.000	30.93	18.08	49.01	74.00	-24.99	peak
5	13952.000	28.36	21.76	50.12	74.00	-23.88	peak
6	17956.000	24.63	25.82	50.45	74.00	-23.55	peak



Test Mode:	802.11ax HE80	Channel:	5775
Polarity:	Vertical	Test Voltage:	DC 12 V

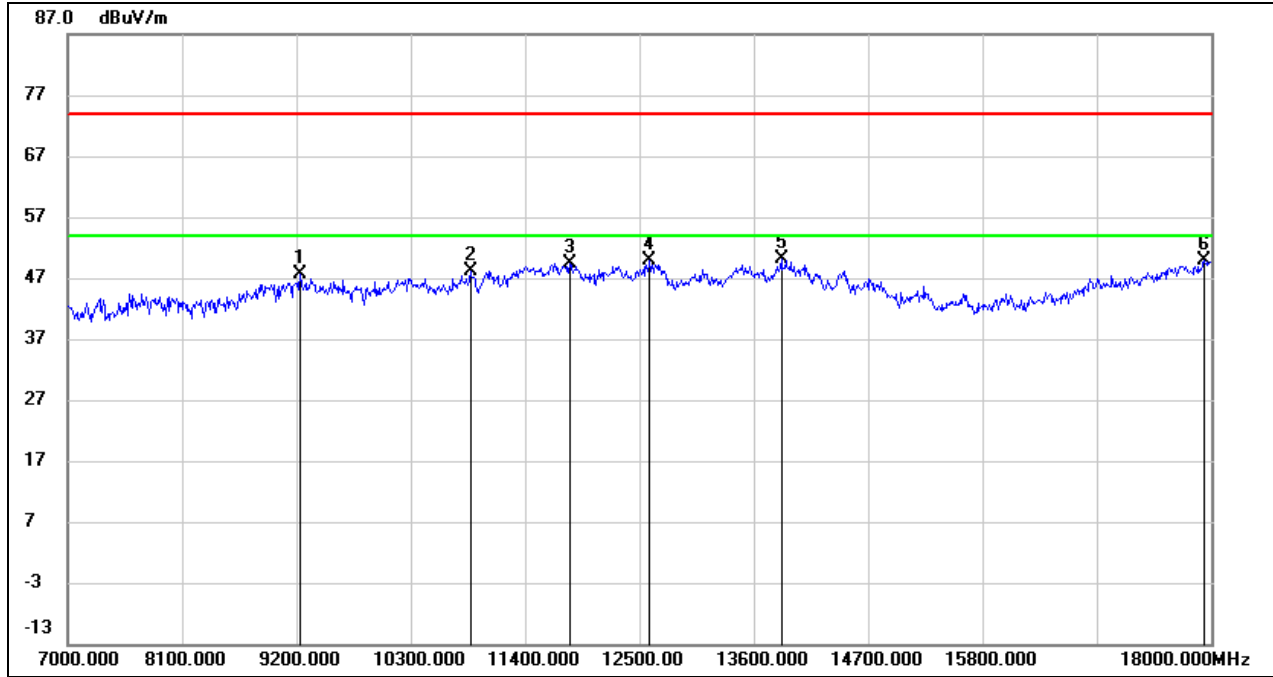

No.	Frequency (MHz)	Reading (dBuV)	Correct (dB/m)	Result (dBuV/m)	Limit (dBuV/m)	Margin (dB)	Remark
1	9233.000	37.09	10.48	47.57	74.00	-26.43	peak
2	10872.000	33.96	14.23	48.19	74.00	-25.81	peak
3	11829.000	31.93	17.38	49.31	74.00	-24.69	peak
4	12599.000	31.88	17.95	49.83	74.00	-24.17	peak
5	13864.000	28.56	21.53	50.09	74.00	-23.91	peak
6	17934.000	24.09	25.67	49.76	74.00	-24.24	peak



Test Mode:	802.11be EHT20	Channel:	5180
Polarity:	Horizontal	Test Voltage:	DC 12 V

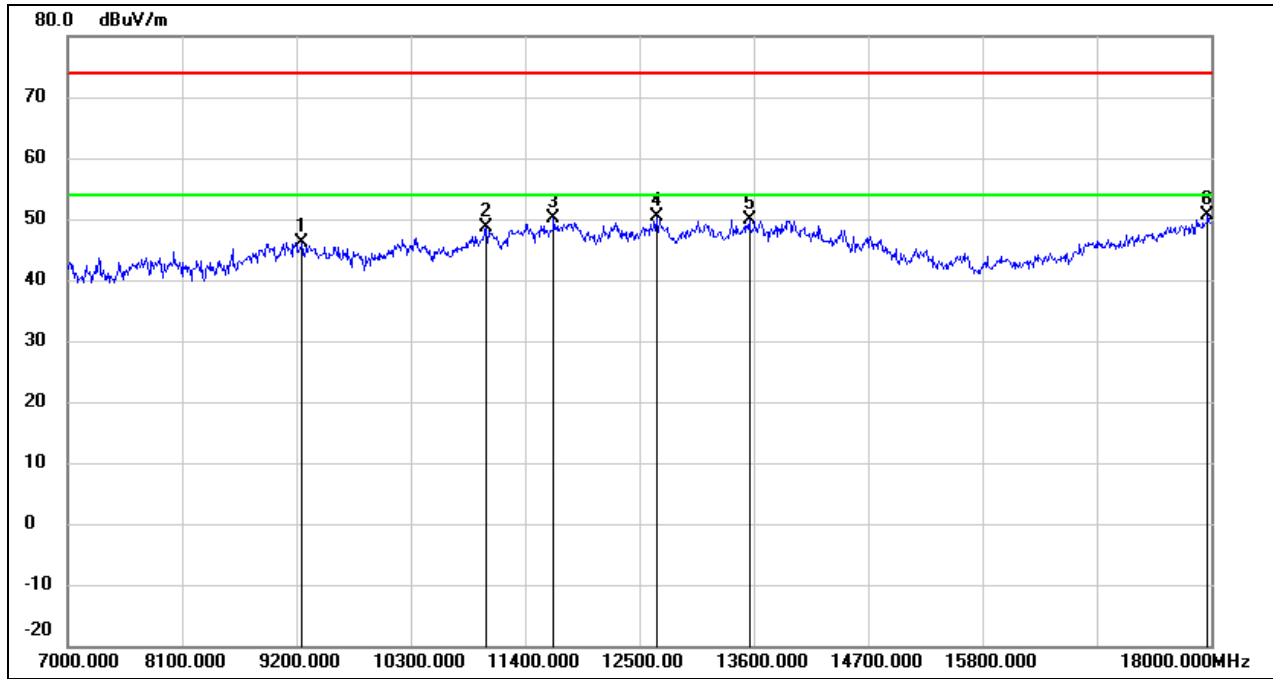

No.	Frequency (MHz)	Reading (dBuV)	Correct (dB/m)	Result (dBuV/m)	Limit (dBuV/m)	Margin (dB)	Remark
1	9255.000	35.72	10.51	46.23	74.00	-27.77	peak
2	11026.000	33.75	14.82	48.57	74.00	-25.43	peak
3	11675.000	33.12	17.10	50.22	74.00	-23.78	peak
4	12665.000	32.29	18.04	50.33	74.00	-23.67	peak
5	13556.000	29.16	20.78	49.94	74.00	-24.06	peak
6	17967.000	24.75	25.89	50.64	74.00	-23.36	peak



Test Mode:	802.11be EHT20	Channel:	5180
Polarity:	Vertical	Test Voltage:	DC 12 V

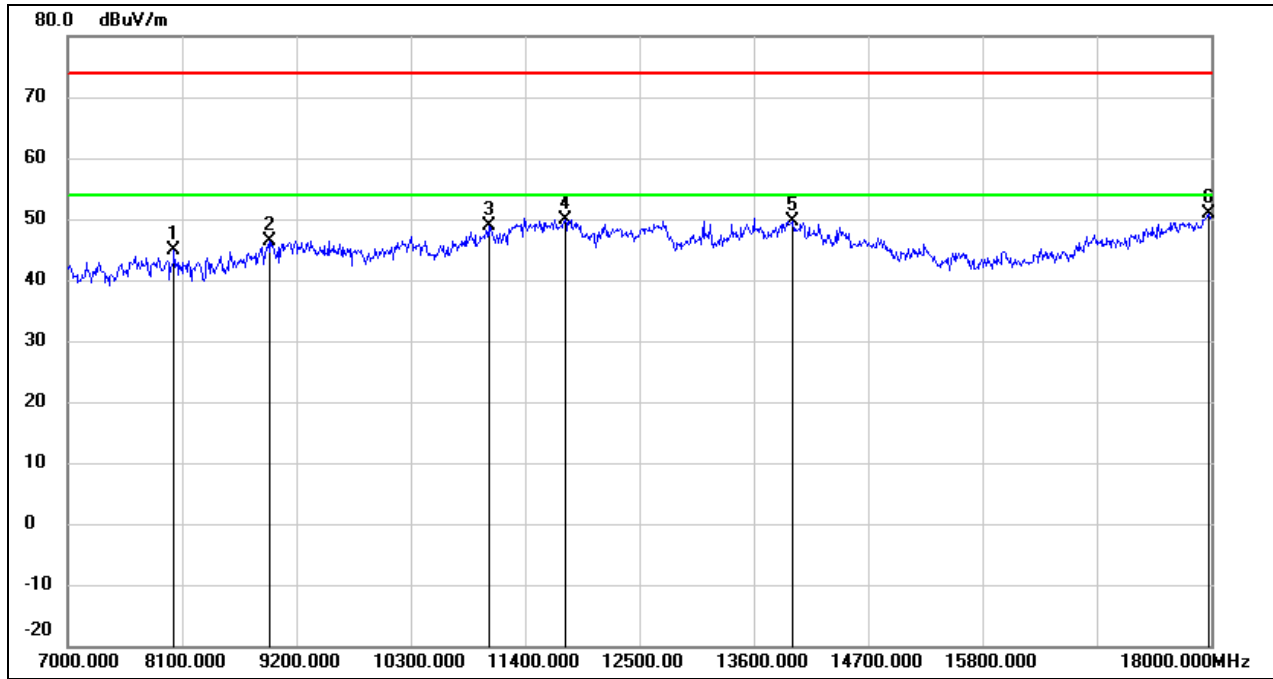

No.	Frequency (MHz)	Reading (dBuV)	Correct (dB/m)	Result (dBuV/m)	Limit (dBuV/m)	Margin (dB)	Remark
1	8023.000	38.53	6.45	44.98	74.00	-29.02	peak
2	8936.000	36.50	9.90	46.40	74.00	-27.60	peak
3	11048.000	34.03	14.91	48.94	74.00	-25.06	peak
4	11785.000	32.58	17.30	49.88	74.00	-24.12	peak
5	13974.000	27.72	21.82	49.54	74.00	-24.46	peak
6	17978.000	24.81	25.97	50.78	74.00	-23.22	peak



Test Mode:	802.11be EHT20	Channel:	5200
Polarity:	Horizontal	Test Voltage:	DC 12 V

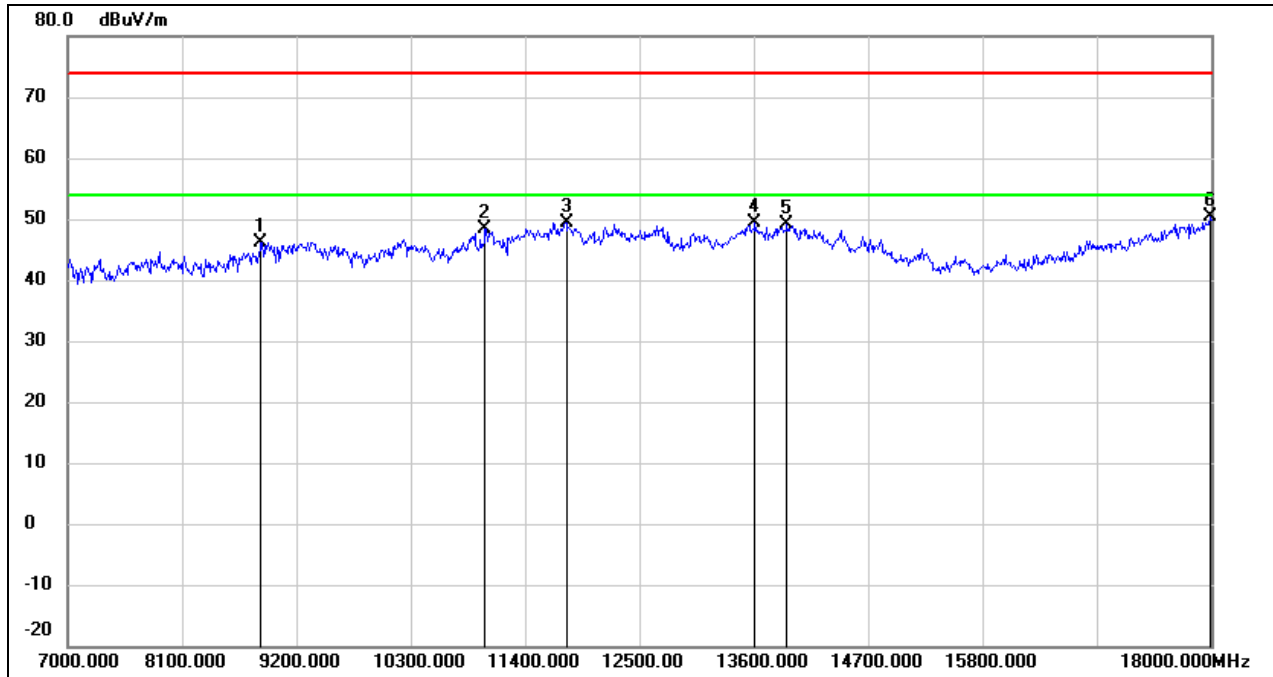

No.	Frequency (MHz)	Reading (dBuV)	Correct (dB/m)	Result (dBuV/m)	Limit (dBuV/m)	Margin (dB)	Remark
1	8859.000	36.89	9.36	46.25	74.00	-27.75	peak
2	11015.000	33.68	14.79	48.47	74.00	-25.53	peak
3	11796.000	32.11	17.32	49.43	74.00	-24.57	peak
4	13611.000	28.48	20.92	49.40	74.00	-24.60	peak
5	13919.000	27.44	21.68	49.12	74.00	-24.88	peak
6	17989.000	24.38	26.04	50.42	74.00	-23.58	peak



Test Mode:	802.11be EHT20	Channel:	5200
Polarity:	Vertical	Test Voltage:	DC 12 V

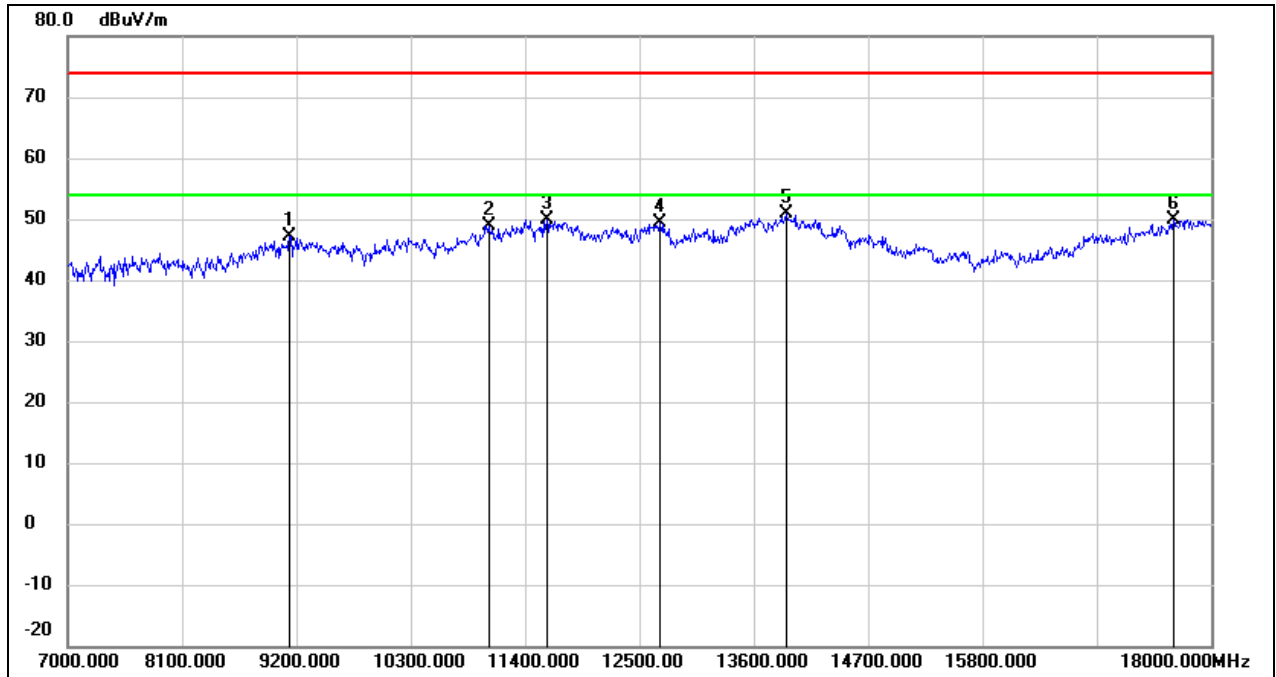

No.	Frequency (MHz)	Reading (dBuV)	Correct (dB/m)	Result (dBuV/m)	Limit (dBuV/m)	Margin (dB)	Remark
1	9134.000	36.72	10.41	47.13	74.00	-26.87	peak
2	11048.000	34.08	14.91	48.99	74.00	-25.01	peak
3	11609.000	32.89	16.98	49.87	74.00	-24.13	peak
4	12698.000	31.23	18.08	49.31	74.00	-24.69	peak
5	13919.000	29.28	21.68	50.96	74.00	-23.04	peak
6	17637.000	26.21	23.64	49.85	74.00	-24.15	peak



Test Mode:	802.11be EHT20	Channel:	5240
Polarity:	Horizontal	Test Voltage:	DC 12 V

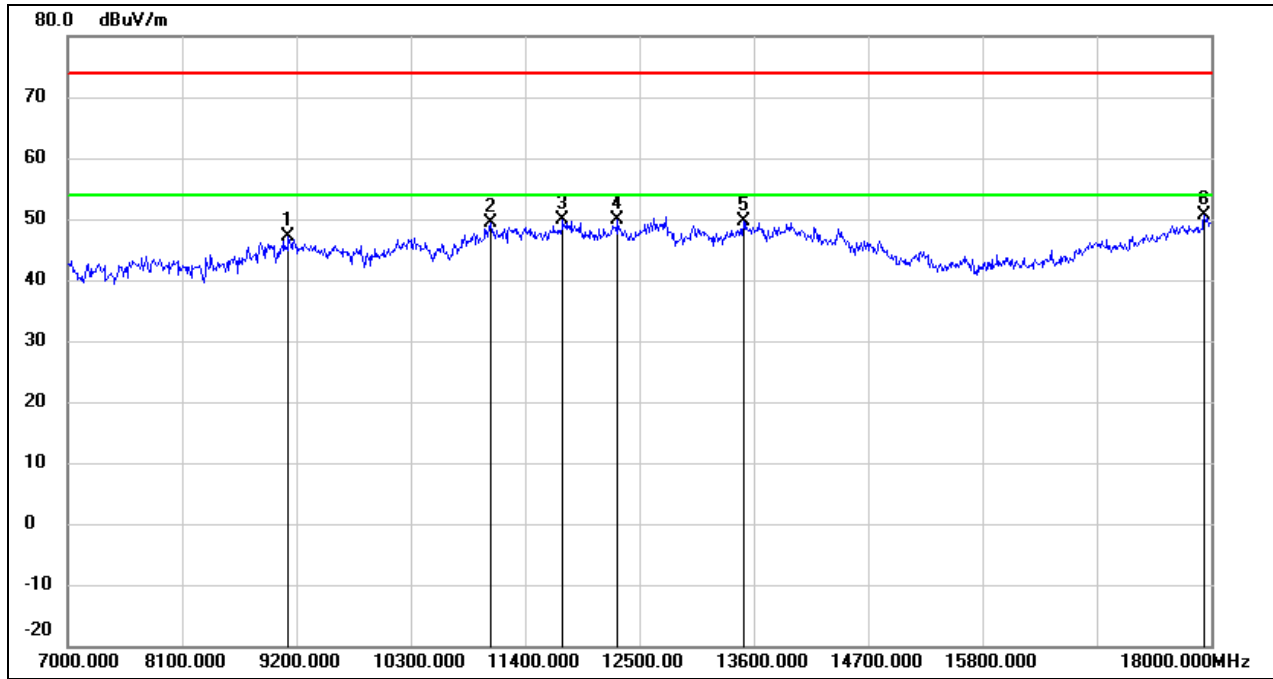

No.	Frequency (MHz)	Reading (dBuV)	Correct (dB/m)	Result (dBuV/m)	Limit (dBuV/m)	Margin (dB)	Remark
1	9123.000	36.71	10.42	47.13	74.00	-26.87	peak
2	11070.000	34.25	15.01	49.26	74.00	-24.74	peak
3	11763.000	32.59	17.26	49.85	74.00	-24.15	peak
4	12291.000	32.13	17.78	49.91	74.00	-24.09	peak
5	13501.000	29.05	20.64	49.69	74.00	-24.31	peak
6	17934.000	24.99	25.67	50.66	74.00	-23.34	peak





Test Mode:	802.11be EHT20	Channel:	5240
Polarity:	Vertical	Test Voltage:	DC 12 V

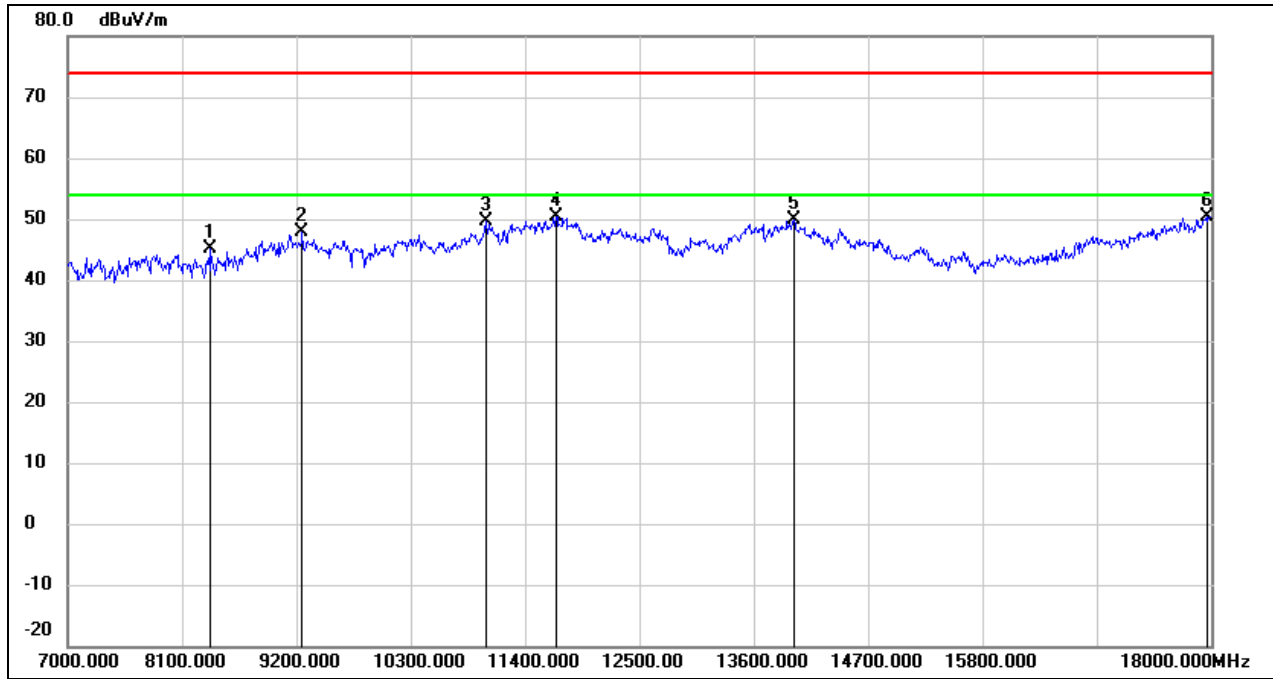

No.	Frequency (MHz)	Reading (dBuV)	Correct (dB/m)	Result (dBuV/m)	Limit (dBuV/m)	Margin (dB)	Remark
1	8375.000	38.35	6.77	45.12	74.00	-28.88	peak
2	9255.000	37.26	10.51	47.77	74.00	-26.23	peak
3	11026.000	34.71	14.82	49.53	74.00	-24.47	peak
4	11697.000	33.36	17.13	50.49	74.00	-23.51	peak
5	13985.000	28.07	21.85	49.92	74.00	-24.08	peak
6	17956.000	24.52	25.82	50.34	74.00	-23.66	peak



Test Mode:	802.11be EHT20	Channel:	5745
Polarity:	Horizontal	Test Voltage:	DC 12 V

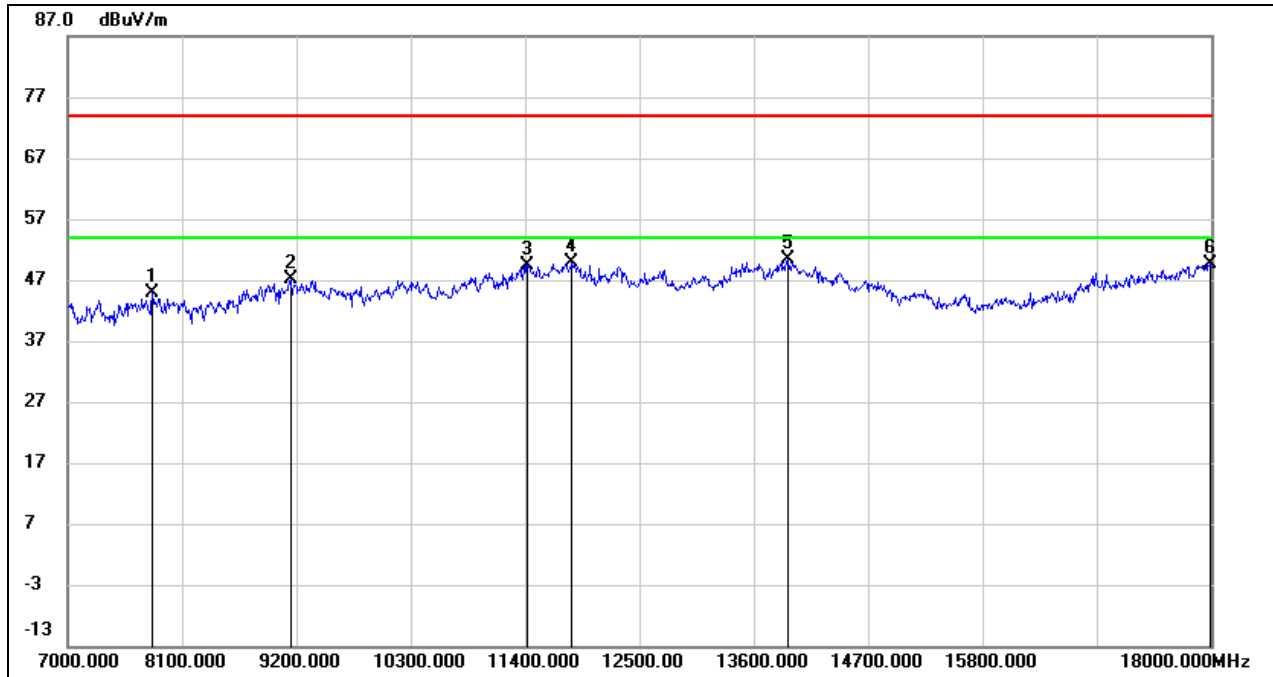

No.	Frequency (MHz)	Reading (dBuV)	Correct (dB/m)	Result (dBuV/m)	Limit (dBuV/m)	Margin (dB)	Remark
1	7814.000	38.38	6.60	44.98	74.00	-29.02	peak
2	9145.000	36.68	10.43	47.11	74.00	-26.89	peak
3	11422.000	32.96	16.46	49.42	74.00	-24.58	peak
4	11851.000	32.44	17.43	49.87	74.00	-24.13	peak
5	13930.000	28.56	21.71	50.27	74.00	-23.73	peak
6	17989.000	23.65	26.04	49.69	74.00	-24.31	peak



Test Mode:	802.11be EHT20	Channel:	5745
Polarity:	Vertical	Test Voltage:	DC 12 V

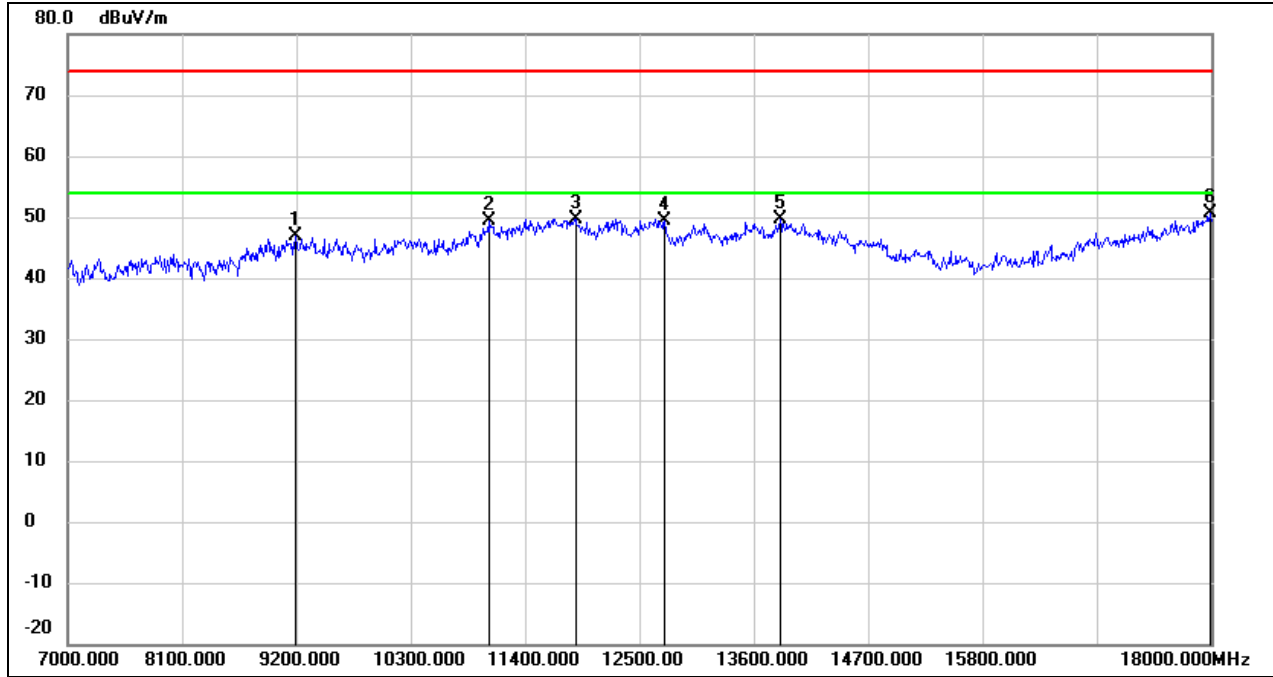

No.	Frequency (MHz)	Reading (dBuV)	Correct (dB/m)	Result (dBuV/m)	Limit (dBuV/m)	Margin (dB)	Remark
1	9189.000	36.47	10.46	46.93	74.00	-27.07	peak
2	11048.000	34.39	14.91	49.30	74.00	-24.70	peak
3	11884.000	32.23	17.48	49.71	74.00	-24.29	peak
4	12742.000	31.23	18.13	49.36	74.00	-24.64	peak
5	13853.000	28.15	21.52	49.67	74.00	-24.33	peak
6	17989.000	24.54	26.04	50.58	74.00	-23.42	peak



Test Mode:	802.11be EHT20	Channel:	5785
Polarity:	Horizontal	Test Voltage:	DC 12 V

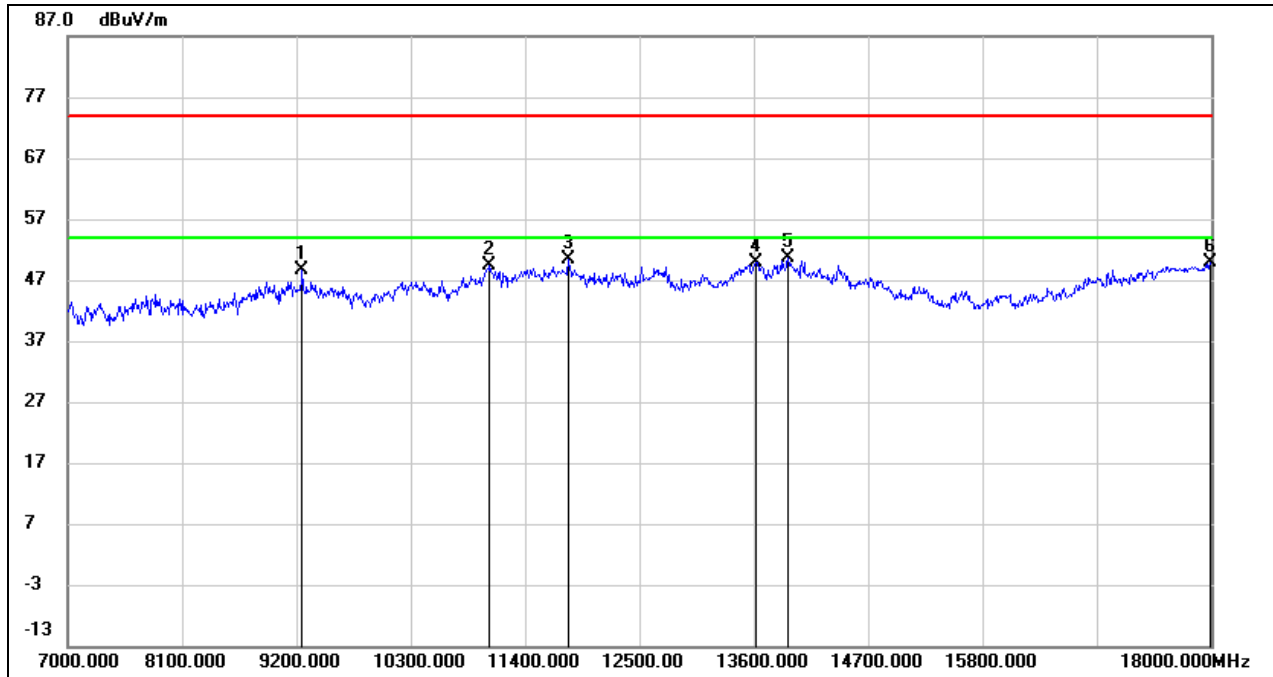

No.	Frequency (MHz)	Reading (dBuV)	Correct (dB/m)	Result (dBuV/m)	Limit (dBuV/m)	Margin (dB)	Remark
1	9255.000	38.17	10.51	48.68	74.00	-25.32	peak
2	11059.000	34.40	14.96	49.36	74.00	-24.64	peak
3	11818.000	33.04	17.36	50.40	74.00	-23.60	peak
4	13622.000	29.02	20.95	49.97	74.00	-24.03	peak
5	13930.000	28.91	21.71	50.62	74.00	-23.38	peak
6	17989.000	23.90	26.04	49.94	74.00	-24.06	peak



Test Mode:	802.11be EHT20	Channel:	5785
Polarity:	Vertical	Test Voltage:	DC 12 V

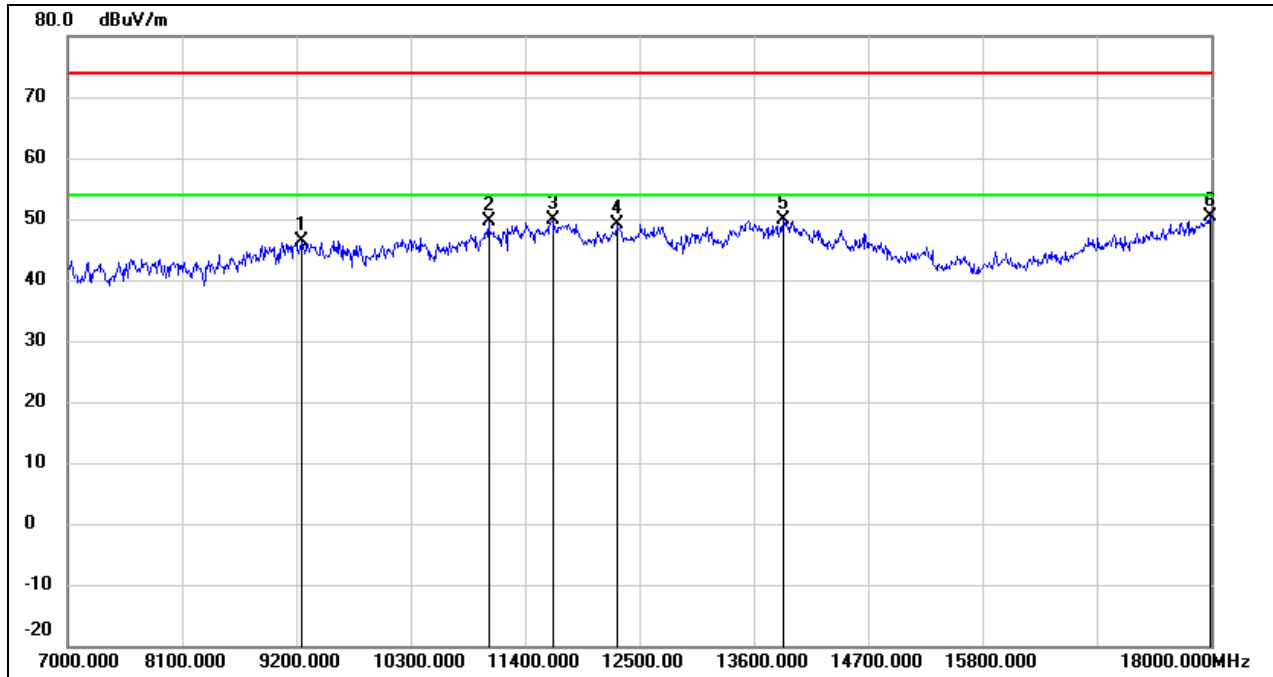

No.	Frequency (MHz)	Reading (dBuV)	Correct (dB/m)	Result (dBuV/m)	Limit (dBuV/m)	Margin (dB)	Remark
1	9255.000	35.95	10.51	46.46	74.00	-27.54	peak
2	11048.000	34.76	14.91	49.67	74.00	-24.33	peak
3	11664.000	32.70	17.08	49.78	74.00	-24.22	peak
4	12280.000	31.42	17.77	49.19	74.00	-24.81	peak
5	13886.000	28.20	21.60	49.80	74.00	-24.20	peak
6	17989.000	24.41	26.04	50.45	74.00	-23.55	peak



Test Mode:	802.11be EHT20	Channel:	5825
Polarity:	Horizontal	Test Voltage:	DC 12 V

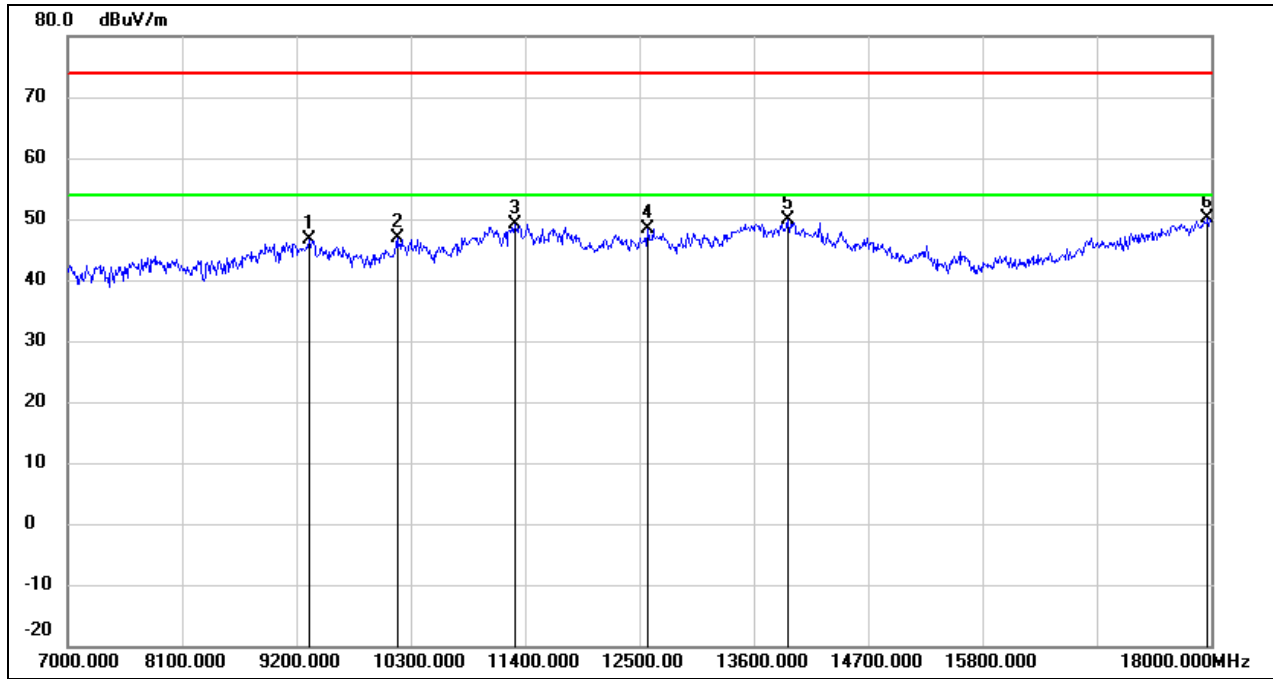

No.	Frequency (MHz)	Reading (dBuV)	Correct (dB/m)	Result (dBuV/m)	Limit (dBuV/m)	Margin (dB)	Remark
1	9321.000	36.04	10.53	46.57	74.00	-27.43	peak
2	10168.000	34.76	12.13	46.89	74.00	-27.11	peak
3	11301.000	33.24	15.95	49.19	74.00	-24.81	peak
4	12577.000	30.55	17.93	48.48	74.00	-25.52	peak
5	13930.000	28.14	21.71	49.85	74.00	-24.15	peak
6	17967.000	24.24	25.89	50.13	74.00	-23.87	peak



Test Mode:	802.11be EHT20	Channel:	5825
Polarity:	Vertical	Test Voltage:	DC 12 V

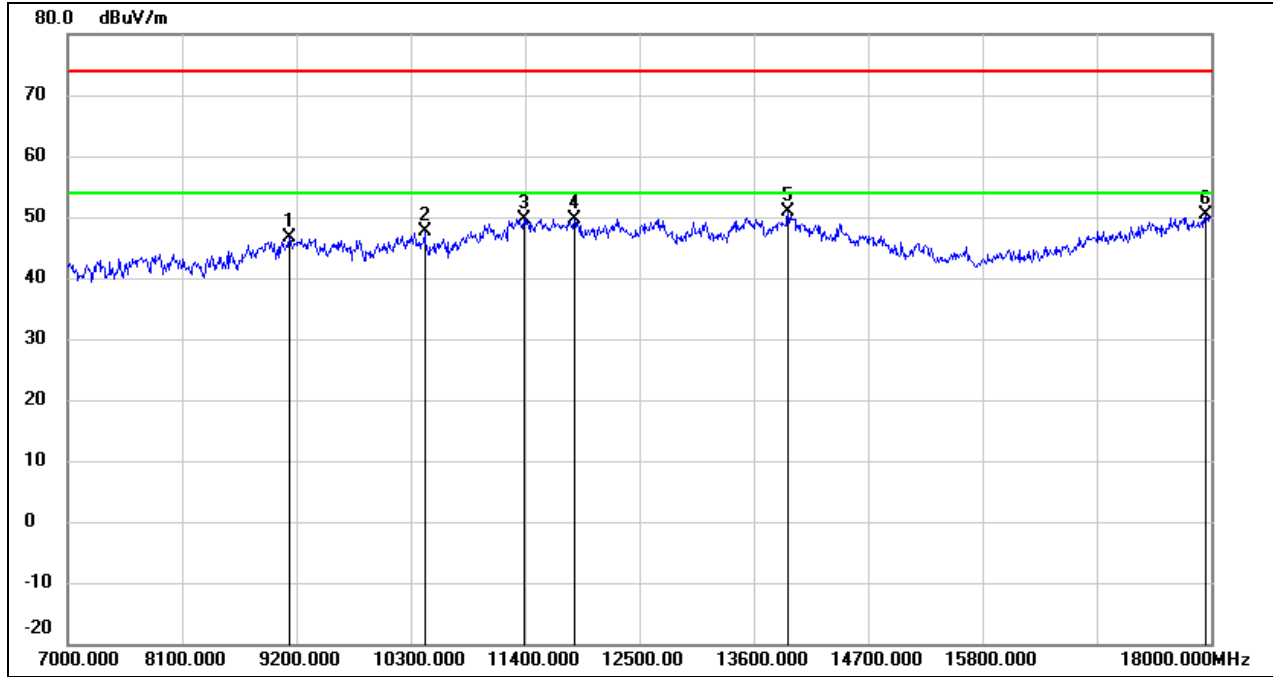

No.	Frequency (MHz)	Reading (dBuV)	Correct (dB/m)	Result (dBuV/m)	Limit (dBuV/m)	Margin (dB)	Remark
1	9134.000	36.21	10.41	46.62	74.00	-27.38	peak
2	10432.000	34.92	12.67	47.59	74.00	-26.41	peak
3	11389.000	33.44	16.31	49.75	74.00	-24.25	peak
4	11873.000	32.18	17.46	49.64	74.00	-24.36	peak
5	13930.000	29.06	21.71	50.77	74.00	-23.23	peak
6	17945.000	24.55	25.75	50.30	74.00	-23.70	peak



Test Mode:	802.11be EHT40	Channel:	5190
Polarity:	Horizontal	Test Voltage:	DC 12 V

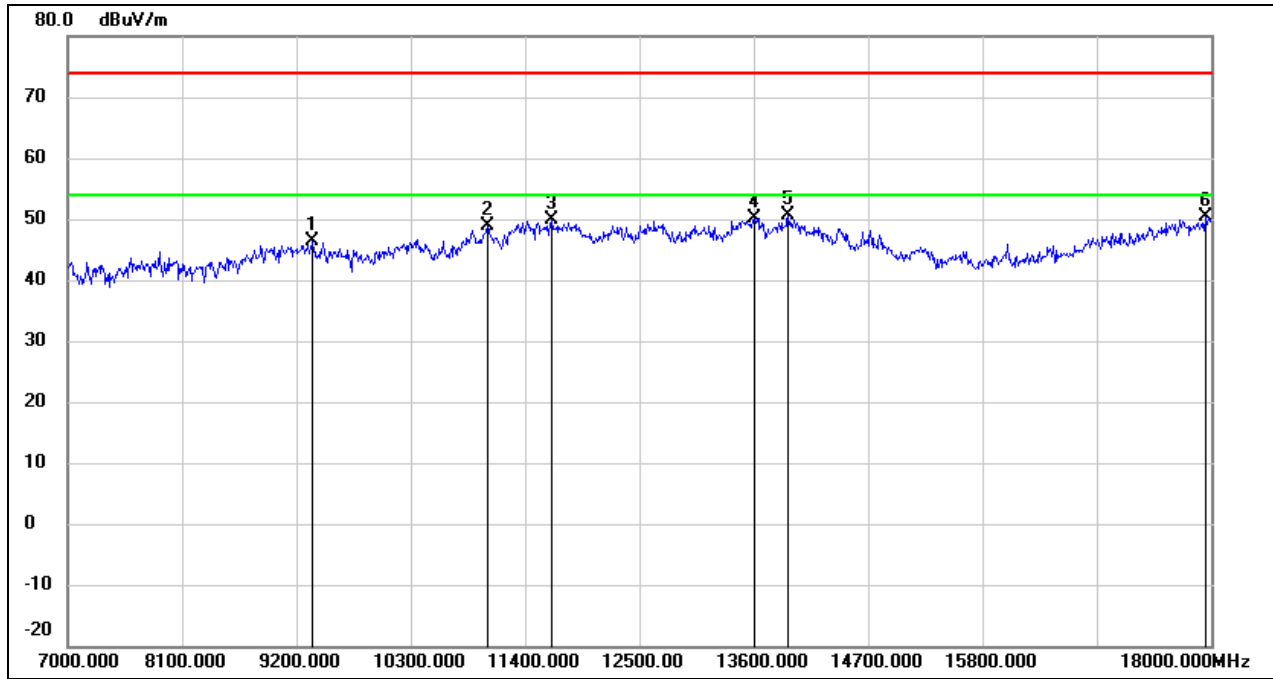

No.	Frequency (MHz)	Reading (dBuV)	Correct (dB/m)	Result (dBuV/m)	Limit (dBuV/m)	Margin (dB)	Remark
1	9354.000	35.72	10.56	46.28	74.00	-27.72	peak
2	11037.000	34.08	14.87	48.95	74.00	-25.05	peak
3	11653.000	32.89	17.05	49.94	74.00	-24.06	peak
4	13611.000	29.21	20.92	50.13	74.00	-23.87	peak
5	13930.000	28.89	21.71	50.60	74.00	-23.40	peak
6	17945.000	24.55	25.75	50.30	74.00	-23.70	peak





Test Mode:	802.11be EHT40	Channel:	5190
Polarity:	Vertical	Test Voltage:	DC 12 V

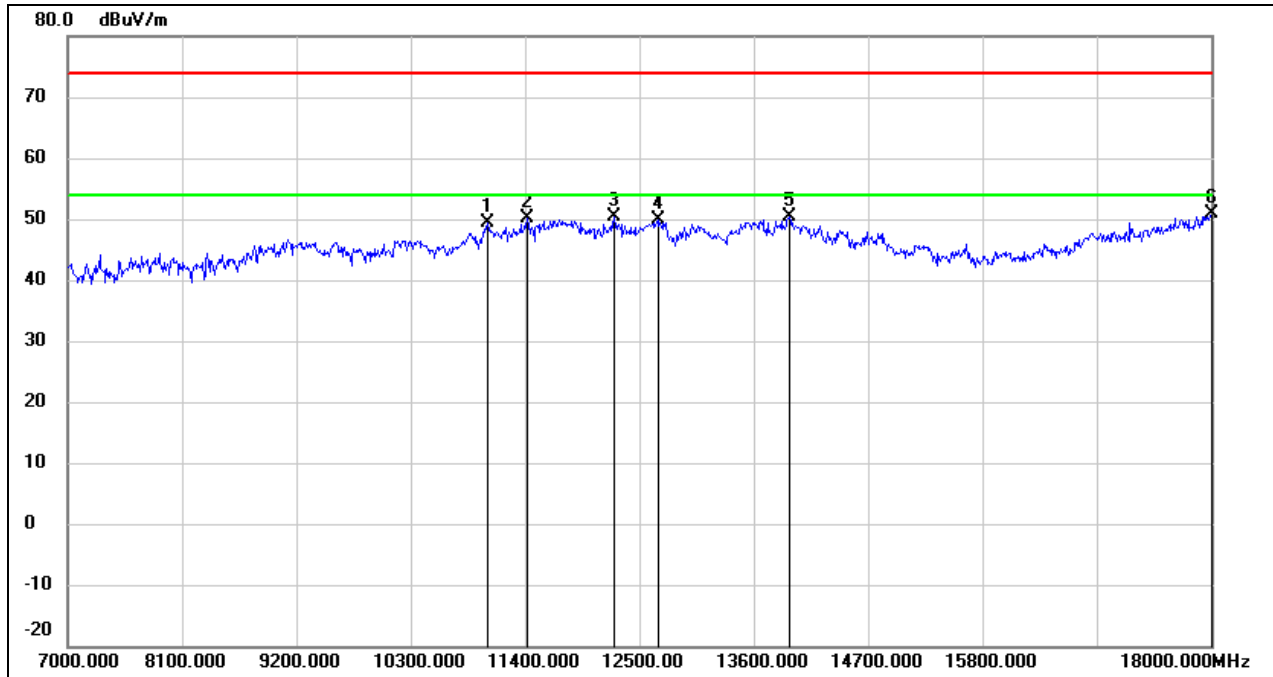

No.	Frequency (MHz)	Reading (dBuV)	Correct (dB/m)	Result (dBuV/m)	Limit (dBuV/m)	Margin (dB)	Remark
1	11037.000	34.58	14.87	49.45	74.00	-24.55	peak
2	11422.000	33.72	16.46	50.18	74.00	-23.82	peak
3	12258.000	32.56	17.77	50.33	74.00	-23.67	peak
4	12676.000	31.89	18.05	49.94	74.00	-24.06	peak
5	13941.000	28.70	21.73	50.43	74.00	-23.57	peak
6	18000.000	24.66	26.12	50.78	74.00	-23.22	peak



Test Mode:	802.11be EHT40	Channel:	5230
Polarity:	Horizontal	Test Voltage:	DC 12 V

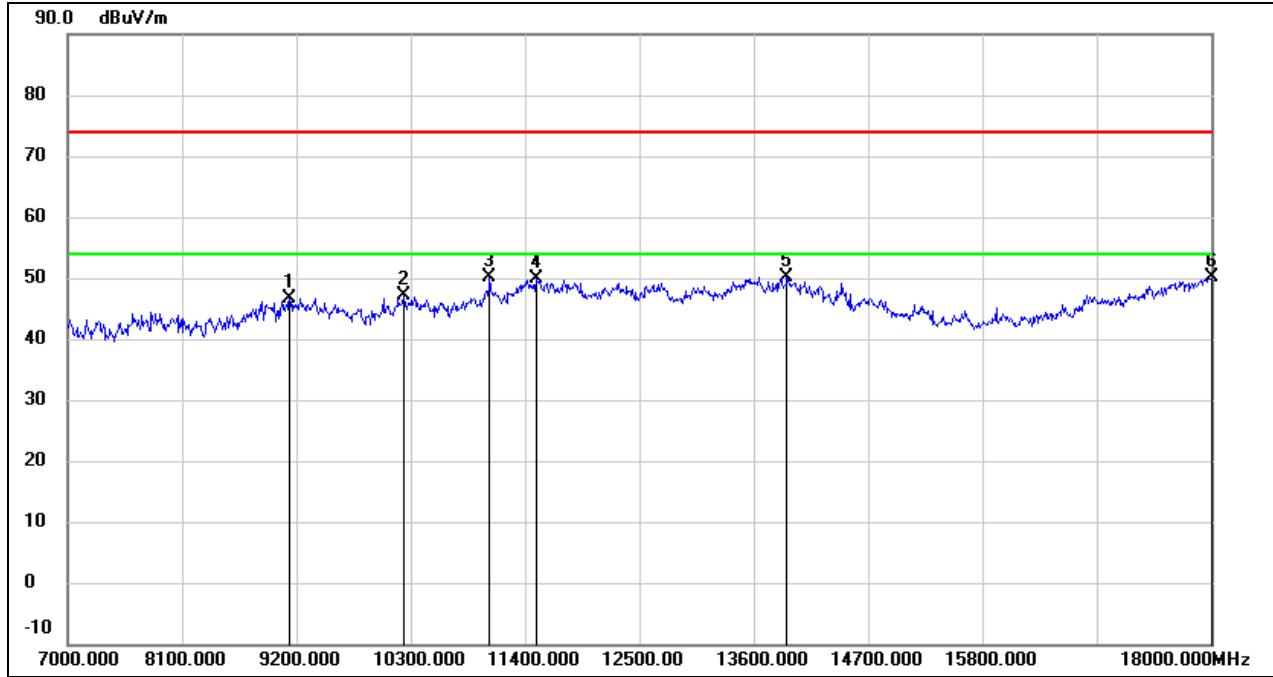

No.	Frequency (MHz)	Reading (dBuV)	Correct (dB/m)	Result (dBuV/m)	Limit (dBuV/m)	Margin (dB)	Remark
1	9134.000	36.28	10.41	46.69	74.00	-27.31	peak
2	10234.000	34.99	12.26	47.25	74.00	-26.75	peak
3	11059.000	35.20	14.96	50.16	74.00	-23.84	peak
4	11510.000	33.05	16.79	49.84	74.00	-24.16	peak
5	13919.000	28.47	21.68	50.15	74.00	-23.85	peak
6	18000.000	24.03	26.12	50.15	74.00	-23.85	peak



Test Mode:	802.11be EHT40	Channel:	5230
Polarity:	Vertical	Test Voltage:	DC 12 V

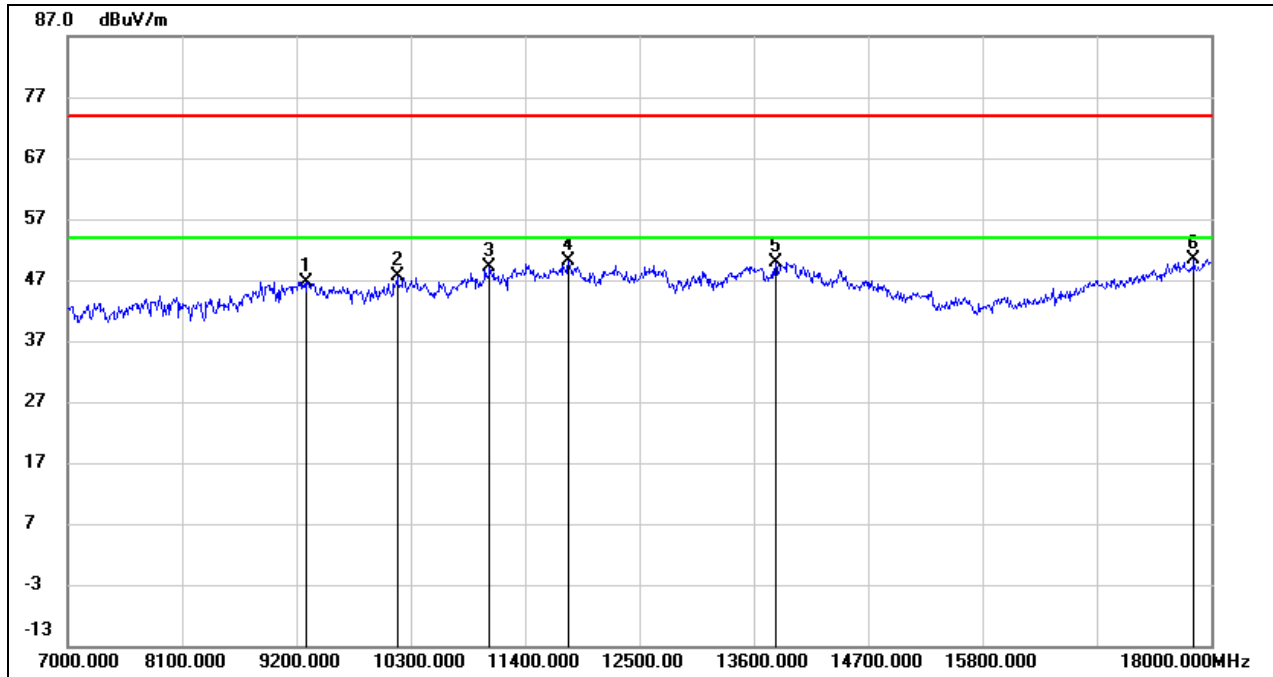

No.	Frequency (MHz)	Reading (dBuV)	Correct (dB/m)	Result (dBuV/m)	Limit (dBuV/m)	Margin (dB)	Remark
1	9299.000	36.18	10.53	46.71	74.00	-27.29	peak
2	10168.000	35.57	12.13	47.70	74.00	-26.30	peak
3	11059.000	34.05	14.96	49.01	74.00	-24.99	peak
4	11818.000	32.72	17.36	50.08	74.00	-23.92	peak
5	13809.000	28.59	21.41	50.00	74.00	-24.00	peak
6	17835.000	25.36	24.99	50.35	74.00	-23.65	peak



Test Mode:	802.11be EHT40	Channel:	5755
Polarity:	Horizontal	Test Voltage:	DC 12 V

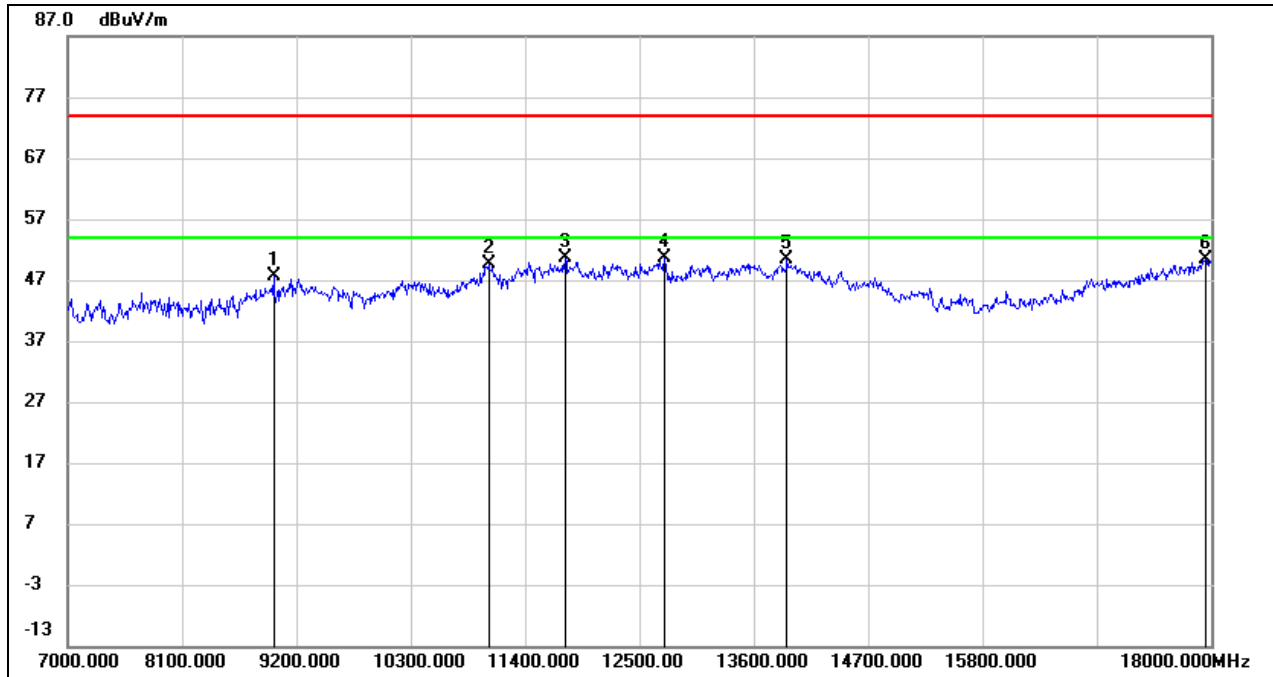

No.	Frequency (MHz)	Reading (dBuV)	Correct (dB/m)	Result (dBuV/m)	Limit (dBuV/m)	Margin (dB)	Remark
1	8980.000	37.42	10.21	47.63	74.00	-26.37	peak
2	11048.000	34.67	14.91	49.58	74.00	-24.42	peak
3	11785.000	33.22	17.30	50.52	74.00	-23.48	peak
4	12742.000	32.49	18.13	50.62	74.00	-23.38	peak
5	13919.000	28.66	21.68	50.34	74.00	-23.66	peak
6	17945.000	24.71	25.75	50.46	74.00	-23.54	peak



Test Mode:	802.11be EHT40	Channel:	5755
Polarity:	Vertical	Test Voltage:	DC 12 V

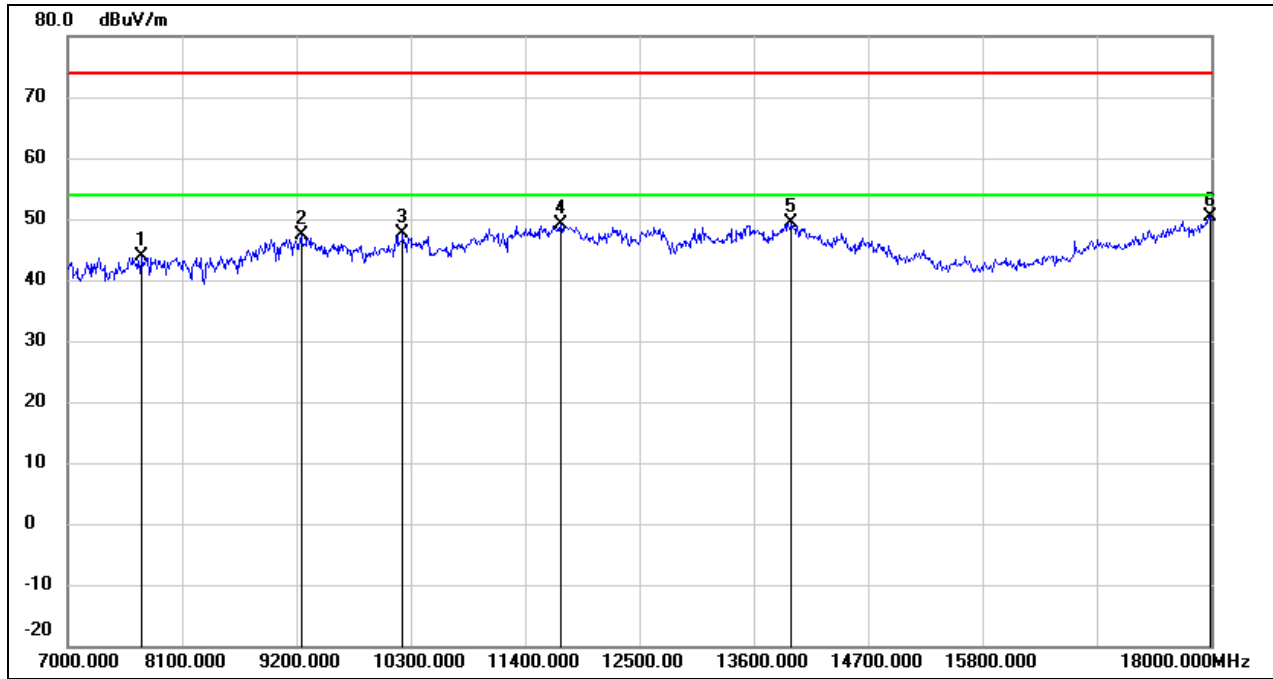

No.	Frequency (MHz)	Reading (dBuV)	Correct (dB/m)	Result (dBuV/m)	Limit (dBuV/m)	Margin (dB)	Remark
1	7715.000	37.24	6.68	43.92	74.00	-30.08	peak
2	9244.000	37.00	10.49	47.49	74.00	-26.51	peak
3	10223.000	35.37	12.24	47.61	74.00	-26.39	peak
4	11741.000	31.94	17.22	49.16	74.00	-24.84	peak
5	13963.000	27.49	21.78	49.27	74.00	-24.73	peak
6	17989.000	24.33	26.04	50.37	74.00	-23.63	peak



Test Mode:	802.11be EHT40	Channel:	5795
Polarity:	Horizontal	Test Voltage:	DC 12 V

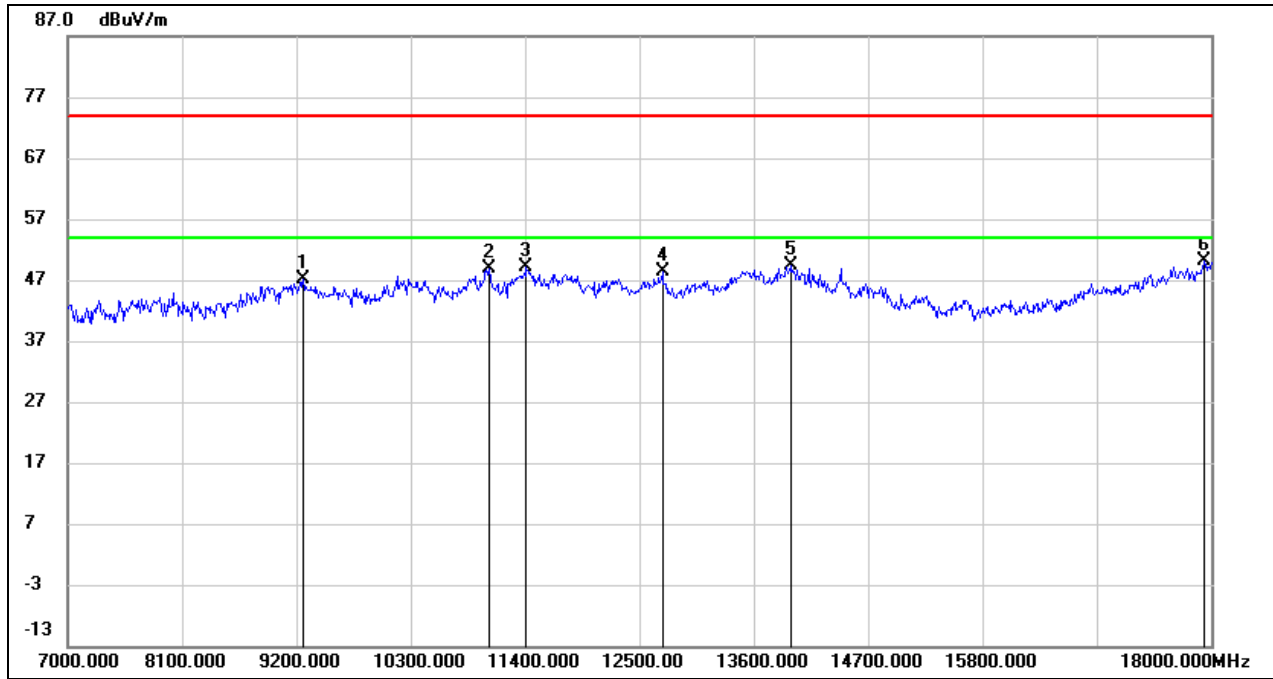

No.	Frequency (MHz)	Reading (dBuV)	Correct (dB/m)	Result (dBuV/m)	Limit (dBuV/m)	Margin (dB)	Remark
1	9266.000	36.51	10.51	47.02	74.00	-26.98	peak
2	11059.000	33.90	14.96	48.86	74.00	-25.14	peak
3	11411.000	32.64	16.41	49.05	74.00	-24.95	peak
4	12720.000	30.34	18.09	48.43	74.00	-25.57	peak
5	13963.000	27.62	21.78	49.40	74.00	-24.60	peak
6	17934.000	24.48	25.67	50.15	74.00	-23.85	peak



Test Mode:	802.11be EHT40	Channel:	5795
Polarity:	Vertical	Test Voltage:	DC 12 V

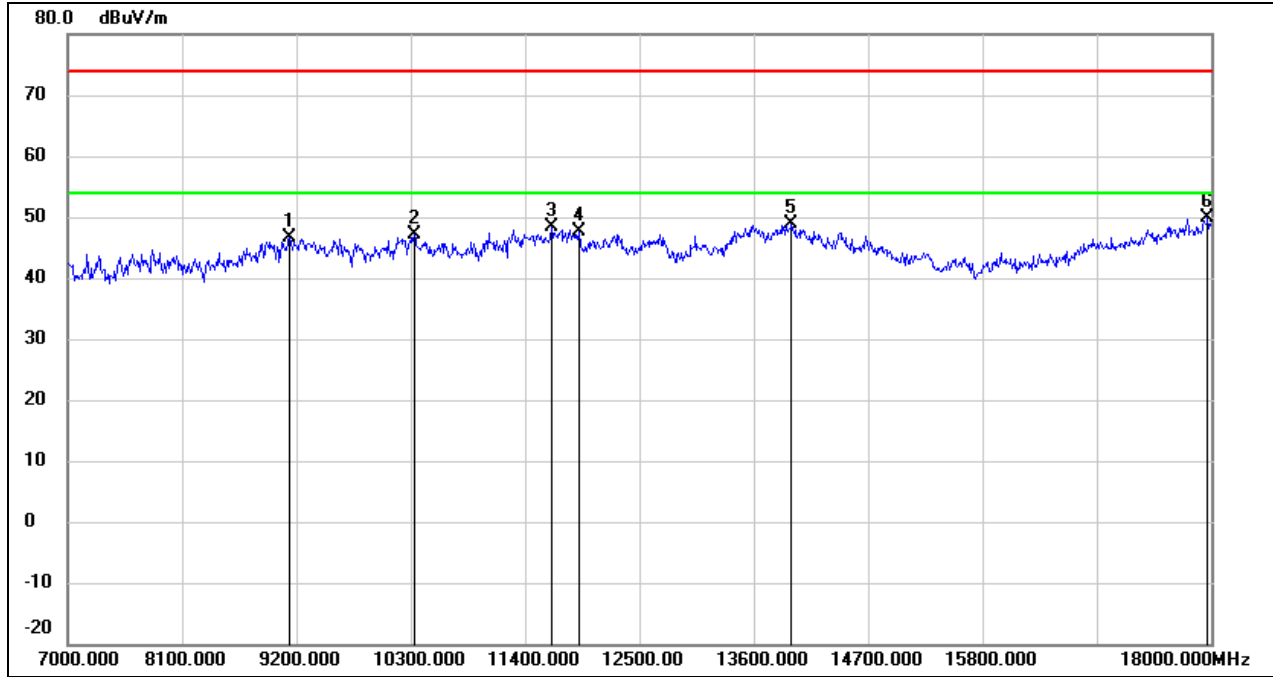

No.	Frequency (MHz)	Reading (dBuV)	Correct (dB/m)	Result (dBuV/m)	Limit (dBuV/m)	Margin (dB)	Remark
1	9134.000	36.18	10.41	46.59	74.00	-27.41	peak
2	10333.000	34.58	12.47	47.05	74.00	-26.95	peak
3	11653.000	31.43	17.05	48.48	74.00	-25.52	peak
4	11917.000	30.10	17.54	47.64	74.00	-26.36	peak
5	13963.000	27.00	21.78	48.78	74.00	-25.22	peak
6	17967.000	24.00	25.89	49.89	74.00	-24.11	peak



Test Mode:	802.11be EHT80	Channel:	5775
Polarity:	Horizontal	Test Voltage:	DC 12 V

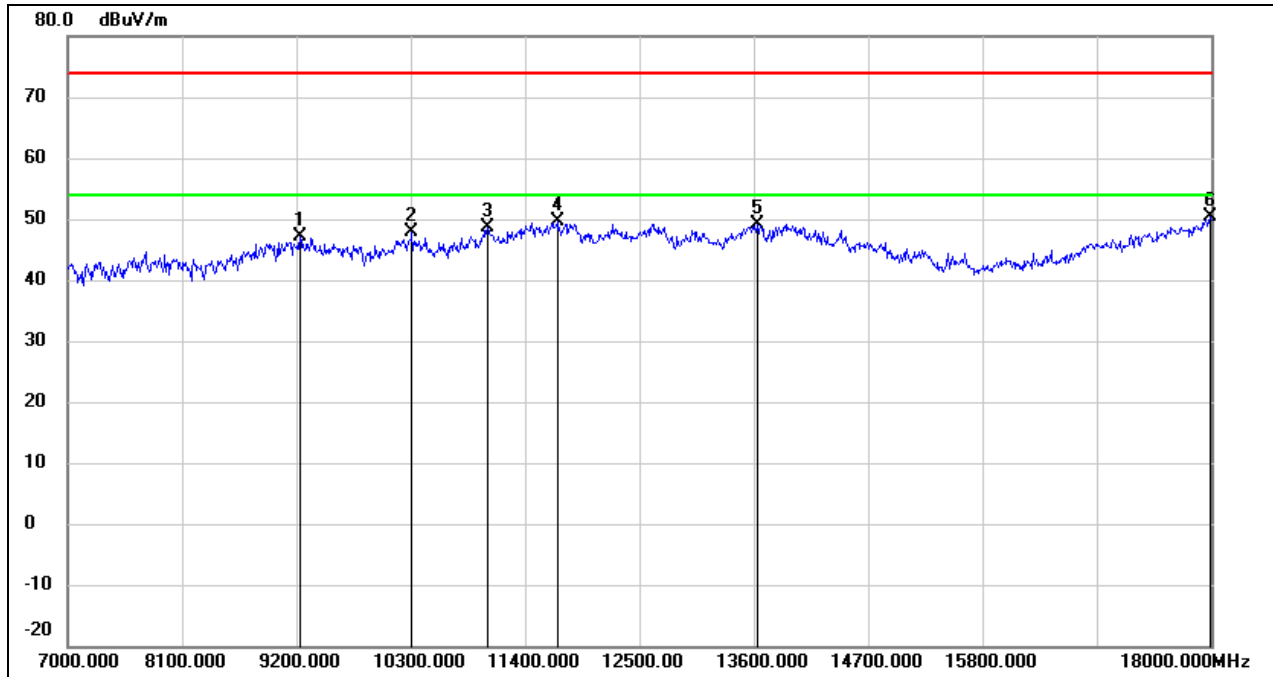

No.	Frequency (MHz)	Reading (dBuV)	Correct (dB/m)	Result (dBuV/m)	Limit (dBuV/m)	Margin (dB)	Remark
1	9233.000	36.53	10.48	47.01	74.00	-26.99	peak
2	10311.000	35.46	12.42	47.88	74.00	-26.12	peak
3	11037.000	33.82	14.87	48.69	74.00	-25.31	peak
4	11708.000	32.52	17.16	49.68	74.00	-24.32	peak
5	13633.000	28.25	20.97	49.22	74.00	-24.78	peak
6	17989.000	24.22	26.04	50.26	74.00	-23.74	peak





Test Mode:	802.11be EHT80	Channel:	5775
Polarity:	Vertical	Test Voltage:	DC 12 V

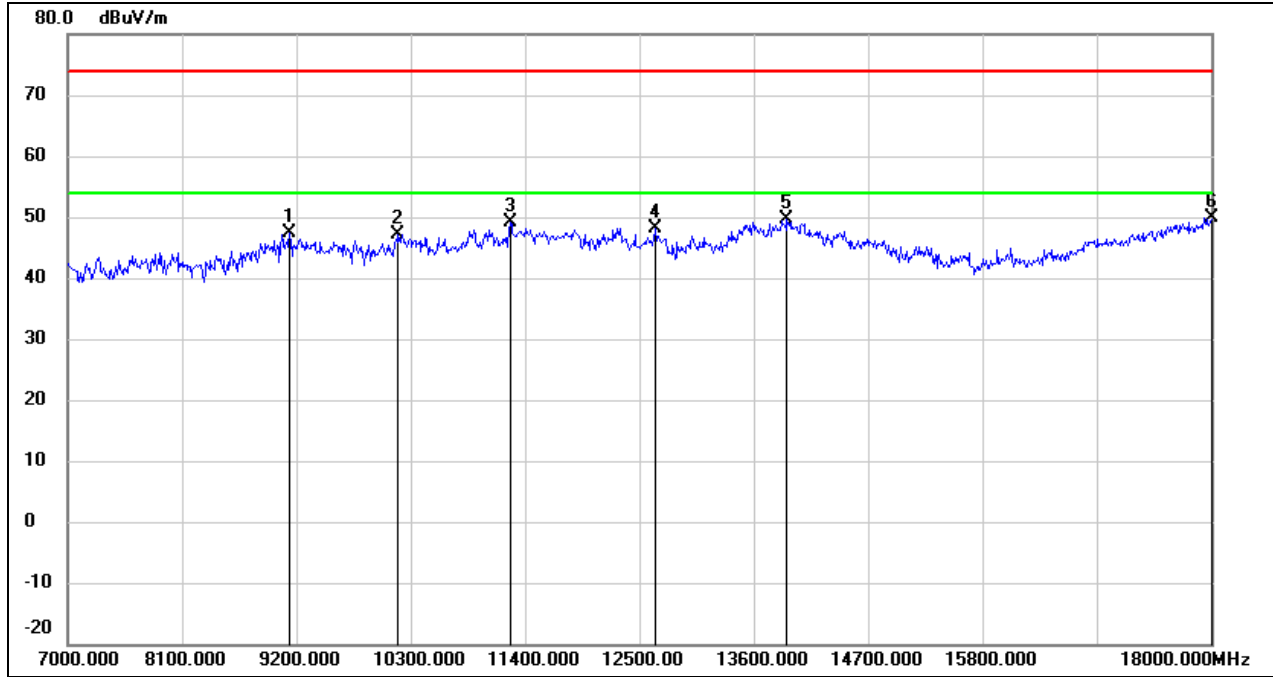

No.	Frequency (MHz)	Reading (dBuV)	Correct (dB/m)	Result (dBuV/m)	Limit (dBuV/m)	Margin (dB)	Remark
1	9134.000	36.91	10.41	47.32	74.00	-26.68	peak
2	10179.000	35.07	12.14	47.21	74.00	-26.79	peak
3	11257.000	33.45	15.78	49.23	74.00	-24.77	peak
4	12654.000	30.05	18.01	48.06	74.00	-25.94	peak
5	13919.000	27.95	21.68	49.63	74.00	-24.37	peak
6	18000.000	23.86	26.12	49.98	74.00	-24.02	peak



### 8.4. SPURIOUS EMISSIONS(9 KHZ~30 MHZ)

Test Mode:	802.11a20	Channel:	5180
Polarity:	Horizontal	Test Voltage:	DC 12 V

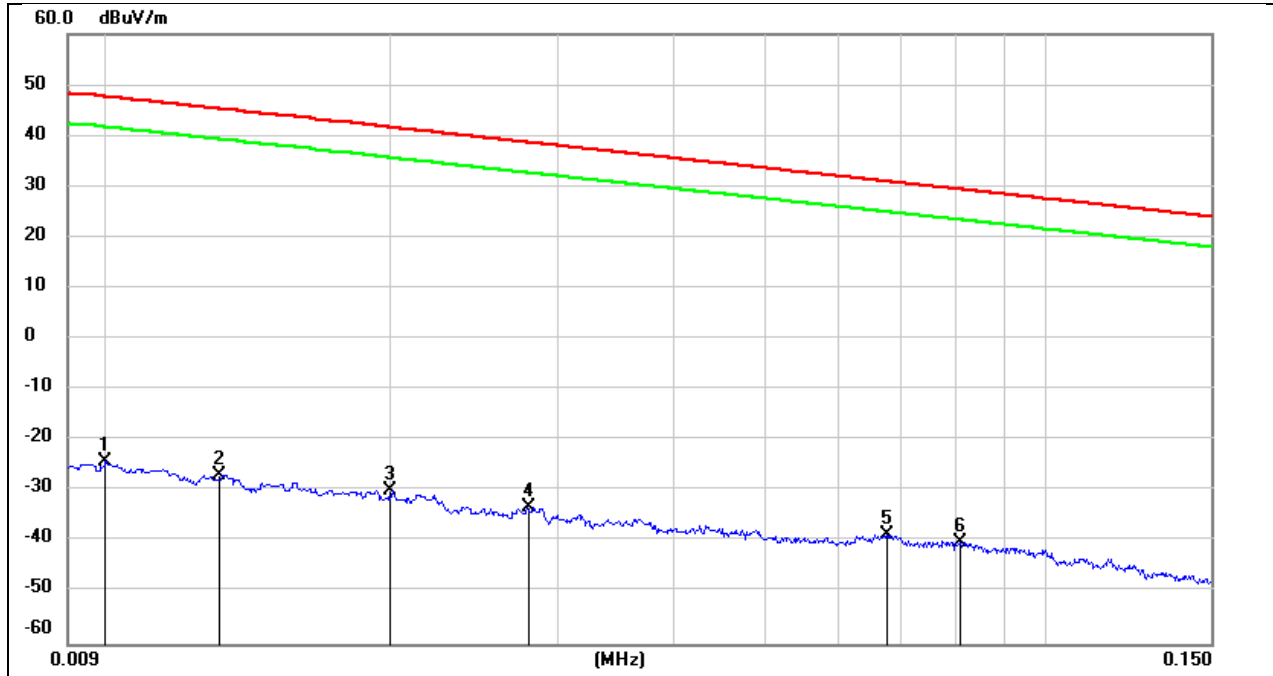

No.	Frequency (MHz)	Reading (dBuV)	Correct (dB/m)	FCC Result (dBuV/m)	FCC Limit (dBuV/m)	ISED Result (dBuA/m)	ISED Limit (dBuA/m)	Margin (dB)	Remark
1	0.0100	77.22	-101.40	-24.18	47.60	-75.68	-3.90	-71.78	peak
2	0.0131	74.47	-101.38	-26.91	45.25	-78.41	-6.25	-72.16	peak
3	0.0200	71.36	-101.34	-29.98	41.58	-81.48	-9.92	-71.56	peak
4	0.0280	68.29	-101.38	-33.09	38.66	-84.59	-12.84	-71.75	peak
5	0.0675	63.14	-101.56	-38.42	31.02	-89.92	-20.48	-69.44	peak
6	0.0806	61.68	-101.63	-39.95	29.47	-91.45	-22.03	-69.42	peak



Test Mode:	802.11a20	Channel:	5180
Polarity:	Horizontal	Test Voltage:	DC 12 V

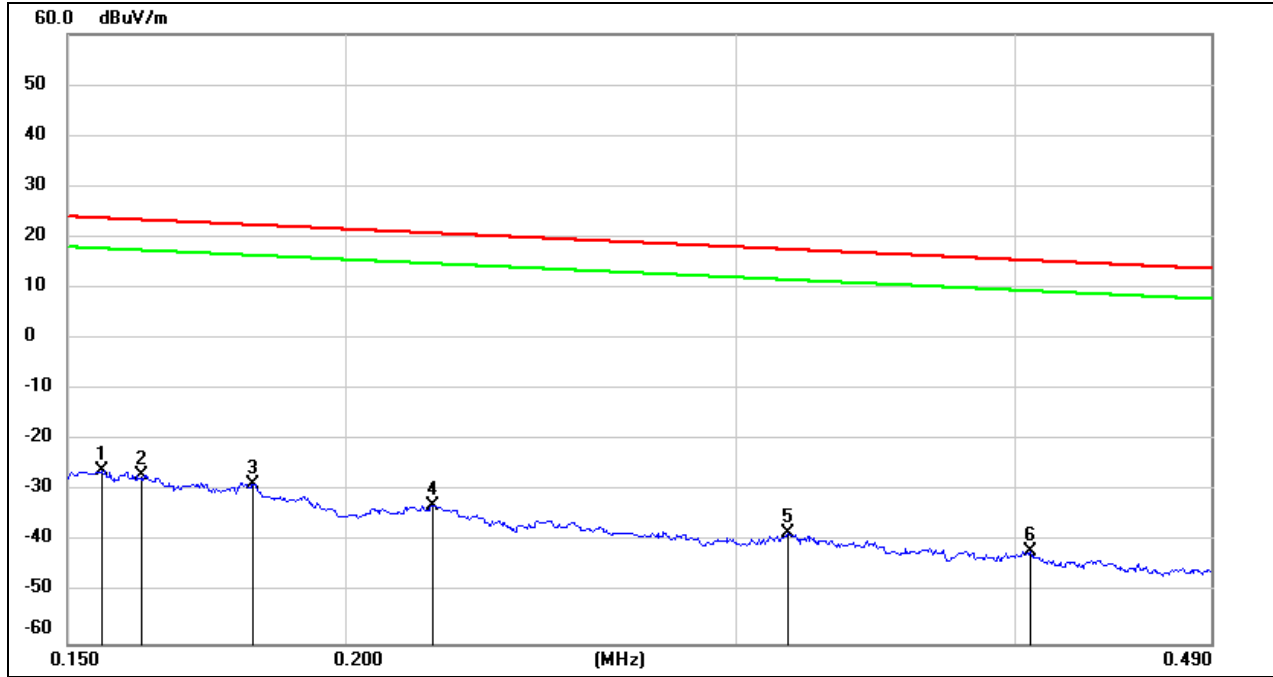

No.	Frequency (MHz)	Reading (dBuV)	Correct (dB/m)	FCC Result (dBuV/m)	FCC Limit (dBuV/m)	ISED Result (dBuA/m)	ISED Limit (dBuA/m)	Margin (dB)	Remark
1	0.1554	75.77	-101.65	-25.88	23.77	-77.38	-27.73	-49.65	peak
2	0.1621	74.92	-101.65	-26.73	23.41	-78.23	-28.09	-50.14	peak
3	0.1817	73.03	-101.68	-28.65	22.42	-80.15	-29.08	-51.07	peak
4	0.2190	68.77	-101.75	-32.98	20.79	-84.48	-30.71	-53.77	peak
5	0.3163	63.70	-101.87	-38.17	17.60	-89.67	-33.90	-55.77	peak
6	0.4062	60.14	-101.96	-41.82	15.43	-93.32	-36.07	-57.25	peak



Test Mode:	802.11a20	Channel:	5180
Polarity:	Horizontal	Test Voltage:	DC 12 V

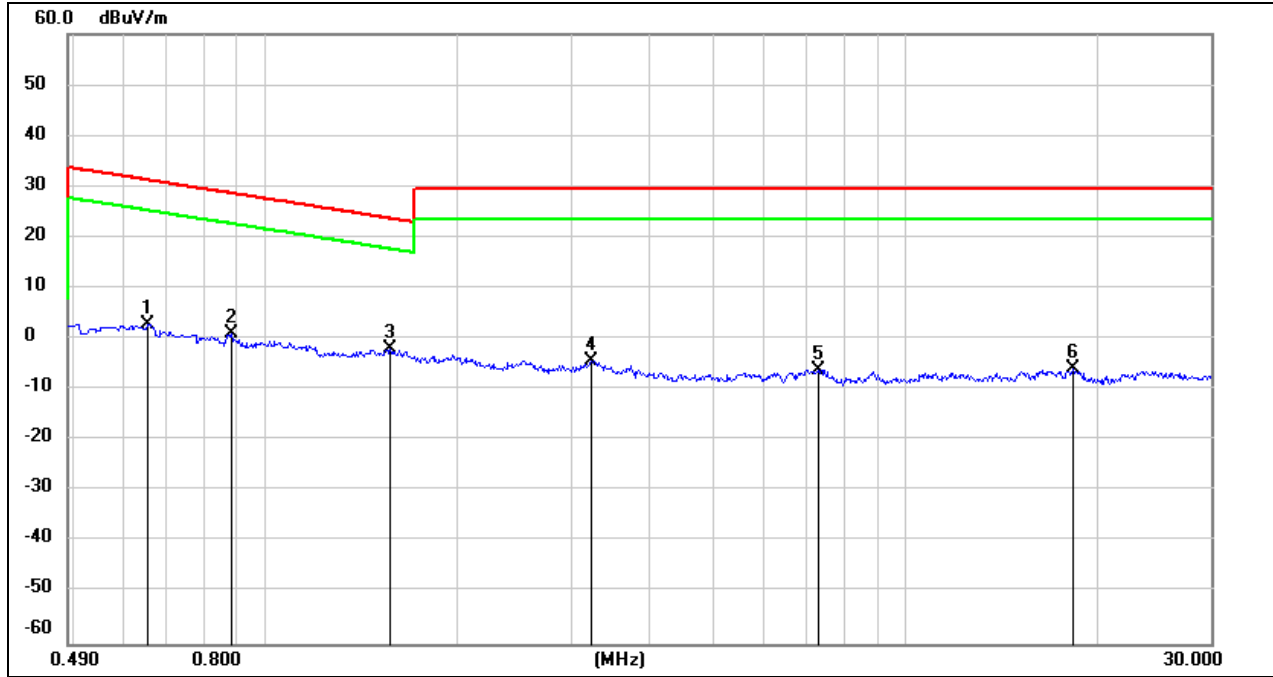

No.	Frequency (MHz)	Reading (dBuV)	Correct (dB/m)	FCC Result (dBuV/m)	FCC Limit (dBuV/m)	ISED Result (dBuA/m)	ISED Limit (dBuA/m)	Margin (dB)	Remark
1	0.6532	64.98	-62.10	2.88	31.30	-48.62	-20.20	-28.42	peak
2	0.8820	63.19	-62.19	1.00	28.69	-50.50	-22.81	-27.69	peak
3	1.5625	59.96	-62.02	-2.06	23.73	-53.56	-27.77	-25.79	peak
4	3.2343	57.29	-61.53	-4.24	29.54	-55.74	-21.96	-33.78	peak
5	7.3361	55.08	-61.17	-6.09	29.54	-57.59	-21.96	-35.63	peak
6	18.2545	54.93	-60.90	-5.97	29.54	-57.47	-21.96	-35.51	peak

**8.5. SPURIOUS EMISSIONS(18 GHZ~26 GHZ)**

Test Mode:	802.11a 20	Channel:	5180
Polarity:	Horizontal	Test Voltage:	DC 12 V

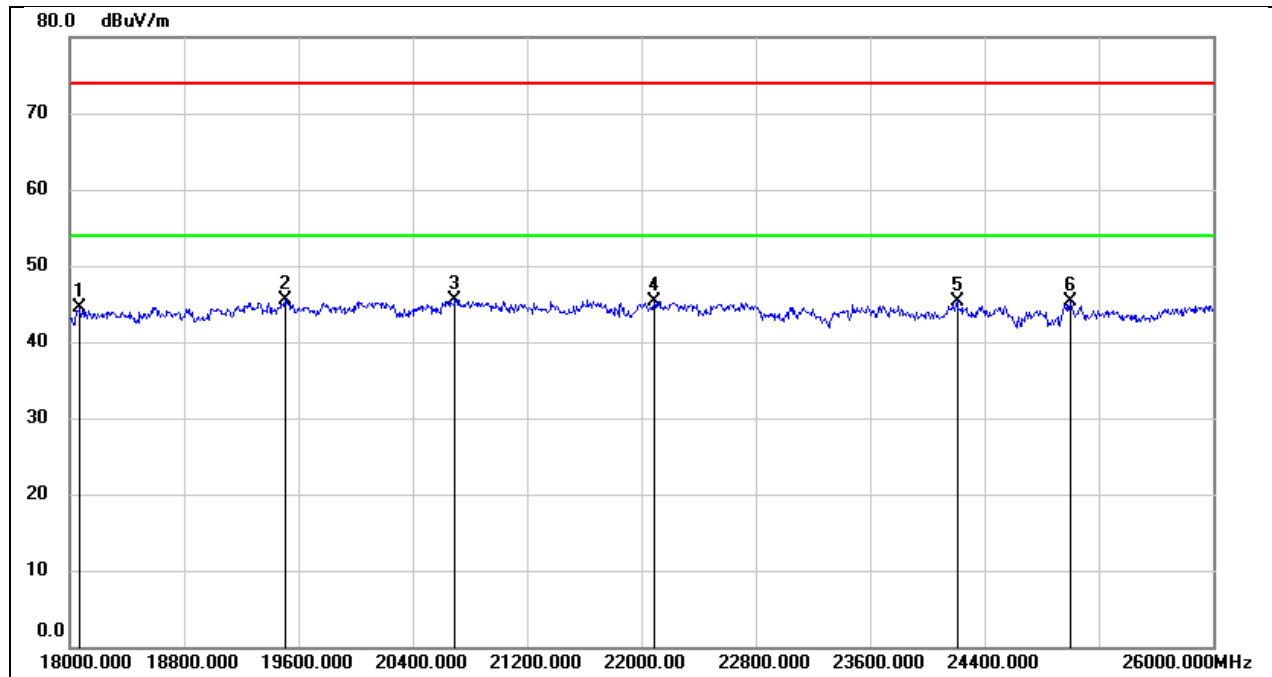

No.	Frequency (MHz)	Reading (dBuV)	Correct (dB/m)	Result (dBuV/m)	Limit (dBuV/m)	Margin (dB)	Remark
1	18072.000	49.95	-5.43	44.52	74.00	-29.48	peak
2	19504.000	50.97	-5.54	45.43	74.00	-28.57	peak
3	20696.000	50.71	-5.16	45.55	74.00	-28.45	peak
4	22088.000	49.66	-4.39	45.27	74.00	-28.73	peak
5	24208.000	48.21	-2.81	45.40	74.00	-28.60	peak
6	25000.000	47.36	-2.10	45.26	74.00	-28.74	peak



Test Mode:	802.11a 20	Channel:	5180
Polarity:	Vertical	Test Voltage:	DC 12 V

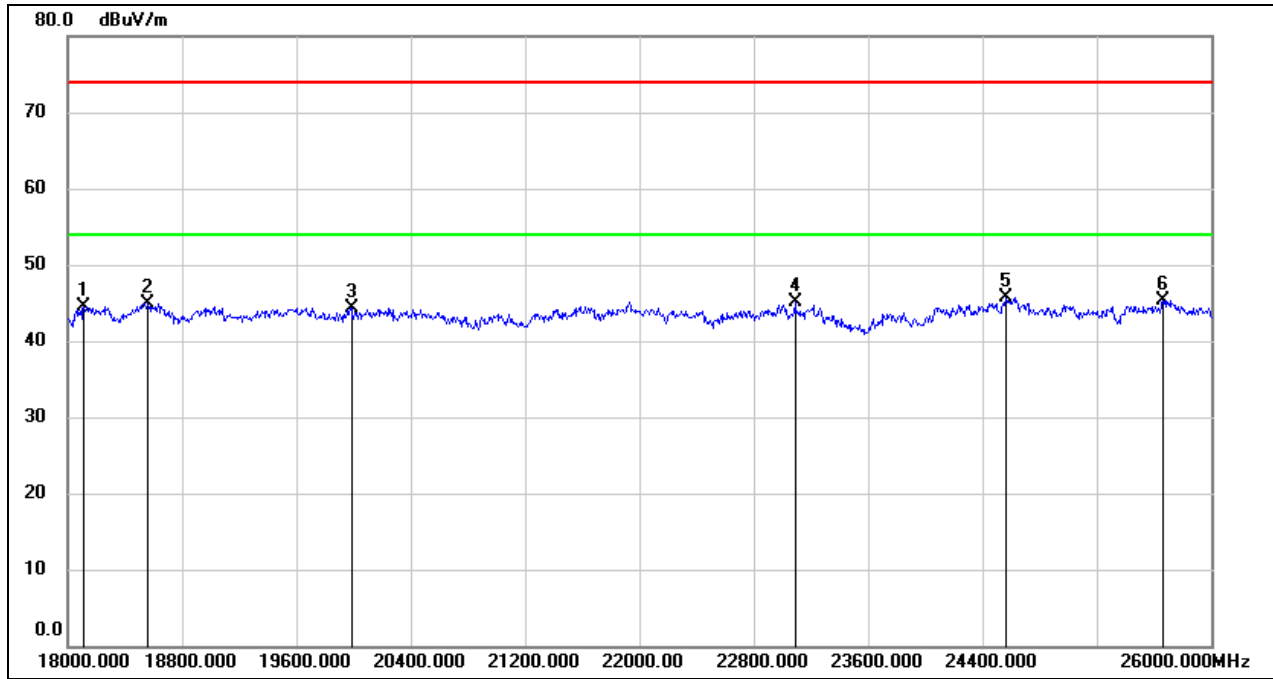

No.	Frequency (MHz)	Reading (dBuV)	Correct (dB/m)	Result (dBuV/m)	Limit (dBuV/m)	Margin (dB)	Remark
1	18112.000	49.96	-5.47	44.49	74.00	-29.51	peak
2	18560.000	50.14	-5.29	44.85	74.00	-29.15	peak
3	19984.000	49.71	-5.44	44.27	74.00	-29.73	peak
4	23088.000	48.52	-3.41	45.11	74.00	-28.89	peak
5	24568.000	48.10	-2.33	45.77	74.00	-28.23	peak
6	25664.000	46.39	-1.01	45.38	74.00	-28.62	peak



### 8.6. SPURIOUS EMISSIONS(26 GHZ~40 GHZ)

Test Mode:	802.11a 20	Channel:	5180
Polarity:	Horizontal	Test Voltage:	DC 12 V

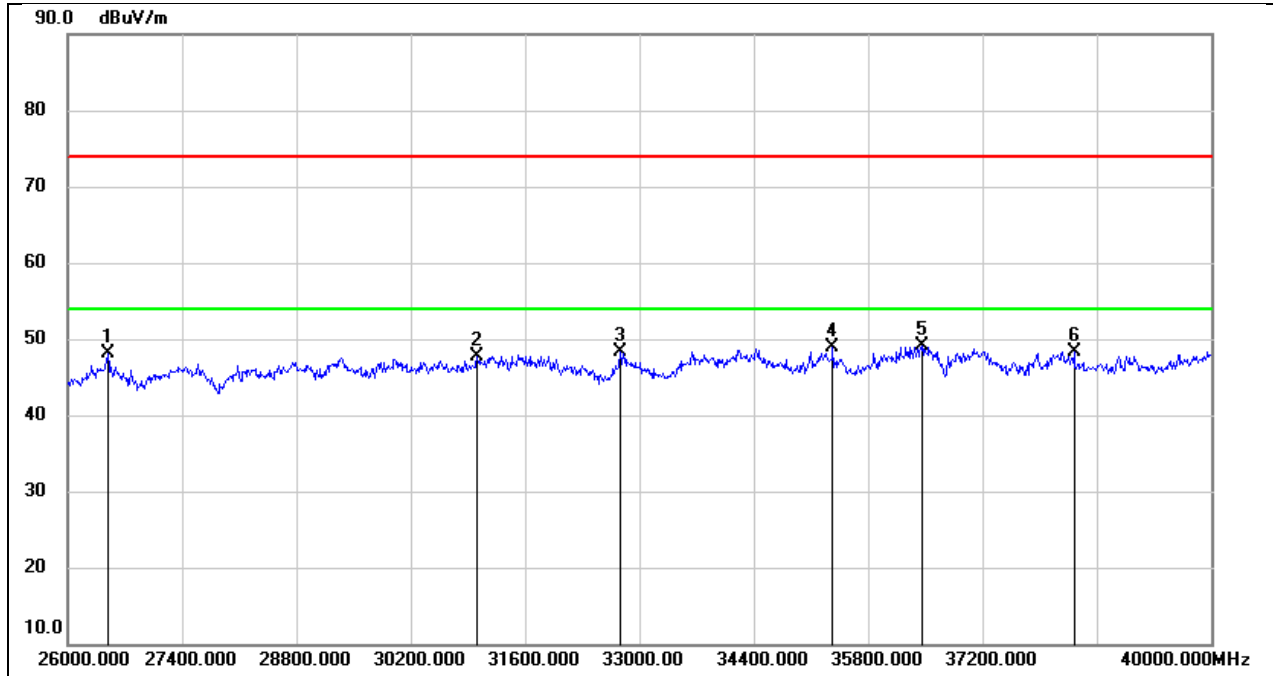

No.	Frequency (MHz)	Reading (dBuV)	Correct (dB/m)	Result (dBuV/m)	Limit (dBuV/m)	Margin (dB)	Remark
1	26490.000	52.79	-4.74	48.05	74.00	-25.95	peak
2	31012.000	48.33	-0.71	47.62	74.00	-26.38	peak
3	32762.000	49.45	-1.21	48.24	74.00	-25.76	peak
4	35366.000	46.40	2.59	48.99	74.00	-25.01	peak
5	36458.000	45.38	3.67	49.05	74.00	-24.95	peak
6	38320.000	44.56	3.77	48.33	74.00	-25.67	peak



Test Mode:	802.11a 20	Channel:	5180
Polarity:	Vertical	Test Voltage:	DC 12 V

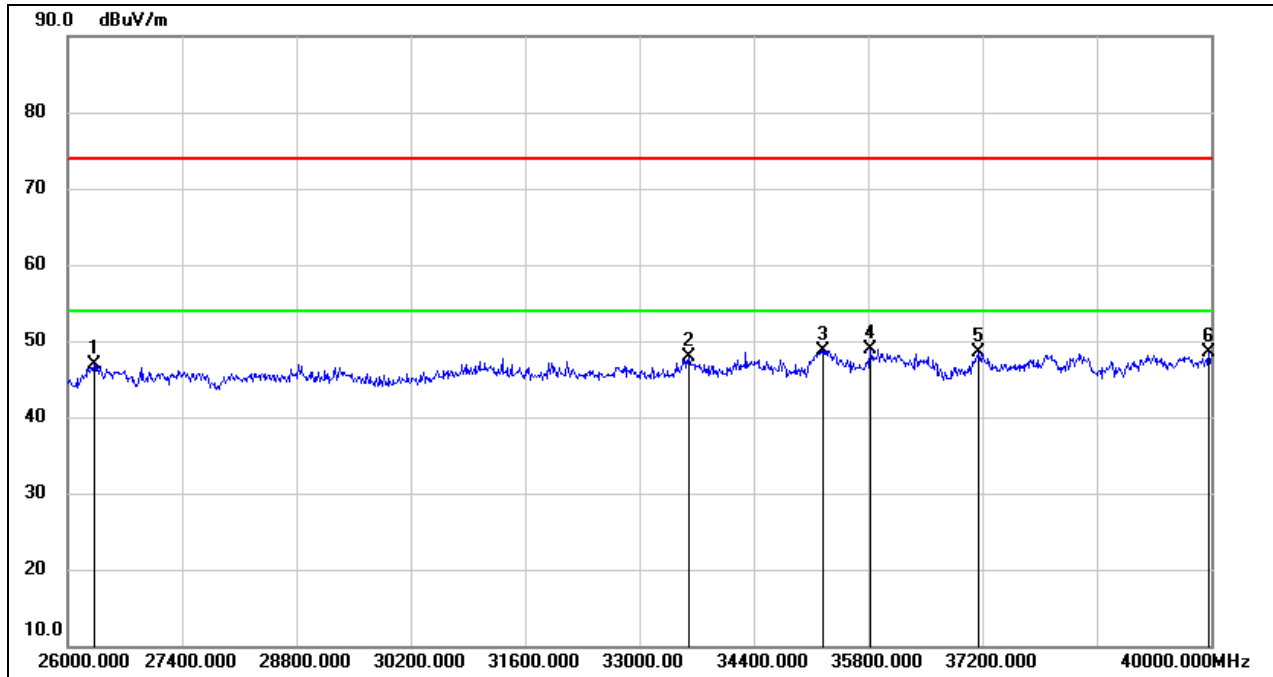

No.	Frequency (MHz)	Reading (dBuV)	Correct (dB/m)	Result (dBuV/m)	Limit (dBuV/m)	Margin (dB)	Remark
1	26322.000	52.12	-5.18	46.94	74.00	-27.06	peak
2	33602.000	47.51	0.46	47.97	74.00	-26.03	peak
3	35254.000	46.12	2.65	48.77	74.00	-25.23	peak
4	35828.000	45.25	3.67	48.92	74.00	-25.08	peak
5	37158.000	45.34	3.17	48.51	74.00	-25.49	peak
6	39972.000	43.45	5.13	48.58	74.00	-25.42	peak





### 8.7. SPURIOUS EMISSIONS(30 MHZ~1 GHZ)

Test Mode:	802.11a 20	Channel:	5180
Polarity:	Horizontal	Test Voltage:	DC 12 V

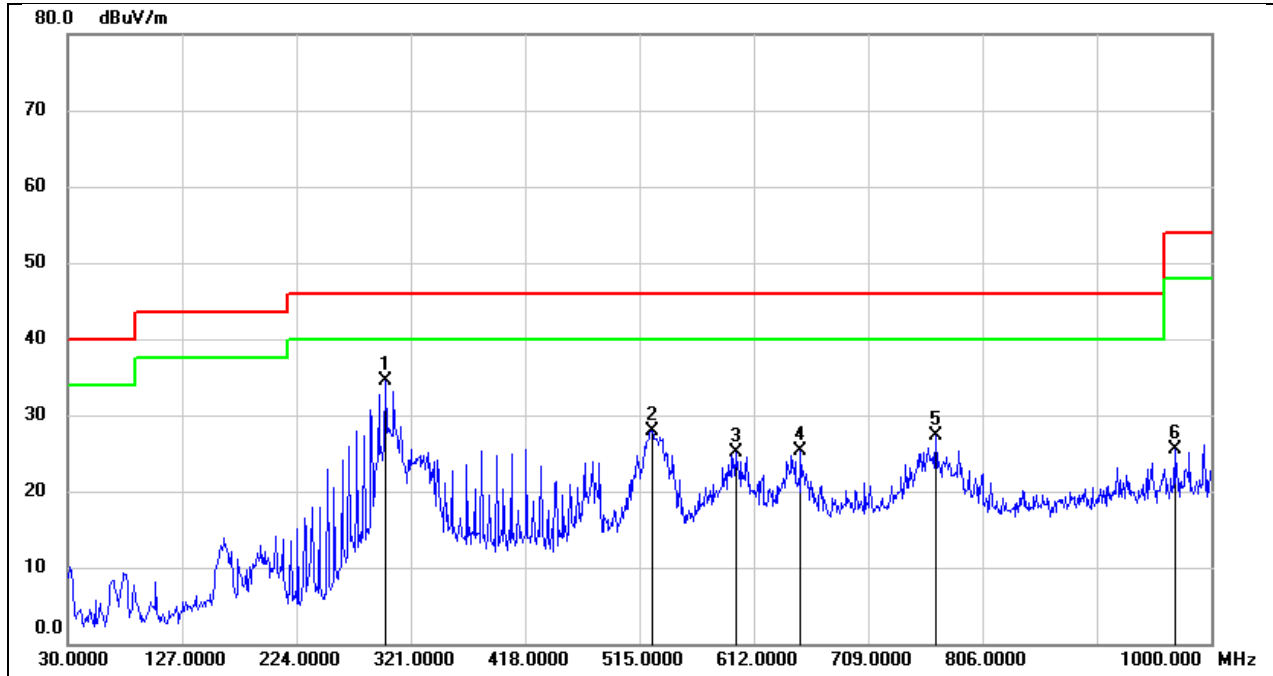

No.	Frequency (MHz)	Reading (dBuV)	Correct (dB/m)	Result (dBuV/m)	Limit (dBuV/m)	Margin (dB)	Remark
1	299.6600	49.80	-15.32	34.48	46.00	-11.52	QP
2	525.6700	38.88	-10.93	27.95	46.00	-18.05	QP
3	596.4800	34.77	-9.64	25.13	46.00	-20.87	QP
4	651.7700	34.21	-8.99	25.22	46.00	-20.78	QP
5	766.2300	35.02	-7.64	27.38	46.00	-18.62	QP
6	968.9600	29.90	-4.42	25.48	54.00	-28.52	QP



Test Mode:	802.11a 20	Channel:	5180
Polarity:	Vertical	Test Voltage:	DC 12 V

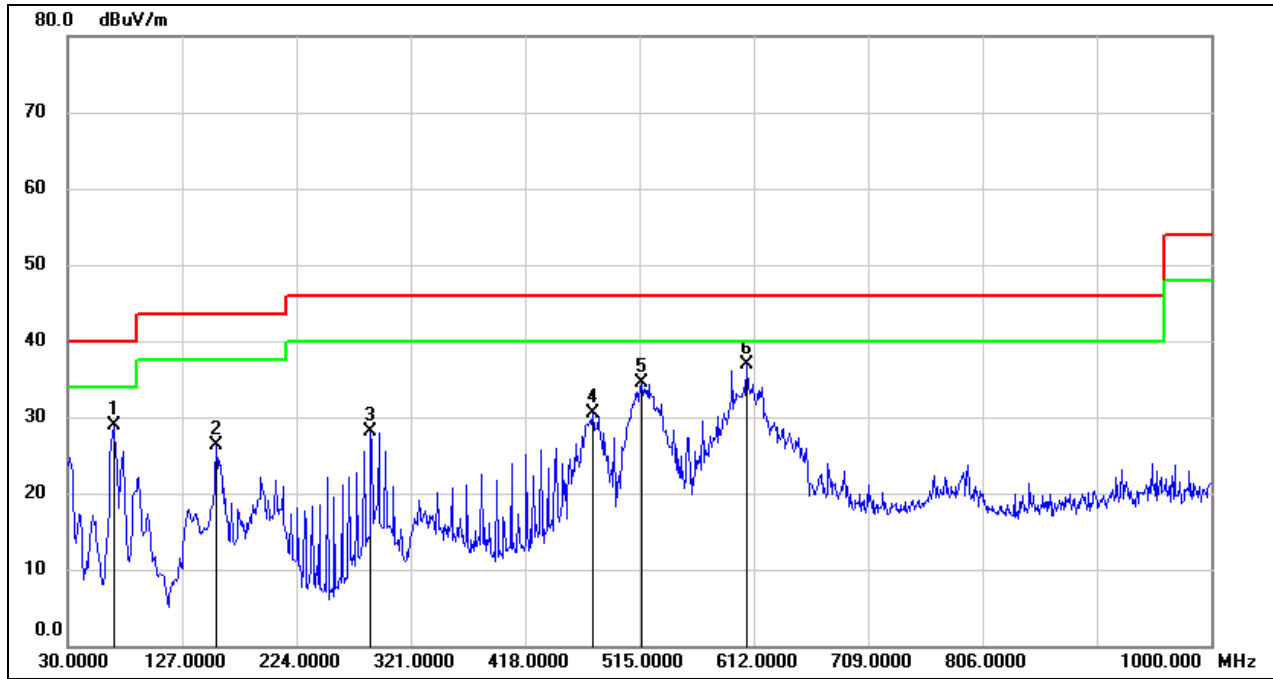

No.	Frequency (MHz)	Reading (dBuV)	Correct (dB/m)	Result (dBuV/m)	Limit (dBuV/m)	Margin (dB)	Remark
1	68.8000	49.51	-20.56	28.95	40.00	-11.05	QP
2	156.1000	44.19	-17.96	26.23	43.50	-17.27	QP
3	287.0500	44.15	-16.14	28.01	46.00	-17.99	QP
4	475.2300	42.38	-11.90	30.48	46.00	-15.52	QP
5	516.9400	45.58	-11.13	34.45	46.00	-11.55	QP
6	606.1800	46.28	-9.45	36.83	46.00	-9.17	QP

## 9. AC POWER LINE CONDUCTED EMISSION

### LIMITS

Please refer to CFR 47 FCC §15.207 (a) and ISED RSS-Gen Clause 8.8

FREQUENCY (MHz)	Quasi-peak	Average
0.15 -0.5	66 - 56 *	56 - 46 *
0.50 -5.0	56.00	46.00
5.0 -30.0	60.00	50.00

### TEST PROCEDURE

Refer to ANSI C63.10-2013 clause 6.2.

The EUT is put on a table of non-conducting material that is 80 cm high. The vertical conducting wall of shielding is located 40 cm to the rear of the EUT. The power line of the EUT is connected to the AC mains through a Artificial Mains Network (A.M.N.). A EMI Measurement Receiver (R&S Test Receiver ESR3) is used to test the emissions from both sides of AC line. According to the requirements in Section 6.2 of ANSI C63.10-2013. Conducted emissions from the EUT measured in the frequency range between 0.15 MHz and 30 MHz using CISPR Quasi-Peak and average detector mode. The bandwidth of EMI test receiver is set at 9 kHz.

The arrangement of the equipment is installed to meet the standards and operating in a manner, which tends to maximize its emission characteristics in a normal application.

### TEST SETUP

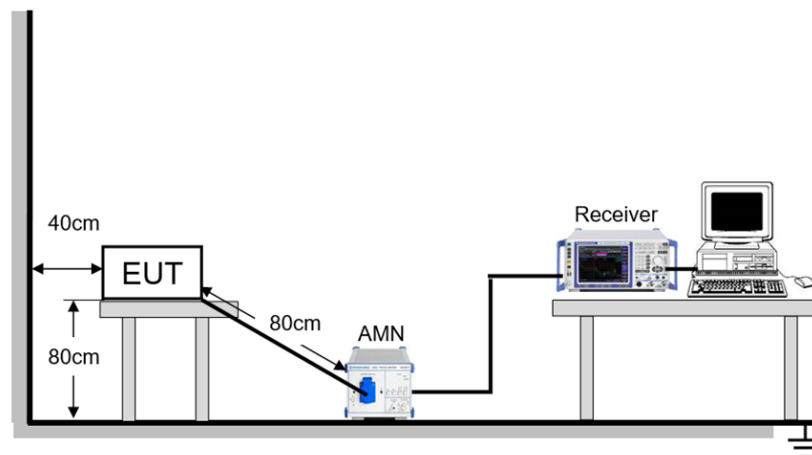



**TEST ENVIRONMENT**

Temperature	22.8°C	Relative Humidity	55.5%
Atmosphere Pressure	101kPa	Test Voltage	AC 120 V, 60 Hz

**TEST DATE / ENGINEER**

Test Date	February 21, 2023	Test By	Wite Chen
-----------	-------------------	---------	-----------



**TEST RESULTS**

Test Mode:	802.11a20	Channel:	5180
Line:	Line	Test Voltage:	AC 120 V, 60 Hz

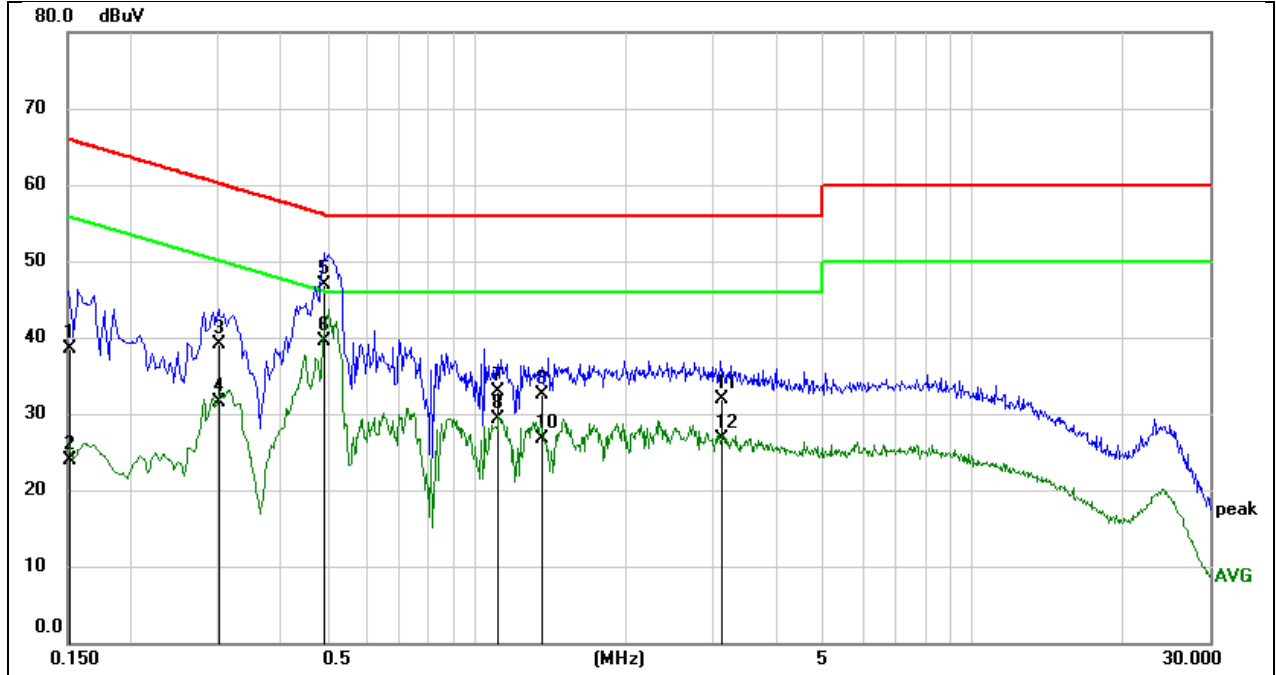

No.	Frequency (MHz)	Reading (dBuV)	Correct (dB)	Result (dBuV)	Limit (dBuV)	Margin (dB)	Remark
1	0.1516	28.96	9.59	38.55	65.91	-27.36	QP
2	0.1516	14.27	9.59	23.86	55.91	-32.05	AVG
3	0.3050	29.60	9.59	39.19	60.11	-20.92	QP
4	0.3050	22.00	9.59	31.59	50.11	-18.52	AVG
5	0.4942	37.30	9.60	46.90	56.10	-9.20	QP
6	0.4942	29.92	9.60	39.52	46.10	-6.58	AVG
7	1.1090	23.32	9.61	32.93	56.00	-23.07	QP
8	1.1090	19.69	9.61	29.30	46.00	-16.70	AVG
9	1.3596	22.97	9.61	32.58	56.00	-23.42	QP
10	1.3596	17.13	9.61	26.74	46.00	-19.26	AVG
11	3.1171	22.14	9.68	31.82	56.00	-24.18	QP
12	3.1171	17.11	9.68	26.79	46.00	-19.21	AVG

Note:

1. Result = Reading + Correct Factor.
2. If QP Result complies with AV limit, AV Result is deemed to comply with AV limit.
3. Test setup: RBW: 200 Hz (9 kHz ~ 150 kHz), 9 kHz (150 kHz ~ 30 MHz).
4. Step size: 80 Hz (0.009 MHz ~ 0.15 MHz), 4 kHz (0.15 MHz ~ 30 MHz), Scan time: auto.

Note: All the modes have been tested, only the worst data was recorded in the report.



Test Mode:	802.11a20	Channel:	5180
Line:	Neutral	Test Voltage:	AC 120 V, 60 Hz

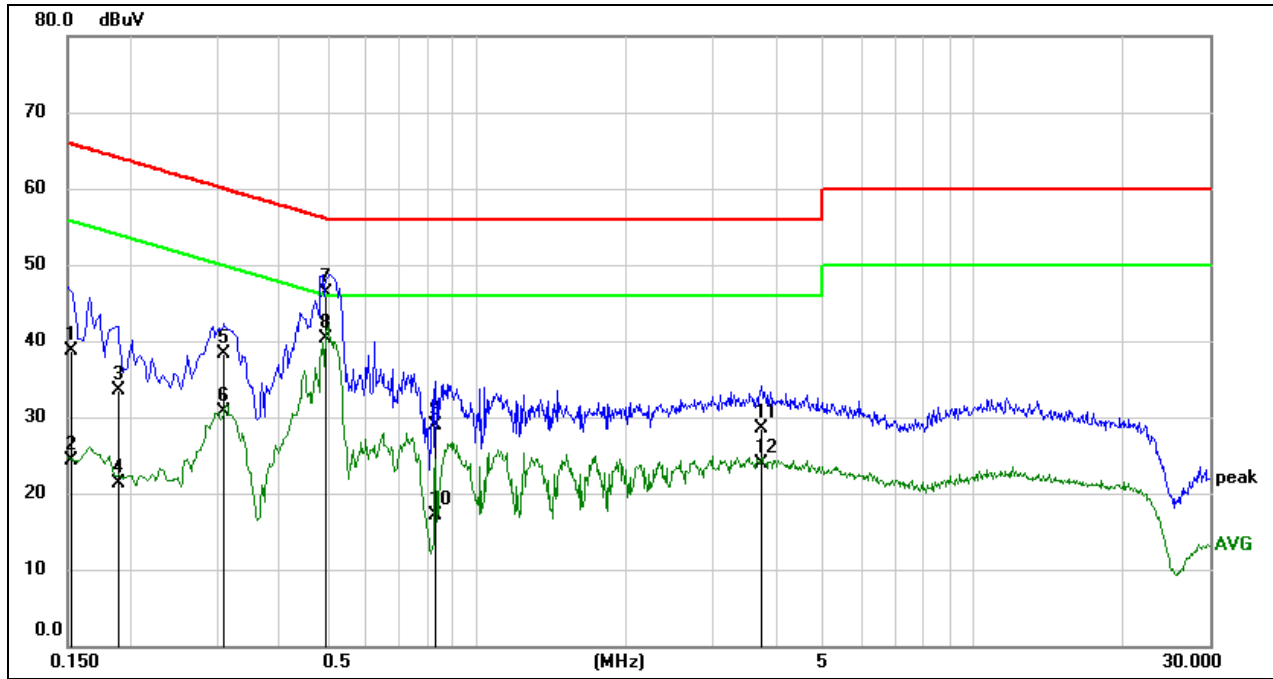

No.	Frequency (MHz)	Reading (dBuV)	Correct (dB)	Result (dBuV)	Limit (dBuV)	Margin (dB)	Remark
1	0.1531	29.09	9.59	38.68	65.83	-27.15	QP
2	0.1531	14.62	9.59	24.21	55.83	-31.62	AVG
3	0.1907	23.87	9.59	33.46	64.01	-30.55	QP
4	0.1907	11.70	9.59	21.29	54.01	-32.72	AVG
5	0.3109	28.69	9.59	38.28	59.95	-21.67	QP
6	0.3109	21.14	9.59	30.73	49.95	-19.22	AVG
7	0.4969	36.79	9.60	46.39	56.05	-9.66	QP
8	0.4969	30.68	9.60	40.28	46.05	-5.77	AVG
9	0.8276	19.28	9.60	28.88	56.00	-27.12	QP
10	0.8276	7.58	9.60	17.18	46.00	-28.82	AVG
11	3.7582	18.82	9.70	28.52	56.00	-27.48	QP
12	3.7582	14.11	9.70	23.81	46.00	-22.19	AVG

Note:

1. Result = Reading + Correct Factor.
2. If QP Result complies with AV limit, AV Result is deemed to comply with AV limit.
3. Test setup: RBW: 200 Hz (9 kHz ~ 150 kHz), 9 kHz (150 kHz ~ 30 MHz).
4. Step size: 80 Hz (0.009 MHz ~ 0.15 MHz), 4 kHz (0.15 MHz ~ 30 MHz), Scan time: auto.

Note: All the modes have been tested, only the worst data was recorded in the report.



## 10. ANTENNA REQUIREMENT

### REQUIREMENT

Please refer to FCC part 15.203

An intentional radiator shall be designed to ensure that no antenna other than that furnished by the responsible party shall be used with the device. The use of a permanently attached antenna or of an antenna that uses a unique coupling to the intentional radiator shall be considered sufficient to comply with the provisions of this section. The manufacturer may design the unit so that a broken antenna can be replaced by the user, but the use of a standard antenna jack or electrical connector is prohibited.

Please refer to FCC part 15.247(b)(4)

The conducted output power limit specified in paragraph (b) of this section is based on the use of antennas with directional gains that do not exceed 6 dBi. Except as shown in paragraph (c) of this section, if transmitting antennas of directional gain greater than 6 dBi are used, the conducted output power from the intentional radiator shall be reduced below the stated values in paragraphs (b)(1), (b)(2), and (b)(3) of this section, as appropriate, by the amount in dB that the directional gain of the antenna exceeds 6 dBi.

### DESCRIPTION

Pass



## 11. TEST DATA

### 11.1. APPENDIX A: EMISSION BANDWIDTH

#### 11.1.1. Test Result

Test Mode	Antenna	Channel	26db EBW [MHz]	FL[MHz]	FH[MHz]	Verdict
11A-CDD	Ant1	5180	21.600	5169.040	5190.640	PASS
	Ant3	5180	22.440	5168.440	5190.880	PASS
	Ant1	5200	22.200	5189.080	5211.280	PASS
	Ant3	5200	21.920	5189.200	5211.120	PASS
	Ant1	5240	21.960	5228.800	5250.760	PASS
	Ant3	5240	22.760	5228.200	5250.960	PASS
	Ant1	5745	21.640	5734.000	5755.640	PASS
	Ant3	5745	22.000	5734.040	5756.040	PASS
	Ant1	5785	20.920	5774.600	5795.520	PASS
	Ant3	5785	21.800	5774.200	5796.000	PASS
	Ant1	5825	21.920	5813.960	5835.880	PASS
Ant3	5825	23.680	5813.680	5837.360	PASS	
11AX20MIMO	Ant1	5180	22.320	5168.720	5191.040	PASS
	Ant3	5180	21.720	5169.080	5190.800	PASS
	Ant1	5200	21.160	5189.400	5210.560	PASS
	Ant3	5200	21.880	5189.000	5210.880	PASS
	Ant1	5240	22.040	5228.840	5250.880	PASS
	Ant3	5240	21.280	5229.280	5250.560	PASS
	Ant1	5745	20.560	5734.800	5755.360	PASS
	Ant3	5745	21.080	5734.680	5755.760	PASS
	Ant1	5785	21.720	5774.080	5795.800	PASS
	Ant3	5785	20.800	5774.520	5795.320	PASS
	Ant1	5825	20.960	5814.200	5835.160	PASS
Ant3	5825	21.560	5814.440	5836.000	PASS	
11AX40MIMO	Ant1	5190	41.280	5169.200	5210.480	PASS
	Ant3	5190	42.160	5169.120	5211.280	PASS
	Ant1	5230	41.520	5208.720	5250.240	PASS
	Ant3	5230	41.600	5208.720	5250.320	PASS
	Ant1	5755	42.000	5733.880	5775.880	PASS
	Ant3	5755	41.840	5734.200	5776.040	PASS
	Ant1	5795	42.080	5773.880	5815.960	PASS
	Ant3	5795	42.000	5773.720	5815.720	PASS
11AX80MIMO	Ant1	5210	86.240	5166.000	5252.240	PASS
	Ant3	5210	88.640	5166.320	5254.960	PASS
	Ant1	5775	85.440	5731.640	5817.080	PASS
	Ant3	5775	85.440	5731.640	5817.080	PASS
11BE20MIMO	Ant1	5180	22.120	5169.040	5191.160	PASS
	Ant3	5180	22.800	5168.520	5191.320	PASS
	Ant1	5200	22.280	5189.080	5211.360	PASS
	Ant3	5200	22.000	5189.080	5211.080	PASS
	Ant1	5240	21.960	5228.960	5250.920	PASS
	Ant3	5240	22.640	5228.800	5251.440	PASS
	Ant1	5745	21.840	5733.880	5755.720	PASS
	Ant3	5745	22.280	5734.200	5756.480	PASS
	Ant1	5785	22.880	5773.720	5796.600	PASS
	Ant3	5785	22.560	5773.720	5796.280	PASS
	Ant1	5825	22.200	5813.920	5836.120	PASS
Ant3	5825	22.160	5813.680	5835.840	PASS	
11BE40MIMO	Ant1	5190	43.200	5168.320	5211.520	PASS
	Ant3	5190	44.000	5167.840	5211.840	PASS
	Ant1	5230	43.280	5208.480	5251.760	PASS
	Ant3	5230	43.920	5208.320	5252.240	PASS
	Ant1	5755	42.400	5733.720	5776.120	PASS
	Ant3	5755	44.080	5732.680	5776.760	PASS
11BE40MIMO	Ant1	5795	43.600	5773.000	5816.600	PASS





	Ant3	5795	43.760	5773.400	5817.160	PASS
11BE80MIMO	Ant1	5210	88.960	5165.520	5254.480	PASS
	Ant3	5210	87.360	5166.480	5253.840	PASS
	Ant1	5775	86.560	5731.320	5817.880	PASS
	Ant3	5775	88.800	5730.840	5819.640	PASS

### 11.1.2. Test Graphs



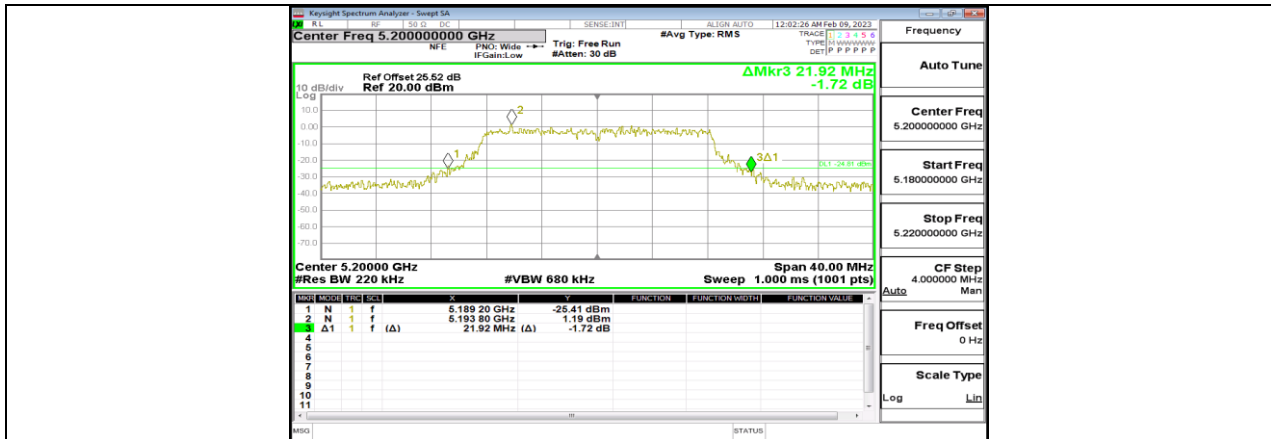

11A-CDD\_Ant3\_5200

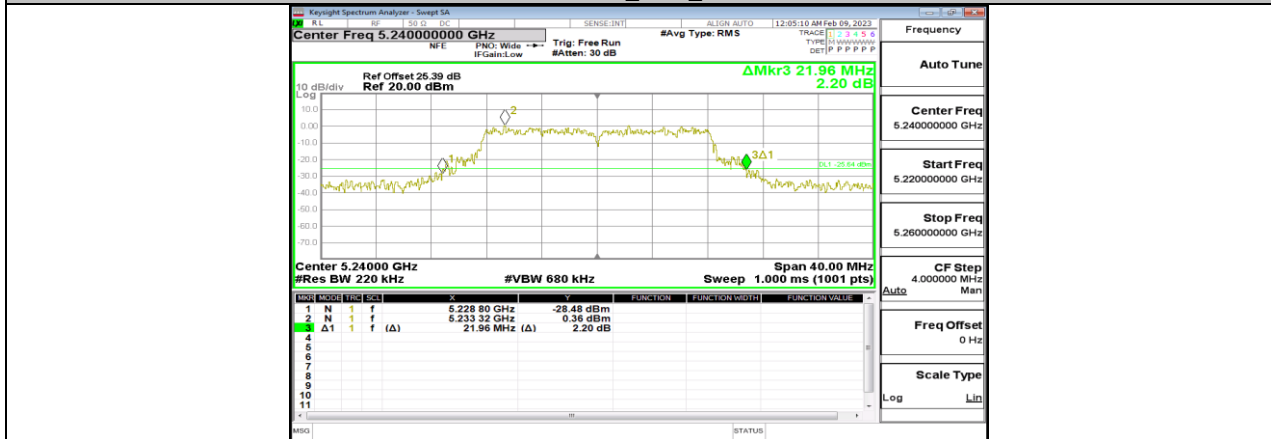

11A-CDD\_Ant1\_5240

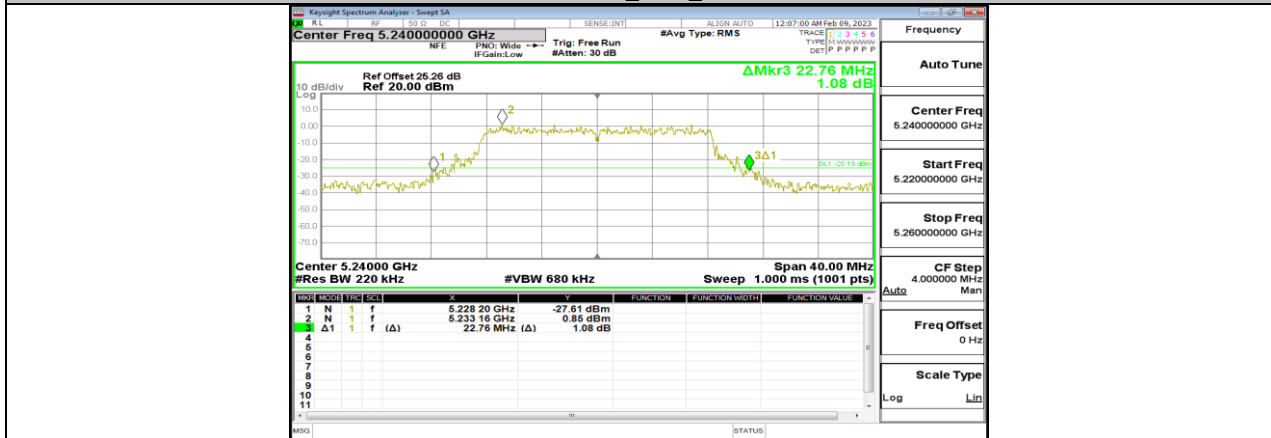

11A-CDD\_Ant3\_5240



11A-CDD\_Ant1\_5745

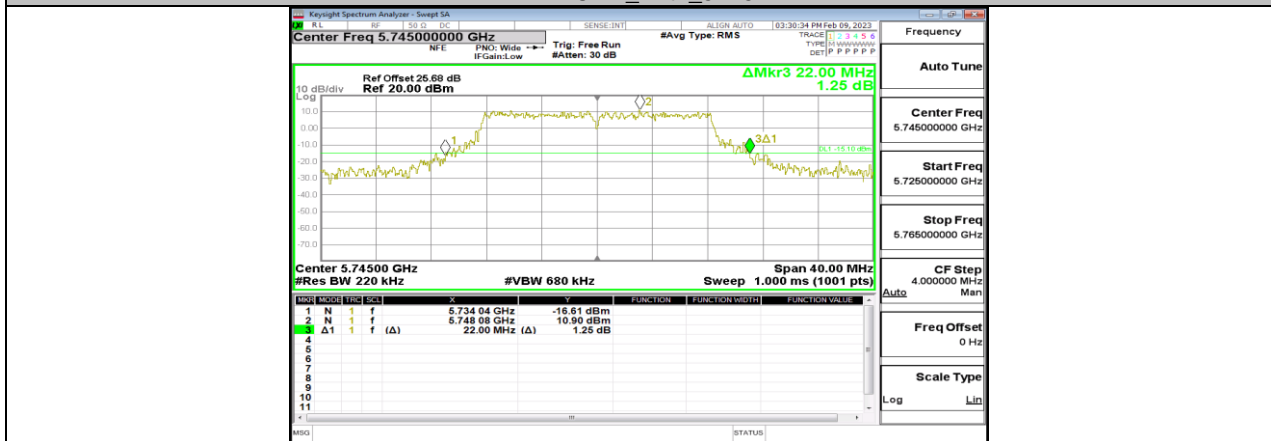

11A-CDD\_Ant3\_5745



11A-CDD\_Ant1\_5785



11A-CDD\_Ant3\_5785



11A-CDD\_Ant1\_5825

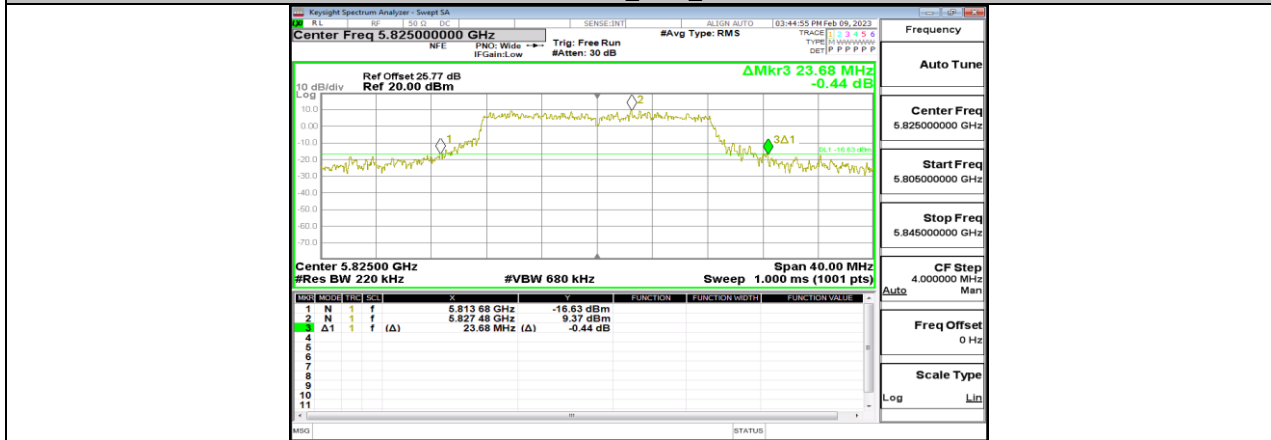

11A-CDD\_Ant3\_5825

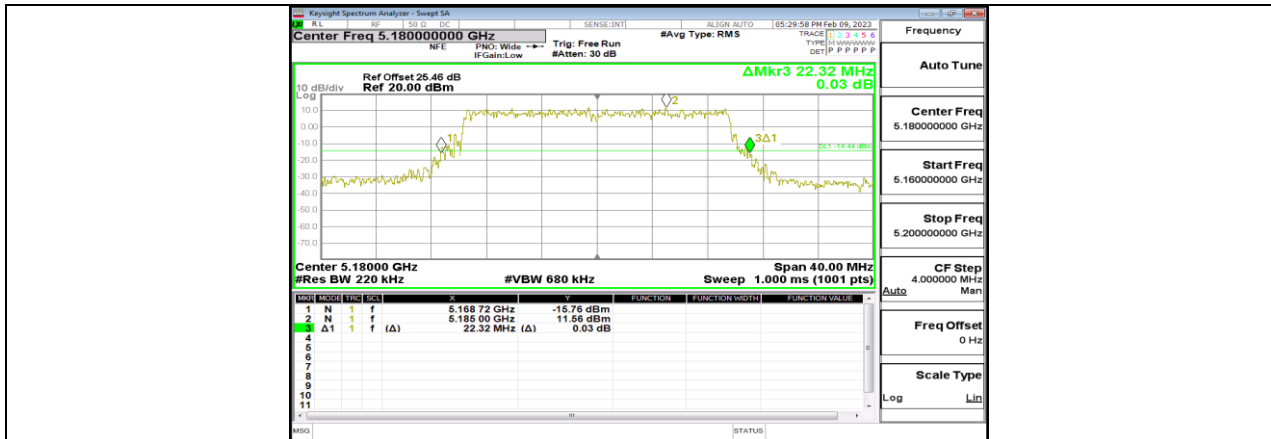

11AX20MIMO\_Ant1\_5180

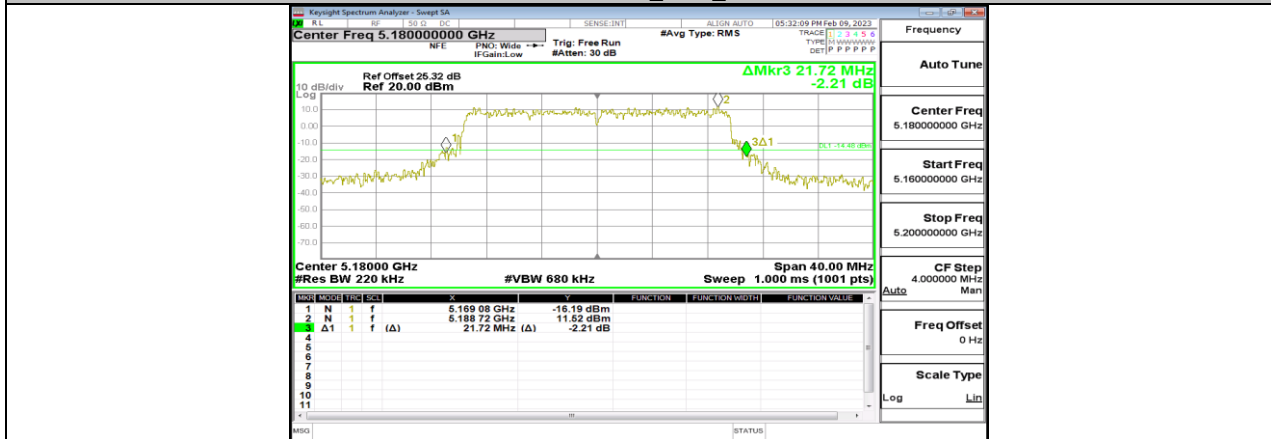

11AX20MIMO\_Ant3\_5180

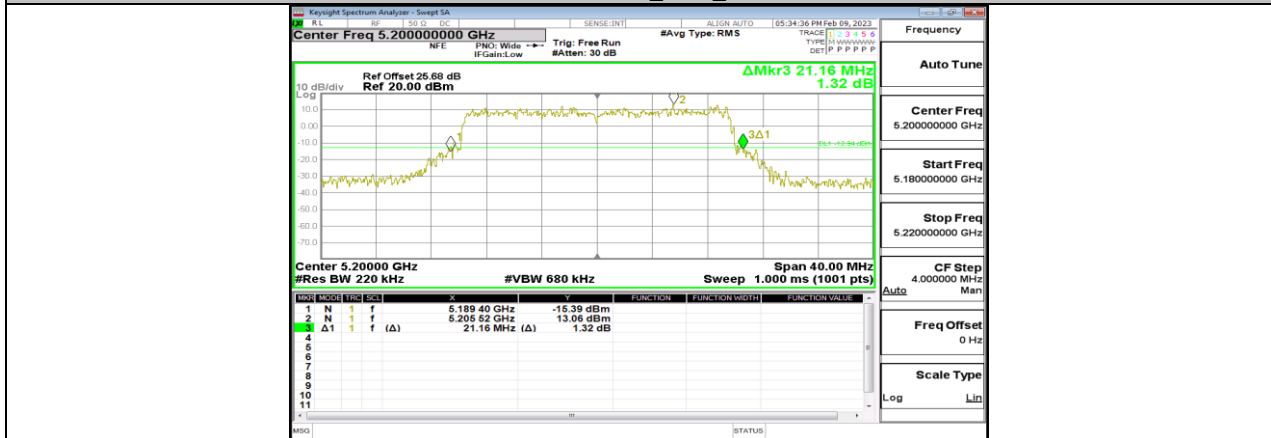

11AX20MIMO\_Ant1\_5200

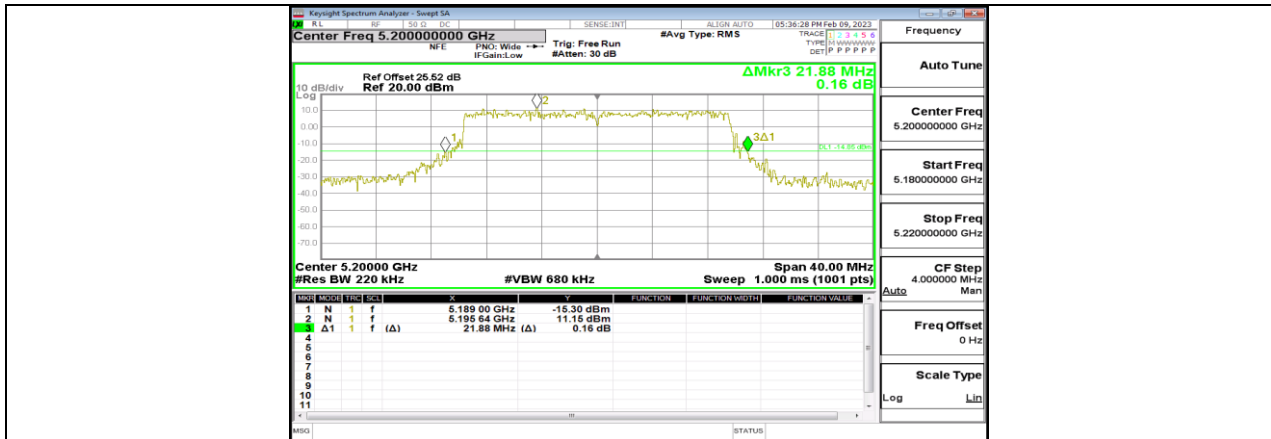

11AX20MIMO\_Ant3\_5200

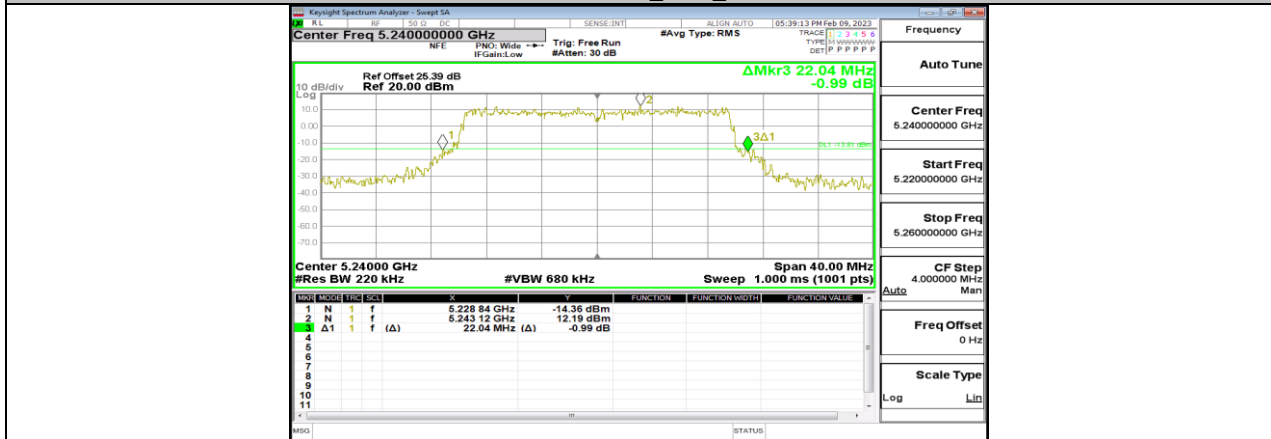

11AX20MIMO\_Ant1\_5240



11AX20MIMO\_Ant3\_5240

