

**CFR 47 FCC PART 15 SUBPART E  
ISED RSS-247 ISSUE 2**

**TEST REPORT**

*For*

**BE9300 Tri-Band Wi-Fi 7 Router**

**MODEL NUMBER: Archer BE550**

**REPORT NUMBER: 4790818590-1-RF-2**

**FCC ID: 2AXJ4BE550**

**IC: 26583-BE550**

**ISSUE DATE: May 26, 2023**

*Prepared for*

**TP-Link Corporation Limited  
Room 901, 9/F. , New East Ocean Centre, 9 Science Museum Road, Tsim Sha Tsui,  
Kowloon, Hong Kong**

*Prepared by*

**UL Verification Services (Guangzhou) Co., Ltd, Song Shan Lake Branch**

**Building 10, Innovation Technology Park, No. 1, Li Bin Road, Song Shan Lake Hi-Tech Development Zone Dongguan, 523808, People's Republic of China**

**Tel: +86 769 22038881**

**Fax: +86 769 33244054**

**Website: [www.ul.com](http://www.ul.com)**

## Revision History

Rev.	Issue Date	Revisions	Revised By
V0	May 26, 2023	Initial Issue	

### Summary of Test Results

Test Item	Clause	Limit/Requirement	Result
ON TIME AND DUTY CYCLE	ANSI C63.10-2013, Clause 12.2	None; for reporting purposes only.	Pass
6dB AND 26dB EMISSION BANDWIDTH AND 99% OCCUPIED BANDWIDTH	KDB 789033 D02 v02r01 Section C.1	FCC Part 15.407 (a)/(e), RSS-247 Issue 2, Clause 6.2.1.2 RSS-Gen Clause 6.7	Pass
CONDUCTED OUTPUT POWER	KDB 789033 D02 v02r01 Section E.3.a (Method PM)	FCC 15.407 (a) RSS-247 Clause 6.2	Pass
POWER SPECTRAL DENSITY	KDB 789033 D02 v02r01 Section F	FCC 15.407 (a) RSS-247 Clause 6.2	Pass
AC Power Line Conducted Emission	ANSI C63.10-2013, Clause 6.2.	FCC 15.207 RSS-GEN Clause 8.8	Pass
Radiated Emissions and Band Edge Measurement	KDB 789033 D02 v02r01 Section G.3, G.4, G.5, and G.6	FCC 15.407 (b) FCC 15.209 FCC 15.205 RSS-247 Clause 6.2 RSS-GEN Clause 8.9	Pass
FREQUENCY STABILITY	ANSI C63.10-2013, Clause 6.8	FCC 15.407 (g)	Pass
Antenna Requirement	N/A	FCC 47 CFR Part 15.203/ 15.407(a)(1) (2), RSS-Gen Issue 5, Clause 6.8	Pass

Note:

1. N/A: In this whole report not applicable.

\*This test report is only published to and used by the applicant, and it is not for evidence purpose in China.

\*The measurement result for the sample received is <Pass> according to <CFR 47 FCC PART 15 SUBPART E  
ISED RSS-247 ISSUE 2> when <Accuracy Method> decision rule is applied.

## CONTENTS

<b>1. ATTESTATION OF TEST RESULTS.....</b>	<b>6</b>
<b>2. TEST METHODOLOGY.....</b>	<b>7</b>
<b>3. FACILITIES AND ACCREDITATION.....</b>	<b>7</b>
<b>4. CALIBRATION AND UNCERTAINTY .....</b>	<b>8</b>
4.1. <i>MEASURING INSTRUMENT CALIBRATION .....</i>	<i>8</i>
4.2. <i>MEASUREMENT UNCERTAINTY.....</i>	<i>8</i>
<b>5. EQUIPMENT UNDER TEST .....</b>	<b>9</b>
5.1. <i>DESCRIPTION OF EUT .....</i>	<i>9</i>
5.2. <i>CHANNEL LIST .....</i>	<i>10</i>
5.3. <i>MAXIMUM EIRP .....</i>	<i>11</i>
5.4. <i>TEST CHANNEL CONFIGURATION.....</i>	<i>12</i>
5.5. <i>THE WORSE CASE POWER SETTING PARAMETER.....</i>	<i>13</i>
5.6. <i>WORSE CASE CONFIGURATIONS.....</i>	<i>15</i>
5.7. <i>DESCRIPTION OF AVAILABLE ANTENNAS .....</i>	<i>17</i>
5.8. <i>SUPPORT UNITS FOR SYSTEM TEST.....</i>	<i>19</i>
<b>6. MEASURING EQUIPMENT AND SOFTWARE USED.....</b>	<b>20</b>
<b>7. ANTENNA PORT TEST RESULTS .....</b>	<b>23</b>
7.1. <i>ON TIME AND DUTY CYCLE.....</i>	<i>23</i>
7.2. <i>6DB AND 26DB EMISSION BANDWIDTH AND 99% OCCUPIED BANDWIDTH ...</i>	<i>24</i>
7.3. <i>CONDUCTED OUTPUT POWER.....</i>	<i>26</i>
7.4. <i>POWER SPECTRAL DENSITY .....</i>	<i>29</i>
7.5. <i>FREQUENCY STABILITY.....</i>	<i>31</i>
<b>8. RADIATED TEST RESULTS.....</b>	<b>33</b>
8.1. <i>RESTRICTED BANDEDGE .....</i>	<i>43</i>
8.2. <i>RESTRICTED BANDEDGE .....</i>	<i>77</i>
8.3. <i>SPURIOUS EMISSIONS(1 GHZ~7 GHZ) .....</i>	<i>87</i>
8.4. <i>SPURIOUS EMISSIONS(1 GHZ~7 GHZ) .....</i>	<i>99</i>
8.5. <i>SPURIOUS EMISSIONS(7 GHZ~18 GHZ) .....</i>	<i>105</i>
8.6. <i>SPURIOUS EMISSIONS(7 GHZ~18 GHZ) .....</i>	<i>165</i>
8.7. <i>SPURIOUS EMISSIONS(9 KHZ~30 MHZ) .....</i>	<i>195</i>
8.8. <i>SPURIOUS EMISSIONS(18 GHZ~26 GHZ) .....</i>	<i>198</i>
8.9. <i>SPURIOUS EMISSIONS(26 GHZ~40 GHZ) .....</i>	<i>200</i>

8.10.	SPURIOUS EMISSIONS(30 MHZ~1 GHZ) .....	202
8.11.	SIMULTANEOUSLY TRANSMISSION SPURIOUS EMISSIONS .....	204
<b>9.</b>	<b>AC POWER LINE CONDUCTED EMISSION .....</b>	<b>208</b>
<b>10.</b>	<b>ANTENNA REQUIREMENT .....</b>	<b>212</b>
<b>11.</b>	<b>TEST DATA.....</b>	<b>213</b>
11.1.	APPENDIX A: EMISSION BANDWIDTH.....	213
11.1.1.	Test Result.....	213
11.1.2.	Test Graphs .....	215
11.2.	APPENDIX B: OCCUPIED CHANNEL BANDWIDTH.....	235
11.2.1.	Test Result.....	235
11.2.2.	Test Graphs .....	237
11.3.	APPENDIX C: MIN EMISSION BANDWIDTH .....	257
11.3.1.	Test Result.....	257
11.3.2.	Test Graphs .....	258
11.4.	APPENDIX D: MAXIMUM CONDUCTED OUTPUT POWER.....	268
11.4.1.	Test Result For FCC .....	268
11.4.2.	Test Result For ISED .....	270
11.5.	APPENDIX E: MAXIMUM POWER SPECTRAL DENSITY .....	272
11.5.1.	Test Result For FCC .....	272
11.5.2.	Test Graphs For FCC.....	274
11.5.3.	Test Result For ISED .....	295
11.5.4.	Test Graphs For ISED.....	297
11.6.	APPENDIX F: FREQUENCY STABILITY.....	320
11.6.1.	Test Result.....	320
11.7.	APPENDIX G: DUTY CYCLE.....	321
11.7.1.	Test Result.....	321
11.7.2.	Test Graphs .....	322

# 1. ATTESTATION OF TEST RESULTS

## Applicant Information

Company Name: TP-Link Corporation Limited  
 Address: Room 901, 9/F. , New East Ocean Centre, 9 Science Museum Road, Tsim Sha Tsui, Kowloon, Hong Kong

## Manufacturer Information

Company Name: TP-Link Corporation Limited  
 Address: Room 901, 9/F. , New East Ocean Centre, 9 Science Museum Road, Tsim Sha Tsui, Kowloon, Hong Kong

## EUT Information

EUT Name: BE9300 Tri-Band Wi-Fi 7 Router  
 Model: Archer BE550  
 Series Model: Archer BE9300  
 Model Difference: Refer to section 5.1  
 Brand: tp-link  
 Sample Received Date: April 23, 2023  
 Sample Status: Normal  
 Date of Tested: April 23, 2023 to May 26, 2023

APPLICABLE STANDARDS	
STANDARD	TEST RESULTS
CFR 47 FCC PART 15 SUBPART E ISED RSS-247 ISSUE 2	Pass

Prepared By:

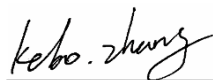

Kebo Zhang  
 Senior Project Engineer

Checked By:

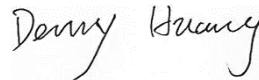

Denny Huang  
 Senior Project Engineer

Approved By:



Stephen Guo  
 Operations Manager

## 2. TEST METHODOLOGY

All tests were performed in accordance with the standard CFR 47 FCC PART 15 SUBPART E ISED RSS-247 ISSUE 2, ANSI C63.10-2013, CFR 47 FCC Part 2, KDB 789033 D02 v02r01, RSS-GEN Issue 5, KDB414788 D01 Radiated Test Site v01, KDB 662911 D01 Multiple Transmitter Output v02r01.

## 3. FACILITIES AND ACCREDITATION

Accreditation Certificate	<p><b>A2LA (Certificate No.: 4102.01)</b>                  UL Verification Services (Guangzhou) Co., Ltd. Song Shan Lake Branch. has been assessed and proved to be in compliance with A2LA.</p> <p><b>FCC (FCC Designation No.: CN1187)</b>                  UL Verification Services (Guangzhou) Co., Ltd. Song Shan Lake Branch. Has been recognized to perform compliance testing on equipment subject to the Commission's Declaration of Conformity (DoC) and Certification rules</p> <p><b>ISED (Company No.: 21320)</b>                  UL Verification Services (Guangzhou) Co., Ltd. Song Shan Lake Branch. has been registered and fully described in a report filed with ISED. The Company Number is 21320 and the test lab Conformity Assessment Body Identifier (CABID) is CN0046.</p> <p><b>VCCI (Registration No.: G-20019, R-20004, C-20012 and T-20011)</b>                  UL Verification Services (Guangzhou) Co., Ltd. Song Shan Lake Branch. has been assessed and proved to be in compliance with VCCI, the Membership No. is 3793.                  Facility Name:                  Chamber D, the VCCI registration No. is G-20019 and R-20004                  Shielding Room B , the VCCI registration No. is C-20012 and T-20011</p>
---------------------------	--

**Note 1:**

All tests measurement facilities use to collect the measurement data are located at Building 10, Innovation Technology Park, No. 1, Li Bin Road, Song Shan Lake Hi-Tech Development Zone Dongguan, 523808, People's Republic of China.

**Note 2:**

The test anechoic chamber in UL Verification Services (Guangzhou) Co., Ltd. Song Shan Lake Branch had been calibrated and compared to the open field sites and the test anechoic chamber is shown to be equivalent to or worst case from the open field site.

**Note 3:**

For below 30 MHz, lab had performed measurements at test anechoic chamber and comparing to measurements obtained on an open field site. And these measurements below 30 MHz had been correlated to measurements performed on an OFS.

## 4. CALIBRATION AND UNCERTAINTY

### 4.1. MEASURING INSTRUMENT CALIBRATION

The measuring equipment utilized to perform the tests documented in this report has been calibrated in accordance with the manufacturer's recommendations and is traceable to recognized national standards.

### 4.2. MEASUREMENT UNCERTAINTY

Where relevant, the following measurement uncertainty levels have been estimated for tests performed on the apparatus:

Test Item	Uncertainty
Conduction emission	3.62 dB
Radiated Emission (Included Fundamental Emission) (9 kHz ~ 30 MHz)	2.2 dB
Radiated Emission (Included Fundamental Emission) (30 MHz ~ 1 GHz)	4.00 dB
Radiated Emission (Included Fundamental Emission) (1 GHz to 40 GHz)	5.78 dB (1 GHz ~ 18 GHz)
	5.23 dB (18 GHz ~ 26 GHz)
	5.37 dB (26 GHz ~ 40 GHz)
Duty Cycle	±0.028%
Emission Bandwidth and 99% Occupied Bandwidth	±0.0196%
Maximum Conducted Output Power	±0.766 dB
Maximum Power Spectral Density Level	±1.22 dB
Frequency Stability	±2.76%
Conducted Band-edge Compliance	±1.328 dB
Conducted Unwanted Emissions In Non-restricted Frequency Bands	±0.746 dB (9 kHz ~ 1 GHz)
	±1.328dB (1 GHz ~ 26 GHz)
Note: This uncertainty represents an expanded uncertainty expressed at approximately the 95% confidence level using a coverage factor of k=2.	



## 5. EQUIPMENT UNDER TEST

### 5.1. DESCRIPTION OF EUT

EUT Name/PMN:	BE9300 Tri-Band Wi-Fi 7 Router
Model/HVIN1:	Archer BE550
Series Model/HVIN2:	Archer BE9300
Model Difference:	Archer BE9300 has the same RF technical construction including circuit diagram, PCB Layout, components, component layout and performance with Archer BE550. Only the model number are difference.
Frequency Range:	5180 MHz to 5240 MHz(U-NII-1) 5745 MHz to 5825 MHz(U-NII-3)
TPC Function:	Support
DFS Operational mode:	Master
Type of Modulation:	IEEE 802.11a: OFDM(64QAM, 16QAM, QPSK, BPSK) IEEE 802.11n: OFDM(64QAM, 16QAM, QPSK, BPSK) IEEE 802.11ac: OFDM(256QAM, 64QAM, 16QAM, QPSK, BPSK) IEEE 802.11ax: OFDMA (1024QAM, 256QAM, 64QAM, 16QAM, QPSK, BPSK) IEEE 802.11be: OFDMA (4096QAM, 1024QAM, 256QAM, 64QAM, 16QAM, QPSK, BPSK)
Radio Technology:	IEEE802.11a/n HT20/n HT40/ ac VHT20/ac VHT40/ac VHT80 ax HE20/ax HE40/ax HE80 be EHT20/be EHT40/be EHT80
FVIN:	V1.0
Normal Test Voltage:	DC 12 V via adapter

## 5.2. CHANNEL LIST

UNII-1 (For Bandwidth=20MHz)		UNII-1 (For Bandwidth=40MHz)		UNII-1 (For Bandwidth=80MHz)	
Channel	Frequency (MHz)	Channel	Frequency (MHz)	Channel	Frequency (MHz)
36	5180	38	5190	42	5210
40	5200	46	5230		
44	5220				
48	5240				

UNII-3 (For Bandwidth=20MHz)		UNII-3 (For Bandwidth=40MHz)		UNII-3 (For Bandwidth=80MHz)	
Channel	Frequency (MHz)	Channel	Frequency (MHz)	Channel	Frequency (MHz)
149	5745	151	5755	155	5775
153	5765	159	5795		
157	5785				
161	5805				
165	5825				

### 5.3. MAXIMUM EIRP

IEEE Std. 802.11	Frequency (MHz)	Maximum Average Conducted Power (dBm)	Maximum Average EIRP (dBm)
a	5180 ~ 5825	28.03	31.03
ax HE20		28.27	31.27
ax HE40		28.90	31.90
ax HE80		24.28	27.28
be EHT20		28.71	31.71
be EHT40		28.90	31.90
be EHT80		24.53	27.53

#### 5.4. TEST CHANNEL CONFIGURATION

UNII-1 Test Channel Configuration		
IEEE Std.	Test Channel Number	Frequency
802.11a	CH 36(Low Channel), CH 40(MID Channel), CH 48(High Channel)	5180 MHz, 5200 MHz, 5240 MHz
802.11ax HE20	CH 36(Low Channel), CH 40(MID Channel), CH 48(High Channel)	5180 MHz, 5200 MHz, 5240 MHz
802.11ax HE40	CH 38(Low Channel), CH 46(High Channel)	5190 MHz, 5230 MHz
802.11ax HE80	CH 42(Low Channel)	5210 MHz
802.11be EHT20	CH 36(Low Channel), CH 40(MID Channel), CH 48(High Channel)	5180 MHz, 5200 MHz, 5240 MHz
802.11be EHT40	CH 38(Low Channel), CH 46(High Channel)	5190 MHz, 5230 MHz
802.11be EHT80	CH 42(Low Channel)	5210 MHz

UNII-3 Test Channel Configuration		
IEEE Std.	Test Channel Number	Frequency
802.11a	CH 149(Low Channel), CH 157(MID Channel), CH 165(High Channel)	5745 MHz, 5785 MHz, 5825 MHz
802.11ax HE20	CH 149(Low Channel), CH 157(MID Channel), CH 165(High Channel)	5745 MHz, 5785 MHz, 5825 MHz
802.11ax HE40	CH 151(Low Channel), CH 159(High Channel)	5755MHz, 5795MHz
802.11ax HE80	CH 155(Low Channel)	5775 MHz
802.11be EHT20	CH 149(Low Channel), CH 157(MID Channel), CH 165(High Channel)	5745 MHz, 5785 MHz, 5825 MHz
802.11be EHT40	CH 151(Low Channel), CH 159(High Channel)	5755MHz, 5795MHz
802.11be EHT80	CH 155(Low Channel)	5775 MHz

## 5.5. THE WORSE CASE POWER SETTING PARAMETER

The Worse Case Power Setting Parameter	
Test Software	QSPR

FOR FCC		
Mode	Freq(MHz)	Tx power level(dBm)
		ANT1/ANT4
802.11a-CDD	5180	19
	5200	24
	5240	24
	5745	24
	5785	24
	5825	24
802.11AX 20M	5180	20
	5200	24
	5240	24
	5745	24
	5785	24
	5825	24
802.11AX 40M	5190	18
	5230	20
	5755	23
	5795	24
802.11AX 80M	5210	17
	5775	21
802.11be 20M	5180	19
	5200	24
	5240	23
	5745	24
	5785	24
	5825	24
802.11be 40M	5190	17.5
	5230	20.5
	5755	23
	5795	24
802.11be 80M	5210	17
	5775	21

FOR ISED		
Mode	Freq(MHz)	Tx power level(dBm)
		ANT1/ANT4
802.11a-CDD	5180	11
	5200	10.5
	5240	10.5
	5745	24
	5785	24
	5825	24
802.11AX 20M	5180	11.5
	5200	11
	5240	11.5
	5745	24
	5785	24
	5825	24
802.11AX 40M	5190	14.5
	5230	14.5
	5755	23
	5795	24
802.11AX 80M	5210	16
	5775	21
802.11be 20M	5180	11.5
	5200	11.5
	5240	11.5
	5745	24
	5785	24
	5825	24
802.11be 40M	5190	14.5
	5230	14.5
	5755	23
	5795	24
802.11be 80M	5210	16
	5775	21

## 5.6. WORSE CASE CONFIGURATIONS

The EUT was tested in the following configuration(s):

Controlled in test mode using a software application on the EUT supplied by customer. The application was used to enable a continuous transmission and to select the mode, test channels, bandwidth, data rates as required.

Test channels referring to section 5.4.

Maximum power setting referring to section 5.5.

Worst case Data Rates declared by the customer:

802.11a 20 CDD mode : 6 Mbps  
 802.11n HT20 CDD mode : MCS0  
 802.11n HT40 CDD mode : MCS0  
 802.11ac VHT20 CDD mode : MCS0  
 802.11ac VHT40 CDD mode : MCS0  
 802.11ac VHT80 CDD mode : MCS0  
 802.11ax HE20 CDD mode : MCS0  
 802.11ax HE40 CDD mode : MCS0  
 802.11ax HE80 CDD mode : MCS0  
 802.11be EHT20 CDD mode : MCS0  
 802.11be EHT40 CDD mode : MCS0  
 802.11be EHT80 CDD mode : MCS0

All modes support CDD mode.

All modes support TX beamforming mode except 802.11a.

802.11n HT20/HT40/ac VHT20/VHT40/VHT80 and 802.11ax HE20/HE40/HE80 were performed on the worst case (802.11ax HE20/HE40/HE80) mode and only the worst data was recorded in this report.

The EUT has 6 separate antennas which correspond to 6 separate antenna ports. Core 2 and Core 5 correspond to antenna 2 and antenna 5 respectively and they support WLAN 2.4G. Core 1 and Core 4 correspond to antenna 1 and antenna 4 respectively and they support RLAN 5G. Core 3 and Core 6 correspond to antenna 3 and antenna 6 respectively and they support RLAN 6G, but it's not check in this device, and they have been disabled by software.

The measured additional path loss was included in any path loss calculations for all RF cable used during tested.

The 5 GHz beamforming function is enabled by test program, the carrier wave will be under radio chip phase control and sent to the antennas through the test program.

US and CA country codes changed the power table for U-NII band 1. Therefore U-NII-1 was tested to both powers. For other bands have the same power table. The CA country code also disabled any channels in the 5600-5650 MHz band.

Sample ID:	6014565-1	For FCC full band and ISED UNII-3 test
Sample ID:	6014565-2	For ISED UNII-1 test

The EUT not support partial Rus and channel puncturing mode.

Simultaneously Transmission Conditions:

Support Technology		Support (YES/NO)
WLAN (2.4G)	WLAN (5G)	YES

Note: The emission of the simultaneous operation has been evaluated and no non-compliance was found.



## 5.7. DESCRIPTION OF AVAILABLE ANTENNAS

Antenna No.	Frequency Band	Antenna Type	Max Antenna Gain (dBi)
1	5150-5850	Dipole Antenna	3
4	5150-5850	Dipole Antenna	3

The EUT support Cyclic Shift Diversity(CDD) mode.

MIMO output power port and MIMO PSD port summing were performed in accordance with KDB 662911 D01. For the CDD results the Directional Gain was calculated in accordance with the following method.

For output power measurements:

Directional gain=  $G_{ANT} + \text{Array Gain} = 3 \text{ dBi}$

$G_{ANT}$  : equal to the gain of the antenna having the highest gain

Array Gain = 0 dB (i.e., no array gain) for  $N_{ANT} \leq 4$

For power spectral density (PSD) measurements:

Directional gain=  $G_{ANT} + \text{Array Gain} = 3.01 \text{ dBi}$

Array Gain =  $10 \log(N_{ANT}/N_{SS}) \text{ dB}$ .

$N_{ANT}$  : number of transmit antennas

$N_{SS}$  : number of spatial streams, The worst case directional gain will occur when  $N_{SS} = 1$

For TX Beamforming:

Directional gain=  $G_{ANT} + 10 \log(N_{ANT}/N_{SS}) = 6.01 \text{ dBi}$

IEE Std. 802.11	Transmit and Receive Mode	Description
802.11a	<input checked="" type="checkbox"/> 2TX, 2RX	ANT 1 and ANT 4 can be used as transmitting/receiving antenna.
802.11n HT20	<input checked="" type="checkbox"/> 2TX, 2RX	ANT 1 and ANT 4 can be used as transmitting/receiving antenna.
802.11n HT40	<input checked="" type="checkbox"/> 2TX, 2RX	ANT 1 and ANT 4 can be used as transmitting/receiving antenna.
802.11ac VHT20	<input checked="" type="checkbox"/> 2TX, 2RX	ANT 1 and ANT 4 can be used as transmitting/receiving antenna.
802.11ac VHT40	<input checked="" type="checkbox"/> 2TX, 2RX	ANT 1 and ANT 4 can be used as transmitting/receiving antenna.
802.11ac VHT80	<input checked="" type="checkbox"/> 2TX, 2RX	ANT 1 and ANT 4 can be used as transmitting/receiving antenna.
802.11ax HE20	<input checked="" type="checkbox"/> 2TX, 2RX	ANT 1 and ANT 4 can be used as transmitting/receiving antenna.
802.11ax HE40	<input checked="" type="checkbox"/> 2TX, 2RX	ANT 1 and ANT 4 can be used as transmitting/receiving antenna.
802.11ax HE80	<input checked="" type="checkbox"/> 2TX, 2RX	ANT 1 and ANT 4 can be used as transmitting/receiving antenna.
802.11ax HE160	<input checked="" type="checkbox"/> 2TX, 2RX	ANT 1 and ANT 4 can be used as transmitting/receiving antenna.
802.11be EHT20	<input checked="" type="checkbox"/> 2TX, 2RX	ANT 1 and ANT 4 can be used as transmitting/receiving antenna.
802.11be EHT40	<input checked="" type="checkbox"/> 2TX, 2RX	ANT 1 and ANT 4 can be used as transmitting/receiving antenna.
802.11be EHT80	<input checked="" type="checkbox"/> 2TX, 2RX	ANT 1 and ANT 4 can be used as transmitting/receiving antenna.

Note: The value of the antenna gain was declared by customer.

## 5.8. SUPPORT UNITS FOR SYSTEM TEST

### SUPPORT EQUIPMENT

Item	Equipment	Brand Name	Model Name	Remarks
1	Laptop	ThinkPad	X230i	/

### I/O CABLES

Cable No	Port	Connector Type	Cable Type	Cable Length(m)	Remarks
1	LAN1	RJ45	Unshielded	1.0 m	/

### ACCESSORIES

Item	Accessory	Brand Name	Model Name	Description
1	I.T.E POWER SUPPLY	tp-link	T120330-2B4	Input: AC 100-240 V, 50 / 60 Hz, 1 A Output: DC 12.0 V, 3.3 A

### TEST SETUP

The EUT can work in engineering mode with a software through a laptop.

### SETUP DIAGRAM FOR TESTS

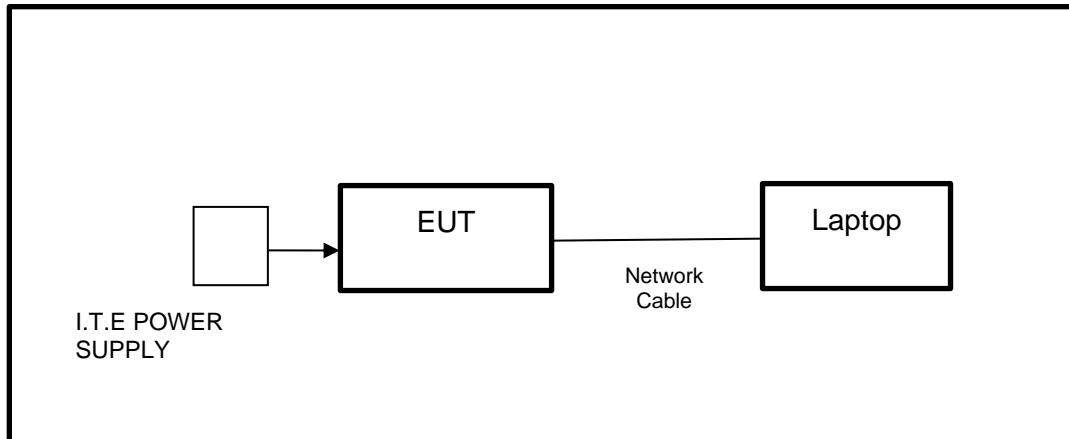

## 6. MEASURING EQUIPMENT AND SOFTWARE USED

R&S TS 8997 Test System					
Equipment	Manufacturer	Model No.	Serial No.	Last Cal.	Due. Date
Power sensor, Power Meter	R&S	OSP120	100921	Mar.31,2023	Mar.30,2024
Vector Signal Generator	R&S	SMBV100A	261637	Oct.17, 2022	Oct.16, 2023
Signal Generator	R&S	SMB100A	178553	Oct.17, 2022	Oct.16, 2023
Signal Analyzer	R&S	FSV40	101118	Oct.17, 2022	Oct.16, 2023
Software					
Description	Manufacturer	Name		Version	
For R&S TS 8997 Test System	Rohde & Schwarz	EMC 32		10.60.10	
Tonsend RF Test System					
Equipment	Manufacturer	Model No.	Serial No.	Last Cal.	Due. Date
Wideband Radio Communication Tester	R&S	CMW500	155523	Oct.17, 2022	Oct.16, 2023
Wireless Connectivity Tester	R&S	CMW270	1201.0002N75-102	Sep.28, 2022	Sep.27, 2023
PXA Signal Analyzer	Keysight	N9030A	MY55410512	Oct.17, 2022	Oct.16, 2023
MXG Vector Signal Generator	Keysight	N5182B	MY56200284	Oct.17, 2022	Oct.16, 2023
MXG Vector Signal Generator	Keysight	N5172B	MY56200301	Oct.17, 2022	Oct.16, 2023
DC power supply	Keysight	E3642A	MY55159130	Oct.17, 2022	Oct.16, 2023
Temperature & Humidity Chamber	SANMOOD	SG-80-CC-2	2088	Oct.17, 2022	Oct.16, 2023
Attenuator	Aglient	8495B	2814a12853	Oct.18, 2022	Oct.17, 2023
RF Control Unit	Tonscend	JS0806-2	23B80620666	April 18,2023	April 17,2024
Software					
Description	Manufacturer	Name		Version	
Tonsend SRD Test System	Tonsend	JS1120-3 RF Test System		V3.2.22	

Conducted Emissions					
Equipment	Manufacturer	Model No.	Serial No.	Last Cal.	Due Date
EMI Test Receiver	R&S	ESR3	101961	Oct.17, 2022	Oct.16, 2023
Two-Line V-Network	R&S	ENV216	101983	Oct.17, 2022	Oct.16, 2023
Artificial Mains Networks	Schwarzbeck	NSLK 8126	8126465	Oct.17, 2022	Oct.16, 2023
Software					
Description			Manufacturer	Name	Version
Test Software for Conducted Emissions			Farad	EZ-EMC	Ver. UL-3A1

Radiated Emissions					
Equipment	Manufacturer	Model No.	Serial No.	Last Cal.	Due Date
MXE EMI Receiver	KESIGHT	N9038A	MY56400036	Oct.17, 2022	Oct.16, 2023
Hybrid Log Periodic Antenna	TDK	HLP-3003C	130959	Aug.02, 2021	Aug.01, 2024
Preamplifier	HP	8447D	2944A09099	Oct.17, 2022	Oct.16, 2023
EMI Measurement Receiver	R&S	ESR26	101377	Oct.17, 2022	Oct.16, 2023
Horn Antenna	TDK	HRN-0118	130940	July 20, 2021	July 19, 2024
Preamplifier	TDK	PA-02-0118	TRS-305-00067	Oct.17, 2022	Oct.16, 2023
Horn Antenna	Schwarzbeck	BBHA9170	697	July 20, 2021	July 19, 2024
Preamplifier	TDK	PA-02-2	TRS-307-00003	Oct.17, 2022	Oct.16, 2023
Preamplifier	TDK	PA-02-3	TRS-308-00002	Oct.17, 2022	Oct.16, 2023
Loop antenna	Schwarzbeck	1519B	00008	Dec.14, 2021	Dec.13, 2024
Preamplifier	TDK	PA-02-001-3000	TRS-302-00050	Oct.17, 2022	Oct.16, 2023
Preamplifier	Mini-Circuits	ZX60-83LN-S+	SUP01202035	Oct.17, 2022	Oct.16, 2023
High Pass Filter	Wi	WHKX10-2700-3000-18000-40SS	23	/	/
Highpass Filter	Wainwright	WHKX10-5850-6500-1800-40SS	4	/	/
Band Reject Filter	Wainwright	WRCJV12-5695-5725-5850-5880-40SS	4	/	/

Band Reject Filter	Wainwright	WRCJV20-5120-5150-5350-5380-60SS	2	/	/
Band Reject Filter	Wainwright	WRCJV20-5440-5470-5725-5755-60SS	1	/	/
Band Reject Filter	Wainwright	WRCJV8-2350-2400-2483.5-2533.5-40SS	4	/	/
Band Reject Filter	Wainwright	WRCD5-1879-1879.85-1880.15-1881-40SS	1	/	/
Notch Filter	Wainwright	WHJ10-882-980-7000-40SS	1	/	/
<b>Software</b>					
Description		Manufacturer	Name	Version	
Test Software for Radiated Emissions		Farad	EZ-EMC	Ver. UL-3A1	

<b>Other Instrument</b>					
Equipment	Manufacturer	Model No.	Serial No.	Last Cal.	Due Date
Temperature humidity probe	OMEGA	ITHX-SD-5	18470007	Oct.22, 2022	Oct.21, 2023
Barometer	Yiyi	Baro	N/A	Oct.24, 2022	Oct.23, 2023
Attenuator	Agilent	8495B	2814a12853	Oct.18, 2022	Oct.17, 2023

## 7. ANTENNA PORT TEST RESULTS

### 7.1. ON TIME AND DUTY CYCLE

#### LIMITS

None; for reporting purposes only.

#### TEST PROCEDURE

Refer to KDB 789033 D02 General U-NII Test Procedures New Rules v02r01 section II.B.

The zero-span mode on a spectrum analyzer or EMI receiver, if the response time and spacing between bins on the sweep are sufficient to permit accurate measurements of the on and off times of the transmitted signal. Set the center frequency of the instrument to the center frequency of the transmission. Set  $RBW \geq EBW$  if possible; otherwise, set RBW to the largest available value. Set  $VBW \geq RBW$ . Set detector = peak or average. The zero-span measurement method shall not be used unless both RBW and VBW are  $> 50/T$ , where T is defined in II.B.1.a), and the number of sweep points across duration T exceeds 100. (For example, if VBW and/or RBW are limited to 3 MHz, then the zero-span method of measuring duty cycle shall not be used if  $T \leq 16.7$  microseconds.)

#### TEST SETUP

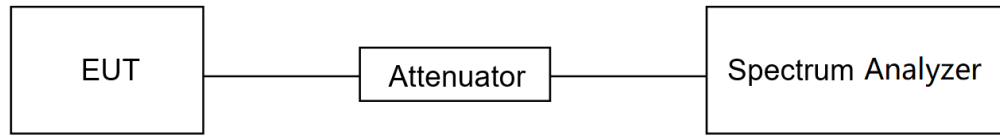

#### TEST ENVIRONMENT

Temperature	26.9°C	Relative Humidity	56.4%
Atmosphere Pressure	101kPa	Test Voltage	DC 12 V

#### TEST DATE / ENGINEER

Test Date	May 25, 2023	Test By	Johnson Liu
-----------	--------------	---------	-------------

#### TEST RESULTS

Please refer to section "Test Data" - Appendix G

## 7.2. 6DB AND 26DB EMISSION BANDWIDTH AND 99% OCCUPIED BANDWIDTH

### LIMITS

CFR 47 FCC Part15, Subpart E ISED RSS-247 ISSUE 2		
Test Item	Limit	Frequency Range (MHz)
26 dB Emission Bandwidth	For reporting purposes only.	5150 ~ 5250
26 dB Emission Bandwidth	For reporting purposes only.	5250 ~ 5350
26 dB Emission Bandwidth	For reporting purposes only.	5470 ~ 5725 (For FCC) 5470 ~ 5600 (For ISED) 5650 ~ 5725 (For ISED)
6 dB Emission Bandwidth	The minimum 6 dB emission bandwidth shall be 500 kHz.	5725 ~ 5850
99 % Occupied Bandwidth	For reporting purposes only.	5150 ~ 5825 (For ISED)

### TEST PROCEDURE

Refer to KDB 789033 D02 General U-NII Test Procedures New Rules v02r01 section II.C1. for 26 dB Emission Bandwidth; section II.C2. for 6 dB Emission Bandwidth; section II.D. for 99 % Occupied Bandwidth.

Connect the EUT to the spectrum analyser and use the following settings:

Center Frequency	The center frequency of the channel under test
Detector	Peak
RBW	For 6 dB Emission Bandwidth: RBW=100 kHz For 26 dB Emission bandwidth: approximately 1 % of the EBW. For 99 % Occupied Bandwidth: approximately 1 % ~ 5 % of the OBW.
VBW	For 6 dB Bandwidth: $\geq 3 \times \text{RBW}$ For 26 dB Bandwidth: $> 3 \times \text{RBW}$ For 99 % Bandwidth: $> 3 \times \text{RBW}$
Trace	Max hold
Sweep	Auto couple

- Use the 99 % power bandwidth function of the instrument, allow the trace to stabilize and report the measured bandwidth.
- Allow the trace to stabilize and measure the maximum width of the emission that is constrained by the frequencies associated with the two outermost amplitude points (upper and lower frequencies) that are attenuated by 6/26 dB relative to the maximum level measured in the fundamental emission.

### Calculation for 99 % Bandwidth of UNII-2C and UNII-3 Straddle Channel:

For Example: Fundamental Frequency: 5720 MHz

99 % OBW: 21.00 MHz

Turning Frequency: 5725 MHz

99 % Bandwidth of UNII-2C Band Portion =  $(5725 - (5720 - (21.00/2))) = 15.50 \text{ MHz}$



99 % Bandwidth of UNII-3 Band Portion =  $(5720+(21.00/2)-5725) = 5.50$  MHz

**Calculation for 26 dB Bandwidth of UNII-2C Straddle Channel:**

For Example: Fundamental frequency: 5720 MHz

26 dB BW: 20.00 MHz

FL: 5710.16 MHz

FH: 5730.16 MHz

Turning Frequency: 5725 MHz

26 dB Bandwidth of UNII-2C Band Portion =  $5725-5710.16=14.84$  MHz

**Calculation for 6dB Bandwidth of UNII-3 Straddle Channel:**

For Example: Fundamental frequency: 5720 MHz

6 dB BW: 16.44 MHz

FL: 5711.76 MHz

FH: 5728.2 MHz

Turning Frequency: 5725 MHz

6 dB Bandwidth of UNII-3 band Portion =  $5728.2-5725=3.2$  MHz

**TEST SETUP**

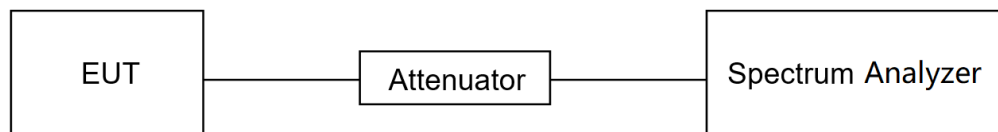

**TEST ENVIRONMENT**

Temperature	26.9°C	Relative Humidity	56.4%
Atmosphere Pressure	101kPa	Test Voltage	DC 12 V

**TEST DATE / ENGINEER**

Test Date	May 25, 2023	Test By	Johnson Liu
-----------	--------------	---------	-------------

**TEST RESULTS**

Please refer to section "Test Data" - Appendix A&B&C

### 7.3. CONDUCTED OUTPUT POWER

#### LIMITS

CFR 47 FCC Part15, Subpart E		
Test Item	Limit	Frequency Range (MHz)
Conducted Output Power	<input type="checkbox"/> Outdoor Access Point: 1 W (30 dBm) <input checked="" type="checkbox"/> Indoor Access Point: 1 W (30 dBm) <input type="checkbox"/> Fixed Point-To-Point Access Points: 1 W (30 dBm) <input type="checkbox"/> Client Devices: 250 mW (24 dBm)	5150 ~ 5250
	Shall not exceed the lesser of 250 mW (24dBm) or 11 dBm + 10 log B, where B is the 26 dB emission bandwidth in megahertz.	5250 ~ 5350 5470 ~ 5725
	Shall not exceed 1 Watt (30 dBm).	5725 ~ 5850

ISED RSS-247 ISSUE 2		
Test Item	Limit	Frequency Range (MHz)
Conducted Output Power or e.i.r.p.	The maximum e.i.r.p. shall not exceed 200 mW (23 dBm) or $10 + 10 \log_{10}B$ , dBm, whichever power is less. B is the 99 % emission bandwidth in megahertz.	5150 ~ 5250
	a. The maximum conducted output power shall not exceed 250 mW (24 dBm) or $11 + 10 \log_{10}B$ dBm, whichever is less.  b. The maximum e.i.r.p. shall not exceed 1.0 W (30 dBm) or $17 + 10 \log_{10}B$ dBm, whichever is less. B is the 99 % emission bandwidth in megahertz. Note that devices with a maximum e.i.r.p. greater than 500 mW shall implement TPC in order to have the capability to operate at least 6 dB below the maximum permitted e.i.r.p. of 1 W.	5250 ~ 5350 5470 ~ 5600 5650 ~ 5725
	Shall not exceed 1 Watt (30 dBm). The e.i.r.p. shall not exceed 4 W	5725 ~ 5850

#### Note:

The above limits are based upon the maximum antenna gain does not exceed 6 dBi. If transmitting antennas of directional gain greater than 6 dBi are used, the maximum conducted output power shall be reduced by the amount in dB that the directional gain of the antenna exceeds 6 dBi.

#### TEST PROCEDURE

Refer to KDB 789033 D02 General U-NII Test Procedures New Rules v02r01 section II.E.

#### Method SA-2 (trace averaging across ON and OFF times of the EUT transmissions, followed by duty cycle correction.):

- (a) Measure the duty cycle D of the transmitter output signal.
- (b) Set span to encompass the entire 26 dB EBW or 99% OBW of the signal.

- (c) Set RBW = 1 MHz.
- (d) Set VBW  $\geq$  3 MHz.
- (e) Number of points in sweep  $\geq$   $[2 \times \text{span} / \text{RBW}]$ . (This gives bin-to-bin spacing  $\leq$  RBW / 2, so that narrowband signals are not lost between frequency bins.)
- (f) Sweep time = auto.
- (g) Detector = RMS (i.e., power averaging), if available. Otherwise, use sample detector mode.
- (h) Do not use sweep triggering. Allow the sweep to “free run.”
- (i) Trace average at least 100 traces in power averaging (rms) mode; however, the number of traces to be averaged shall be increased above 100 as needed such that the average accurately represents the true average over the ON and OFF periods of the transmitter.
- j) Compute power by integrating the spectrum across the 26 dB EBW or 99% OBW of the signal using the instrument’s band power measurement function with band limits set equal to the EBW or OBW band edges. If the instrument does not have a band power function, then sum the spectrum levels (in power units) at 1 MHz intervals extending across the 26 dB EBW or 99% OBW of the spectrum.
- k) Add  $[10 \log (1 / D)]$ , where D is the duty cycle, to the measured power to compute the average power during the actual transmission times (because the measurement represents an average over both the ON and OFF times of the transmission). For example, add  $[10 \log (1 / 0.25)] = 6$  dB if the duty cycle is 25%.

**Method PM (Measurement using an RF average power meter):**

- (i) Measurements may be performed using a wideband RF power meter with a thermocouple detector or equivalent if all of the following conditions are satisfied:
  - a. The EUT is configured to transmit continuously or to transmit with a constant duty cycle.
  - b. At all times when the EUT is transmitting, it must be transmitting at its maximum power control level.
  - c. The integration period of the power meter exceeds the repetition period of the transmitted signal by at least a factor of five.
- (ii) If the transmitter does not transmit continuously, measure the duty cycle, x, of the transmitter output signal as described in II.B.
- (iii) Measure the average power of the transmitter. This measurement is an average over both the on and off periods of the transmitter.
- (iv) Adjust the measurement in dBm by adding  $10 \log (1/x)$  where x is the duty cycle (e.g.,  $10 \log (1/0.25)$  if the duty cycle is 25 %).

Note: Method SA-2 was used for straddle channel output power test, and Method PM was used for testing rest channels

**TEST SETUP**

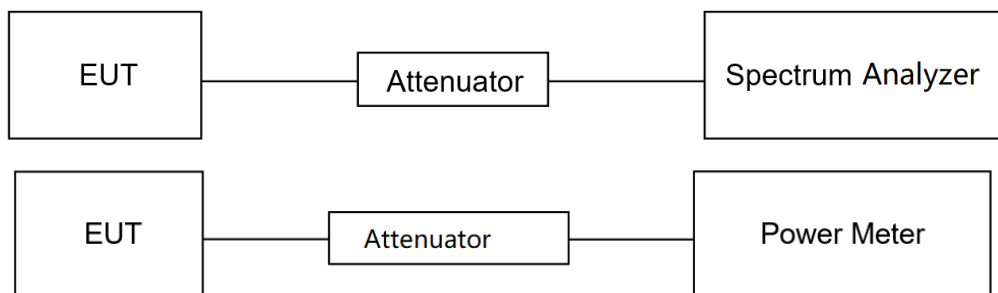

**TEST ENVIRONMENT**

Temperature	26.9°C	Relative Humidity	56.4%
Atmosphere Pressure	101kPa	Test Voltage	DC 12 V

**TEST DATE / ENGINEER**

Test Date	May 25, 2023	Test By	Johnson Liu
-----------	--------------	---------	-------------

**TEST RESULTS**

Please refer to section "Test Data" - Appendix D

## 7.4. POWER SPECTRAL DENSITY

### LIMITS

CFR 47 FCC Part15, Subpart E		
Test Item	Limit	Frequency Range (MHz)
Power Spectral Density	<input type="checkbox"/> Outdoor Access Point: 17 dBm/MHz <input checked="" type="checkbox"/> Indoor Access Point: 17 dBm/MHz <input type="checkbox"/> Fixed Point-To-Point Access Points: 17 dBm/MHz <input type="checkbox"/> Client Devices: 11 dBm/MHz	5150 ~ 5250
	11 dBm/MHz	5250 ~ 5350 5470 ~ 5725
	30 dBm/500kHz	5725 ~ 5850

ISED RSS-247 ISSUE 2		
Test Item	Limit	Frequency Range (MHz)
Power Spectral Density	The e.i.r.p. spectral density shall not exceed 10 dBm in any 1.0 MHz band.	5150 ~ 5250
	The power spectral density shall not exceed 11 dBm in any 1.0 MHz band.	5250 ~ 5350 5470 ~ 5600 5650 ~ 5725
	30 dBm / 500 kHz	5725 ~ 5850

#### Note:

The above limits are based upon the maximum antenna gain does not exceed 6 dBi. If transmitting antennas of directional gain greater than 6 dBi are used, maximum power spectral density shall be reduced by the amount in dB that the directional gain of the antenna exceeds 6 dBi.

### TEST PROCEDURE

Refer to KDB 789033 D02 General U-NII Test Procedures New Rules v02r01 section II.F.

Connect the EUT to the spectrum analyser and use the following settings:

For U-NII-1, U-NII-2A and U-NII-2C band:

Center Frequency	The center frequency of the channel under test
Detector	RMS
RBW	1 MHz
VBW	$\geq 3 \times$ RBW
Span	Encompass the entire emissions bandwidth (EBW) of the signal
Trace	Max hold
Sweep time	Auto

For U-NII-3:

Center Frequency	The center frequency of the channel under test
Detector	RMS
RBW	500 kHz
VBW	$\geq 3 \times \text{RBW}$
Span	Encompass the entire emissions bandwidth (EBW) of the signal
Trace	Max hold
Sweep time	Auto

Allow trace to fully stabilize and Use the peak search function on the instrument to find the peak of the spectrum and record its value.

Add  $10 \log(1/x)$ , where  $x$  is the duty cycle, to the peak of the spectrum, the result is the Maximum PSD over 1 MHz / 500 kHz reference bandwidth.

### **TEST SETUP**

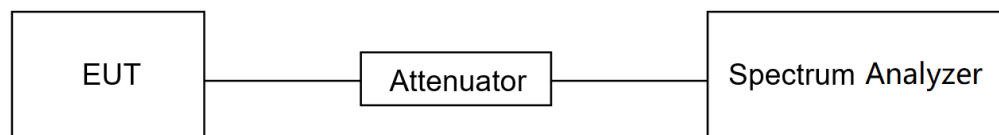

### **TEST ENVIRONMENT**

Temperature	26.9°C	Relative Humidity	56.4%
Atmosphere Pressure	101kPa	Test Voltage	DC 12 V

### **TEST DATE / ENGINEER**

Test Date	May 25, 2023	Test By	Johnson Liu
-----------	--------------	---------	-------------

### **TEST RESULTS**

Please refer to section "Test Data" - Appendix E

## 7.5. FREQUENCY STABILITY

### LIMITS

The frequency of the carrier signal shall be maintained within band of operation.

### TEST PROCEDURE

1. The EUT was placed inside an environmental chamber as the temperature in the chamber was varied between 0 °C ~ 40 °C (declared by customer).
2. The temperature was incremented by 10 °C intervals and the unit allowed to stabilize at each temperature before each measurement. The center frequency of the transmitting channel was evaluated at each temperature and the frequency deviation from the channel's center frequency was recorded.
3. The primary supply voltage is varied from 85 % to 115 % of the nominal value for non hand-carried battery and AC powered equipment. For hand-carried, battery-powered equipment, primary supply voltage is reduced to the battery operating end point which shall be specified by the manufacturer.

Connect the EUT to the spectrum analyser and use the following settings:

Center Frequency	The center frequency of the channel under test
Detector	Peak
RBW	10 kHz
VBW	$\geq 3 \times \text{RBW}$
Span	Encompass the entire emissions bandwidth (EBW) of the signal
Trace	Max hold
Sweep time	Auto

4. While maintaining a constant temperature inside the environmental chamber, turn the EUT on and record the operating frequency at startup, and at 2 minutes, 5 minutes, and 10 minutes after the EUT is energized.
5. Allow the trace to stabilize, find the peak value of the power envelope and record the frequency, then calculated the frequency drift.

### TEST ENVIRONMENT

	Normal Test Conditions	Extreme Test Conditions
Relative Humidity	20 % - 75 %	/
Atmospheric Pressure	100 kPa ~102 kPa	/
Temperature	T <sub>N</sub> (Normal Temperature): 25.1 °C	T <sub>L</sub> (Low Temperature): 0 °C
		T <sub>H</sub> (High Temperature): 40 °C
Supply Voltage	V <sub>N</sub> (Normal Voltage): DC 12 V	V <sub>L</sub> (Low Voltage): DC 10.2 V
		V <sub>H</sub> (High Voltage): DC 13.8 V

**TEST SETUP**

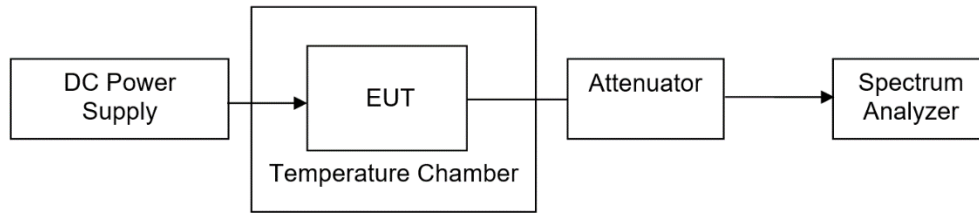

**TEST ENVIRONMENT**

Temperature	26.9°C	Relative Humidity	56.4%
Atmosphere Pressure	101kPa	Test Voltage	DC 12 V

**TEST DATE / ENGINEER**

Test Date	May 25, 2023	Test By	Johnson Liu
-----------	--------------	---------	-------------

**TEST RESULTS**

Please refer to section "Test Data" - Appendix F



## 8. RADIATED TEST RESULTS

### LIMITS

Refer to CFR 47 FCC §15.205, §15.209 and §15.407 (b).

Refer to ISED RSS-GEN Clause 8.9, Clause 8.10 and ISED RSS-247 6.2.

Radiation Disturbance Test Limit for FCC (Class B) (9 kHz ~ 1 GHz)

Emissions radiated outside of the specified frequency bands above 30 MHz			
Frequency Range (MHz)	Field Strength Limit (uV/m) at 3 m	Field Strength Limit (dBuV/m) at 3 m	
		Quasi-Peak	
30 - 88	100	40	
88 - 216	150	43.5	
216 - 960	200	46	
Above 960	500	54	
Above 1000	500	Peak	Average
		74	54

FCC Emissions radiated outside of the specified frequency bands below 30 MHz		
Frequency (MHz)	Field strength (microvolts/meter)	Measurement distance (meters)
0.009-0.490	2400/F(kHz)	300
0.490-1.705	24000/F(kHz)	30
1.705-30.0	30	30

ISED General field strength limits at frequencies below 30 MHz

Table 6 – General field strength limits at frequencies below 30 MHz		
Frequency	Magnetic field strength (H-Field) (µA/m)	Measurement distance (m)
9 - 490 kHz <sup>Note 1</sup>	6.37/F (F in kHz)	300
490 - 1705 kHz	63.7/F (F in kHz)	30
1.705 - 30 MHz	0.08	30

**Note 1:** The emission limits for the ranges 9-90 kHz and 110-490 kHz are based on measurements employing a linear average detector.

ISED Restricted bands refer to ISED RSS-GEN Clause 8.10

Table 7 – Restricted frequency bands <sup>Note 1</sup>		
MHz	MHz	GHz
0.090 - 0.110	149.9 - 150.05	9.0 - 9.2
0.495 - 0.505	156.52475 - 156.52525	9.3 - 9.5
2.1735 - 2.1905	156.7 - 156.9	10.6 - 12.7
3.020 - 3.026	162.0125 - 167.17	13.25 - 13.4
4.125 - 4.128	167.72 - 173.2	14.47 - 14.5
4.17725 - 4.17775	240 - 285	15.35 - 16.2
4.20725 - 4.20775	322 - 335.4	17.7 - 21.4
5.677 - 5.683	399.9 - 410	22.01 - 23.12
6.215 - 6.218	608 - 614	23.6 - 24.0
6.26775 - 6.26825	960 - 1427	31.2 - 31.8
6.31175 - 6.31225	1435 - 1626.5	36.43 - 36.5
8.291 - 8.294	1645.5 - 1646.5	Above 38.6
8.362 - 8.366	1680 - 1710	
8.37625 - 8.38675	1718.8 - 1722.2	
8.41425 - 8.41475	2200 - 2300	
12.29 - 12.293	2310 - 2390	
12.51975 - 12.52025	2483.5 - 2500	
12.57675 - 12.57725	2655 - 2900	
13.36 - 13.41	3260 - 3267	
16.42 - 16.423	3332 - 3339	
16.80475 - 16.80525	3345.8 - 3358	
16.80425 - 16.80475	3500 - 4400	
25.5 - 25.67	4500 - 5150	
37.5 - 38.25	5350 - 5400	
73 - 74.6	7250 - 7750	
74.8 - 75.2	8025 - 8500	
108 - 138		

**Note 1:** Certain frequency bands listed in table 7 and in bands above 38.6 GHz are designated for licence-exempt applications. These frequency bands and the requirements that apply to related devices are set out in the 200 and 300 series of RSSs.

FCC Restricted bands of operation refer to FCC §15.205 (a):

MHz	MHz	MHz	GHz
0.090-0.110	16.42-16.423	399.9-410	4.5-5.15
<sup>1</sup> 0.495-0.505	16.69475-16.69525	608-614	5.35-5.46
2.1735-2.1905	16.80425-16.80475	960-1240	7.25-7.75
4.125-4.128	25.5-25.67	1300-1427	8.025-8.5
4.17725-4.17775	37.5-38.25	1435-1626.5	9.0-9.2
4.20725-4.20775	73-74.6	1645.5-1646.5	9.3-9.5
6.215-6.218	74.8-75.2	1660-1710	10.6-12.7
6.26775-6.26825	108-121.94	1718.8-1722.2	13.25-13.4
6.31175-6.31225	123-138	2200-2300	14.47-14.5
8.291-8.294	149.9-150.05	2310-2390	15.35-16.2
8.362-8.366	156.52475-156.52525	2483.5-2500	17.7-21.4
8.37625-8.38675	156.7-156.9	2690-2900	22.01-23.12
8.41425-8.41475	162.0125-167.17	3260-3267	23.6-24.0
12.29-12.293	167.72-173.2	3332-3339	31.2-31.8
12.51975-12.52025	240-285	3345.8-3358	36.43-36.5
12.57675-12.57725	322-335.4	3600-4400	( <sup>2</sup> )
13.36-13.41			

Note: <sup>1</sup>Until February 1, 1999, this restricted band shall be 0.490-0.510 MHz.

<sup>2</sup>Above 38.6c

Limits of unwanted/undesirable emission out of the restricted bands refer to CFR 47 FCC §15.407 (b) and ISED RSS-247 6.2.

LIMITS OF RADIATED EMISSION MEASUREMENT (Above 1GHz)		
Frequency Range (MHz)	EIRP Limit	Field Strength Limit (dBuV/m) at 3 m
5150~5250 MHz	PK: -27 (dBm/MHz)	PK:68.2(dBμV/m)
5250~5350 MHz		
5470~5725 MHz		
5725~5850 MHz	PK: -27 (dBm/MHz) *1 PK: 10 (dBm/MHz) *2 PK: 15.6 (dBm/MHz) *3 PK: 27 (dBm/MHz) *4	PK: 68.2(dBμV/m) *1 PK: 105.2 (dBμV/m) *2 PK: 110.8(dBμV/m) *3 PK: 122.2 (dBμV/m) *4
Note: *1 beyond 75 MHz or more above of the band edge. *2 below the band edge increasing linearly to 10 dBm/MHz at 25 MHz above. *3 below the band edge increasing linearly to a level of 15.6 dBm/MHz at 5 MHz above. *4 from 5 MHz above or below the band edge increasing linearly to a level of 27 dBm/MHz at the band edge.		

## **TEST PROCEDURE**

Below 30 MHz

The setting of the spectrum analyser

RBW	200 Hz (From 9 kHz to 0.15 MHz)/ 9 kHz (From 0.15 MHz to 30 MHz)
VBW	200 Hz (From 9 kHz to 0.15 MHz)/ 9 kHz (From 0.15 MHz to 30 MHz)
Sweep	Auto

1. The testing follows the guidelines in ANSI C63.10-2013 clause 6.4.
2. The EUT was arranged to its worst case and then turntable (from 0 degree to 360 degrees) to find the maximum reading. A pre-amp and a high pass filter are used for the test in order to get better signal level. Both Horizontal, Face-on and Face-off polarizations of the antenna are set to make the measurement.
3. The EUT was placed on a turntable with 80 cm above ground.
4. The EUT was set 3 meters from the interference receiving antenna, which was mounted on the top of a 1 m height antenna tower.
5. The radiated emission limits are based on measurements employing a CISPR quasi-peak detector except for the frequency bands 9-90 kHz, 110-490 kHz and above 1000 MHz Radiated emission limits in these three bands are based on measurements employing an average detector.
6. For measurement below 1 GHz, the initial step in collecting conducted emission data is a spectrum analyzer peak detector mode pre-scanning the measurement frequency range. Significant peaks are then marked and then Quasi Peak and average detector mode re-measured. If the emission level of the EUT measured by the peak detector is 3 dB lower than the applicable limit, the peak emission level will be reported. Otherwise, the emission measurement will be repeated using the quasi-peak and average detector and reported.

7. Although these tests were performed other than open field site, adequate comparison measurements were confirmed against 30m open field site. Therefore sufficient tests were made to demonstrate that the alternative site produces results that correlate with the ones of tests made in an open field site based on KDB 414788.

8. The limits in CFR 47, Part 15, Subpart C, paragraph 15.209 (a), are identical to those in RSS-GEN Section 8.9, Table 6, since the measurements are performed in terms of magnetic field strength and converted to electric field strength levels (as reported in the table) using the free space impedance of  $377\Omega$ . For example, the measurement frequency X KHz resulted in a level of Y dBuV/m, which is equivalent to  $Y-51.5 = Z$  dBuA/m, which has the same margin, W dB, to the corresponding RSS-GEN Table 6 limit as it has to be 15.209(a) limit.

Below 1 GHz and above 30 MHz

The setting of the spectrum analyser

RBW	120 kHz
VBW	300 kHz
Sweep	Auto
Detector	Peak/QP
Trace	Max hold

1. The testing follows the guidelines in ANSI C63.10-2013 clause 6.5.
2. The EUT was arranged to its worst case and then tune the antenna tower (from 1 m to 4 m) and turntable (from 0 degree to 360 degrees) to find the maximum reading. A pre-amp and a high pass filter are used for the test in order to get better signal level. Both horizontal and vertical polarizations of the antenna are set to make the measurement.
3. The EUT was placed on a turntable with 80 cm above ground.
4. The EUT was set 3 meters from the interference receiving antenna, which was mounted on the top of a variable height antenna tower.
5. For measurement below 1 GHz, the initial step in collecting conducted emission data is a spectrum analyzer peak detector mode pre-scanning the measurement frequency range. Significant peaks are then marked and then Quasi Peak detector mode re-measured. If the emission level of the EUT measured by the peak detector is 3 dB lower than the applicable limit, the peak emission level will be reported. Otherwise, the emission measurement will be repeated using the quasi-peak detector and reported.

Above 1 GHz

The setting of the spectrum analyser

RBW	1 MHz
VBW	PEAK: 3 MHz AVG: see note 6
Sweep	Auto
Detector	Peak
Trace	Max hold

1. The testing follows the guidelines in KDB 789033 D02 General U-NII Test Procedures New Rules v02r01 section II.G.3 ~ II.G.6.
2. The EUT was arranged to its worst case and then tune the antenna tower (from 1 m to 4 m) and turntable (from 0 degree to 360 degrees) to find the maximum reading. A pre-amp and a high pass filter are used for the test in order to get better signal level. Both horizontal and vertical polarizations of the antenna are set to make the measurement.
3. The EUT was placed on a turntable with 1.5 m above ground.
4. The EUT was set 3 meters from the interference receiving antenna, which was mounted on the top of a variable height antenna tower.
5. For measurement above 1 GHz, the emission measurement will be measured by the peak detector. This peak level, once corrected, must comply with the limit specified in Section 15.209.
6. For measurements above 1 GHz the resolution bandwidth is set to 1 MHz, then the video bandwidth is set to 3 MHz for peak measurements and 1 MHz resolution bandwidth with 1/T video bandwidth with peak detector for average measurements. For the Duty Cycle please refer to clause 7.1.ON TIME AND DUTY CYCLE.

X axis, Y axis, Z axis positions:

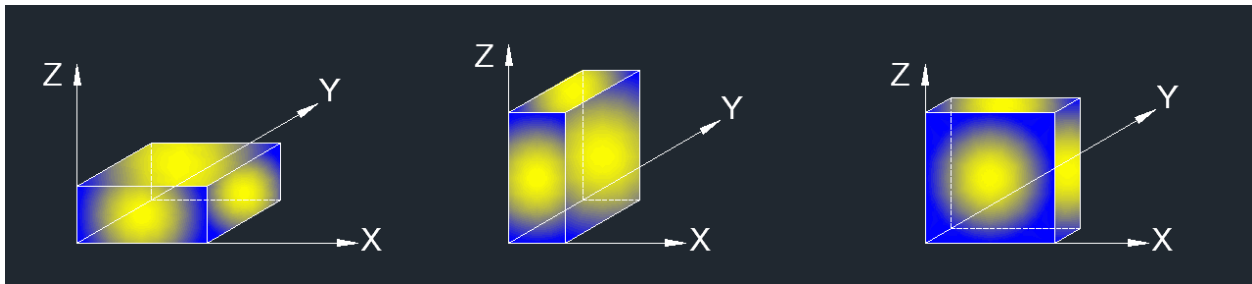

Note 1: For all radiated test, EUT in each of three orthogonal axis emissions had been tested, but only the worst case (X axis) data recorded in the report.

Note 2: The EUT was fully exercised with external accessories during the test. In the case of multiple accessory external ports, an external accessory shall be connected to one of each type of port.

For Band edge:

Note:

1. Measurement = Reading Level + Correct Factor.
2. If the Peak values are less than the Average limit of 54 dBuV/m, the Average result is deemed to comply with Average limit.
3. Peak: Peak detector.
4. AVG:  $VBW=1/Ton$ , where: Ton is the transmitting duration.
5. For the transmitting duration, please refer to clause 7.1.
6. Only the worst data was recorded, if it complies with the limit, the other emissions deemed to comply with the limit.
7. Horizontal and Vertical have been tested, only the worst data was recorded in the report.
8. All modes, channels and antennas have been tested, only the worst data was recorded in the report.

For Radiate Spurious emission 1GHz-7GHz:

Note:

1. Measurement = Reading Level + Correct Factor.
2. If the Peak values are less than the Average limit of 54 dBuV/m, the Average result is deemed to comply with Average limit.
3. Peak: Peak detector.
4. AVG:  $VBW=1/Ton$ , where: Ton is the transmitting duration.
5. For the transmitting duration, please refer to clause 7.1.
6. Filter losses were only considered in the spurious frequency bands and the authorized band was not corrected for Band reject filter losses.
7. Proper operation of the transmitter prior to adding the filter to the measurement chain.
8. Since non-restricted band peak emissions are less than the average limit, they also comply with the -27dBm/MHz (68.2dBuV/m) limit.
9. All modes, channels and antennas have been tested, only the worst data was recorded in the report.

For Radiate Spurious emission 7GHz-18GHz:

Note:

1. Measurement = Reading Level + Correct Factor.
2. If the Peak values are less than the Average limit of 54 dBuV/m, the Average result is deemed to comply with Average limit.
3. Peak: Peak detector.
4. AVG:  $VBW=1/Ton$ , where: Ton is the transmitting duration.
5. For the transmitting duration, please refer to clause 7.1.
6. Filter losses were only considered in the spurious frequency bands and the authorized band was not corrected for High Pass Filter losses.
7. Proper operation of the transmitter prior to adding the filter to the measurement chain.
8. Since non-restricted band peak emissions are less than the average limit, they also comply with the -27dBm/MHz (68.2dBuV/m) limit.
9. All modes, channels and antennas have been tested, only the worst data was recorded in the report.

For Radiate Spurious emission 9kHz-30MHz:

Note:

1. Measurement = Reading Level + Correct Factor  
(dBuA/m= dBuV/m- 20Log10[120π] = dBuV/m- 51.5).
2. If the Peak values are less than the QP limit, the QP result is deemed to comply with QP limit.
3. All 3 polarizations (Horizontal, Face-on and Face-off) of the loop antenna had been tested, but only the worst data recorded in the report.
4. All modes, channels and antennas have been tested, only the worst data was recorded in the report.

For Radiate Spurious emission 18GHz-26GHz:

Note:

1. Measurement = Reading Level + Correct Factor.
2. If the Peak values are less than the Average limit of 54 dBuV/m, the Average result is deemed to comply with Average limit.
3. Peak: Peak detector.
4. All modes, channels and antennas have been tested, only the worst data was recorded in the report.

For Radiate Spurious emission 26GHz-40GHz:

Note:

1. Measurement = Reading Level + Correct Factor.
2. If the Peak values are less than the Average limit of 54 dBuV/m, the Average result is deemed to comply with Average limit.
3. Peak: Peak detector.
4. All modes, channels and antennas have been tested, only the worst data was recorded in the report.

For Radiate Spurious emission 30MHz-1GHz:

Note:

1. Result Level = Read Level + Correct Factor.
2. If the Peak values are less than the QP limit, the QP result is deemed to comply with QP limit.
3. Test setup: RBW: 120 kHz, VBW: 300 kHz, Sweep time: auto.
4. All modes, channels and antennas have been tested, only the worst data was recorded in the report.



**TEST SETUP**

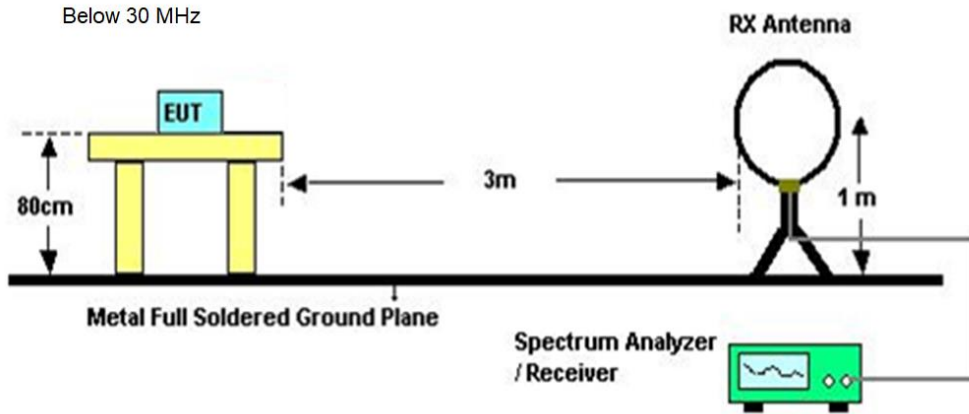

Below 1 GHz and above 30 MHz

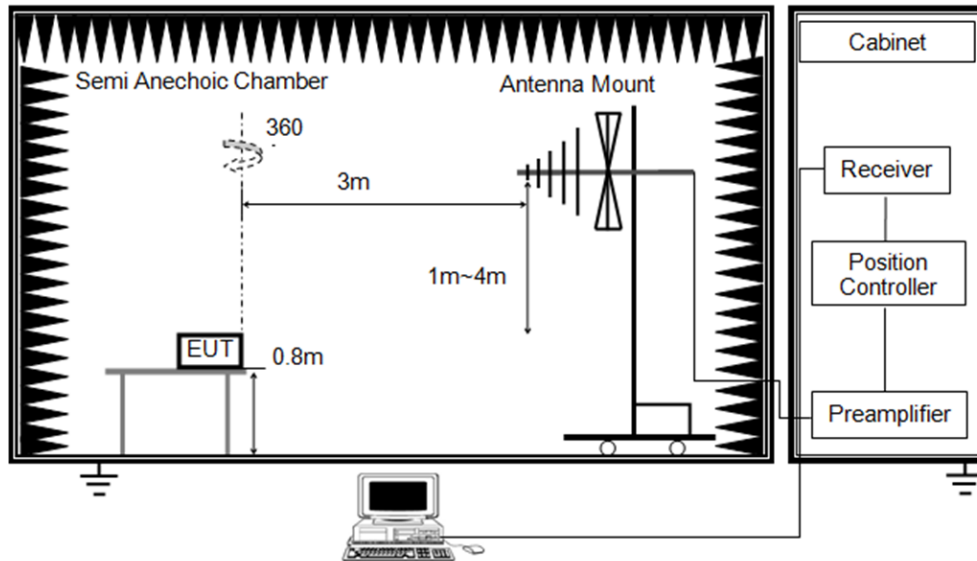

Above 1 GHz

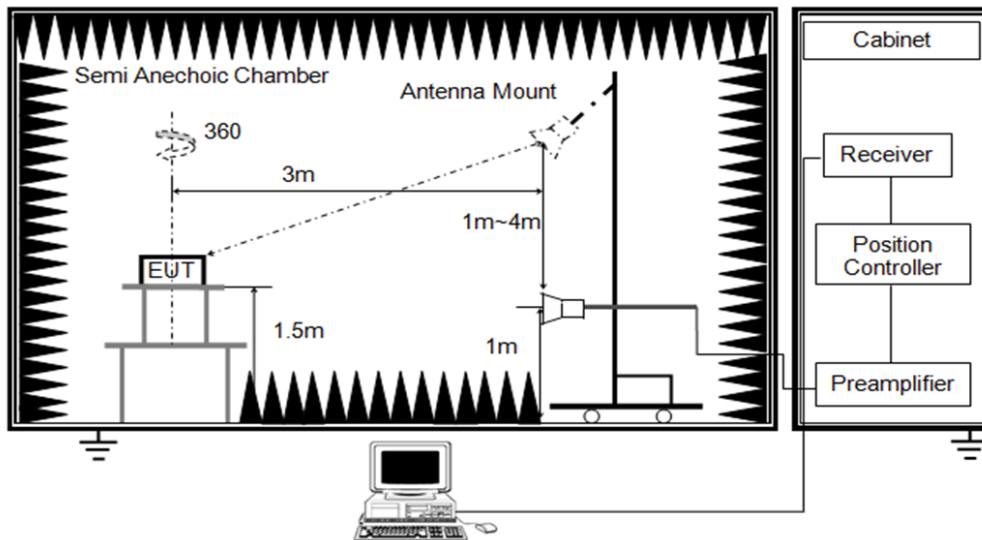

**TEST ENVIRONMENT**

Temperature	24.9°C	Relative Humidity	63%
Atmosphere Pressure	101kPa	Test Voltage	

**TEST DATE / ENGINEER**

Test Date	May 24, 2023	Test By	Rex Huang
-----------	--------------	---------	-----------

**TEST RESULTS**

## 8.1. RESTRICTED BANDEDGE

For FCC UNII-1&UNII-3; ISED UNII-3 test data:

Test Mode:	802.11a 20 PK	Channel:	5180
Polarity:	Vertical	Test Voltage:	DC 12 V

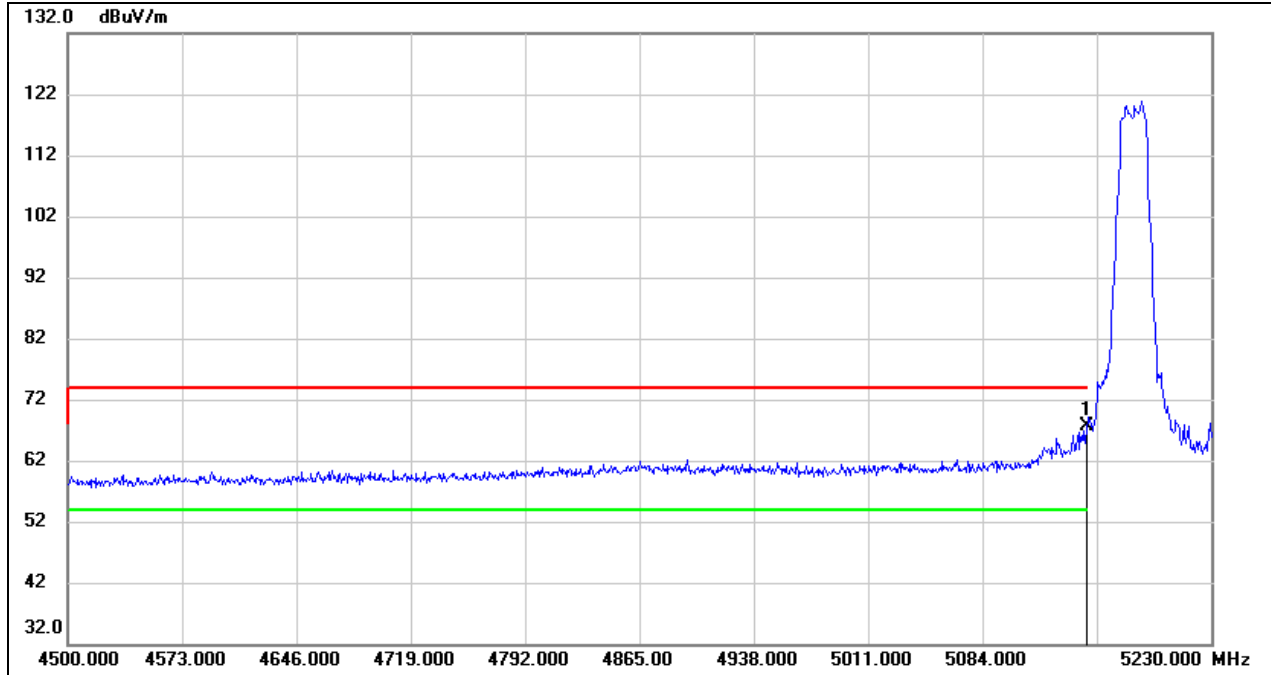

No.	Frequency (MHz)	Reading (dBuV)	Correct (dB/m)	Result (dBuV/m)	Limit (dBuV/m)	Margin (dB)	Remark
1	5150.000	27.26	40.27	67.53	74.00	-6.47	peak

Test Mode:	802.11a 20 AV	Channel:	5180
Polarity:	Vertical	Test Voltage:	DC 12 V

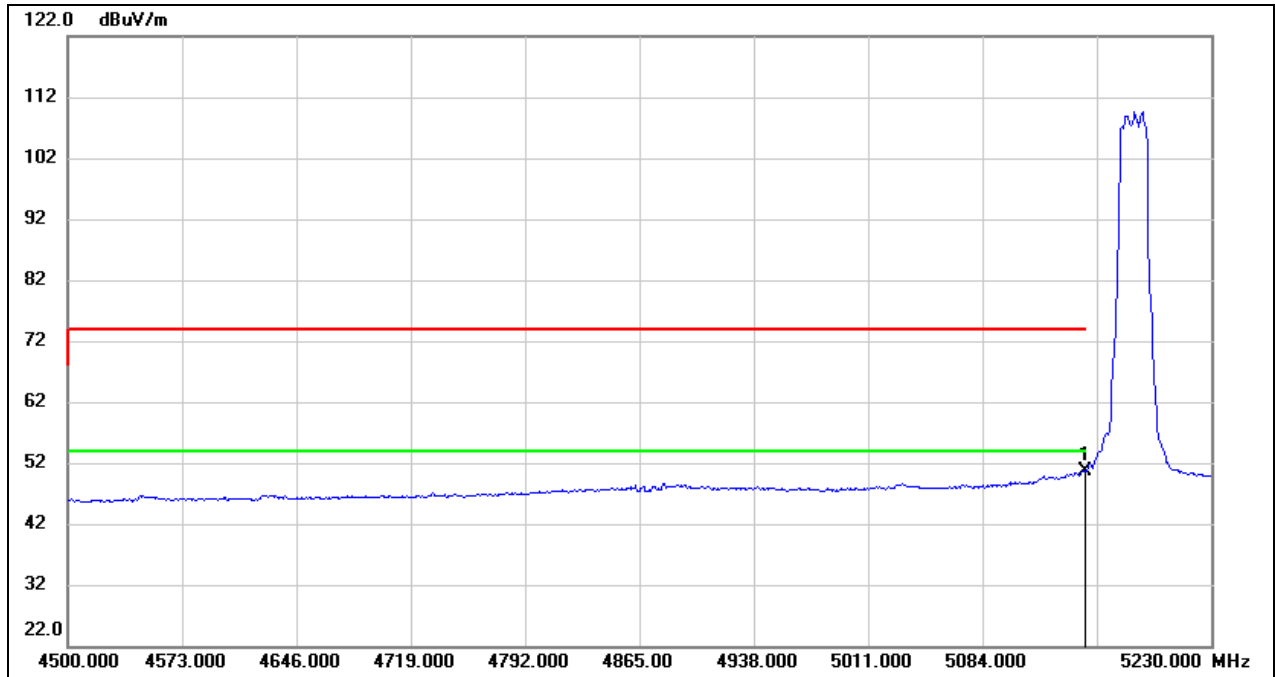

No.	Frequency (MHz)	Reading (dBuV)	Correct (dB/m)	Result (dBuV/m)	Limit (dBuV/m)	Margin (dB)	Remark
1	5150.000	10.25	40.27	50.52	54.00	-3.48	AVG

Test Mode:	802.11a 20 PK	Channel:	5240
Polarity:	Vertical	Test Voltage:	DC 12 V

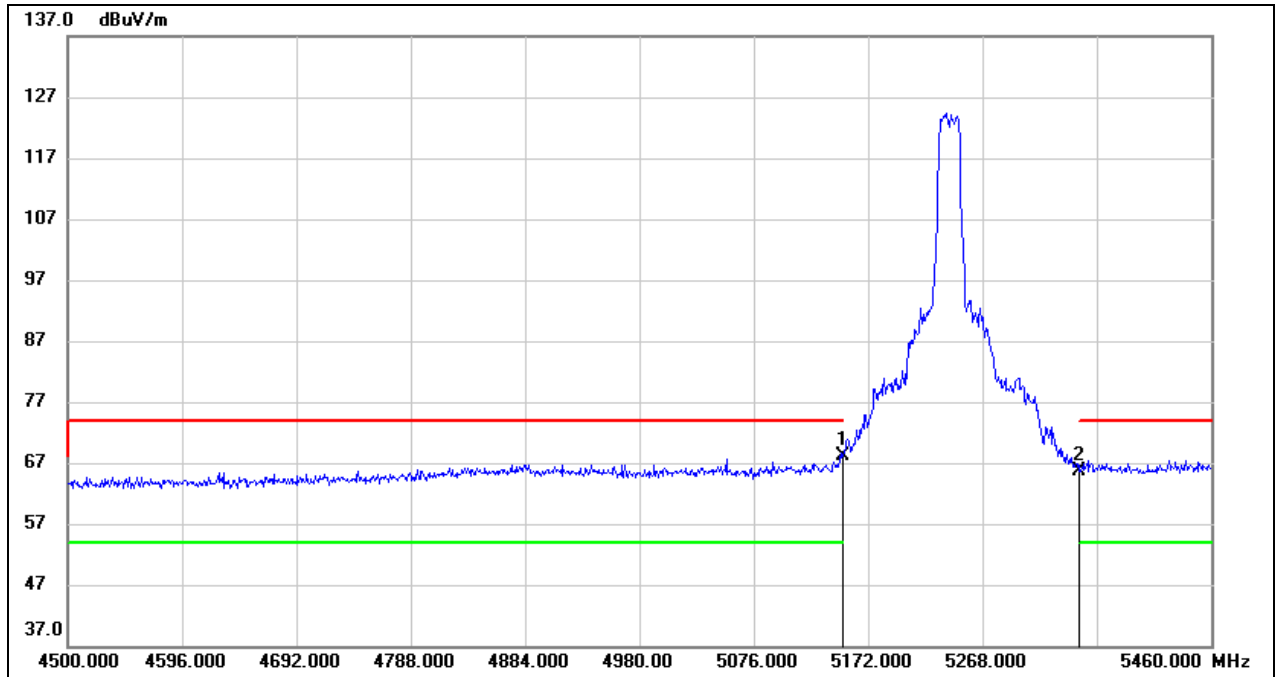

No.	Frequency (MHz)	Reading (dBuV)	Correct (dB/m)	Result (dBuV/m)	Limit (dBuV/m)	Margin (dB)	Remark
1	5150.000	27.82	40.27	68.09	74.00	-5.91	peak
2	5350.000	25.05	40.49	65.54	74.00	-8.46	peak

Test Mode:	802.11a 20 AV	Channel:	5240
Polarity:	Vertical	Test Voltage:	DC 12 V

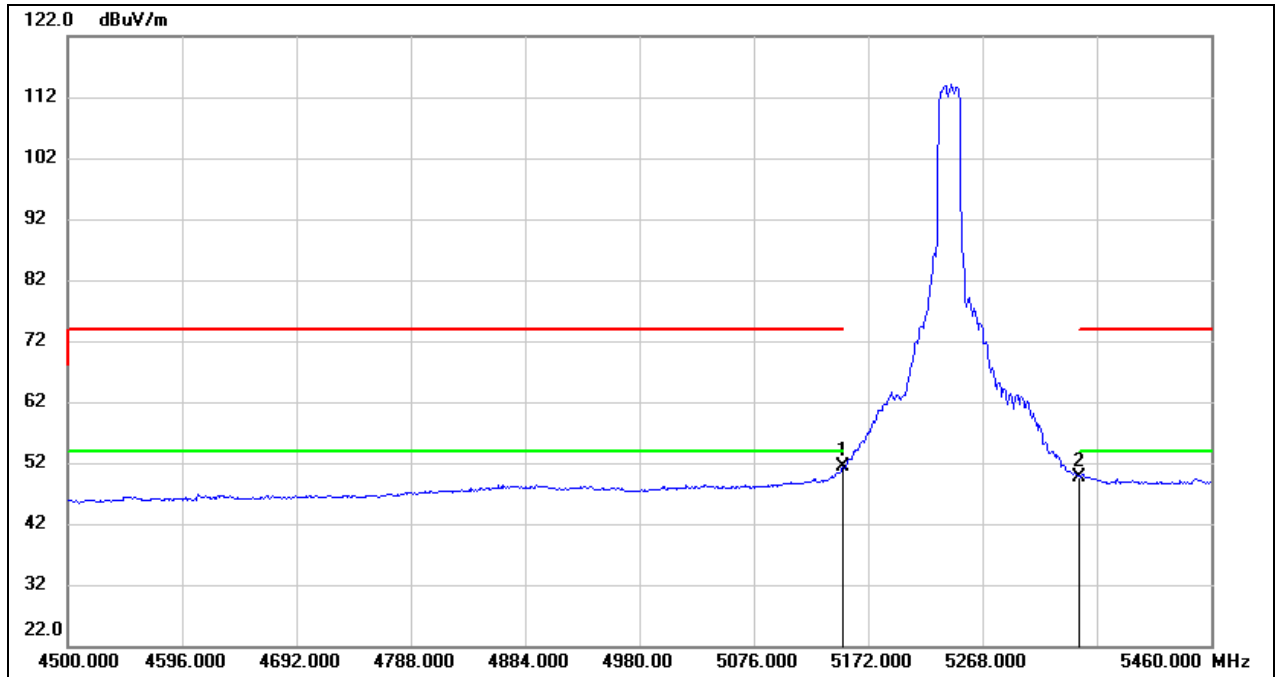

No.	Frequency (MHz)	Reading (dBuV)	Correct (dB/m)	Result (dBuV/m)	Limit (dBuV/m)	Margin (dB)	Remark
1	5150.000	11.09	40.27	51.36	54.00	-2.64	AVG
2	5350.000	9.22	40.49	49.71	54.00	-4.29	AVG

Test Mode:	802.11a 20 PK	Channel:	5745
Polarity:	Vertical	Test Voltage:	DC 12 V

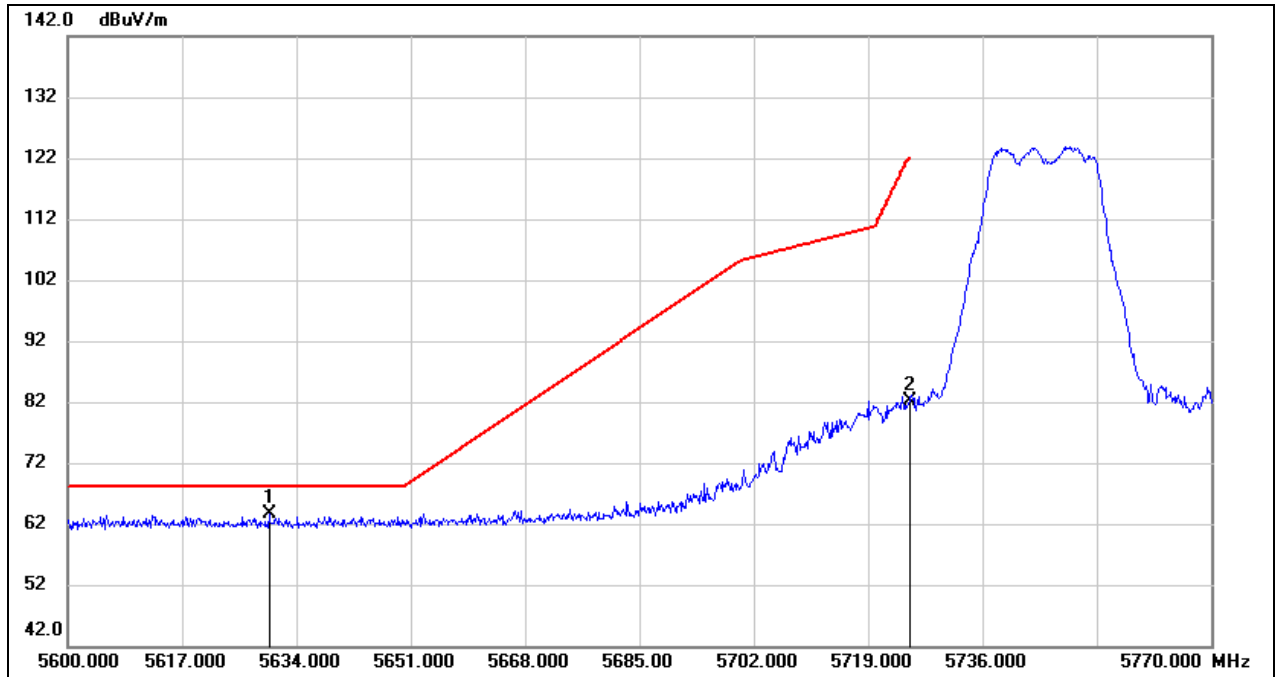

No.	Frequency (MHz)	Reading (dBuV)	Correct (dB/m)	Result (dBuV/m)	Limit (dBuV/m)	Margin (dB)	Remark
1	5629.920	22.61	41.01	63.62	68.20	-4.58	peak
2	5725.000	40.84	41.27	82.11	122.20	-40.09	peak

Test Mode:	802.11a 20 PK	Channel:	5825
Polarity:	Vertical	Test Voltage:	DC 12 V

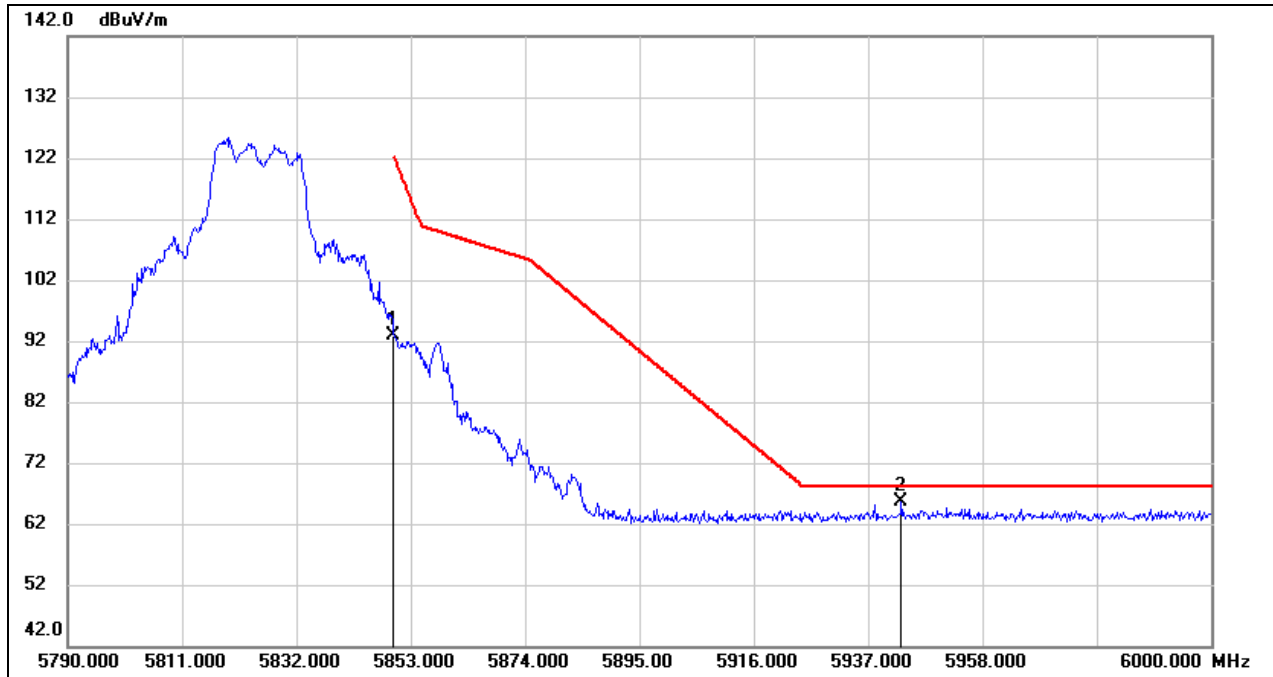

No.	Frequency (MHz)	Reading (dBuV)	Correct (dB/m)	Result (dBuV/m)	Limit (dBuV/m)	Margin (dB)	Remark
1	5850.000	51.29	41.60	92.89	122.20	-29.31	peak
2	5943.090	23.68	41.84	65.52	68.20	-2.68	peak



Test Mode:	802.11ax HE20 PK	Channel:	5180
Polarity:	Vertical	Test Voltage:	DC 12 V

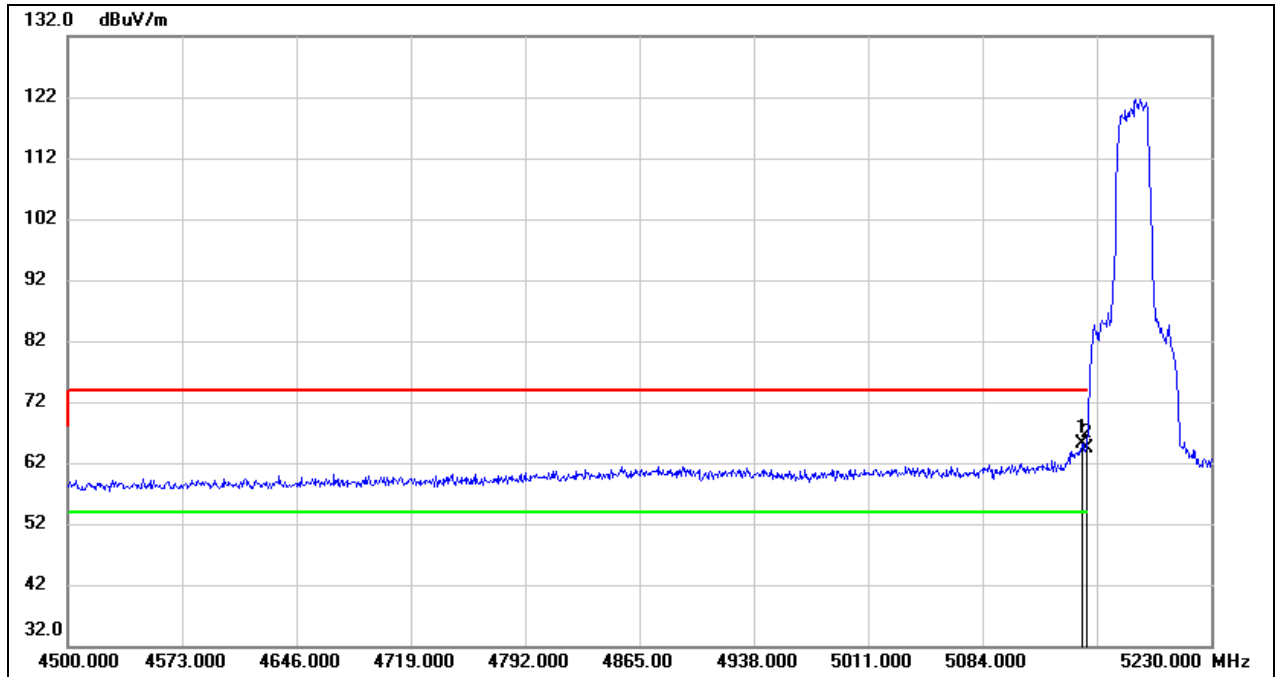

No.	Frequency (MHz)	Reading (dBuV)	Correct (dB/m)	Result (dBuV/m)	Limit (dBuV/m)	Margin (dB)	Remark
1	5147.510	24.92	40.28	65.20	74.00	-8.80	peak
2	5150.000	24.15	40.27	64.42	74.00	-9.58	peak

Test Mode:	802.11ax HE20 AV	Channel:	5180
Polarity:	Vertical	Test Voltage:	DC 12 V

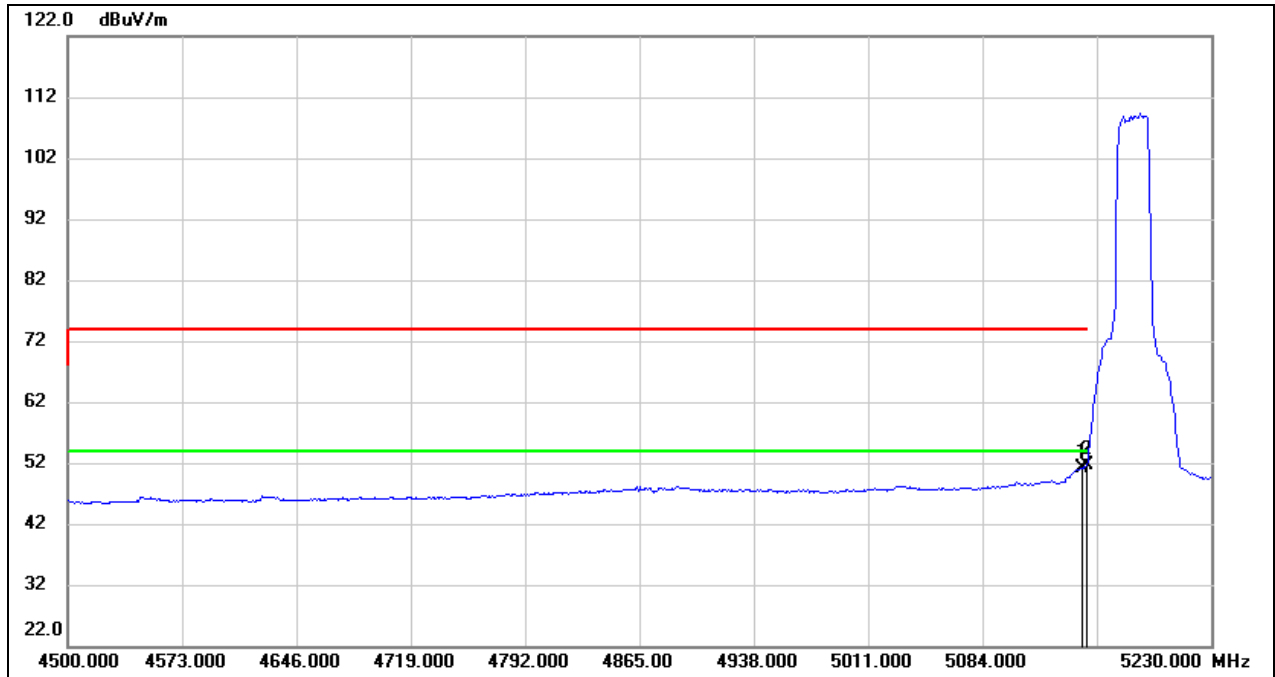

No.	Frequency (MHz)	Reading (dBuV)	Correct (dB/m)	Result (dBuV/m)	Limit (dBuV/m)	Margin (dB)	Remark
1	5147.510	10.88	40.28	51.16	54.00	-2.84	AVG
2	5150.000	11.35	40.27	51.62	54.00	-2.38	AVG

Test Mode:	802.11ax HE20 PK	Channel:	5240
Polarity:	Vertical	Test Voltage:	DC 12 V

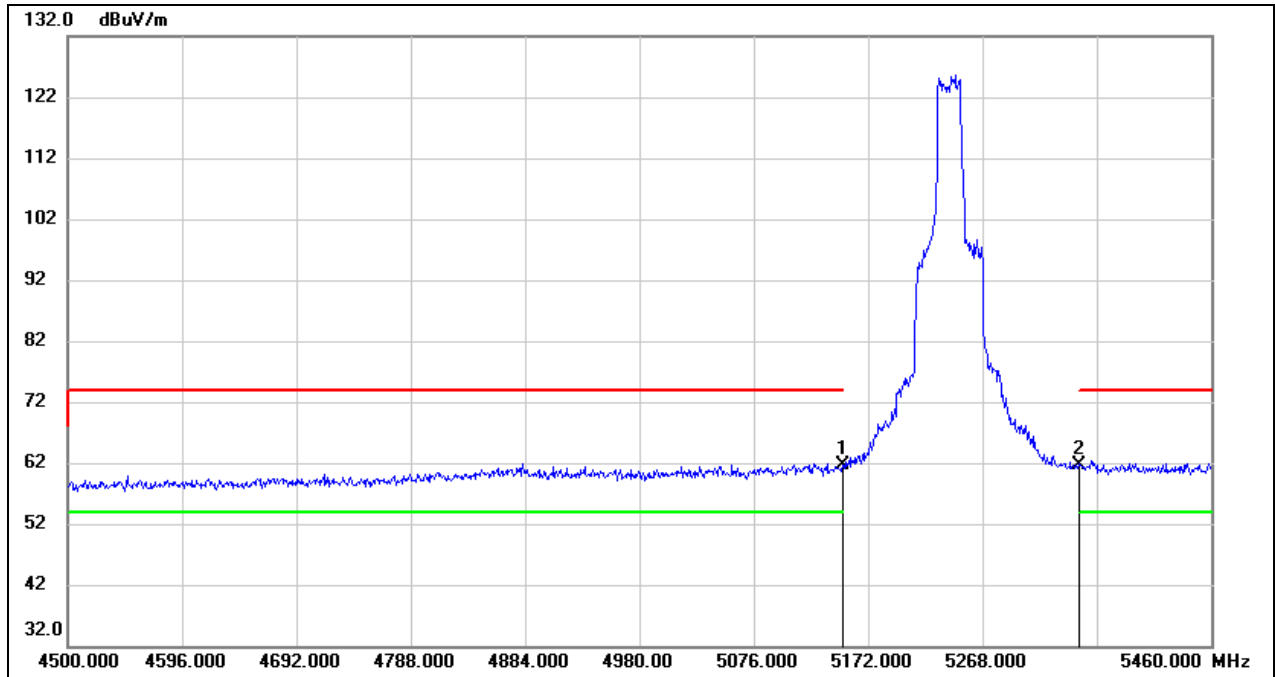

No.	Frequency (MHz)	Reading (dBuV)	Correct (dB/m)	Result (dBuV/m)	Limit (dBuV/m)	Margin (dB)	Remark
1	5150.000	21.37	40.27	61.64	74.00	-12.36	peak
2	5350.000	21.15	40.49	61.64	74.00	-12.36	peak

Test Mode:	802.11ax HE20 AV	Channel:	5240
Polarity:	Vertical	Test Voltage:	DC 12 V

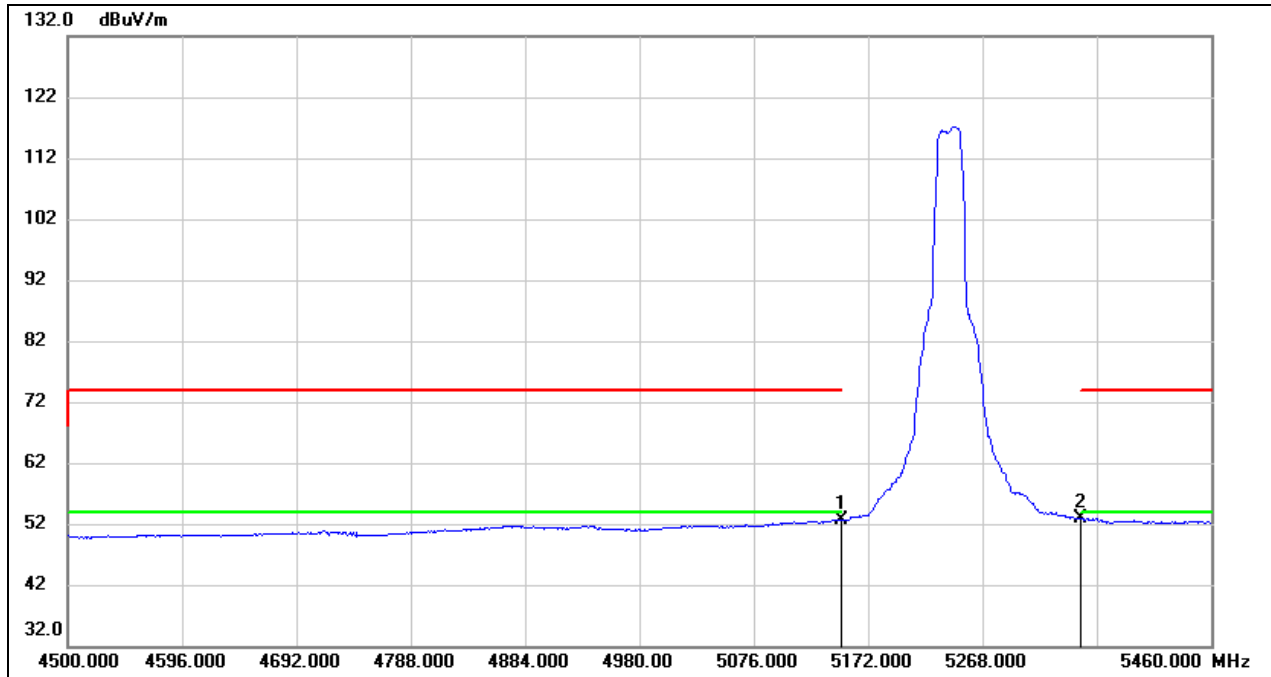

No.	Frequency (MHz)	Reading (dBuV)	Correct (dB/m)	Result (dBuV/m)	Limit (dBuV/m)	Margin (dB)	Remark
1	5150.000	12.29	40.27	52.56	54.00	-1.44	AVG
2	5350.000	12.35	40.49	52.84	54.00	-1.16	AVG

Test Mode:	802.11ax HE20 PK	Channel:	5745
Polarity:	Vertical	Test Voltage:	DC 12 V

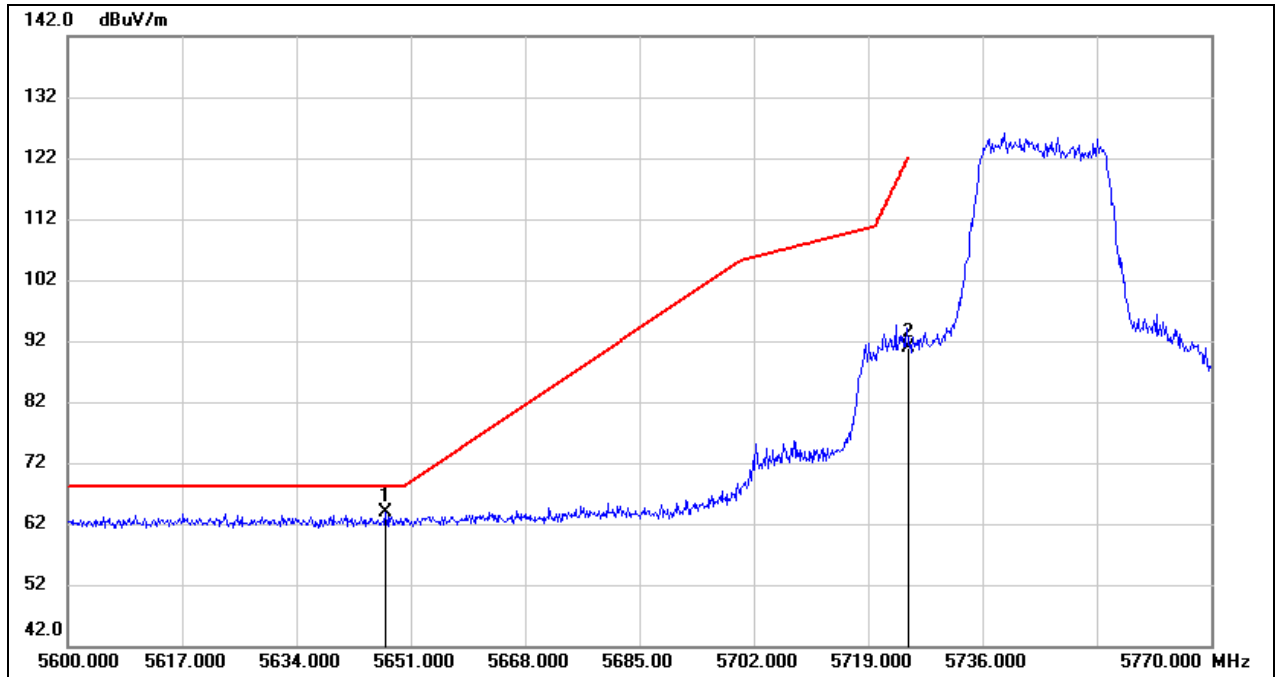

No.	Frequency (MHz)	Reading (dBuV)	Correct (dB/m)	Result (dBuV/m)	Limit (dBuV/m)	Margin (dB)	Remark
1	5647.260	22.83	41.06	63.89	68.20	-4.31	peak
2	5725.000	49.67	41.27	90.94	122.20	-31.26	peak

Test Mode:	802.11ax HE20 PK	Channel:	5825
Polarity:	Vertical	Test Voltage:	DC 12 V

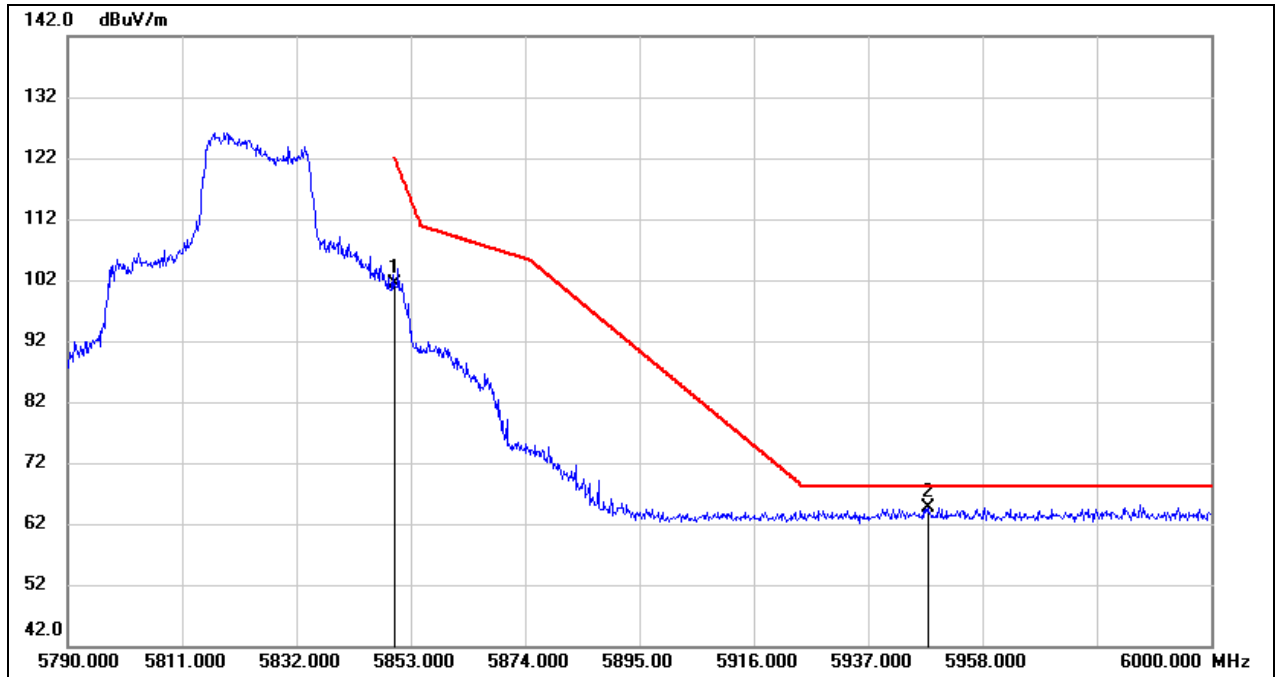

No.	Frequency (MHz)	Reading (dBuV)	Correct (dB/m)	Result (dBuV/m)	Limit (dBuV/m)	Margin (dB)	Remark
1	5850.000	59.66	41.60	101.26	122.20	-20.94	peak
2	5947.920	22.84	41.86	64.70	68.20	-3.50	peak

Test Mode:	802.11ax HE40 PK	Channel:	5190
Polarity:	Vertical	Test Voltage:	DC 12 V

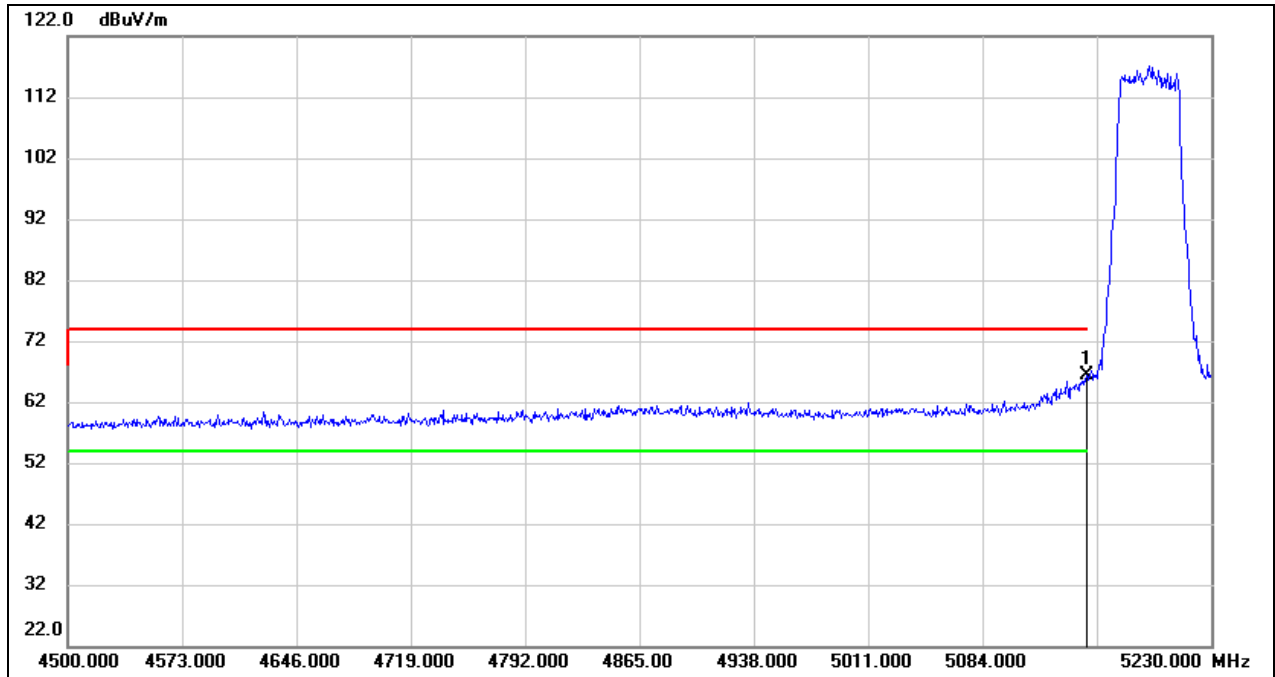

No.	Frequency (MHz)	Reading (dBuV)	Correct (dB/m)	Result (dBuV/m)	Limit (dBuV/m)	Margin (dB)	Remark
1	5150.000	26.14	40.27	66.41	74.00	-7.59	peak

Test Mode:	802.11ax HE40 AV	Channel:	5190
Polarity:	Vertical	Test Voltage:	DC 12 V

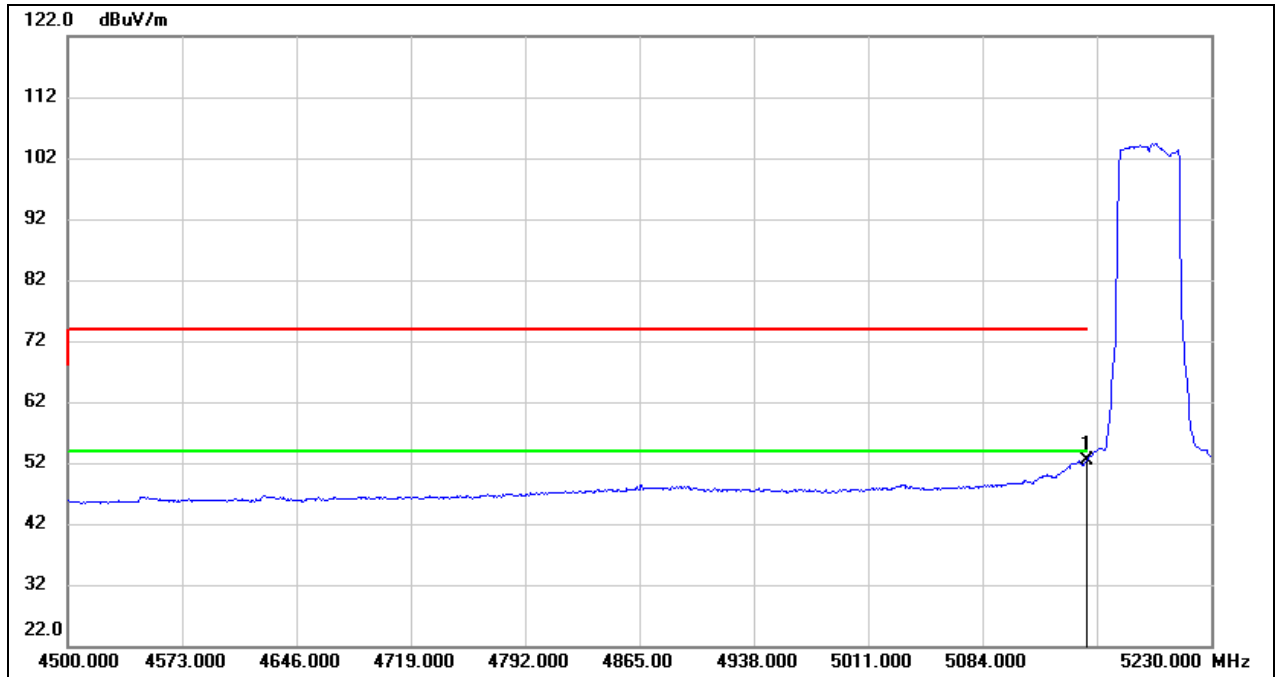

No.	Frequency (MHz)	Reading (dBuV)	Correct (dB/m)	Result (dBuV/m)	Limit (dBuV/m)	Margin (dB)	Remark
1	5150.000	12.19	40.27	52.46	54.00	-1.54	AVG



Test Mode:	802.11ax HE40 PK	Channel:	5755
Polarity:	Vertical	Test Voltage:	DC 12 V

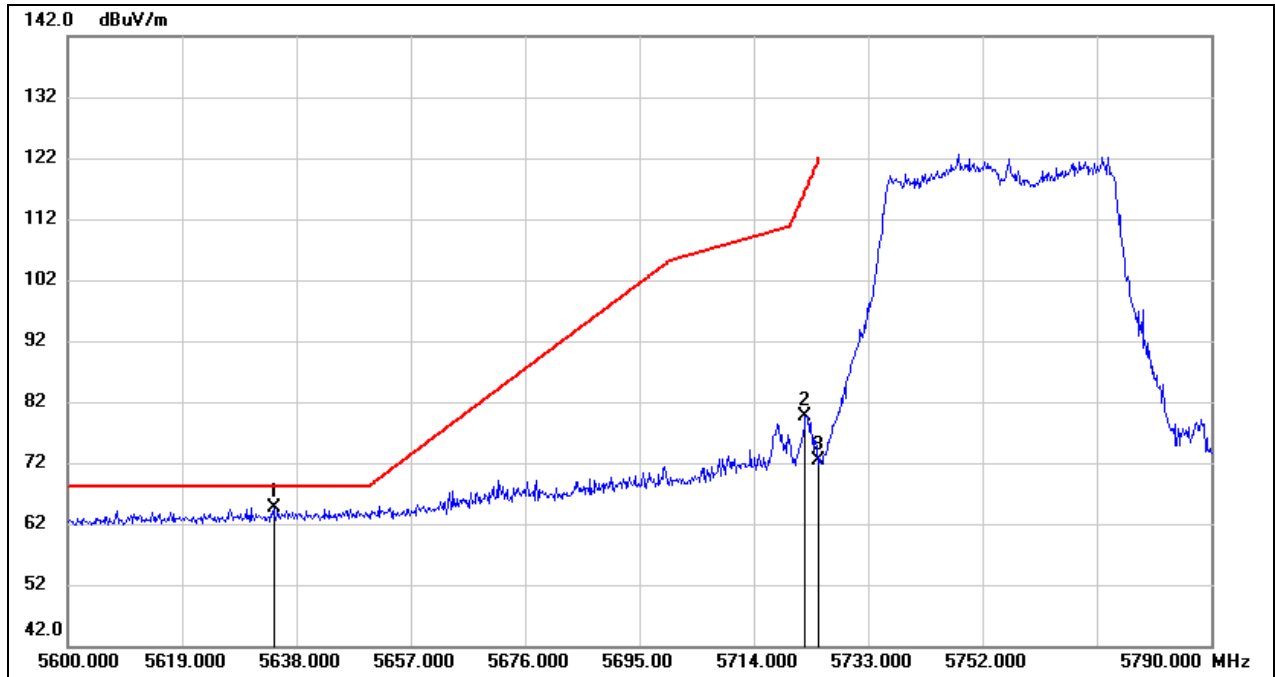

No.	Frequency (MHz)	Reading (dBuV)	Correct (dB/m)	Result (dBuV/m)	Limit (dBuV/m)	Margin (dB)	Remark
1	5634.200	23.60	41.02	64.62	68.20	-3.58	peak
2	5722.550	38.48	41.25	79.73	116.62	-36.89	peak
3	5725.000	31.03	41.27	72.30	122.20	-49.90	peak

Test Mode:	802.11ax HE40 PK	Channel:	5795
Polarity:	Vertical	Test Voltage:	DC 12 V

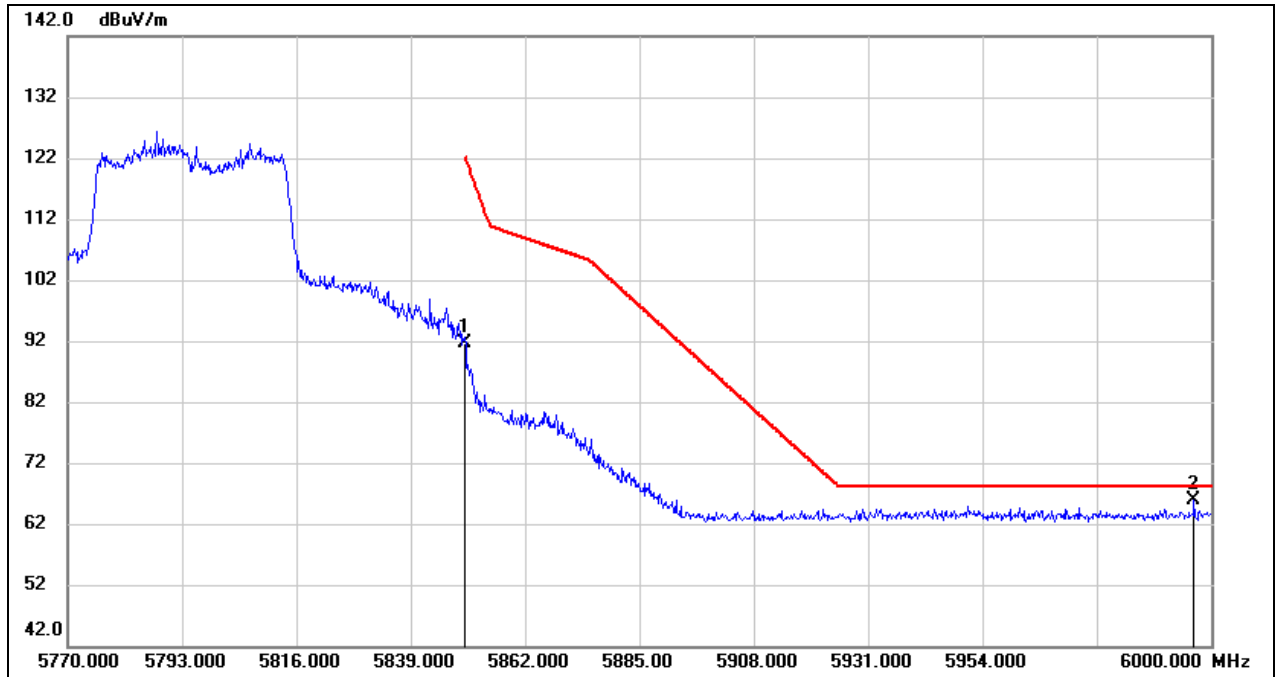

No.	Frequency (MHz)	Reading (dBuV)	Correct (dB/m)	Result (dBuV/m)	Limit (dBuV/m)	Margin (dB)	Remark
1	5850.000	49.93	41.60	91.53	122.20	-30.67	peak
2	5996.550	23.84	41.99	65.83	68.20	-2.37	peak

Test Mode:	802.11ax HE80 PK	Channel:	5210
Polarity:	Vertical	Test Voltage:	DC 12 V

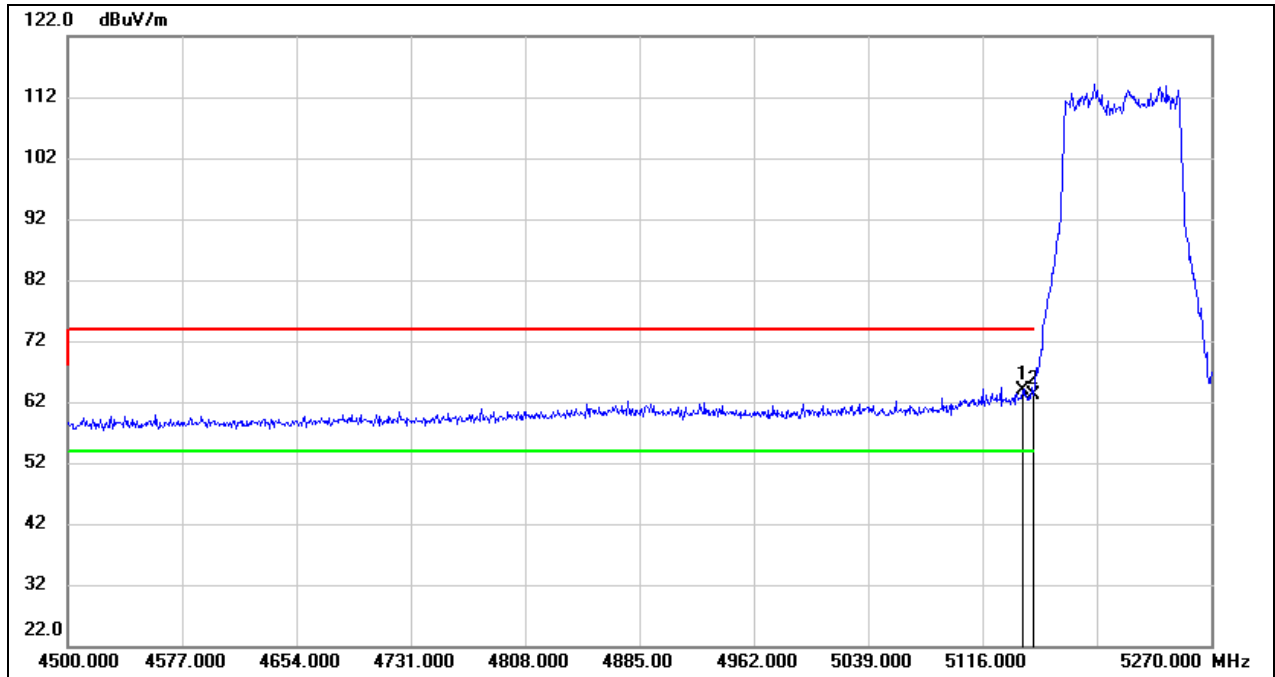

No.	Frequency (MHz)	Reading (dBuV)	Correct (dB/m)	Result (dBuV/m)	Limit (dBuV/m)	Margin (dB)	Remark
1	5142.950	23.67	40.27	63.94	74.00	-10.06	peak
2	5150.000	22.79	40.27	63.06	74.00	-10.94	peak

Test Mode:	802.11ax HE80 AV	Channel:	5210
Polarity:	Vertical	Test Voltage:	DC 12 V

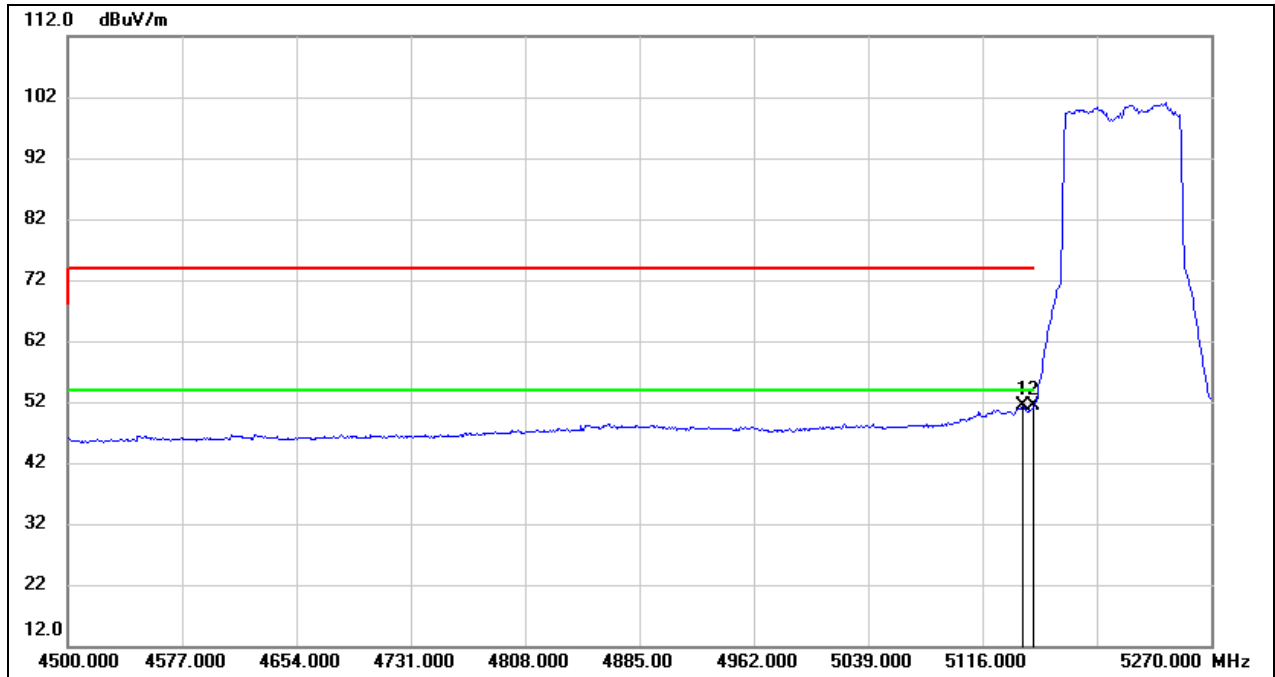

No.	Frequency (MHz)	Reading (dBuV)	Correct (dB/m)	Result (dBuV/m)	Limit (dBuV/m)	Margin (dB)	Remark
1	5142.950	11.14	40.27	51.41	54.00	-2.59	AVG
2	5150.000	11.11	40.27	51.38	54.00	-2.62	AVG

Test Mode:	802.11ax HE80 PK	Channel:	5775
Polarity:	Vertical	Test Voltage:	DC 12 V

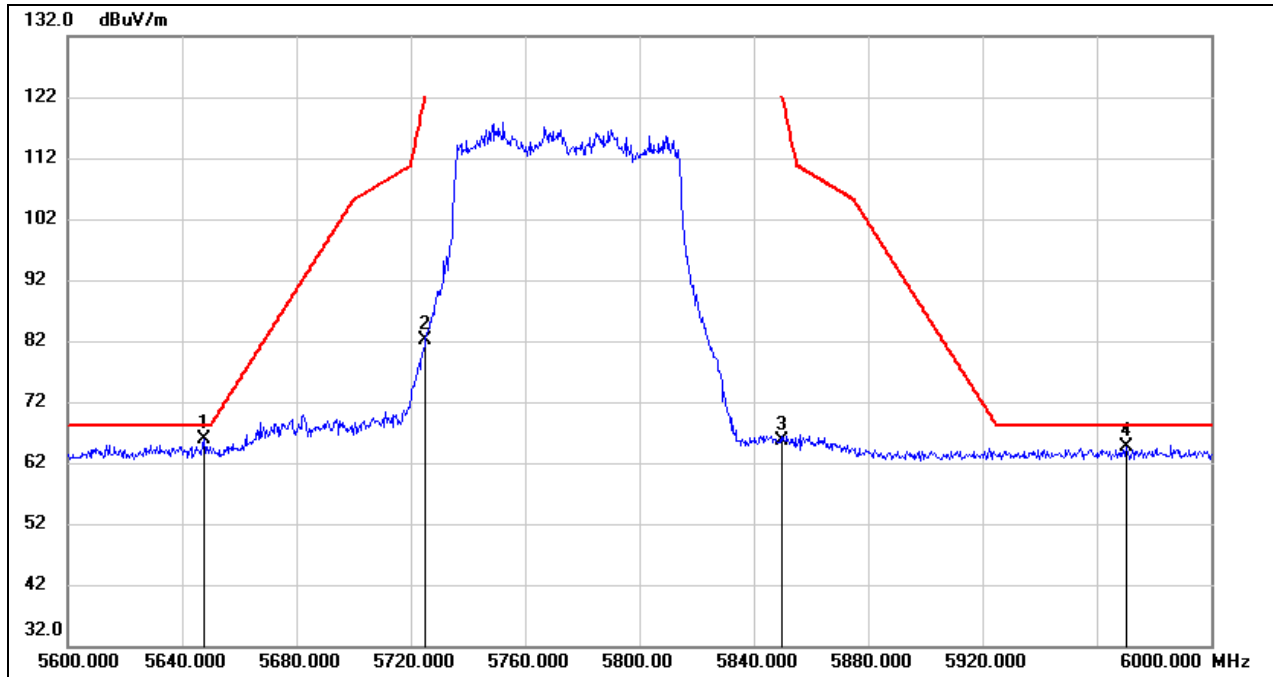

No.	Frequency (MHz)	Reading (dBuV)	Correct (dB/m)	Result (dBuV/m)	Limit (dBuV/m)	Margin (dB)	Remark
1	5647.600	24.74	41.06	65.80	68.20	-2.40	peak
2	5725.000	40.96	41.27	82.23	122.20	-39.97	peak
3	5850.000	23.96	41.60	65.56	122.20	-56.64	peak
4	5970.400	22.61	41.92	64.53	68.20	-3.67	peak

Test Mode:	802.11be EHT20 PK	Channel:	5180
Polarity:	Vertical	Test Voltage:	DC 12 V

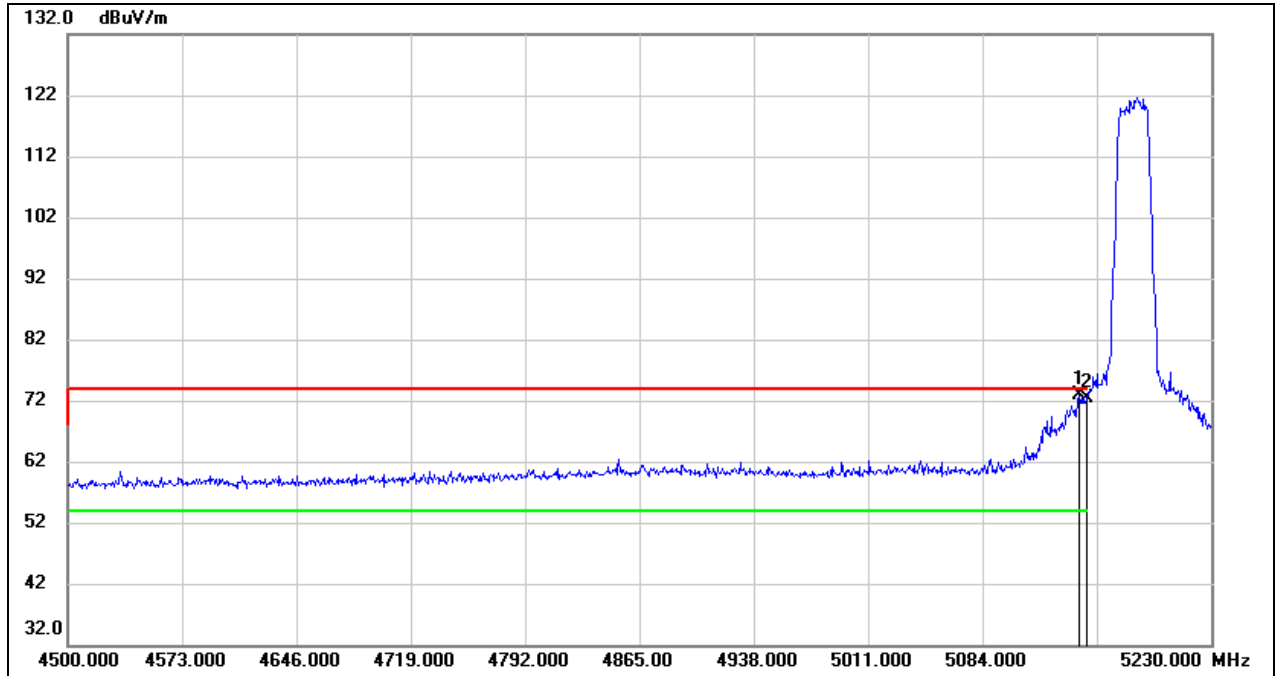

No.	Frequency (MHz)	Reading (dBuV)	Correct (dB/m)	Result (dBuV/m)	Limit (dBuV/m)	Margin (dB)	Remark
1	5146.050	32.63	40.27	72.90	74.00	-1.10	peak
2	5150.000	32.06	40.27	72.33	74.00	-1.67	peak

Test Mode:	802.11be EHT20 AV	Channel:	5180
Polarity:	Vertical	Test Voltage:	DC 12 V

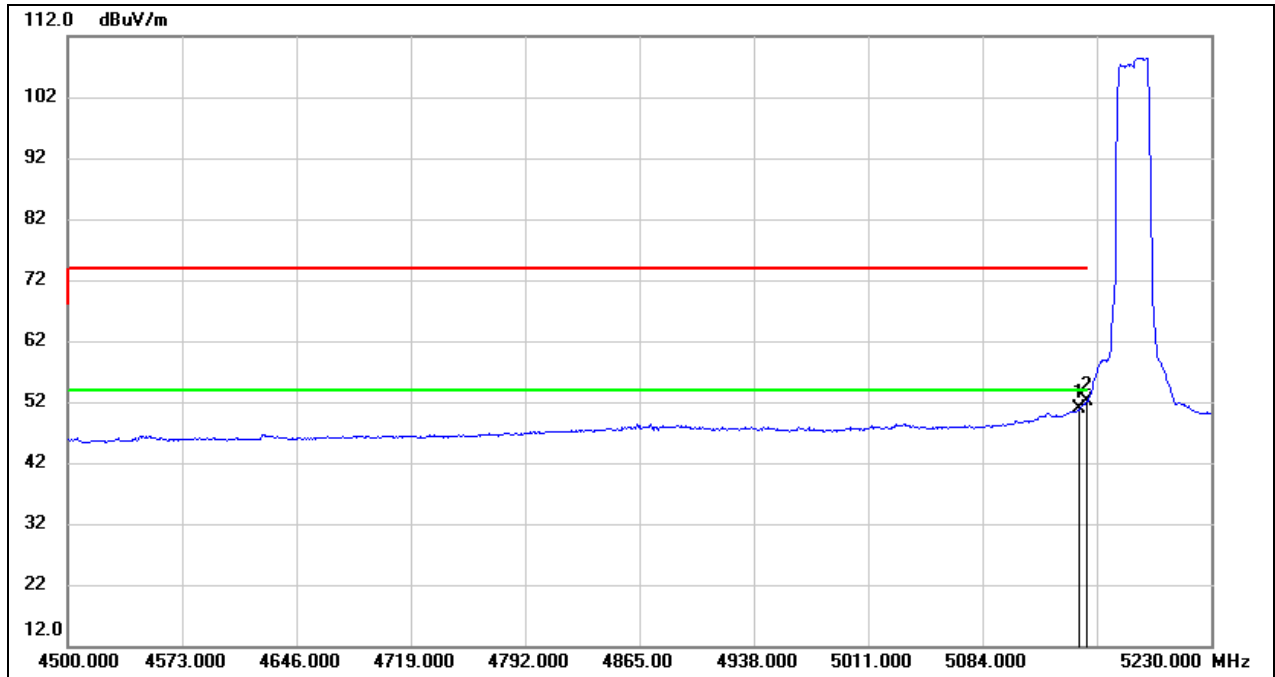

No.	Frequency (MHz)	Reading (dBuV)	Correct (dB/m)	Result (dBuV/m)	Limit (dBuV/m)	Margin (dB)	Remark
1	5146.050	10.58	40.27	50.85	54.00	-3.15	AVG
2	5150.000	11.77	40.27	52.04	54.00	-1.96	AVG

Test Mode:	802.11be EHT20 PK	Channel:	5240
Polarity:	Vertical	Test Voltage:	DC 12 V

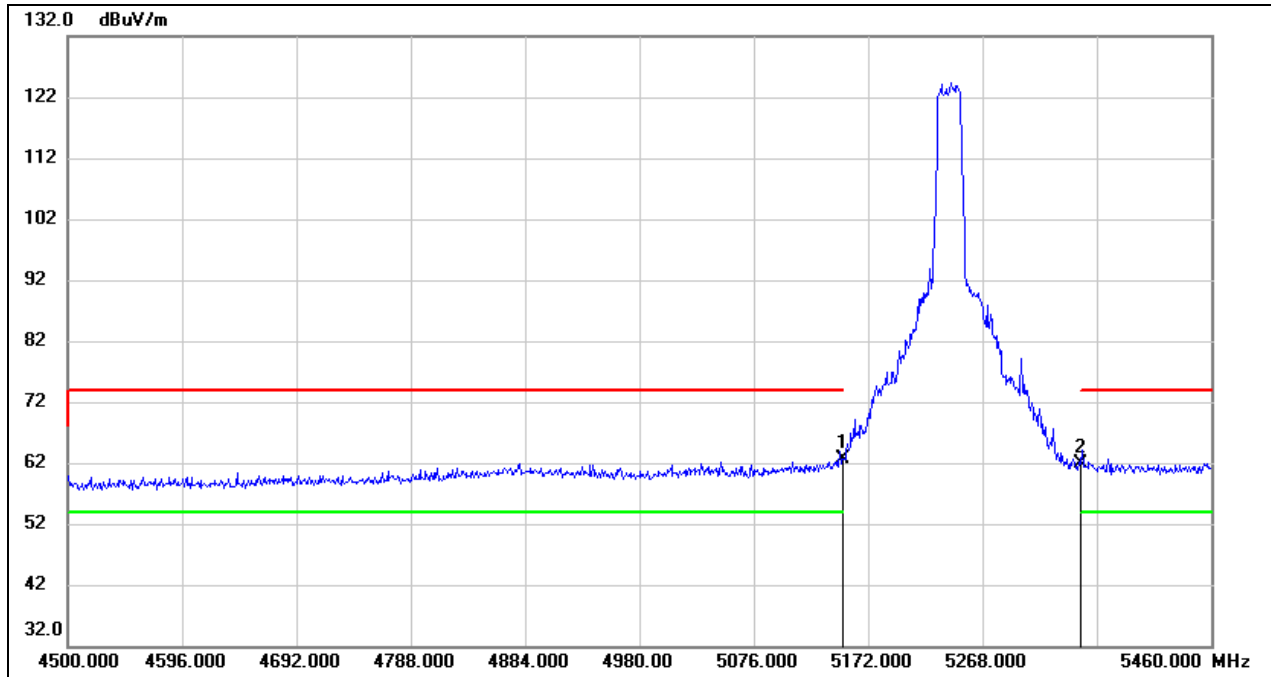

No.	Frequency (MHz)	Reading (dBuV)	Correct (dB/m)	Result (dBuV/m)	Limit (dBuV/m)	Margin (dB)	Remark
1	5150.000	22.28	40.27	62.55	74.00	-11.45	peak
2	5350.000	21.45	40.49	61.94	74.00	-12.06	peak



Test Mode:	802.11be EHT20 AV	Channel:	5240
Polarity:	Vertical	Test Voltage:	DC 12 V

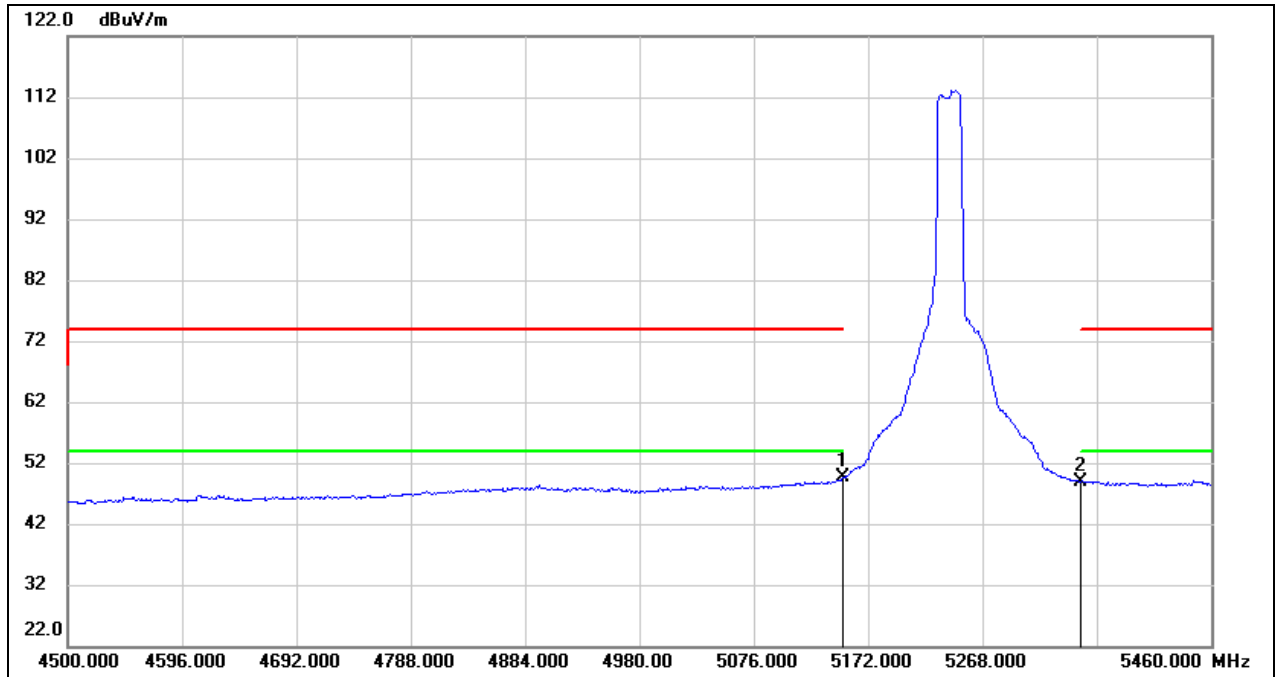

No.	Frequency (MHz)	Reading (dBuV)	Correct (dB/m)	Result (dBuV/m)	Limit (dBuV/m)	Margin (dB)	Remark
1	5150.000	9.28	40.27	49.55	54.00	-4.45	AVG
2	5350.000	8.42	40.49	48.91	54.00	-5.09	AVG

Test Mode:	802.11be EHT20 PK	Channel:	5745
Polarity:	Vertical	Test Voltage:	DC 12 V

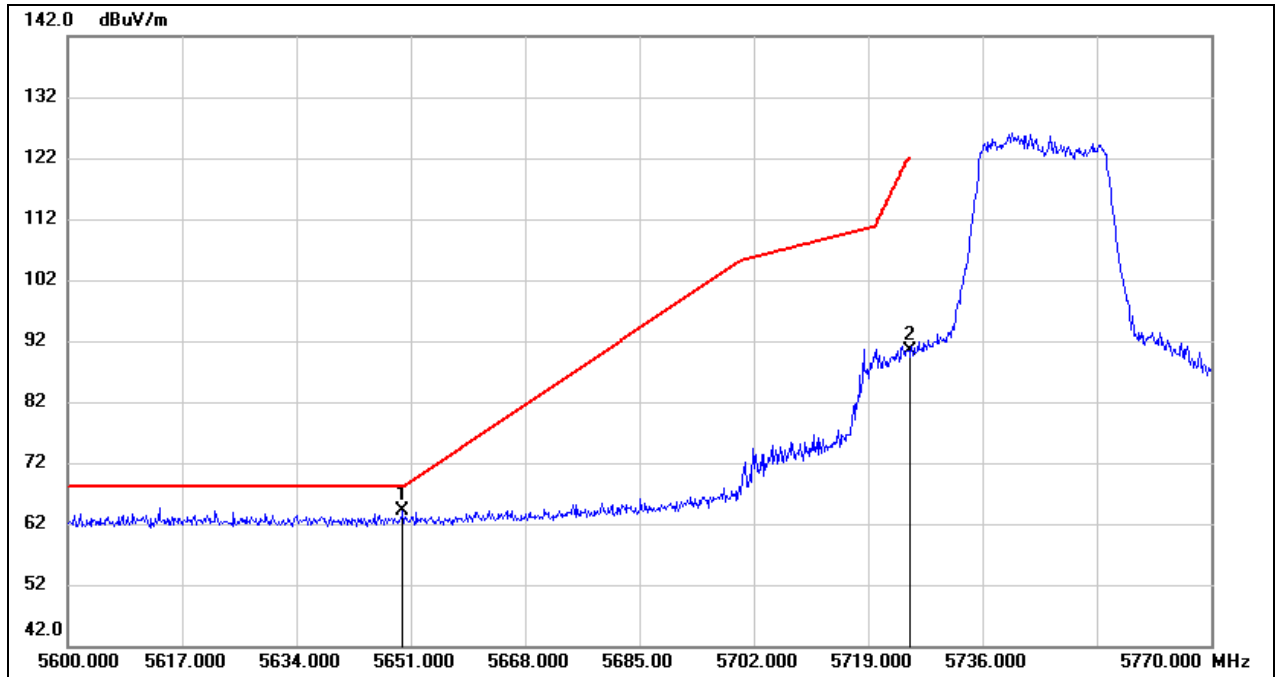

No.	Frequency (MHz)	Reading (dBuV)	Correct (dB/m)	Result (dBuV/m)	Limit (dBuV/m)	Margin (dB)	Remark
1	5649.810	23.16	41.06	64.22	68.20	-3.98	peak
2	5725.000	49.12	41.27	90.39	122.20	-31.81	peak

Test Mode:	802.11be EHT20 PK	Channel:	5825
Polarity:	Vertical	Test Voltage:	DC 12 V

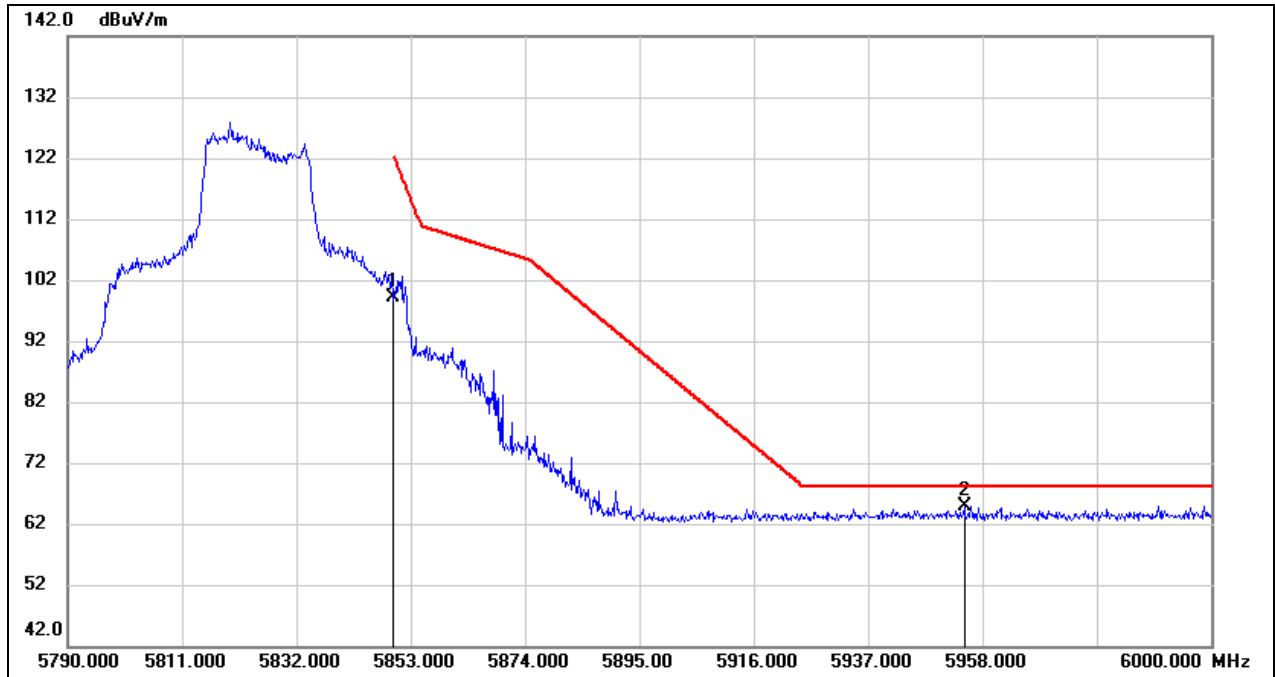

No.	Frequency (MHz)	Reading (dBuV)	Correct (dB/m)	Result (dBuV/m)	Limit (dBuV/m)	Margin (dB)	Remark
1	5850.000	57.65	41.60	99.25	122.20	-22.95	peak
2	5954.640	23.06	41.87	64.93	68.20	-3.27	peak

Test Mode:	802.11be EHT40 PK	Channel:	5190
Polarity:	Vertical	Test Voltage:	DC 12 V

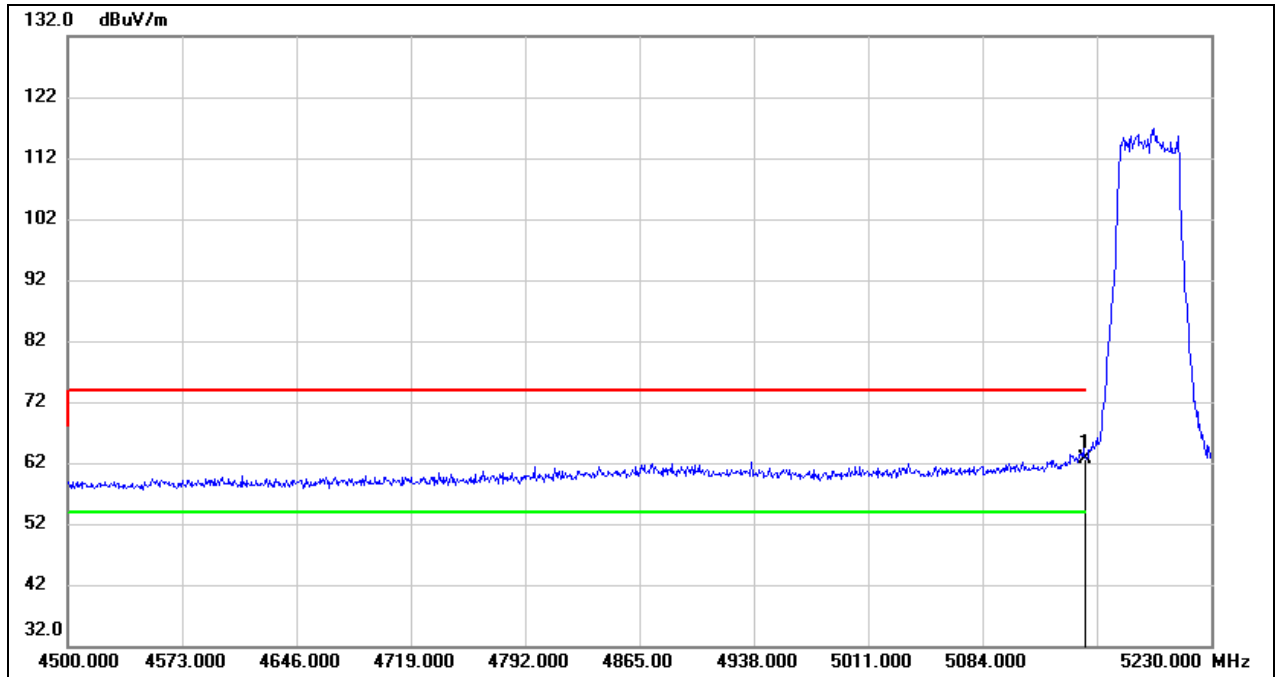

No.	Frequency (MHz)	Reading (dBuV)	Correct (dB/m)	Result (dBuV/m)	Limit (dBuV/m)	Margin (dB)	Remark
1	5150.000	22.36	40.27	62.63	74.00	-11.37	peak

Test Mode:	802.11be EHT40 AV	Channel:	5190
Polarity:	Vertical	Test Voltage:	DC 12 V

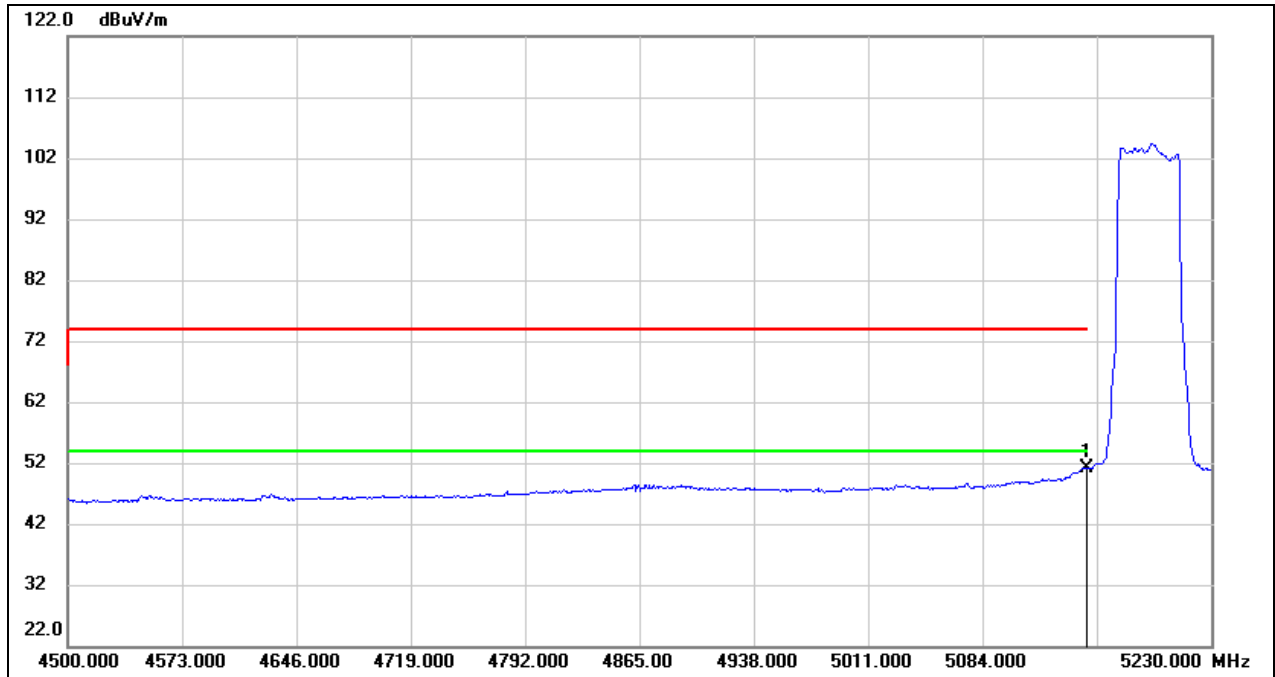

No.	Frequency (MHz)	Reading (dBuV)	Correct (dB/m)	Result (dBuV/m)	Limit (dBuV/m)	Margin (dB)	Remark
1	5150.000	10.80	40.27	51.07	54.00	-2.93	AVG

Test Mode:	802.11be EHT40 PK	Channel:	5230
Polarity:	Vertical	Test Voltage:	DC 12 V

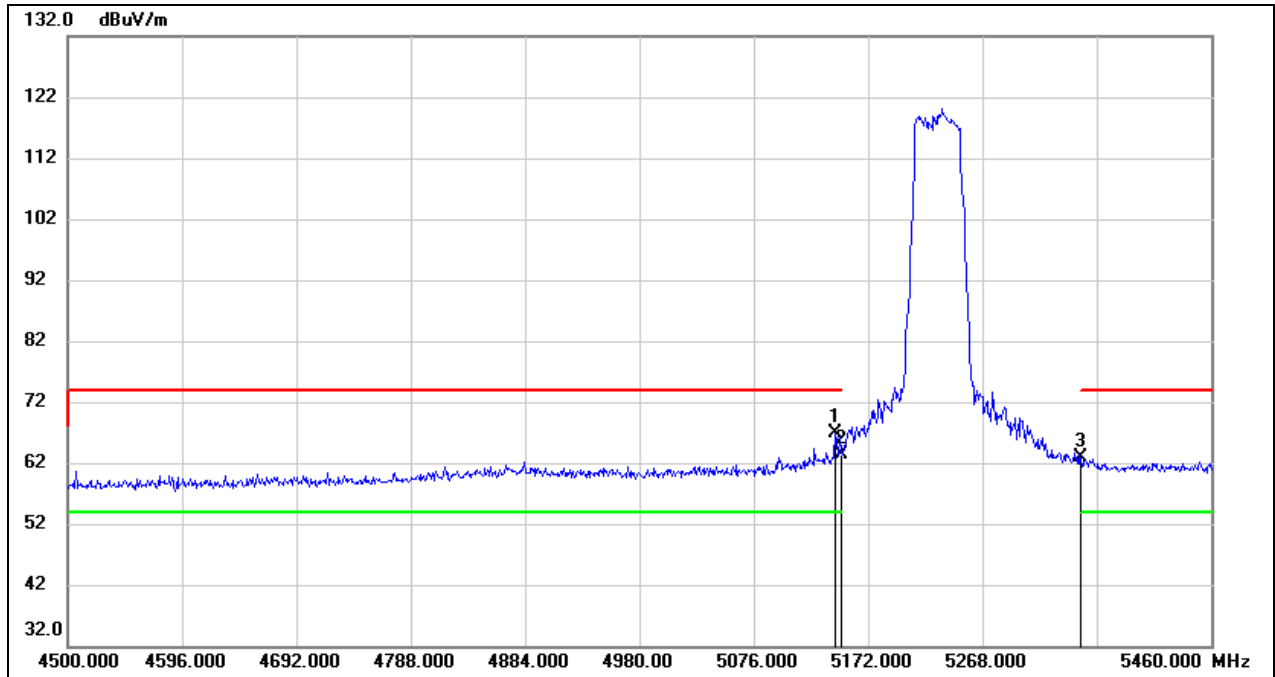

No.	Frequency (MHz)	Reading (dBuV)	Correct (dB/m)	Result (dBuV/m)	Limit (dBuV/m)	Margin (dB)	Remark
1	5144.160	26.59	40.27	66.86	74.00	-7.14	peak
2	5150.000	23.11	40.27	63.38	74.00	-10.62	peak
3	5350.000	22.42	40.49	62.91	74.00	-11.09	peak

Test Mode:	802.11be EHT40 AV	Channel:	5230
Polarity:	Vertical	Test Voltage:	DC 12 V

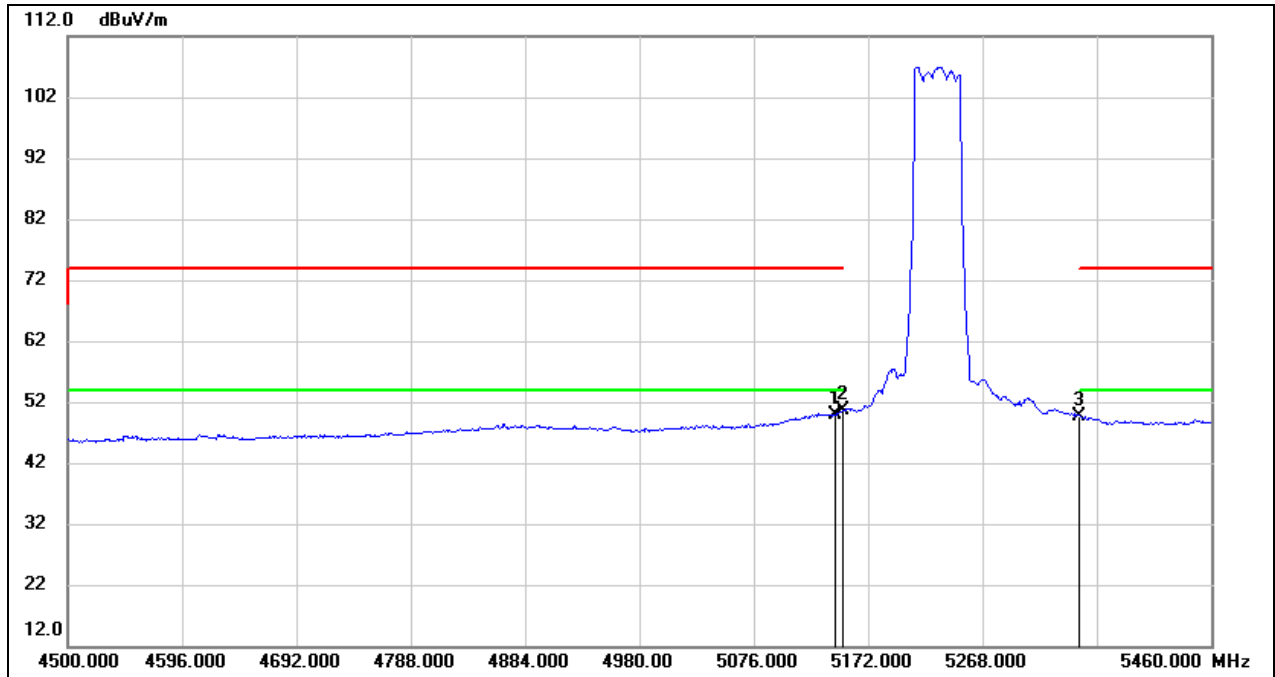

No.	Frequency (MHz)	Reading (dBuV)	Correct (dB/m)	Result (dBuV/m)	Limit (dBuV/m)	Margin (dB)	Remark
1	5144.160	9.72	40.27	49.99	54.00	-4.01	AVG
2	5150.000	10.30	40.27	50.57	54.00	-3.43	AVG
3	5350.000	9.12	40.49	49.61	54.00	-4.39	AVG

Test Mode:	802.11be EHT40 PK	Channel:	5755
Polarity:	Vertical	Test Voltage:	DC 12 V

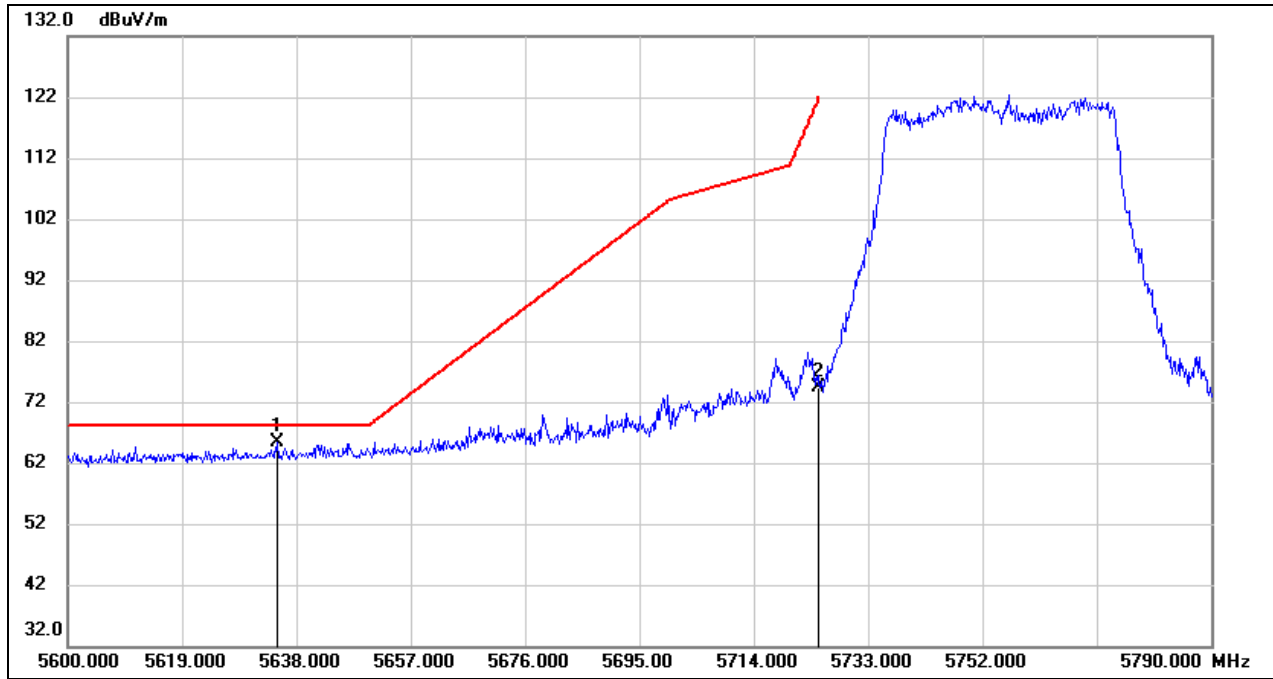

No.	Frequency (MHz)	Reading (dBuV)	Correct (dB/m)	Result (dBuV/m)	Limit (dBuV/m)	Margin (dB)	Remark
1	5634.770	24.32	41.02	65.34	68.20	-2.86	peak
2	5725.000	33.16	41.27	74.43	122.20	-47.77	peak



Test Mode:	802.11be EHT40 PK	Channel:	5795
Polarity:	Vertical	Test Voltage:	DC 12 V

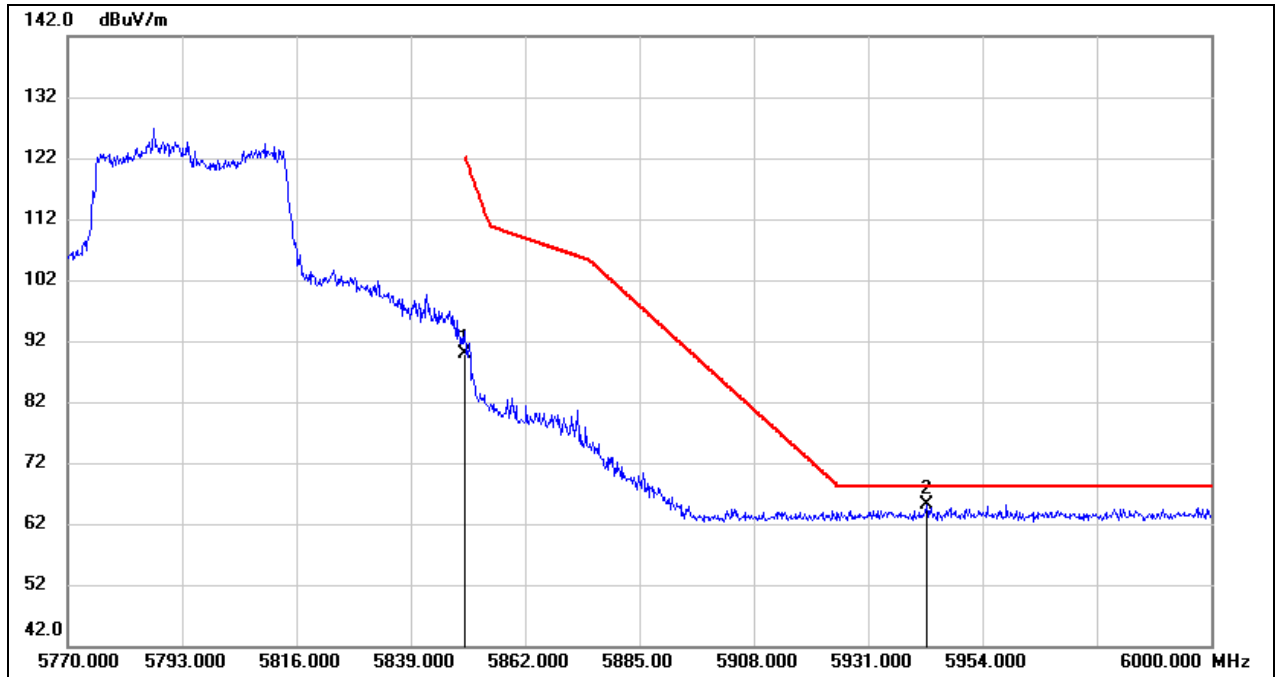

No.	Frequency (MHz)	Reading (dBuV)	Correct (dB/m)	Result (dBuV/m)	Limit (dBuV/m)	Margin (dB)	Remark
1	5850.000	48.33	41.60	89.93	122.20	-32.27	peak
2	5942.730	23.19	41.84	65.03	68.20	-3.17	peak

Test Mode:	802.11be EHT80 PK	Channel:	5210
Polarity:	Vertical	Test Voltage:	DC 12 V

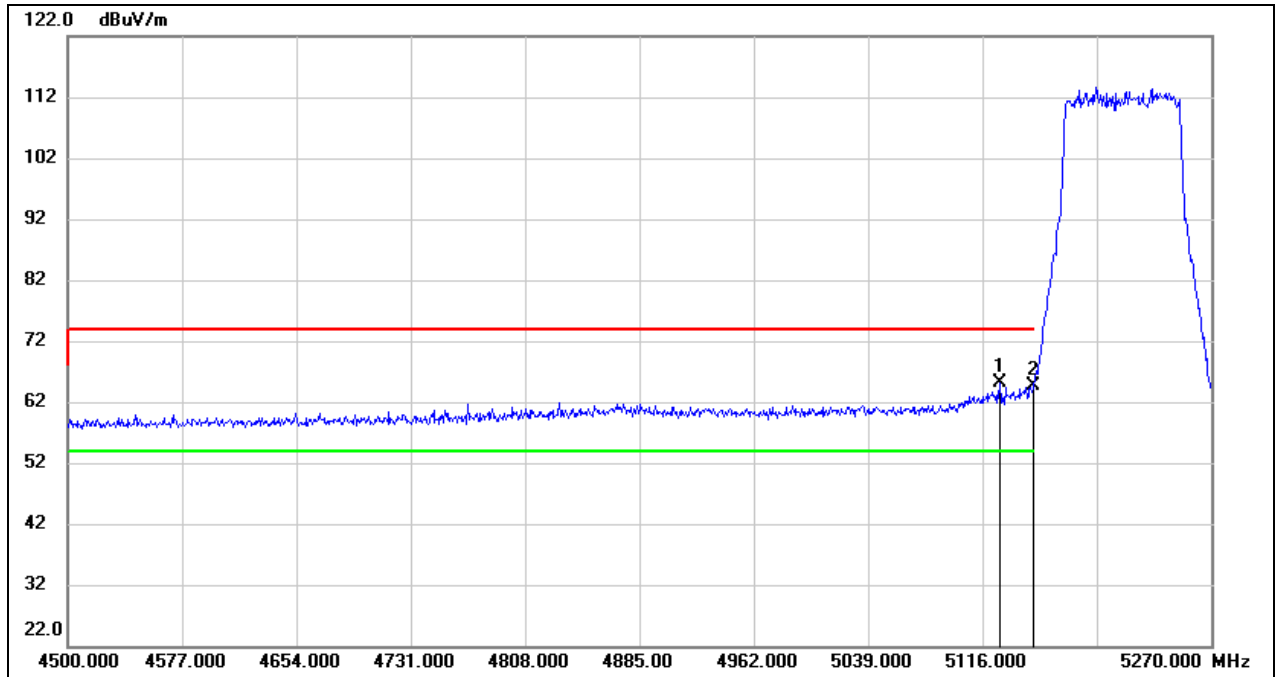

No.	Frequency (MHz)	Reading (dBuV)	Correct (dB/m)	Result (dBuV/m)	Limit (dBuV/m)	Margin (dB)	Remark
1	5127.550	24.87	40.26	65.13	74.00	-8.87	peak
2	5150.000	24.48	40.27	64.75	74.00	-9.25	peak

Test Mode:	802.11be EHT80 AV	Channel:	5210
Polarity:	Vertical	Test Voltage:	DC 12 V

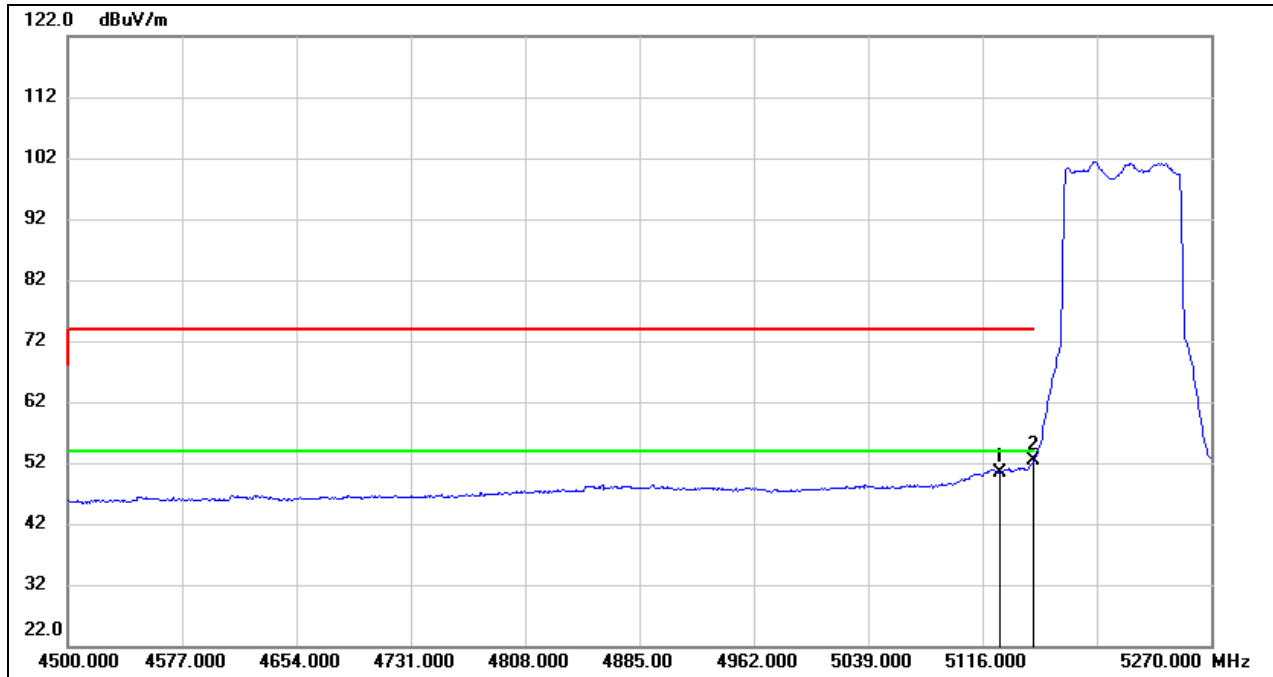

No.	Frequency (MHz)	Reading (dBuV)	Correct (dB/m)	Result (dBuV/m)	Limit (dBuV/m)	Margin (dB)	Remark
1	5127.550	10.10	40.26	50.36	54.00	-3.64	AVG
2	5150.000	12.16	40.27	52.43	54.00	-1.57	AVG

Test Mode:	802.11be EHT80 PK	Channel:	5775
Polarity:	Vertical	Test Voltage:	DC 12 V

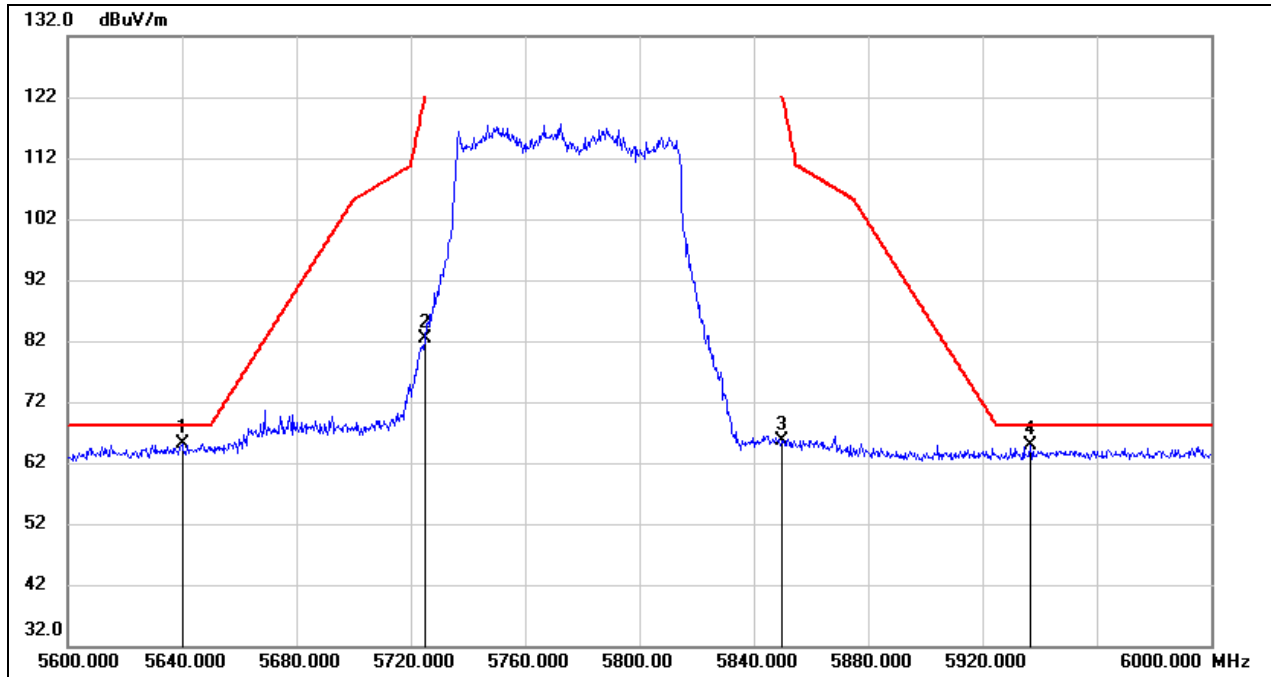

No.	Frequency (MHz)	Reading (dBuV)	Correct (dB/m)	Result (dBuV/m)	Limit (dBuV/m)	Margin (dB)	Remark
1	5640.000	23.98	41.04	65.02	68.20	-3.18	peak
2	5725.000	40.99	41.27	82.26	122.20	-39.94	peak
3	5850.000	24.07	41.60	65.67	122.20	-56.53	peak
4	5936.800	23.11	41.83	64.94	68.20	-3.26	peak

## 8.2. RESTRICTED BANDEDGE

For ISED UNII-1 test data:

Test Mode:	802.11a 20 PK	Channel:	5180
Polarity:	Vertical	Test Voltage:	DC 12 V

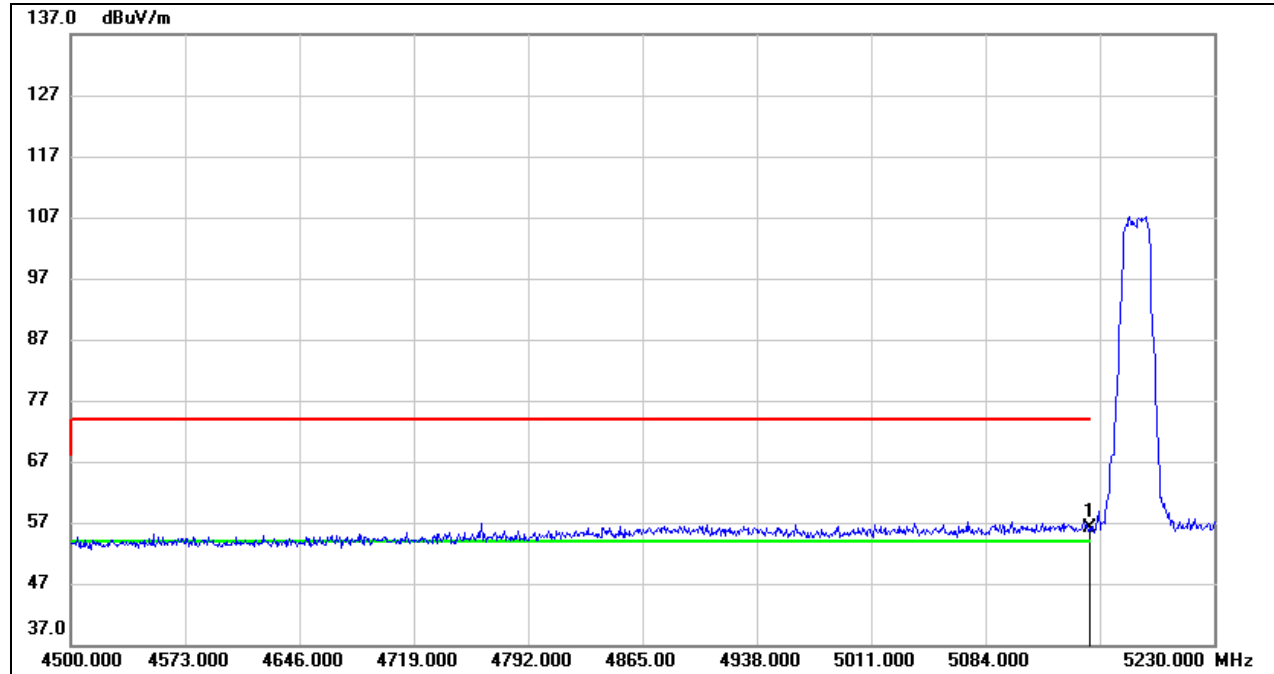

No.	Frequency (MHz)	Reading (dBuV)	Correct (dB/m)	Result (dBuV/m)	Limit (dBuV/m)	Margin (dB)	Remark
1	5150.000	15.74	40.27	56.01	74.00	-17.99	peak

Test Mode:	802.11a 20 AV	Channel:	5180
Polarity:	Vertical	Test Voltage:	DC 12 V

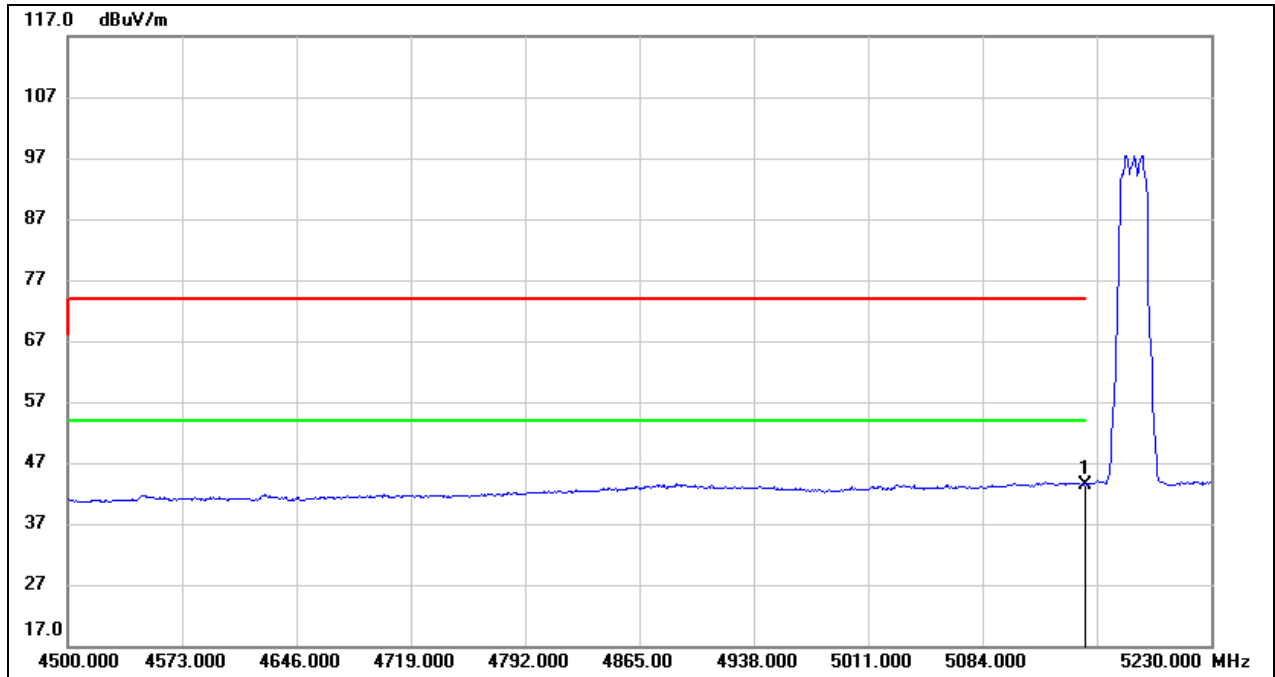

No.	Frequency (MHz)	Reading (dBuV)	Correct (dB/m)	Result (dBuV/m)	Limit (dBuV/m)	Margin (dB)	Remark
1	5150.000	3.14	40.27	43.41	54.00	-10.59	AVG

Test Mode:	802.11a 20 PK	Channel:	5240
Polarity:	Vertical	Test Voltage:	DC 12 V

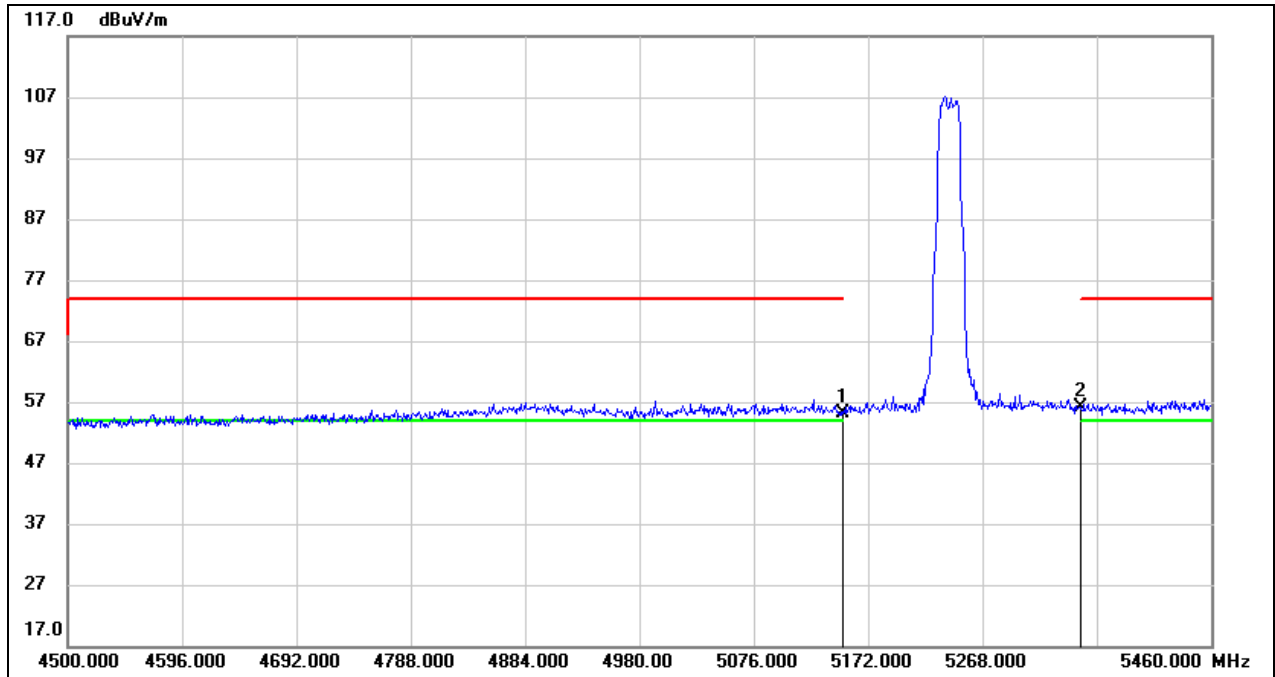

No.	Frequency (MHz)	Reading (dBuV)	Correct (dB/m)	Result (dBuV/m)	Limit (dBuV/m)	Margin (dB)	Remark
1	5150.000	14.93	40.27	55.20	74.00	-18.80	peak
2	5350.000	15.60	40.49	56.09	74.00	-17.91	peak

Test Mode:	802.11a 20 AV	Channel:	5240
Polarity:	Vertical	Test Voltage:	DC 12 V

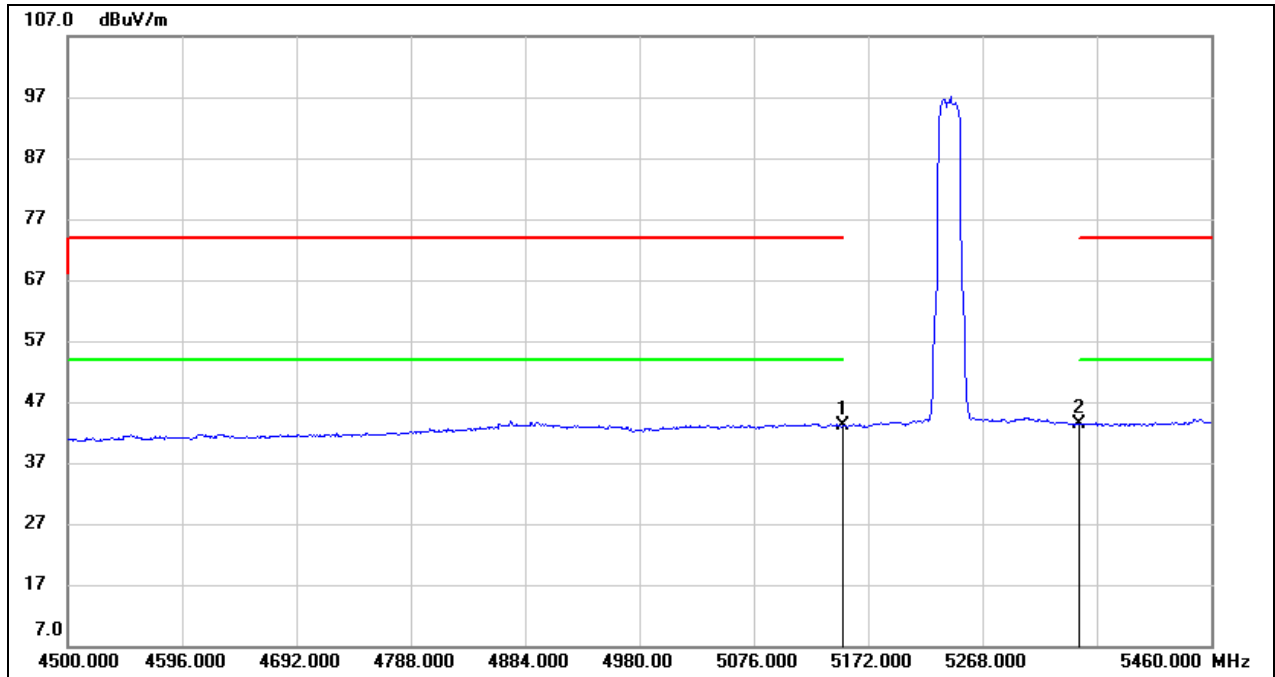

No.	Frequency (MHz)	Reading (dBuV)	Correct (dB/m)	Result (dBuV/m)	Limit (dBuV/m)	Margin (dB)	Remark
1	5150.000	2.79	40.27	43.06	54.00	-10.94	AVG
2	5350.000	2.80	40.49	43.29	54.00	-10.71	AVG



Test Mode:	802.11ax HE20 PK	Channel:	5180
Polarity:	Vertical	Test Voltage:	DC 12 V

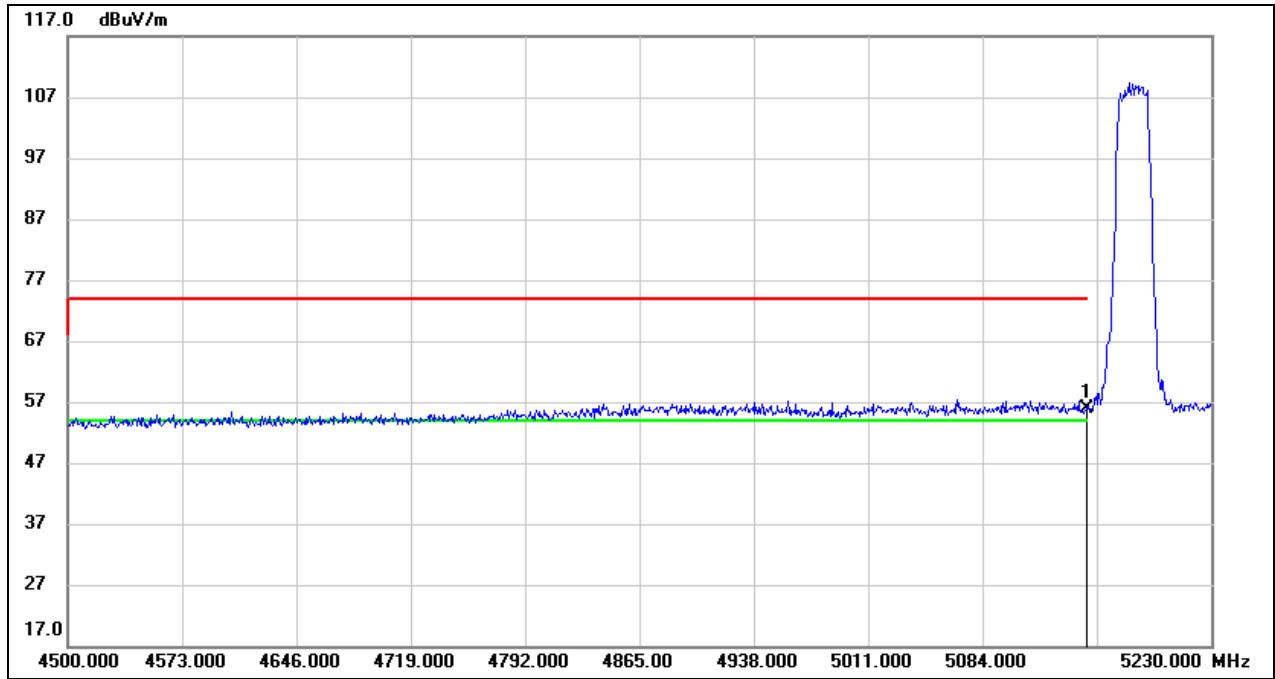

No.	Frequency (MHz)	Reading (dBuV)	Correct (dB/m)	Result (dBuV/m)	Limit (dBuV/m)	Margin (dB)	Remark
1	5150.000	15.49	40.27	55.76	74.00	-18.24	peak

Test Mode:	802.11ax HE20 AV	Channel:	5180
Polarity:	Vertical	Test Voltage:	DC 12 V

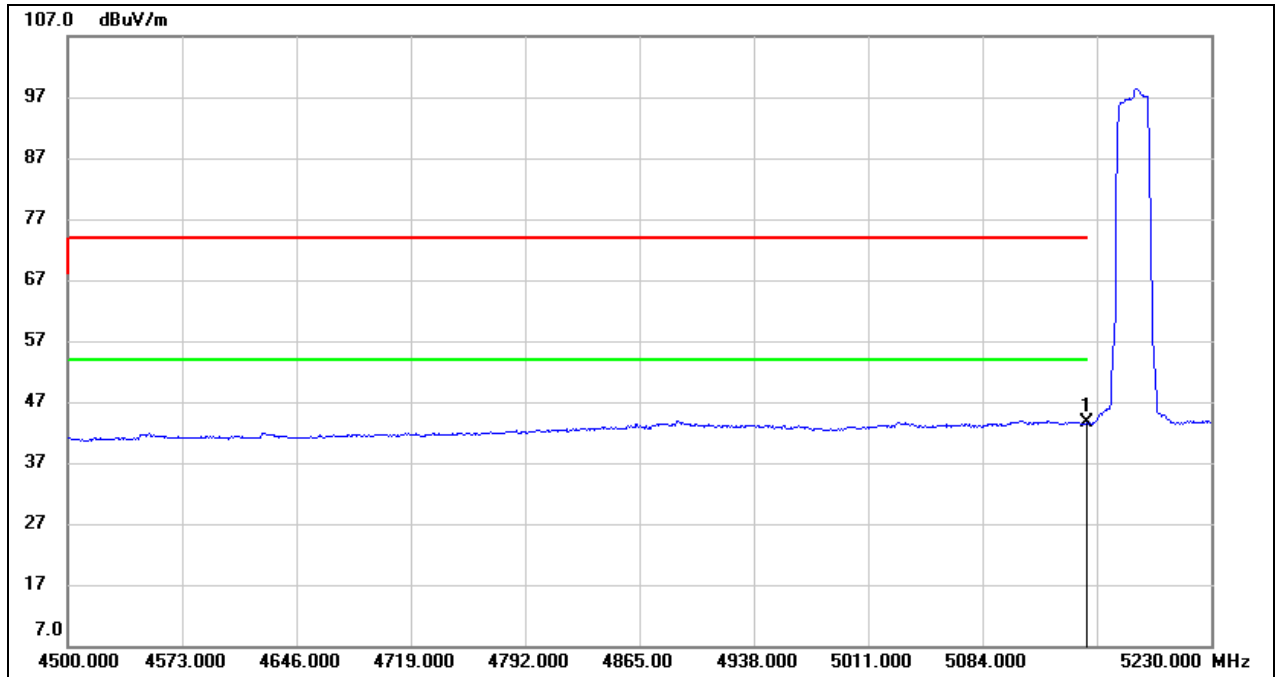

No.	Frequency (MHz)	Reading (dBuV)	Correct (dB/m)	Result (dBuV/m)	Limit (dBuV/m)	Margin (dB)	Remark
1	5150.000	3.26	40.27	43.53	54.00	-10.47	AVG

Test Mode:	802.11ax HE20 PK	Channel:	5240
Polarity:	Vertical	Test Voltage:	DC 12 V

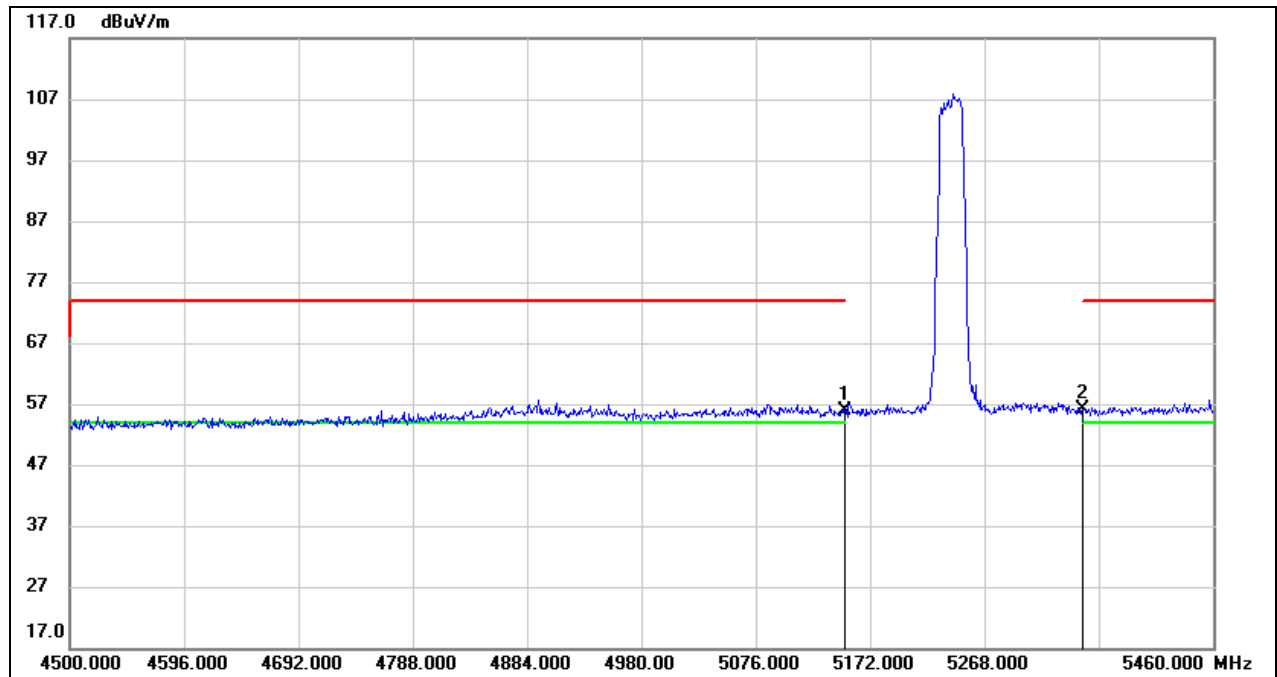

No.	Frequency (MHz)	Reading (dBuV)	Correct (dB/m)	Result (dBuV/m)	Limit (dBuV/m)	Margin (dB)	Remark
1	5150.000	15.52	40.27	55.79	74.00	-18.21	peak
2	5350.000	15.75	40.49	56.24	74.00	-17.76	peak

Test Mode:	802.11ax HE20 AV	Channel:	5240
Polarity:	Vertical	Test Voltage:	DC 12 V

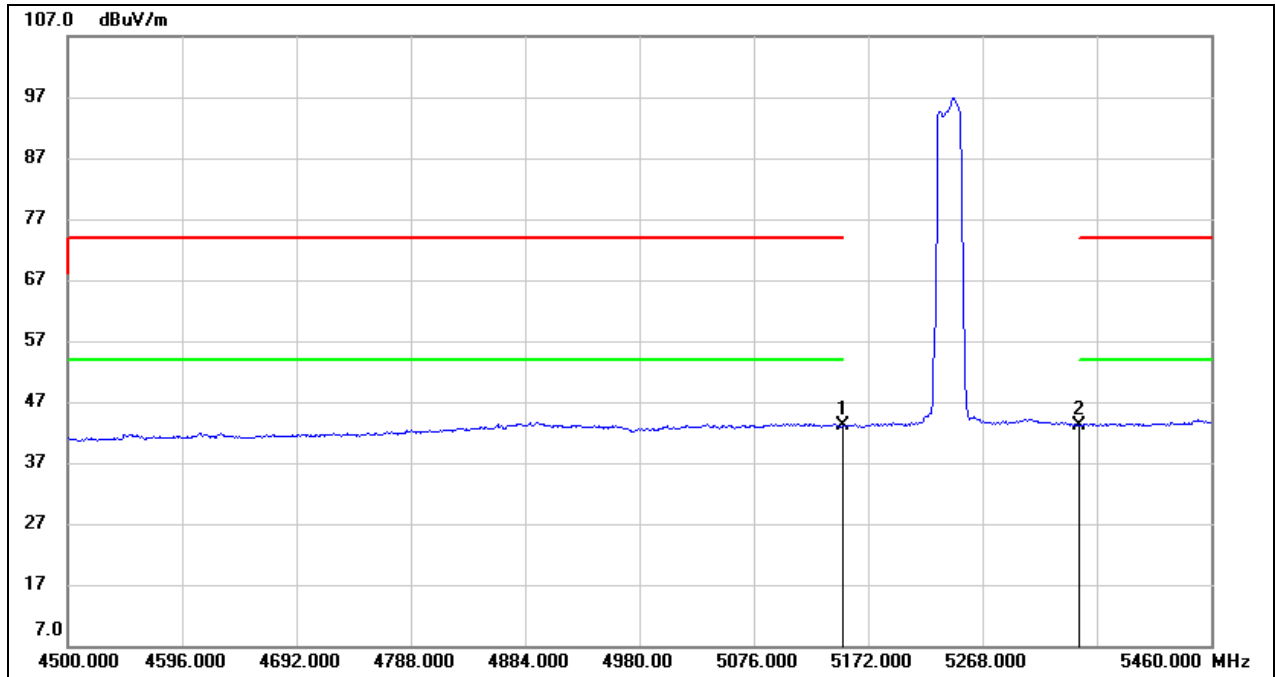

No.	Frequency (MHz)	Reading (dBuV)	Correct (dB/m)	Result (dBuV/m)	Limit (dBuV/m)	Margin (dB)	Remark
1	5150.000	2.74	40.27	43.01	54.00	-10.99	AVG
2	5350.000	2.71	40.49	43.20	54.00	-10.80	AVG

Test Mode:	802.11ax HE40 PK	Channel:	5190
Polarity:	Vertical	Test Voltage:	DC 12 V

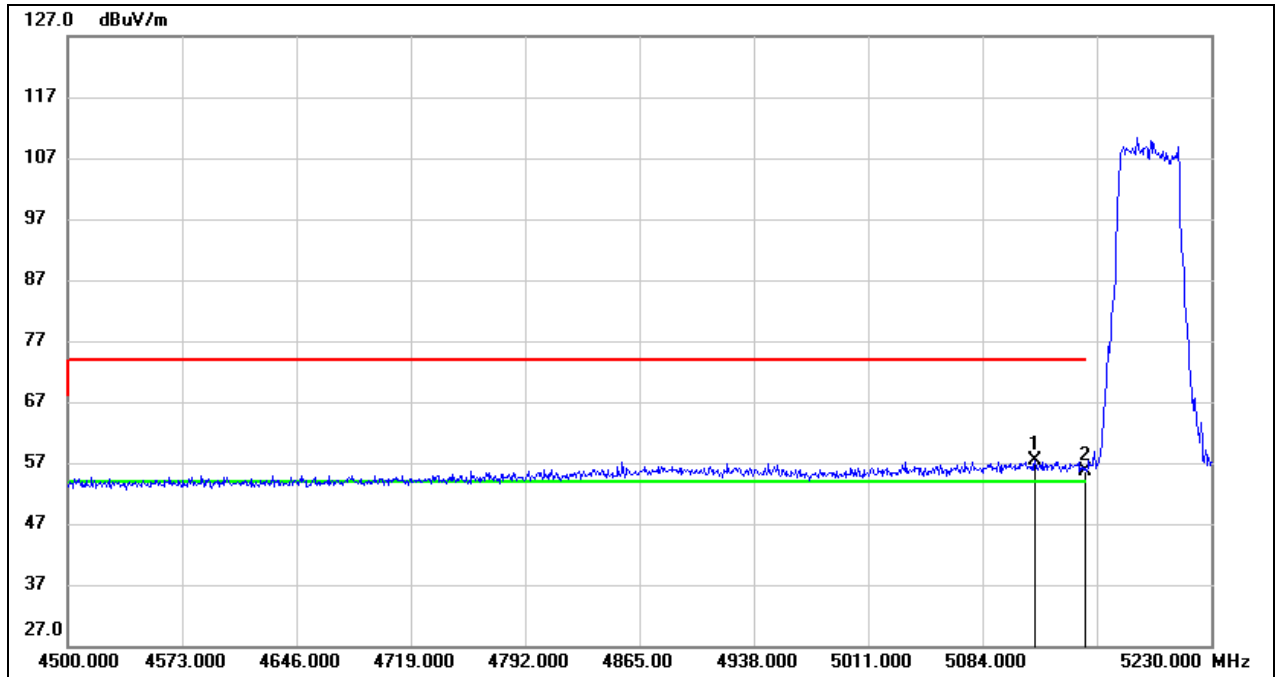

No.	Frequency (MHz)	Reading (dBuV)	Correct (dB/m)	Result (dBuV/m)	Limit (dBuV/m)	Margin (dB)	Remark
1	5117.580	17.03	40.24	57.27	74.00	-16.73	peak
2	5150.000	15.35	40.27	55.62	74.00	-18.38	peak

Test Mode:	802.11ax HE40 AV	Channel:	5190
Polarity:	Vertical	Test Voltage:	DC 12 V

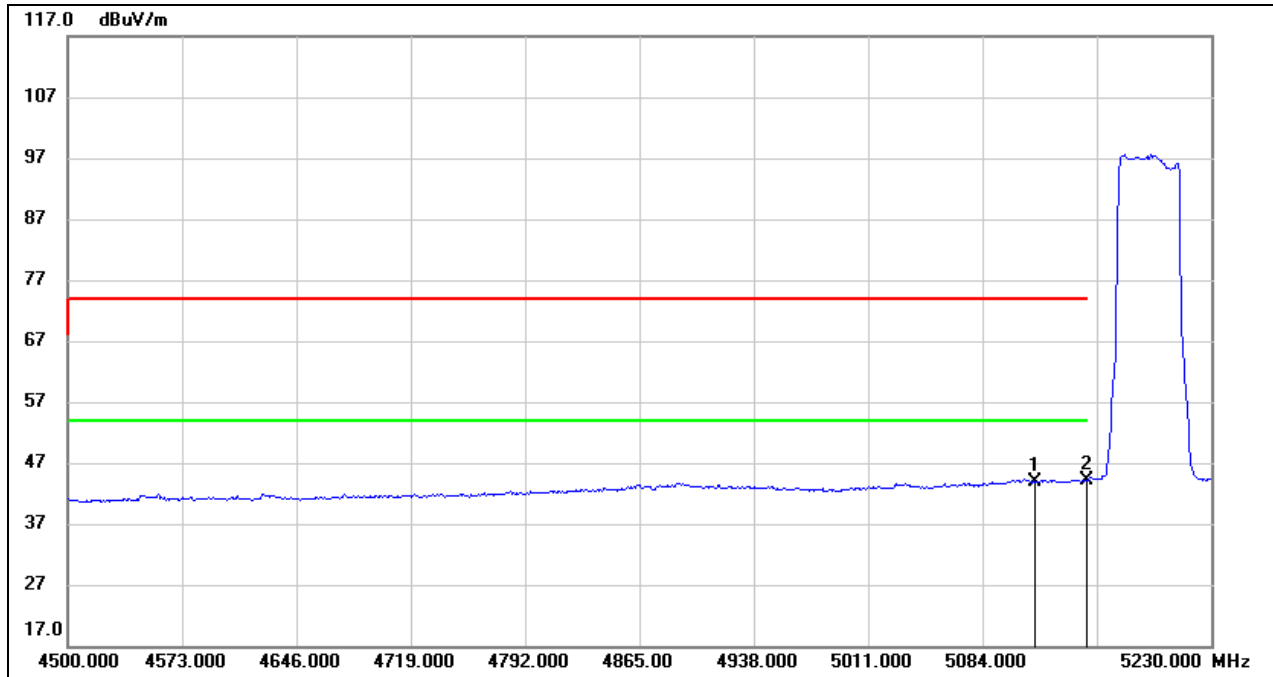

No.	Frequency (MHz)	Reading (dBuV)	Correct (dB/m)	Result (dBuV/m)	Limit (dBuV/m)	Margin (dB)	Remark
1	5117.580	3.58	40.24	43.82	54.00	-10.18	AVG
2	5150.000	3.80	40.27	44.07	54.00	-9.93	AVG

### 8.3. SPURIOUS EMISSIONS(1 GHZ~7 GHZ)

For FCC UNII-1&UNII-3; ISED UNII-3 test data:

Test Mode:	802.11a 20	Channel:	5180
Polarity:	Horizontal	Test Voltage:	DC 12 V

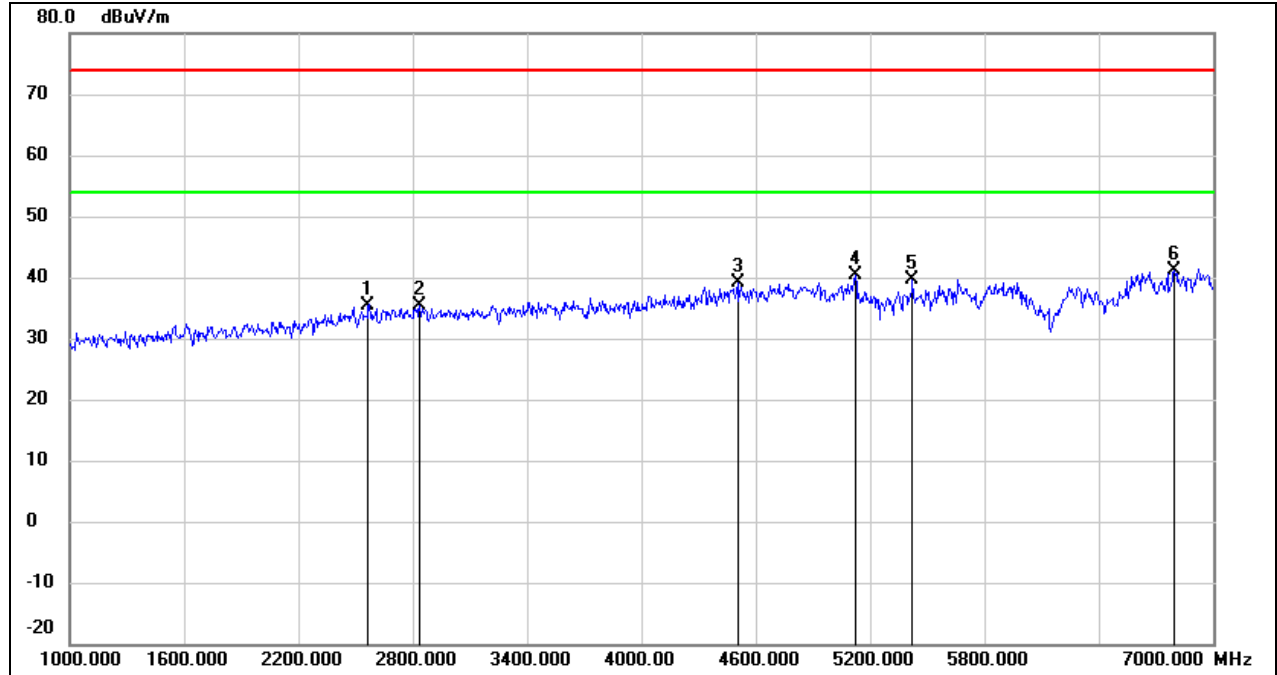

No.	Frequency (MHz)	Reading (dBuV)	Correct (dB/m)	Result (dBuV/m)	Limit (dBuV/m)	Margin (dB)	Remark
1	2566.000	43.66	-8.29	35.37	74.00	-38.63	peak
2	2836.000	42.88	-7.48	35.40	74.00	-38.60	peak
3	4504.000	41.28	-2.12	39.16	74.00	-34.84	peak
4	5122.000	40.39	-0.02	40.37	74.00	-33.63	peak
5	5422.000	39.43	0.32	39.75	74.00	-34.25	peak
6	6796.000	35.90	5.19	41.09	74.00	-32.91	peak

Test Mode:	802.11a 20	Channel:	5180
Polarity:	Vertical	Test Voltage:	DC 12 V

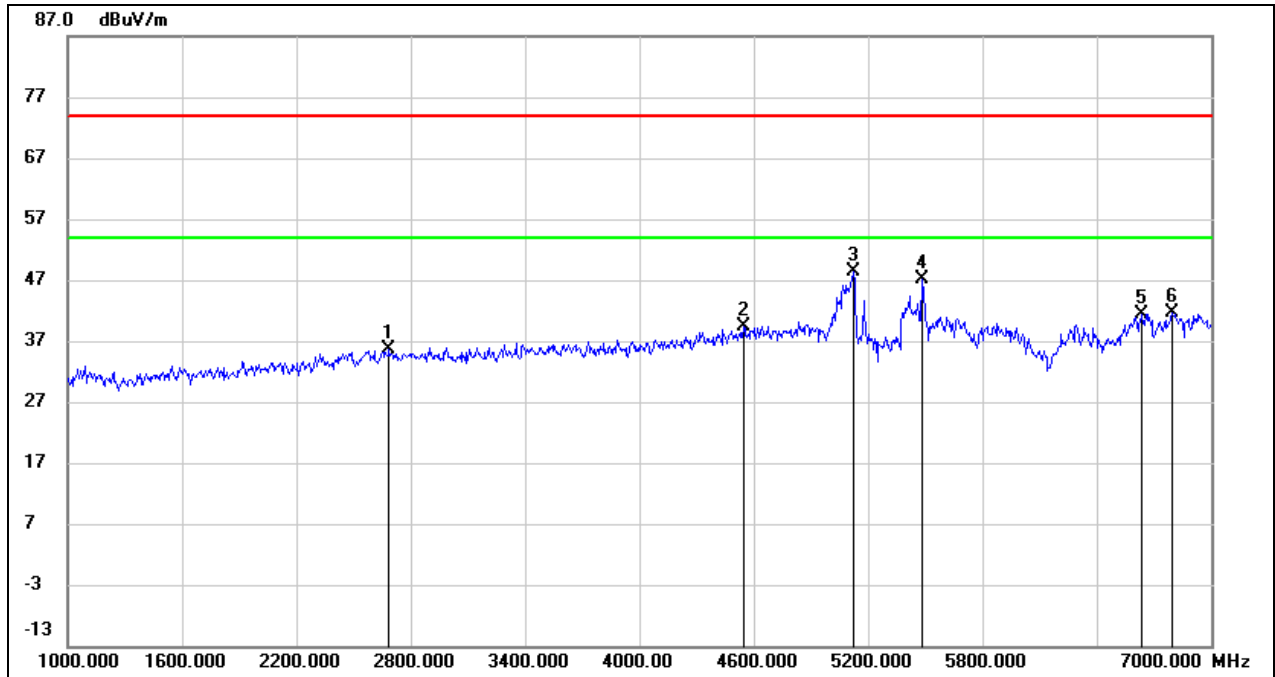

No.	Frequency (MHz)	Reading (dBuV)	Correct (dB/m)	Result (dBuV/m)	Limit (dBuV/m)	Margin (dB)	Remark
1	2686.000	43.49	-7.93	35.56	74.00	-38.44	peak
2	4546.000	41.30	-1.96	39.34	74.00	-34.66	peak
3	5122.000	48.28	-0.02	48.26	74.00	-25.74	peak
4	5482.000	46.80	0.40	47.20	74.00	-26.80	peak
5	6634.000	37.11	4.38	41.49	74.00	-32.51	peak
6	6796.000	36.53	5.19	41.72	74.00	-32.28	peak



Test Mode:	802.11a 20	Channel:	5200
Polarity:	Horizontal	Test Voltage:	DC 12 V

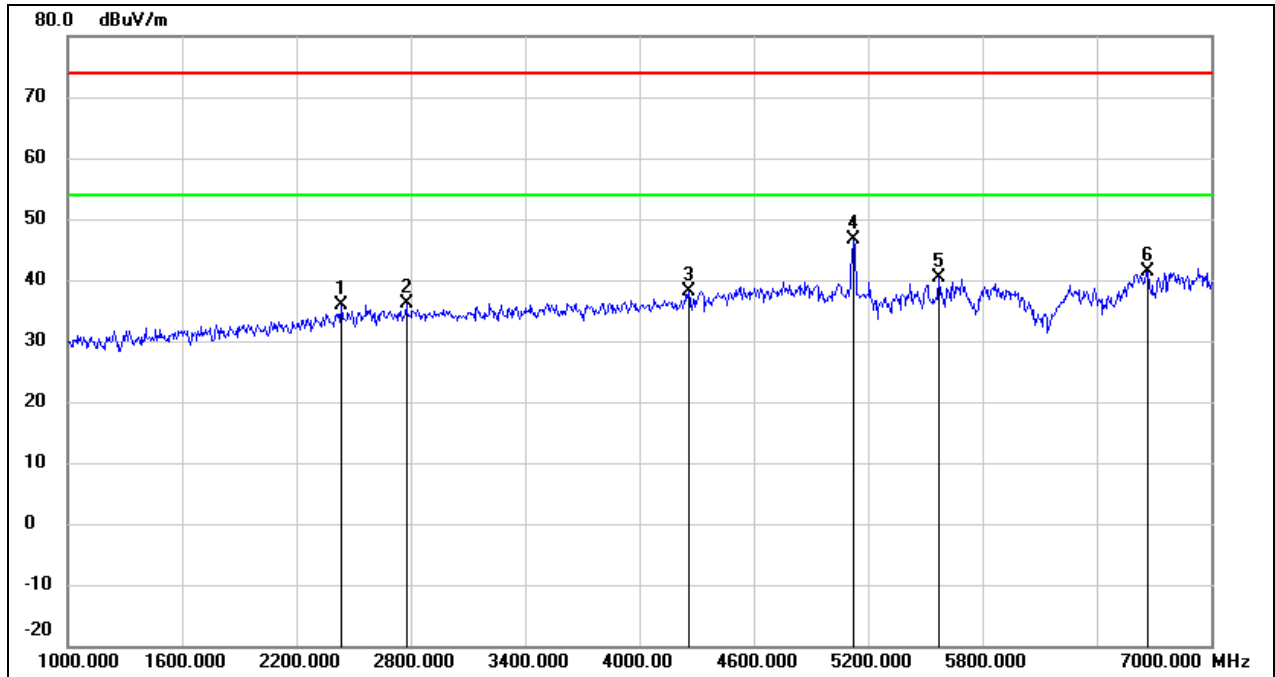

No.	Frequency (MHz)	Reading (dBuV)	Correct (dB/m)	Result (dBuV/m)	Limit (dBuV/m)	Margin (dB)	Remark
1	2434.000	44.83	-8.83	36.00	74.00	-38.00	peak
2	2776.000	43.90	-7.66	36.24	74.00	-37.76	peak
3	4258.000	41.38	-3.27	38.11	74.00	-35.89	peak
4	5122.000	46.75	-0.02	46.73	74.00	-27.27	peak
5	5572.000	39.72	0.63	40.35	74.00	-33.65	peak
6	6670.000	36.87	4.57	41.44	74.00	-32.56	peak

Test Mode:	802.11a 20	Channel:	5200
Polarity:	Vertical	Test Voltage:	DC 12 V

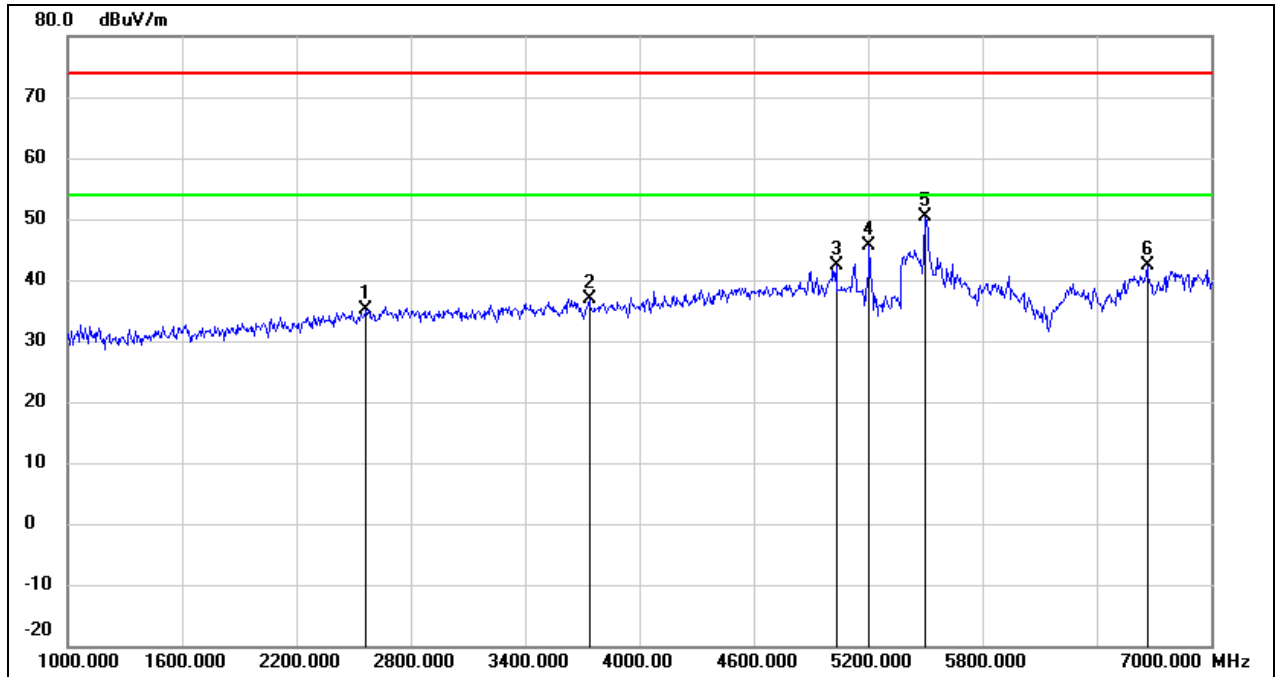

No.	Frequency (MHz)	Reading (dBuV)	Correct (dB/m)	Result (dBuV/m)	Limit (dBuV/m)	Margin (dB)	Remark
1	2566.000	43.41	-8.29	35.12	74.00	-38.88	peak
2	3736.000	42.18	-5.21	36.97	74.00	-37.03	peak
3	5032.000	42.40	-0.12	42.28	74.00	-31.72	peak
4	5206.000	45.62	0.08	45.70	74.00	-28.30	peak
5	5500.000	49.99	0.42	50.41	74.00	-23.59	peak
6	6664.000	37.79	4.54	42.33	74.00	-31.67	peak

Test Mode:	802.11a 20	Channel:	5240
Polarity:	Horizontal	Test Voltage:	DC 12 V

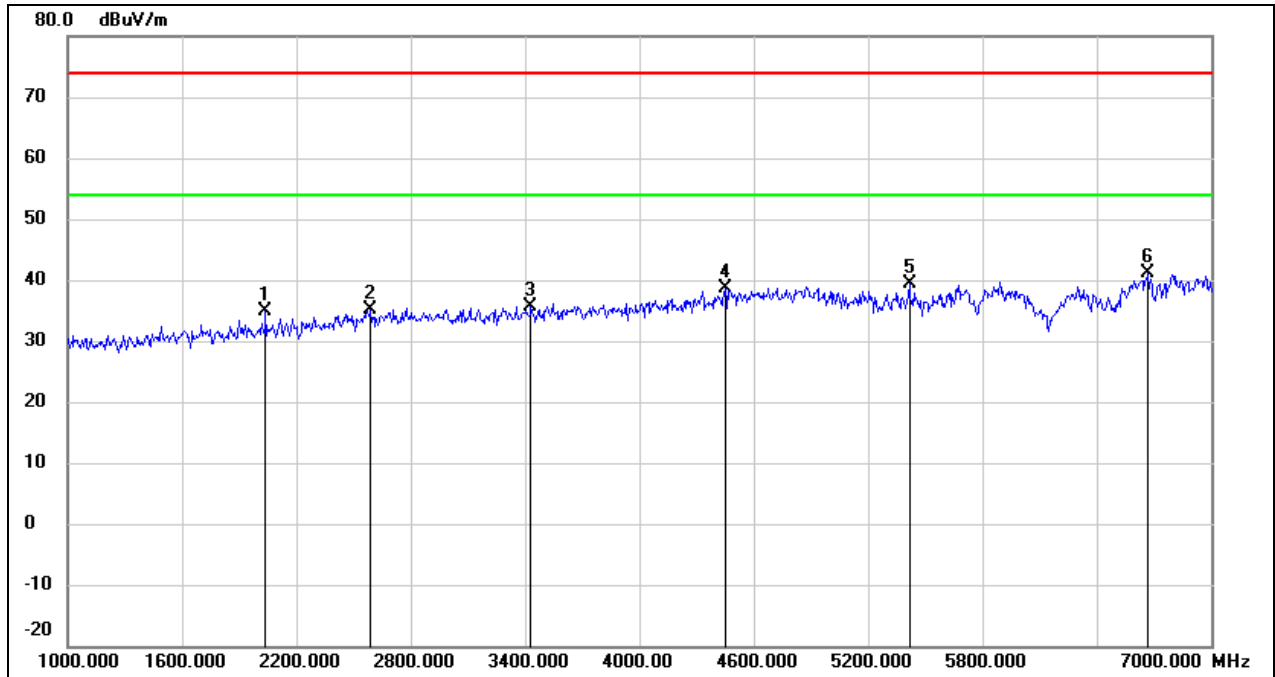

No.	Frequency (MHz)	Reading (dBuV)	Correct (dB/m)	Result (dBuV/m)	Limit (dBuV/m)	Margin (dB)	Remark
1	2038.000	45.86	-10.86	35.00	74.00	-39.00	peak
2	2590.000	43.39	-8.22	35.17	74.00	-38.83	peak
3	3430.000	41.60	-6.01	35.59	74.00	-38.41	peak
4	4450.000	40.94	-2.37	38.57	74.00	-35.43	peak
5	5416.000	39.06	0.32	39.38	74.00	-34.62	peak
6	6670.000	36.63	4.57	41.20	74.00	-32.80	peak

Test Mode:	802.11a 20	Channel:	5240
Polarity:	Vertical	Test Voltage:	DC 12 V

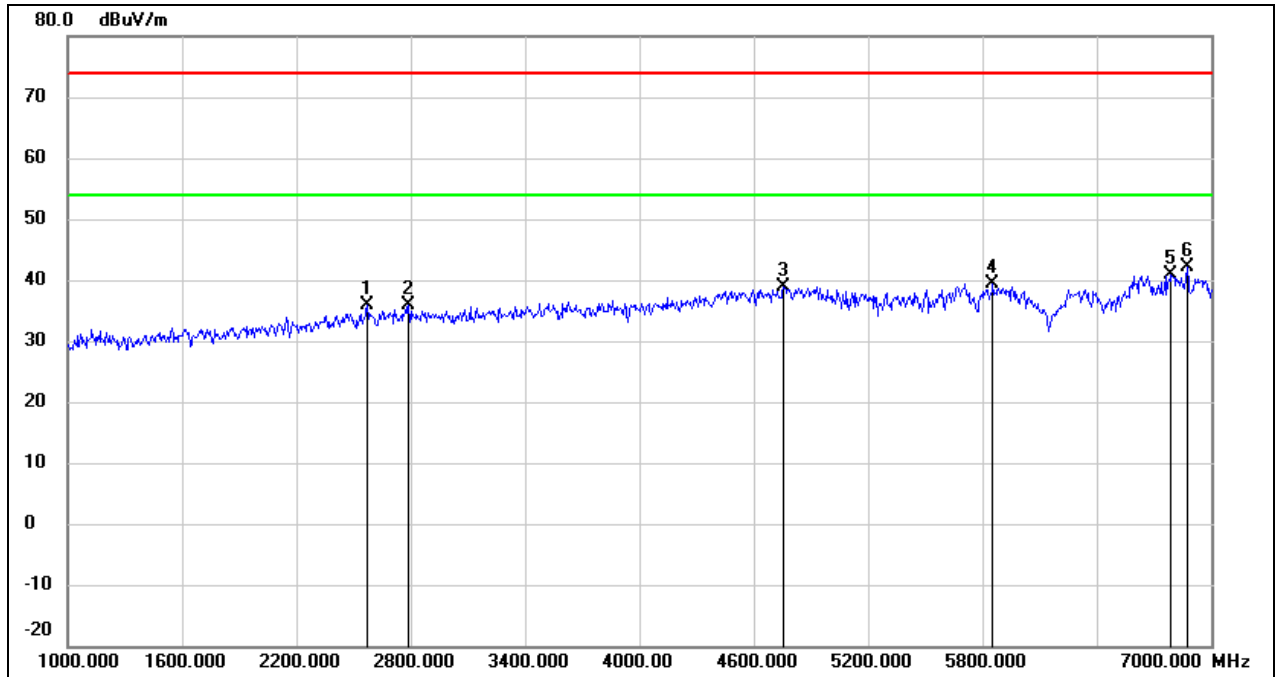

No.	Frequency (MHz)	Reading (dBuV)	Correct (dB/m)	Result (dBuV/m)	Limit (dBuV/m)	Margin (dB)	Remark
1	2572.000	44.04	-8.27	35.77	74.00	-38.23	peak
2	2788.000	43.47	-7.62	35.85	74.00	-38.15	peak
3	4756.000	40.07	-1.12	38.95	74.00	-35.05	peak
4	5854.000	37.91	1.43	39.34	74.00	-34.66	peak
5	6790.000	35.68	5.15	40.83	74.00	-33.17	peak
6	6874.000	36.61	5.57	42.18	74.00	-31.82	peak

Test Mode:	802.11a 20	Channel:	5745
Polarity:	Horizontal	Test Voltage:	DC 12 V

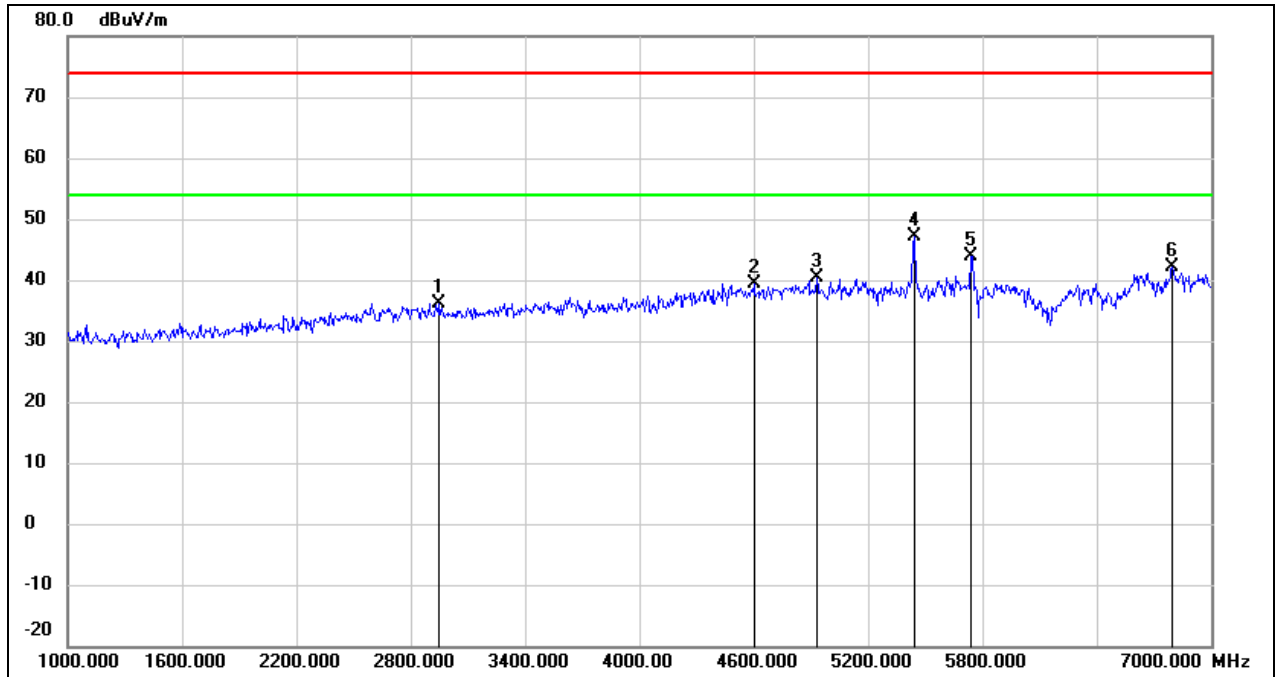

No.	Frequency (MHz)	Reading (dBuV)	Correct (dB/m)	Result (dBuV/m)	Limit (dBuV/m)	Margin (dB)	Remark
1	2950.000	43.33	-7.13	36.20	74.00	-37.80	peak
2	4600.000	41.19	-1.74	39.45	74.00	-34.55	peak
3	4930.000	40.73	-0.43	40.30	74.00	-33.70	peak
4	5440.000	46.67	0.35	47.02	74.00	-26.98	peak
5	5740.000	42.76	1.10	43.86	74.00	-30.14	peak
6	6796.000	36.91	5.19	42.10	74.00	-31.90	peak

Test Mode:	802.11a 20	Channel:	5745
Polarity:	Vertical	Test Voltage:	DC 12 V

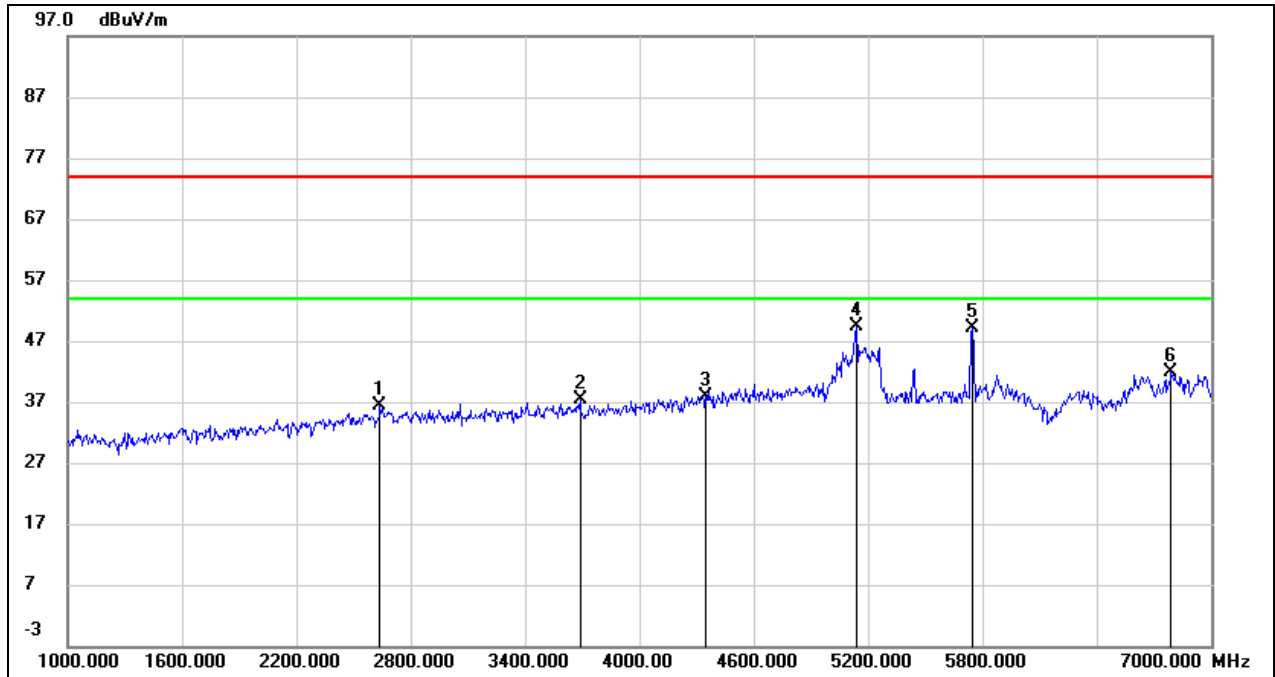

No.	Frequency (MHz)	Reading (dBuV)	Correct (dB/m)	Result (dBuV/m)	Limit (dBuV/m)	Margin (dB)	Remark
1	2638.000	44.51	-8.07	36.44	74.00	-37.56	peak
2	3688.000	42.75	-5.33	37.42	74.00	-36.58	peak
3	4348.000	40.78	-2.85	37.93	74.00	-36.07	peak
4	5140.000	49.41	0.01	49.42	74.00	-24.58	peak
5	5746.000	48.10	1.12	49.22	74.00	-24.78	peak
6	6790.000	36.77	5.15	41.92	74.00	-32.08	peak

Test Mode:	802.11a 20	Channel:	5785
Polarity:	Horizontal	Test Voltage:	DC 12 V

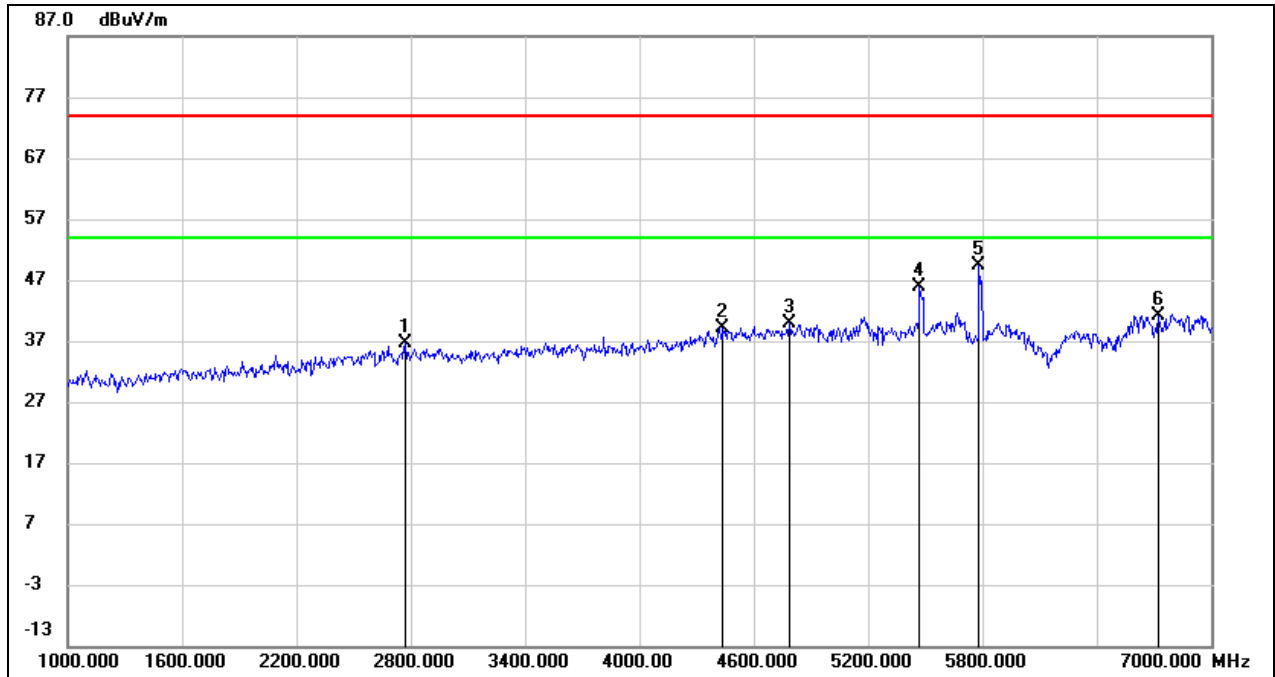

No.	Frequency (MHz)	Reading (dBuV)	Correct (dB/m)	Result (dBuV/m)	Limit (dBuV/m)	Margin (dB)	Remark
1	2770.000	44.29	-7.67	36.62	74.00	-37.38	peak
2	4438.000	41.59	-2.42	39.17	74.00	-34.83	peak
3	4786.000	40.84	-1.00	39.84	74.00	-34.16	peak
4	5470.000	45.40	0.39	45.79	74.00	-28.21	peak
5	5782.000	48.08	1.23	49.31	74.00	-24.69	peak
6	6724.000	36.27	4.82	41.09	74.00	-32.91	peak

Test Mode:	802.11a 20	Channel:	5785
Polarity:	Vertical	Test Voltage:	DC 12 V

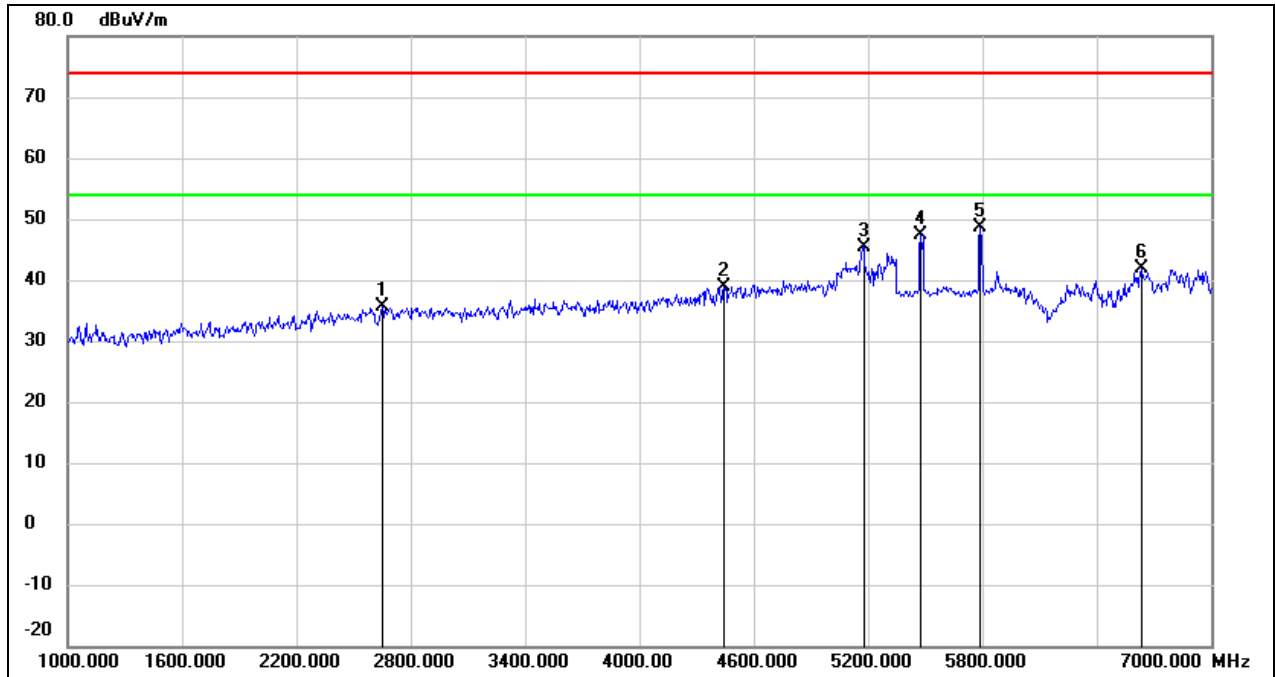

No.	Frequency (MHz)	Reading (dBuV)	Correct (dB/m)	Result (dBuV/m)	Limit (dBuV/m)	Margin (dB)	Remark
1	2650.000	43.55	-8.03	35.52	74.00	-38.48	peak
2	4444.000	41.30	-2.40	38.90	74.00	-35.10	peak
3	5176.000	45.34	0.05	45.39	74.00	-28.61	peak
4	5476.000	47.06	0.39	47.45	74.00	-26.55	peak
5	5788.000	47.32	1.25	48.57	74.00	-25.43	peak
6	6634.000	37.45	4.38	41.83	74.00	-32.17	peak



Test Mode:	802.11a 20	Channel:	5825
Polarity:	Horizontal	Test Voltage:	DC 12 V

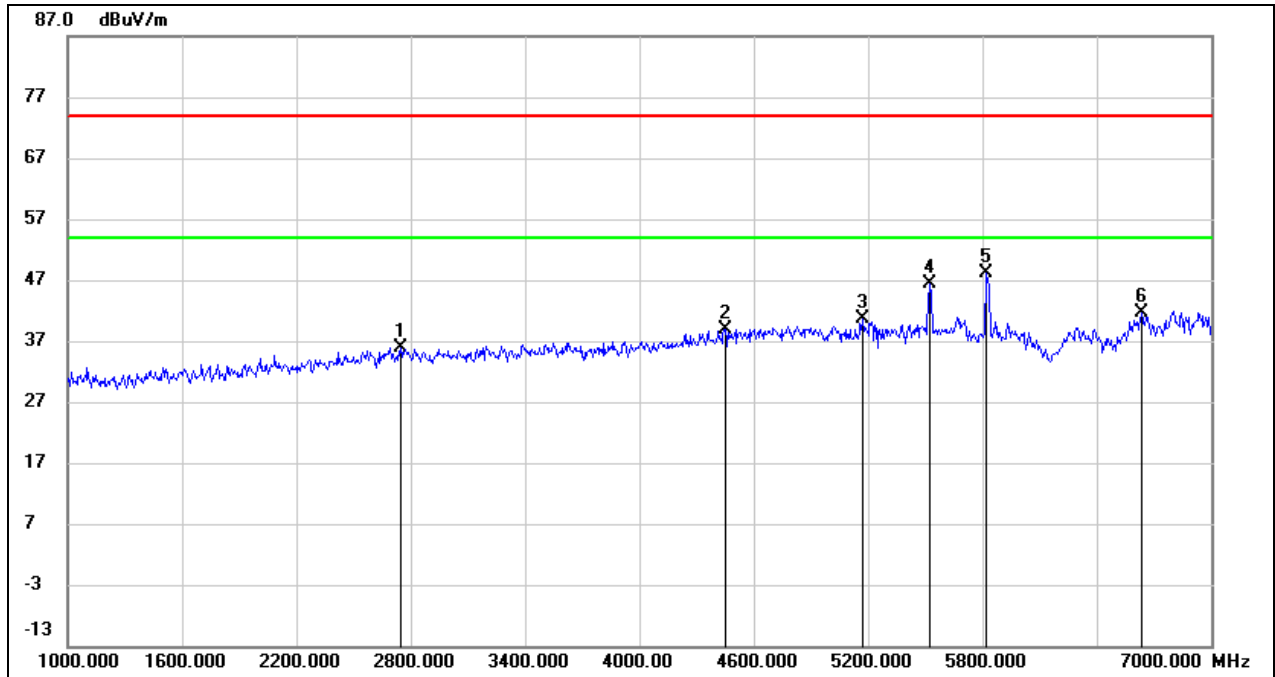

No.	Frequency (MHz)	Reading (dBuV)	Correct (dB/m)	Result (dBuV/m)	Limit (dBuV/m)	Margin (dB)	Remark
1	2746.000	43.73	-7.75	35.98	74.00	-38.02	peak
2	4450.000	41.30	-2.37	38.93	74.00	-35.07	peak
3	5170.000	40.51	0.05	40.56	74.00	-33.44	peak
4	5524.000	46.02	0.48	46.50	74.00	-27.50	peak
5	5818.000	46.71	1.33	48.04	74.00	-25.96	peak
6	6634.000	37.19	4.38	41.57	74.00	-32.43	peak

Test Mode:	802.11a 20	Channel:	5825
Polarity:	Vertical	Test Voltage:	DC 12 V

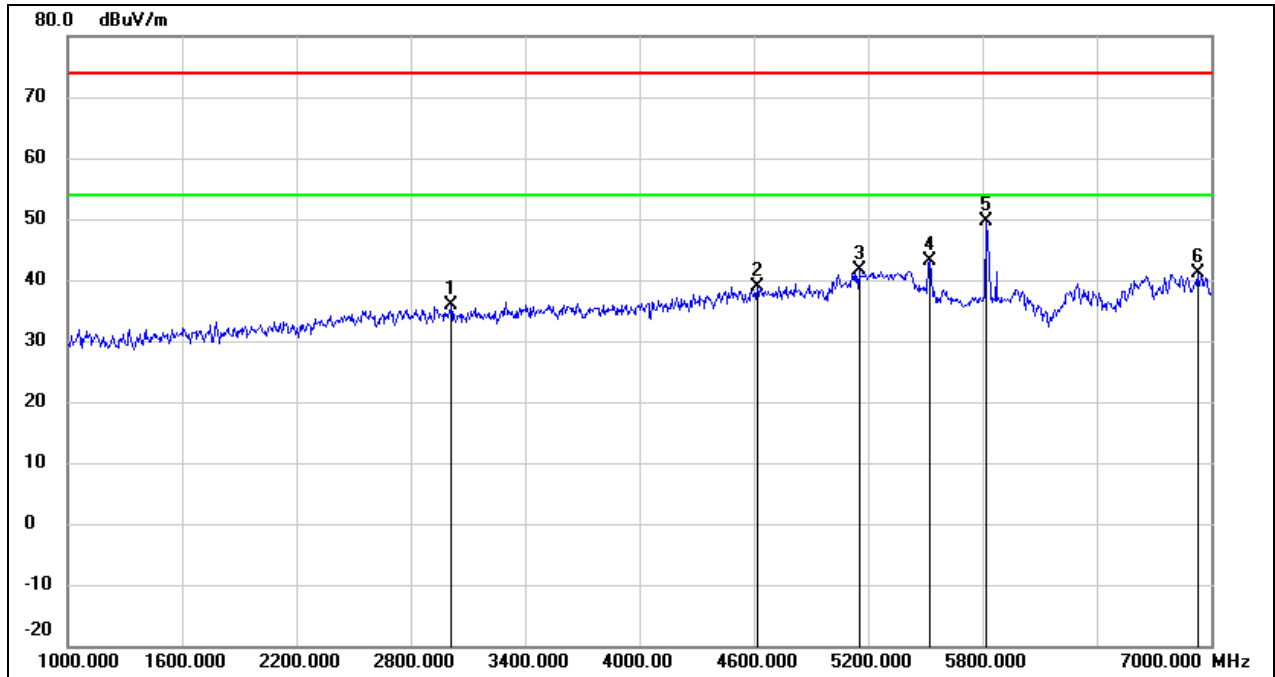

No.	Frequency (MHz)	Reading (dBuV)	Correct (dB/m)	Result (dBuV/m)	Limit (dBuV/m)	Margin (dB)	Remark
1	3010.000	42.77	-6.95	35.82	74.00	-38.18	peak
2	4618.000	40.65	-1.67	38.98	74.00	-35.02	peak
3	5152.000	41.61	0.02	41.63	74.00	-32.37	peak
4	5524.000	42.59	0.48	43.07	74.00	-30.93	peak
5	5818.000	48.19	1.33	49.52	74.00	-24.48	peak
6	6928.000	35.27	5.85	41.12	74.00	-32.88	peak

### 8.4. SPURIOUS EMISSIONS(1 GHZ~7 GHZ)

For ISED UNII-1 test data:

Test Mode:	802.11a 20	Channel:	5180
Polarity:	Horizontal	Test Voltage:	DC 12 V

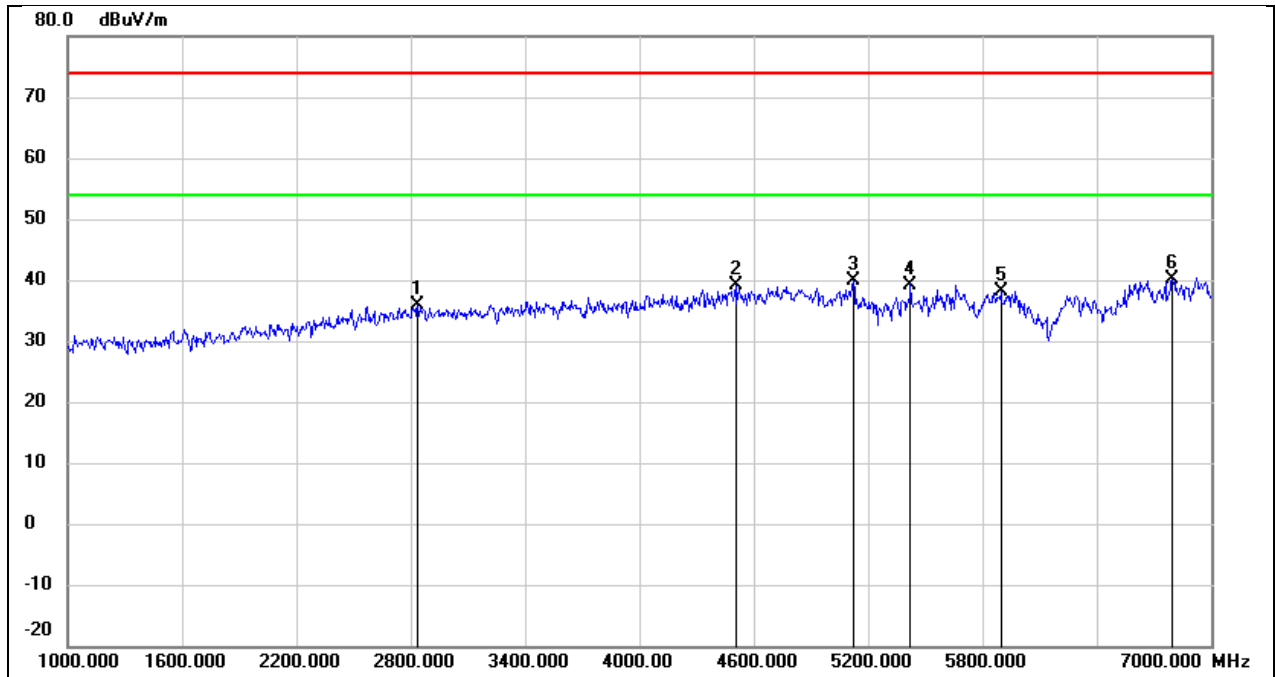

No.	Frequency (MHz)	Reading (dBuV)	Correct (dB/m)	Result (dBuV/m)	Limit (dBuV/m)	Margin (dB)	Remark
1	2836.000	43.38	-7.48	35.90	74.00	-38.10	peak
2	4504.000	41.28	-2.12	39.16	74.00	-34.84	peak
3	5122.000	39.89	-0.02	39.87	74.00	-34.13	peak
4	5422.000	38.93	0.32	39.25	74.00	-34.75	peak
5	5896.000	36.65	1.56	38.21	74.00	-35.79	peak
6	6796.000	34.90	5.19	40.09	74.00	-33.91	peak

Test Mode:	802.11a 20	Channel:	5180
Polarity:	Vertical	Test Voltage:	DC 12 V

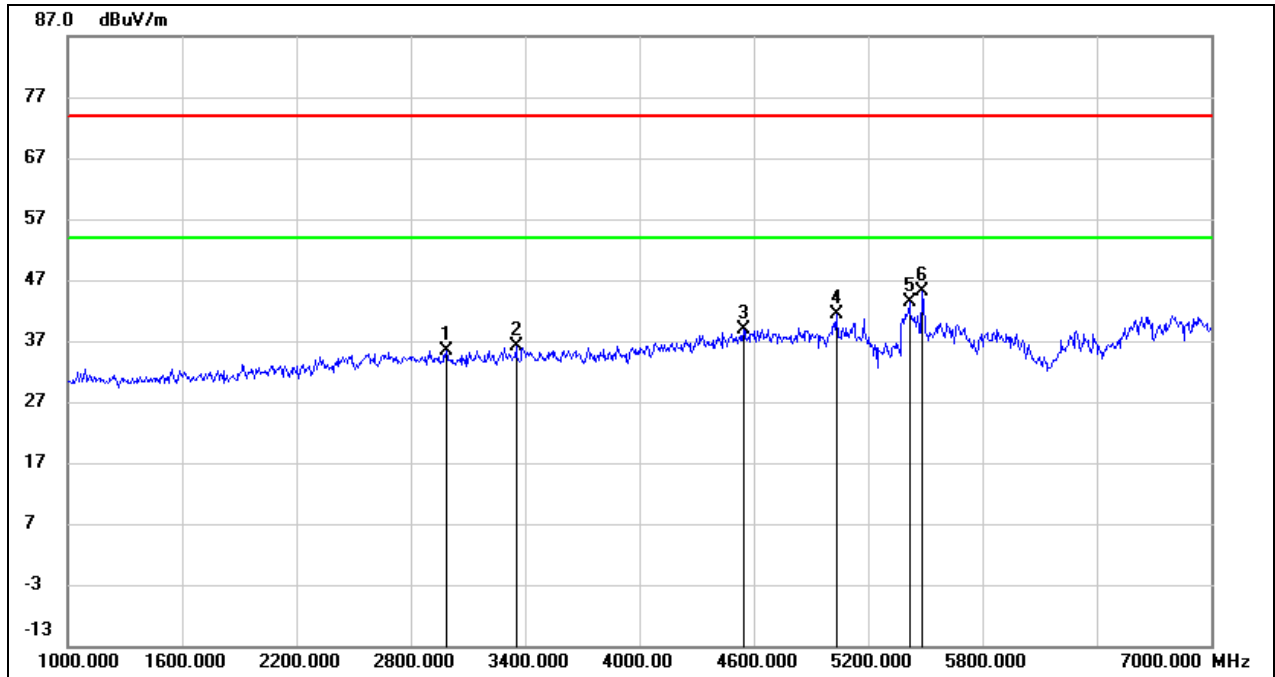

No.	Frequency (MHz)	Reading (dBuV)	Correct (dB/m)	Result (dBuV/m)	Limit (dBuV/m)	Margin (dB)	Remark
1	2986.000	42.44	-7.03	35.41	74.00	-38.59	peak
2	3352.000	42.38	-6.19	36.19	74.00	-37.81	peak
3	4546.000	40.80	-1.96	38.84	74.00	-35.16	peak
4	5032.000	41.48	-0.12	41.36	74.00	-32.64	peak
5	5416.000	43.14	0.32	43.46	74.00	-30.54	peak
6	5482.000	44.80	0.40	45.20	74.00	-28.80	peak

Test Mode:	802.11a 20	Channel:	5200
Polarity:	Horizontal	Test Voltage:	DC 12 V

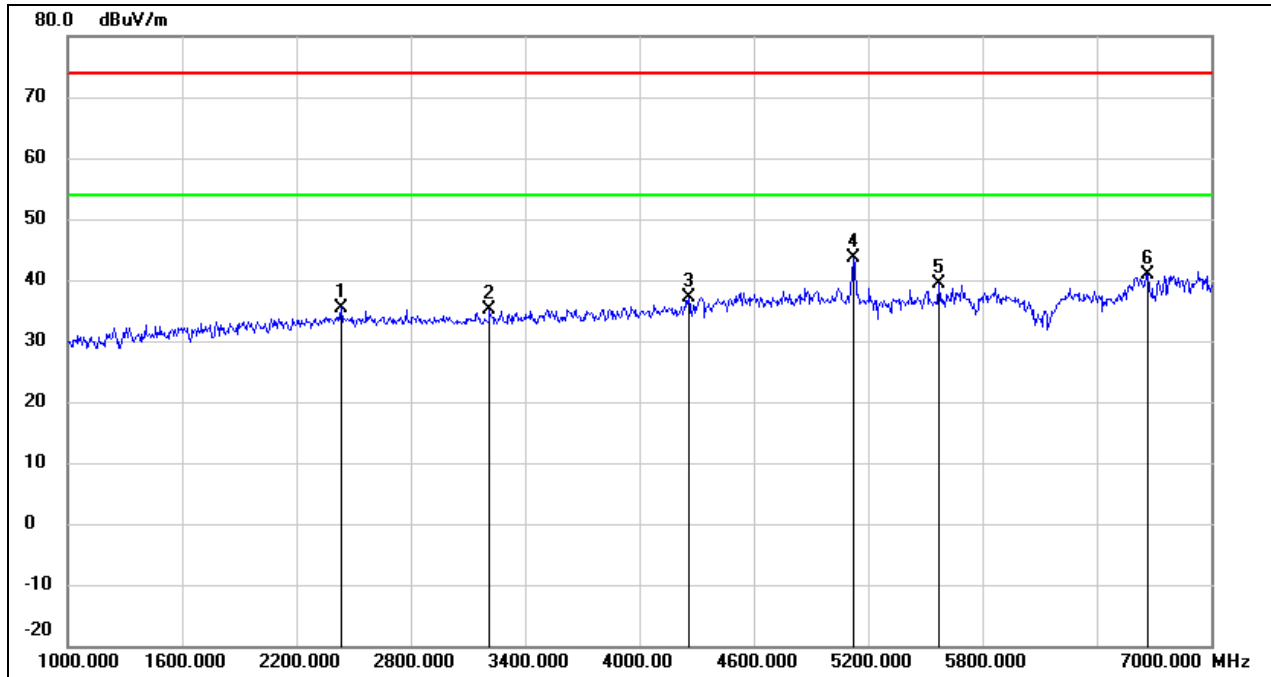

No.	Frequency (MHz)	Reading (dBuV)	Correct (dB/m)	Result (dBuV/m)	Limit (dBuV/m)	Margin (dB)	Remark
1	2434.000	44.33	-8.83	35.50	74.00	-38.50	peak
2	3214.000	41.73	-6.50	35.23	74.00	-38.77	peak
3	4258.000	40.38	-3.27	37.11	74.00	-36.89	peak
4	5122.000	43.75	-0.02	43.73	74.00	-30.27	peak
5	5572.000	38.72	0.63	39.35	74.00	-34.65	peak
6	6670.000	36.37	4.57	40.94	74.00	-33.06	peak

Test Mode:	802.11a 20	Channel:	5200
Polarity:	Vertical	Test Voltage:	DC 12 V

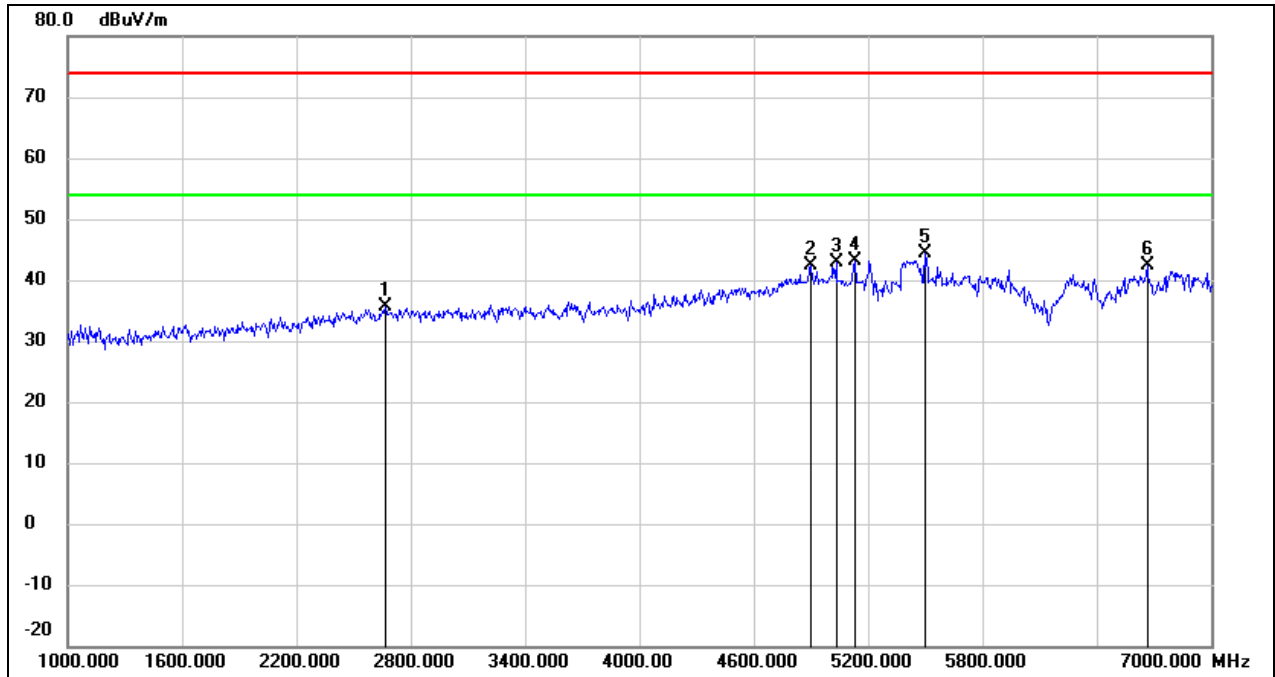

No.	Frequency (MHz)	Reading (dBuV)	Correct (dB/m)	Result (dBuV/m)	Limit (dBuV/m)	Margin (dB)	Remark
1	2668.000	43.52	-7.98	35.54	74.00	-38.46	peak
2	4900.000	42.88	-0.55	42.33	74.00	-31.67	peak
3	5032.000	42.90	-0.12	42.78	74.00	-31.22	peak
4	5134.000	43.22	0.00	43.22	74.00	-30.78	peak
5	5500.000	43.99	0.42	44.41	74.00	-29.59	peak
6	6664.000	37.79	4.54	42.33	74.00	-31.67	peak

Test Mode:	802.11a 20	Channel:	5240
Polarity:	Horizontal	Test Voltage:	DC 12 V

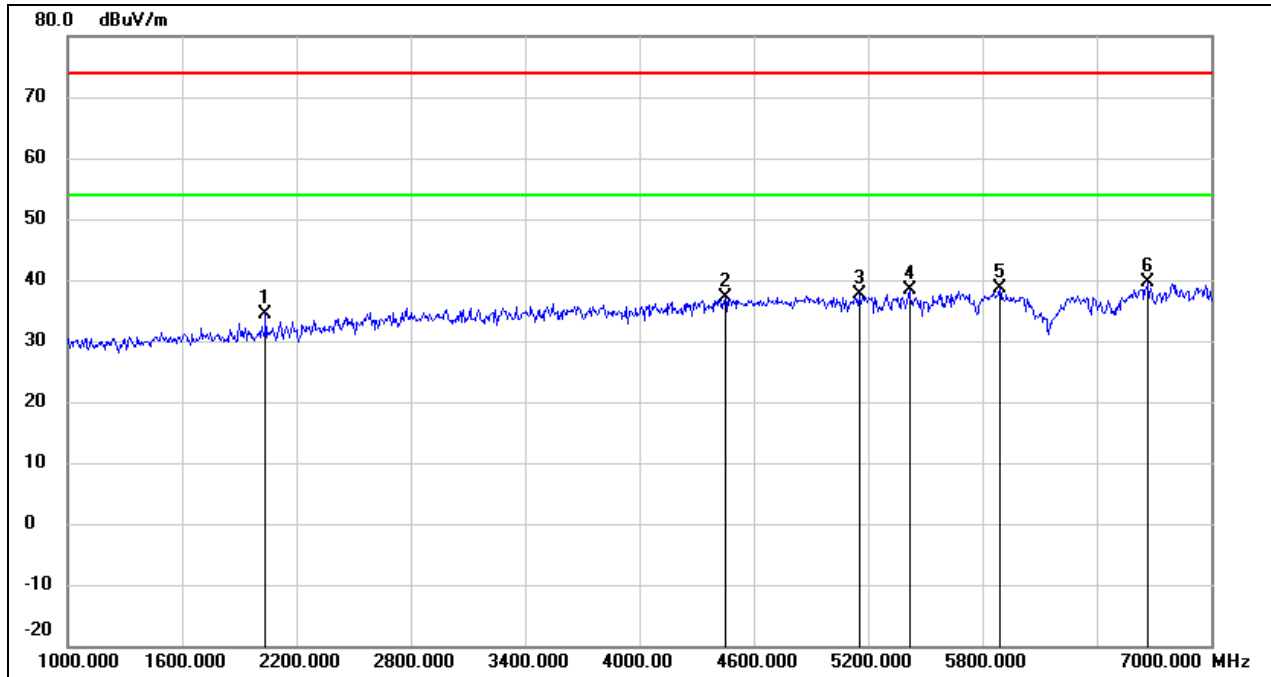

No.	Frequency (MHz)	Reading (dBuV)	Correct (dB/m)	Result (dBuV/m)	Limit (dBuV/m)	Margin (dB)	Remark
1	2038.000	45.36	-10.86	34.50	74.00	-39.50	peak
2	4450.000	39.44	-2.37	37.07	74.00	-36.93	peak
3	5152.000	37.70	0.02	37.72	74.00	-36.28	peak
4	5416.000	38.06	0.32	38.38	74.00	-35.62	peak
5	5890.000	37.00	1.54	38.54	74.00	-35.46	peak
6	6670.000	35.13	4.57	39.70	74.00	-34.30	peak

Test Mode:	802.11a 20	Channel:	5240
Polarity:	Vertical	Test Voltage:	DC 12 V

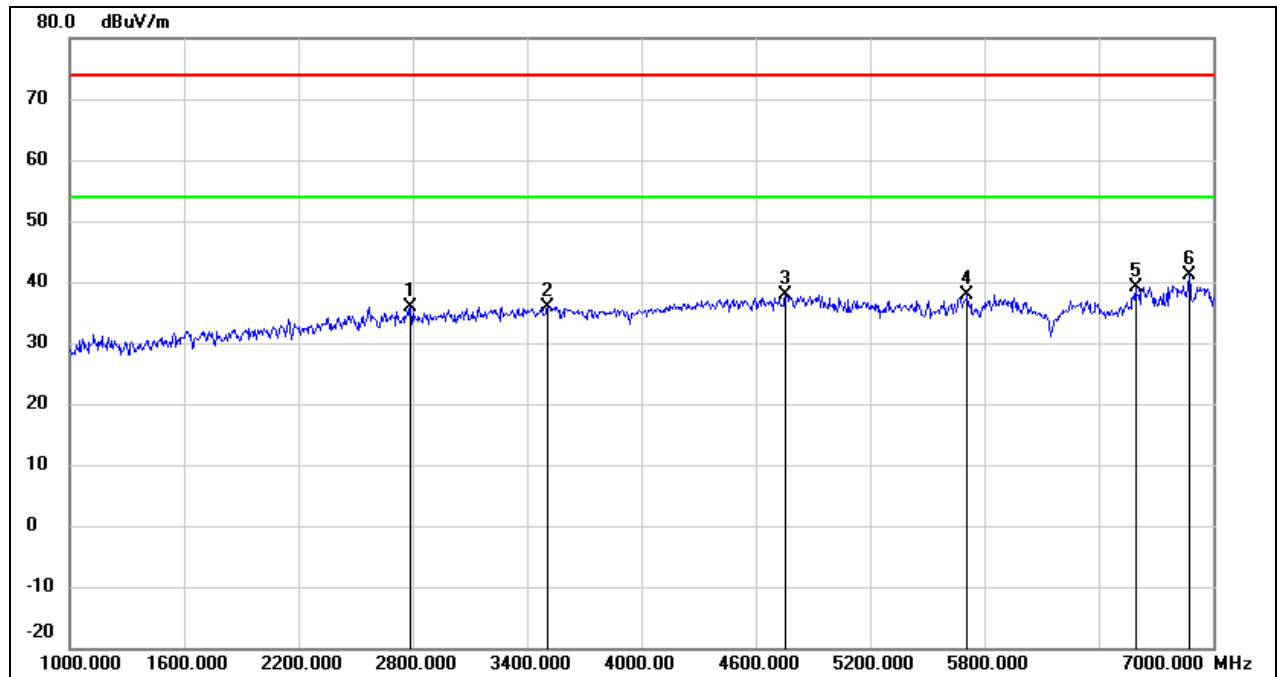

No.	Frequency (MHz)	Reading (dBuV)	Correct (dB/m)	Result (dBuV/m)	Limit (dBuV/m)	Margin (dB)	Remark
1	2788.000	43.47	-7.62	35.85	74.00	-38.15	peak
2	3508.000	41.78	-5.82	35.96	74.00	-38.04	peak
3	4756.000	39.07	-1.12	37.95	74.00	-36.05	peak
4	5710.000	36.82	1.02	37.84	74.00	-36.16	peak
5	6592.000	34.84	4.19	39.03	74.00	-34.97	peak
6	6874.000	35.61	5.57	41.18	74.00	-32.82	peak



### 8.5. SPURIOUS EMISSIONS(7 GHZ~18 GHZ)

For FCC UNII-1&UNII-3; ISED UNII-3 test data:

Test Mode:	802.11a 20	Channel:	5180
Polarity:	Horizontal	Test Voltage:	DC 12 V

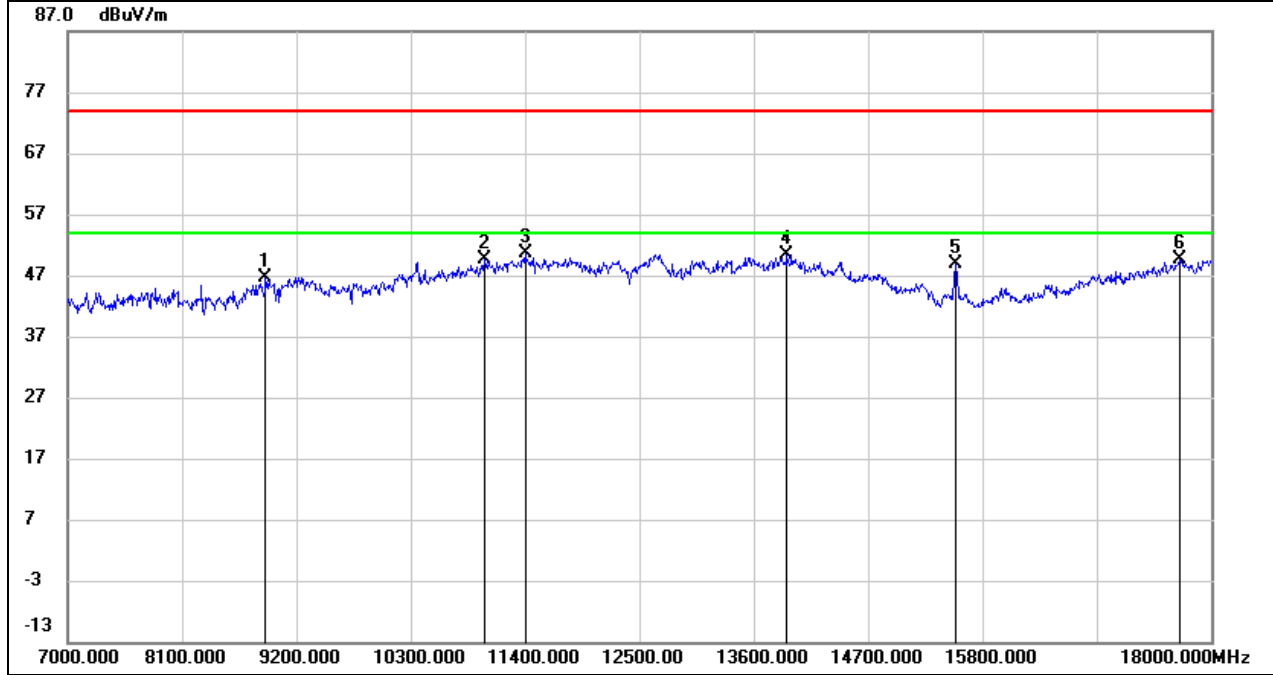

No.	Frequency (MHz)	Reading (dBuV)	Correct (dB/m)	Result (dBuV/m)	Limit (dBuV/m)	Margin (dB)	Remark
1	8903.000	36.96	9.66	46.62	74.00	-27.38	peak
2	11015.000	34.93	14.79	49.72	74.00	-24.28	peak
3	11400.000	34.25	16.36	50.61	74.00	-23.39	peak
4	13919.000	28.79	21.68	50.47	74.00	-23.53	peak
5	15536.000	32.08	16.73	48.81	74.00	-25.19	peak
6	17692.000	25.65	24.01	49.66	74.00	-24.34	peak

Test Mode:	802.11a 20	Channel:	5180
Polarity:	Vertical	Test Voltage:	DC 12 V

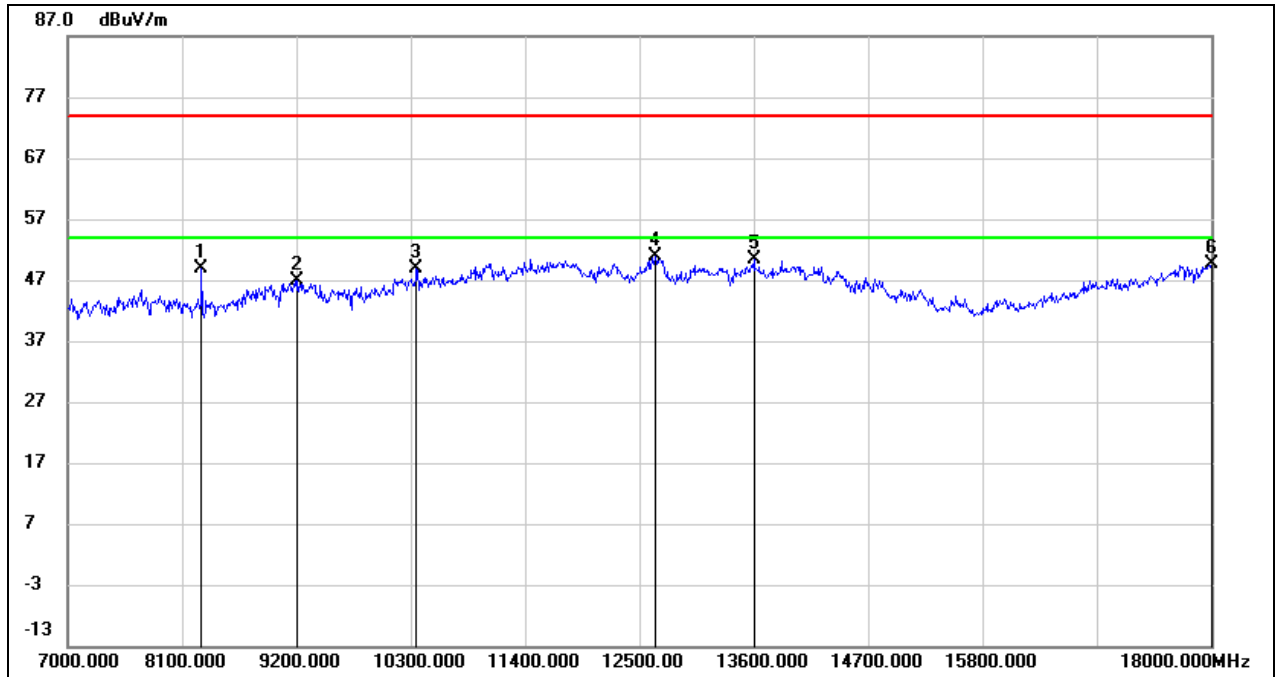

No.	Frequency (MHz)	Reading (dBuV)	Correct (dB/m)	Result (dBuV/m)	Limit (dBuV/m)	Margin (dB)	Remark
1	8287.000	42.11	6.70	48.81	74.00	-25.19	peak
2	9211.000	36.31	10.47	46.78	74.00	-27.22	peak
3	10355.000	36.36	12.52	48.88	74.00	-25.12	peak
4	12654.000	32.76	18.01	50.77	74.00	-23.23	peak
5	13600.000	29.52	20.89	50.41	74.00	-23.59	peak
6	18000.000	23.60	26.12	49.72	74.00	-24.28	peak

Test Mode:	802.11a 20	Channel:	5200
Polarity:	Horizontal	Test Voltage:	DC 12 V

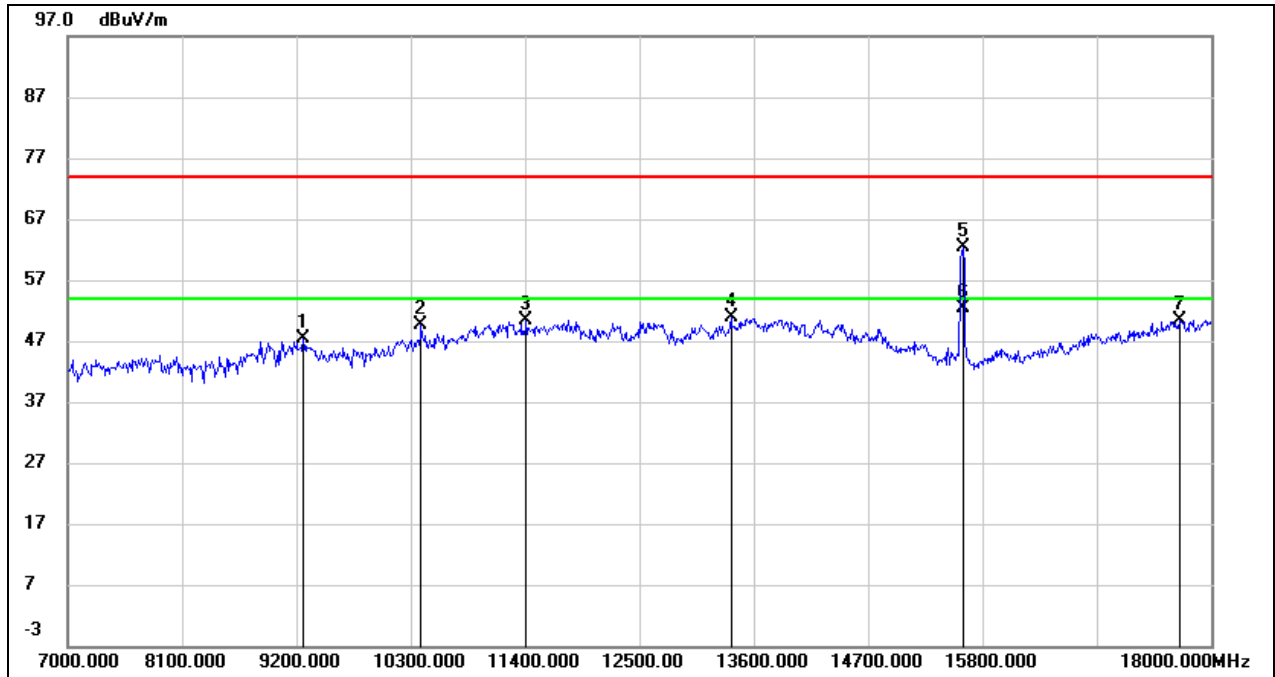

No.	Frequency (MHz)	Reading (dBuV)	Correct (dB/m)	Result (dBuV/m)	Limit (dBuV/m)	Margin (dB)	Remark
1	9266.000	36.76	10.51	47.27	74.00	-26.73	peak
2	10399.000	37.00	12.61	49.61	74.00	-24.39	peak
3	11411.000	33.90	16.41	50.31	74.00	-23.69	peak
4	13380.000	30.82	20.12	50.94	74.00	-23.06	peak
5	15613.000	45.54	16.76	62.30	74.00	-11.70	peak
6	15613.000	35.54	16.76	52.30	54.00	-1.70	AVG
7	17692.000	26.40	24.01	50.41	74.00	-23.59	peak

Test Mode:	802.11a 20	Channel:	5200
Polarity:	Vertical	Test Voltage:	DC 12 V

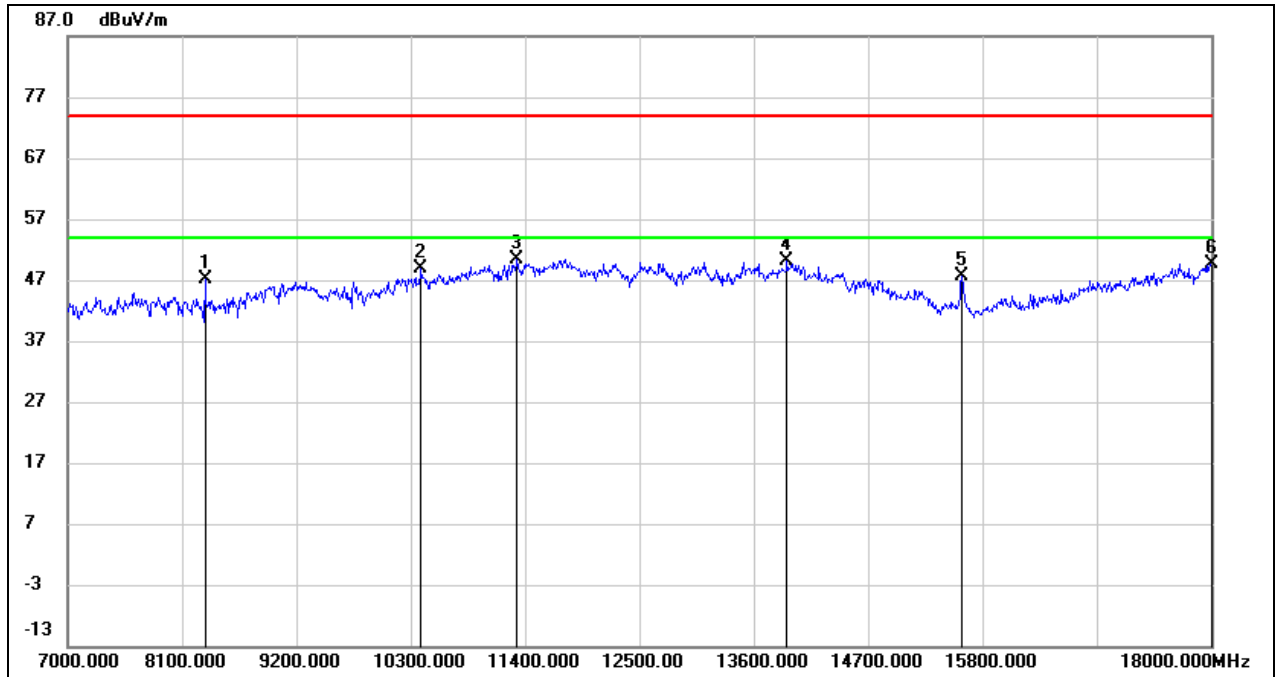

No.	Frequency (MHz)	Reading (dBuV)	Correct (dB/m)	Result (dBuV/m)	Limit (dBuV/m)	Margin (dB)	Remark
1	8320.000	40.48	6.72	47.20	74.00	-26.80	peak
2	10399.000	36.20	12.61	48.81	74.00	-25.19	peak
3	11323.000	34.25	16.05	50.30	74.00	-23.70	peak
4	13919.000	28.37	21.68	50.05	74.00	-23.95	peak
5	15602.000	30.81	16.75	47.56	74.00	-26.44	peak
6	18000.000	23.56	26.12	49.68	74.00	-24.32	peak

Test Mode:	802.11a 20	Channel:	5240
Polarity:	Horizontal	Test Voltage:	DC 12 V

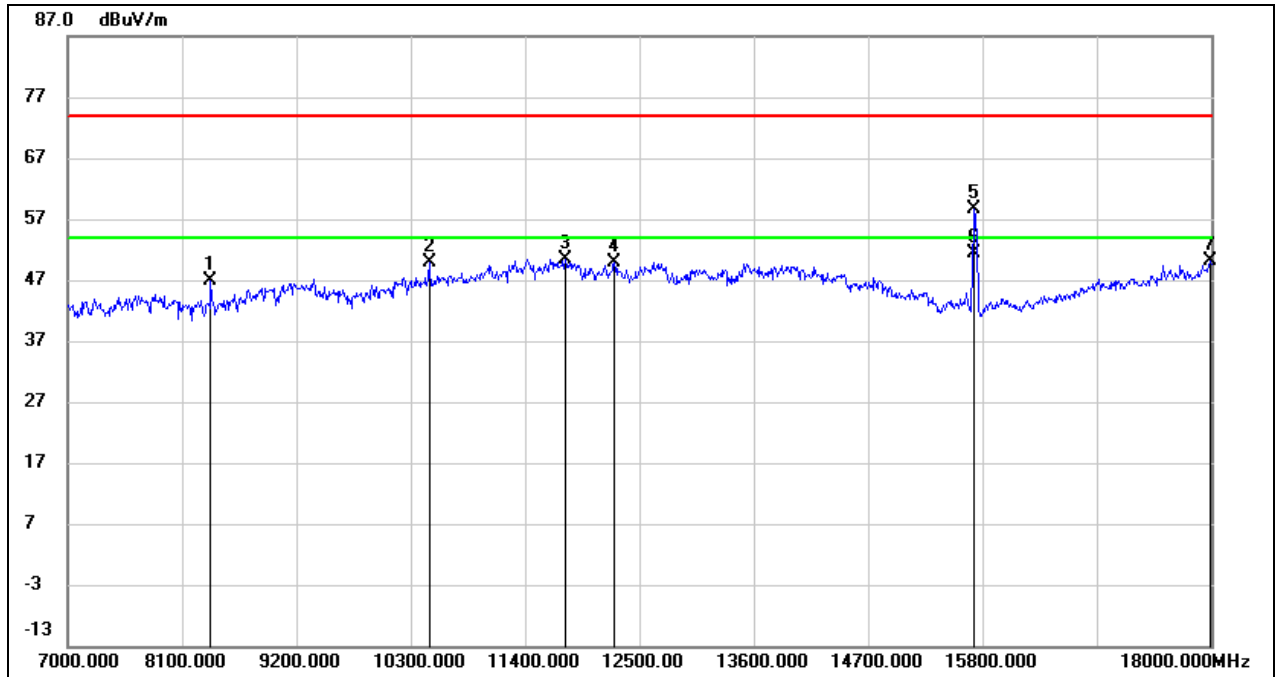

No.	Frequency (MHz)	Reading (dBuV)	Correct (dB/m)	Result (dBuV/m)	Limit (dBuV/m)	Margin (dB)	Remark
1	8375.000	40.16	6.77	46.93	74.00	-27.07	peak
2	10476.000	37.13	12.77	49.90	74.00	-24.10	peak
3	11785.000	33.13	17.30	50.43	74.00	-23.57	peak
4	12258.000	32.07	17.77	49.84	74.00	-24.16	peak
5	15723.000	41.91	16.81	58.72	74.00	-15.28	peak
6	15723.000	34.49	16.81	51.30	54.00	-2.70	AVG
7	17989.000	24.01	26.04	50.05	74.00	-23.95	peak

Test Mode:	802.11a 20	Channel:	5240
Polarity:	Vertical	Test Voltage:	DC 12 V

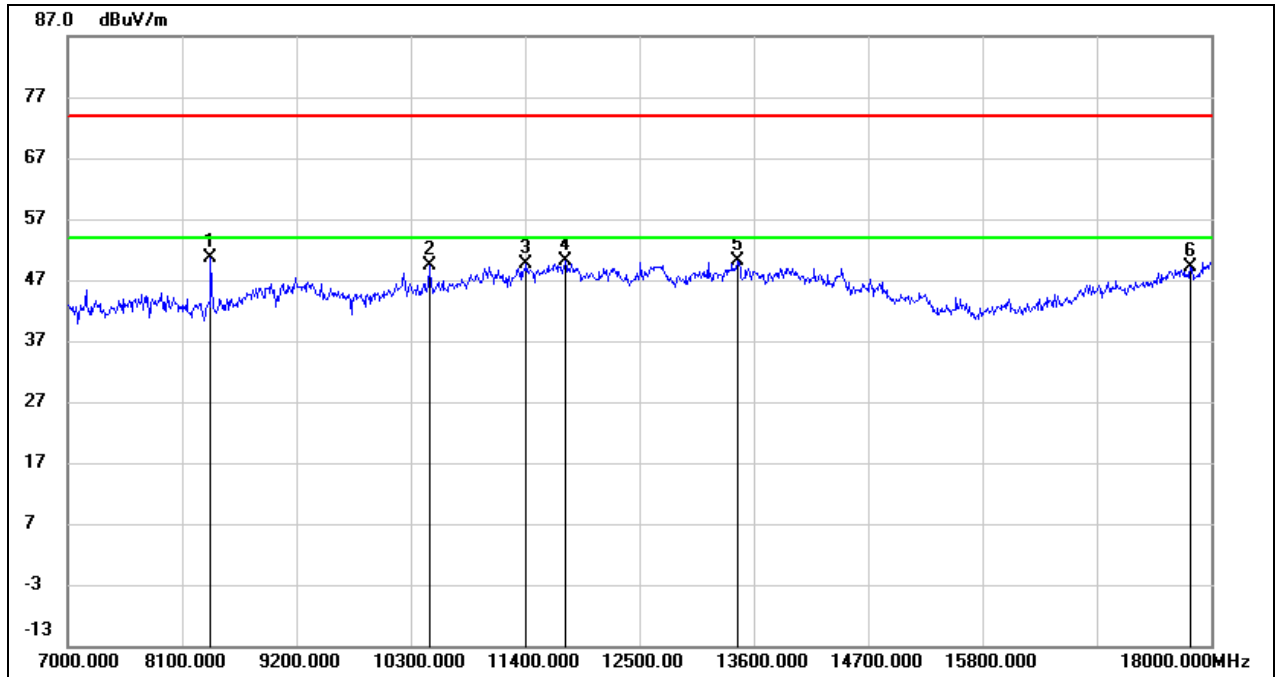

No.	Frequency (MHz)	Reading (dBuV)	Correct (dB/m)	Result (dBuV/m)	Limit (dBuV/m)	Margin (dB)	Remark
1	8375.000	43.76	6.77	50.53	74.00	-23.47	peak
2	10476.000	36.64	12.77	49.41	74.00	-24.59	peak
3	11411.000	33.16	16.41	49.57	74.00	-24.43	peak
4	11785.000	32.89	17.30	50.19	74.00	-23.81	peak
5	13446.000	29.78	20.41	50.19	74.00	-23.81	peak
6	17802.000	24.39	24.76	49.15	74.00	-24.85	peak

Test Mode:	802.11a 20	Channel:	5745
Polarity:	Horizontal	Test Voltage:	DC 12 V

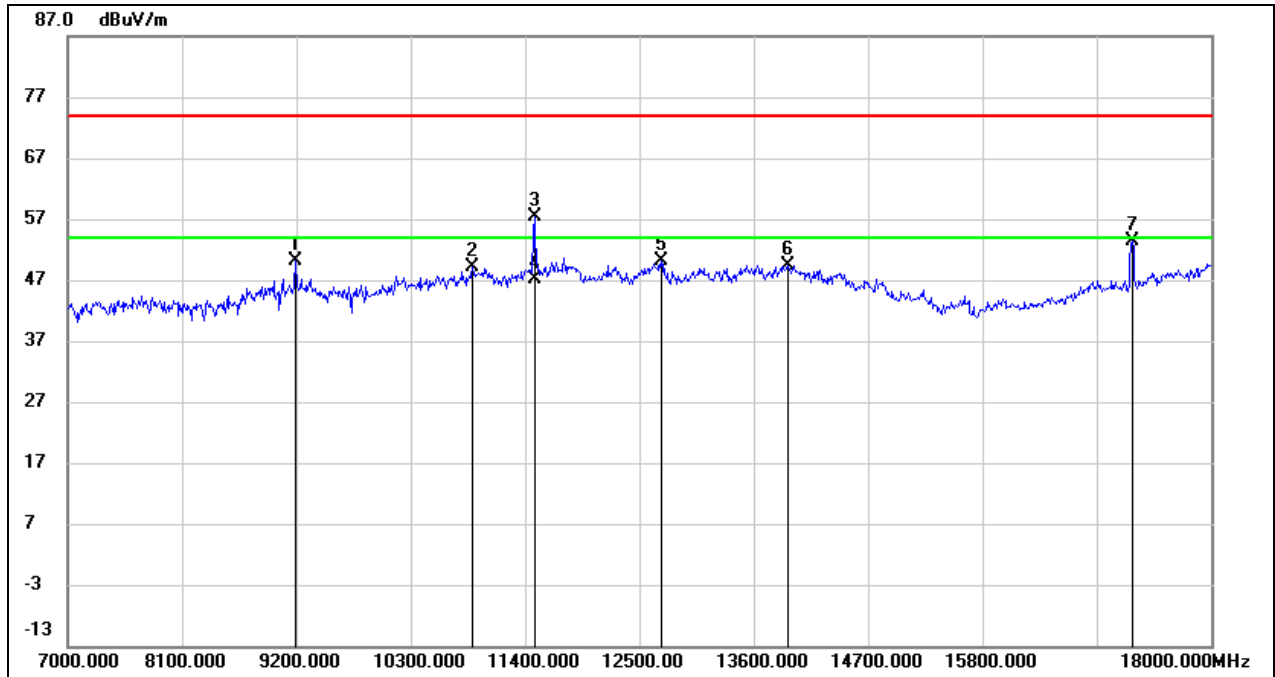

No.	Frequency (MHz)	Reading (dBuV)	Correct (dB/m)	Result (dBuV/m)	Limit (dBuV/m)	Margin (dB)	Remark
1	9189.000	39.56	10.46	50.02	74.00	-23.98	peak
2	10894.000	34.90	14.32	49.22	74.00	-24.78	peak
3	11488.000	40.63	16.72	57.35	74.00	-16.65	peak
4	11488.000	30.38	16.72	47.10	54.00	-6.90	AVG
5	12709.000	32.10	18.09	50.19	74.00	-23.81	peak
6	13930.000	27.79	21.71	49.50	74.00	-24.50	peak
7	17241.000	31.78	21.62	53.40	74.00	-20.60	peak

Test Mode:	802.11a 20	Channel:	5745
Polarity:	Vertical	Test Voltage:	DC 12 V

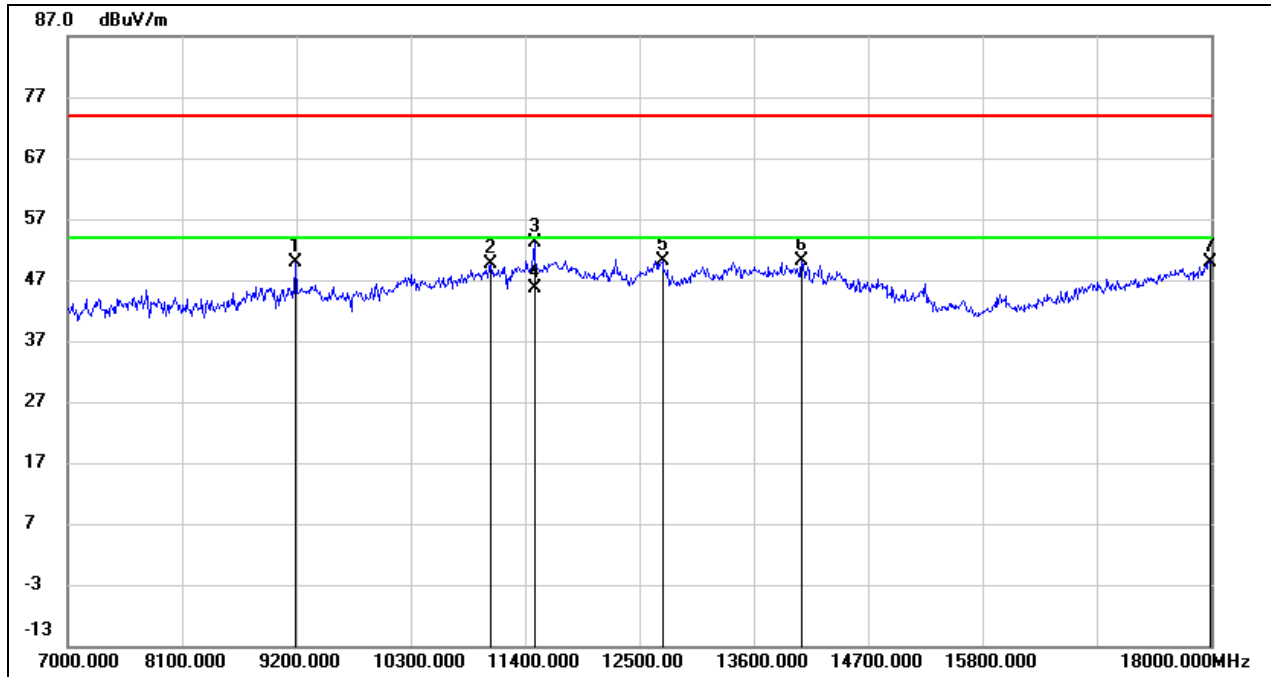

No.	Frequency (MHz)	Reading (dBuV)	Correct (dB/m)	Result (dBuV/m)	Limit (dBuV/m)	Margin (dB)	Remark
1	9189.000	39.40	10.46	49.86	74.00	-24.14	peak
2	11070.000	34.58	15.01	49.59	74.00	-24.41	peak
3	11488.000	36.42	16.72	53.14	74.00	-20.86	peak
4	11488.000	28.88	16.72	45.60	54.00	-8.40	AVG
5	12720.000	32.13	18.09	50.22	74.00	-23.78	peak
6	14062.000	28.53	21.62	50.15	74.00	-23.85	peak
7	17989.000	23.90	26.04	49.94	74.00	-24.06	peak



Test Mode:	802.11a 20	Channel:	5785
Polarity:	Horizontal	Test Voltage:	DC 12 V

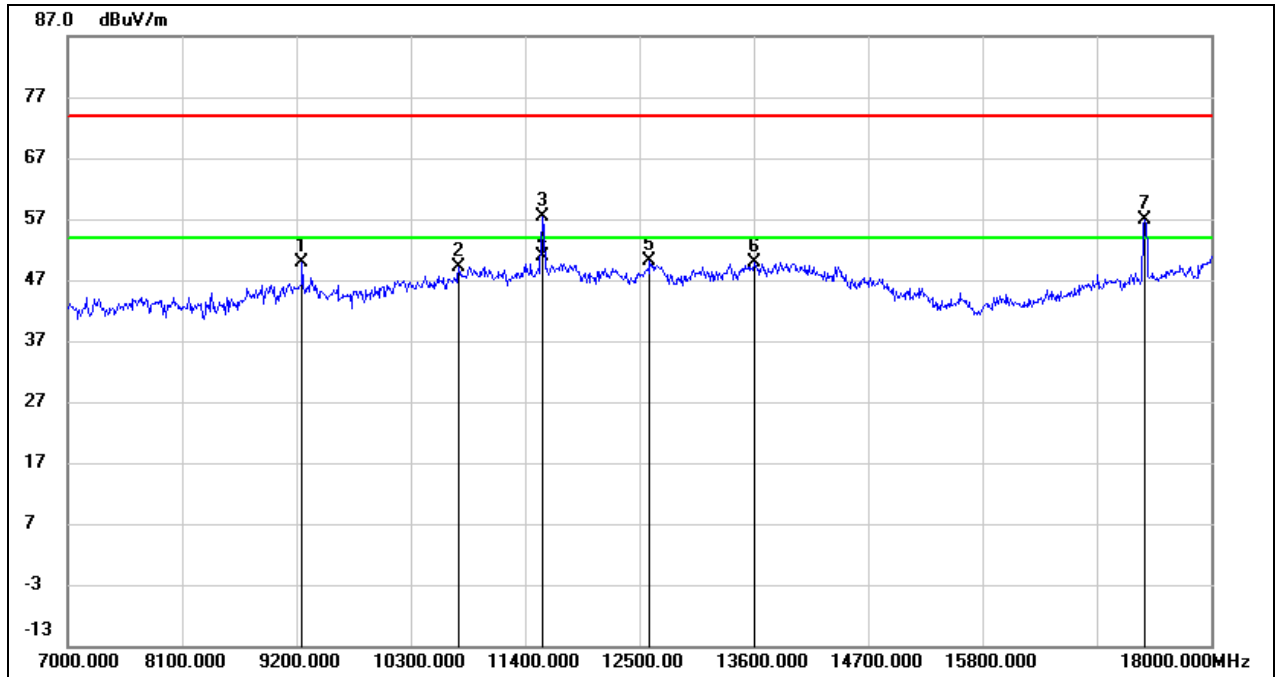

No.	Frequency (MHz)	Reading (dBuV)	Correct (dB/m)	Result (dBuV/m)	Limit (dBuV/m)	Margin (dB)	Remark
1	9255.000	39.38	10.51	49.89	74.00	-24.11	peak
2	10762.000	35.37	13.82	49.19	74.00	-24.81	peak
3	11565.000	40.59	16.89	57.48	74.00	-16.52	peak
4	11565.000	33.91	16.89	50.80	54.00	-3.20	AVG
5	12599.000	32.17	17.95	50.12	74.00	-23.88	peak
6	13600.000	29.03	20.89	49.92	74.00	-24.08	peak
7	17362.000	34.80	22.12	56.92	74.00	-17.08	peak

Test Mode:	802.11a 20	Channel:	5785
Polarity:	Vertical	Test Voltage:	DC 12 V

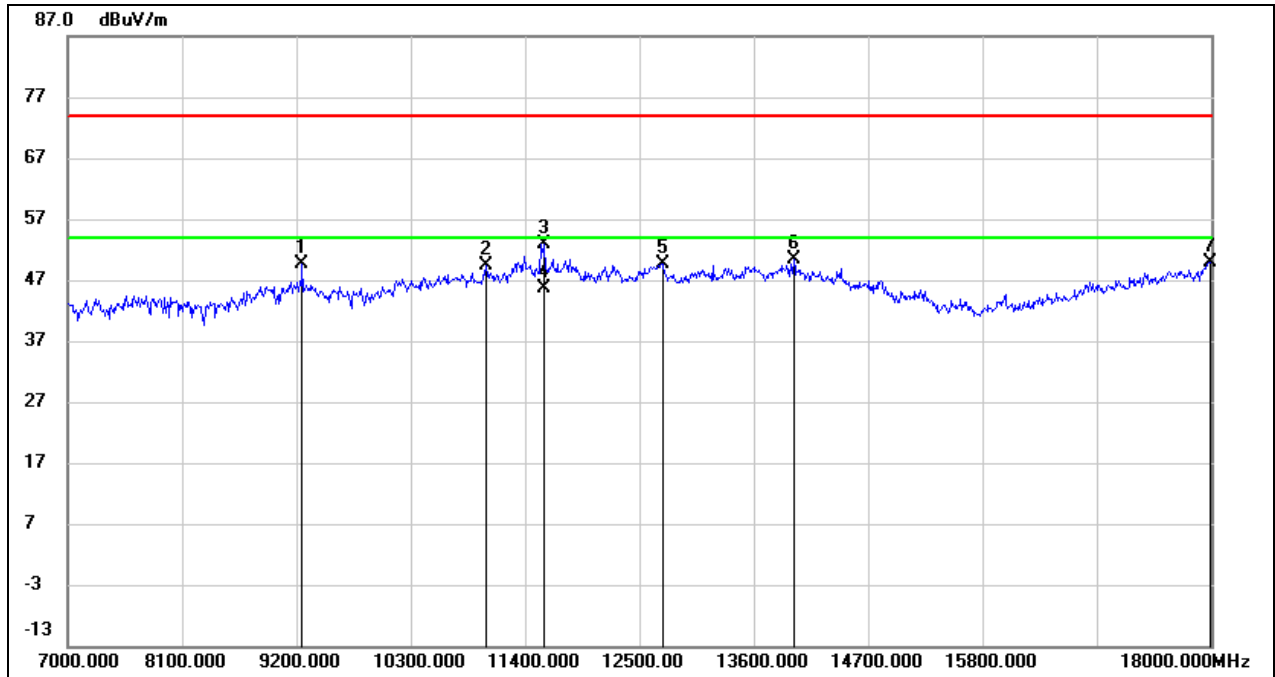

No.	Frequency (MHz)	Reading (dBuV)	Correct (dB/m)	Result (dBuV/m)	Limit (dBuV/m)	Margin (dB)	Remark
1	9255.000	39.13	10.51	49.64	74.00	-24.36	peak
2	11026.000	34.65	14.82	49.47	74.00	-24.53	peak
3	11576.000	35.93	16.91	52.84	74.00	-21.16	peak
4	11576.000	28.79	16.91	45.70	54.00	-8.30	AVG
5	12720.000	31.50	18.09	49.59	74.00	-24.41	peak
6	13985.000	28.48	21.85	50.33	74.00	-23.67	peak
7	17989.000	23.78	26.04	49.82	74.00	-24.18	peak

Test Mode:	802.11a 20	Channel:	5825
Polarity:	Horizontal	Test Voltage:	DC 12 V

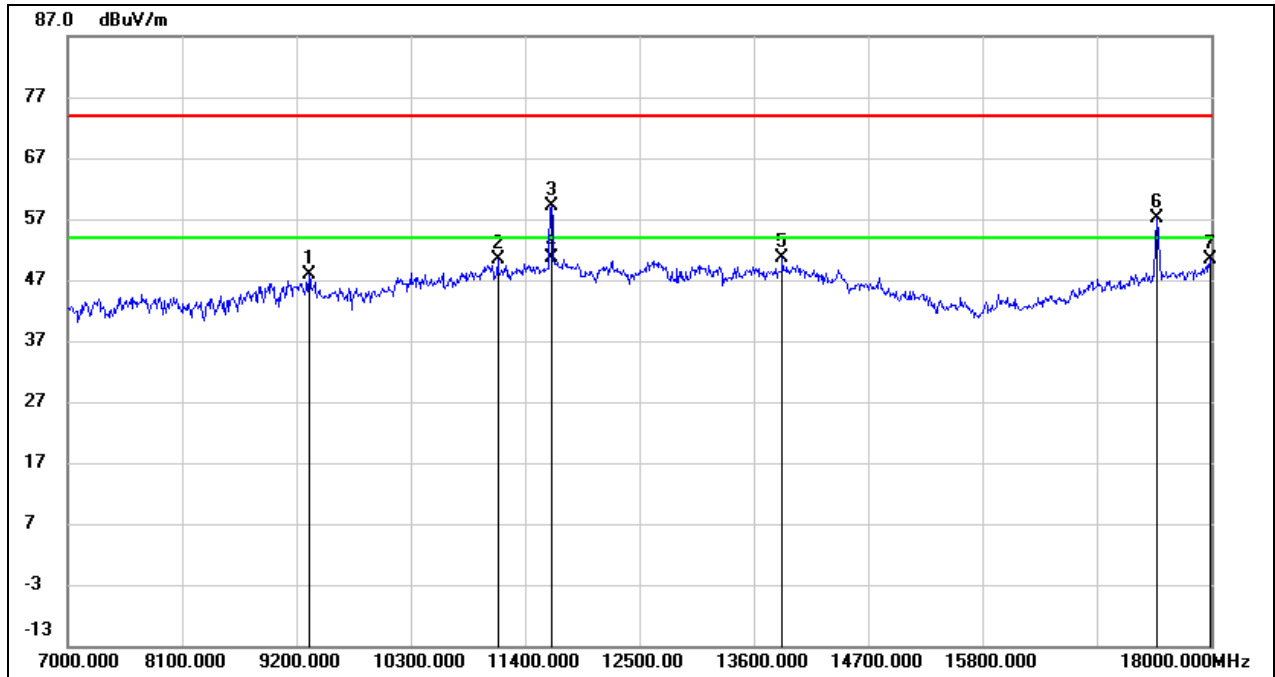

No.	Frequency (MHz)	Reading (dBuV)	Correct (dB/m)	Result (dBuV/m)	Limit (dBuV/m)	Margin (dB)	Remark
1	9321.000	37.44	10.53	47.97	74.00	-26.03	peak
2	11136.000	35.10	15.27	50.37	74.00	-23.63	peak
3	11653.000	42.20	17.05	59.25	74.00	-14.75	peak
4	11653.000	33.49	17.05	50.54	54.00	-3.46	AVG
5	13875.000	29.00	21.57	50.57	74.00	-23.43	peak
6	17483.000	34.61	22.62	57.23	74.00	-16.77	peak
7	17989.000	24.28	26.04	50.32	74.00	-23.68	peak

Test Mode:	802.11a 20	Channel:	5825
Polarity:	Vertical	Test Voltage:	DC 12 V

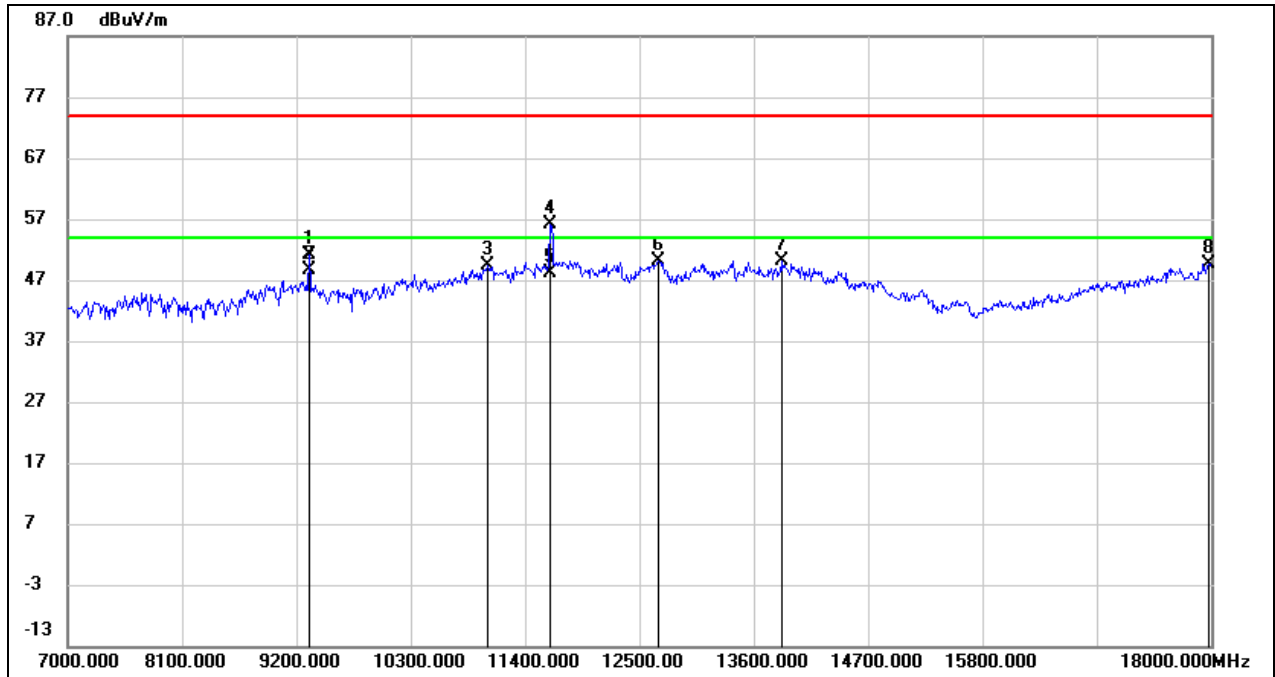

No.	Frequency (MHz)	Reading (dBuV)	Correct (dB/m)	Result (dBuV/m)	Limit (dBuV/m)	Margin (dB)	Remark
1	9321.000	40.59	10.53	51.12	74.00	-22.88	peak
2	9321.000	37.99	10.53	48.52	54.00	-5.48	AVG
3	11037.000	34.59	14.87	49.46	74.00	-24.54	peak
4	11642.000	39.20	17.03	56.23	74.00	-17.77	peak
5	11642.000	31.08	17.03	48.11	54.00	-5.89	AVG
6	12676.000	32.16	18.05	50.21	74.00	-23.79	peak
7	13864.000	28.68	21.53	50.21	74.00	-23.79	peak
8	17978.000	23.68	25.97	49.65	74.00	-24.35	peak

Test Mode:	802.11ax HE20	Channel:	5180
Polarity:	Horizontal	Test Voltage:	DC 12 V

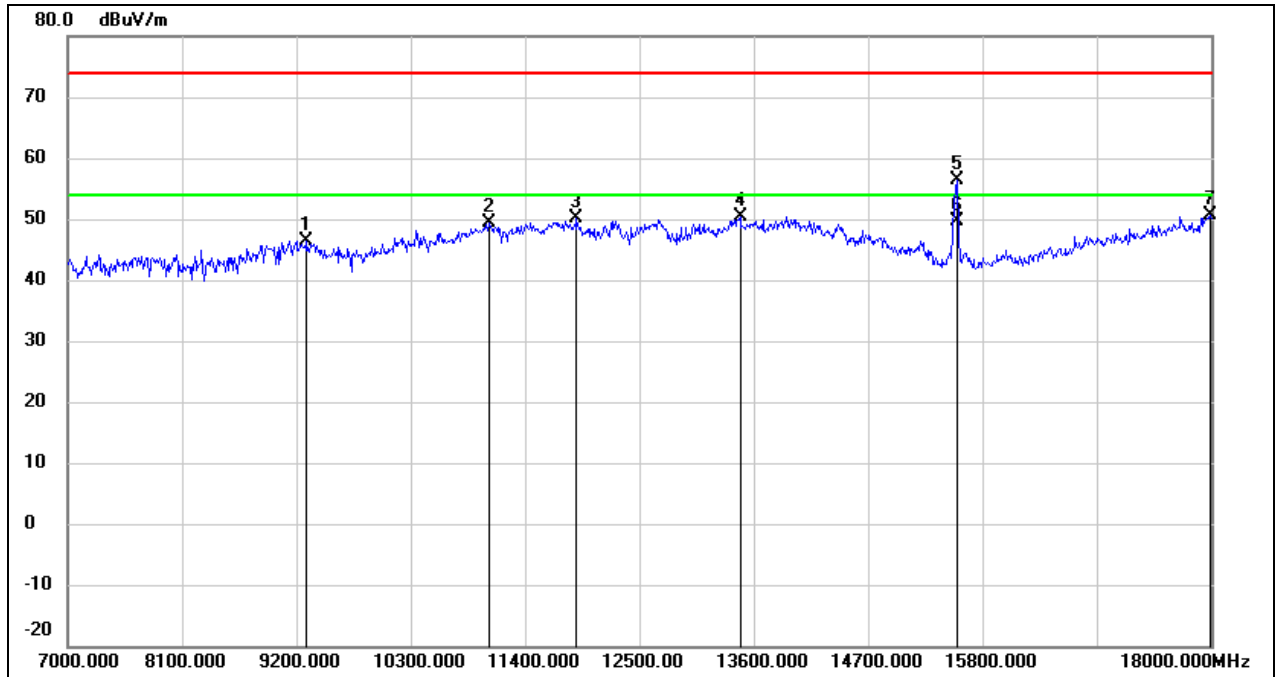

No.	Frequency (MHz)	Reading (dBuV)	Correct (dB/m)	Result (dBuV/m)	Limit (dBuV/m)	Margin (dB)	Remark
1	9299.000	35.95	10.53	46.48	74.00	-27.52	peak
2	11059.000	34.45	14.96	49.41	74.00	-24.59	peak
3	11895.000	32.73	17.51	50.24	74.00	-23.76	peak
4	13468.000	29.94	20.50	50.44	74.00	-23.56	peak
5	15558.000	39.63	16.74	56.37	74.00	-17.63	peak
6	15558.000	32.86	16.74	49.60	54.00	-4.40	AVG
7	17989.000	24.58	26.04	50.62	74.00	-23.38	peak

Test Mode:	802.11ax HE20	Channel:	5180
Polarity:	Vertical	Test Voltage:	DC 12 V

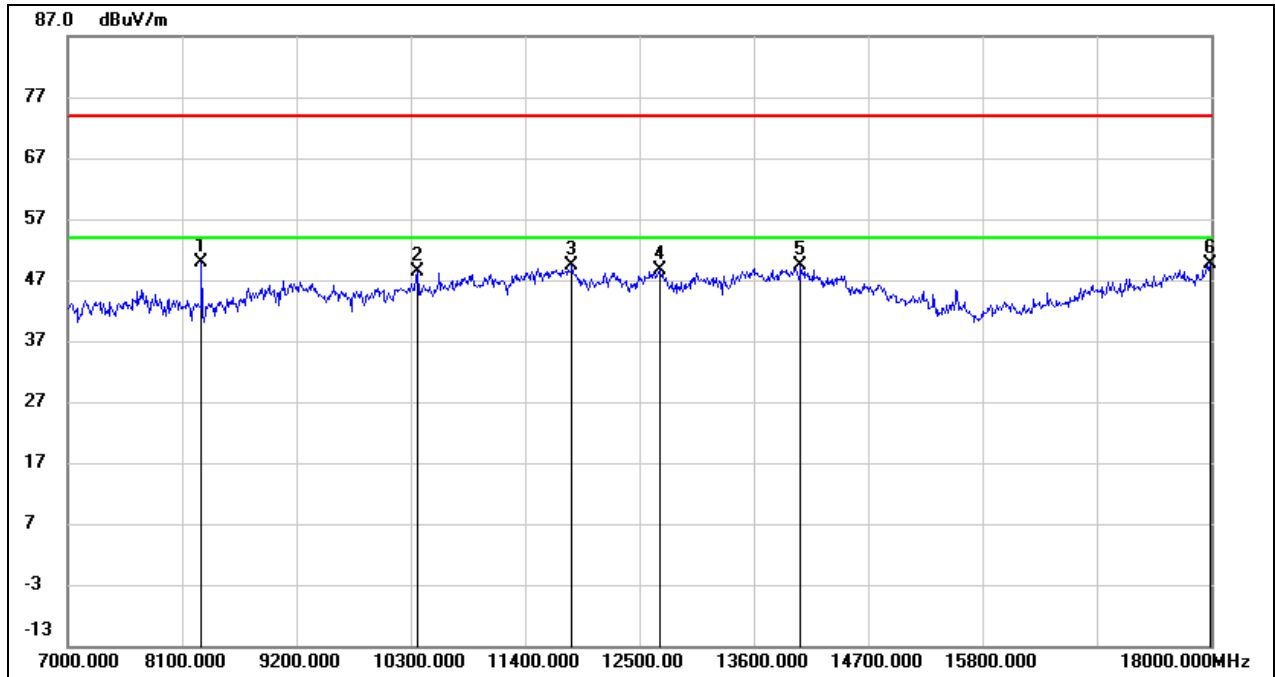

No.	Frequency (MHz)	Reading (dBuV)	Correct (dB/m)	Result (dBuV/m)	Limit (dBuV/m)	Margin (dB)	Remark
1	8287.000	43.22	6.70	49.92	74.00	-24.08	peak
2	10366.000	35.76	12.54	48.30	74.00	-25.70	peak
3	11851.000	31.98	17.43	49.41	74.00	-24.59	peak
4	12698.000	30.50	18.08	48.58	74.00	-25.42	peak
5	14051.000	27.64	21.67	49.31	74.00	-24.69	peak
6	17989.000	23.60	26.04	49.64	74.00	-24.36	peak

Test Mode:	802.11ax HE20	Channel:	5200
Polarity:	Horizontal	Test Voltage:	DC 12 V

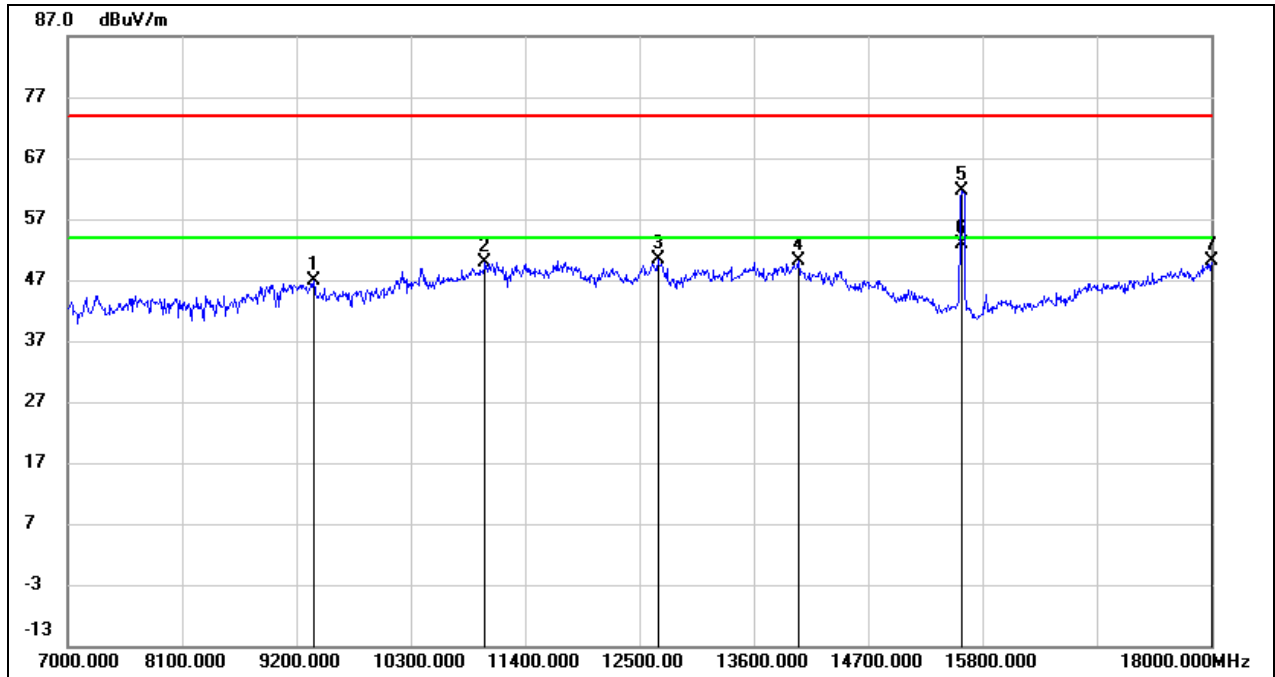

No.	Frequency (MHz)	Reading (dBuV)	Correct (dB/m)	Result (dBuV/m)	Limit (dBuV/m)	Margin (dB)	Remark
1	9365.000	36.31	10.57	46.88	74.00	-27.12	peak
2	11015.000	35.17	14.79	49.96	74.00	-24.04	peak
3	12676.000	32.38	18.05	50.43	74.00	-23.57	peak
4	14029.000	28.29	21.76	50.05	74.00	-23.95	peak
5	15602.000	44.78	16.75	61.53	74.00	-12.47	peak
6	15602.000	36.03	16.75	52.78	54.00	-1.22	AVG
7	18000.000	23.91	26.12	50.03	74.00	-23.97	peak

Test Mode:	802.11ax HE20	Channel:	5200
Polarity:	Vertical	Test Voltage:	DC 12 V

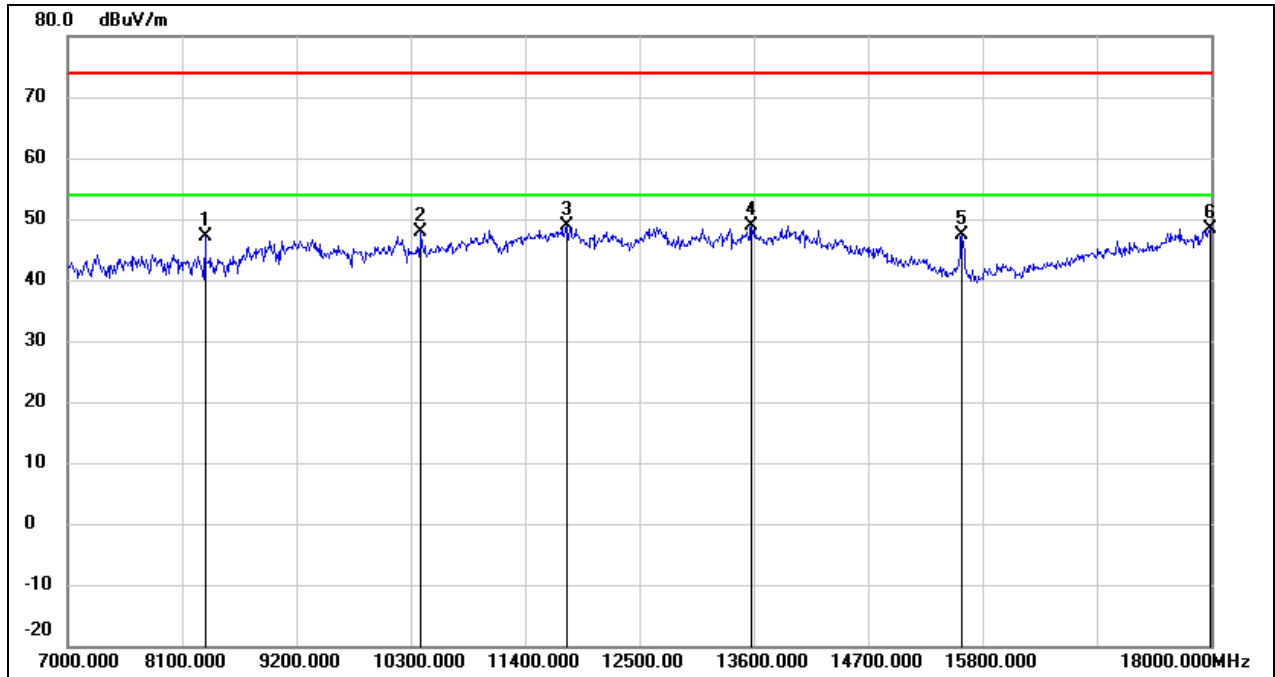

No.	Frequency (MHz)	Reading (dBuV)	Correct (dB/m)	Result (dBuV/m)	Limit (dBuV/m)	Margin (dB)	Remark
1	8320.000	40.38	6.72	47.10	74.00	-26.90	peak
2	10399.000	35.34	12.61	47.95	74.00	-26.05	peak
3	11796.000	31.46	17.32	48.78	74.00	-25.22	peak
4	13578.000	28.02	20.83	48.85	74.00	-25.15	peak
5	15602.000	30.73	16.75	47.48	74.00	-26.52	peak
6	17989.000	22.37	26.04	48.41	74.00	-25.59	peak



Test Mode:	802.11ax HE20	Channel:	5240
Polarity:	Horizontal	Test Voltage:	DC 12 V

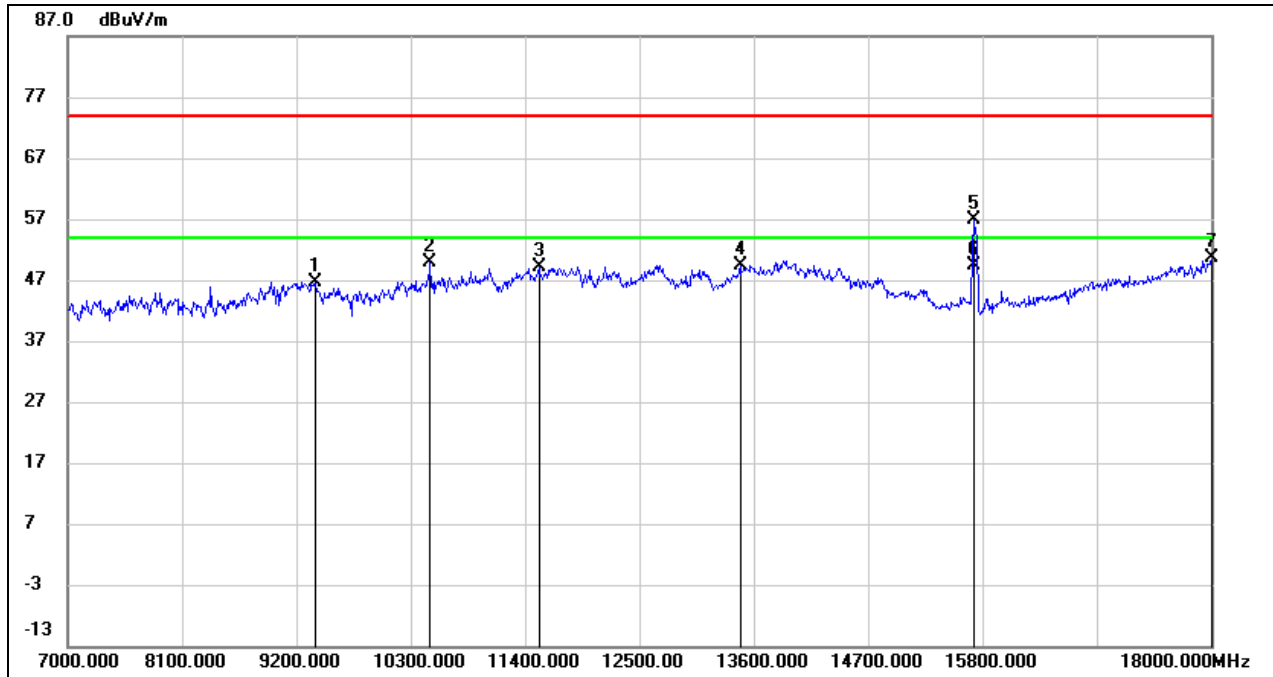

No.	Frequency (MHz)	Reading (dBuV)	Correct (dB/m)	Result (dBuV/m)	Limit (dBuV/m)	Margin (dB)	Remark
1	9387.000	36.07	10.58	46.65	74.00	-27.35	peak
2	10487.000	37.14	12.79	49.93	74.00	-24.07	peak
3	11532.000	32.42	16.83	49.25	74.00	-24.75	peak
4	13468.000	28.87	20.50	49.37	74.00	-24.63	peak
5	15712.000	39.98	16.80	56.78	74.00	-17.22	peak
6	15712.000	32.50	16.80	49.30	54.00	-4.70	AVG
7	18000.000	24.40	26.12	50.52	74.00	-23.48	peak

Test Mode:	802.11ax HE20	Channel:	5240
Polarity:	Vertical	Test Voltage:	DC 12 V

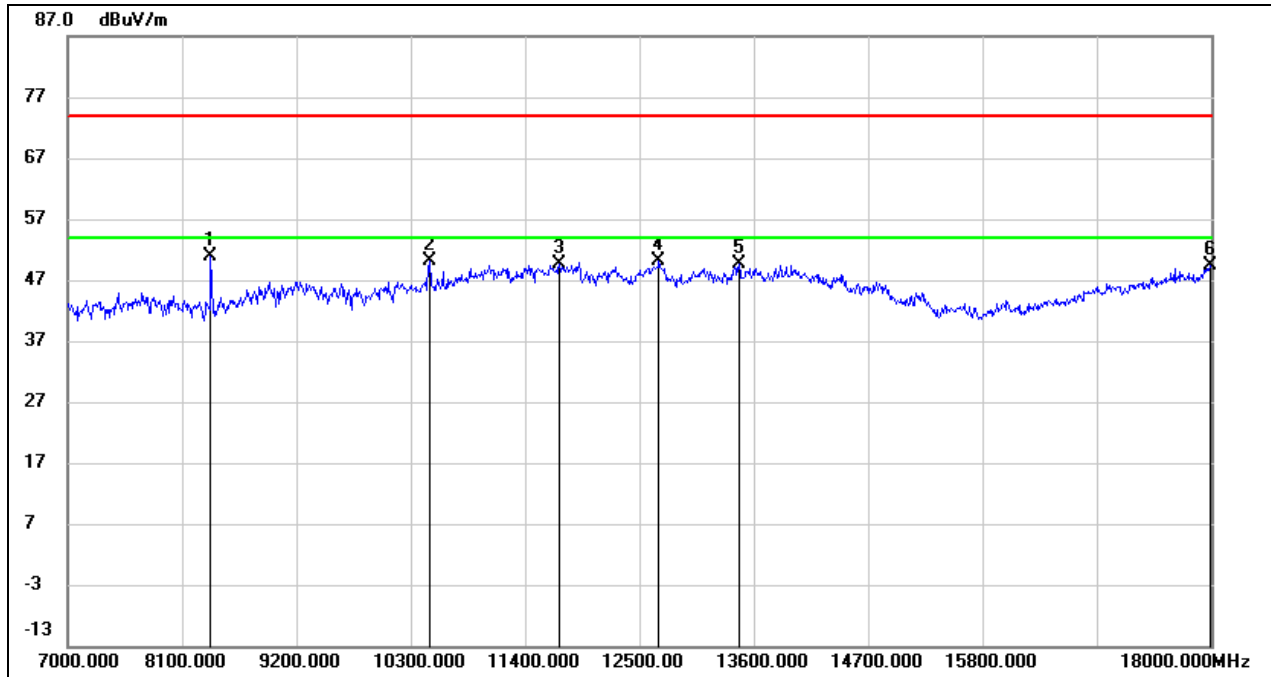

No.	Frequency (MHz)	Reading (dBuV)	Correct (dB/m)	Result (dBuV/m)	Limit (dBuV/m)	Margin (dB)	Remark
1	8375.000	44.11	6.77	50.88	74.00	-23.12	peak
2	10487.000	37.35	12.79	50.14	74.00	-23.86	peak
3	11730.000	32.47	17.19	49.66	74.00	-24.34	peak
4	12687.000	32.06	18.05	50.11	74.00	-23.89	peak
5	13457.000	29.28	20.46	49.74	74.00	-24.26	peak
6	17989.000	23.39	26.04	49.43	74.00	-24.57	peak

Test Mode:	802.11ax HE20	Channel:	5745
Polarity:	Horizontal	Test Voltage:	DC 12 V

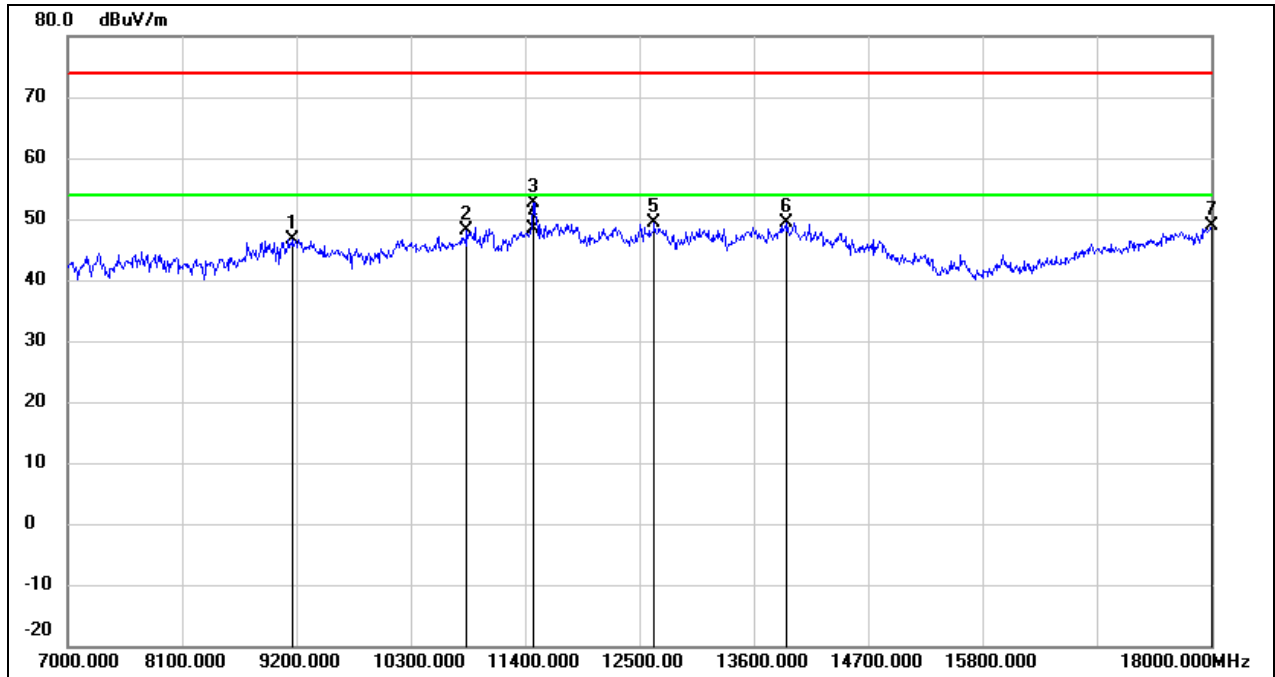

No.	Frequency (MHz)	Reading (dBuV)	Correct (dB/m)	Result (dBuV/m)	Limit (dBuV/m)	Margin (dB)	Remark
1	9167.000	36.28	10.45	46.73	74.00	-27.27	peak
2	10839.000	33.96	14.10	48.06	74.00	-25.94	peak
3	11477.000	35.98	16.67	52.65	74.00	-21.35	peak
4	11477.000	31.63	16.67	48.30	54.00	-5.70	AVG
5	12643.000	31.27	18.01	49.28	74.00	-24.72	peak
6	13919.000	27.72	21.68	49.40	74.00	-24.60	peak
7	18000.000	22.86	26.12	48.98	74.00	-25.02	peak

Test Mode:	802.11ax HE20	Channel:	5745
Polarity:	Vertical	Test Voltage:	DC 12 V

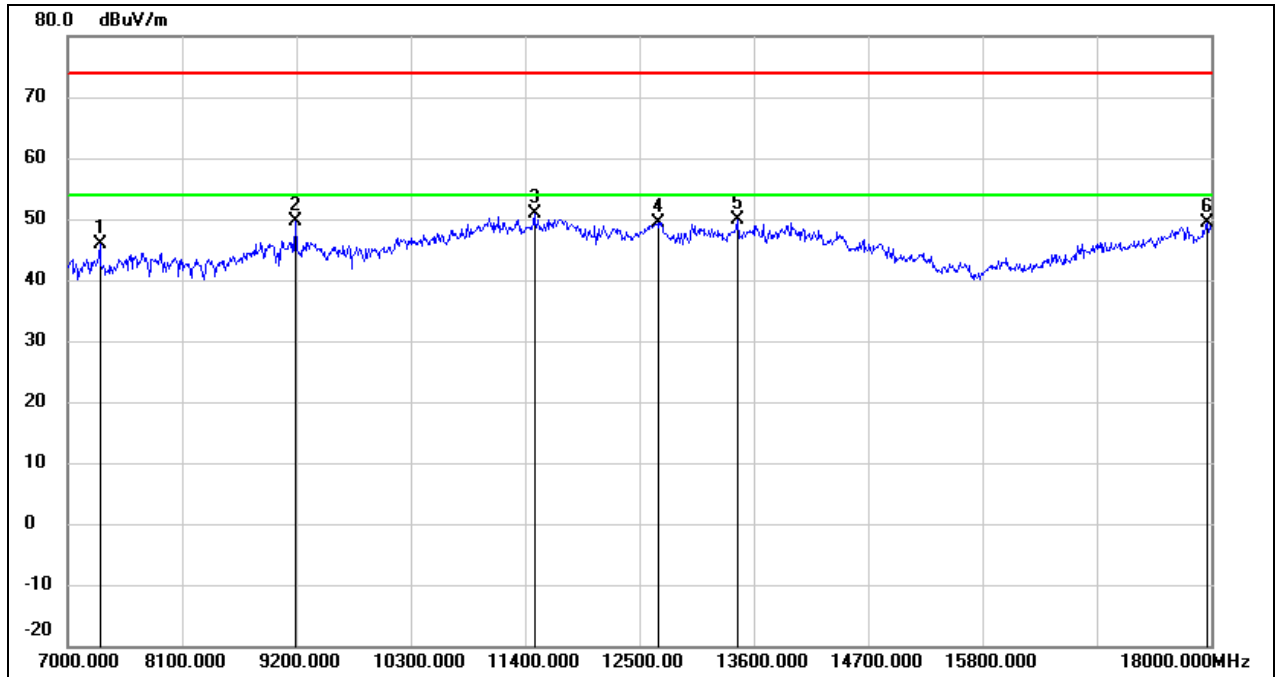

No.	Frequency (MHz)	Reading (dBuV)	Correct (dB/m)	Result (dBuV/m)	Limit (dBuV/m)	Margin (dB)	Remark
1	7308.000	38.96	6.94	45.90	74.00	-28.10	peak
2	9189.000	39.21	10.46	49.67	74.00	-24.33	peak
3	11488.000	34.08	16.72	50.80	74.00	-23.20	peak
4	12676.000	31.34	18.05	49.39	74.00	-24.61	peak
5	13446.000	29.36	20.41	49.77	74.00	-24.23	peak
6	17967.000	23.52	25.89	49.41	74.00	-24.59	peak

Test Mode:	802.11ax HE20	Channel:	5785
Polarity:	Horizontal	Test Voltage:	DC 12 V

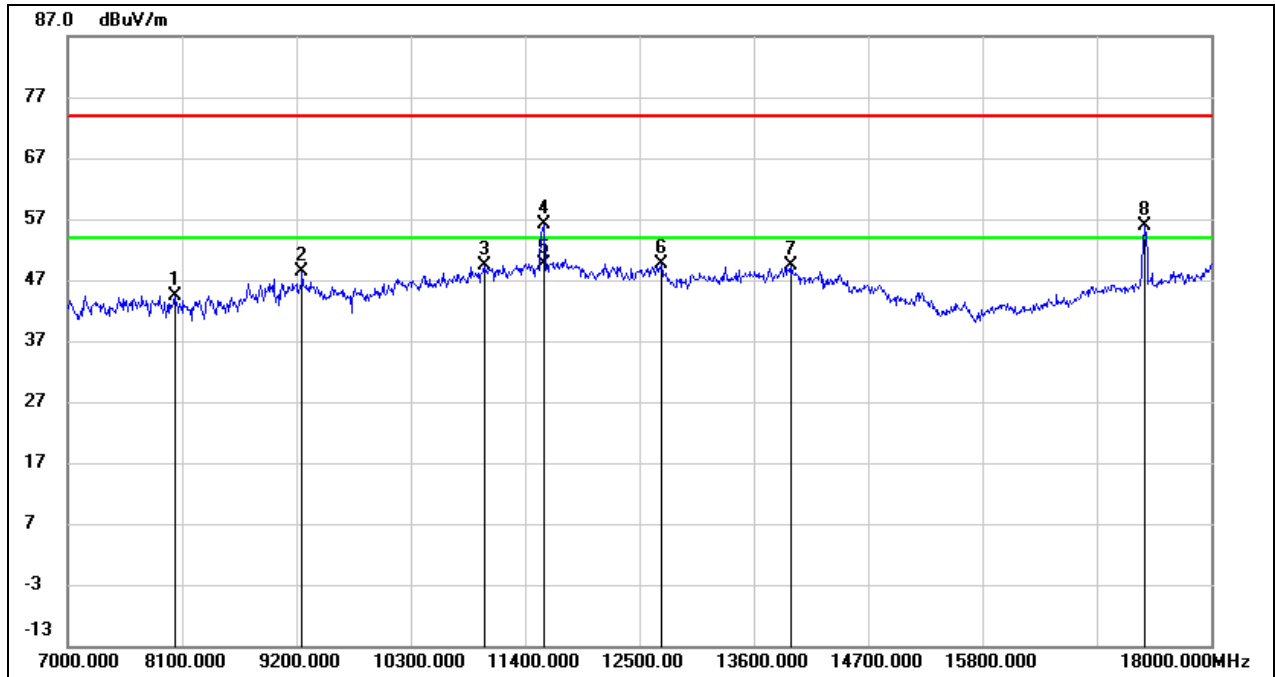

No.	Frequency (MHz)	Reading (dBuV)	Correct (dB/m)	Result (dBuV/m)	Limit (dBuV/m)	Margin (dB)	Remark
1	8034.000	38.02	6.47	44.49	74.00	-29.51	peak
2	9255.000	37.99	10.51	48.50	74.00	-25.50	peak
3	11004.000	34.52	14.74	49.26	74.00	-24.74	peak
4	11576.000	39.19	16.91	56.10	74.00	-17.90	peak
5	11576.000	32.69	16.91	49.60	54.00	-4.40	AVG
6	12709.000	31.42	18.09	49.51	74.00	-24.49	peak
7	13963.000	27.58	21.78	49.36	74.00	-24.64	peak
8	17362.000	33.69	22.12	55.81	74.00	-18.19	peak

Test Mode:	802.11ax HE20	Channel:	5785
Polarity:	Vertical	Test Voltage:	DC 12 V

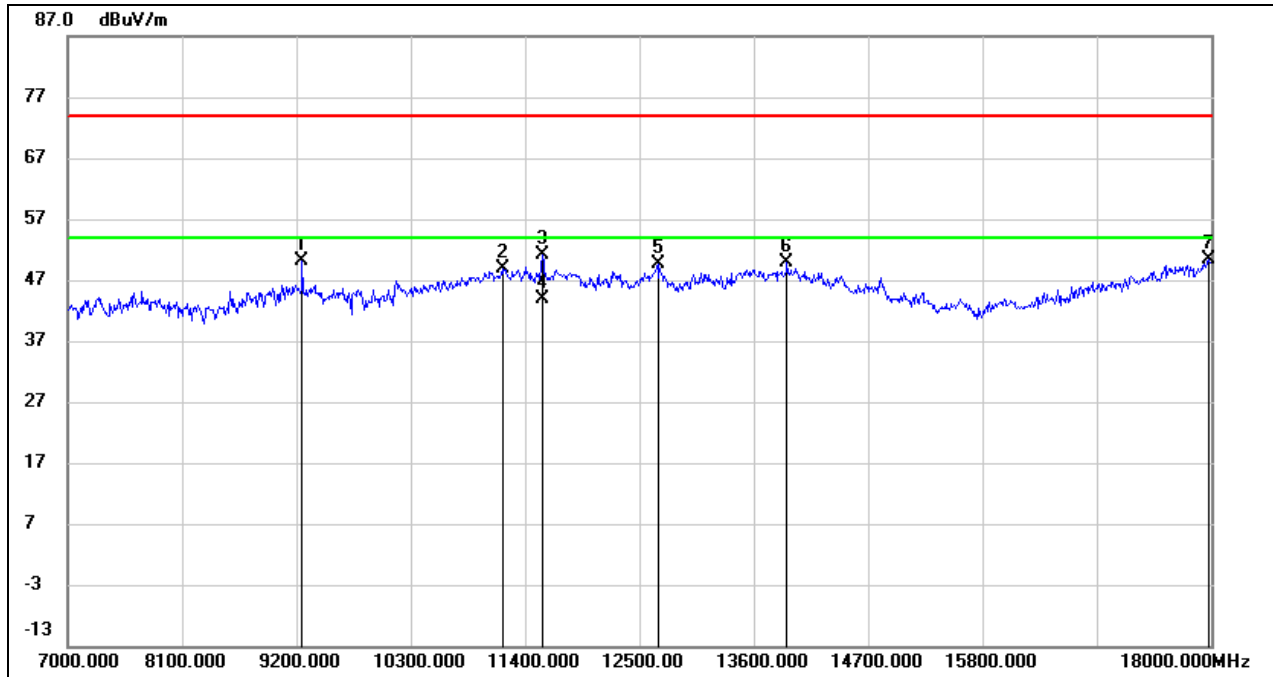

No.	Frequency (MHz)	Reading (dBuV)	Correct (dB/m)	Result (dBuV/m)	Limit (dBuV/m)	Margin (dB)	Remark
1	9255.000	39.73	10.50	50.23	74.00	-23.77	peak
2	11180.000	33.46	15.46	48.92	74.00	-25.08	peak
3	11565.000	34.24	16.89	51.13	74.00	-22.87	peak
4	11565.000	26.91	16.89	43.80	54.00	-10.20	AVG
5	12676.000	31.68	18.05	49.73	74.00	-24.27	peak
6	13919.000	28.09	21.68	49.77	74.00	-24.23	peak
7	17978.000	24.37	25.97	50.34	74.00	-23.66	peak

Test Mode:	802.11ax HE20	Channel:	5825
Polarity:	Horizontal	Test Voltage:	DC 12 V

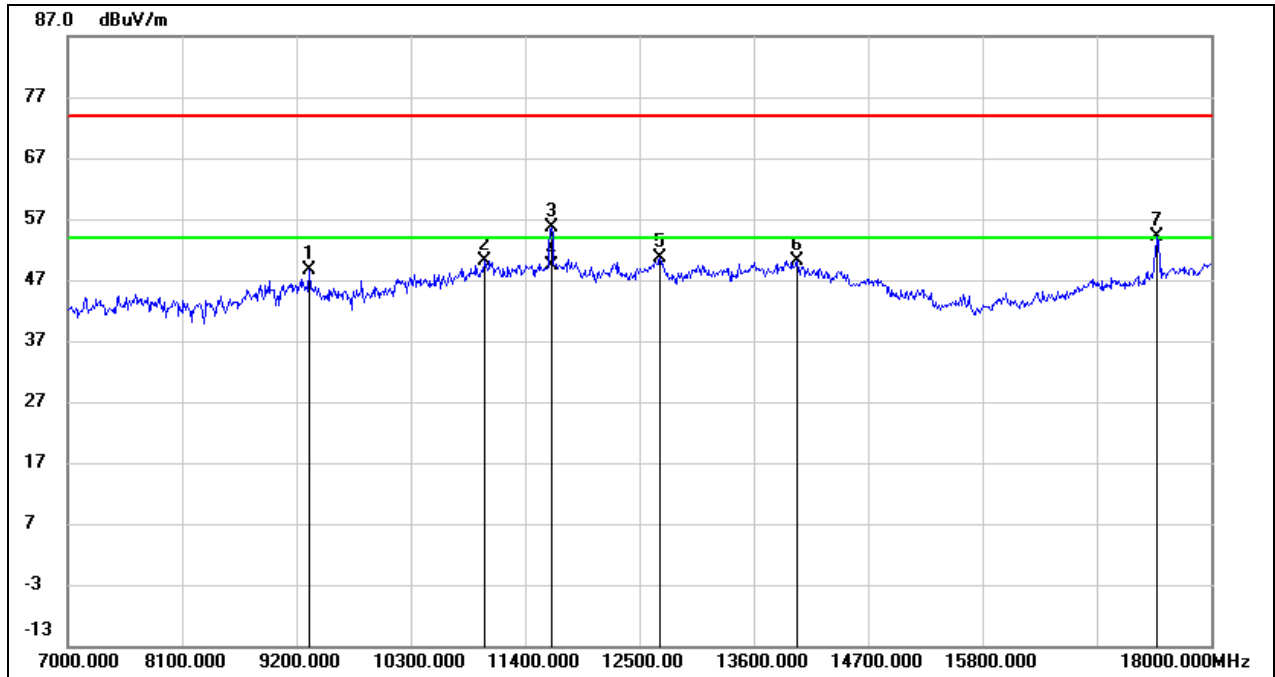

No.	Frequency (MHz)	Reading (dBuV)	Correct (dB/m)	Result (dBuV/m)	Limit (dBuV/m)	Margin (dB)	Remark
1	9321.000	38.01	10.53	48.54	74.00	-25.46	peak
2	11015.000	35.36	14.79	50.15	74.00	-23.85	peak
3	11653.000	38.53	17.05	55.58	74.00	-18.42	peak
4	11653.000	32.45	17.05	49.50	54.00	-4.50	AVG
5	12698.000	32.64	18.08	50.72	74.00	-23.28	peak
6	14018.000	28.22	21.80	50.02	74.00	-23.98	peak
7	17483.000	31.45	22.62	54.07	74.00	-19.93	peak

Test Mode:	802.11ax HE20	Channel:	5825
Polarity:	Vertical	Test Voltage:	DC 12 V

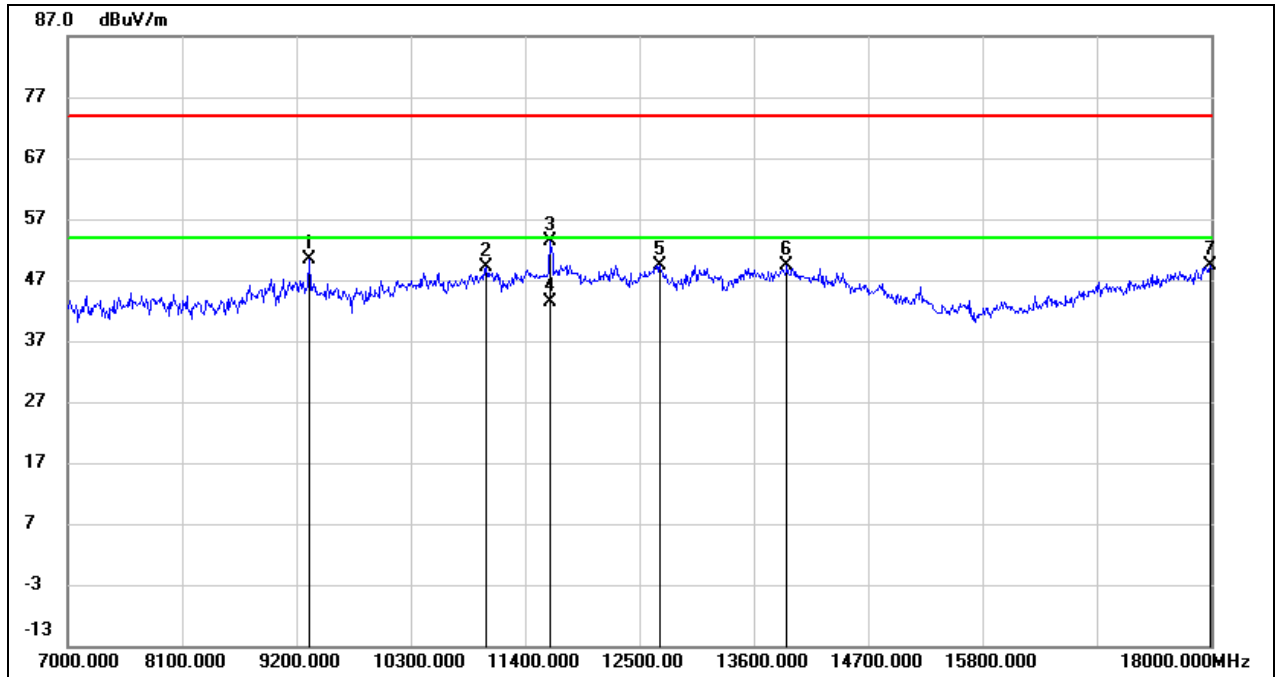

No.	Frequency (MHz)	Reading (dBuV)	Correct (dB/m)	Result (dBuV/m)	Limit (dBuV/m)	Margin (dB)	Remark
1	9321.000	39.84	10.53	50.37	74.00	-23.63	peak
2	11026.000	34.22	14.82	49.04	74.00	-24.96	peak
3	11642.000	36.24	17.03	53.27	74.00	-20.73	peak
4	11642.000	26.47	17.03	43.50	54.00	-10.50	AVG
5	12698.000	31.41	18.08	49.49	74.00	-24.51	peak
6	13919.000	27.76	21.68	49.44	74.00	-24.56	peak
7	17989.000	23.40	26.04	49.44	74.00	-24.56	peak



Test Mode:	802.11ax HE40	Channel:	5190
Polarity:	Horizontal	Test Voltage:	DC 12 V

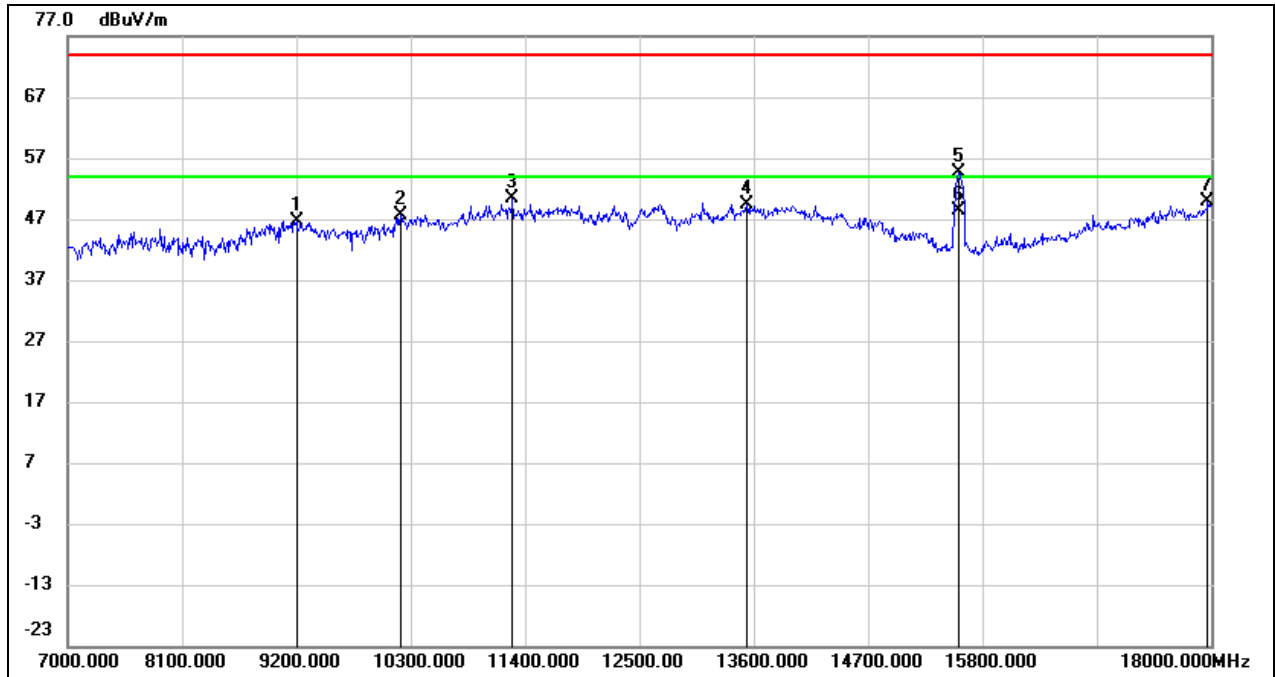

No.	Frequency (MHz)	Reading (dBuV)	Correct (dB/m)	Result (dBuV/m)	Limit (dBuV/m)	Margin (dB)	Remark
1	9200.000	36.20	10.46	46.66	74.00	-27.34	peak
2	10201.000	35.47	12.19	47.66	74.00	-26.34	peak
3	11279.000	34.48	15.86	50.34	74.00	-23.66	peak
4	13534.000	28.74	20.73	49.47	74.00	-24.53	peak
5	15569.000	37.88	16.74	54.62	74.00	-19.38	peak
6	15569.000	31.66	16.74	48.40	54.00	-5.60	AVG
7	17967.000	23.99	25.89	49.88	74.00	-24.12	peak

Test Mode:	802.11ax HE40	Channel:	5190
Polarity:	Vertical	Test Voltage:	DC 12 V

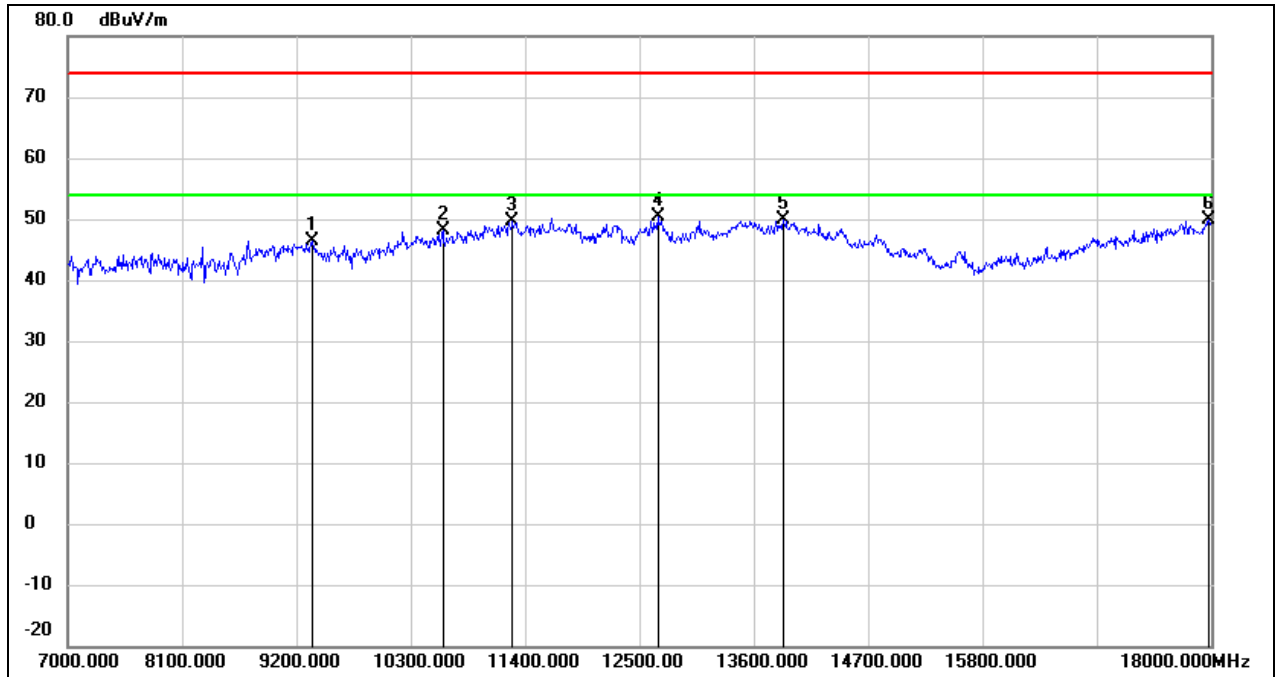

No.	Frequency (MHz)	Reading (dBuV)	Correct (dB/m)	Result (dBuV/m)	Limit (dBuV/m)	Margin (dB)	Remark
1	9354.000	35.81	10.56	46.37	74.00	-27.63	peak
2	10608.000	34.81	13.23	48.04	74.00	-25.96	peak
3	11279.000	33.74	15.86	49.60	74.00	-24.40	peak
4	12676.000	32.24	18.05	50.29	74.00	-23.71	peak
5	13886.000	28.17	21.60	49.77	74.00	-24.23	peak
6	17978.000	23.86	25.97	49.83	74.00	-24.17	peak

Test Mode:	802.11ax HE40	Channel:	5230
Polarity:	Horizontal	Test Voltage:	DC 12 V

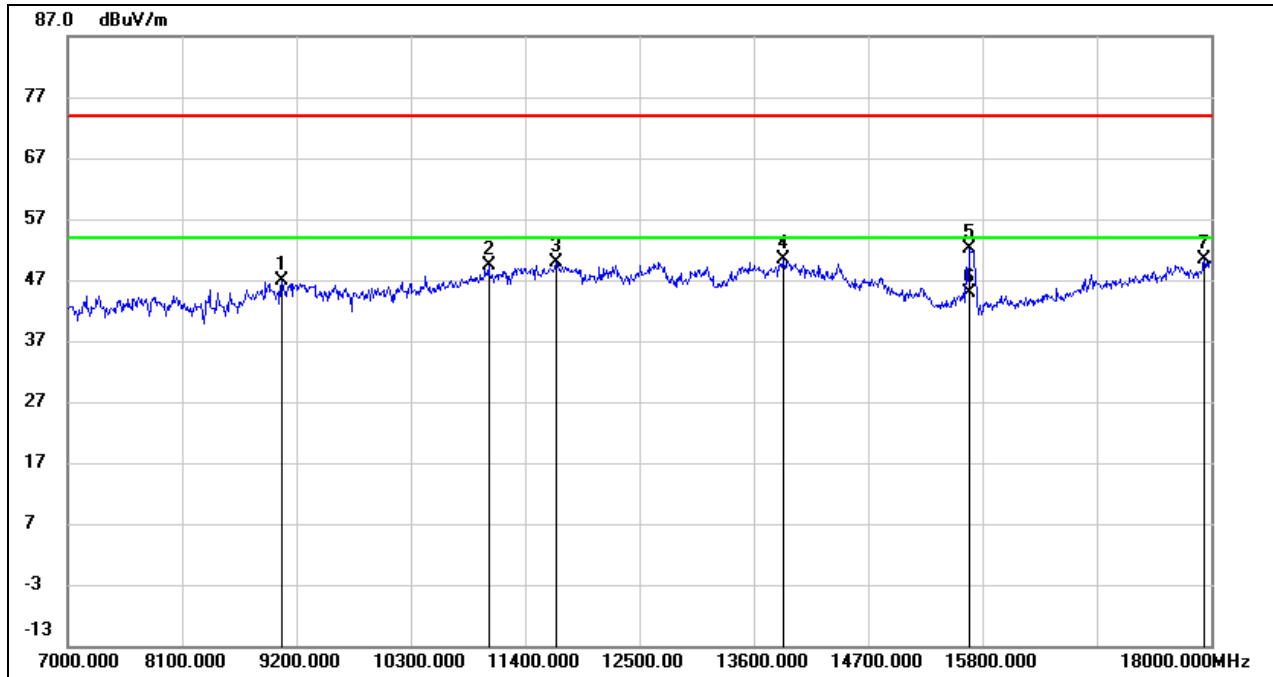

No.	Frequency (MHz)	Reading (dBuV)	Correct (dB/m)	Result (dBuV/m)	Limit (dBuV/m)	Margin (dB)	Remark
1	9057.000	36.45	10.38	46.83	74.00	-27.17	peak
2	11048.000	34.37	14.91	49.28	74.00	-24.72	peak
3	11697.000	32.69	17.13	49.82	74.00	-24.18	peak
4	13886.000	28.72	21.60	50.32	74.00	-23.68	peak
5	15679.000	35.43	16.79	52.22	74.00	-21.78	peak
6	15679.000	28.11	16.79	44.90	54.00	-9.10	AVG
7	17934.000	24.73	25.67	50.40	74.00	-23.60	peak

Test Mode:	802.11ax HE40	Channel:	5230
Polarity:	Vertical	Test Voltage:	DC 12 V

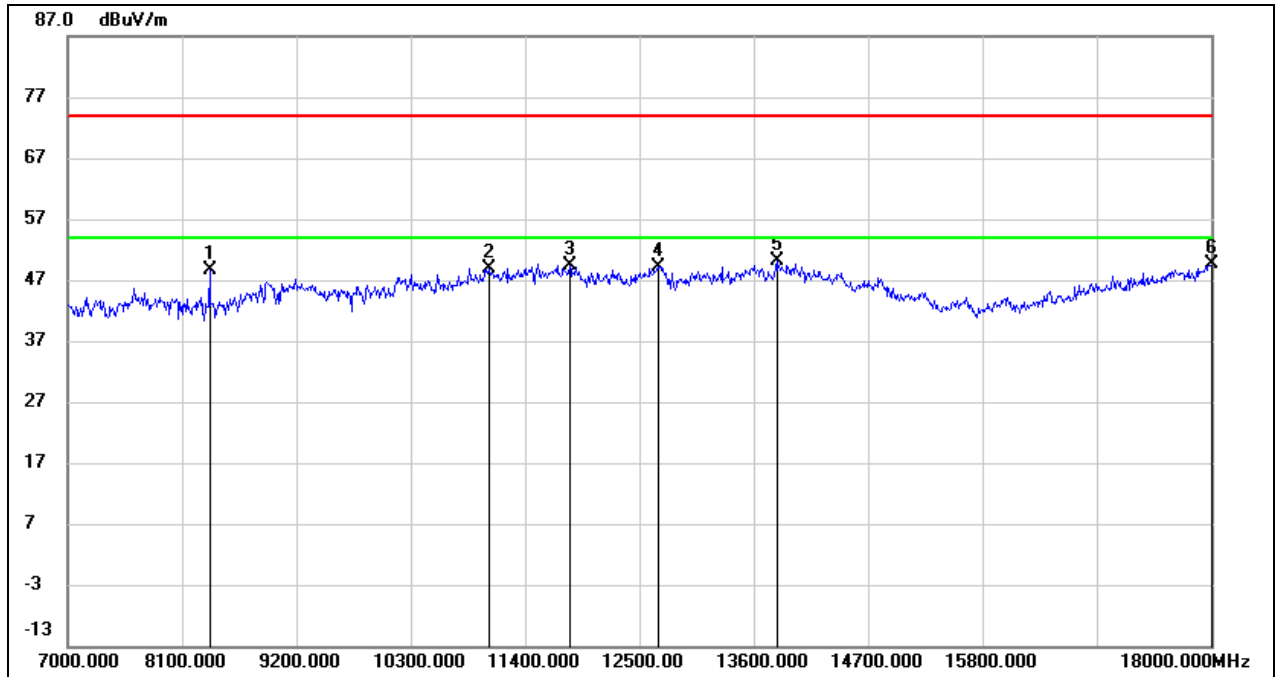

No.	Frequency (MHz)	Reading (dBuV)	Correct (dB/m)	Result (dBuV/m)	Limit (dBuV/m)	Margin (dB)	Remark
1	8364.000	41.85	6.76	48.61	74.00	-25.39	peak
2	11059.000	33.93	14.96	48.89	74.00	-25.11	peak
3	11829.000	31.93	17.38	49.31	74.00	-24.69	peak
4	12676.000	31.17	18.05	49.22	74.00	-24.78	peak
5	13820.000	28.64	21.43	50.07	74.00	-23.93	peak
6	18000.000	23.62	26.12	49.74	74.00	-24.26	peak

Test Mode:	802.11ax HE40	Channel:	5755
Polarity:	Horizontal	Test Voltage:	DC 12 V

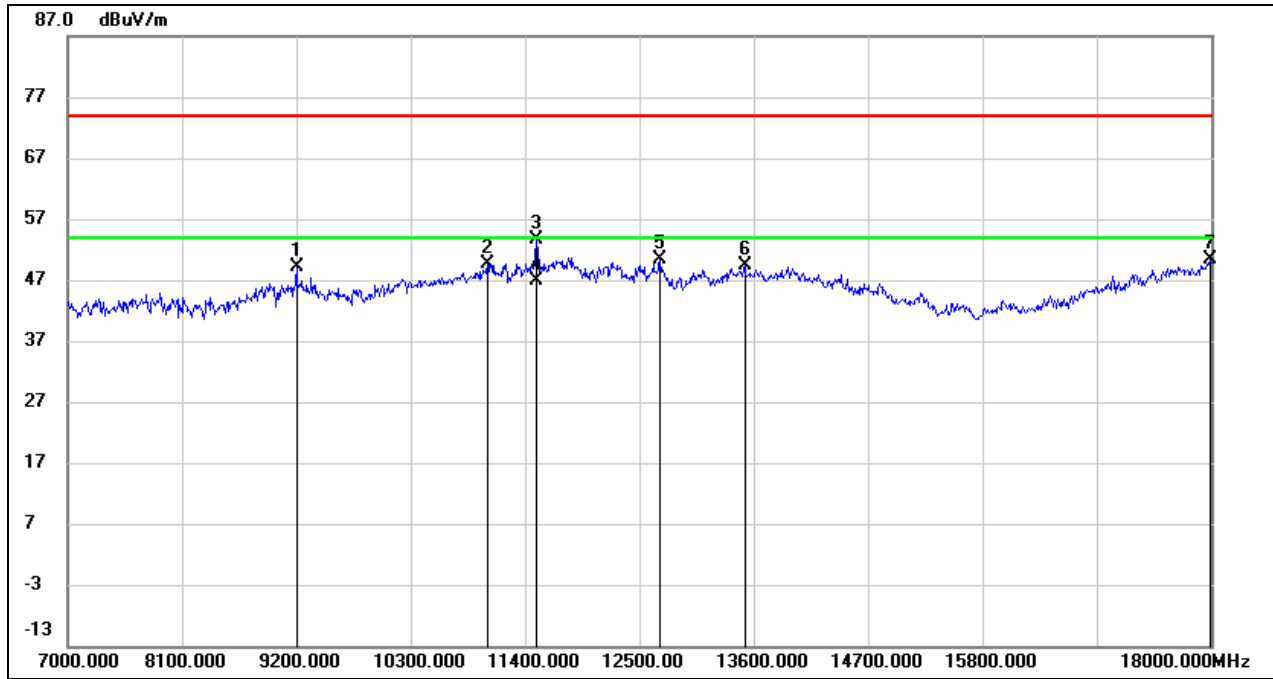

No.	Frequency (MHz)	Reading (dBuV)	Correct (dB/m)	Result (dBuV/m)	Limit (dBuV/m)	Margin (dB)	Remark
1	9200.000	38.56	10.46	49.02	74.00	-24.98	peak
2	11037.000	34.82	14.87	49.69	74.00	-24.31	peak
3	11510.000	36.96	16.79	53.75	74.00	-20.25	peak
4	11510.000	30.01	16.79	46.80	54.00	-7.20	AVG
5	12698.000	32.34	18.08	50.42	74.00	-23.58	peak
6	13512.000	28.67	20.68	49.35	74.00	-24.65	peak
7	17989.000	24.34	26.04	50.38	74.00	-23.62	peak

Test Mode:	802.11ax HE40	Channel:	5755
Polarity:	Vertical	Test Voltage:	DC 12 V

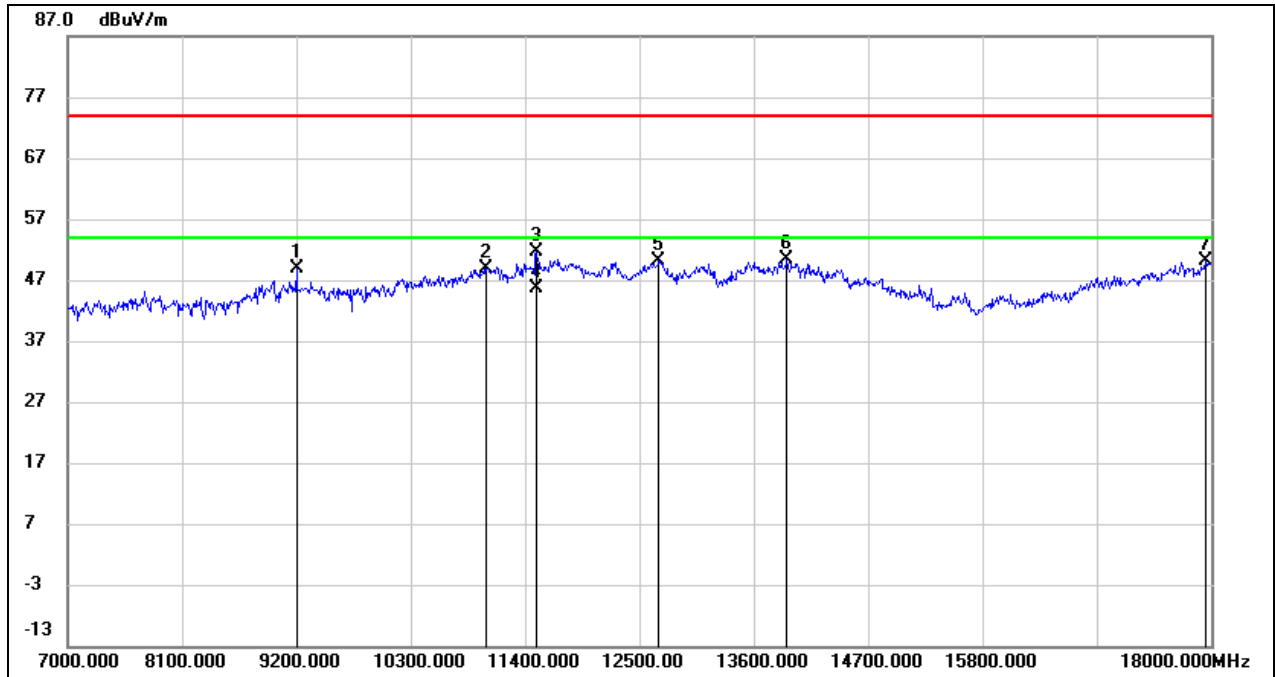

No.	Frequency (MHz)	Reading (dBuV)	Correct (dB/m)	Result (dBuV/m)	Limit (dBuV/m)	Margin (dB)	Remark
1	9200.000	38.48	10.46	48.94	74.00	-25.06	peak
2	11026.000	34.17	14.82	48.99	74.00	-25.01	peak
3	11510.000	34.76	16.79	51.55	74.00	-22.45	peak
4	11510.000	28.91	16.79	45.70	54.00	-8.30	AVG
5	12687.000	32.02	18.05	50.07	74.00	-23.93	peak
6	13919.000	28.71	21.68	50.39	74.00	-23.61	peak
7	17945.000	24.34	25.75	50.09	74.00	-23.91	peak

Test Mode:	802.11ax HE40	Channel:	5795
Polarity:	Horizontal	Test Voltage:	DC 12 V

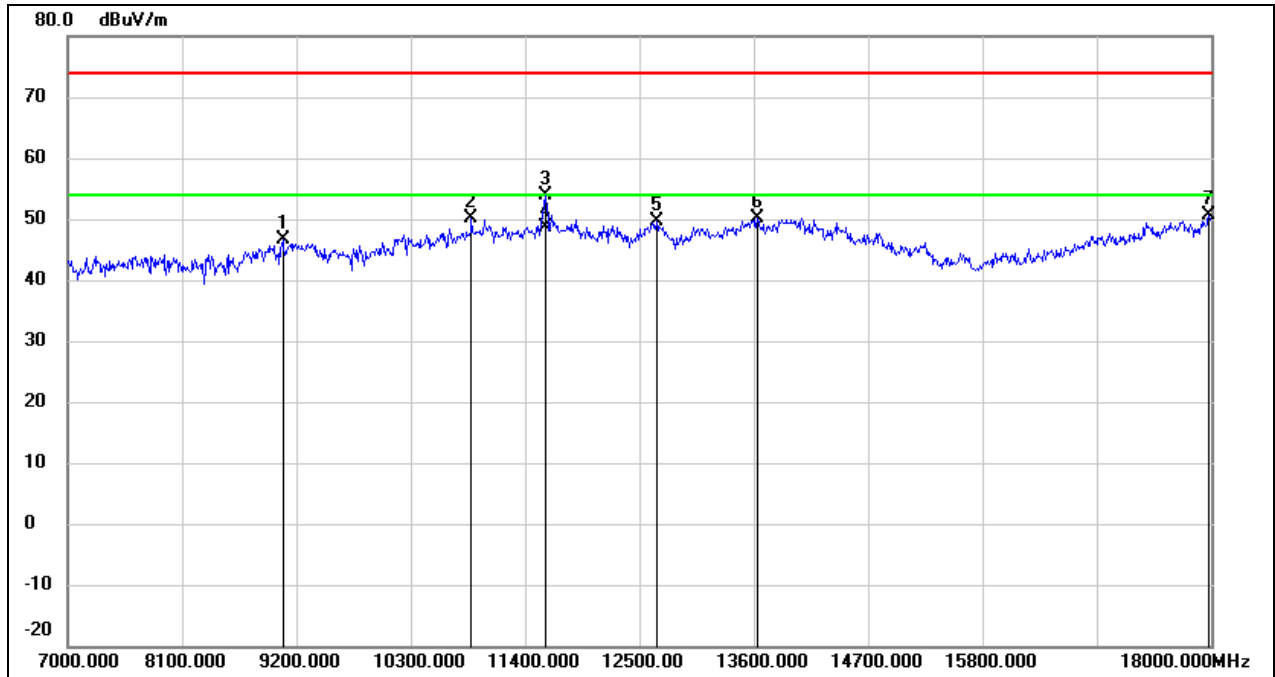

No.	Frequency (MHz)	Reading (dBuV)	Correct (dB/m)	Result (dBuV/m)	Limit (dBuV/m)	Margin (dB)	Remark
1	9068.000	36.15	10.39	46.54	74.00	-27.46	peak
2	10883.000	35.78	14.27	50.05	74.00	-23.95	peak
3	11598.000	36.92	16.96	53.88	74.00	-20.12	peak
4	11598.000	31.64	16.96	48.60	54.00	-5.40	AVG
5	12665.000	31.62	18.04	49.66	74.00	-24.34	peak
6	13633.000	29.20	20.97	50.17	74.00	-23.83	peak
7	17978.000	24.54	25.97	50.51	74.00	-23.49	peak

Test Mode:	802.11ax HE40	Channel:	5795
Polarity:	Vertical	Test Voltage:	DC 12 V

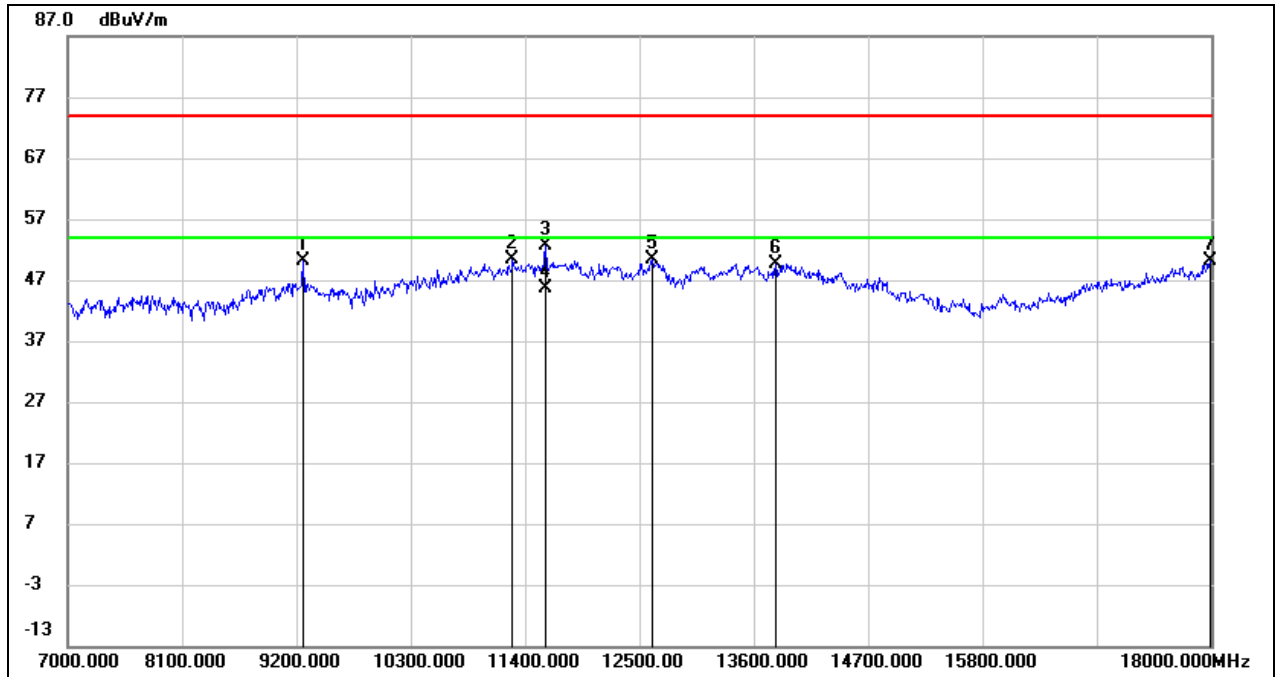

No.	Frequency (MHz)	Reading (dBuV)	Correct (dB/m)	Result (dBuV/m)	Limit (dBuV/m)	Margin (dB)	Remark
1	9266.000	39.69	10.51	50.20	74.00	-23.80	peak
2	11279.000	34.54	15.86	50.40	74.00	-23.60	peak
3	11598.000	35.56	16.96	52.52	74.00	-21.48	peak
4	11598.000	28.64	16.96	45.60	54.00	-8.40	AVG
5	12621.000	32.28	17.98	50.26	74.00	-23.74	peak
6	13809.000	28.32	21.41	49.73	74.00	-24.27	peak
7	17989.000	23.97	26.04	50.01	74.00	-23.99	peak



Test Mode:	802.11ax HE80	Channel:	5210
Polarity:	Horizontal	Test Voltage:	DC 12 V

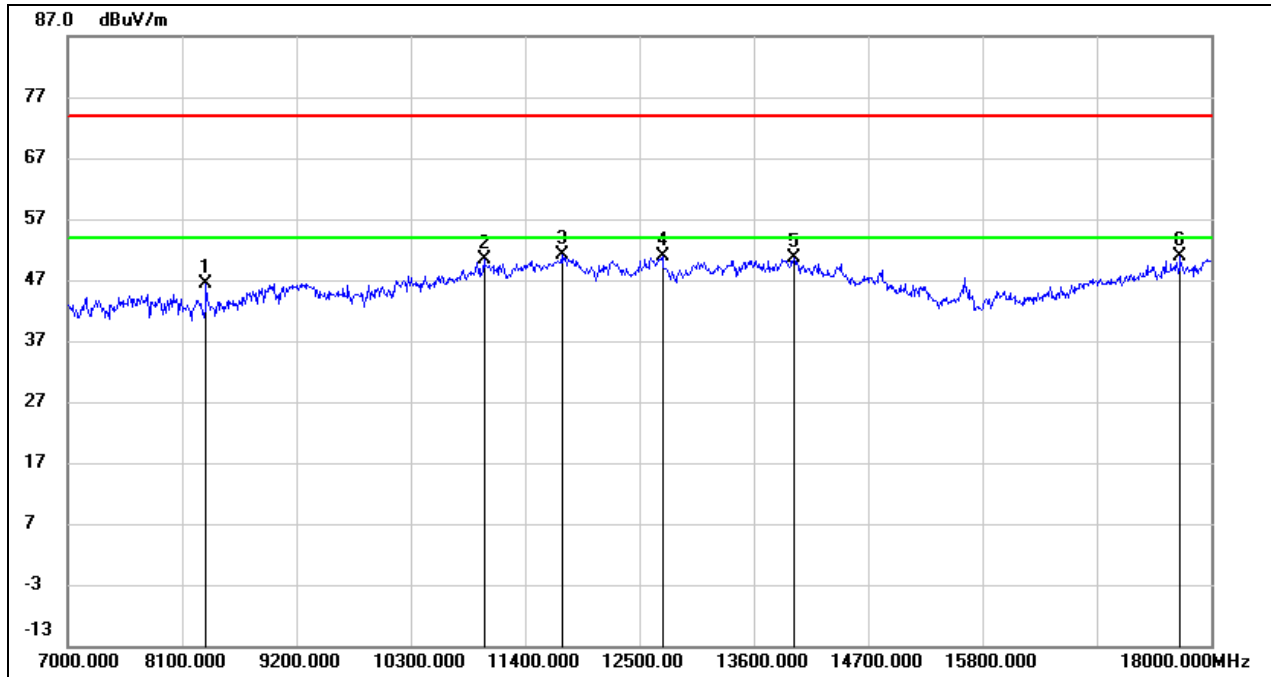

No.	Frequency (MHz)	Reading (dBuV)	Correct (dB/m)	Result (dBuV/m)	Limit (dBuV/m)	Margin (dB)	Remark
1	8331.000	39.75	6.73	46.48	74.00	-27.52	peak
2	11004.000	35.64	14.74	50.38	74.00	-23.62	peak
3	11752.000	33.77	17.24	51.01	74.00	-22.99	peak
4	12720.000	32.90	18.09	50.99	74.00	-23.01	peak
5	13985.000	28.88	21.85	50.73	74.00	-23.27	peak
6	17703.000	26.71	24.09	50.80	74.00	-23.20	peak

Test Mode:	802.11ax HE80	Channel:	5210
Polarity:	Vertical	Test Voltage:	DC 12 V

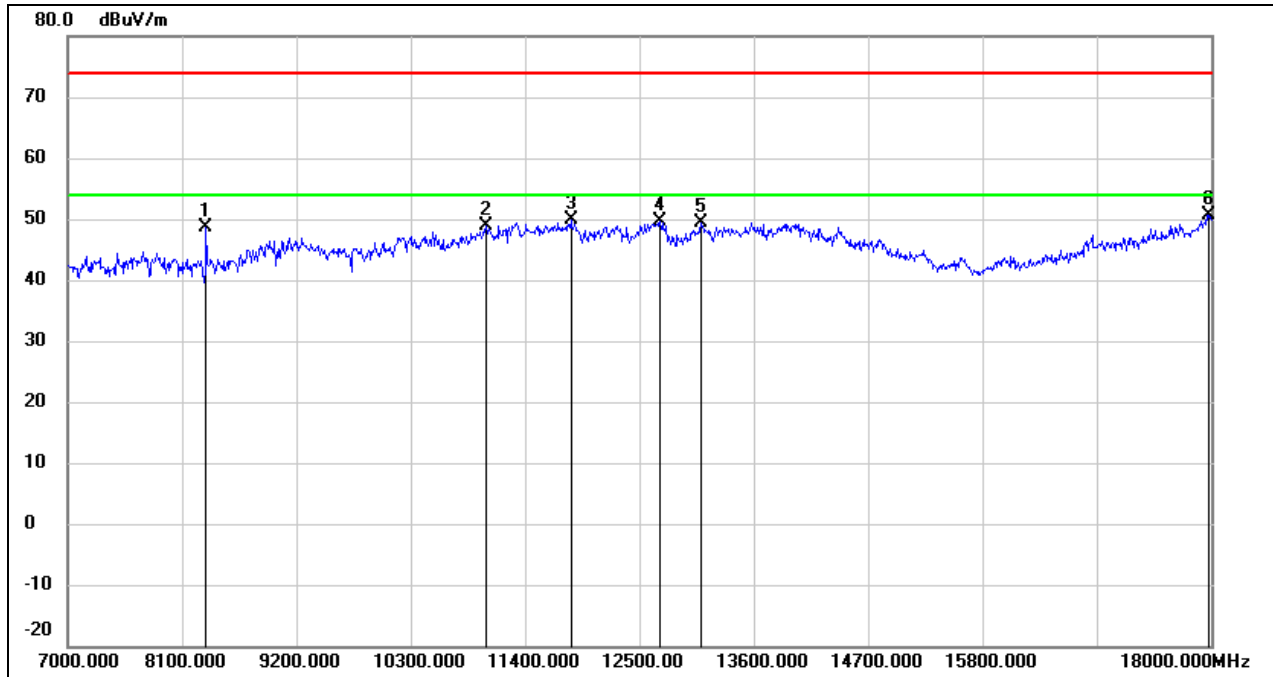

No.	Frequency (MHz)	Reading (dBuV)	Correct (dB/m)	Result (dBuV/m)	Limit (dBuV/m)	Margin (dB)	Remark
1	8331.000	41.86	6.73	48.59	74.00	-25.41	peak
2	11026.000	34.13	14.82	48.95	74.00	-25.05	peak
3	11840.000	32.42	17.40	49.82	74.00	-24.18	peak
4	12698.000	31.62	18.08	49.70	74.00	-24.30	peak
5	13094.000	30.45	18.87	49.32	74.00	-24.68	peak
6	17978.000	24.67	25.97	50.64	74.00	-23.36	peak

Test Mode:	802.11ax HE80	Channel:	5775
Polarity:	Horizontal	Test Voltage:	DC 12 V

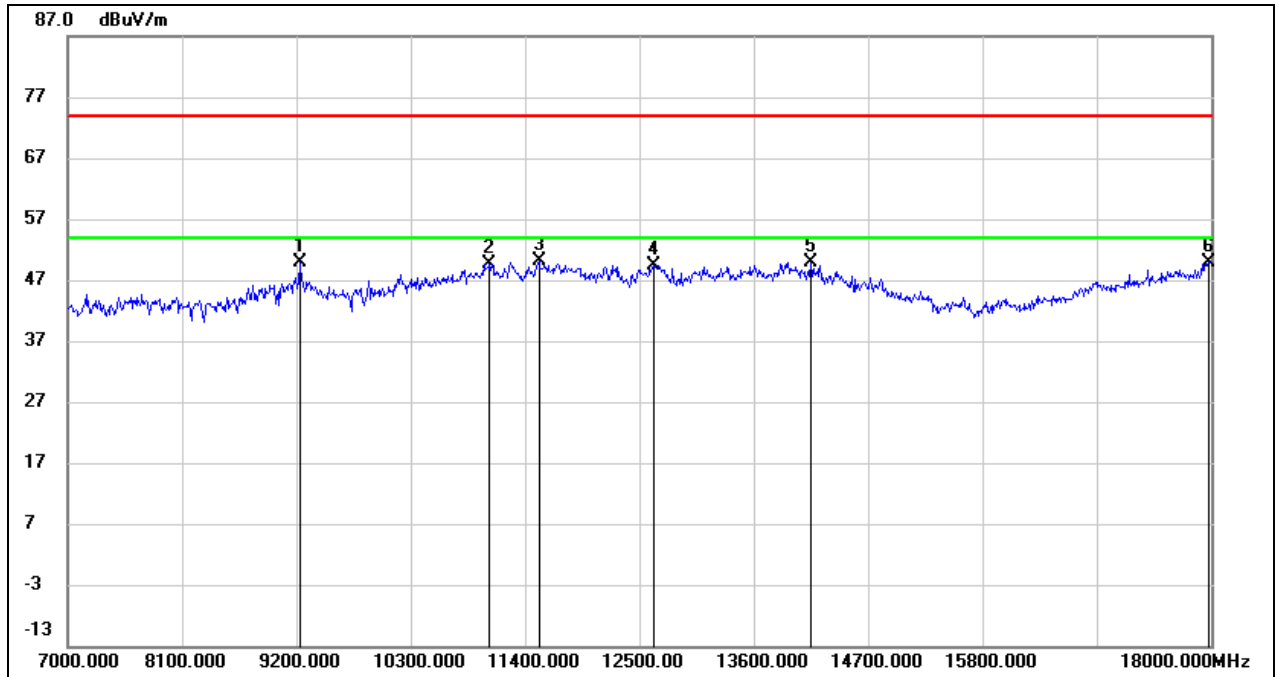

No.	Frequency (MHz)	Reading (dBuV)	Correct (dB/m)	Result (dBuV/m)	Limit (dBuV/m)	Margin (dB)	Remark
1	9233.000	39.48	10.48	49.96	74.00	-24.04	peak
2	11059.000	34.74	14.96	49.70	74.00	-24.30	peak
3	11532.000	33.28	16.83	50.11	74.00	-23.89	peak
4	12632.000	31.35	17.99	49.34	74.00	-24.66	peak
5	14150.000	28.59	21.25	49.84	74.00	-24.16	peak
6	17978.000	23.93	25.97	49.90	74.00	-24.10	peak

Test Mode:	802.11ax HE80	Channel:	5775
Polarity:	Vertical	Test Voltage:	DC 12 V

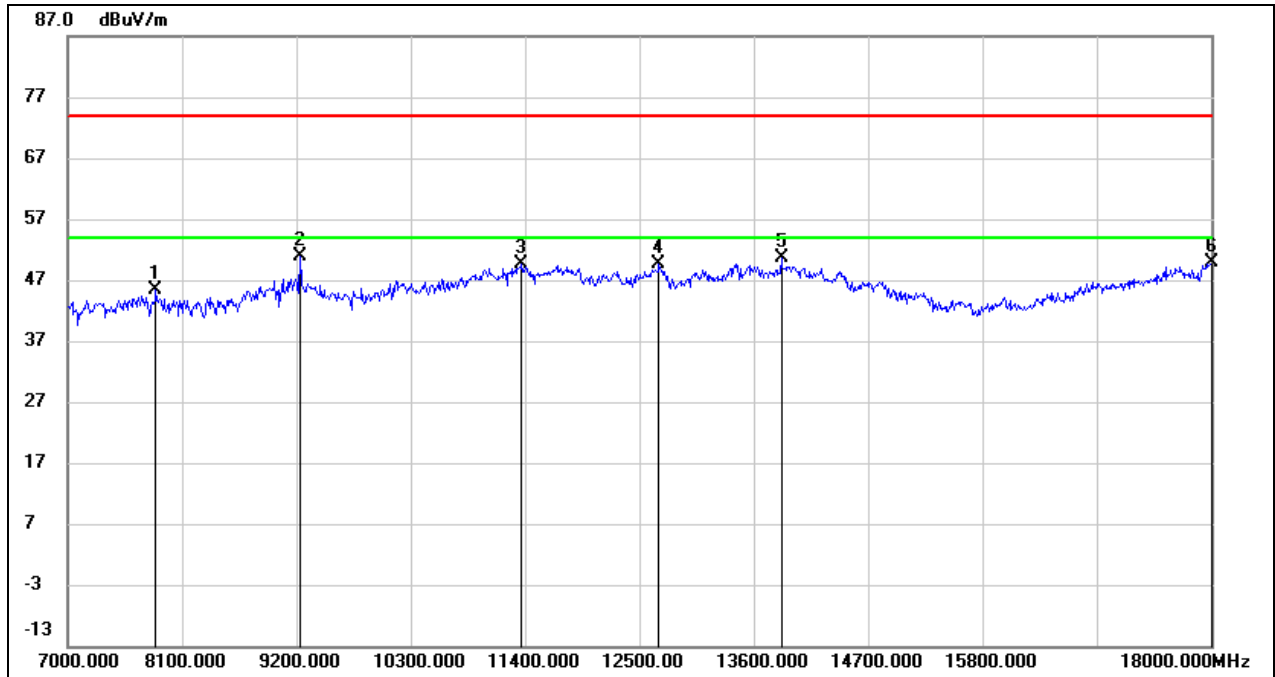

No.	Frequency (MHz)	Reading (dBuV)	Correct (dB/m)	Result (dBuV/m)	Limit (dBuV/m)	Margin (dB)	Remark
1	7847.000	38.70	6.57	45.27	74.00	-28.73	peak
2	9233.000	40.46	10.48	50.94	74.00	-23.06	peak
3	11367.000	33.46	16.22	49.68	74.00	-24.32	peak
4	12687.000	31.56	18.05	49.61	74.00	-24.39	peak
5	13864.000	29.14	21.53	50.67	74.00	-23.33	peak
6	18000.000	23.67	26.12	49.79	74.00	-24.21	peak

Test Mode:	802.11be EHT20	Channel:	5180
Polarity:	Horizontal	Test Voltage:	DC 12 V

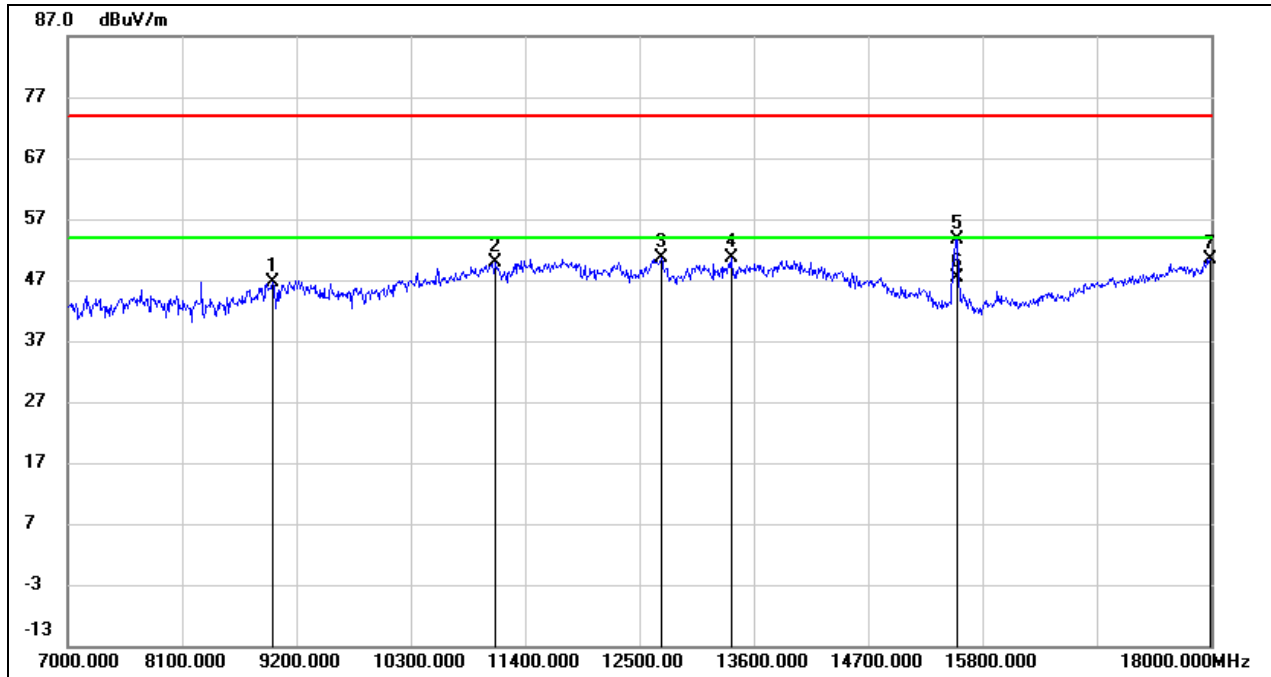

No.	Frequency (MHz)	Reading (dBuV)	Correct (dB/m)	Result (dBuV/m)	Limit (dBuV/m)	Margin (dB)	Remark
1	8969.000	36.55	10.13	46.68	74.00	-27.32	peak
2	11114.000	34.62	15.19	49.81	74.00	-24.19	peak
3	12709.000	32.55	18.09	50.64	74.00	-23.36	peak
4	13380.000	30.42	20.12	50.54	74.00	-23.46	peak
5	15558.000	36.95	16.74	53.69	74.00	-20.31	peak
6	15558.000	30.66	16.74	47.40	54.00	-6.60	AVG
7	17989.000	24.36	26.04	50.40	74.00	-23.60	peak

Test Mode:	802.11be EHT20	Channel:	5180
Polarity:	Vertical	Test Voltage:	DC 12 V

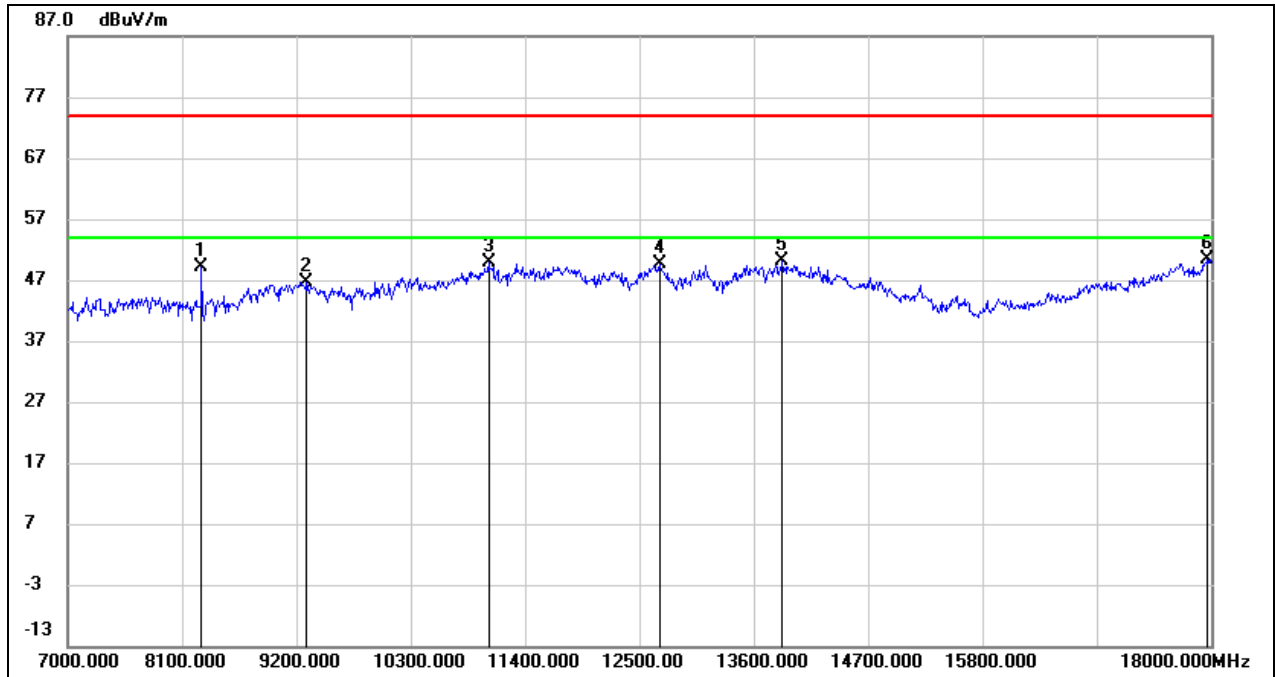

No.	Frequency (MHz)	Reading (dBuV)	Correct (dB/m)	Result (dBuV/m)	Limit (dBuV/m)	Margin (dB)	Remark
1	8287.000	42.37	6.70	49.07	74.00	-24.93	peak
2	9299.000	36.13	10.53	46.66	74.00	-27.34	peak
3	11048.000	34.96	14.91	49.87	74.00	-24.13	peak
4	12698.000	31.49	18.08	49.57	74.00	-24.43	peak
5	13875.000	28.44	21.57	50.01	74.00	-23.99	peak
6	17967.000	24.55	25.89	50.44	74.00	-23.56	peak

Test Mode:	802.11be EHT20	Channel:	5200
Polarity:	Horizontal	Test Voltage:	DC 12 V

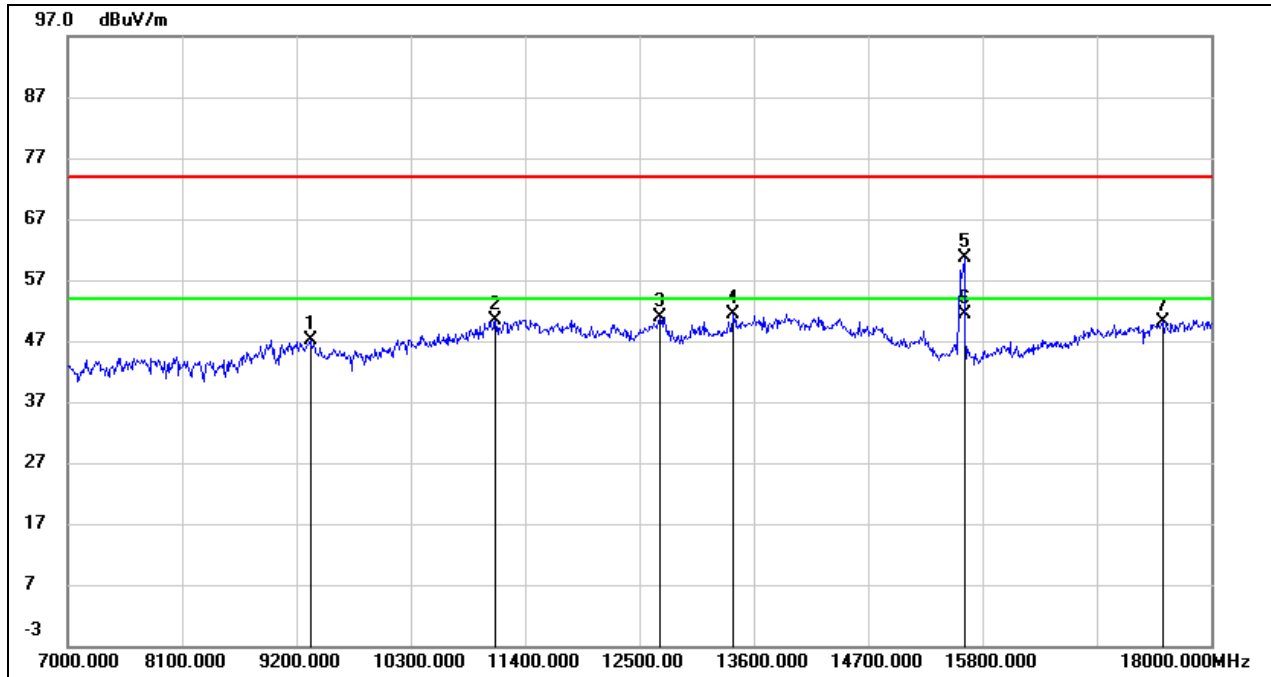

No.	Frequency (MHz)	Reading (dBuV)	Correct (dB/m)	Result (dBuV/m)	Limit (dBuV/m)	Margin (dB)	Remark
1	9332.000	36.61	10.54	47.15	74.00	-26.85	peak
2	11114.000	35.10	15.19	50.29	74.00	-23.71	peak
3	12698.000	32.72	18.08	50.80	74.00	-23.20	peak
4	13402.000	31.11	20.20	51.31	74.00	-22.69	peak
5	15624.000	43.78	16.76	60.54	74.00	-13.46	peak
6	15624.000	34.54	16.76	51.30	54.00	-2.70	AVG
7	17538.000	27.16	22.97	50.13	74.00	-23.87	peak

Test Mode:	802.11be EHT20	Channel:	5200
Polarity:	Vertical	Test Voltage:	DC 12 V

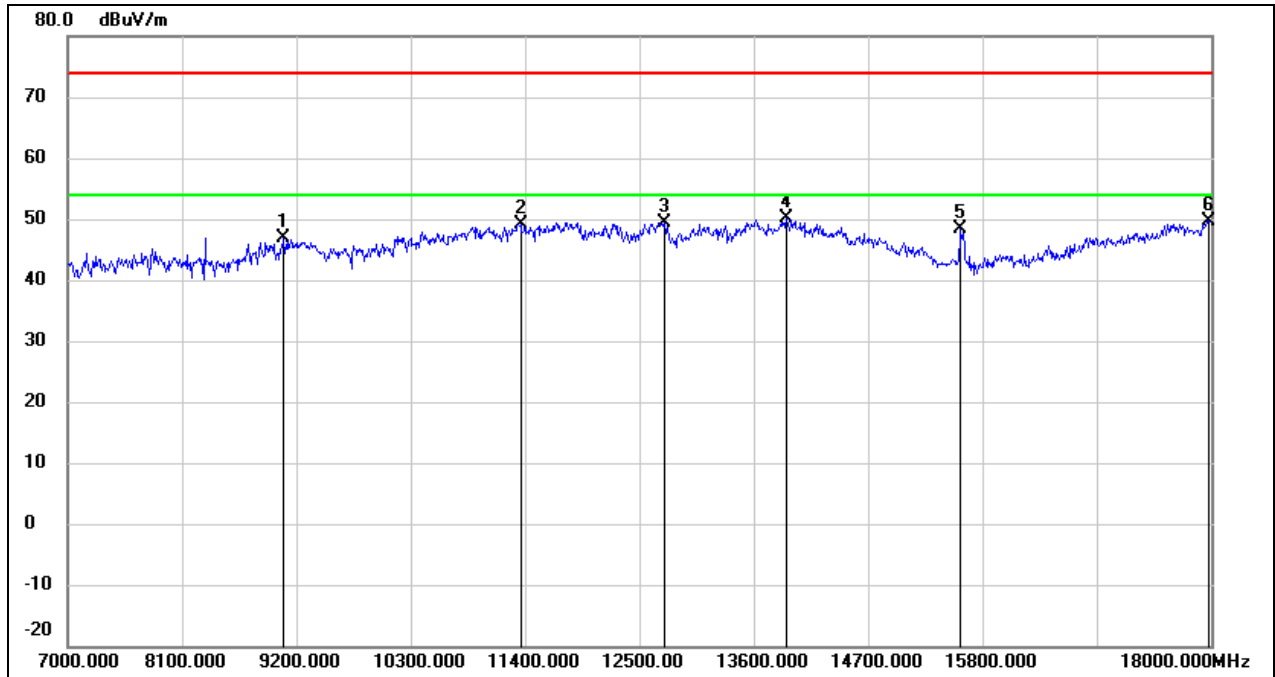

No.	Frequency (MHz)	Reading (dBuV)	Correct (dB/m)	Result (dBuV/m)	Limit (dBuV/m)	Margin (dB)	Remark
1	9079.000	36.51	10.39	46.90	74.00	-27.10	peak
2	11356.000	32.97	16.19	49.16	74.00	-24.84	peak
3	12742.000	31.37	18.13	49.50	74.00	-24.50	peak
4	13908.000	28.50	21.66	50.16	74.00	-23.84	peak
5	15591.000	31.66	16.75	48.41	74.00	-25.59	peak
6	17978.000	23.68	25.97	49.65	74.00	-24.35	peak



Test Mode:	802.11be EHT20	Channel:	5240
Polarity:	Horizontal	Test Voltage:	DC 12 V

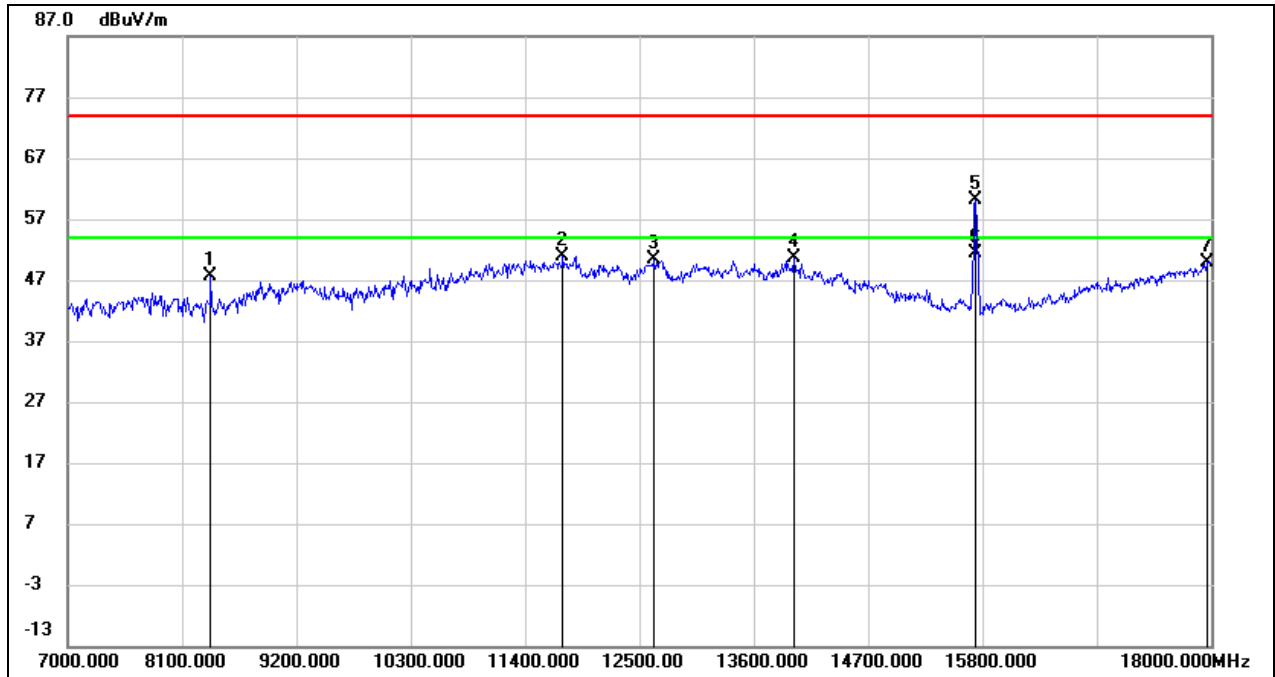

No.	Frequency (MHz)	Reading (dBuV)	Correct (dB/m)	Result (dBuV/m)	Limit (dBuV/m)	Margin (dB)	Remark
1	8375.000	40.77	6.77	47.54	74.00	-26.46	peak
2	11763.000	33.65	17.26	50.91	74.00	-23.09	peak
3	12643.000	32.39	18.01	50.40	74.00	-23.60	peak
4	13985.000	28.79	21.85	50.64	74.00	-23.36	peak
5	15734.000	43.38	16.81	60.19	74.00	-13.81	peak
6	15734.000	34.49	16.81	51.30	54.00	-2.70	AVG
7	17956.000	24.07	25.82	49.89	74.00	-24.11	peak

Test Mode:	802.11be EHT20	Channel:	5240
Polarity:	Vertical	Test Voltage:	DC 12 V

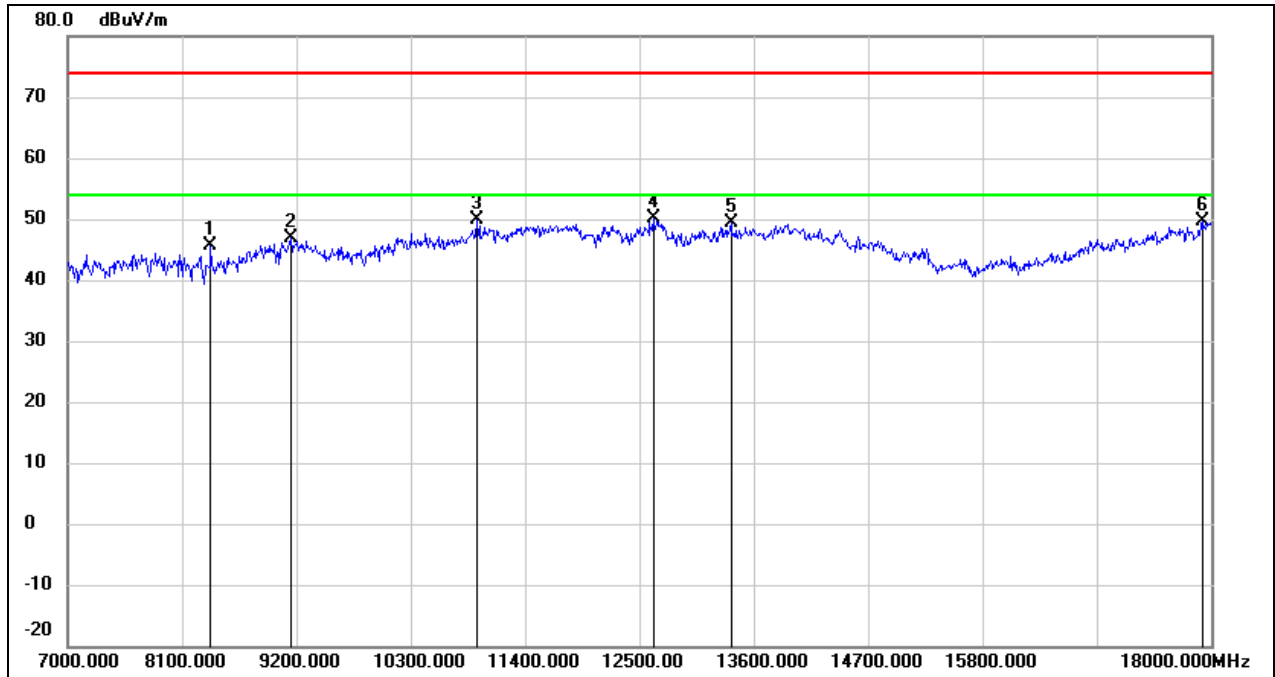

No.	Frequency (MHz)	Reading (dBuV)	Correct (dB/m)	Result (dBuV/m)	Limit (dBuV/m)	Margin (dB)	Remark
1	8375.000	38.80	6.77	45.57	74.00	-28.43	peak
2	9145.000	36.48	10.43	46.91	74.00	-27.09	peak
3	10938.000	35.40	14.48	49.88	74.00	-24.12	peak
4	12632.000	32.12	17.99	50.11	74.00	-23.89	peak
5	13380.000	29.37	20.12	49.49	74.00	-24.51	peak
6	17912.000	24.07	25.52	49.59	74.00	-24.41	peak

Test Mode:	802.11be EHT20	Channel:	5745
Polarity:	Horizontal	Test Voltage:	DC 12 V

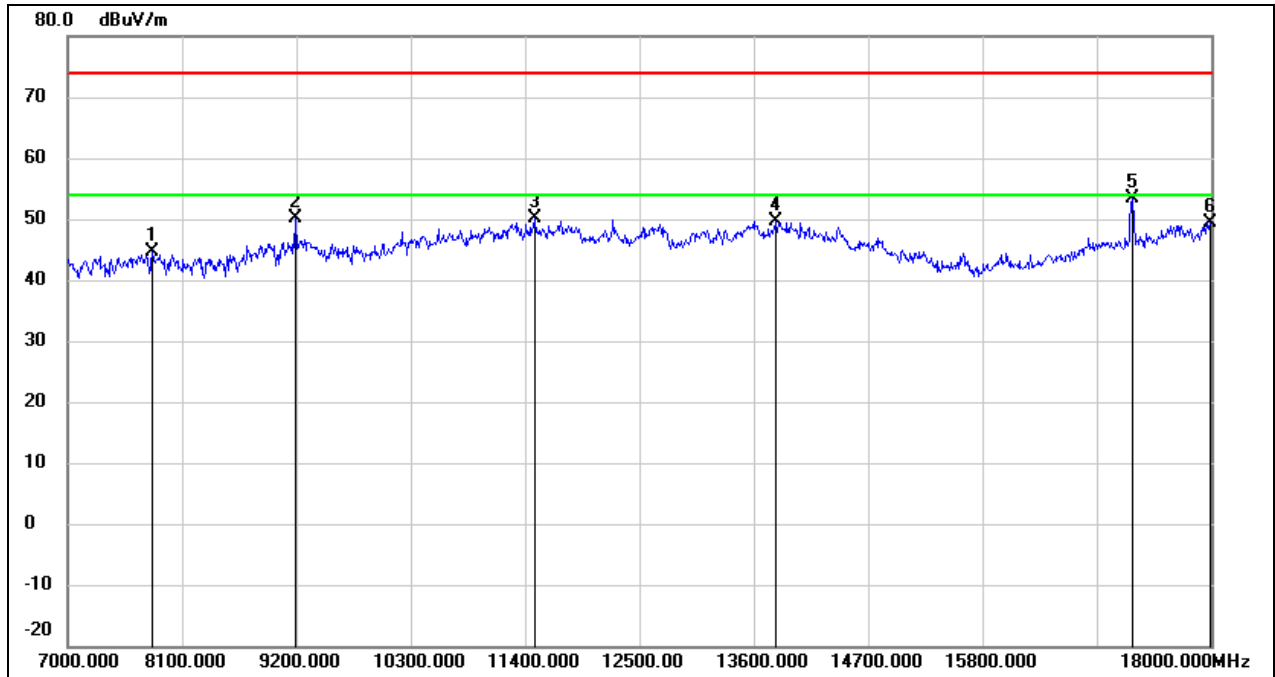

No.	Frequency (MHz)	Reading (dBuV)	Correct (dB/m)	Result (dBuV/m)	Limit (dBuV/m)	Margin (dB)	Remark
1	7814.000	37.99	6.60	44.59	74.00	-29.41	peak
2	9189.000	39.76	10.46	50.22	74.00	-23.78	peak
3	11488.000	33.29	16.72	50.01	74.00	-23.99	peak
4	13809.000	28.30	21.41	49.71	74.00	-24.29	peak
5	17241.000	31.85	21.62	53.47	74.00	-20.53	peak
6	17989.000	23.38	26.04	49.42	74.00	-24.58	peak

Test Mode:	802.11be EHT20	Channel:	5745
Polarity:	Vertical	Test Voltage:	DC 12 V

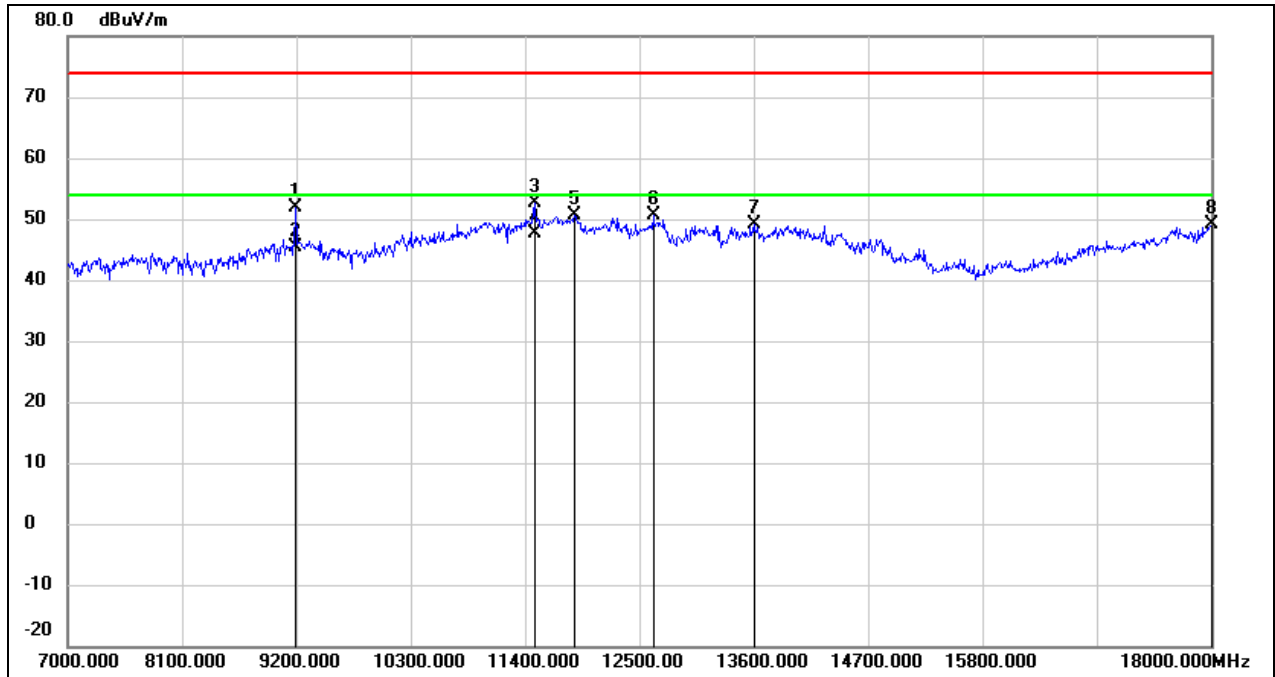

No.	Frequency (MHz)	Reading (dBuV)	Correct (dB/m)	Result (dBuV/m)	Limit (dBuV/m)	Margin (dB)	Remark
1	9189.000	41.46	10.46	51.92	74.00	-22.08	peak
2	9189.000	34.84	10.46	45.30	54.00	-8.70	AVG
3	11488.000	36.00	16.72	52.72	74.00	-21.28	peak
4	11488.000	30.88	16.72	47.60	54.00	-6.40	AVG
5	11873.000	33.10	17.46	50.56	74.00	-23.44	peak
6	12632.000	32.73	17.99	50.72	74.00	-23.28	peak
7	13600.000	28.24	20.89	49.13	74.00	-24.87	peak
8	18000.000	22.92	26.12	49.04	74.00	-24.96	peak

Test Mode:	802.11be EHT20	Channel:	5785
Polarity:	Horizontal	Test Voltage:	DC 12 V

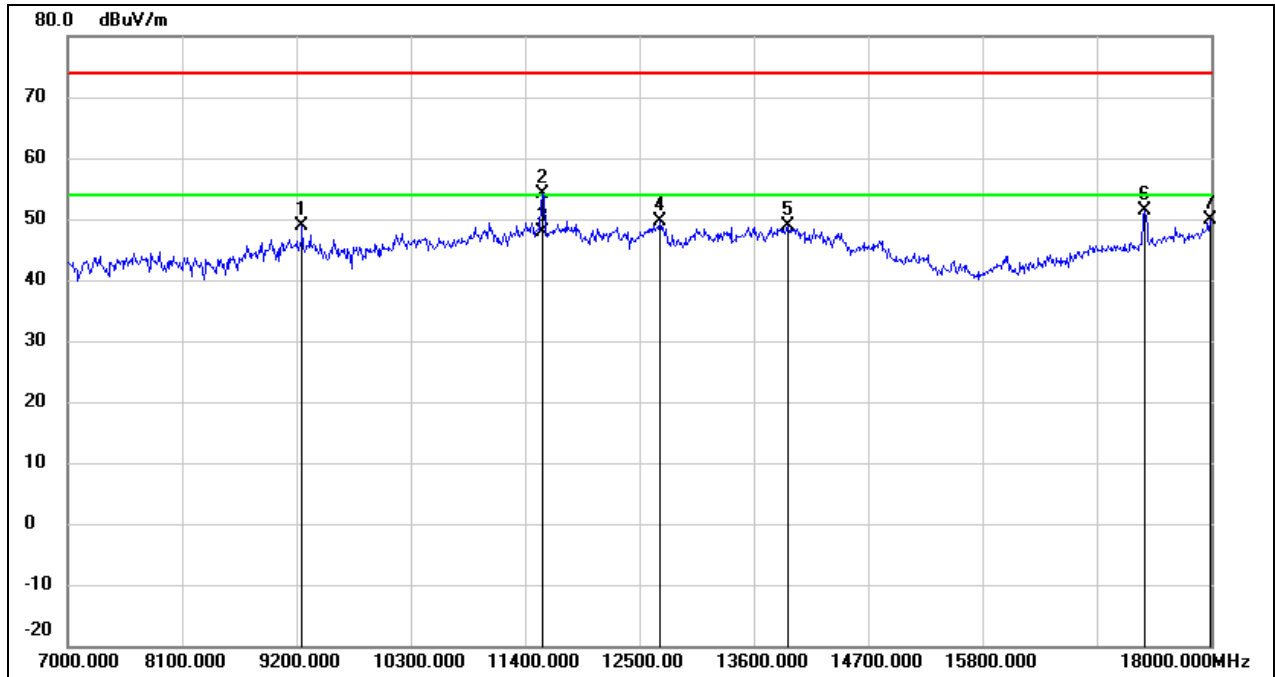

No.	Frequency (MHz)	Reading (dBuV)	Correct (dB/m)	Result (dBuV/m)	Limit (dBuV/m)	Margin (dB)	Remark
1	9255.000	38.29	10.51	48.80	74.00	-25.20	peak
2	11565.000	37.35	16.89	54.24	74.00	-19.76	peak
3	11565.000	31.11	16.89	48.00	54.00	-6.00	AVG
4	12698.000	31.54	18.08	49.62	74.00	-24.38	peak
5	13930.000	27.11	21.71	48.82	74.00	-25.18	peak
6	17362.000	29.28	22.12	51.40	74.00	-22.60	peak
7	17989.000	23.73	26.04	49.77	74.00	-24.23	peak

Test Mode:	802.11be EHT20	Channel:	5785
Polarity:	Vertical	Test Voltage:	DC 12 V

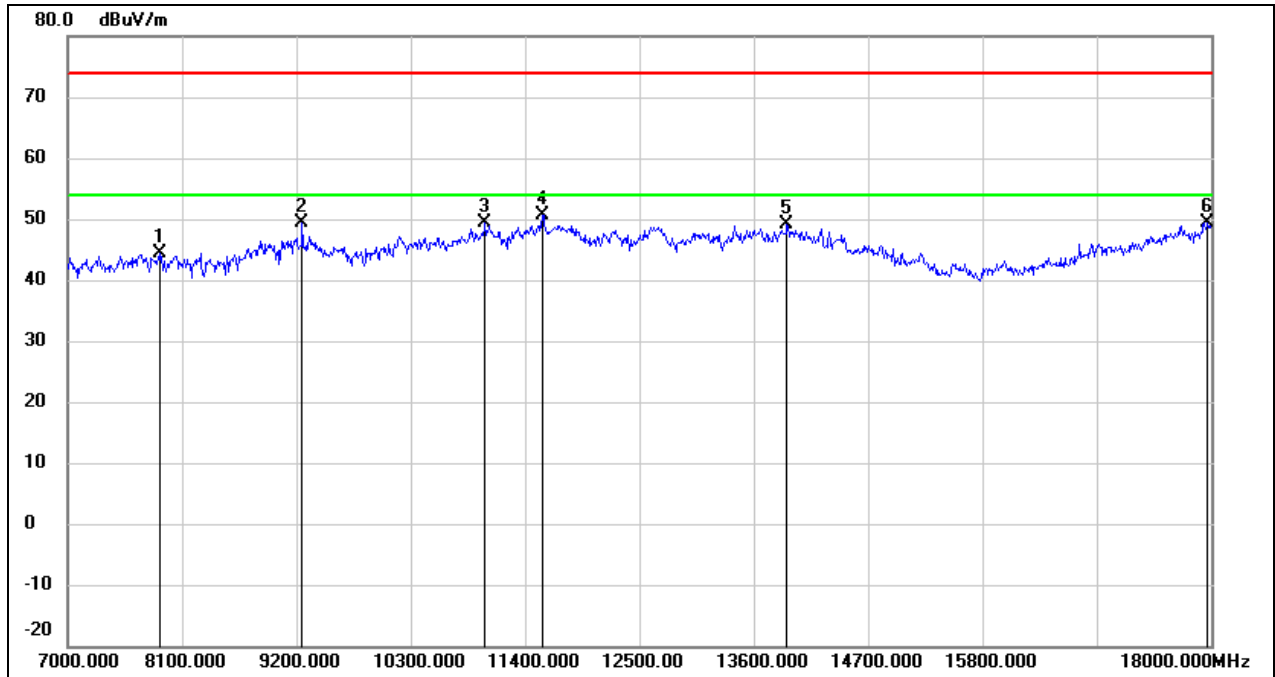

No.	Frequency (MHz)	Reading (dBuV)	Correct (dB/m)	Result (dBuV/m)	Limit (dBuV/m)	Margin (dB)	Remark
1	7880.000	37.84	6.54	44.38	74.00	-29.62	peak
2	9255.000	38.96	10.51	49.47	74.00	-24.53	peak
3	11015.000	34.60	14.79	49.39	74.00	-24.61	peak
4	11565.000	33.86	16.89	50.75	74.00	-23.25	peak
5	13919.000	27.39	21.68	49.07	74.00	-24.93	peak
6	17967.000	23.43	25.89	49.32	74.00	-24.68	peak

Test Mode:	802.11be EHT20	Channel:	5825
Polarity:	Horizontal	Test Voltage:	DC 12 V

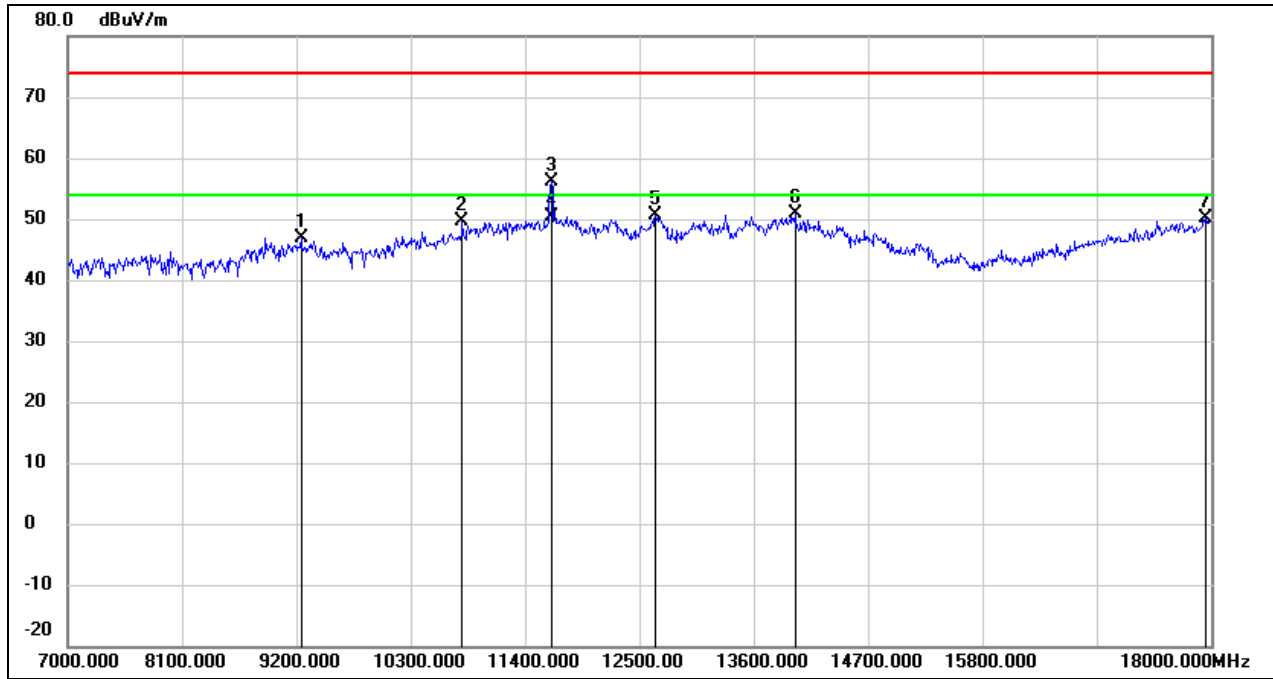

No.	Frequency (MHz)	Reading (dBuV)	Correct (dB/m)	Result (dBuV/m)	Limit (dBuV/m)	Margin (dB)	Remark
1	9244.000	36.29	10.49	46.78	74.00	-27.22	peak
2	10795.000	35.65	13.94	49.59	74.00	-24.41	peak
3	11653.000	38.99	17.05	56.04	74.00	-17.96	peak
4	11653.000	33.25	17.05	50.30	54.00	-3.70	AVG
5	12654.000	32.63	18.01	50.64	74.00	-23.36	peak
6	13996.000	29.12	21.87	50.99	74.00	-23.01	peak
7	17945.000	24.44	25.75	50.19	74.00	-23.81	peak

Test Mode:	802.11be EHT20	Channel:	5825
Polarity:	Vertical	Test Voltage:	DC 12 V

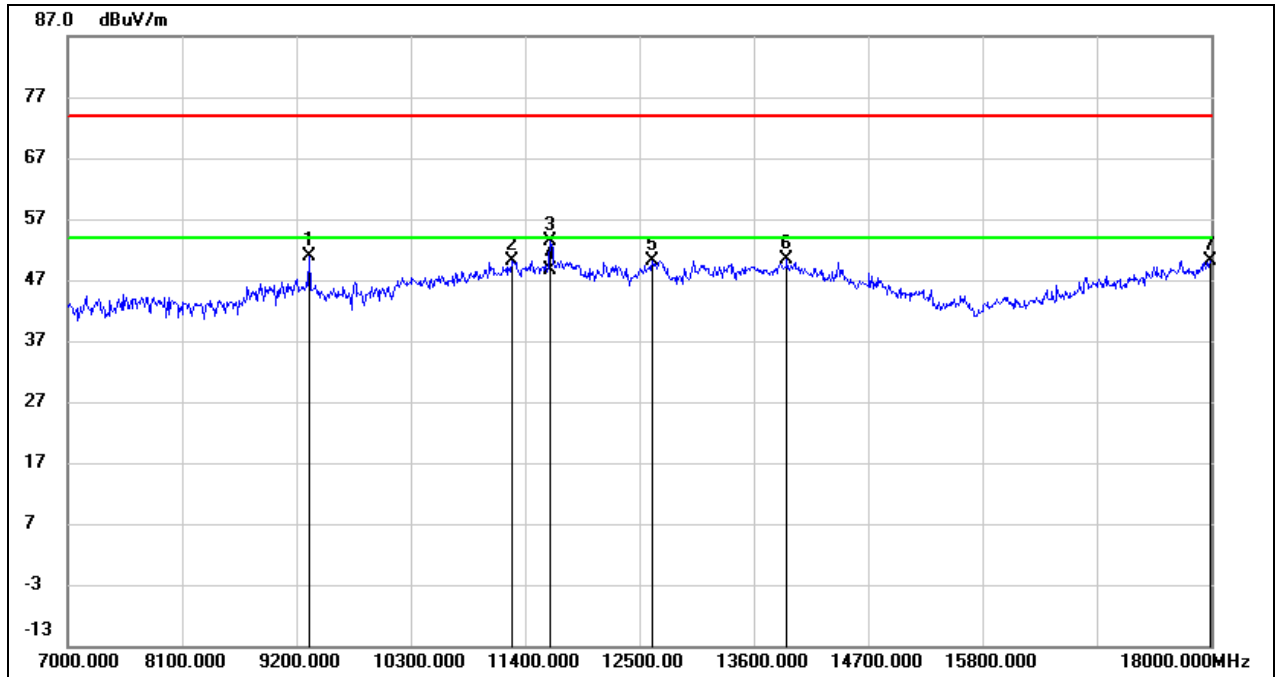

No.	Frequency (MHz)	Reading (dBuV)	Correct (dB/m)	Result (dBuV/m)	Limit (dBuV/m)	Margin (dB)	Remark
1	9321.000	40.29	10.53	50.82	74.00	-23.18	peak
2	11268.000	34.40	15.83	50.23	74.00	-23.77	peak
3	11642.000	36.26	17.03	53.29	74.00	-20.71	peak
4	11642.000	31.67	17.03	48.70	54.00	-5.30	AVG
5	12621.000	32.20	17.98	50.18	74.00	-23.82	peak
6	13919.000	28.67	21.68	50.35	74.00	-23.65	peak
7	17989.000	24.19	26.04	50.23	74.00	-23.77	peak



Test Mode:	802.11be EHT40	Channel:	5190
Polarity:	Horizontal	Test Voltage:	DC 12 V

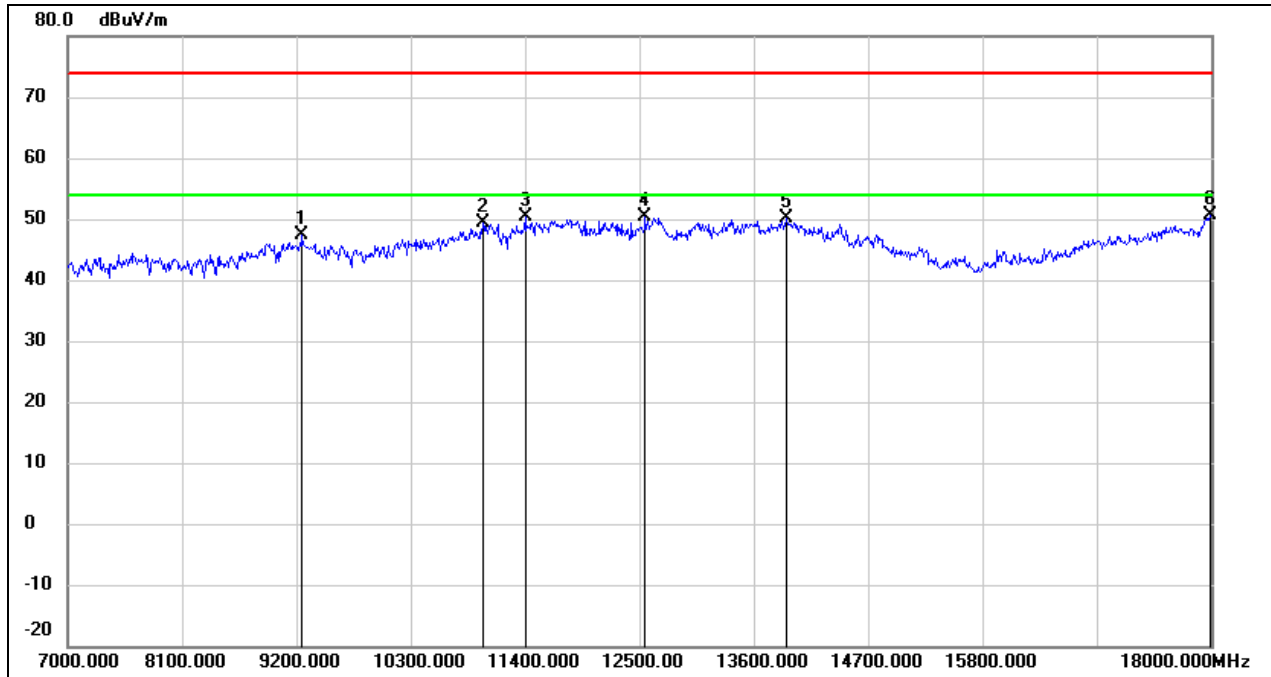

No.	Frequency (MHz)	Reading (dBuV)	Correct (dB/m)	Result (dBuV/m)	Limit (dBuV/m)	Margin (dB)	Remark
1	9255.000	36.83	10.51	47.34	74.00	-26.66	peak
2	10993.000	34.77	14.70	49.47	74.00	-24.53	peak
3	11400.000	33.93	16.36	50.29	74.00	-23.71	peak
4	12555.000	32.43	17.90	50.33	74.00	-23.67	peak
5	13919.000	28.44	21.68	50.12	74.00	-23.88	peak
6	17989.000	24.50	26.04	50.54	74.00	-23.46	peak

Test Mode:	802.11be EHT40	Channel:	5190
Polarity:	Vertical	Test Voltage:	DC 12 V

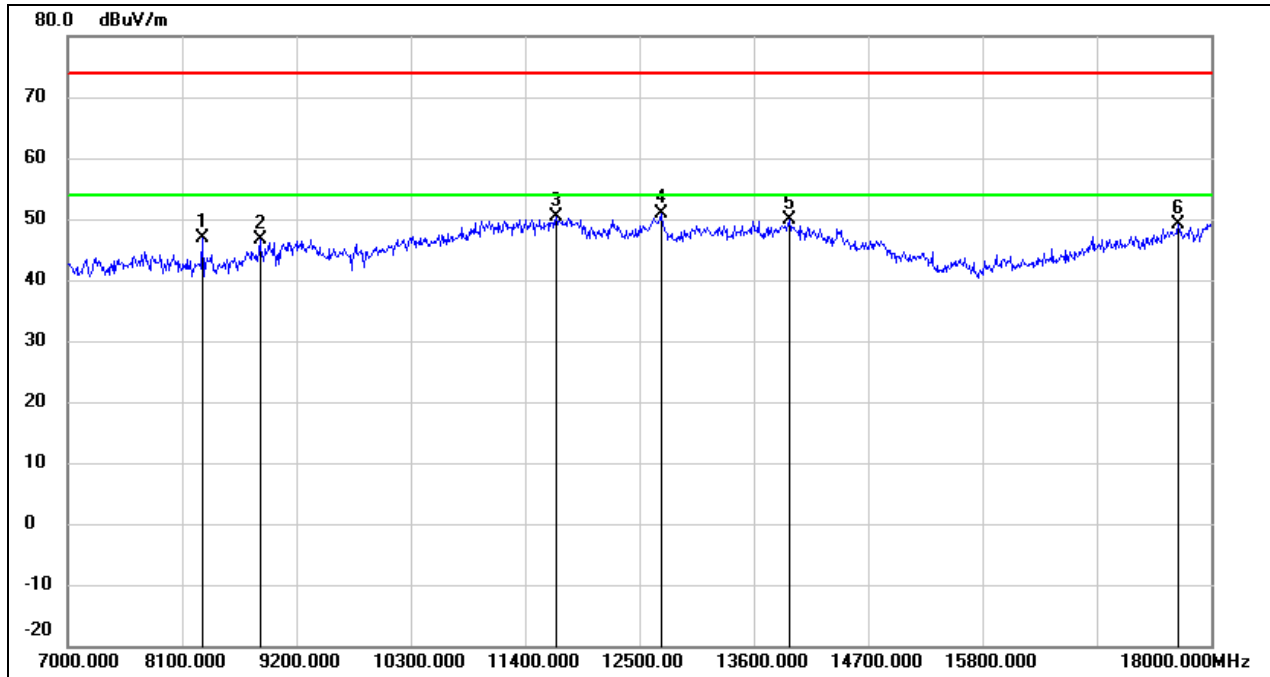

No.	Frequency (MHz)	Reading (dBuV)	Correct (dB/m)	Result (dBuV/m)	Limit (dBuV/m)	Margin (dB)	Remark
1	8298.000	40.18	6.71	46.89	74.00	-27.11	peak
2	8848.000	37.43	9.29	46.72	74.00	-27.28	peak
3	11697.000	33.26	17.13	50.39	74.00	-23.61	peak
4	12709.000	32.71	18.09	50.80	74.00	-23.20	peak
5	13941.000	28.06	21.73	49.79	74.00	-24.21	peak
6	17681.000	25.18	23.94	49.12	74.00	-24.88	peak

Test Mode:	802.11be EHT40	Channel:	5230
Polarity:	Horizontal	Test Voltage:	DC 12 V

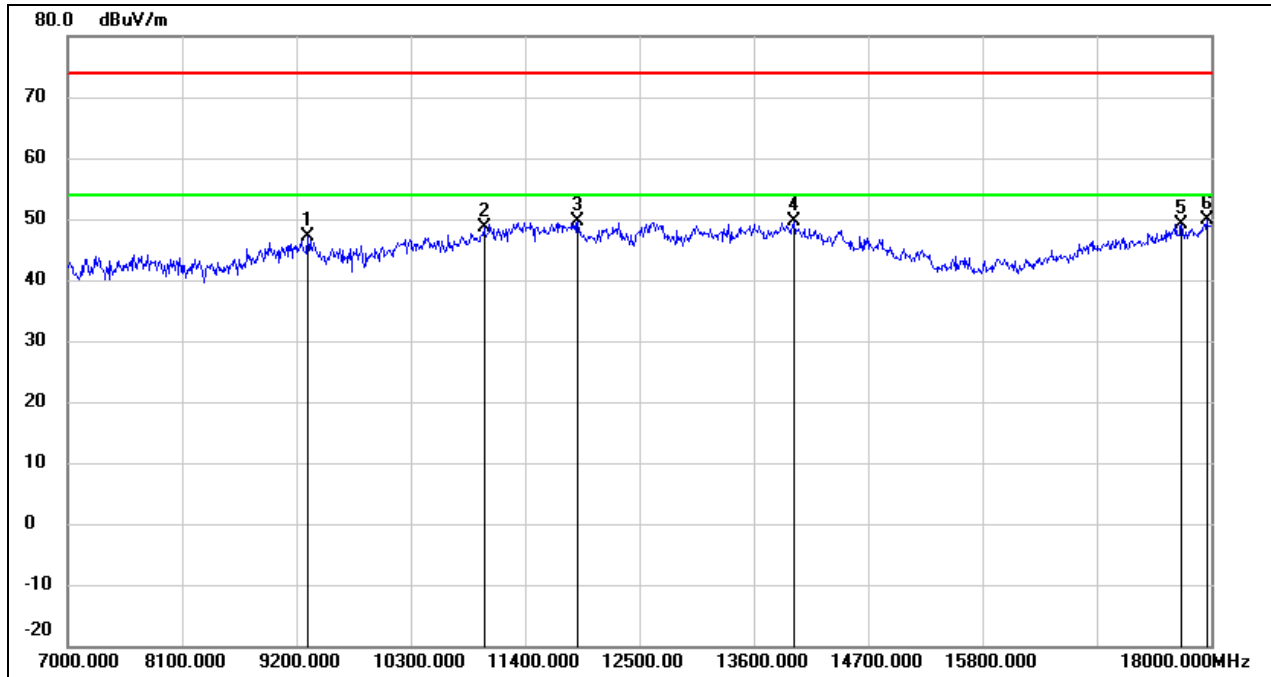

No.	Frequency (MHz)	Reading (dBuV)	Correct (dB/m)	Result (dBuV/m)	Limit (dBuV/m)	Margin (dB)	Remark
1	9310.000	36.52	10.54	47.06	74.00	-26.94	peak
2	11004.000	33.97	14.74	48.71	74.00	-25.29	peak
3	11906.000	32.01	17.52	49.53	74.00	-24.47	peak
4	13985.000	27.67	21.85	49.52	74.00	-24.48	peak
5	17714.000	24.95	24.16	49.11	74.00	-24.89	peak
6	17956.000	24.13	25.82	49.95	74.00	-24.05	peak

Test Mode:	802.11be EHT40	Channel:	5230
Polarity:	Vertical	Test Voltage:	DC 12 V

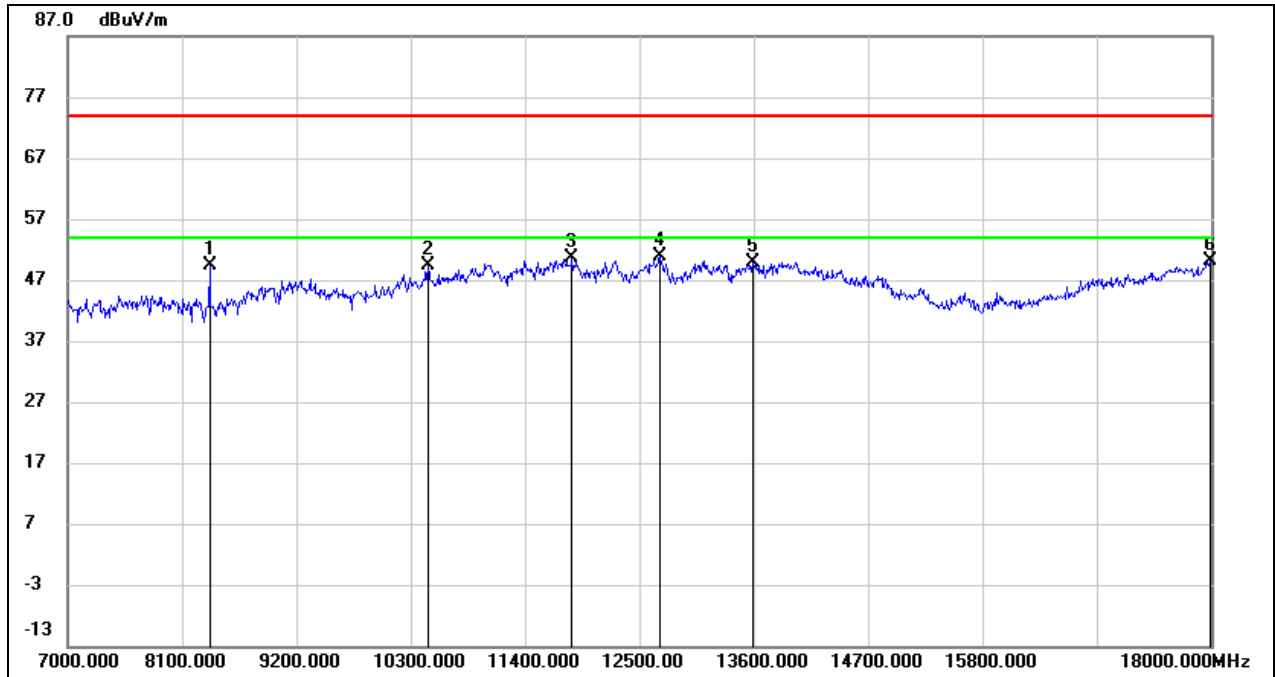

No.	Frequency (MHz)	Reading (dBuV)	Correct (dB/m)	Result (dBuV/m)	Limit (dBuV/m)	Margin (dB)	Remark
1	8364.000	42.61	6.76	49.37	74.00	-24.63	peak
2	10465.000	36.59	12.75	49.34	74.00	-24.66	peak
3	11851.000	33.24	17.43	50.67	74.00	-23.33	peak
4	12698.000	32.91	18.08	50.99	74.00	-23.01	peak
5	13589.000	29.13	20.86	49.99	74.00	-24.01	peak
6	17989.000	23.97	26.04	50.01	74.00	-23.99	peak

Test Mode:	802.11be EHT40	Channel:	5755
Polarity:	Horizontal	Test Voltage:	DC 12 V

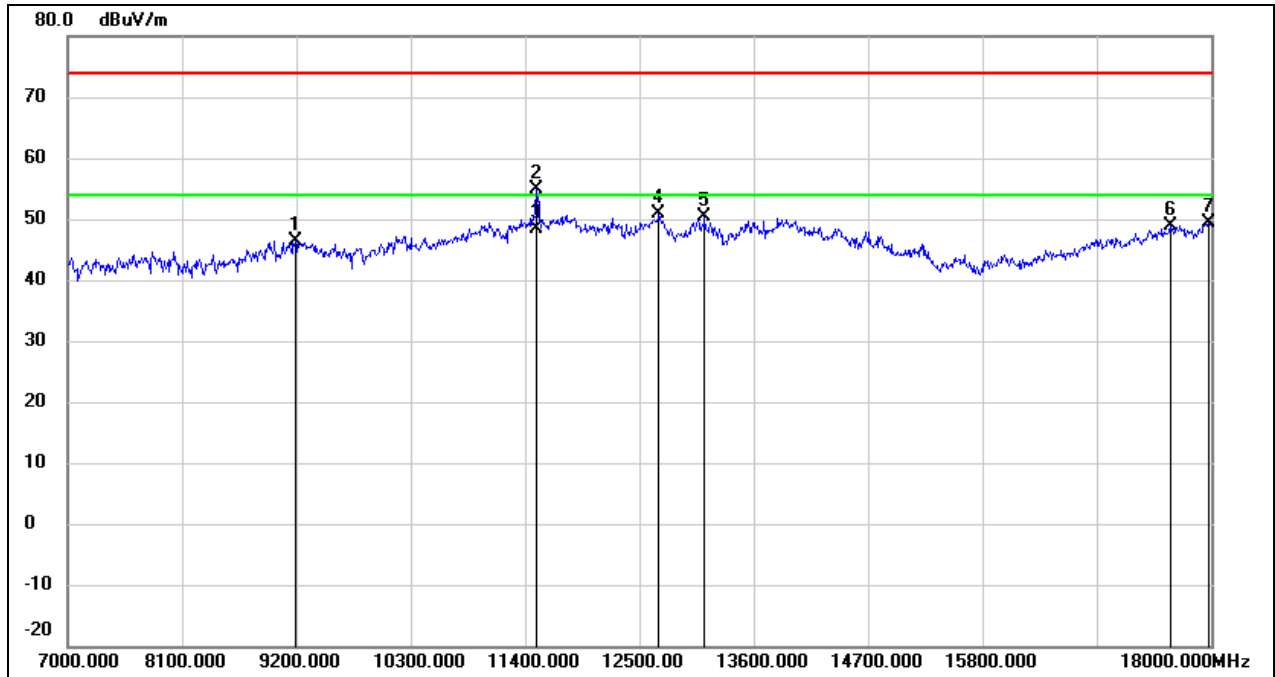

No.	Frequency (MHz)	Reading (dBuV)	Correct (dB/m)	Result (dBuV/m)	Limit (dBuV/m)	Margin (dB)	Remark
1	9189.000	35.99	10.46	46.45	74.00	-27.55	peak
2	11510.000	38.05	16.79	54.84	74.00	-19.16	peak
3	11510.000	31.71	16.79	48.50	54.00	-5.50	AVG
4	12687.000	32.72	18.05	50.77	74.00	-23.23	peak
5	13127.000	31.35	19.01	50.36	74.00	-23.64	peak
6	17604.000	25.59	23.41	49.00	74.00	-25.00	peak
7	17978.000	23.45	25.97	49.42	74.00	-24.58	peak

Test Mode:	802.11be EHT40	Channel:	5755
Polarity:	Vertical	Test Voltage:	DC 12 V

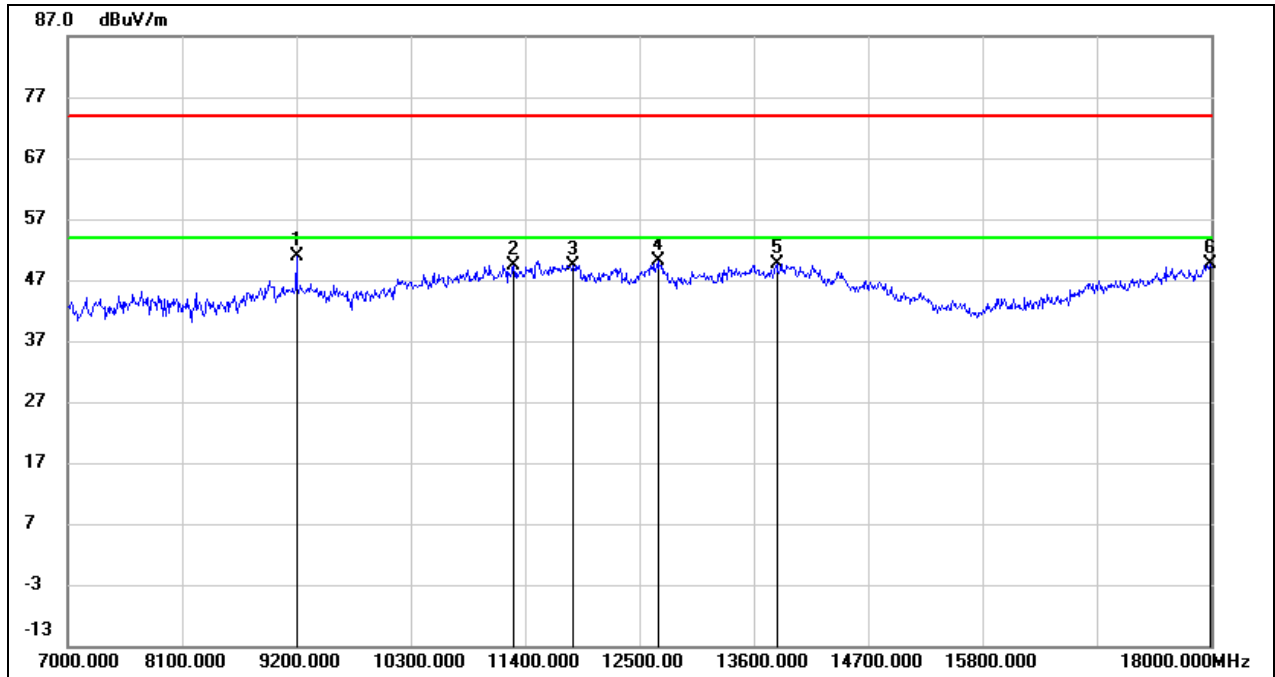

No.	Frequency (MHz)	Reading (dBuV)	Correct (dB/m)	Result (dBuV/m)	Limit (dBuV/m)	Margin (dB)	Remark
1	9200.000	40.37	10.46	50.83	74.00	-23.17	peak
2	11290.000	33.45	15.90	49.35	74.00	-24.65	peak
3	11862.000	32.00	17.45	49.45	74.00	-24.55	peak
4	12676.000	31.98	18.05	50.03	74.00	-23.97	peak
5	13820.000	28.21	21.43	49.64	74.00	-24.36	peak
6	17989.000	23.50	26.04	49.54	74.00	-24.46	peak

Test Mode:	802.11be EHT40	Channel:	5795
Polarity:	Horizontal	Test Voltage:	DC 12 V

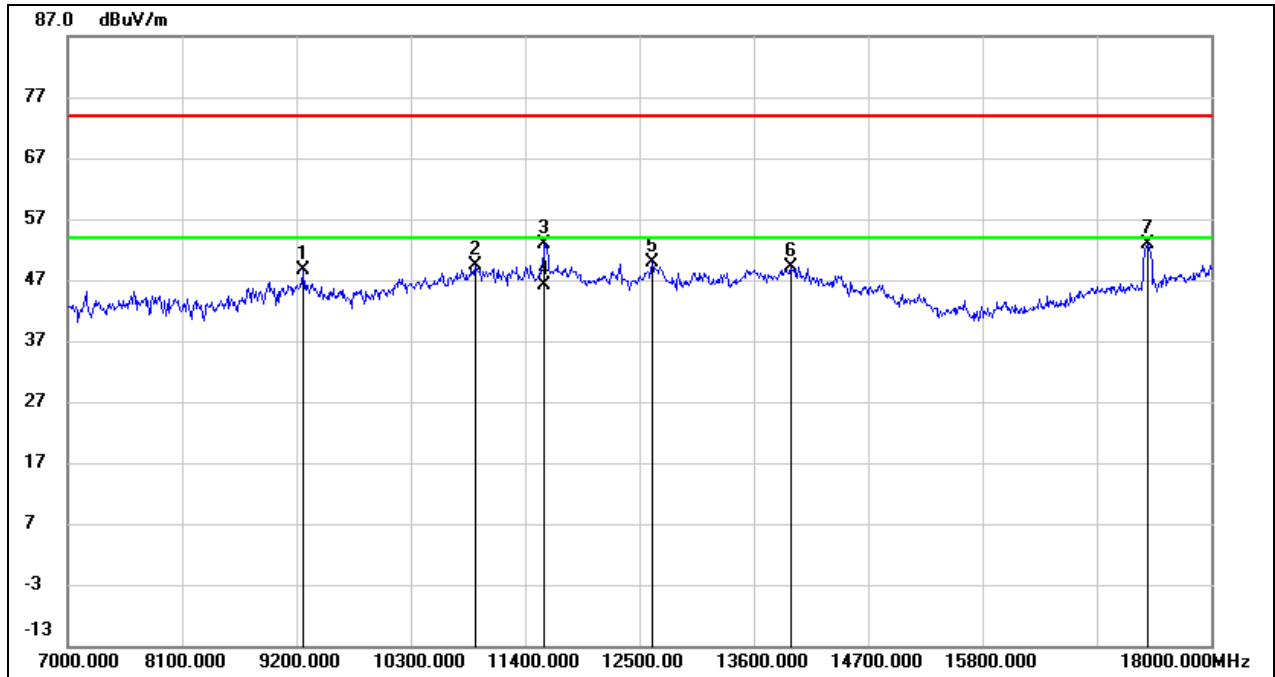

No.	Frequency (MHz)	Reading (dBuV)	Correct (dB/m)	Result (dBuV/m)	Limit (dBuV/m)	Margin (dB)	Remark
1	9266.000	38.05	10.51	48.56	74.00	-25.44	peak
2	10916.000	35.04	14.39	49.43	74.00	-24.57	peak
3	11587.000	36.00	16.93	52.93	74.00	-21.07	peak
4	11587.000	29.17	16.93	46.10	54.00	-7.90	AVG
5	12621.000	32.00	17.98	49.98	74.00	-24.02	peak
6	13952.000	27.30	21.76	49.06	74.00	-24.94	peak
7	17384.000	30.70	22.22	52.92	74.00	-21.08	peak

Test Mode:	802.11be EHT40	Channel:	5795
Polarity:	Vertical	Test Voltage:	DC 12 V

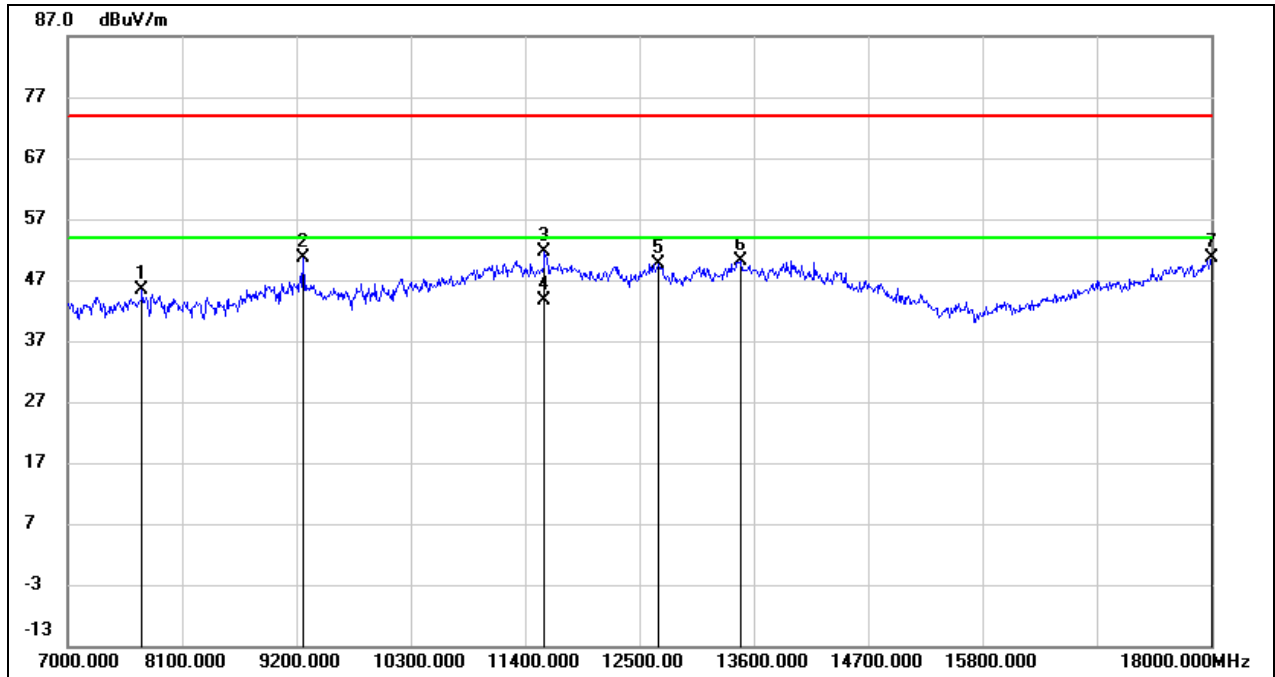

No.	Frequency (MHz)	Reading (dBuV)	Correct (dB/m)	Result (dBuV/m)	Limit (dBuV/m)	Margin (dB)	Remark
1	7715.000	38.75	6.68	45.43	74.00	-28.57	peak
2	9266.000	40.18	10.51	50.69	74.00	-23.31	peak
3	11587.000	34.77	16.93	51.70	74.00	-22.30	peak
4	11587.000	26.77	16.93	43.70	54.00	-10.30	AVG
5	12687.000	31.66	18.05	49.71	74.00	-24.29	peak
6	13479.000	29.68	20.55	50.23	74.00	-23.77	peak
7	18000.000	24.44	26.12	50.56	74.00	-23.44	peak



Test Mode:	802.11be EHT80	Channel:	5210
Polarity:	Horizontal	Test Voltage:	DC 12 V

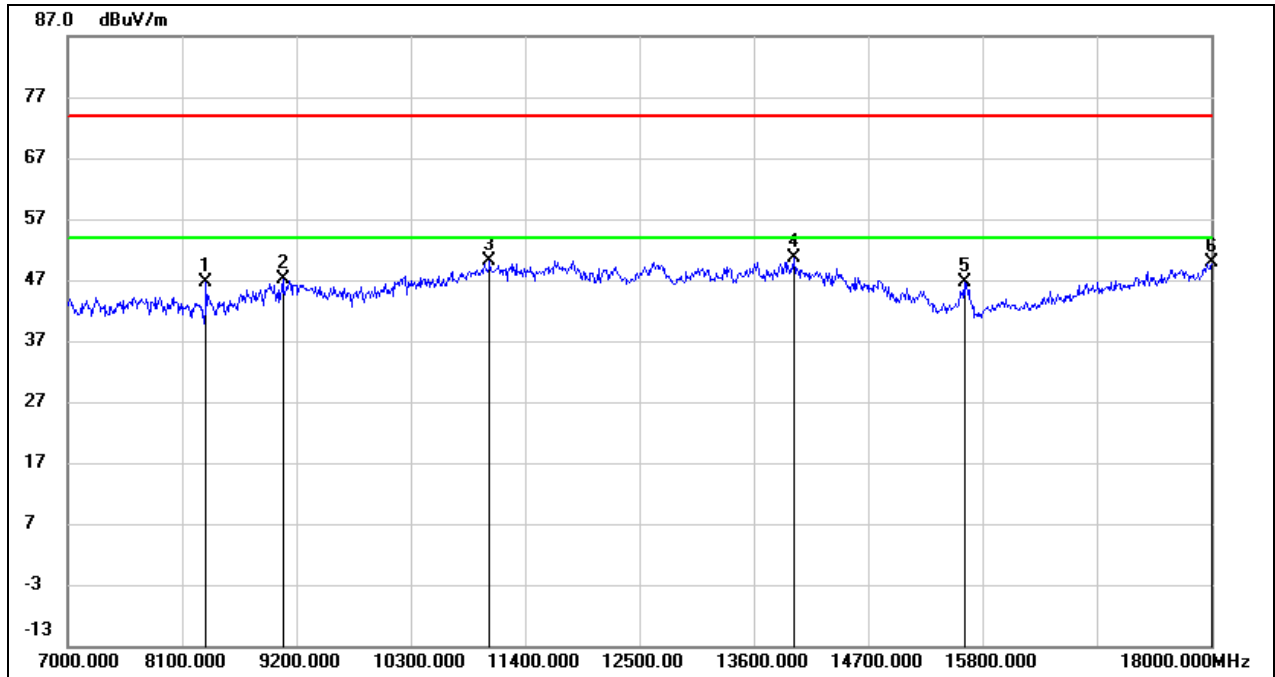

No.	Frequency (MHz)	Reading (dBuV)	Correct (dB/m)	Result (dBuV/m)	Limit (dBuV/m)	Margin (dB)	Remark
1	8331.000	39.89	6.73	46.62	74.00	-27.38	peak
2	9068.000	36.62	10.39	47.01	74.00	-26.99	peak
3	11059.000	35.21	14.96	50.17	74.00	-23.83	peak
4	13985.000	28.89	21.85	50.74	74.00	-23.26	peak
5	15624.000	29.83	16.76	46.59	74.00	-27.41	peak
6	18000.000	23.78	26.12	49.90	74.00	-24.10	peak

Test Mode:	802.11be EHT80	Channel:	5210
Polarity:	Vertical	Test Voltage:	DC 12 V

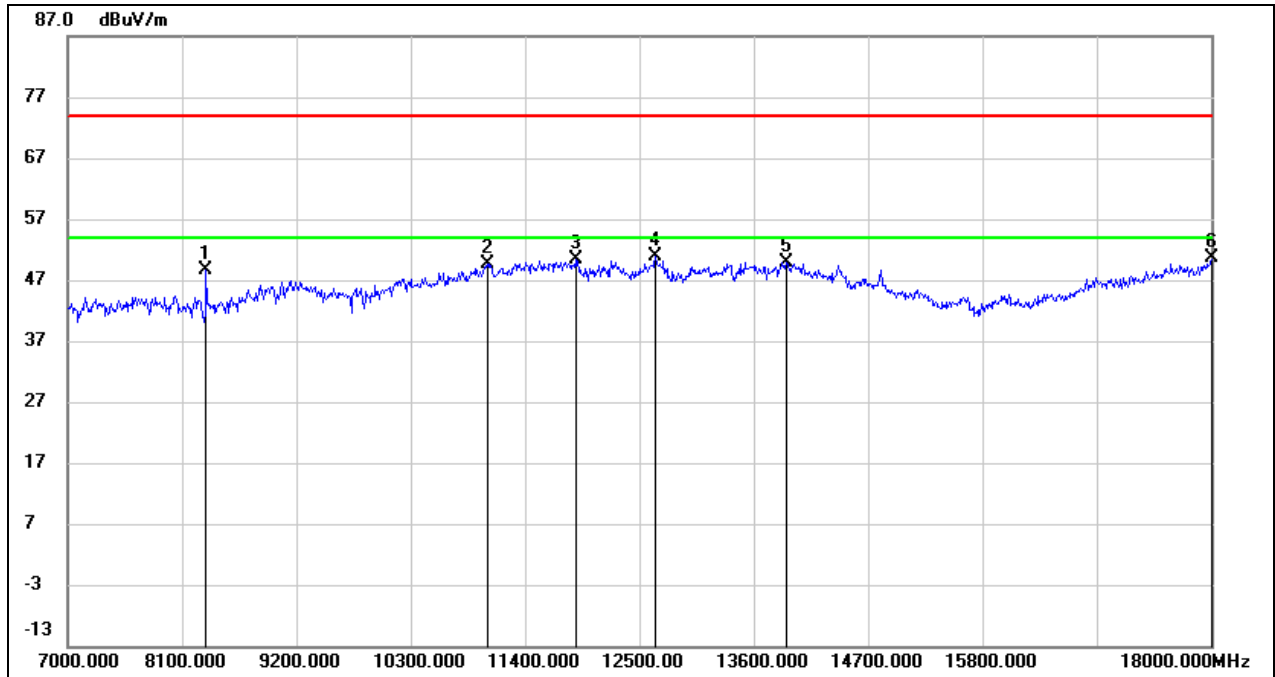

No.	Frequency (MHz)	Reading (dBuV)	Correct (dB/m)	Result (dBuV/m)	Limit (dBuV/m)	Margin (dB)	Remark
1	8331.000	41.87	6.73	48.60	74.00	-25.40	peak
2	11037.000	34.77	14.87	49.64	74.00	-24.36	peak
3	11884.000	32.86	17.48	50.34	74.00	-23.66	peak
4	12654.000	32.80	18.01	50.81	74.00	-23.19	peak
5	13919.000	28.28	21.68	49.96	74.00	-24.04	peak
6	18000.000	24.47	26.12	50.59	74.00	-23.41	peak

Test Mode:	802.11be EHT80	Channel:	5775
Polarity:	Horizontal	Test Voltage:	DC 12 V

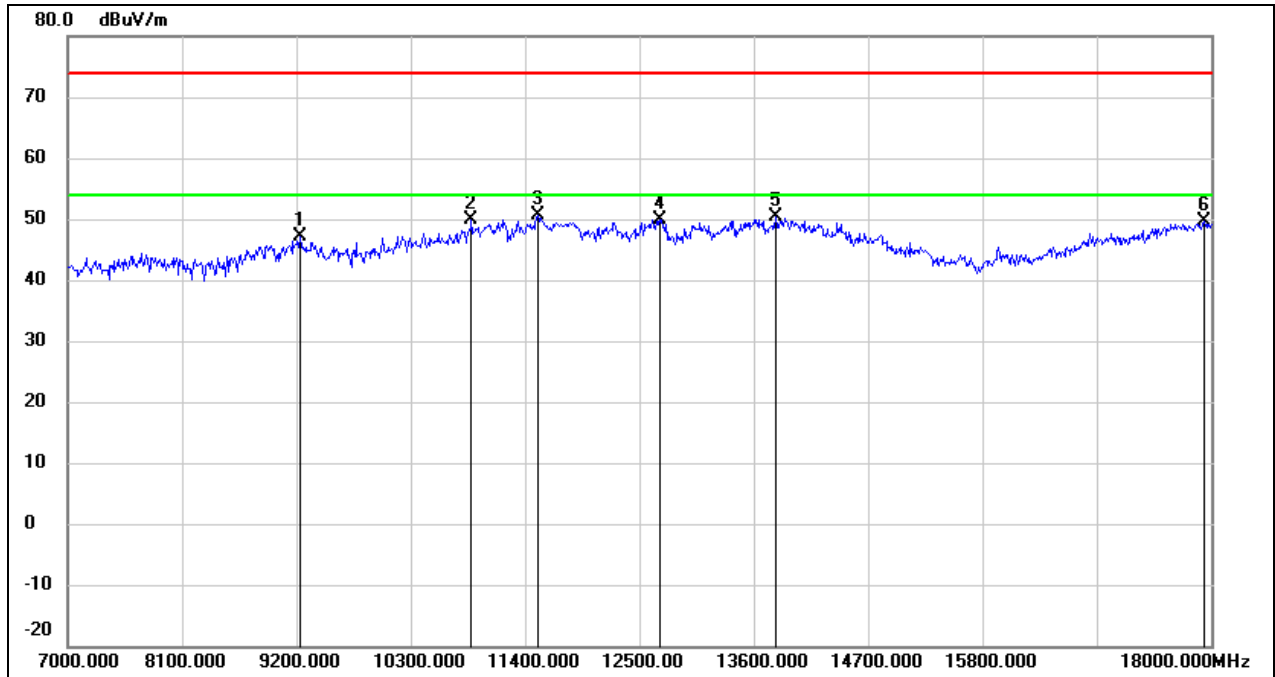

No.	Frequency (MHz)	Reading (dBuV)	Correct (dB/m)	Result (dBuV/m)	Limit (dBuV/m)	Margin (dB)	Remark
1	9233.000	36.73	10.48	47.21	74.00	-26.79	peak
2	10883.000	35.72	14.27	49.99	74.00	-24.01	peak
3	11521.000	33.72	16.82	50.54	74.00	-23.46	peak
4	12698.000	31.91	18.08	49.99	74.00	-24.01	peak
5	13809.000	29.09	21.41	50.50	74.00	-23.50	peak
6	17934.000	23.93	25.67	49.60	74.00	-24.40	peak

Test Mode:	802.11be EHT80	Channel:	5775
Polarity:	Vertical	Test Voltage:	DC 12 V

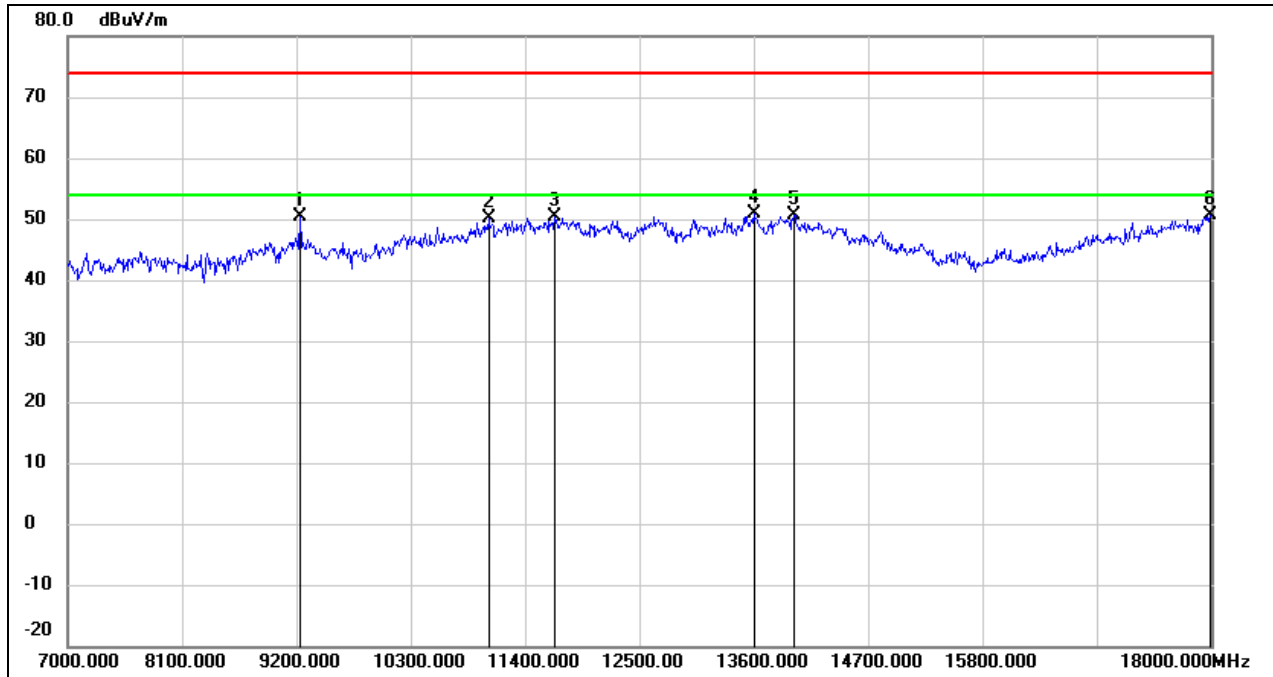

No.	Frequency (MHz)	Reading (dBuV)	Correct (dB/m)	Result (dBuV/m)	Limit (dBuV/m)	Margin (dB)	Remark
1	9233.000	39.99	10.48	50.47	74.00	-23.53	peak
2	11048.000	35.17	14.91	50.08	74.00	-23.92	peak
3	11686.000	33.19	17.12	50.31	74.00	-23.69	peak
4	13600.000	29.89	20.89	50.78	74.00	-23.22	peak
5	13985.000	28.90	21.85	50.75	74.00	-23.25	peak
6	17989.000	24.57	26.04	50.61	74.00	-23.39	peak

## 8.6. SPURIOUS EMISSIONS(7 GHZ~18 GHZ)

For ISED UNII-1 test data:

Test Mode:	802.11a 20	Channel:	5180
Polarity:	Horizontal	Test Voltage:	DC 12 V

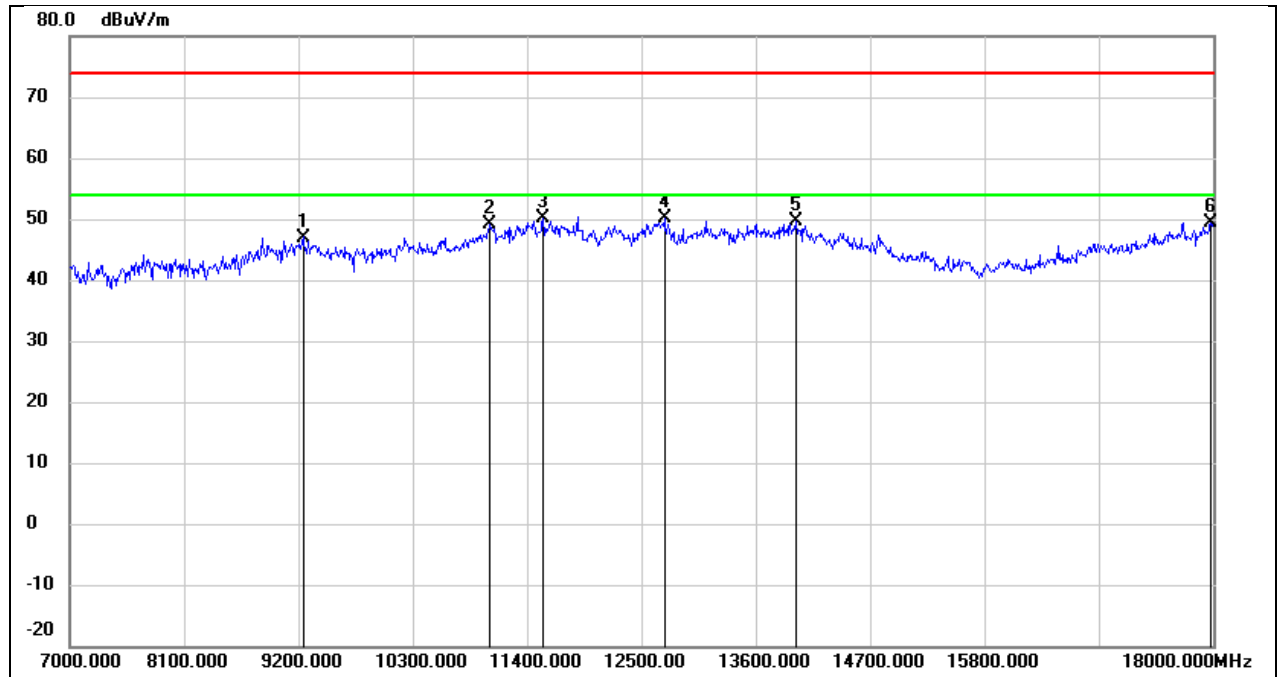

No.	Frequency (MHz)	Reading (dBuV)	Correct (dB/m)	Result (dBuV/m)	Limit (dBuV/m)	Margin (dB)	Remark
1	9244.000	36.51	10.49	47.00	74.00	-27.00	peak
2	11037.000	34.21	14.87	49.08	74.00	-24.92	peak
3	11554.000	33.16	16.87	50.03	74.00	-23.97	peak
4	12720.000	32.10	18.09	50.19	74.00	-23.81	peak
5	13985.000	27.73	21.85	49.58	74.00	-24.42	peak
6	17978.000	23.50	25.97	49.47	74.00	-24.53	peak

Test Mode:	802.11a 20	Channel:	5180
Polarity:	Vertical	Test Voltage:	DC 12 V

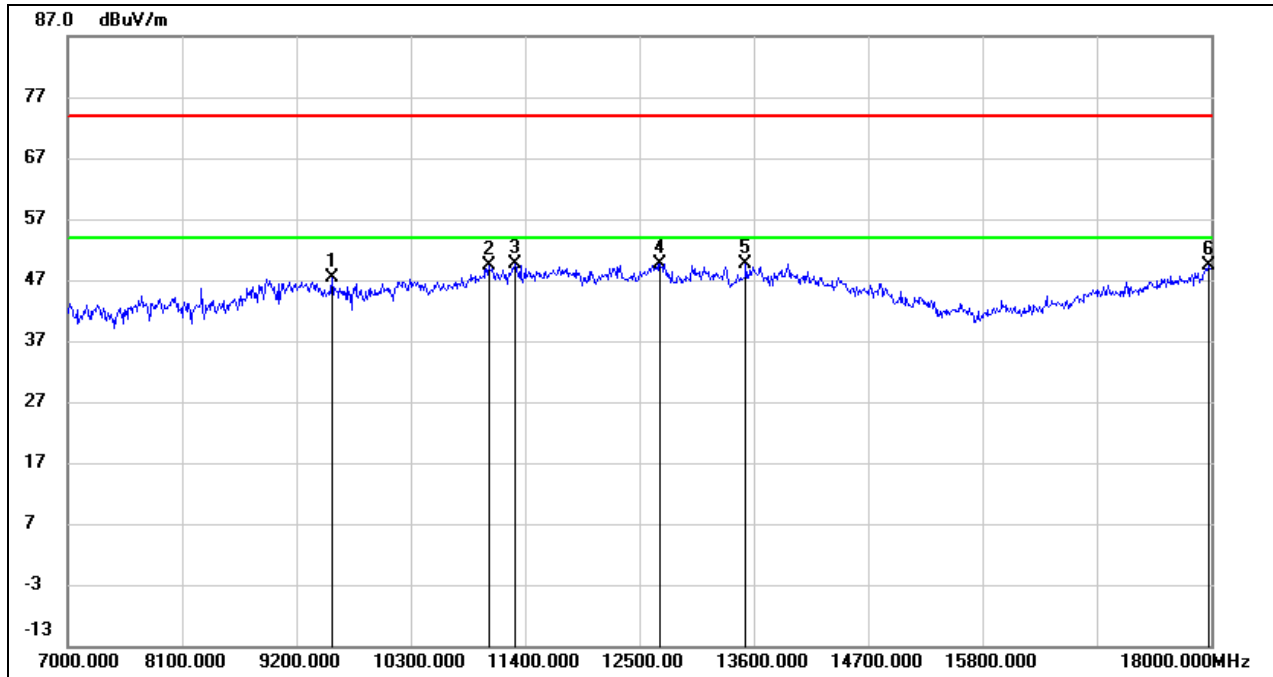

No.	Frequency (MHz)	Reading (dBuV)	Correct (dB/m)	Result (dBuV/m)	Limit (dBuV/m)	Margin (dB)	Remark
1	9541.000	36.74	10.74	47.48	74.00	-26.52	peak
2	11048.000	34.41	14.91	49.32	74.00	-24.68	peak
3	11301.000	33.68	15.95	49.63	74.00	-24.37	peak
4	12698.000	31.61	18.08	49.69	74.00	-24.31	peak
5	13523.000	28.95	20.70	49.65	74.00	-24.35	peak
6	17978.000	23.30	25.97	49.27	74.00	-24.73	peak

Test Mode:	802.11a 20	Channel:	5200
Polarity:	Horizontal	Test Voltage:	DC 12 V

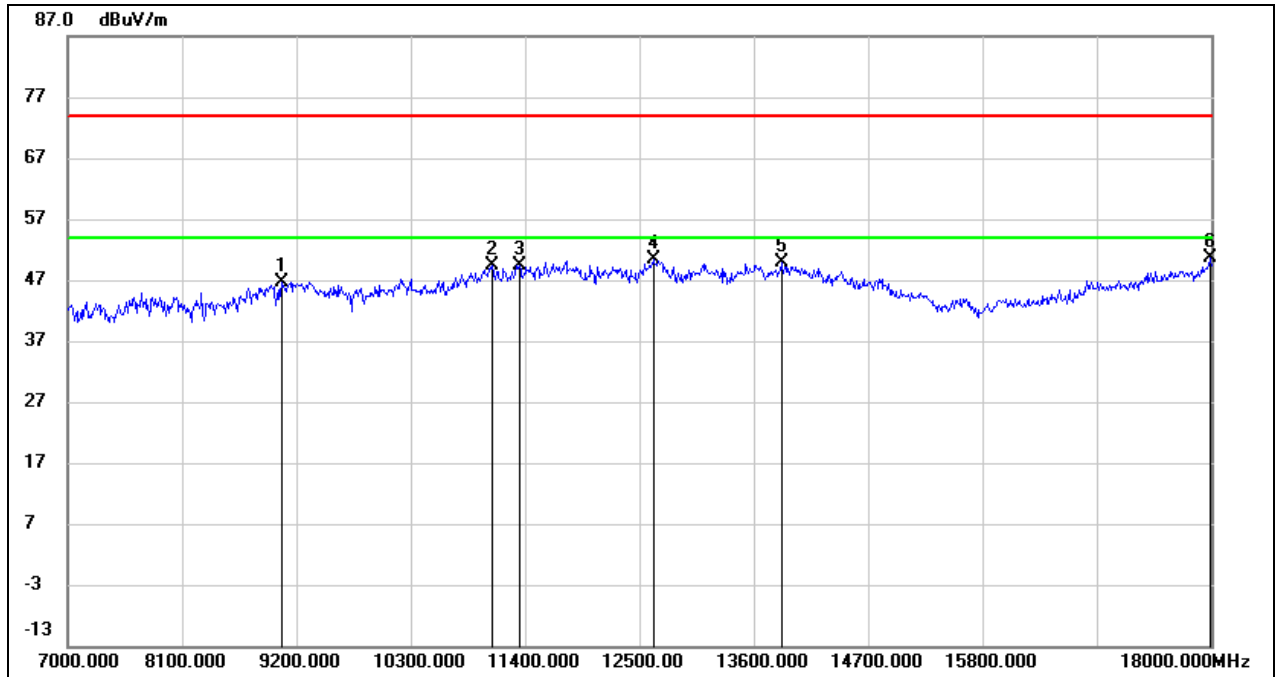

No.	Frequency (MHz)	Reading (dBuV)	Correct (dB/m)	Result (dBuV/m)	Limit (dBuV/m)	Margin (dB)	Remark
1	9057.000	36.20	10.38	46.58	74.00	-27.42	peak
2	11081.000	34.34	15.05	49.39	74.00	-24.61	peak
3	11345.000	33.27	16.14	49.41	74.00	-24.59	peak
4	12632.000	32.32	17.99	50.31	74.00	-23.69	peak
5	13864.000	28.37	21.53	49.90	74.00	-24.10	peak
6	17989.000	24.48	26.04	50.52	74.00	-23.48	peak

Test Mode:	802.11a 20	Channel:	5200
Polarity:	Vertical	Test Voltage:	DC 12 V

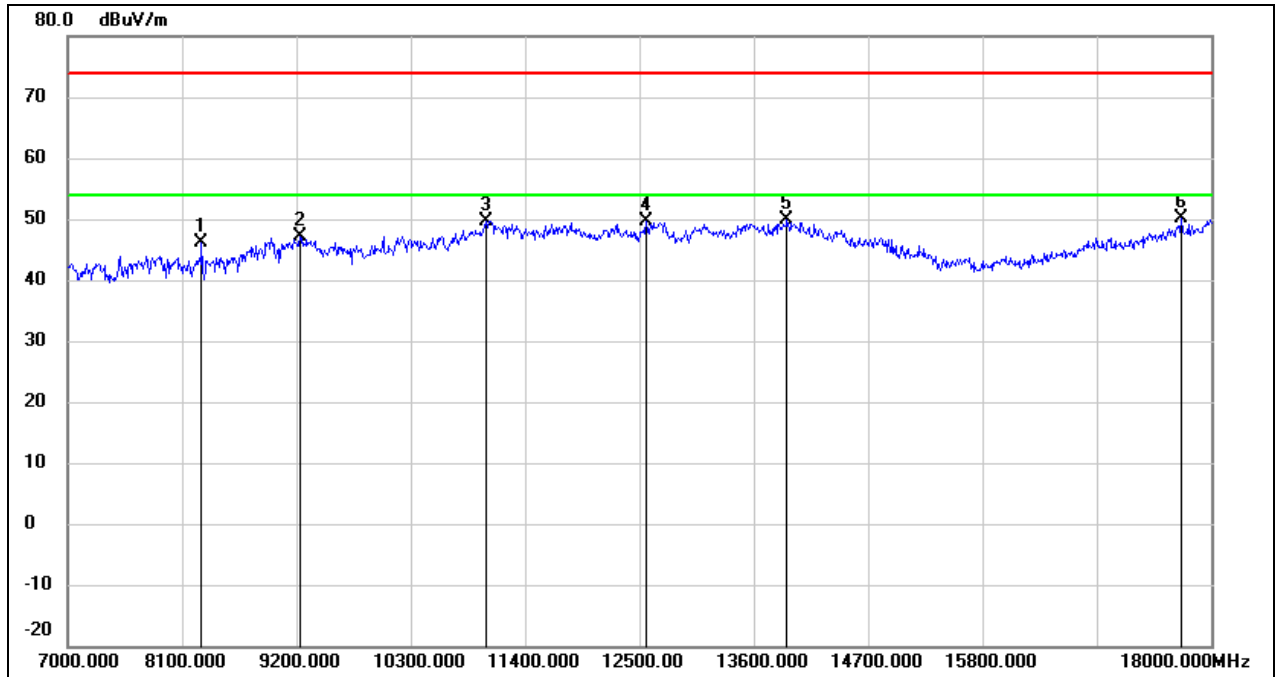

No.	Frequency (MHz)	Reading (dBuV)	Correct (dB/m)	Result (dBuV/m)	Limit (dBuV/m)	Margin (dB)	Remark
1	8287.000	39.47	6.70	46.17	74.00	-27.83	peak
2	9233.000	36.75	10.48	47.23	74.00	-26.77	peak
3	11026.000	34.90	14.82	49.72	74.00	-24.28	peak
4	12566.000	31.72	17.91	49.63	74.00	-24.37	peak
5	13919.000	28.28	21.68	49.96	74.00	-24.04	peak
6	17714.000	26.04	24.16	50.20	74.00	-23.80	peak



Test Mode:	802.11a 20	Channel:	5240
Polarity:	Horizontal	Test Voltage:	DC 12 V

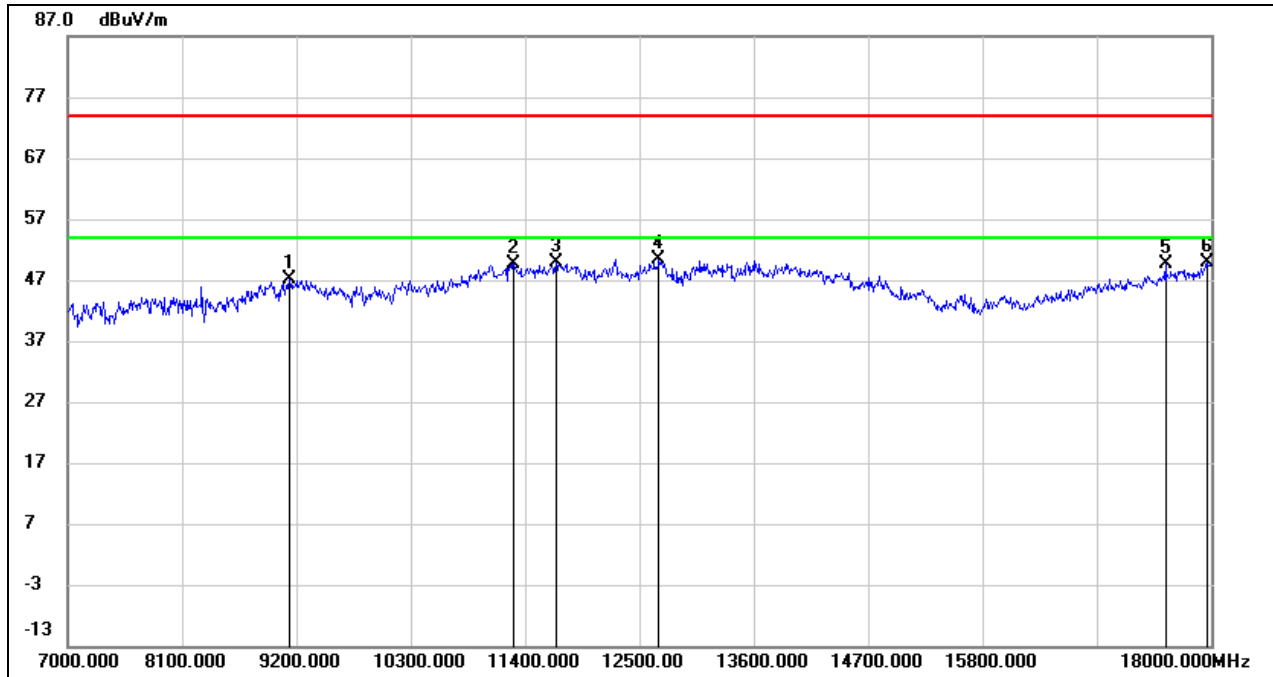

No.	Frequency (MHz)	Reading (dBuV)	Correct (dB/m)	Result (dBuV/m)	Limit (dBuV/m)	Margin (dB)	Remark
1	9134.000	36.79	10.41	47.20	74.00	-26.80	peak
2	11290.000	33.82	15.90	49.72	74.00	-24.28	peak
3	11697.000	32.80	17.13	49.93	74.00	-24.07	peak
4	12687.000	32.29	18.05	50.34	74.00	-23.66	peak
5	17560.000	26.63	23.11	49.74	74.00	-24.26	peak
6	17956.000	24.03	25.82	49.85	74.00	-24.15	peak

Test Mode:	802.11a 20	Channel:	5240
Polarity:	Vertical	Test Voltage:	DC 12 V

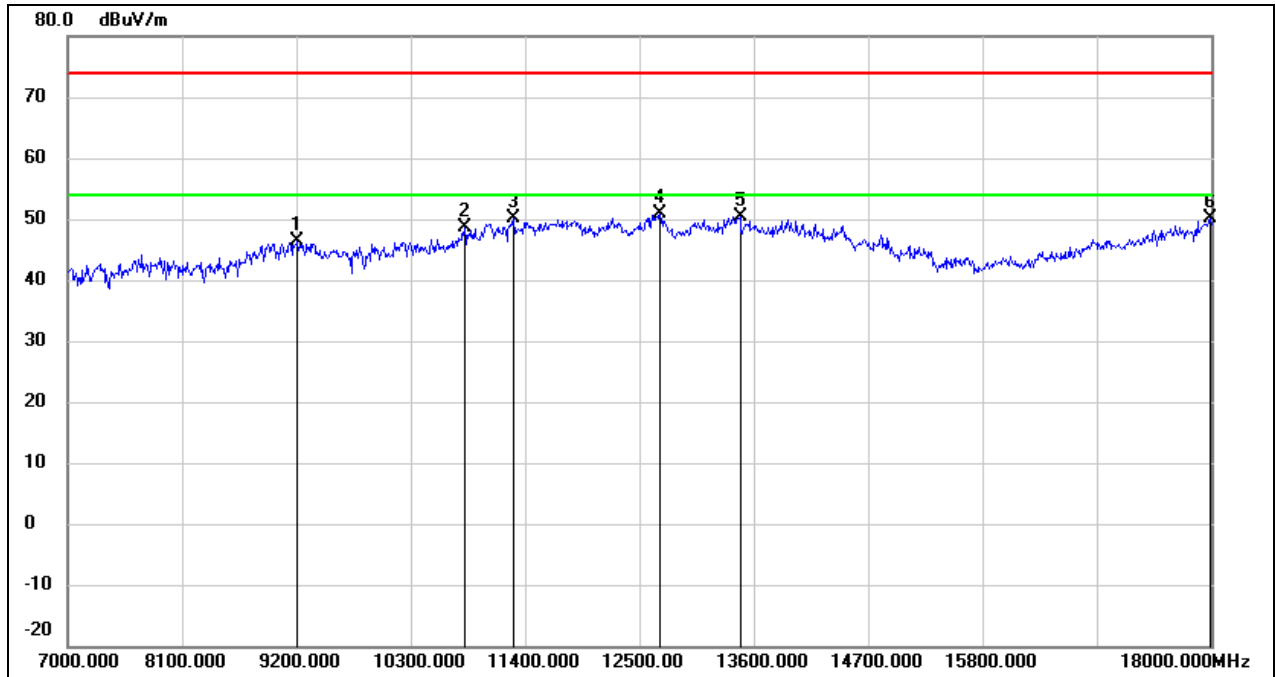

No.	Frequency (MHz)	Reading (dBuV)	Correct (dB/m)	Result (dBuV/m)	Limit (dBuV/m)	Margin (dB)	Remark
1	9211.000	35.96	10.47	46.43	74.00	-27.57	peak
2	10817.000	34.54	14.03	48.57	74.00	-25.43	peak
3	11290.000	34.22	15.90	50.12	74.00	-23.88	peak
4	12698.000	32.85	18.08	50.93	74.00	-23.07	peak
5	13468.000	29.87	20.50	50.37	74.00	-23.63	peak
6	17989.000	24.11	26.04	50.15	74.00	-23.85	peak

Test Mode:	802.11ax HE20	Channel:	5180
Polarity:	Horizontal	Test Voltage:	DC 12 V

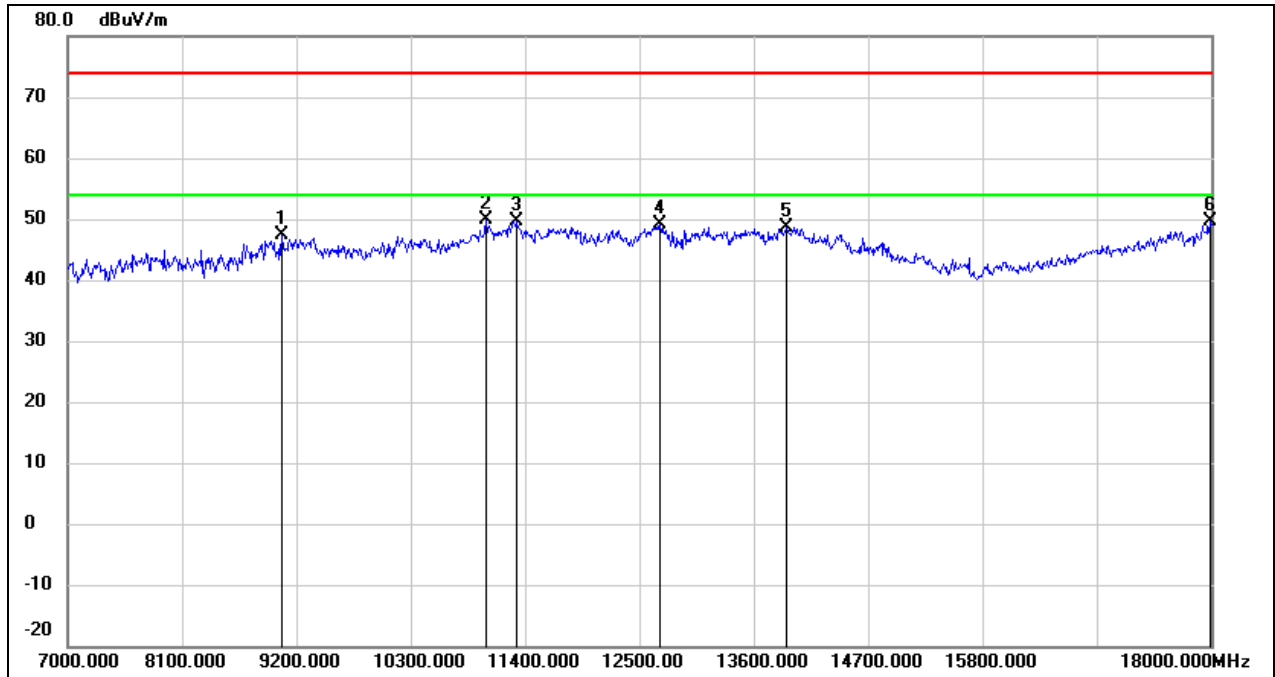

No.	Frequency (MHz)	Reading (dBuV)	Correct (dB/m)	Result (dBuV/m)	Limit (dBuV/m)	Margin (dB)	Remark
1	9057.000	36.92	10.38	47.30	74.00	-26.70	peak
2	11026.000	35.18	14.82	50.00	74.00	-24.00	peak
3	11323.000	33.63	16.05	49.68	74.00	-24.32	peak
4	12698.000	31.08	18.08	49.16	74.00	-24.84	peak
5	13919.000	26.91	21.68	48.59	74.00	-25.41	peak
6	17989.000	23.69	26.04	49.73	74.00	-24.27	peak

Test Mode:	802.11ax HE20	Channel:	5180
Polarity:	Vertical	Test Voltage:	DC 12 V

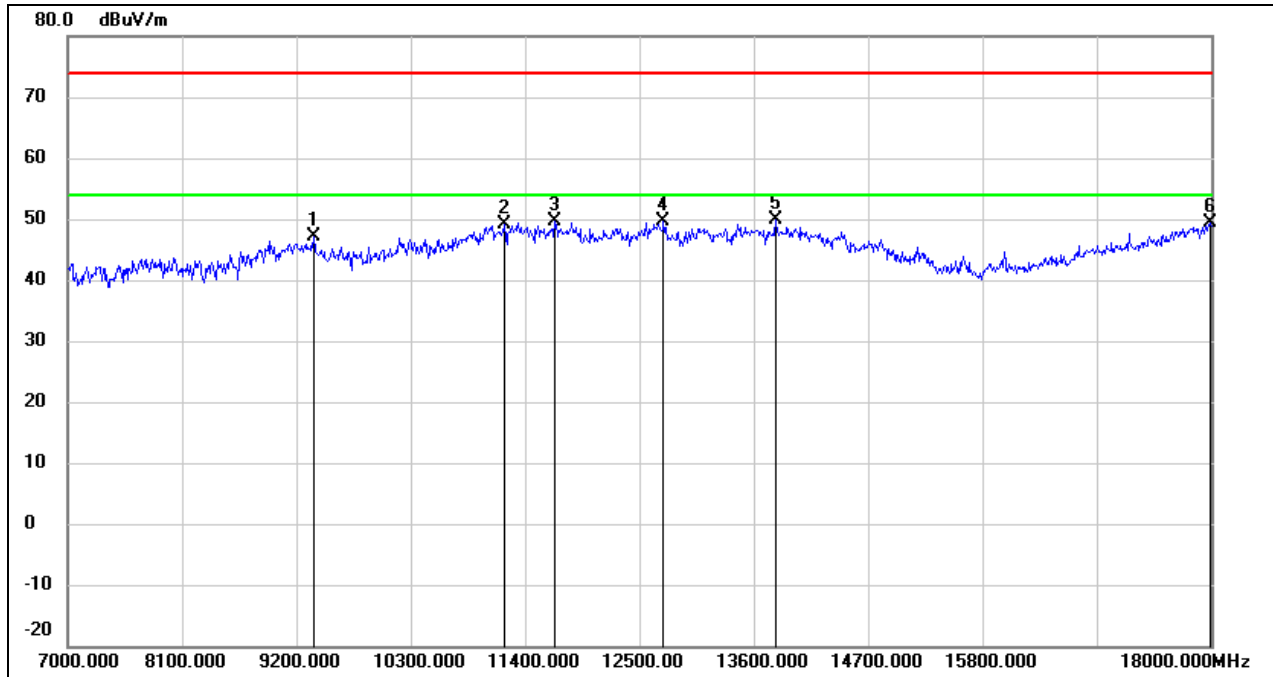

No.	Frequency (MHz)	Reading (dBuV)	Correct (dB/m)	Result (dBuV/m)	Limit (dBuV/m)	Margin (dB)	Remark
1	9365.000	36.58	10.57	47.15	74.00	-26.85	peak
2	11202.000	33.53	15.55	49.08	74.00	-24.92	peak
3	11686.000	32.46	17.12	49.58	74.00	-24.42	peak
4	12731.000	31.55	18.12	49.67	74.00	-24.33	peak
5	13809.000	28.38	21.41	49.79	74.00	-24.21	peak
6	17989.000	23.39	26.04	49.43	74.00	-24.57	peak

Test Mode:	802.11ax HE20	Channel:	5200
Polarity:	Horizontal	Test Voltage:	DC 12 V

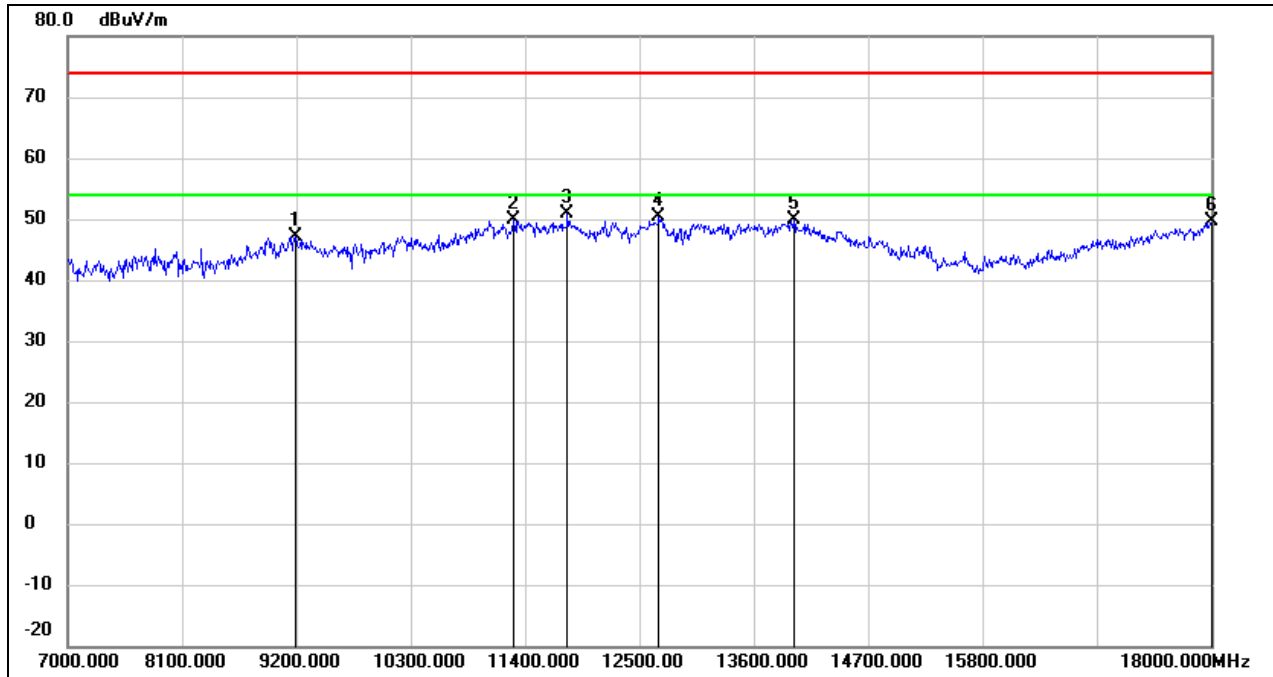

No.	Frequency (MHz)	Reading (dBuV)	Correct (dB/m)	Result (dBuV/m)	Limit (dBuV/m)	Margin (dB)	Remark
1	9189.000	36.70	10.46	47.16	74.00	-26.84	peak
2	11290.000	33.89	15.90	49.79	74.00	-24.21	peak
3	11807.000	33.48	17.34	50.82	74.00	-23.18	peak
4	12687.000	32.27	18.05	50.32	74.00	-23.68	peak
5	13985.000	27.95	21.85	49.80	74.00	-24.20	peak
6	18000.000	23.47	26.12	49.59	74.00	-24.41	peak

Test Mode:	802.11ax HE20	Channel:	5200
Polarity:	Vertical	Test Voltage:	DC 12 V

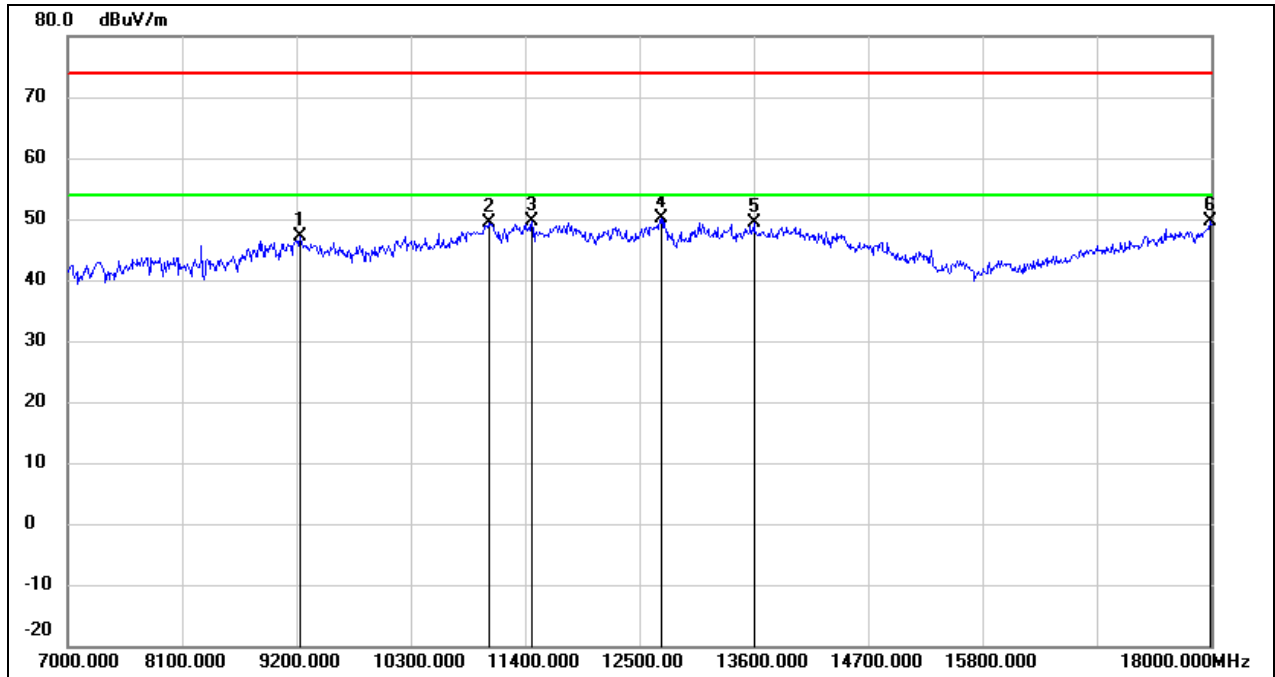

No.	Frequency (MHz)	Reading (dBuV)	Correct (dB/m)	Result (dBuV/m)	Limit (dBuV/m)	Margin (dB)	Remark
1	9233.000	36.61	10.48	47.09	74.00	-26.91	peak
2	11048.000	34.44	14.91	49.35	74.00	-24.65	peak
3	11466.000	32.90	16.63	49.53	74.00	-24.47	peak
4	12709.000	32.10	18.09	50.19	74.00	-23.81	peak
5	13600.000	28.58	20.89	49.47	74.00	-24.53	peak
6	17989.000	23.63	26.04	49.67	74.00	-24.33	peak

Test Mode:	802.11ax HE20	Channel:	5240
Polarity:	Horizontal	Test Voltage:	DC 12 V

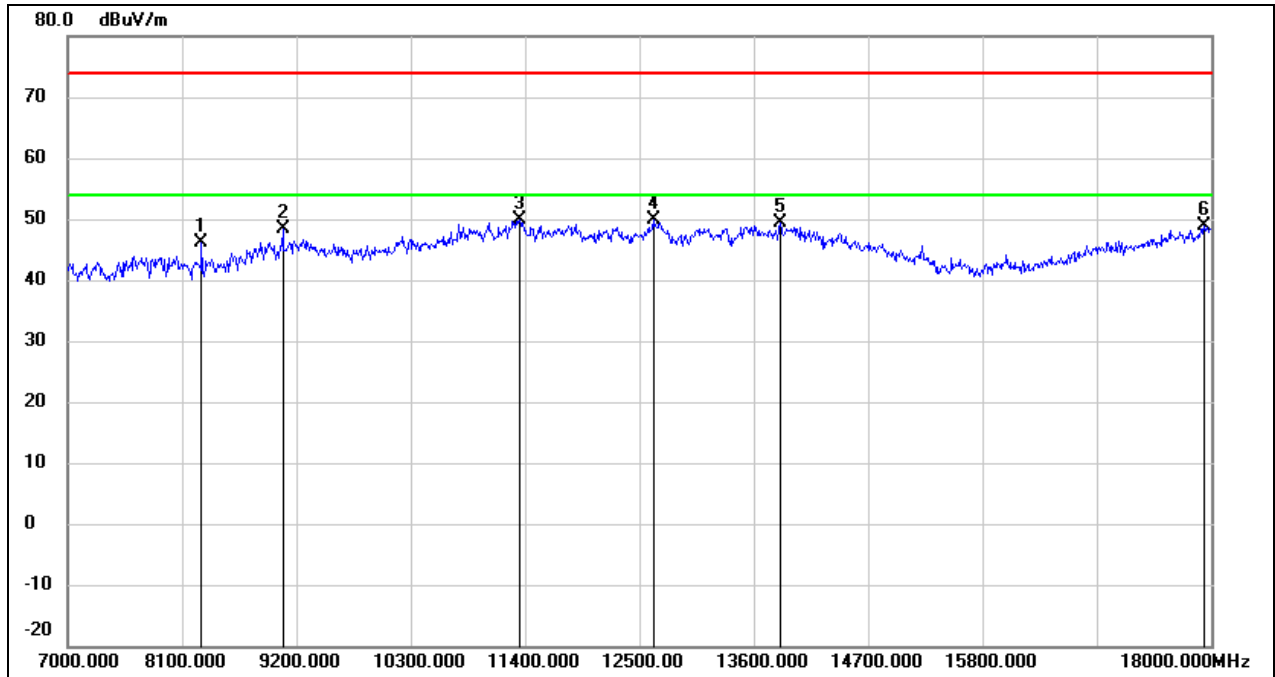

No.	Frequency (MHz)	Reading (dBuV)	Correct (dB/m)	Result (dBuV/m)	Limit (dBuV/m)	Margin (dB)	Remark
1	8287.000	39.39	6.70	46.09	74.00	-27.91	peak
2	9068.000	38.02	10.39	48.41	74.00	-25.59	peak
3	11345.000	33.63	16.14	49.77	74.00	-24.23	peak
4	12632.000	31.89	17.99	49.88	74.00	-24.12	peak
5	13853.000	27.76	21.52	49.28	74.00	-24.72	peak
6	17934.000	23.13	25.67	48.80	74.00	-25.20	peak

Test Mode:	802.11ax HE20	Channel:	5240
Polarity:	Vertical	Test Voltage:	DC 12 V

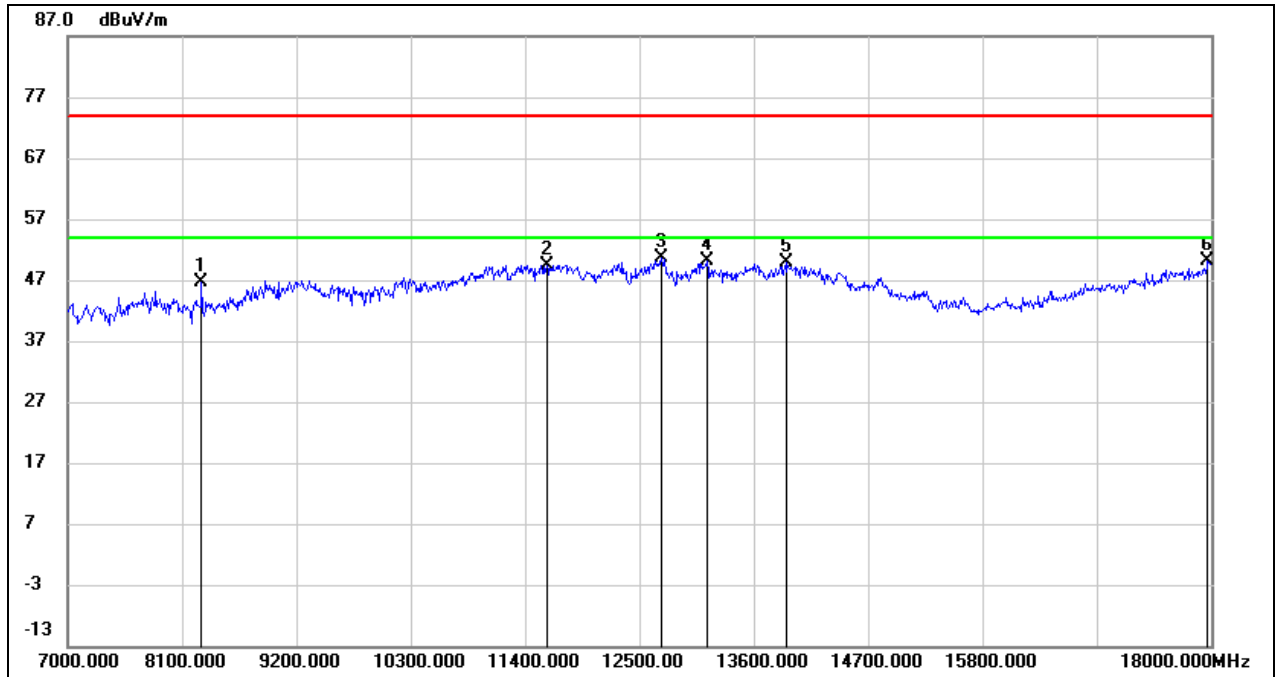

No.	Frequency (MHz)	Reading (dBuV)	Correct (dB/m)	Result (dBuV/m)	Limit (dBuV/m)	Margin (dB)	Remark
1	8287.000	39.92	6.70	46.62	74.00	-27.38	peak
2	11609.000	32.50	16.98	49.48	74.00	-24.52	peak
3	12709.000	32.49	18.09	50.58	74.00	-23.42	peak
4	13149.000	31.04	19.10	50.14	74.00	-23.86	peak
5	13919.000	28.28	21.68	49.96	74.00	-24.04	peak
6	17967.000	24.15	25.89	50.04	74.00	-23.96	peak



Test Mode:	802.11ax HE40	Channel:	5190
Polarity:	Horizontal	Test Voltage:	DC 12 V

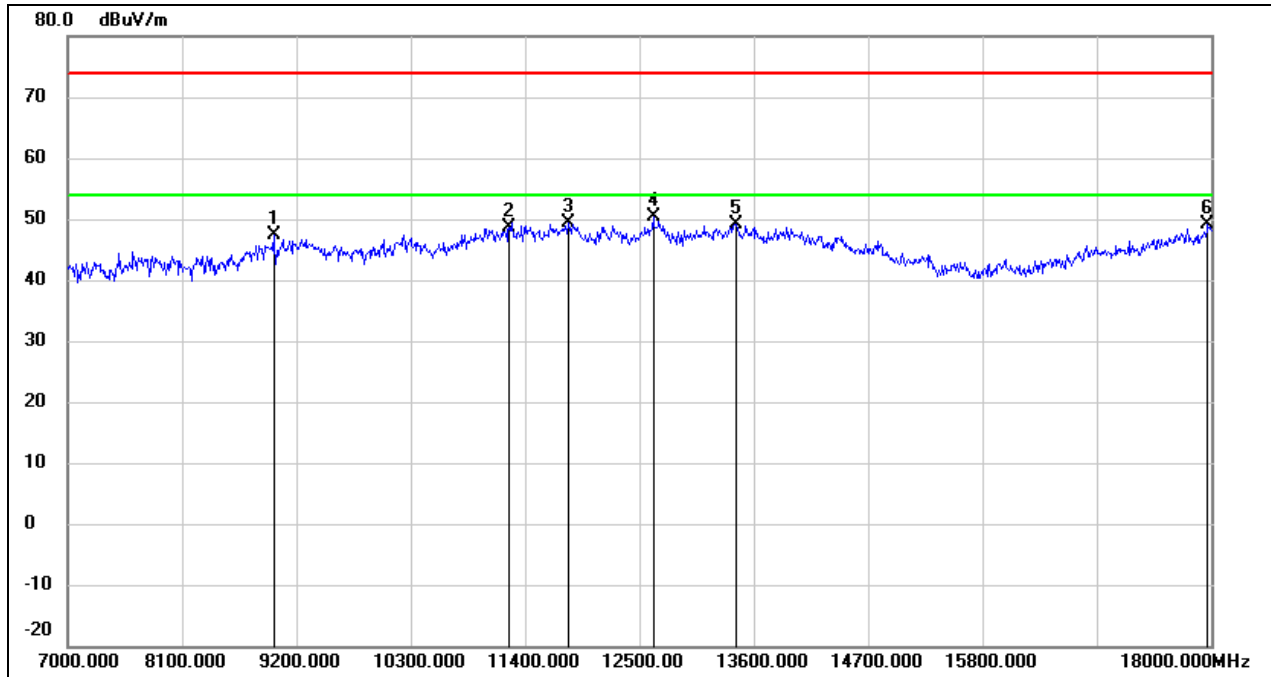

No.	Frequency (MHz)	Reading (dBuV)	Correct (dB/m)	Result (dBuV/m)	Limit (dBuV/m)	Margin (dB)	Remark
1	8980.000	37.16	10.21	47.37	74.00	-26.63	peak
2	11246.000	33.00	15.73	48.73	74.00	-25.27	peak
3	11818.000	31.91	17.36	49.27	74.00	-24.73	peak
4	12632.000	32.27	17.99	50.26	74.00	-23.74	peak
5	13435.000	28.81	20.35	49.16	74.00	-24.84	peak
6	17967.000	23.13	25.89	49.02	74.00	-24.98	peak

Test Mode:	802.11ax HE40	Channel:	5190
Polarity:	Vertical	Test Voltage:	DC 12 V

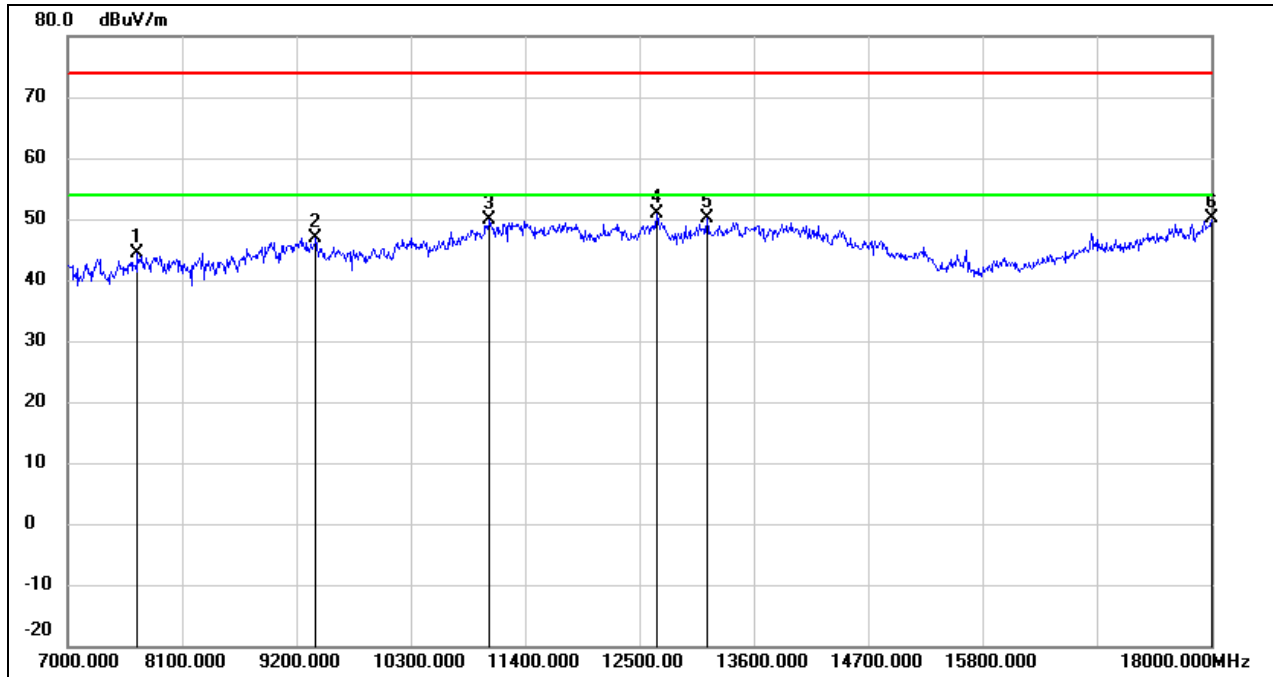

No.	Frequency (MHz)	Reading (dBuV)	Correct (dB/m)	Result (dBuV/m)	Limit (dBuV/m)	Margin (dB)	Remark
1	7671.000	37.60	6.71	44.31	74.00	-29.69	peak
2	9387.000	36.26	10.58	46.84	74.00	-27.16	peak
3	11059.000	34.89	14.96	49.85	74.00	-24.15	peak
4	12665.000	32.72	18.04	50.76	74.00	-23.24	peak
5	13149.000	31.07	19.10	50.17	74.00	-23.83	peak
6	18000.000	23.90	26.12	50.02	74.00	-23.98	peak

Test Mode:	802.11ax HE40	Channel:	5230
Polarity:	Horizontal	Test Voltage:	DC 12 V

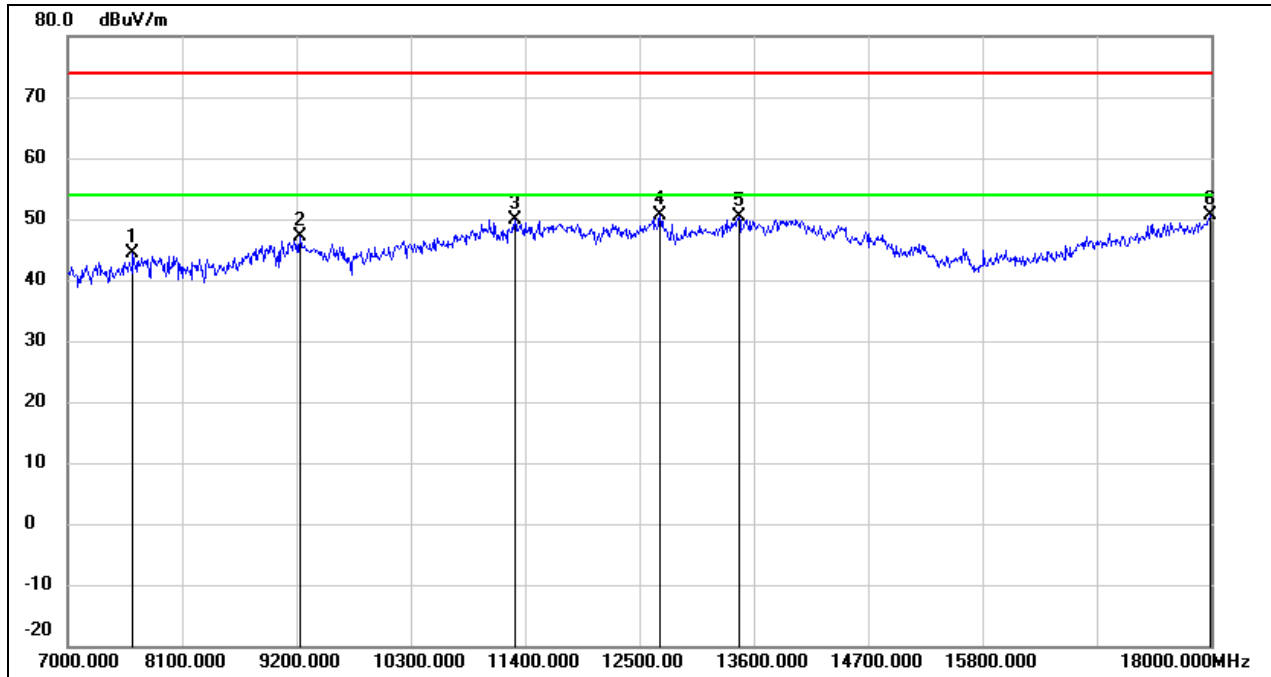

No.	Frequency (MHz)	Reading (dBuV)	Correct (dB/m)	Result (dBuV/m)	Limit (dBuV/m)	Margin (dB)	Remark
1	7627.000	37.56	6.76	44.32	74.00	-29.68	peak
2	9233.000	36.53	10.48	47.01	74.00	-26.99	peak
3	11301.000	33.99	15.95	49.94	74.00	-24.06	peak
4	12698.000	32.49	18.08	50.57	74.00	-23.43	peak
5	13457.000	29.83	20.46	50.29	74.00	-23.71	peak
6	17989.000	24.59	26.04	50.63	74.00	-23.37	peak

Test Mode:	802.11ax HE40	Channel:	5230
Polarity:	Vertical	Test Voltage:	DC 12 V

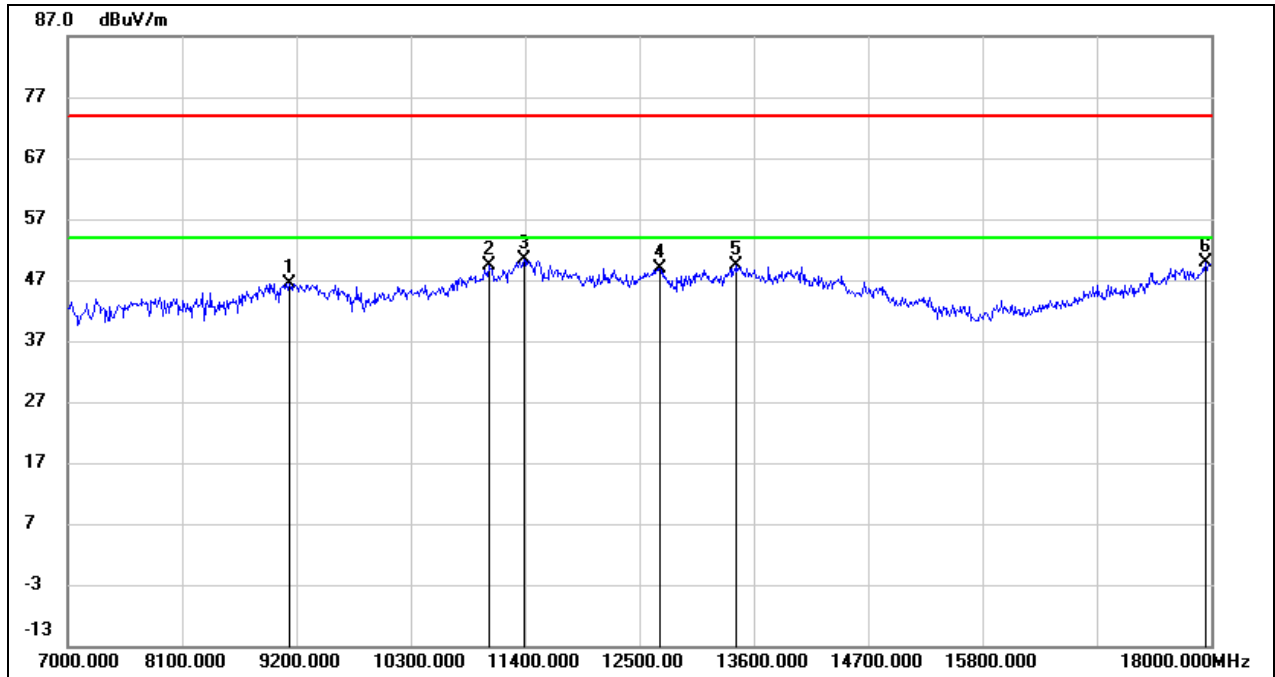

No.	Frequency (MHz)	Reading (dBuV)	Correct (dB/m)	Result (dBuV/m)	Limit (dBuV/m)	Margin (dB)	Remark
1	9134.000	36.07	10.41	46.48	74.00	-27.52	peak
2	11048.000	34.56	14.91	49.47	74.00	-24.53	peak
3	11389.000	34.03	16.31	50.34	74.00	-23.66	peak
4	12698.000	30.86	18.08	48.94	74.00	-25.06	peak
5	13435.000	29.04	20.35	49.39	74.00	-24.61	peak
6	17945.000	24.23	25.75	49.98	74.00	-24.02	peak

Test Mode:	802.11ax HE80	Channel:	5210
Polarity:	Horizontal	Test Voltage:	DC 12 V

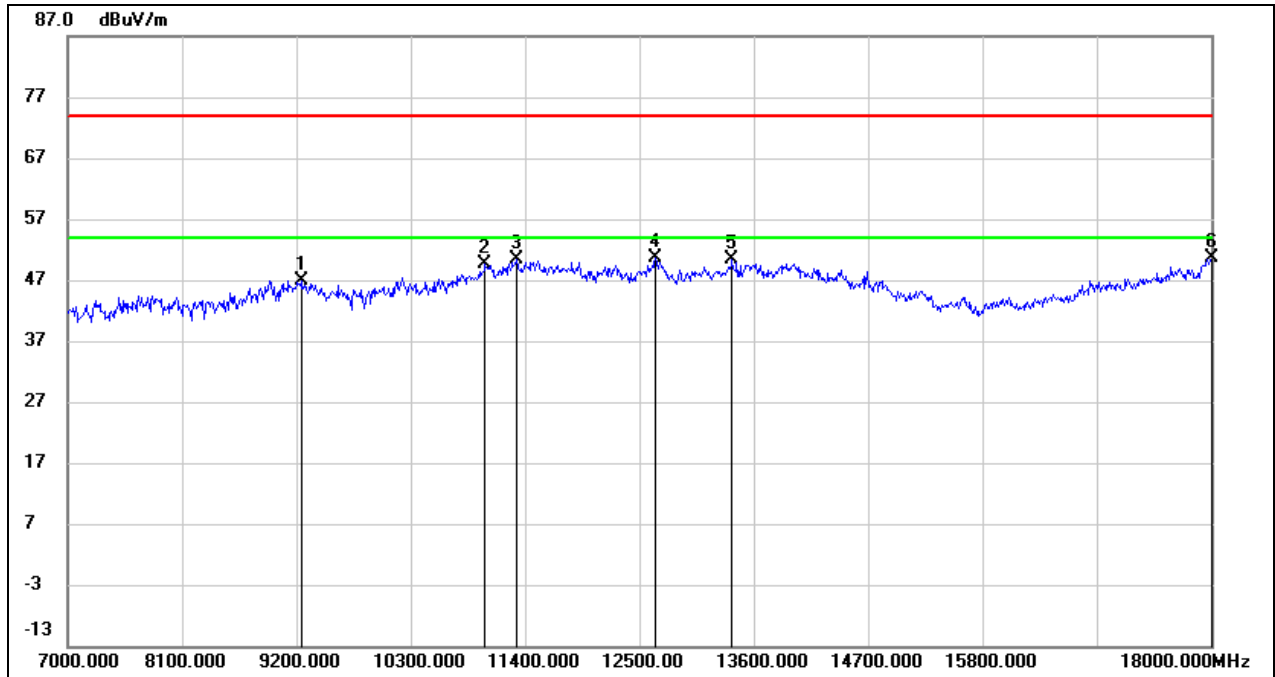

No.	Frequency (MHz)	Reading (dBuV)	Correct (dB/m)	Result (dBuV/m)	Limit (dBuV/m)	Margin (dB)	Remark
1	9244.000	36.48	10.49	46.97	74.00	-27.03	peak
2	11015.000	34.76	14.79	49.55	74.00	-24.45	peak
3	11323.000	34.37	16.05	50.42	74.00	-23.58	peak
4	12654.000	32.58	18.01	50.59	74.00	-23.41	peak
5	13391.000	30.29	20.16	50.45	74.00	-23.55	peak
6	18000.000	24.47	26.12	50.59	74.00	-23.41	peak

Test Mode:	802.11ax HE80	Channel:	5210
Polarity:	Vertical	Test Voltage:	DC 12 V

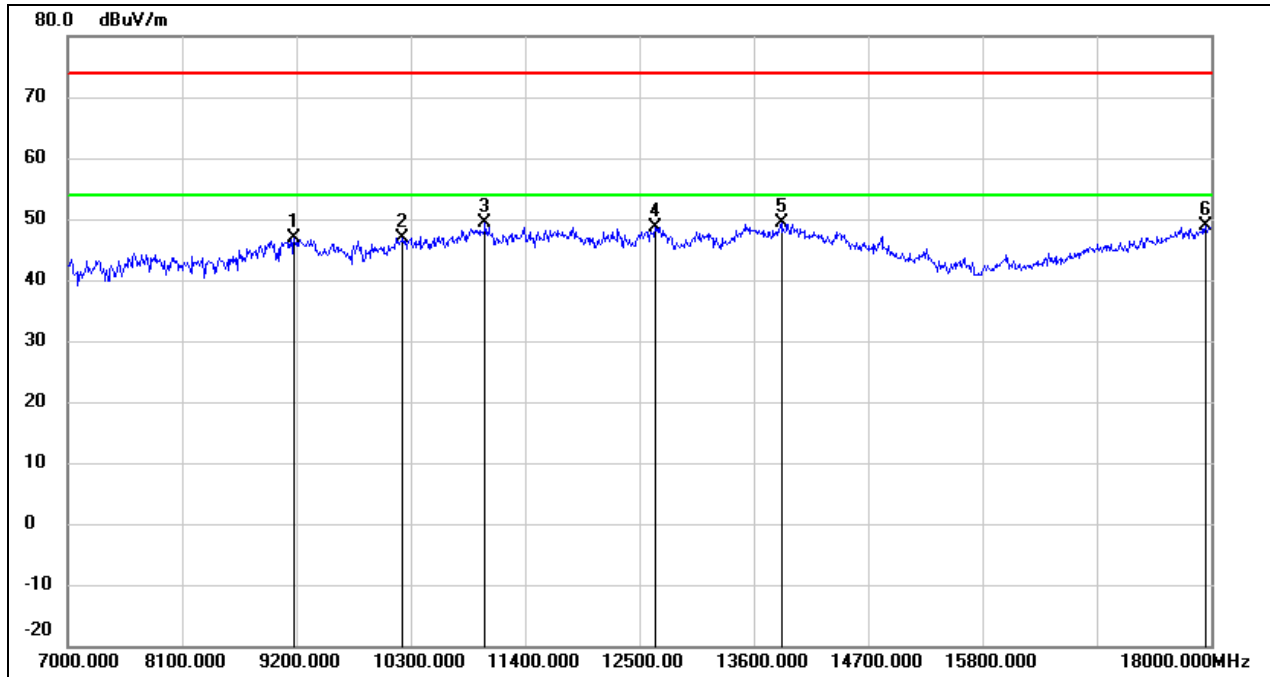

No.	Frequency (MHz)	Reading (dBuV)	Correct (dB/m)	Result (dBuV/m)	Limit (dBuV/m)	Margin (dB)	Remark
1	9178.000	36.40	10.45	46.85	74.00	-27.15	peak
2	10223.000	34.72	12.24	46.96	74.00	-27.04	peak
3	11015.000	34.49	14.79	49.28	74.00	-24.72	peak
4	12654.000	30.58	18.01	48.59	74.00	-25.41	peak
5	13864.000	27.79	21.53	49.32	74.00	-24.68	peak
6	17945.000	23.23	25.75	48.98	74.00	-25.02	peak

Test Mode:	802.11be EHT20	Channel:	5180
Polarity:	Horizontal	Test Voltage:	DC 12 V

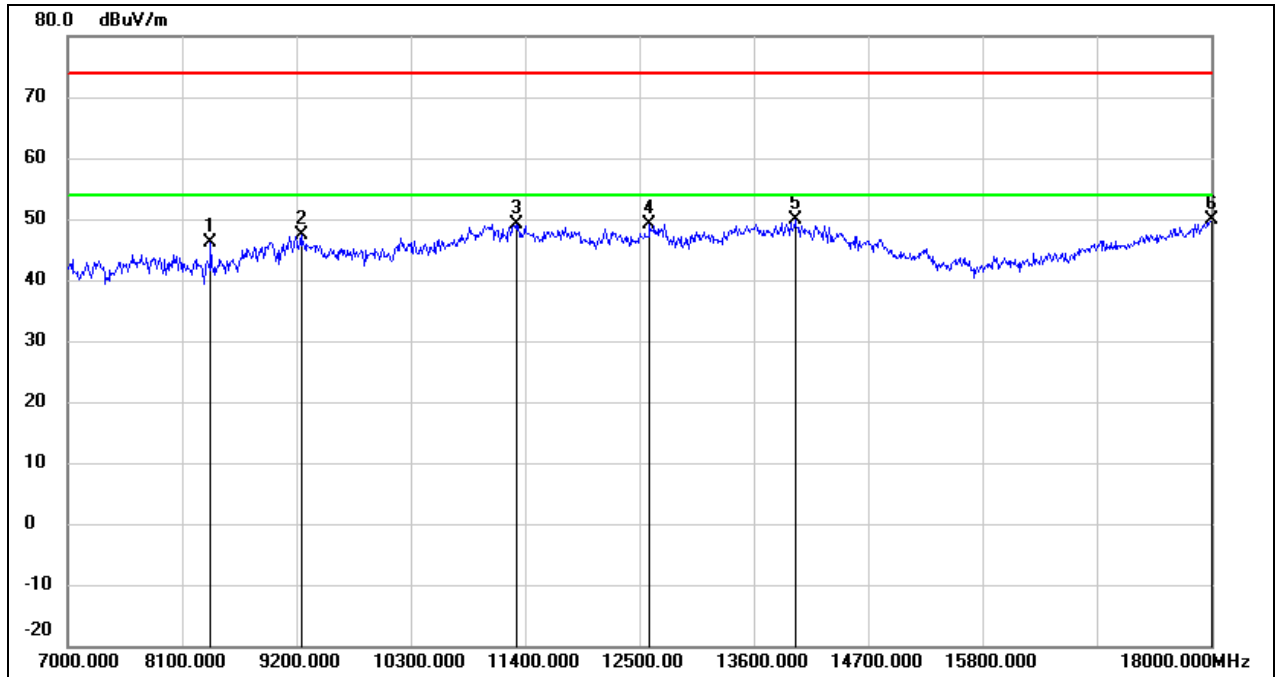

No.	Frequency (MHz)	Reading (dBuV)	Correct (dB/m)	Result (dBuV/m)	Limit (dBuV/m)	Margin (dB)	Remark
1	8375.000	39.32	6.77	46.09	74.00	-27.91	peak
2	9244.000	36.98	10.49	47.47	74.00	-26.53	peak
3	11323.000	33.19	16.05	49.24	74.00	-24.76	peak
4	12599.000	31.11	17.95	49.06	74.00	-24.94	peak
5	13996.000	28.01	21.87	49.88	74.00	-24.12	peak
6	18000.000	23.64	26.12	49.76	74.00	-24.24	peak

Test Mode:	802.11be EHT20	Channel:	5180
Polarity:	Vertical	Test Voltage:	DC 12 V

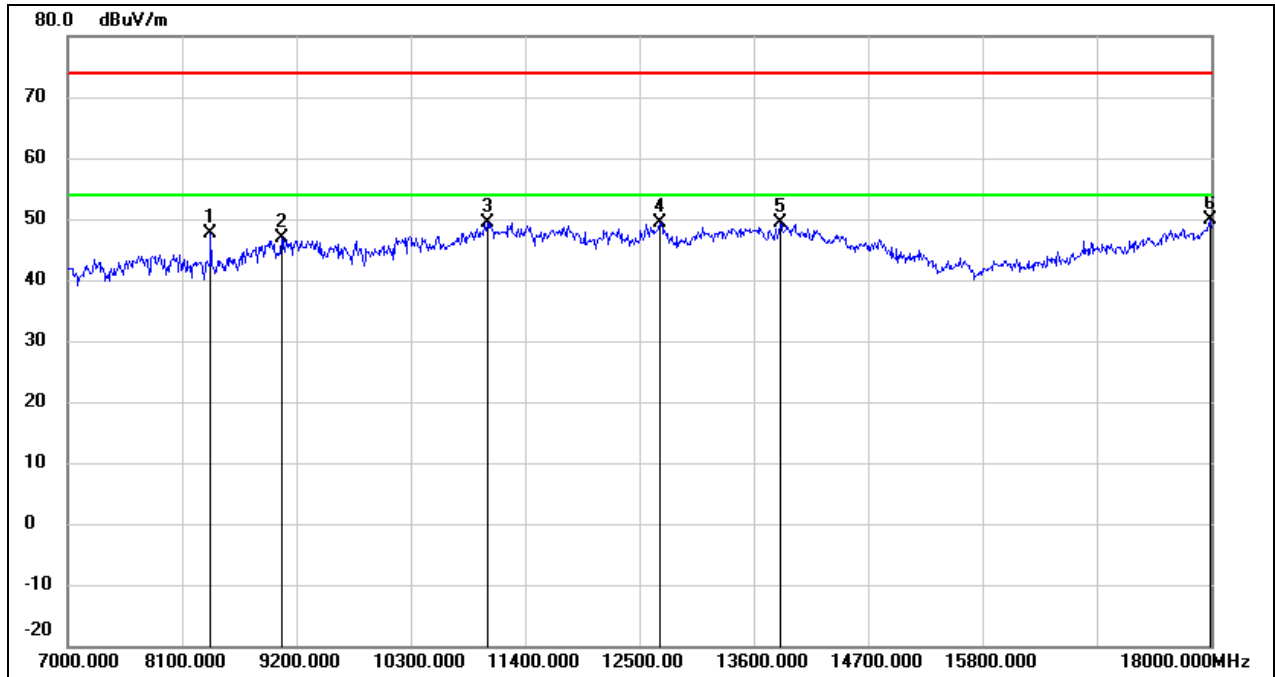

No.	Frequency (MHz)	Reading (dBuV)	Correct (dB/m)	Result (dBuV/m)	Limit (dBuV/m)	Margin (dB)	Remark
1	8375.000	40.98	6.77	47.75	74.00	-26.25	peak
2	9057.000	36.39	10.38	46.77	74.00	-27.23	peak
3	11037.000	34.62	14.87	49.49	74.00	-24.51	peak
4	12698.000	31.24	18.08	49.32	74.00	-24.68	peak
5	13853.000	27.85	21.52	49.37	74.00	-24.63	peak
6	17989.000	23.78	26.04	49.82	74.00	-24.18	peak



Test Mode:	802.11be EHT20	Channel:	5200
Polarity:	Horizontal	Test Voltage:	DC 12 V

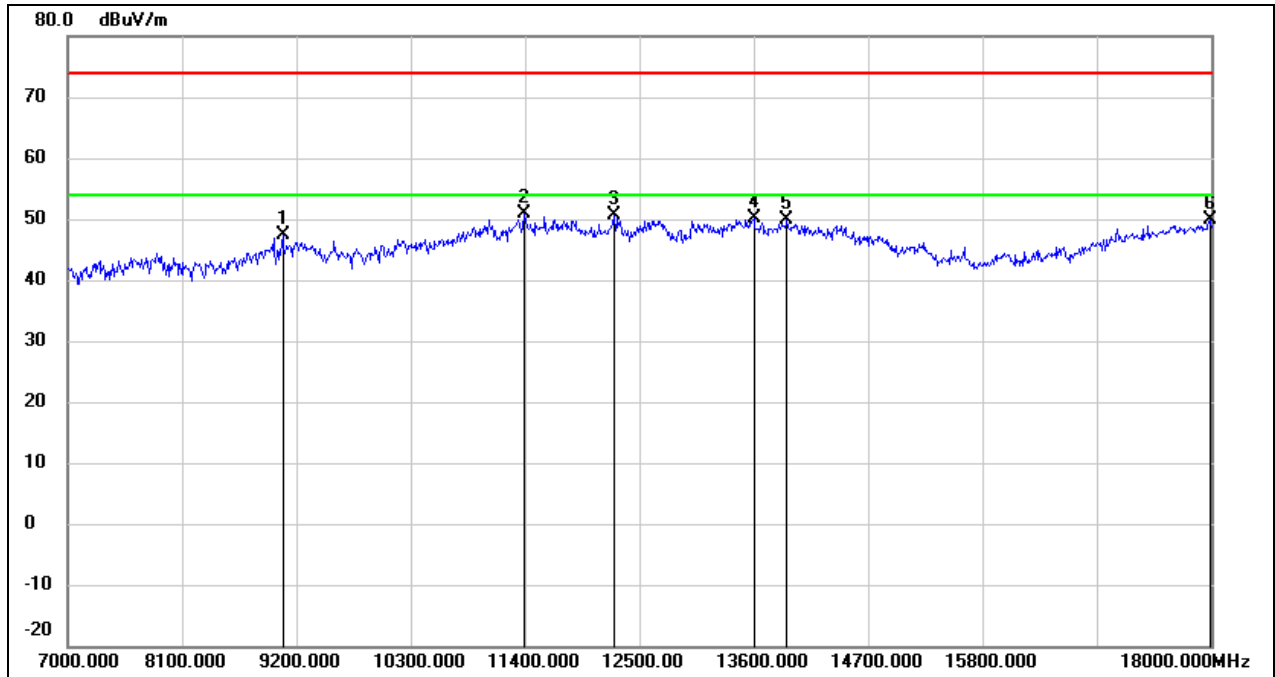

No.	Frequency (MHz)	Reading (dBuV)	Correct (dB/m)	Result (dBuV/m)	Limit (dBuV/m)	Margin (dB)	Remark
1	9068.000	36.99	10.39	47.38	74.00	-26.62	peak
2	11389.000	34.52	16.31	50.83	74.00	-23.17	peak
3	12258.000	32.81	17.77	50.58	74.00	-23.42	peak
4	13600.000	29.14	20.89	50.03	74.00	-23.97	peak
5	13919.000	28.30	21.68	49.98	74.00	-24.02	peak
6	17989.000	23.72	26.04	49.76	74.00	-24.24	peak

Test Mode:	802.11be EHT20	Channel:	5200
Polarity:	Vertical	Test Voltage:	DC 12 V

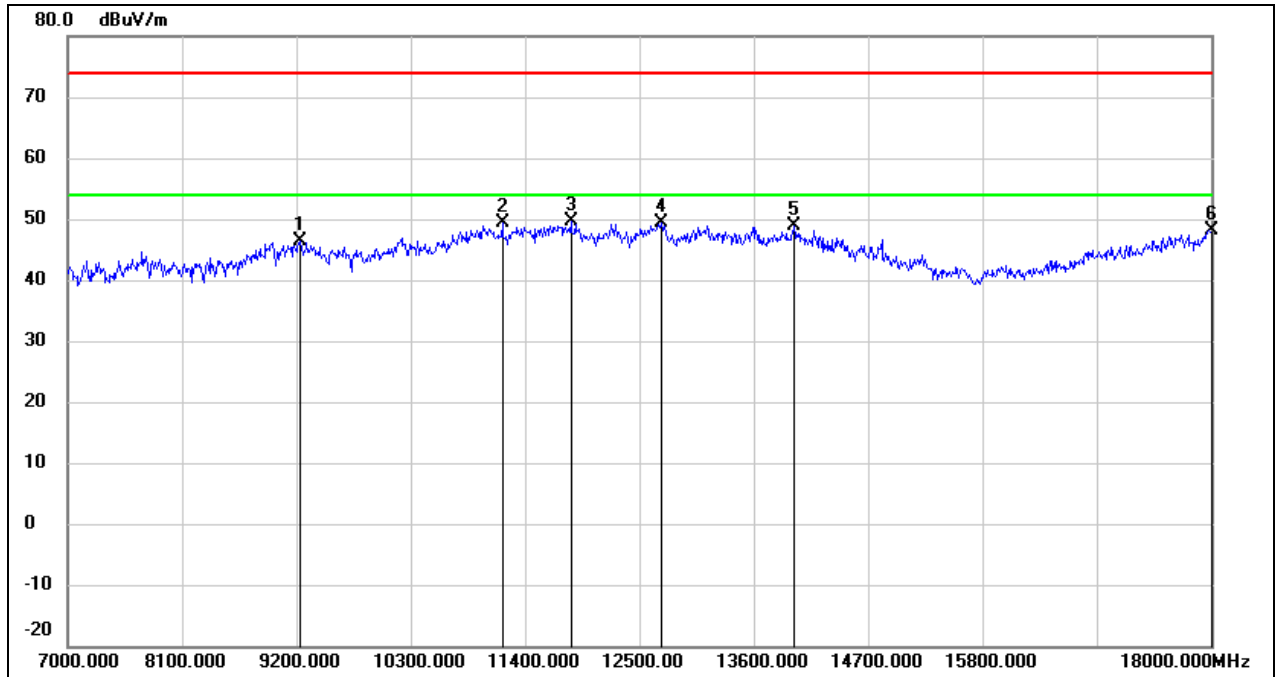

No.	Frequency (MHz)	Reading (dBuV)	Correct (dB/m)	Result (dBuV/m)	Limit (dBuV/m)	Margin (dB)	Remark
1	9233.000	35.82	10.48	46.30	74.00	-27.70	peak
2	11180.000	33.80	15.46	49.26	74.00	-24.74	peak
3	11840.000	32.17	17.40	49.57	74.00	-24.43	peak
4	12709.000	31.21	18.09	49.30	74.00	-24.70	peak
5	13985.000	26.91	21.85	48.76	74.00	-25.24	peak
6	18000.000	22.12	26.12	48.24	74.00	-25.76	peak

Test Mode:	802.11be EHT20	Channel:	5240
Polarity:	Horizontal	Test Voltage:	DC 12 V

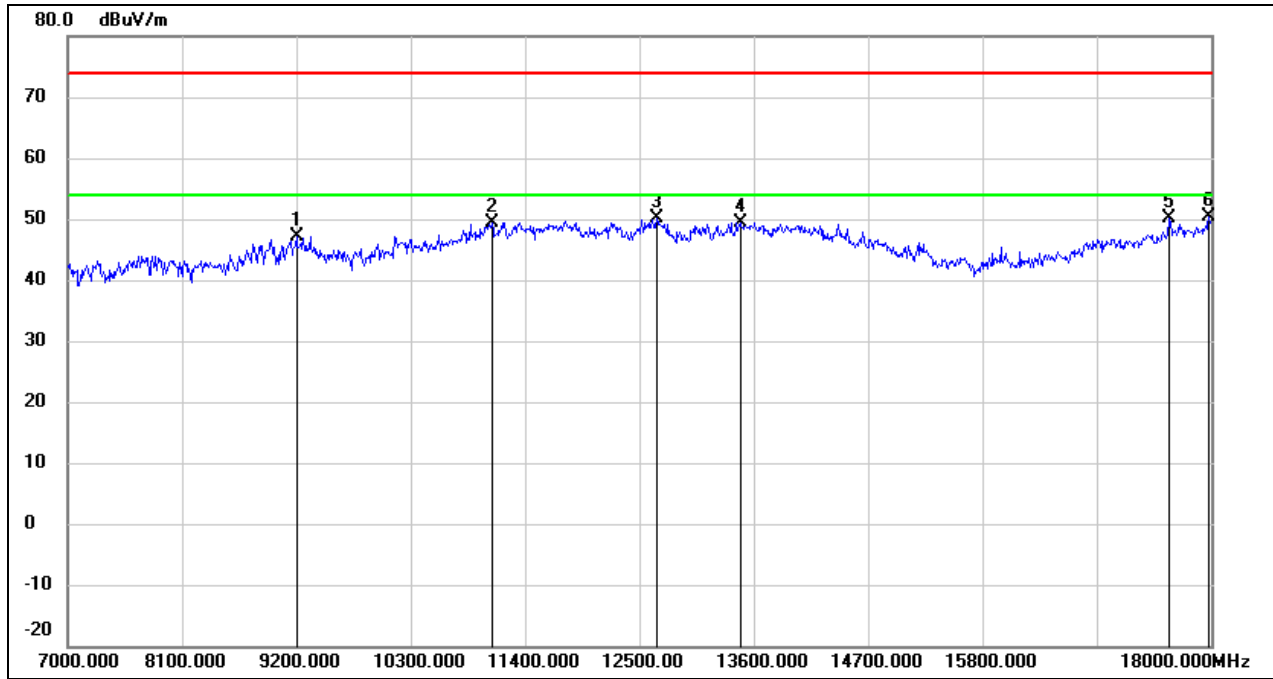

No.	Frequency (MHz)	Reading (dBuV)	Correct (dB/m)	Result (dBuV/m)	Limit (dBuV/m)	Margin (dB)	Remark
1	9200.000	36.74	10.46	47.20	74.00	-26.80	peak
2	11081.000	34.40	15.05	49.45	74.00	-24.55	peak
3	12665.000	32.19	18.04	50.23	74.00	-23.77	peak
4	13468.000	28.98	20.50	49.48	74.00	-24.52	peak
5	17593.000	26.76	23.34	50.10	74.00	-23.90	peak
6	17978.000	24.29	25.97	50.26	74.00	-23.74	peak

Test Mode:	802.11be EHT20	Channel:	5240
Polarity:	Vertical	Test Voltage:	DC 12 V

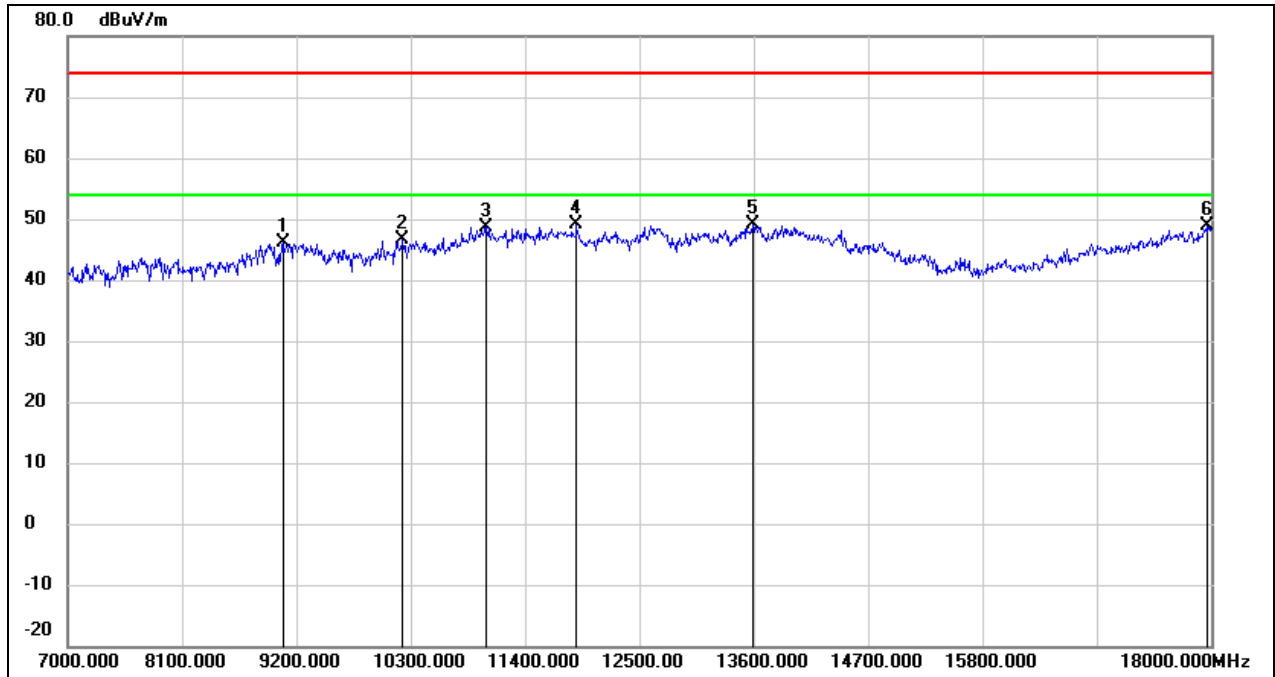

No.	Frequency (MHz)	Reading (dBuV)	Correct (dB/m)	Result (dBuV/m)	Limit (dBuV/m)	Margin (dB)	Remark
1	9068.000	35.72	10.39	46.11	74.00	-27.89	peak
2	10223.000	34.34	12.24	46.58	74.00	-27.42	peak
3	11026.000	33.77	14.82	48.59	74.00	-25.41	peak
4	11895.000	31.70	17.51	49.21	74.00	-24.79	peak
5	13589.000	28.23	20.86	49.09	74.00	-24.91	peak
6	17967.000	23.05	25.89	48.94	74.00	-25.06	peak

Test Mode:	802.11be EHT40	Channel:	5190
Polarity:	Horizontal	Test Voltage:	DC 12 V

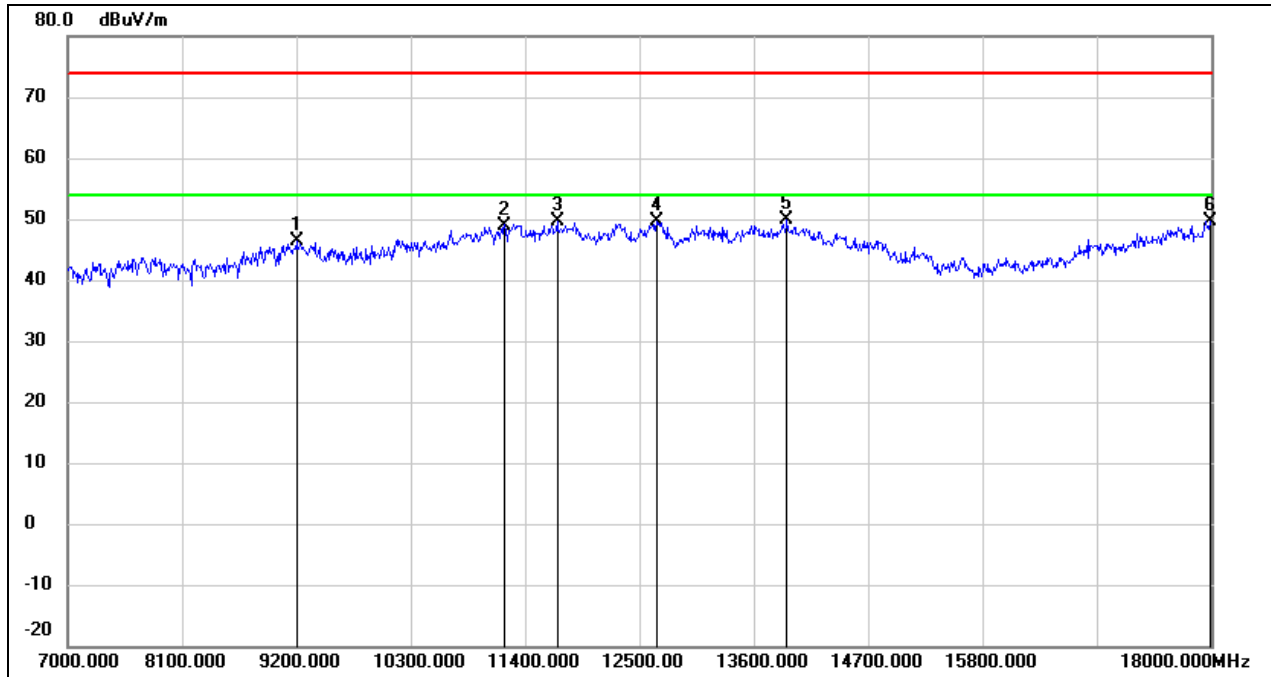

No.	Frequency (MHz)	Reading (dBuV)	Correct (dB/m)	Result (dBuV/m)	Limit (dBuV/m)	Margin (dB)	Remark
1	9200.000	35.81	10.46	46.27	74.00	-27.73	peak
2	11202.000	33.45	15.55	49.00	74.00	-25.00	peak
3	11708.000	32.44	17.16	49.60	74.00	-24.40	peak
4	12665.000	31.53	18.04	49.57	74.00	-24.43	peak
5	13919.000	28.30	21.68	49.98	74.00	-24.02	peak
6	17989.000	23.66	26.04	49.70	74.00	-24.30	peak

Test Mode:	802.11be EHT40	Channel:	5190
Polarity:	Vertical	Test Voltage:	DC 12 V

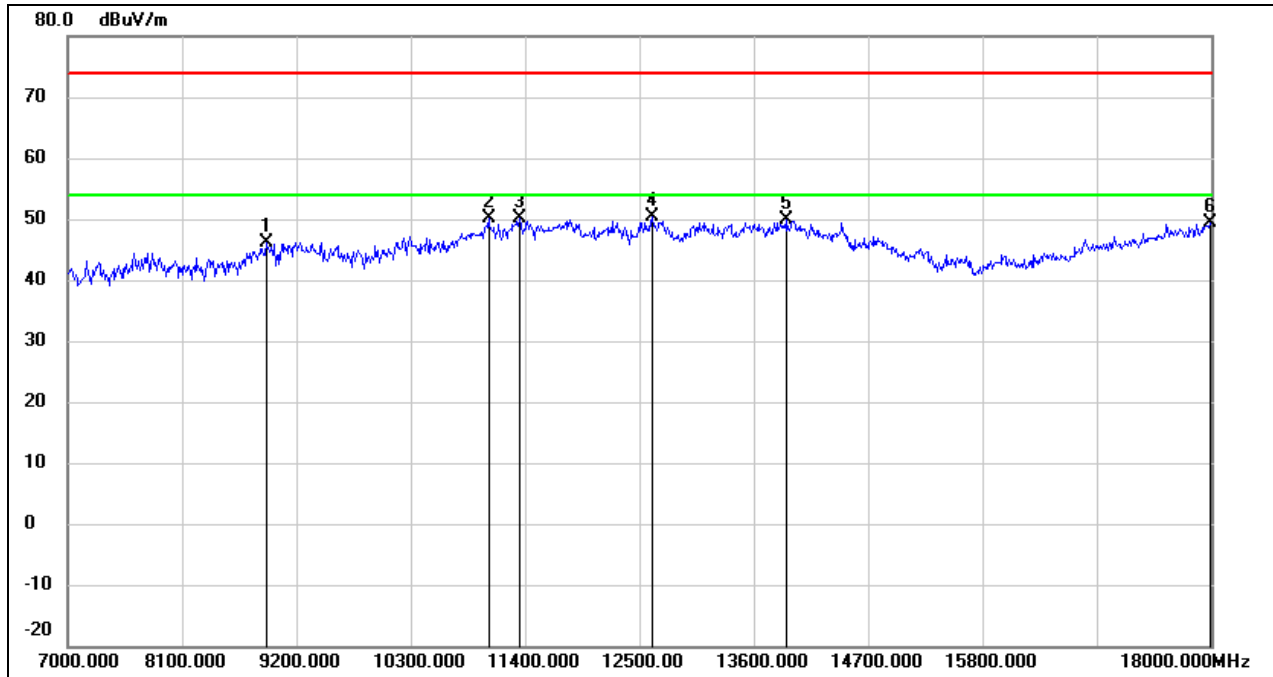

No.	Frequency (MHz)	Reading (dBuV)	Correct (dB/m)	Result (dBuV/m)	Limit (dBuV/m)	Margin (dB)	Remark
1	8914.000	36.34	9.75	46.09	74.00	-27.91	peak
2	11048.000	35.10	14.91	50.01	74.00	-23.99	peak
3	11345.000	33.97	16.14	50.11	74.00	-23.89	peak
4	12621.000	32.42	17.98	50.40	74.00	-23.60	peak
5	13919.000	28.27	21.68	49.95	74.00	-24.05	peak
6	17989.000	23.46	26.04	49.50	74.00	-24.50	peak

Test Mode:	802.11be EHT40	Channel:	5230
Polarity:	Horizontal	Test Voltage:	DC 12 V

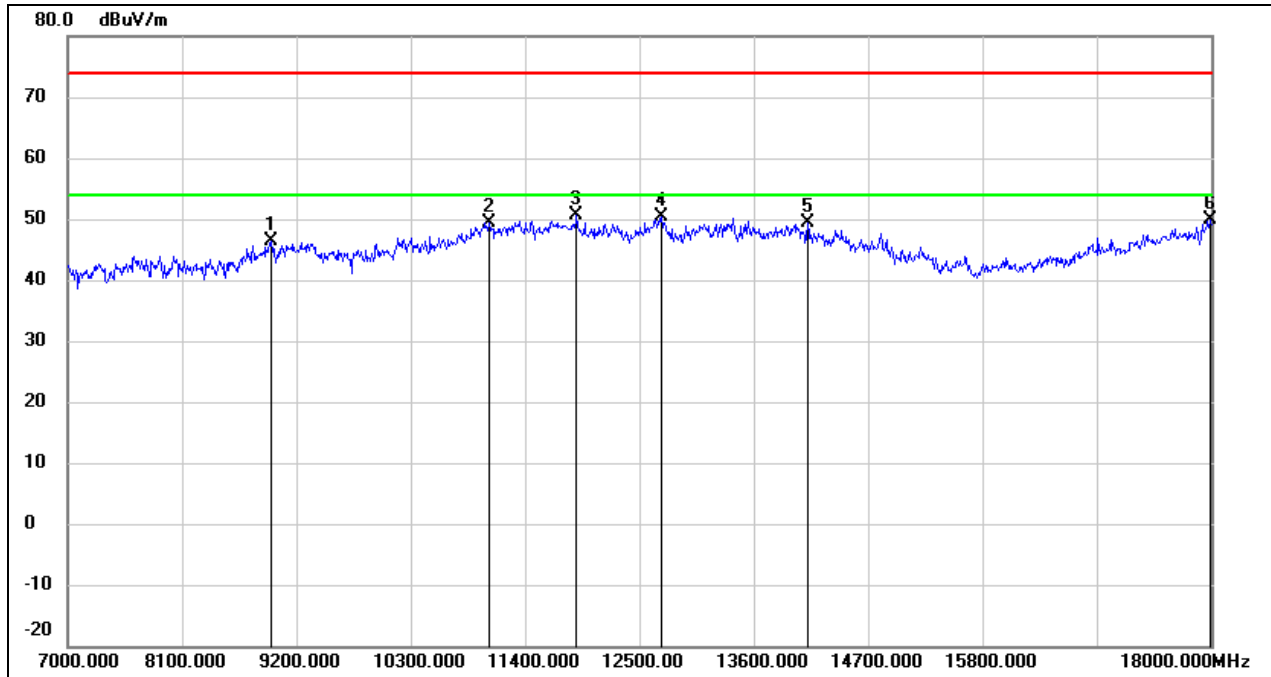

No.	Frequency (MHz)	Reading (dBuV)	Correct (dB/m)	Result (dBuV/m)	Limit (dBuV/m)	Margin (dB)	Remark
1	8958.000	36.21	10.05	46.26	74.00	-27.74	peak
2	11059.000	34.54	14.96	49.50	74.00	-24.50	peak
3	11895.000	33.18	17.51	50.69	74.00	-23.31	peak
4	12709.000	32.27	18.09	50.36	74.00	-23.64	peak
5	14117.000	27.87	21.39	49.26	74.00	-24.74	peak
6	17989.000	23.83	26.04	49.87	74.00	-24.13	peak

Test Mode:	802.11be EHT40	Channel:	5230
Polarity:	Vertical	Test Voltage:	DC 12 V

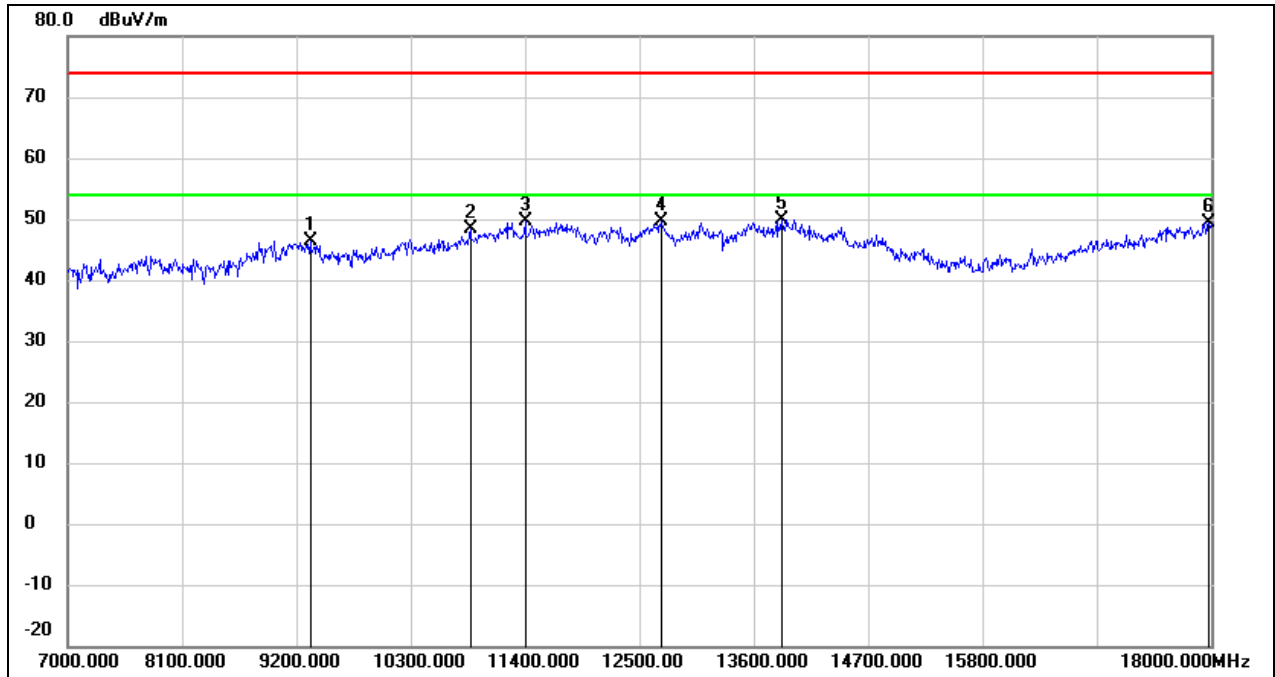

No.	Frequency (MHz)	Reading (dBuV)	Correct (dB/m)	Result (dBuV/m)	Limit (dBuV/m)	Margin (dB)	Remark
1	9332.000	35.80	10.54	46.34	74.00	-27.66	peak
2	10872.000	34.03	14.23	48.26	74.00	-25.74	peak
3	11400.000	33.20	16.36	49.56	74.00	-24.44	peak
4	12709.000	31.48	18.09	49.57	74.00	-24.43	peak
5	13864.000	28.46	21.53	49.99	74.00	-24.01	peak
6	17978.000	23.50	25.97	49.47	74.00	-24.53	peak



Test Mode:	802.11be EHT80	Channel:	5210
Polarity:	Horizontal	Test Voltage:	DC 12 V

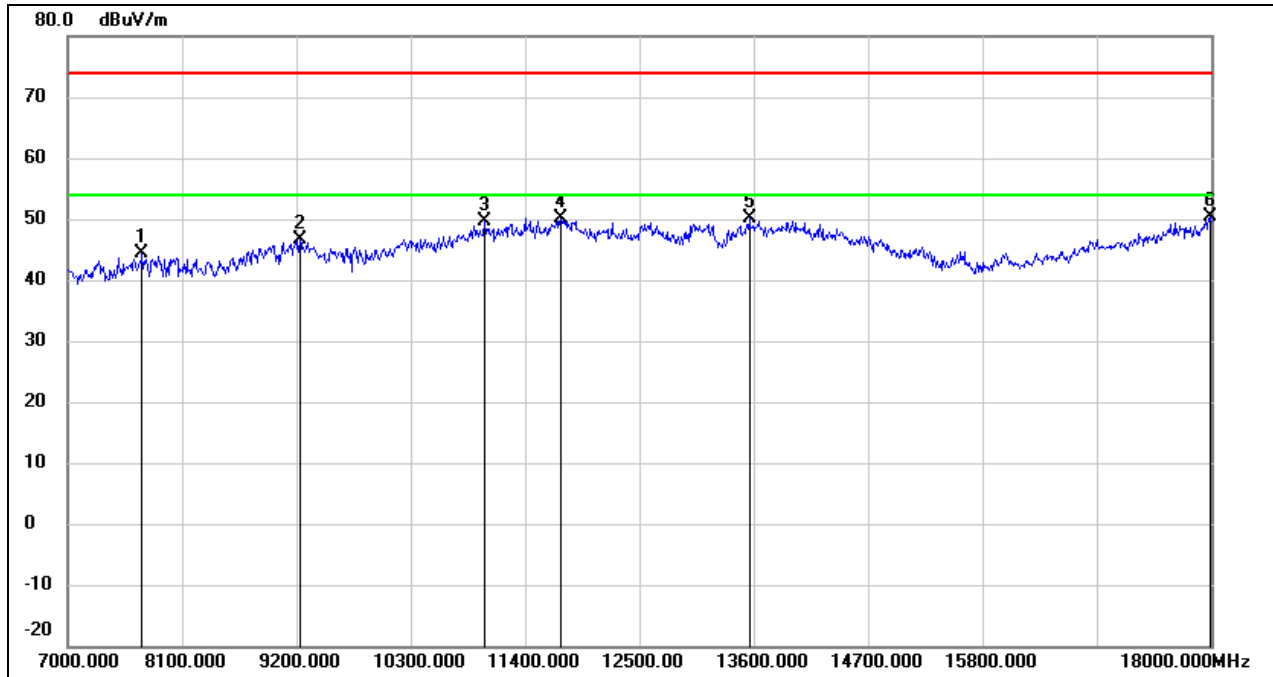

No.	Frequency (MHz)	Reading (dBuV)	Correct (dB/m)	Result (dBuV/m)	Limit (dBuV/m)	Margin (dB)	Remark
1	7715.000	37.70	6.68	44.38	74.00	-29.62	peak
2	9233.000	36.03	10.48	46.51	74.00	-27.49	peak
3	11004.000	34.85	14.74	49.59	74.00	-24.41	peak
4	11741.000	32.79	17.22	50.01	74.00	-23.99	peak
5	13556.000	29.28	20.78	50.06	74.00	-23.94	peak
6	17989.000	24.29	26.04	50.33	74.00	-23.67	peak

Test Mode:	802.11be EHT80	Channel:	5210
Polarity:	Vertical	Test Voltage:	DC 12 V

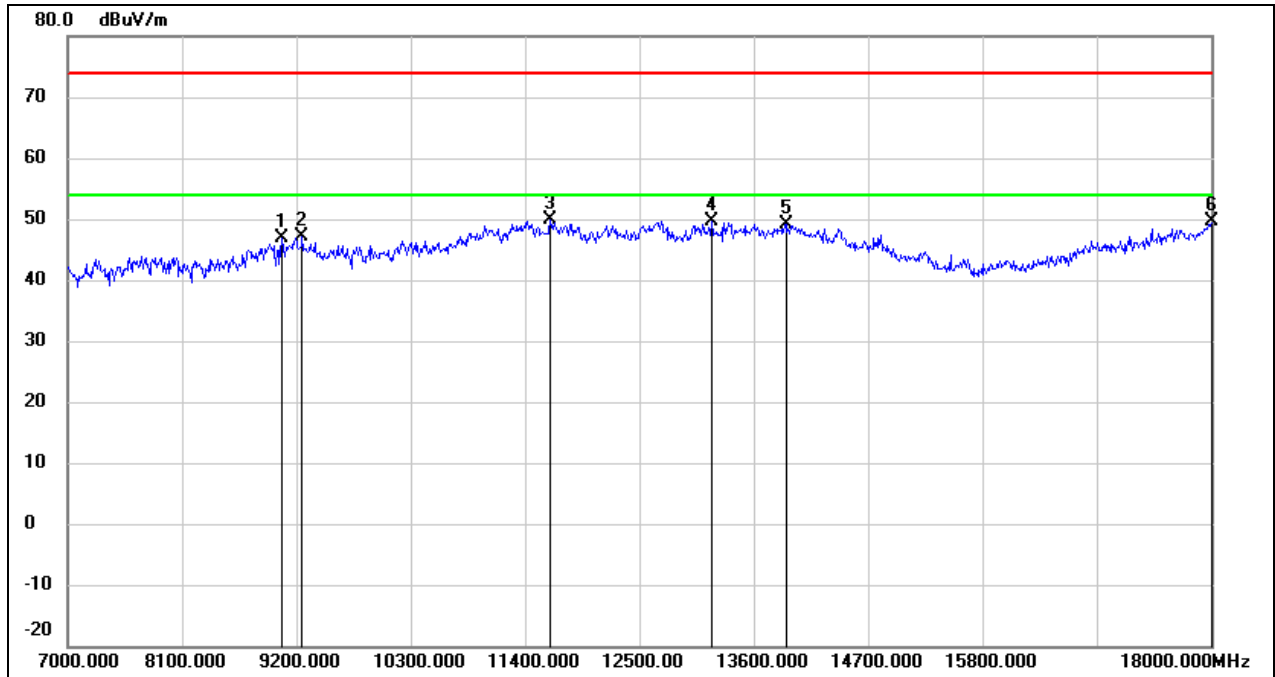

No.	Frequency (MHz)	Reading (dBuV)	Correct (dB/m)	Result (dBuV/m)	Limit (dBuV/m)	Margin (dB)	Remark
1	9057.000	36.51	10.38	46.89	74.00	-27.11	peak
2	9255.000	36.62	10.51	47.13	74.00	-26.87	peak
3	11642.000	32.79	17.03	49.82	74.00	-24.18	peak
4	13193.000	30.39	19.30	49.69	74.00	-24.31	peak
5	13908.000	27.58	21.66	49.24	74.00	-24.76	peak
6	18000.000	23.61	26.12	49.73	74.00	-24.27	peak

### 8.7. SPURIOUS EMISSIONS(9 KHZ~30 MHZ)

Test Mode:	802.11a20	Channel:	5180
Polarity:	Horizontal	Test Voltage:	DC 12 V

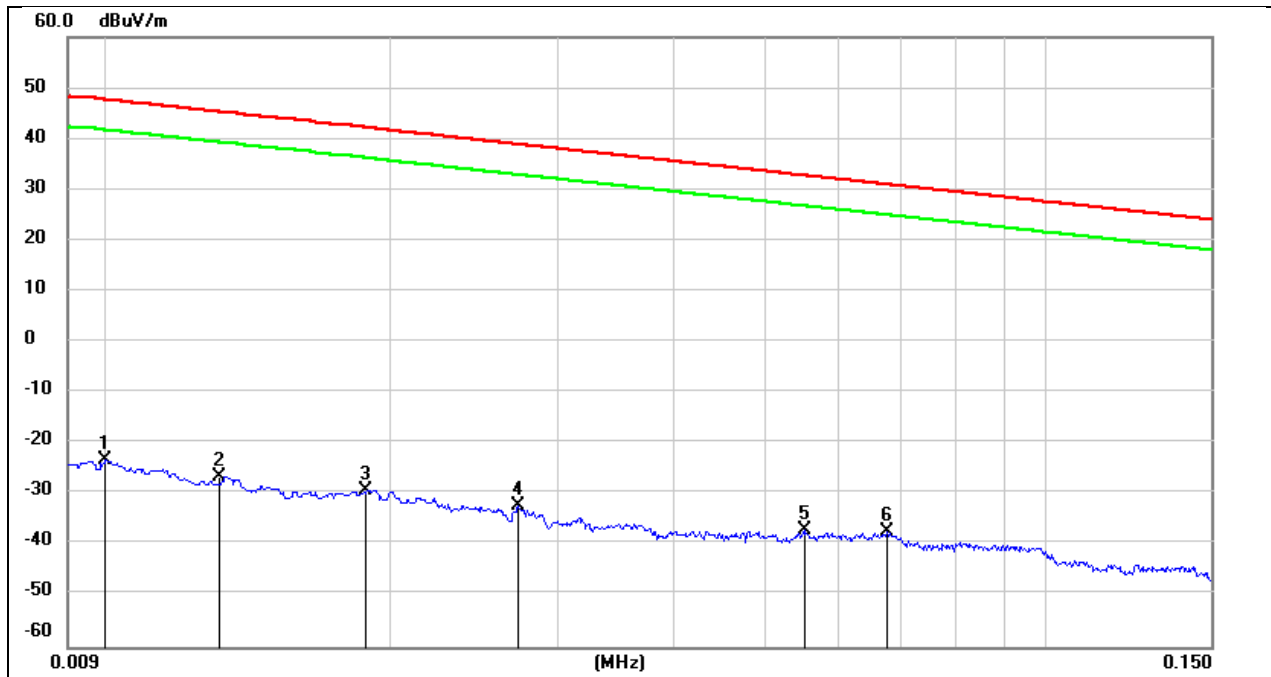

No.	Frequency (MHz)	Reading (dBuV)	Correct (dB/m)	Result (dBuV/m)	Limit (dBuV/m)	Margin (dB)	Remark
1	0.0100	78.22	-101.40	-23.18	47.60	-70.78	peak
2	0.0131	74.97	-101.38	-26.41	45.25	-71.66	peak
3	0.0188	72.14	-101.35	-29.21	42.12	-71.33	peak
4	0.0273	68.99	-101.38	-32.39	38.88	-71.27	peak
5	0.0551	64.45	-101.50	-37.05	32.78	-69.83	peak
6	0.0675	64.14	-101.56	-37.42	31.02	-68.44	peak

Test Mode:	802.11a20	Channel:	5180
Polarity:	Horizontal	Test Voltage:	DC 12 V

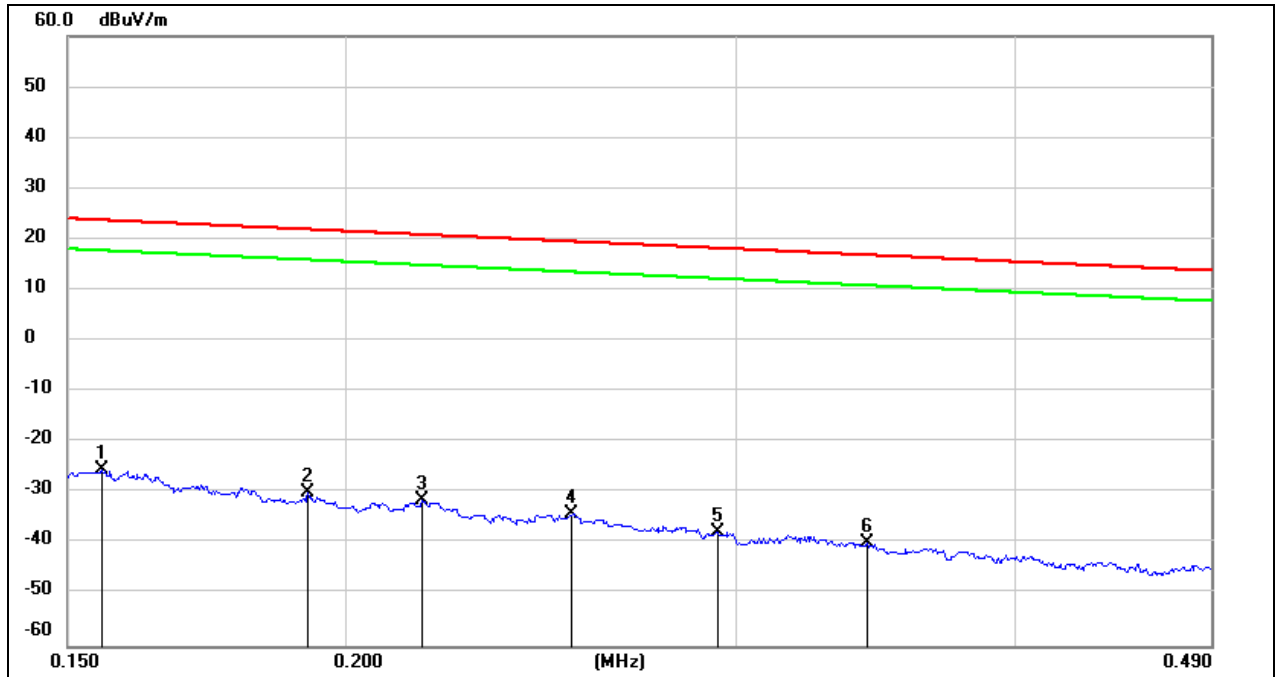

No.	Frequency (MHz)	Reading (dBuV)	Correct (dB/m)	Result (dBuV/m)	Limit (dBuV/m)	Margin (dB)	Remark
1	0.1554	76.27	-101.65	-25.38	23.77	-49.15	peak
2	0.1925	71.96	-101.70	-29.74	21.92	-51.66	peak
3	0.2164	70.27	-101.75	-31.48	20.90	-52.38	peak
4	0.2530	67.64	-101.80	-34.16	19.54	-53.70	peak
5	0.2942	64.32	-101.85	-37.53	18.23	-55.76	peak
6	0.3431	62.17	-101.90	-39.73	16.89	-56.62	peak

Test Mode:	802.11a20	Channel:	5180
Polarity:	Horizontal	Test Voltage:	DC 12 V

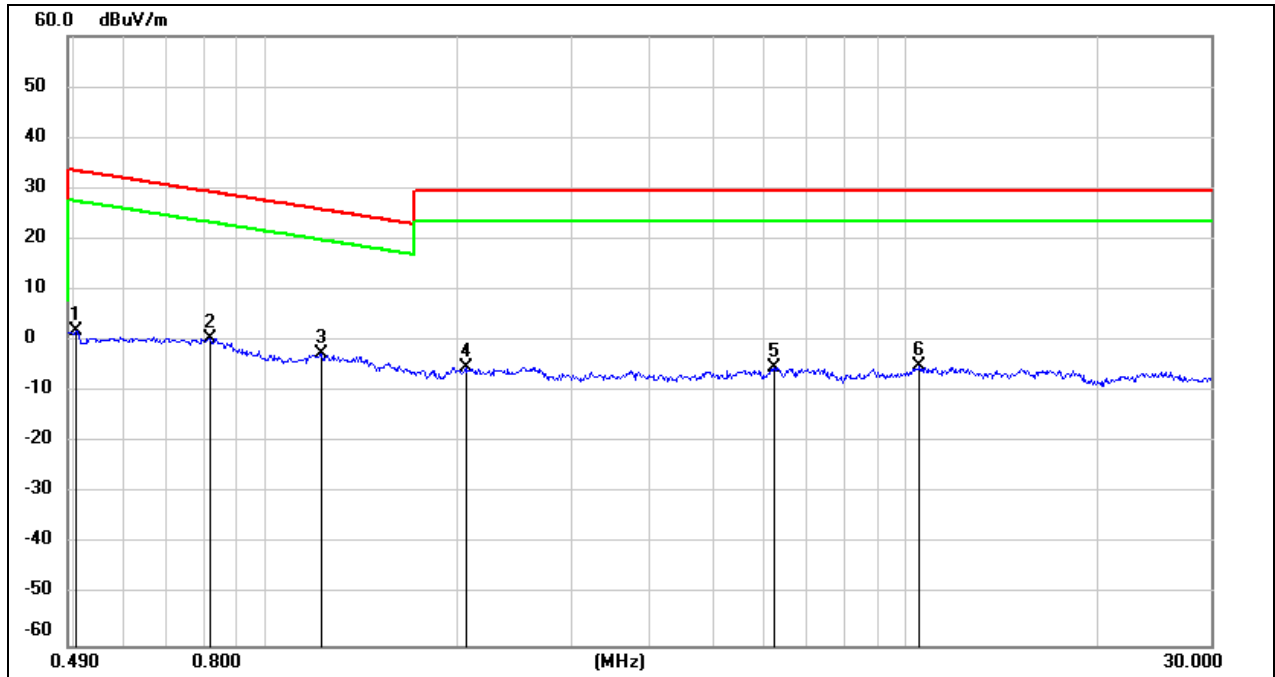

No.	Frequency (MHz)	Reading (dBuV)	Correct (dB/m)	Result (dBuV/m)	Limit (dBuV/m)	Margin (dB)	Remark
1	0.5039	63.93	-62.07	1.86	33.56	-31.70	peak
2	0.8195	62.66	-62.16	0.50	29.33	-28.83	peak
3	1.2214	59.62	-62.16	-2.54	25.87	-28.41	peak
4	2.0539	56.70	-61.81	-5.11	29.54	-34.65	peak
5	6.2445	56.13	-61.32	-5.19	29.54	-34.73	peak
6	10.5234	55.81	-60.82	-5.01	29.54	-34.55	peak

### 8.8. SPURIOUS EMISSIONS(18 GHZ~26 GHZ)

Test Mode:	802.11a 20	Channel:	5180
Polarity:	Horizontal	Test Voltage:	DC 12 V

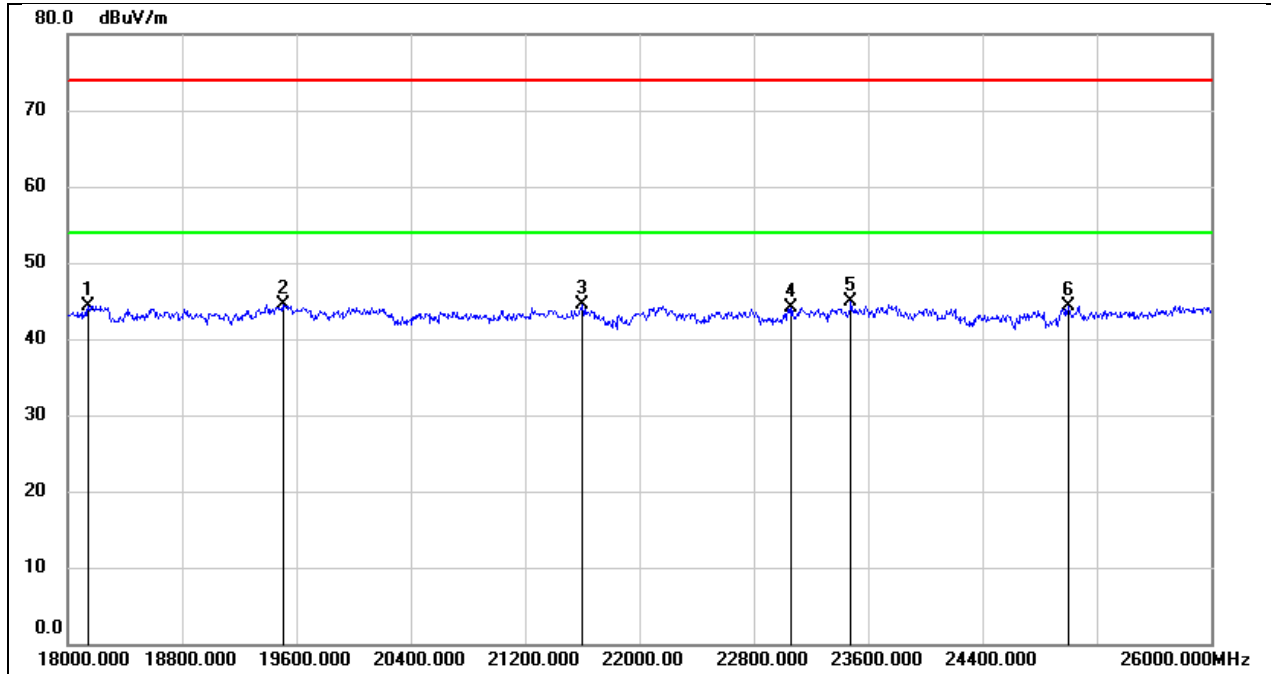

No.	Frequency (MHz)	Reading (dBuV)	Correct (dB/m)	Result (dBuV/m)	Limit (dBuV/m)	Margin (dB)	Remark
1	18144.000	49.77	-5.48	44.29	74.00	-29.71	peak
2	19504.000	49.97	-5.54	44.43	74.00	-29.57	peak
3	21600.000	49.02	-4.54	44.48	74.00	-29.52	peak
4	23064.000	47.49	-3.42	44.07	74.00	-29.93	peak
5	23480.000	48.04	-3.16	44.88	74.00	-29.12	peak
6	25000.000	46.36	-2.10	44.26	74.00	-29.74	peak

Test Mode:	802.11a 20	Channel:	5180
Polarity:	Vertical	Test Voltage:	DC 12 V

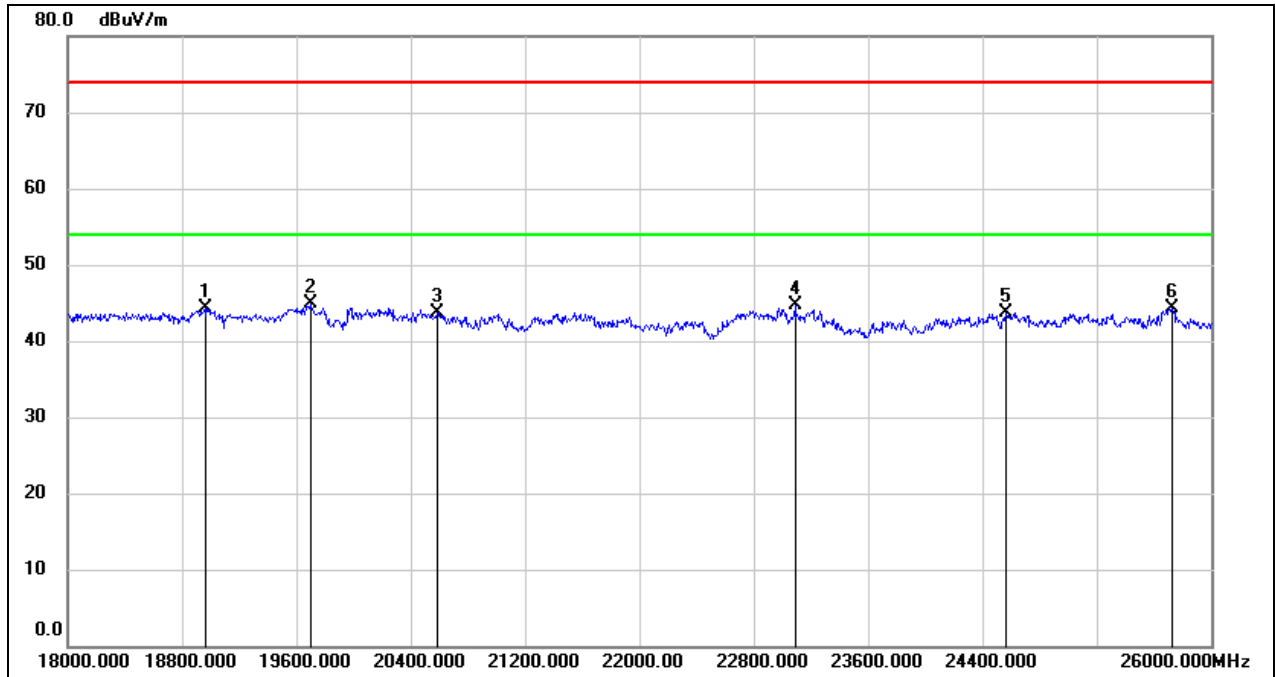

No.	Frequency (MHz)	Reading (dBuV)	Correct (dB/m)	Result (dBuV/m)	Limit (dBuV/m)	Margin (dB)	Remark
1	18960.000	49.51	-5.25	44.26	74.00	-29.74	peak
2	19696.000	50.15	-5.32	44.83	74.00	-29.17	peak
3	20584.000	49.00	-5.27	43.73	74.00	-30.27	peak
4	23088.000	48.02	-3.41	44.61	74.00	-29.39	peak
5	24568.000	46.10	-2.33	43.77	74.00	-30.23	peak
6	25728.000	45.11	-0.72	44.39	74.00	-29.61	peak

### 8.9. SPURIOUS EMISSIONS(26 GHZ~40 GHZ)

Test Mode:	802.11a 20	Channel:	5180
Polarity:	Horizontal	Test Voltage:	DC 12 V

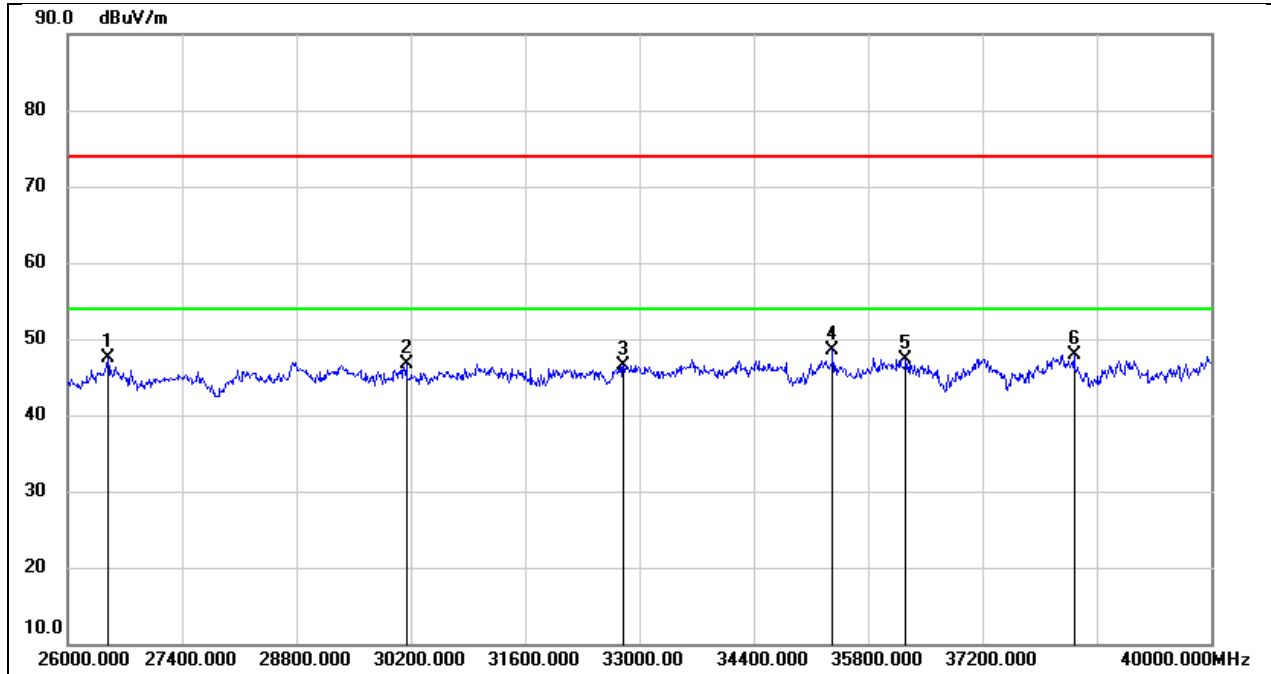

No.	Frequency (MHz)	Reading (dBuV)	Correct (dB/m)	Result (dBuV/m)	Limit (dBuV/m)	Margin (dB)	Remark
1	26490.000	52.29	-4.74	47.55	74.00	-26.45	peak
2	30144.000	47.96	-1.30	46.66	74.00	-27.34	peak
3	32804.000	47.64	-1.12	46.52	74.00	-27.48	peak
4	35366.000	45.90	2.59	48.49	74.00	-25.51	peak
5	36262.000	44.10	3.28	47.38	74.00	-26.62	peak
6	38320.000	44.06	3.77	47.83	74.00	-26.17	peak



Test Mode:	802.11a 20	Channel:	5180
Polarity:	Vertical	Test Voltage:	DC 12 V

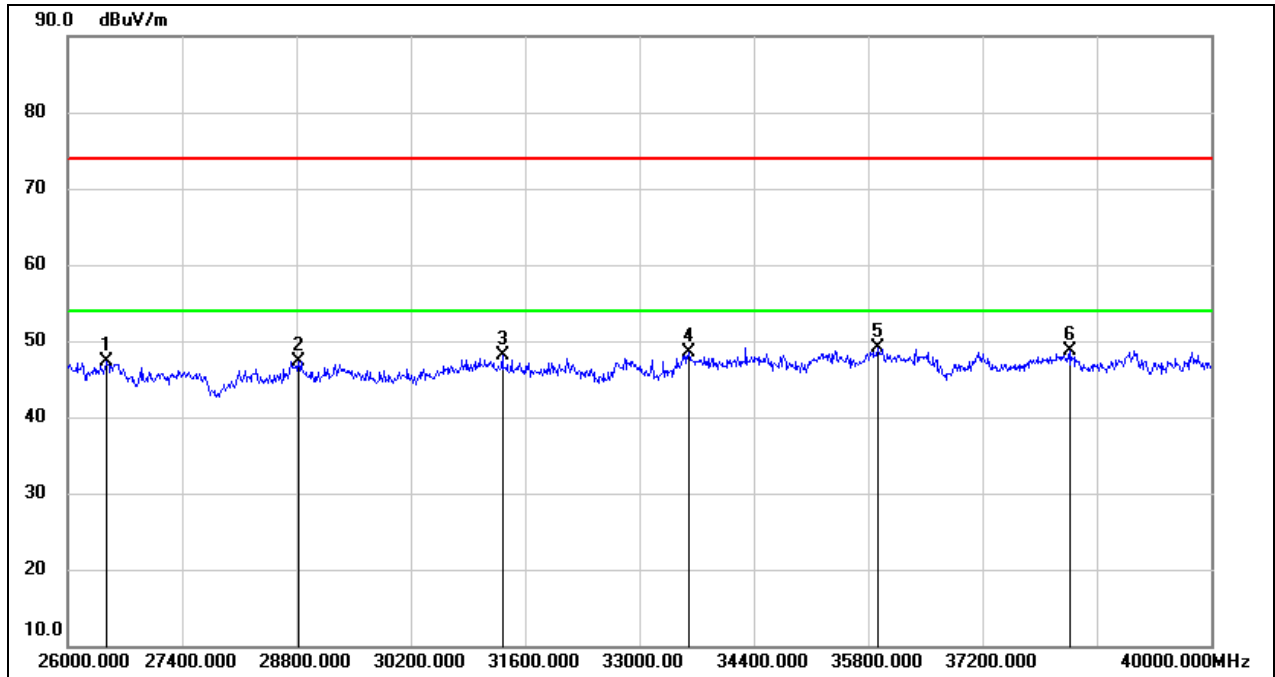

No.	Frequency (MHz)	Reading (dBuV)	Correct (dB/m)	Result (dBuV/m)	Limit (dBuV/m)	Margin (dB)	Remark
1	26476.000	52.03	-4.78	47.25	74.00	-26.75	peak
2	28828.000	48.13	-0.79	47.34	74.00	-26.66	peak
3	31320.000	49.11	-0.93	48.18	74.00	-25.82	peak
4	33602.000	48.01	0.46	48.47	74.00	-25.53	peak
5	35912.000	45.20	3.85	49.05	74.00	-24.95	peak
6	38278.000	44.82	3.82	48.64	74.00	-25.36	peak

### 8.10. SPURIOUS EMISSIONS(30 MHZ~1 GHZ)

Test Mode:	802.11a 20	Channel:	5180
Polarity:	Horizontal	Test Voltage:	DC 12 V

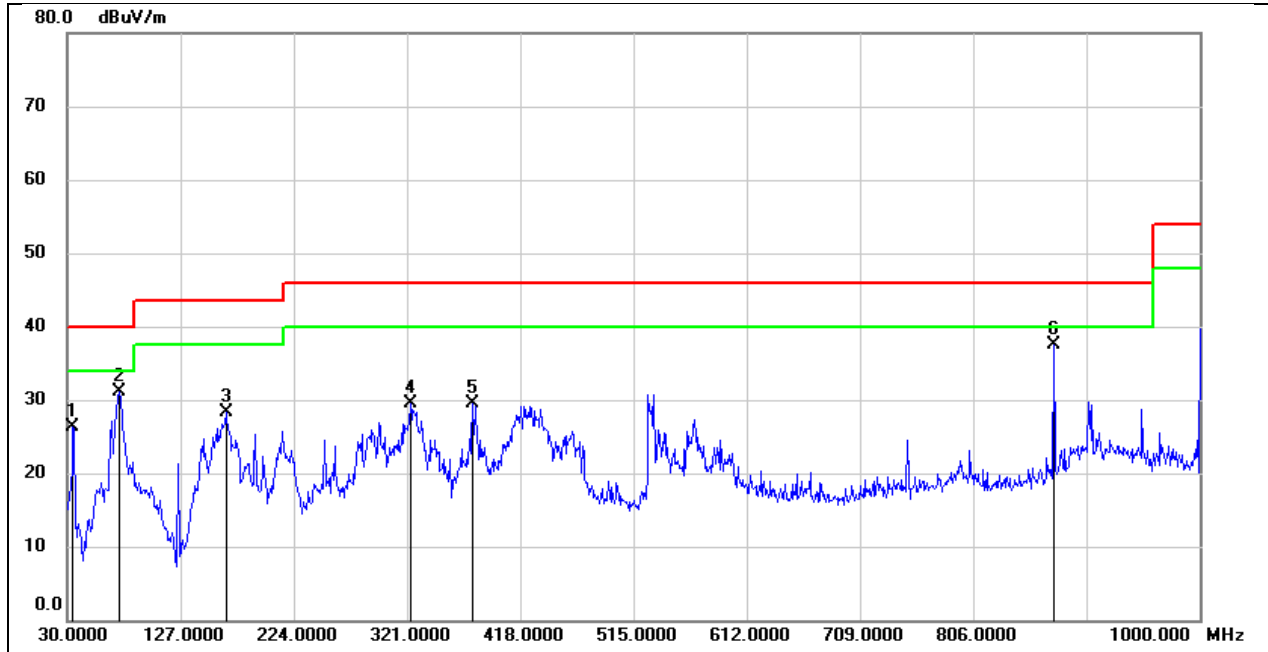

No.	Frequency (MHz)	Reading (dBuV)	Correct (dB/m)	Result (dBuV/m)	Limit (dBuV/m)	Margin (dB)	Remark
1	34.8500	45.33	-18.99	26.34	40.00	-13.66	QP
2	74.6200	52.14	-21.12	31.02	40.00	-8.98	QP
3	165.8000	45.42	-17.19	28.23	43.50	-15.27	QP
4	323.9100	43.67	-14.09	29.58	46.00	-16.42	QP
5	377.2600	42.44	-12.89	29.55	46.00	-16.45	QP
6	874.8700	42.88	-5.44	37.44	46.00	-8.56	QP

Test Mode:	802.11a 20	Channel:	5180
Polarity:	Vertical	Test Voltage:	DC 12 V

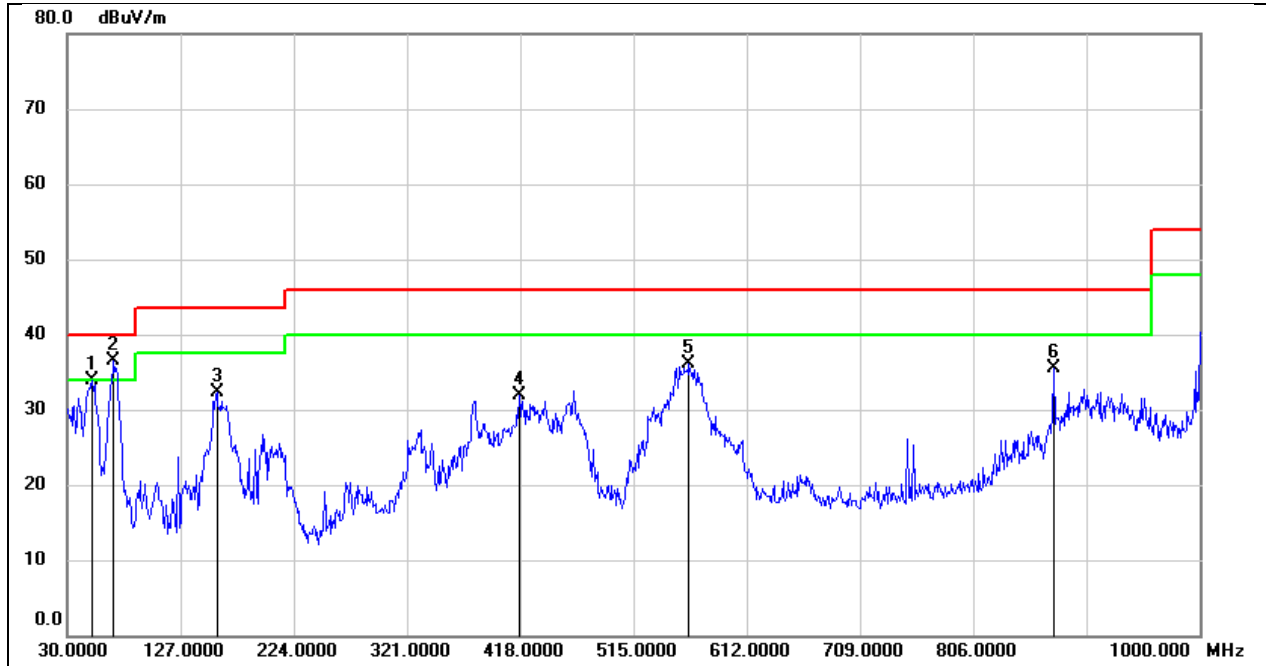

No.	Frequency (MHz)	Reading (dBuV)	Correct (dB/m)	Result (dBuV/m)	Limit (dBuV/m)	Margin (dB)	Remark
1	51.3400	54.44	-20.53	33.91	40.00	-6.09	QP
2	69.7699	57.28	-20.76	36.52	40.00	-3.48	QP
3	158.0399	49.97	-17.71	32.26	43.50	-11.24	QP
4	417.0300	44.41	-12.55	31.86	46.00	-14.14	QP
5	562.5300	46.24	-10.22	36.02	46.00	-9.98	QP
6	874.8700	40.98	-5.44	35.54	46.00	-10.46	QP

## 8.11. SIMULTANEOUSLY TRANSMISSION SPURIOUS EMISSIONS

(1 GHz~18 GHz) (Worst case)

Test Mode:	WIFI 2.4G 802.11b Mode 2437 MHz & WIFI 5G 802.11a Mode 5745 MHz		
Polarity:	Horizontal	Test Voltage:	DC 12 V

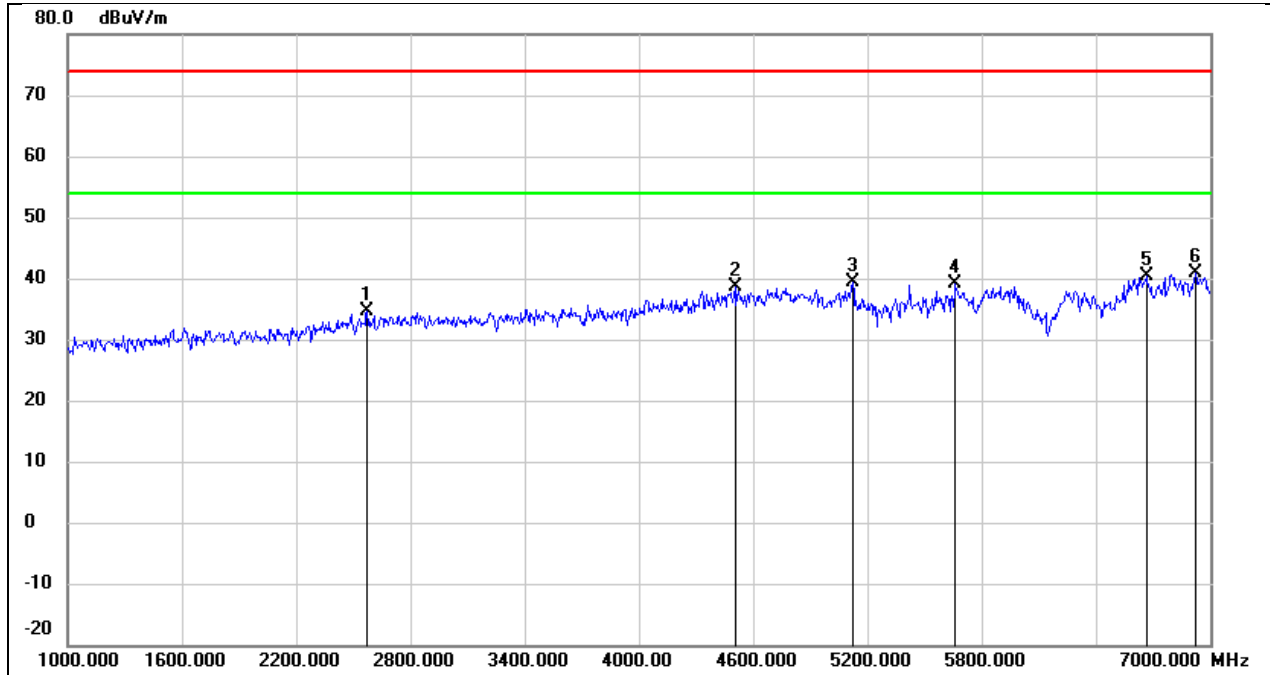

No.	Frequency (MHz)	Reading (dBuV)	Correct (dB/m)	Result (dBuV/m)	Limit (dBuV/m)	Margin (dB)	Remark
1	2572.000	42.92	-8.27	34.65	74.00	-39.35	peak
2	4504.000	40.78	-2.12	38.66	74.00	-35.34	peak
3	5122.000	39.39	-0.02	39.37	74.00	-34.63	peak
4	5662.000	38.31	0.88	39.19	74.00	-34.81	peak
5	6664.000	35.77	4.54	40.31	74.00	-33.69	peak
6	6922.000	35.17	5.81	40.98	74.00	-33.02	peak

Test Mode:	WIFI 2.4G 802.11b Mode 2437 MHz & WIFI 5G 802.11a Mode 5745 MHz		
Polarity:	Vertical	Test Voltage:	DC 12 V

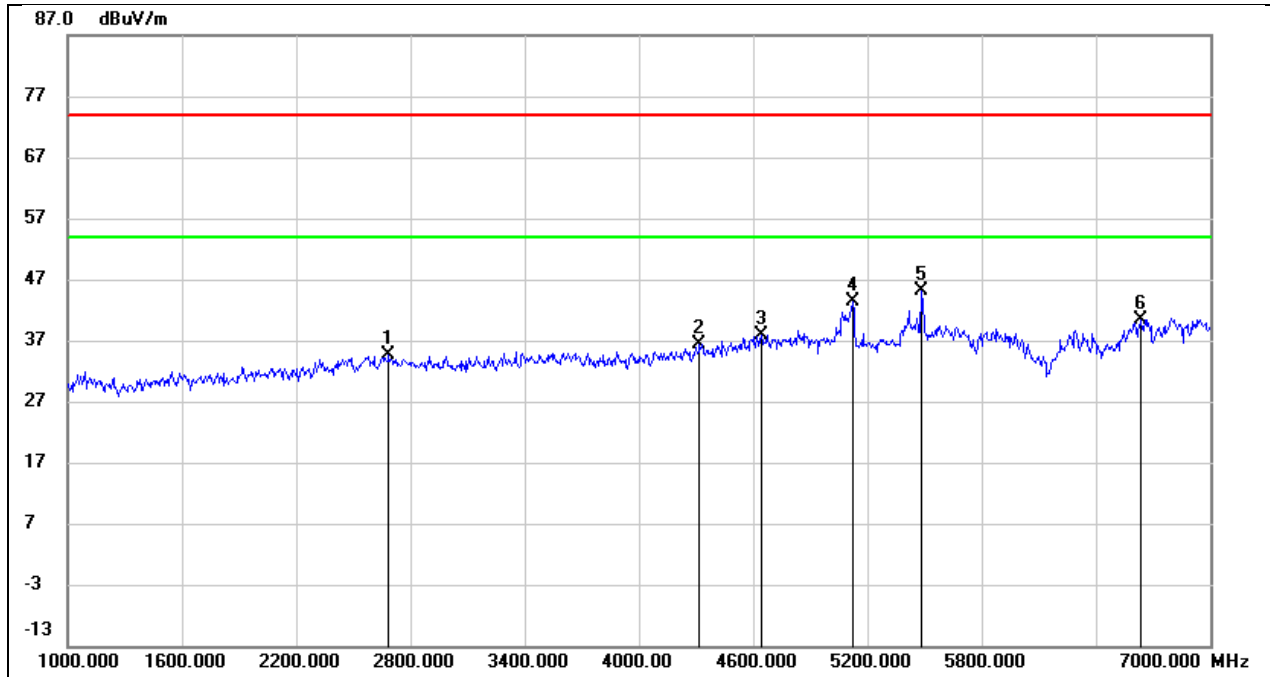

No.	Frequency (MHz)	Reading (dBuV)	Correct (dB/m)	Result (dBuV/m)	Limit (dBuV/m)	Margin (dB)	Remark
1	2686.000	42.49	-7.93	34.56	74.00	-39.44	peak
2	4318.000	39.37	-2.99	36.38	74.00	-37.62	peak
3	4642.000	39.47	-1.57	37.90	74.00	-36.10	peak
4	5122.000	43.28	-0.02	43.26	74.00	-30.74	peak
5	5482.000	44.80	0.40	45.20	74.00	-28.80	peak
6	6634.000	36.11	4.38	40.49	74.00	-33.51	peak

Test Mode:	WIFI 2.4G 802.11b Mode 2437 MHz & WIFI 5G 802.11a Mode 5745 MHz		
Polarity:	Horizontal	Test Voltage:	DC 12 V

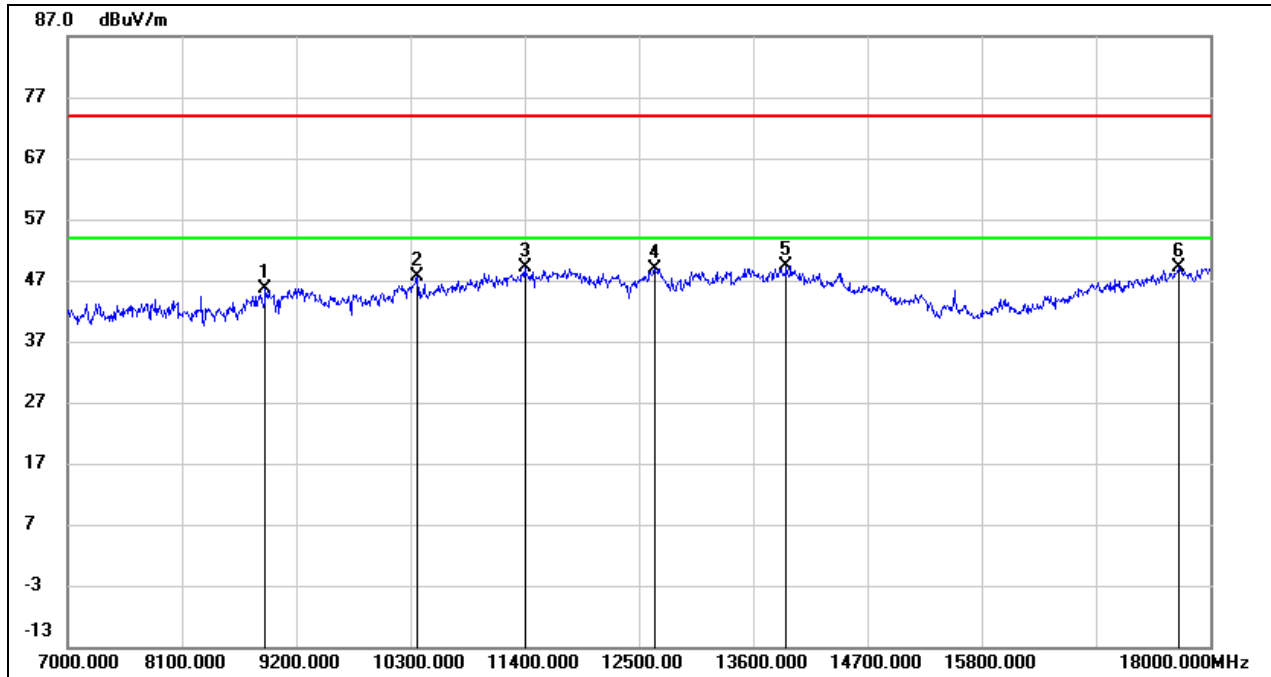

No.	Frequency (MHz)	Reading (dBuV)	Correct (dB/m)	Result (dBuV/m)	Limit (dBuV/m)	Margin (dB)	Remark
1	8903.000	35.96	9.66	45.62	74.00	-28.38	peak
2	10366.000	35.11	12.54	47.65	74.00	-26.35	peak
3	11400.000	32.75	16.36	49.11	74.00	-24.89	peak
4	12654.000	30.92	18.01	48.93	74.00	-25.07	peak
5	13919.000	27.79	21.68	49.47	74.00	-24.53	peak
6	17692.000	25.15	24.01	49.16	74.00	-24.84	peak

Test Mode:	WIFI 2.4G 802.11b Mode 2437 MHz & WIFI 5G 802.11a Mode 5745 MHz		
Polarity:	Vertical	Test Voltage:	DC 12 V

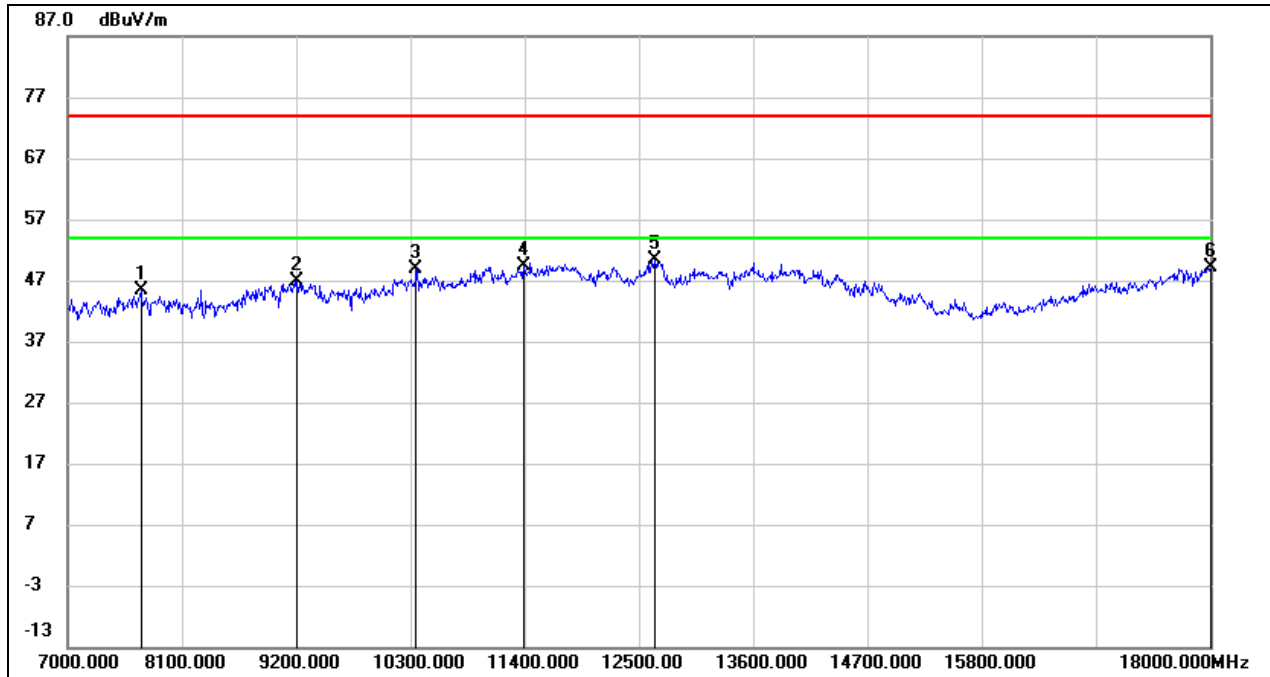

No.	Frequency (MHz)	Reading (dBuV)	Correct (dB/m)	Result (dBuV/m)	Limit (dBuV/m)	Margin (dB)	Remark
1	7704.000	38.79	6.69	45.48	74.00	-28.52	peak
2	9211.000	36.31	10.47	46.78	74.00	-27.22	peak
3	10355.000	36.36	12.52	48.88	74.00	-25.12	peak
4	11389.000	33.11	16.31	49.42	74.00	-24.58	peak
5	12654.000	32.26	18.01	50.27	74.00	-23.73	peak
6	18000.000	23.10	26.12	49.22	74.00	-24.78	peak

## 9. AC POWER LINE CONDUCTED EMISSION

### LIMITS

Please refer to CFR 47 FCC §15.207 (a) and ISED RSS-Gen Clause 8.8

FREQUENCY (MHz)	Quasi-peak	Average
0.15 -0.5	66 - 56 *	56 - 46 *
0.50 -5.0	56.00	46.00
5.0 -30.0	60.00	50.00

### TEST PROCEDURE

Refer to ANSI C63.10-2013 clause 6.2.

The EUT is put on a table of non-conducting material that is 80 cm high. The vertical conducting wall of shielding is located 40 cm to the rear of the EUT. The power line of the EUT is connected to the AC mains through a Artificial Mains Network (A.M.N.). A EMI Measurement Receiver (R&S Test Receiver ESR3) is used to test the emissions from both sides of AC line. According to the requirements in Section 6.2 of ANSI C63.10-2013. Conducted emissions from the EUT measured in the frequency range between 0.15 MHz and 30 MHz using CISPR Quasi-Peak and average detector mode. The bandwidth of EMI test receiver is set at 9 kHz.

The arrangement of the equipment is installed to meet the standards and operating in a manner, which tends to maximize its emission characteristics in a normal application.

### TEST SETUP

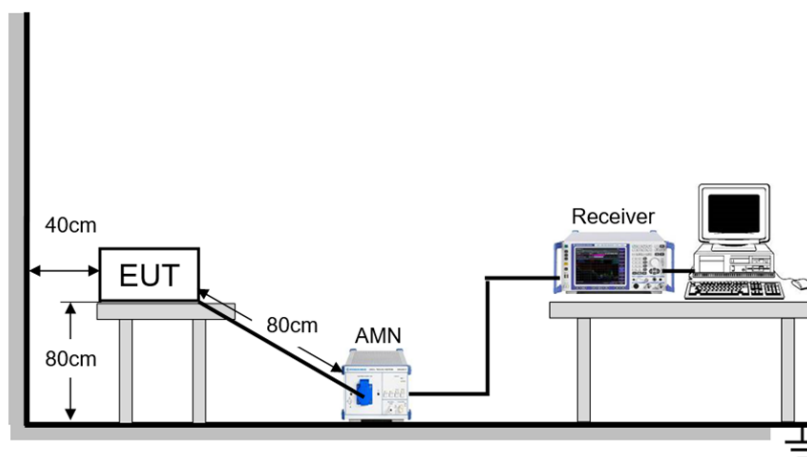



**TEST ENVIRONMENT**

Temperature	25.2°C	Relative Humidity	57%
Atmosphere Pressure	101kPa	Test Voltage	AC 120 V, 60 Hz

**TEST DATE / ENGINEER**

Test Date	May 26, 2023	Test By	Wite Chen
-----------	--------------	---------	-----------

**TEST RESULTS**

Test Mode:	802.11a	Channel:	5180
Line:	Line	Test Voltage:	AC 120 V, 60 Hz

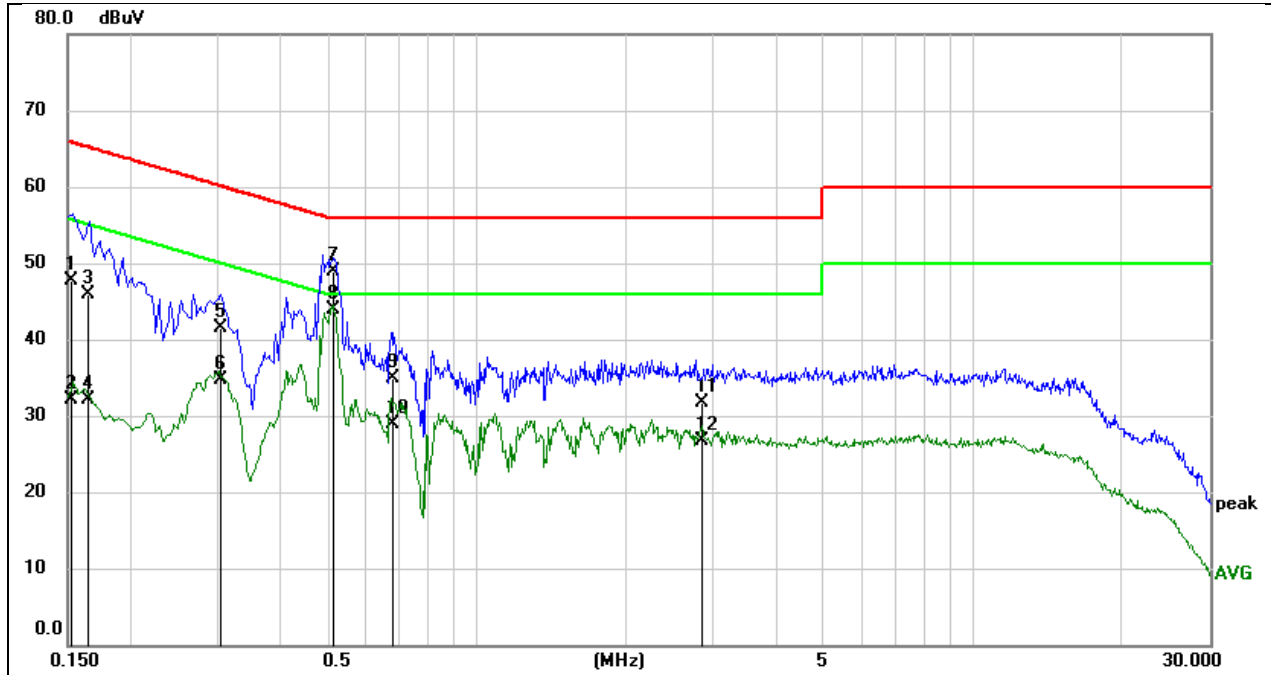

No.	Frequency (MHz)	Reading (dBuV)	Correct (dB)	Result (dBuV)	Limit (dBuV)	Margin (dB)	Remark
1	0.1524	38.15	9.59	47.74	65.87	-18.13	QP
2	0.1524	22.53	9.59	32.12	55.87	-23.75	AVG
3	0.1648	36.33	9.59	45.92	65.22	-19.30	QP
4	0.1648	22.55	9.59	32.14	55.22	-23.08	AVG
5	0.3053	31.93	9.59	41.52	60.10	-18.58	QP
6	0.3053	25.14	9.59	34.73	50.10	-15.37	AVG
7	0.5105	39.37	9.60	48.97	56.00	-7.03	QP
8	0.5105	34.25	9.60	43.85	46.00	-2.15	AVG
9	0.6817	25.40	9.60	35.00	56.00	-21.00	QP
10	0.6817	19.39	9.60	28.99	46.00	-17.01	AVG
11	2.8400	22.08	9.66	31.74	56.00	-24.26	QP
12	2.8400	17.04	9.66	26.70	46.00	-19.30	AVG

**Note:**

1. Result = Reading + Correct Factor.
2. If QP Result complies with AV limit, AV Result is deemed to comply with AV limit.
3. Test setup: RBW: 200 Hz (9 kHz ~ 150 kHz), 9 kHz (150 kHz ~ 30 MHz).
4. Step size: 80 Hz (0.009 MHz ~ 0.15 MHz), 4 kHz (0.15 MHz ~ 30 MHz), Scan time: auto.

Note: All the modes have been tested, only the worst data was recorded in the report.

Test Mode:	802.11a	Channel:	5180
Line:	Neutral	Test Voltage:	AC 120 V, 60 Hz

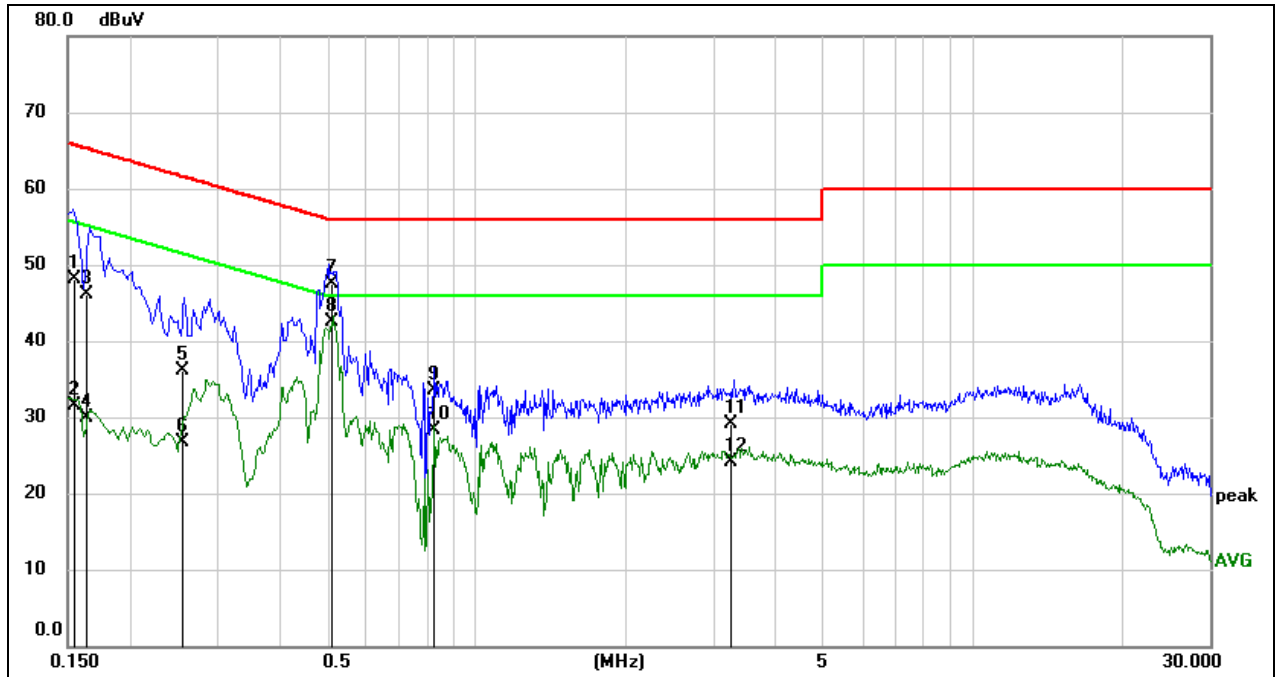

No.	Frequency (MHz)	Reading (dBuV)	Correct (dB)	Result (dBuV)	Limit (dBuV)	Margin (dB)	Remark
1	0.1550	38.48	9.59	48.07	65.73	-17.66	QP
2	0.1550	21.94	9.59	31.53	55.73	-24.20	AVG
3	0.1626	36.46	9.59	46.05	65.33	-19.28	QP
4	0.1626	20.40	9.59	29.99	55.33	-25.34	AVG
5	0.2556	26.57	9.59	36.16	61.57	-25.41	QP
6	0.2556	17.15	9.59	26.74	51.57	-24.83	AVG
7	0.5115	37.90	9.60	47.50	56.00	-8.50	QP
8	0.5115	32.99	9.60	42.59	46.00	-3.41	AVG
9	0.8214	23.87	9.60	33.47	56.00	-22.53	QP
10	0.8214	18.79	9.60	28.39	46.00	-17.61	AVG
11	3.2514	19.49	9.67	29.16	56.00	-26.84	QP
12	3.2514	14.47	9.67	24.14	46.00	-21.86	AVG

**Note:**

1. Result = Reading + Correct Factor.
2. If QP Result complies with AV limit, AV Result is deemed to comply with AV limit.
3. Test setup: RBW: 200 Hz (9 kHz ~ 150 kHz), 9 kHz (150 kHz ~ 30 MHz).
4. Step size: 80 Hz (0.009 MHz ~ 0.15 MHz), 4 kHz (0.15 MHz ~ 30 MHz), Scan time: auto.

Note: All the modes have been tested, only the worst data was recorded in the report.

## 10. ANTENNA REQUIREMENT

### REQUIREMENT

Please refer to FCC part 15.203

An intentional radiator shall be designed to ensure that no antenna other than that furnished by the responsible party shall be used with the device. The use of a permanently attached antenna or of an antenna that uses a unique coupling to the intentional radiator shall be considered sufficient to comply with the provisions of this section. The manufacturer may design the unit so that a broken antenna can be replaced by the user, but the use of a standard antenna jack or electrical connector is prohibited.

Please refer to FCC part 15.407(a)

For an indoor access point operating in the band 5.15-5.25 GHz, the maximum conducted output power over the frequency band of operation shall not exceed 1 W provided the maximum antenna gain does not exceed 6 dBi. In addition, the maximum power spectral density shall not exceed 17 dBm in any 1 megahertz band. If transmitting antennas of directional gain greater than 6 dBi are used, both the maximum conducted output power and the maximum power spectral density shall be reduced by the amount in dB that the directional gain of the antenna exceeds 6 dBi.

### DESCRIPTION

Pass