

802.11ax-HE40 - Ant 3 (Nss = 4)

Channel 35 (6125MHz)

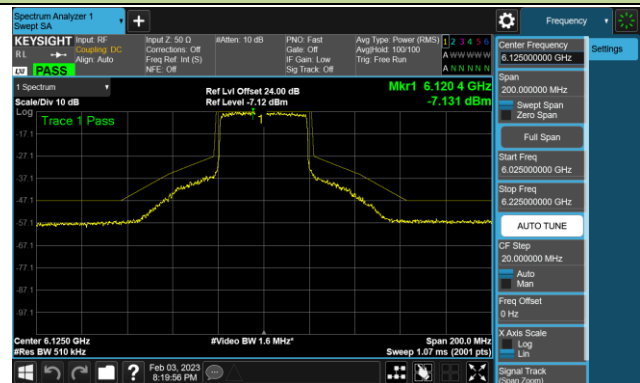

Channel 59 (6245MHz)

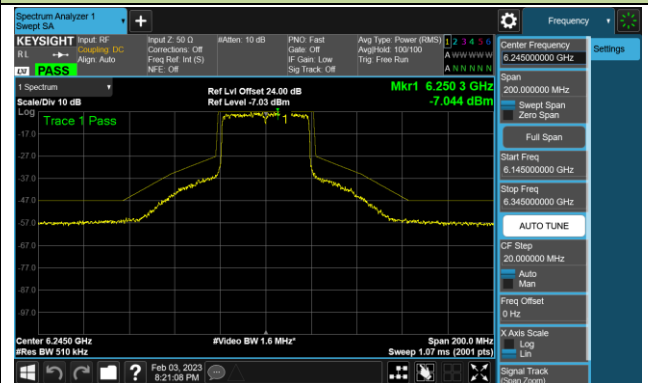

Channel 91 (6405MHz)

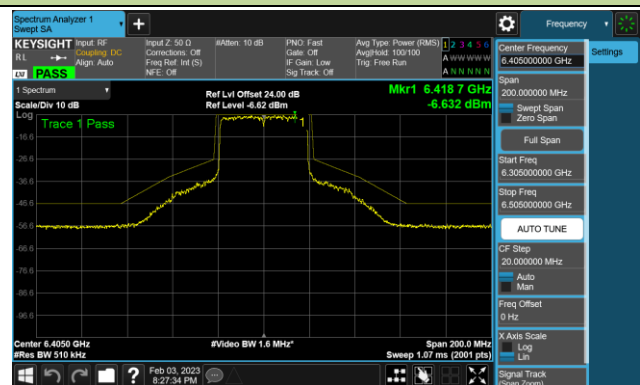

Channel 99 (6445MHz)

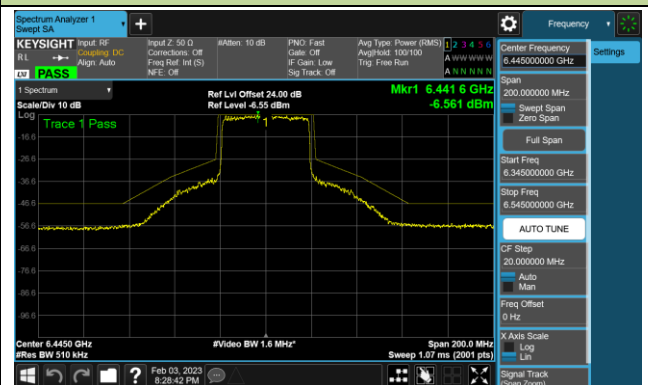

Channel 107 (6485MHz)

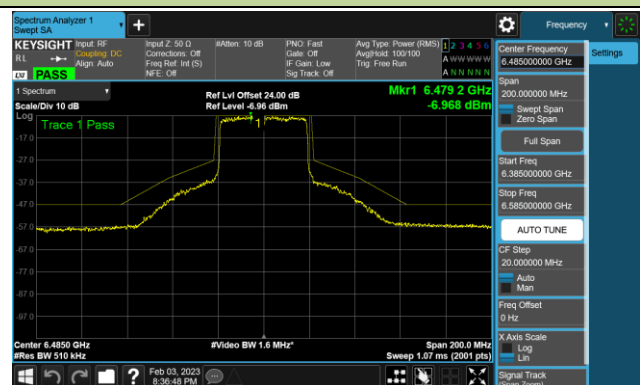

Channel 115 (6525MHz)

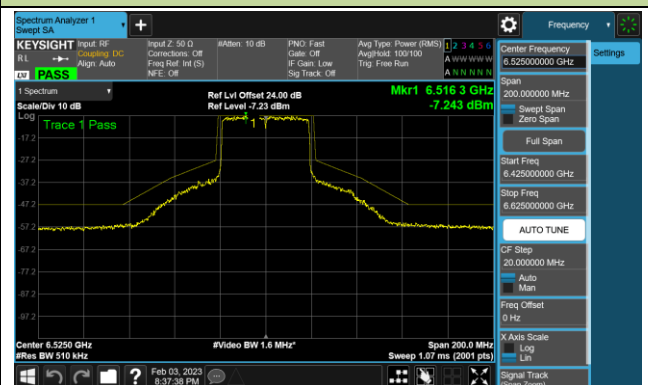

Channel 123 (6565MHz)

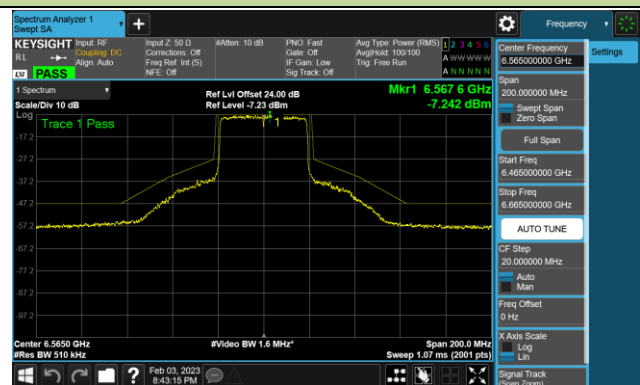

Channel 147 (6685MHz)

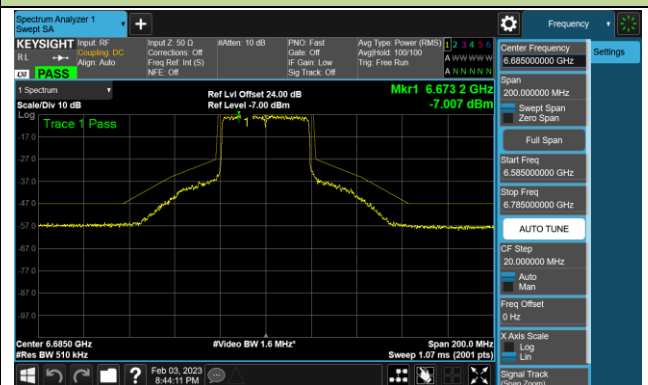

802.11ax-HE40 - Ant 3 (Nss = 4)

Channel 179 (6845MHz)

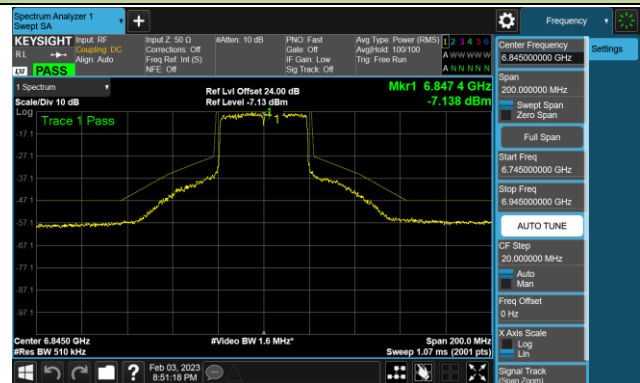

Channel 187 (6885MHz)

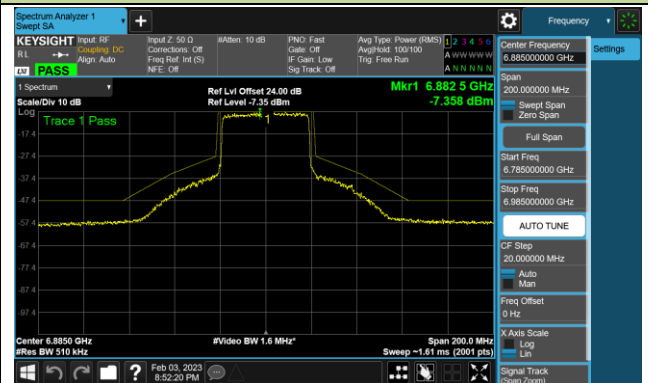

Channel 195 (6925MHz)

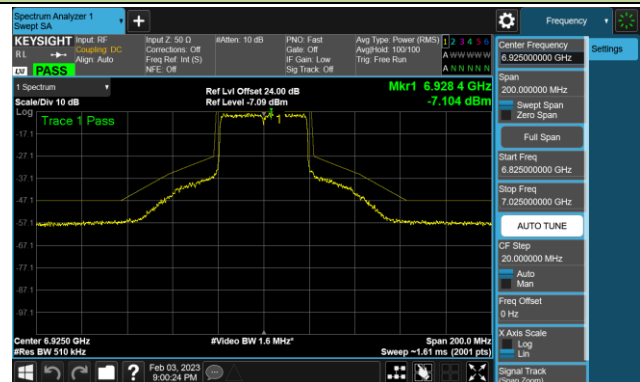

Channel 211 (7005MHz)

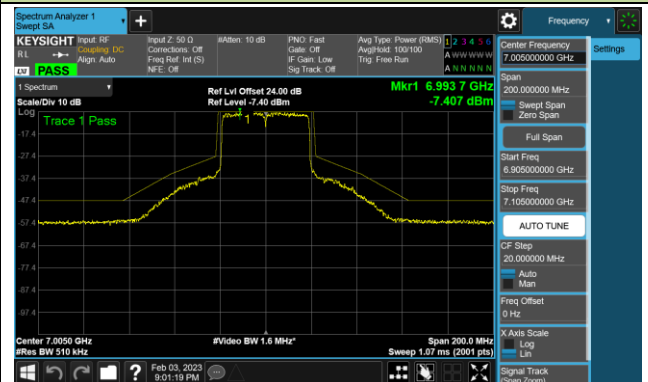

Channel 211 (7085MHz)

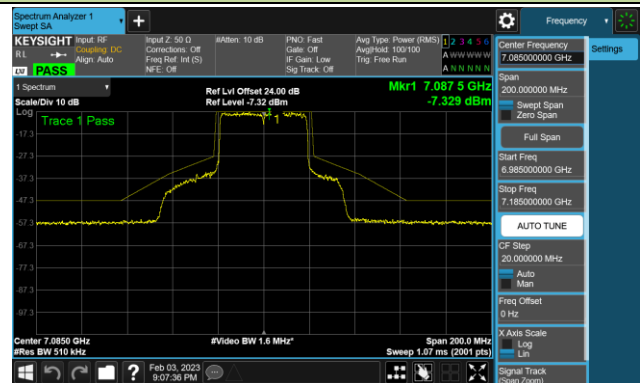

802.11ax-HE80 - Ant 3 (Nss = 4)

Channel 39 (6145MHz)

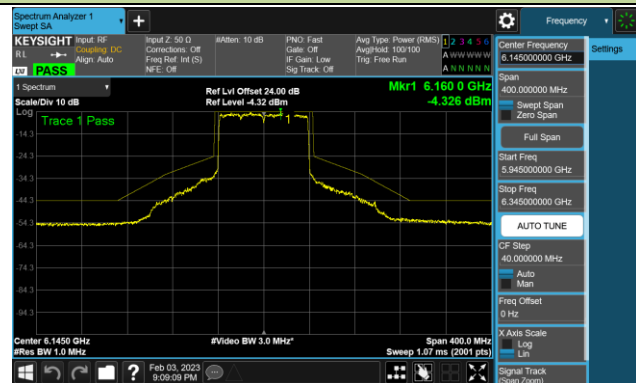

Channel 55 (6225MHz)

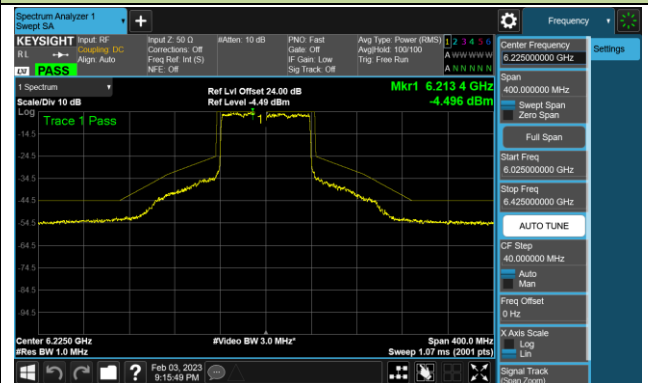

Channel 87 (6385MHz)

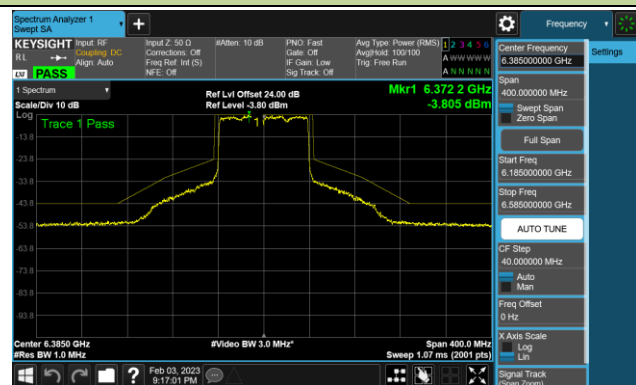

Channel 103 (6465MHz)

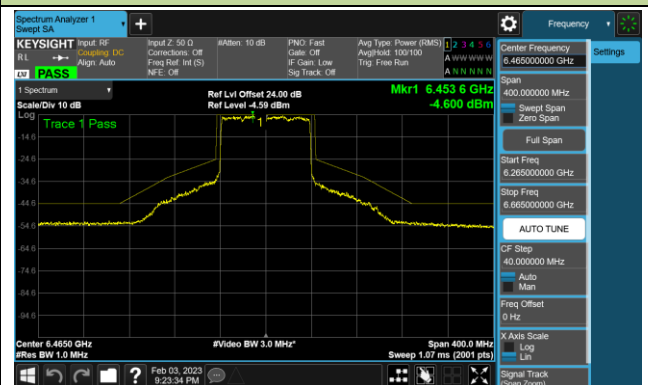

Channel 119 (6545MHz)

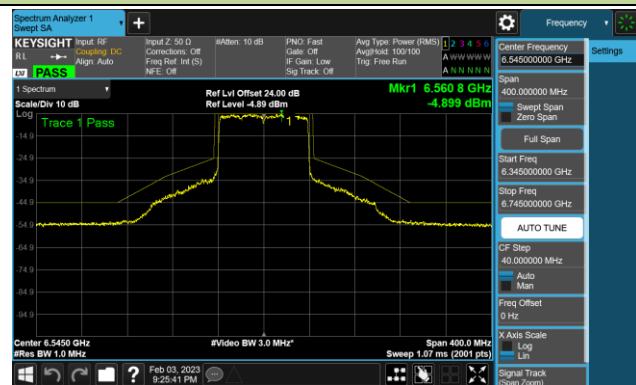

Channel 135 (6625MHz)

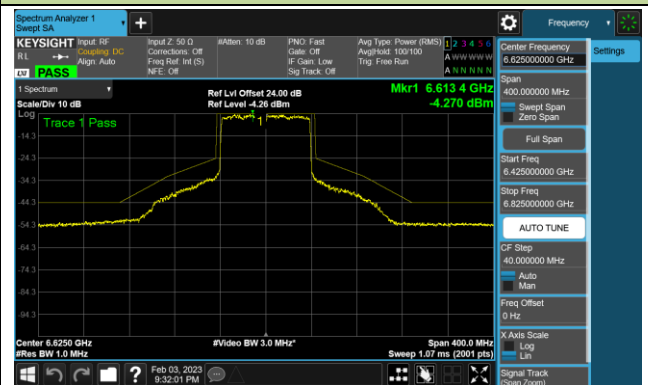

Channel 151 (6705MHz)

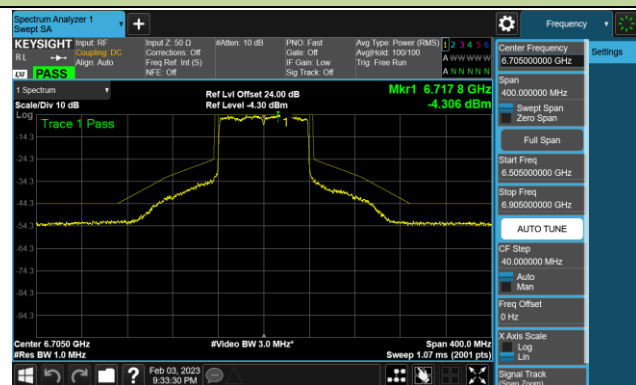

Channel 183 (6865MHz)

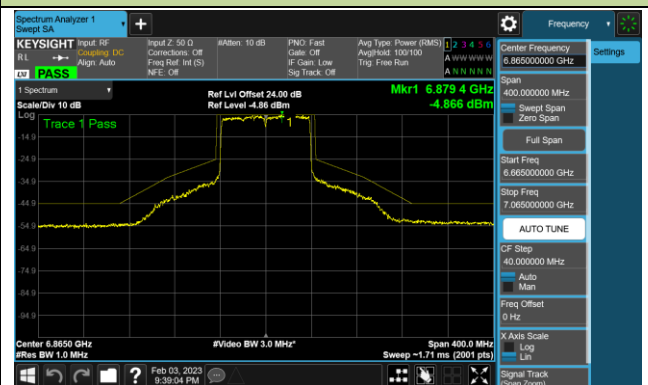

802.11ax-HE80 - Ant 3 (Nss = 4)

Channel 199 (6945MHz)

Channel 215 (7025MHz)

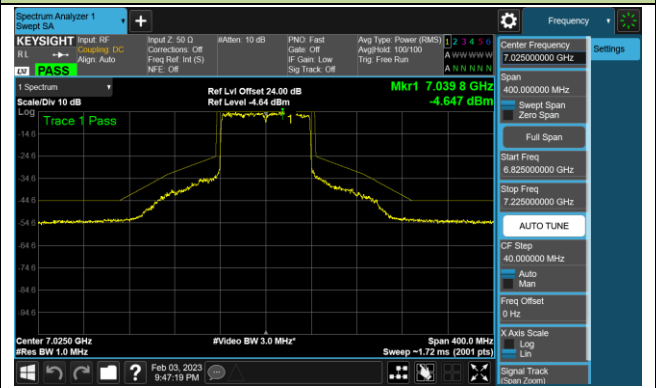
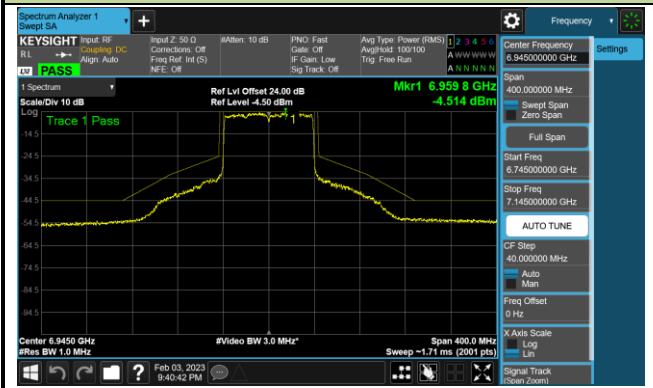

802.11ax-HE160 - Ant 3 (Nss = 4)

Channel 47 (6185MHz)

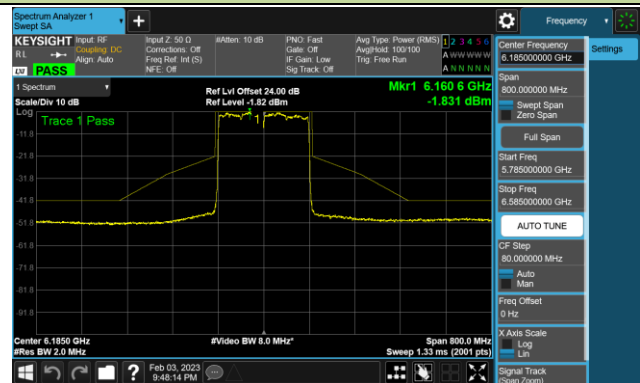

Channel 79 (6345MHz)

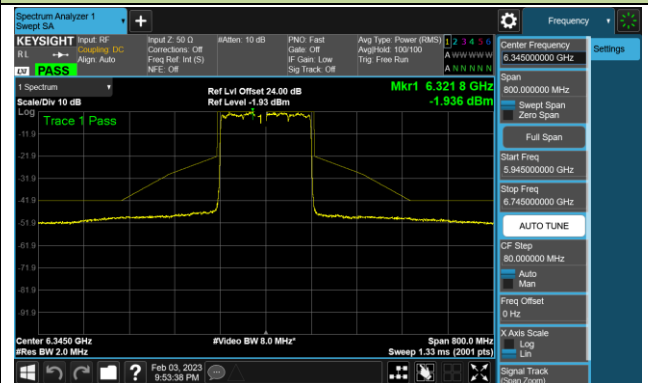

Channel 111 (6505MHz)

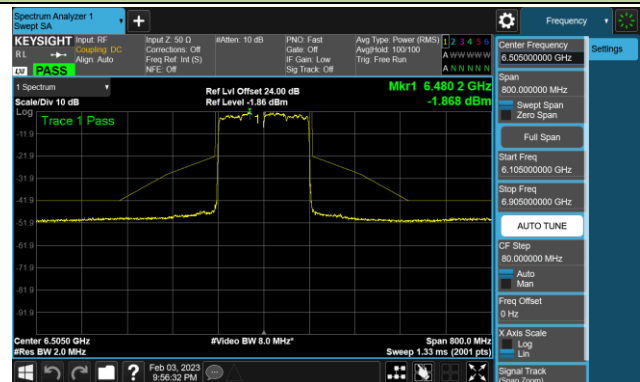

Channel 143 (6665MHz)

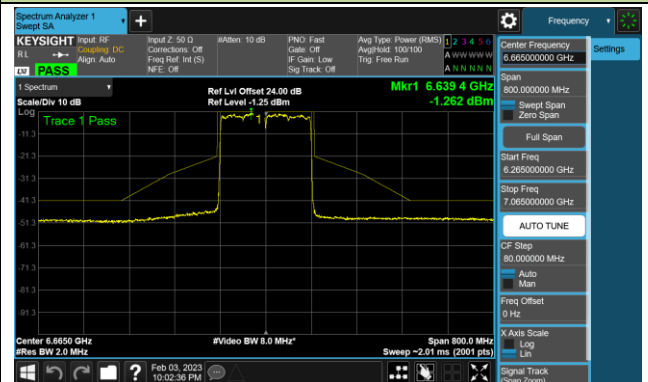

Channel 175 (6825MHz)

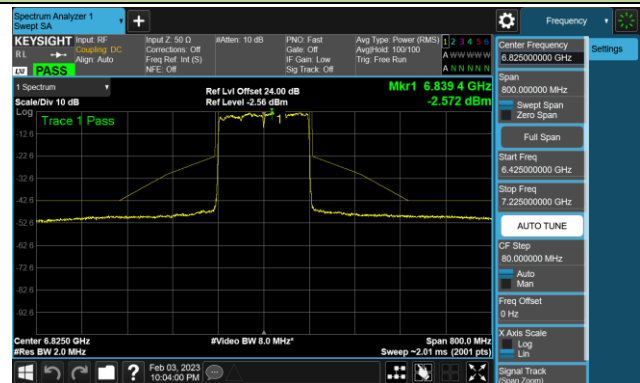

Channel 207 (6985MHz)

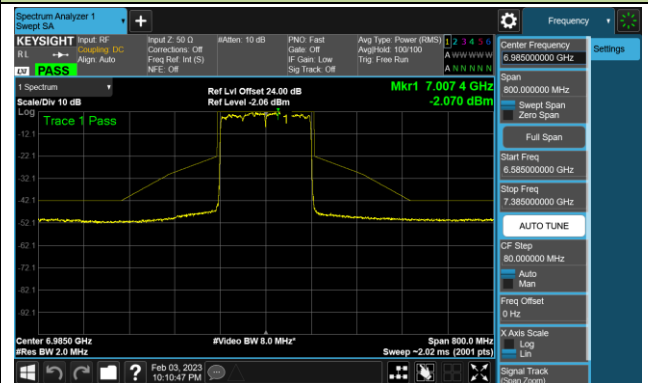

6.6. Frequency Stability Measurement

6.6.1. Test Limit

Manufacturers of U-NII devices are responsible for ensuring frequency stability such that an emission is maintained within the band of operation under all conditions of normal operation as specified in the user's manual.

6.6.2. Test Procedure

Frequency Stability Under Temperature Variations:

The equipment under test was connected to an external AC or DC power supply and input rated voltage. RF output was connected to a frequency counter or spectrum analyzer via feed through attenuators. The EUT was placed inside the temperature chamber. Set the spectrum analyzer RBW low enough to obtain the desired frequency resolution and measure EUT 20°C operating frequency as reference frequency. Turn EUT off and set the chamber temperature to highest. After the temperature stabilized for approximately 30 minutes recorded the frequency. Repeat step measure with 10°C decreased per stage until the lowest temperature reached.

Frequency Stability Under Voltage Variations:

Set chamber temperature to 20°C. Use a variable AC power supply / DC power source to power the EUT and set the voltage to rated voltage. Set the spectrum analyzer RBW low enough to obtain the desired frequency resolution and recorded the frequency.

Reduce the input voltage to specify extreme voltage variation ($\pm 15\%$) and endpoint, record the maximum frequency change.

6.6.3. Test Setup

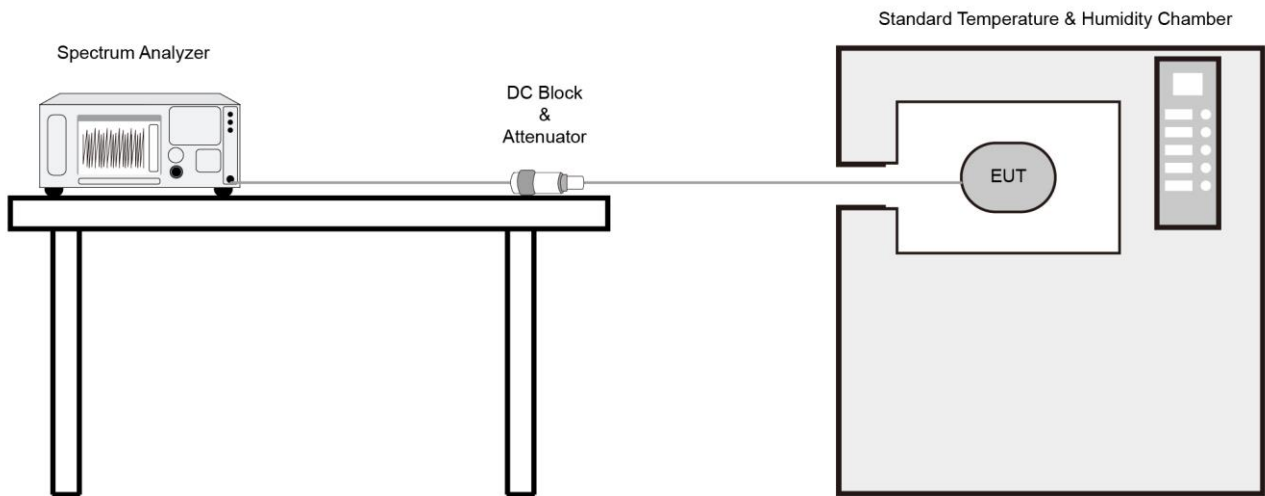

6.6.4. Test Result

Test Site	SR3	Test Engineer	Owen
Test Date	2022/12/30		
Test Mode	6115MHz (Carrier Mode)		

Voltage (%)	Power (VAC)	Temp (°C)	Frequency Tolerance (ppm)			
			0 minutes	2 minutes	5 minutes	10 minutes
100	120	- 30	3.50	2.96	2.65	2.45
		- 20	5.15	5.28	5.31	5.23
		- 10	6.08	6.25	6.52	6.43
		0	5.76	5.41	5.18	5.13
		+ 10	1.16	1.14	1.14	1.13
		+ 20	-1.86	-2.91	-6.49	-6.46
		+ 30	-8.36	-7.85	-7.67	-7.31
		+ 40	-7.13	-7.29	-7.42	-7.56
		+ 50	-7.03	-7.75	-8.57	-9.14
115	138	+ 20	-6.28	-6.38	-3.78	-3.81
85	102	+ 20	-3.52	-6.43	-3.73	-3.34

Note: Frequency Tolerance (ppm) = {[Measured Frequency (Hz) - Declared Frequency (Hz)] / Declared Frequency (Hz)} *10⁶.

6.7. Contention Based Protocol

6.7.1. Test Limit

Unlicensed indoor low power device must detect co-channel radio frequency power that is at least -62dBm (The threshold is referenced to a 0dBi antenna gain.) or low.

Indoor low power device must detect an AWGN signal with 90% (or better) level of certainty.

6.7.2. Test Procedure Used

KDB 987594 D02v01- Section I

6.7.3. Test Setting

1. Configure the EUT to transmit with a constant duty cycle.
2. Set the operating parameters of the EUT including power level, operating frequency, modulation and bandwidth.
3. Set the signal analyzer center frequency to the nominal EUT channel center frequency. The span range of the signal analyzer shall be between two times and five times the OBW of the EUT.
Connect the output port of the EUT to the signal analyzer 2. Ensure that the attenuator 2 provides enough attenuation to not overload the signal analyzer 2 receiver.
4. Monitoring the signal analyzer 2, verify the EUT is operating and transmitting with the parameters set at step two.
5. Using an AWGN signal source, generate a 10 MHz-wide AWGN signal. Use Table 1 of KDB 987594 to determine the center frequency of the 10 MHz AWGN signal relative to the EUT's channel bandwidth and center frequency.
6. Set the AWGN signal power to an extremely low level. Connect the AWGN signal source, via a 3-dB splitter, to the signal analyzer 1 and the EUT as shown in below figure.
7. Transmit the AWGN signal (RF ON) and verify its characteristics on the signal analyzer 1.
8. Monitor the signal analyzer 2 to verify if the AWGN signal has been detected and the EUT has ceased transmission. If the EUT continues to transmit, then incrementally increase the AWGN signal power level until the EUT stops transmitting.

9. Determine and record the AWGN signal power level (at the EUT's antenna port) at which the EUT ceased transmission. Repeat the procedure at least 10 times to verify the EUT can detect an AWGN signal with 90% (or better) level of certainty.

10. Refer to Table 1 to determine number of times the detection threshold testing needs to be repeated. If testing is required more than once, then go back to step 5, choose a different center frequency for the AWGN signal and repeat the process.

6.7.4. Test Setup

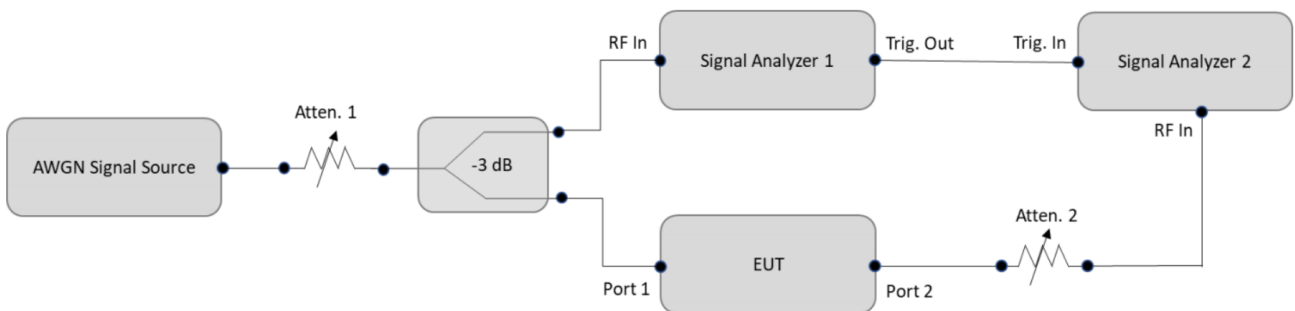

6.7.5. Test Result

Test Site	SR6	Test Engineer	Peter
Test Date	2022/12/20 ~ 2022/12/22		

Test Channel	Bandwidth (MHz)	Freq. (MHz)	AWGN Freq. (MHz)	AWGN Power (dBm)	Ant. Gain (dBi)	Adjust Power (dBm)	Detection Limit (dBm)	Detected Number	Detection Probability (%)	Limit (%)	Test Result
Operation Band: U-NII 5											
33	20	6115	6115	-78	3	-75	≤ -62.0	10	100	90	Pass
47	160	6185	6110	-78	3	-75	≤ -62.0	10	100	90	Pass
47	160	6185	6185	-78	3	-75	≤ -62.0	10	100	90	Pass
47	160	6185	6260	-77	3	-74	≤ -62.0	10	100	90	Pass
Operation Band: U-NII 6											
97	20	6435	6435	-77	3	-74	≤ -62.0	10	100	90	Pass
103	80	6465	6430	-79	3	-76	≤ -62.0	10	100	90	Pass
103	80	6465	6465	-78	3	-75	≤ -62.0	10	100	90	Pass
103	80	6465	6500	-79	3	-76	≤ -62.0	10	100	90	Pass
Operation Band: U-NII 7											
153	20	6715	6715	-79	3	-76	≤ -62.0	10	100	90	Pass
143	160	6665	6590	-78	3	-75	≤ -62.0	10	100	90	Pass
143	160	6665	6665	-77	3	-74	≤ -62.0	10	100	90	Pass
143	160	6665	6740	-78	3	-75	≤ -62.0	10	100	90	Pass
Operation Band: U-NII 8											
213	20	7015	7015	-79	3	-76	≤ -62.0	10	100	90	Pass
207	160	6985	6910	-79	3	-76	≤ -62.0	10	100	90	Pass
207	160	6985	6985	-78	3	-75	≤ -62.0	10	100	90	Pass
207	160	6985	7060	-78	3	-75	≤ -62.0	10	100	90	Pass

Note 1: Adjust Power (dBm) = AWGN Power (dBm) – Antenna Gain (dBi).

Note 2: Conducted measurements are used.

Test Site	SR6	Test Engineer	Peter
Test Date	2022/12/20 ~ 2022/12/22		
Remark	Lowest Interference (AWGN) Level Check		

Bandwidth (MHz)	Freq. (MHz)	AWGN Freq. (MHz)	Adjust Power (dBm)	EUT Tx Status
Operation Band: U-NII 5				
20	6115	6115	-80	ON
			-76	Minimal
			-75	OFF
160	6185	6110	-80	ON
			-76	Minimal
			-75	OFF
160	6185	6185	-80	ON
			-76	Minimal
			-75	OFF
160	6185	6260	-80	ON
			-75	Minimal
			-74	OFF
Operation Band: U-NII 6				
20	6435	6435	-80	ON
			-75	Minimal
			-74	OFF
80	6465	6430	-80	ON
			-77	Minimal
			-76	OFF
80	6465	6465	-80	ON
			-76	Minimal
			-75	OFF
80	6465	6500	-80	ON
			-77	Minimal
			-76	OFF

Bandwidth (MHz)	Freq. (MHz)	AWGN Freq. (MHz)	Adjust Power (dBm)	EUT Status
Operation Band: U-NII 7				
20	6695	6695	-80	ON
			-77	Minimal
			-76	OFF
160	6665	6590	-80	ON
			-76	Minimal
			-75	OFF
160	6665	6665	-80	ON
			-75	Minimal
			-74	OFF
160	6665	6740	-80	ON
			-76	Minimal
			-75	OFF
Operation Band: U-NII 8				
20	7015	7015	-80	ON
			-77	Minimal
			-76	OFF
160	6985	6910	-80	ON
			-77	Minimal
			-76	OFF
160	6985	6985	-80	ON
			-76	Minimal
			-75	OFF
160	6985	7060	-80	ON
			-76	Minimal
			-75	OFF
<p>Note:</p> <p>OFF: AWGN level at which no transmission is detected, consistently for a minimum period of 10 seconds</p> <p>Minimal: AWGN level at which the system begins to trigger the transmission switch-off, albeit not being kept off consistently</p> <p>ON: AWGN level at which no impact on the transmission is detected, consistently for a minimum period of 10 seconds</p>				

AWGN Signal Level (at Antenna Port) Calibration Plots (NII-5 Band)

802.11ax-HE20 / CH33

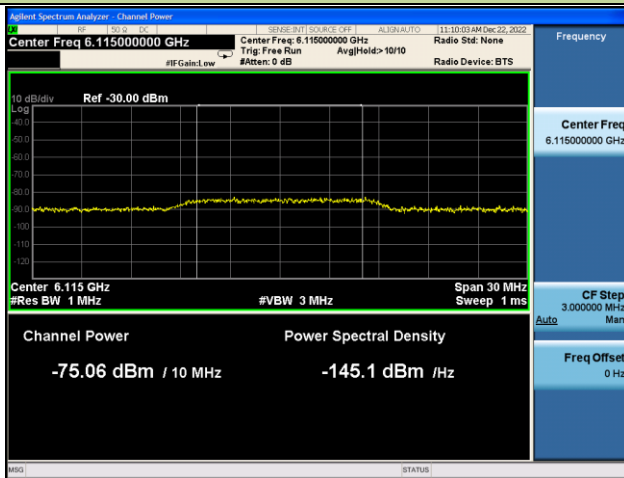

802.11ax-HE160 / CH47 (Low Edge)

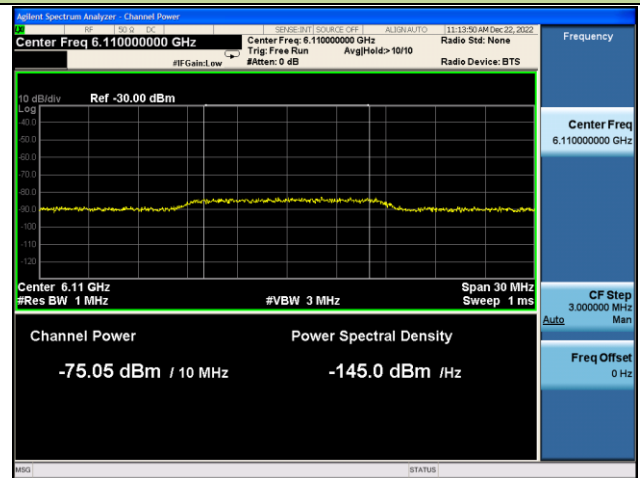

802.11ax-HE160 / CH47 (Middle)

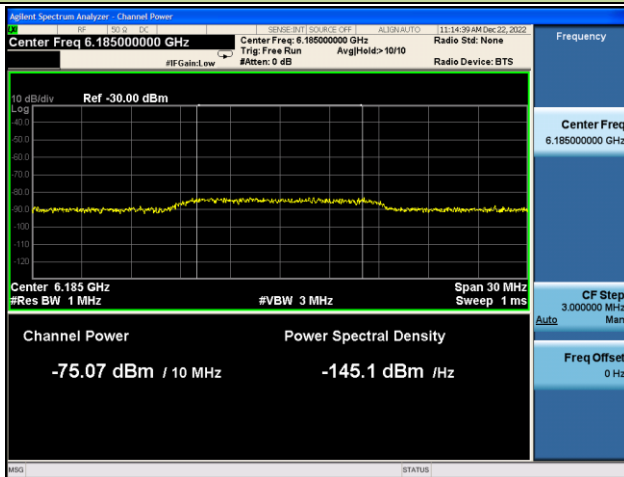

802.11ax-HE160 / CH47 (High Edge)

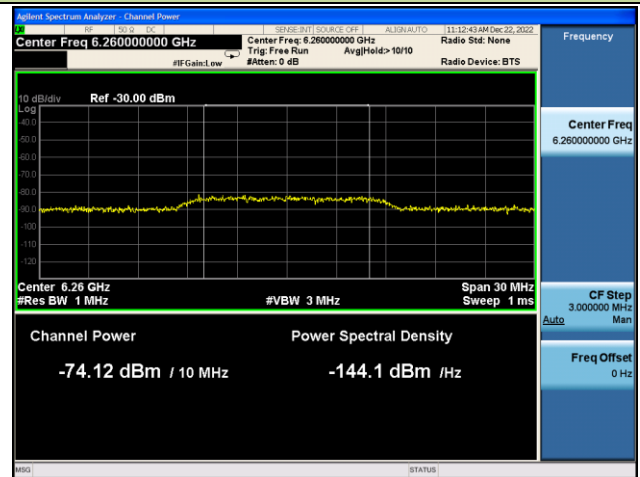

AWGN Signal Level (at Antenna Port) Calibration Plots (NII-6 Band)

802.11ax-HE20 / CH97

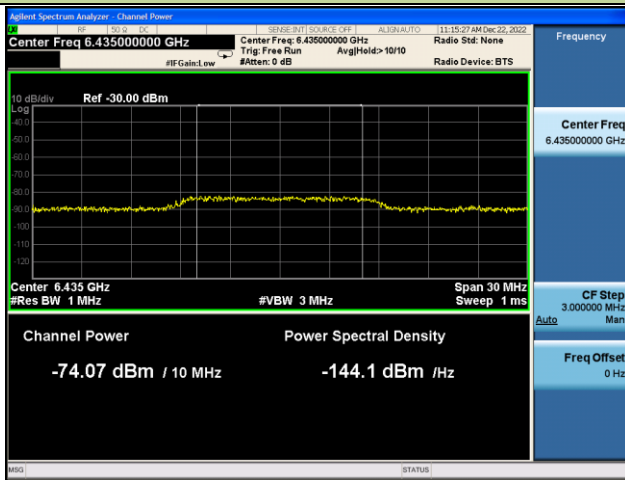

802.11ax-HE80 / CH103 (Low Edge)

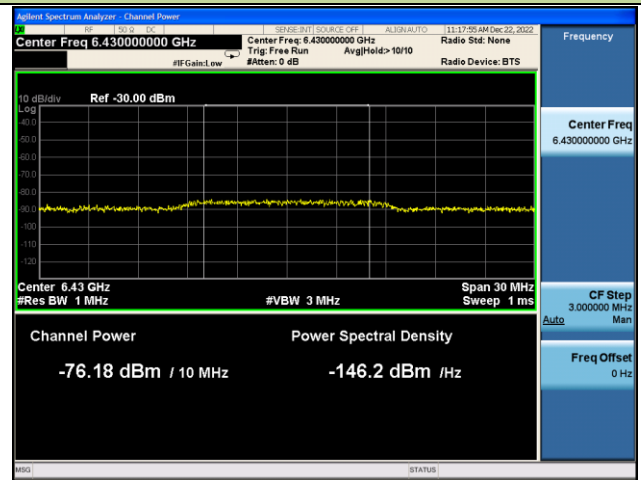

802.11ax-HE80 / CH103 (Middle)

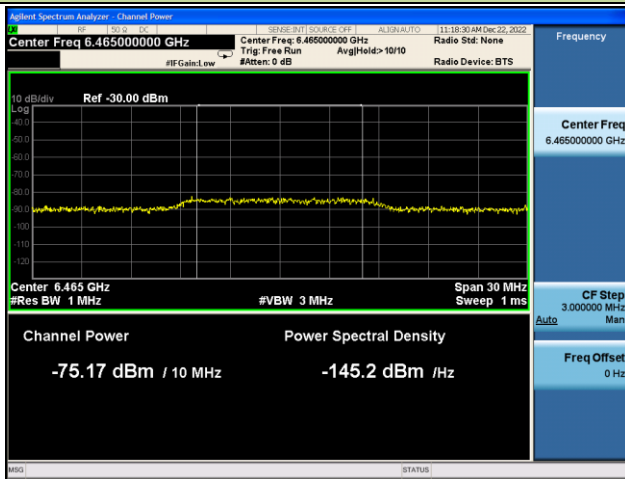

802.11ax-HE80 / CH103 (High Edge)

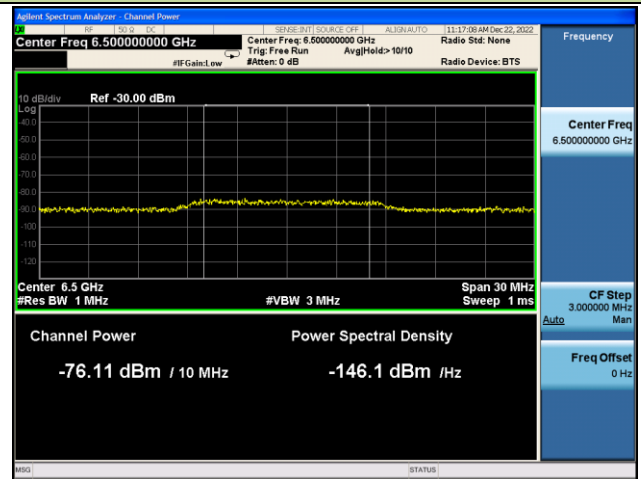

AWGN Signal Level (at Antenna Port) Calibration Plots (NII-7 Band)

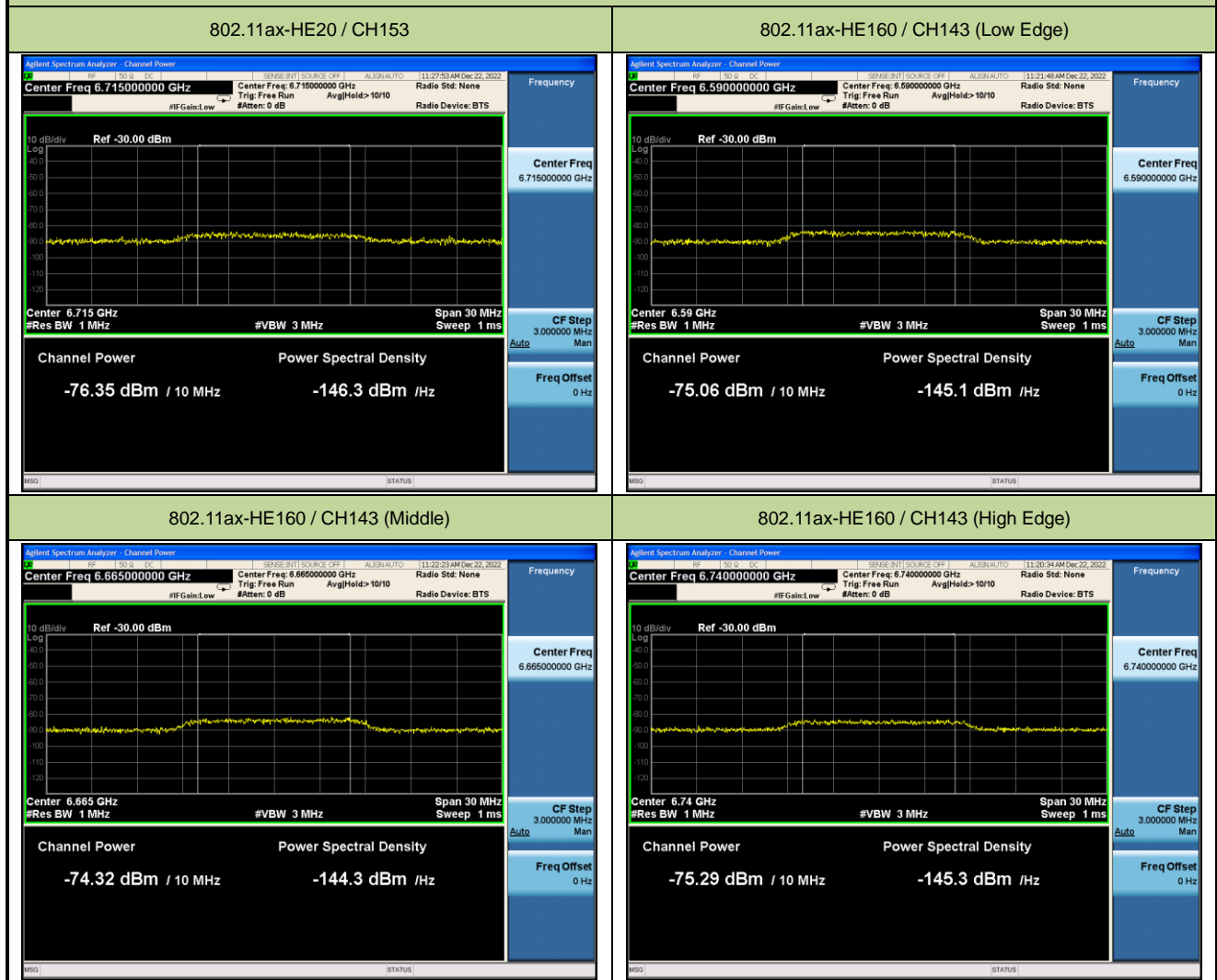

AWGN Signal Level (at Antenna Port) Calibration Plots (NII-8 Band)

802.11ax-HE20 / CH213

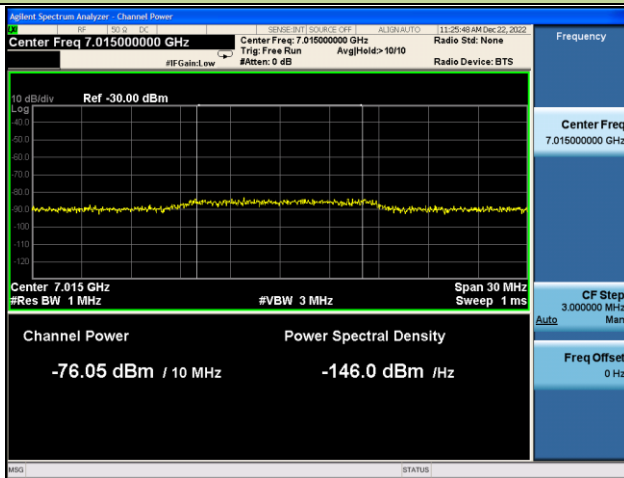

802.11ax-HE160 / CH207 (Low Edge)

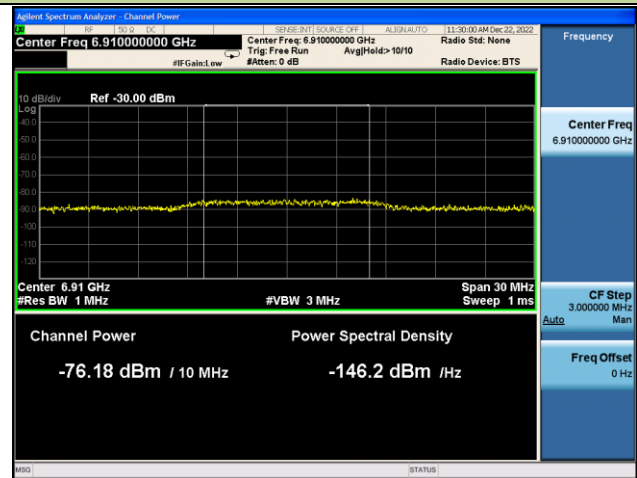

802.11ax-HE160 / CH207 (Middle)

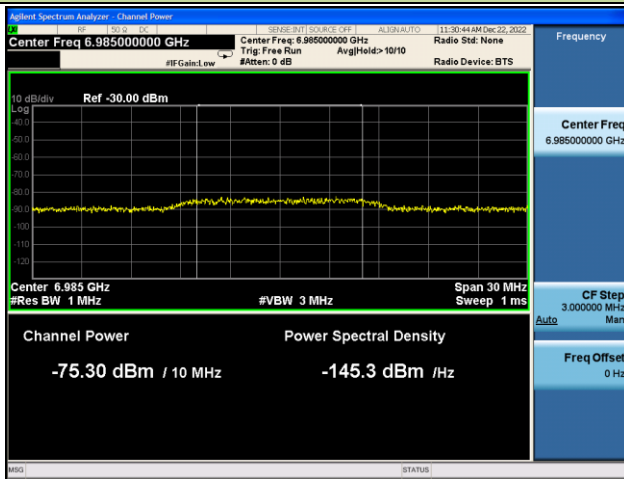

802.11ax-HE160 / CH207 (High Edge)

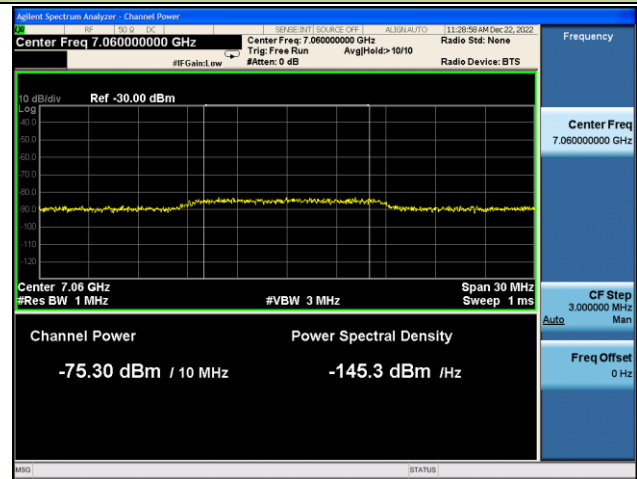

Test Result of EUT ceased transmission (NII-5 Band)

802.11ax-HE20 / CH33



802.11ax-HE160 / CH47 (Low Edge)

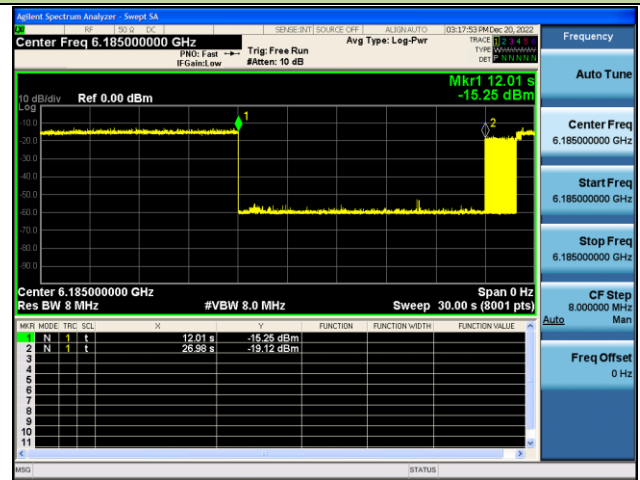

802.11ax-HE160 / CH47 (Middle)

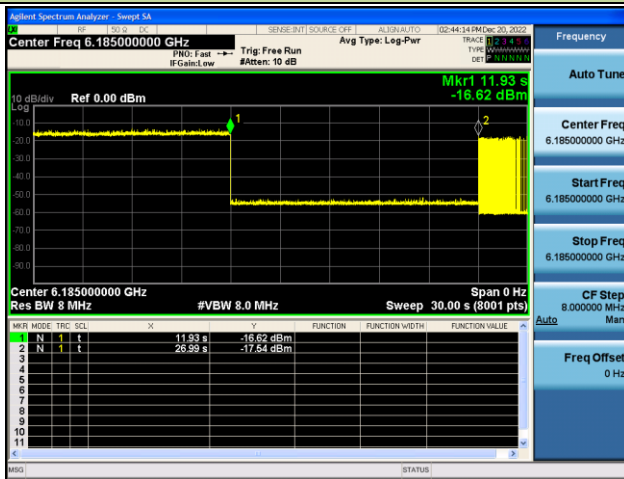

802.11ax-HE160 / CH47 (High Edge)

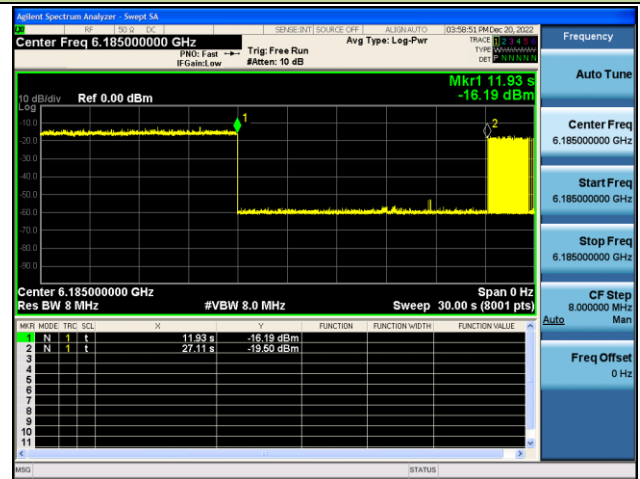

Note – M1: Injection of AWGN Signal, M2: Removal of AWGN Signal

Test Result of EUT ceased transmission (NII-6 Band)

802.11ax-HE20 / CH97



802.11ax-HE80 / CH103 (Low Edge)



802.11ax-HE80 / CH103 (Middle)

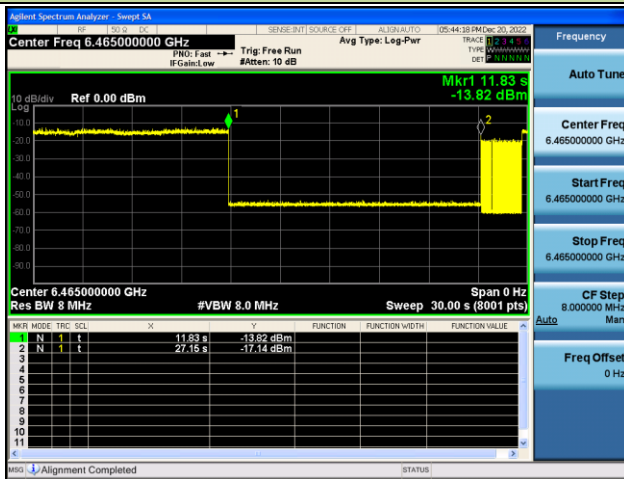

802.11ax-HE80 / CH103 (High Edge)

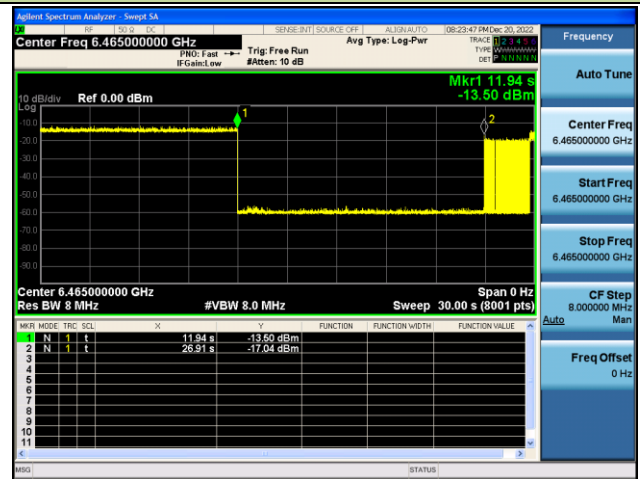

Note – M1: Injection of AWGN Signal, M2: Removal of AWGN Signal

Test Result of EUT ceased transmission (NII-7 Band)

802.11ax-HE20 / CH153

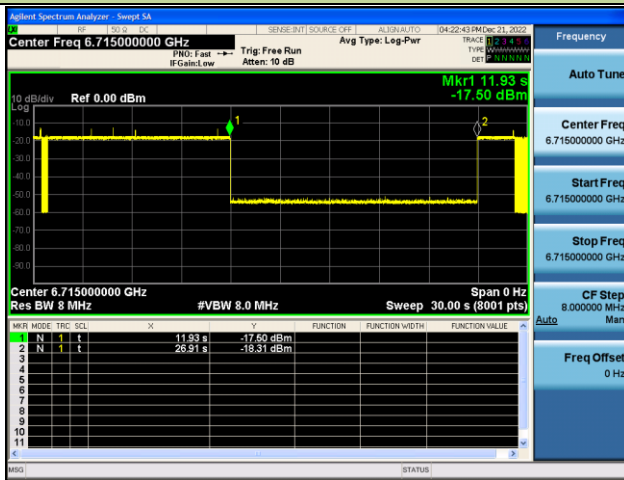

802.11ax-HE160 / CH143 (Low Edge)

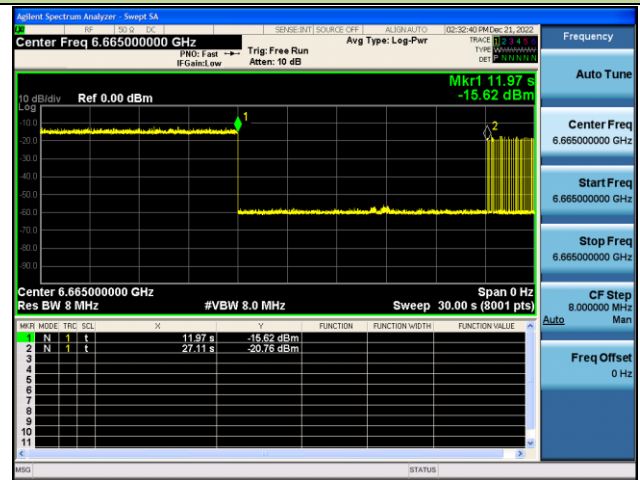

802.11ax-HE160 / CH143 (Middle)

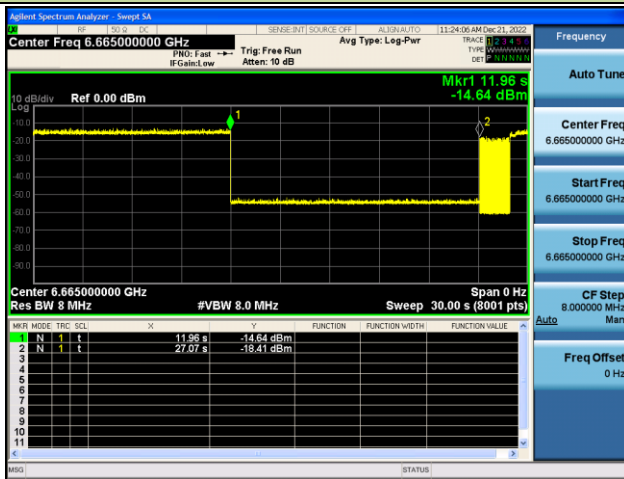

802.11ax-HE160 / CH143 (High Edge)

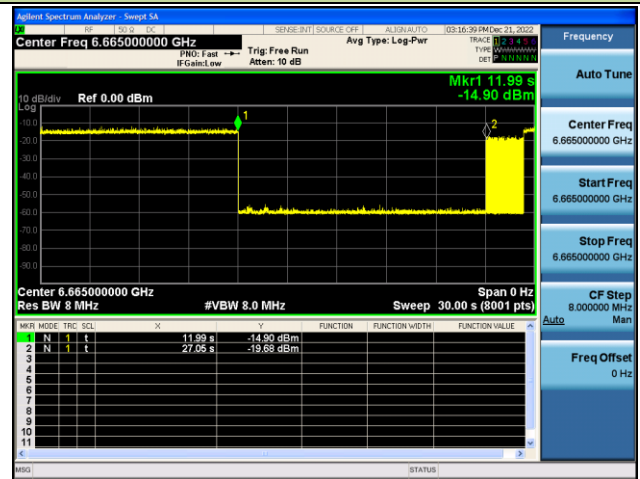

Note – M1: Injection of AWGN Signal, M2: Removal of AWGN Signal

Test Result of EUT ceased transmission (NII-8 Band)

802.11ax-HE20 / CH213

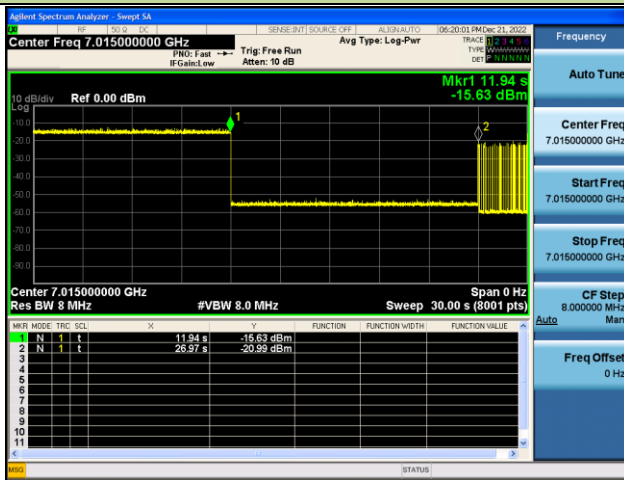

802.11ax-HE160 / CH207 (Low Edge)

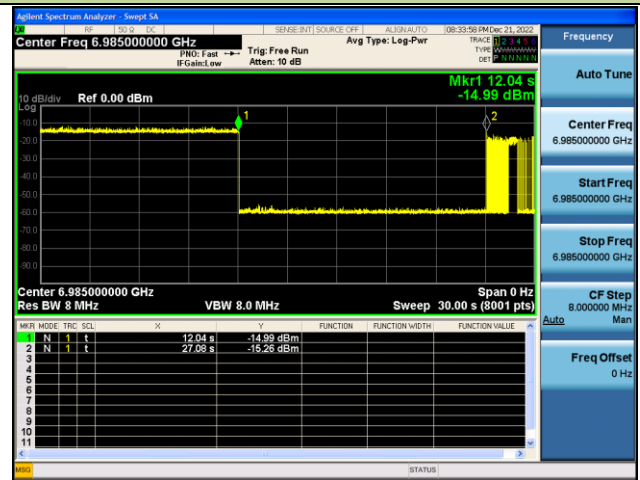

802.11ax-HE160 / CH207 (Middle)

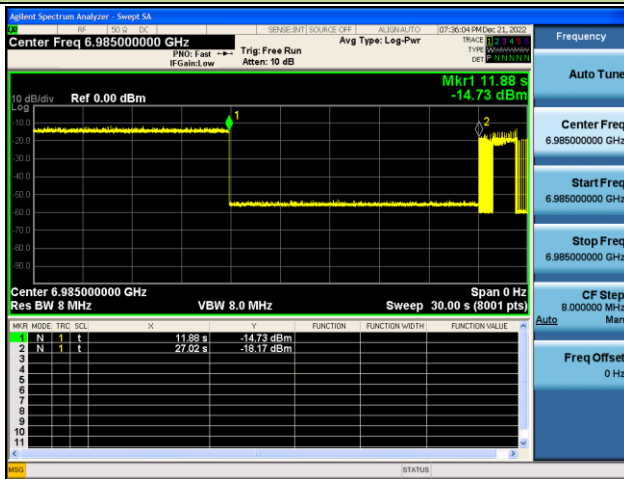

802.11ax-HE160 / CH207 (High Edge)

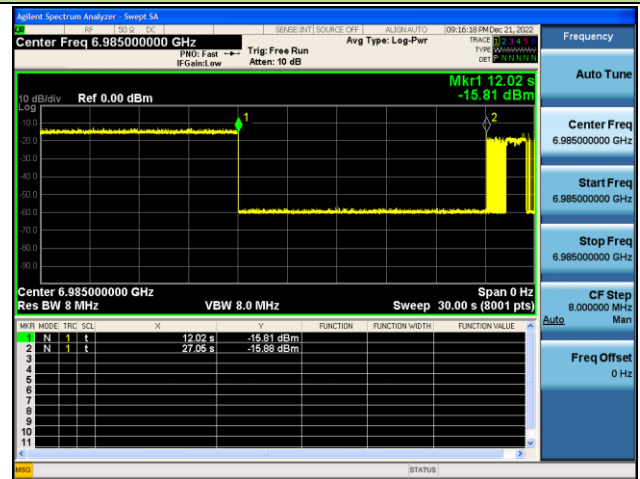

Note – M1: Injection of AWGN Signal, M2: Removal of AWGN Signal

6.8. Radiated Spurious Emission

6.8.1. Test Limit

For 15.407(b)(5) requirement

For transmitters operating within the 5.925-7.125 GHz band: Any emissions outside of the 5.925-7.125 GHz band must not exceed an e.i.r.p. of -27 dBm/MHz.

Refer to 987594 D02 U-NII 6GHz EMC Measurement v01 clause G

Use guidance in KDB 789033 for measurements below 1000 MHz and above 1000 MHz. Unwanted emissions outside of restricted bands are measured with a RMS detector. In addition, 15.35(b) applies where the peak emissions must be limited to no more than 20 dB above the average limit.

All out of band emissions appearing in a restricted band as specified in Section 15.205 of the Title 47CFR must not exceed the limits shown in Table per Section 15.209.

FCC Part 15 Subpart C Paragraph 15.209		
Frequency [MHz]	Field Strength [uV/m]	Measured Distance [Meters]
0.009 - 0.490	2400/F (kHz)	300
0.490 - 1.705	24000/F (kHz)	30
1.705 - 30	30	30
30 - 88	100	3
88 - 216	150	3
216 - 960	200	3
Above 960	500	3

6.8.2. Test Procedure Used

KDB 789033 D02v02r01- Section II) G

6.8.3. Test Setting

Table 1 - RBW as a function of frequency

Frequency	RBW
9 ~ 150 kHz	200 ~ 300 Hz
0.15 ~ 30 MHz	9 ~ 10 kHz
30 ~ 1000 MHz	100 ~ 120 kHz
> 1000MHz	1MHz

Quasi-Peak Measurements below 1GHz

1. Analyzer center frequency was set to the frequency of the radiated spurious emission of interest
2. Span was set greater than 1MHz
3. RBW = as specified in Table 1
4. Detector = CISPR quasi-peak
5. Sweep time = auto couple
6. Trace was allowed to stabilize

Peak Measurements above 1GHz

1. Analyzer center frequency was set to the frequency of the radiated spurious emission of interest
2. RBW = 1MHz
3. VBW = 3MHz
4. Detector = peak
5. Sweep time = auto couple
6. Trace mode = max hold
7. Trace was allowed to stabilize

Average Measurements above 1GHz (Method VB)

1. Analyzer center frequency was set to the frequency of the radiated spurious emission of interest
2. RBW = 1MHz
3. VBW; If the EUT is configured to transmit with duty cycle $\geq 98\%$, set VBW = 10 Hz.
If the EUT duty cycle is $< 98\%$, set VBW $\geq 1/T$. T is the minimum transmission duration.
4. Detector = Peak
5. Sweep time = auto
6. Trace mode = max hold
7. Trace was allowed to stabilize

6.8.4. Test Setup

Below 1GHz Test Setup:

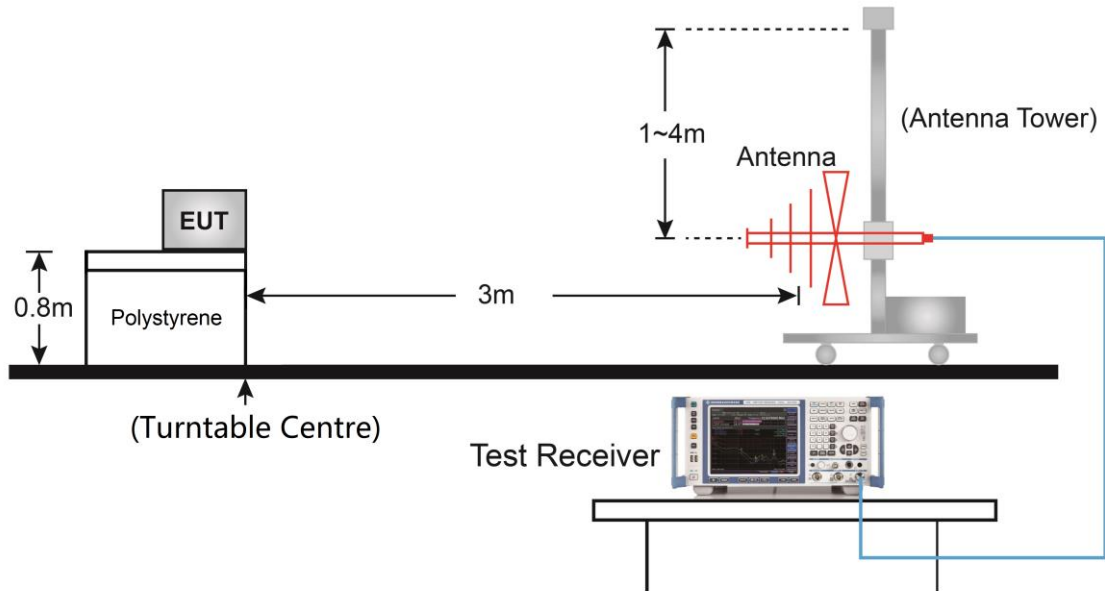

Above 1GHz Test Setup:

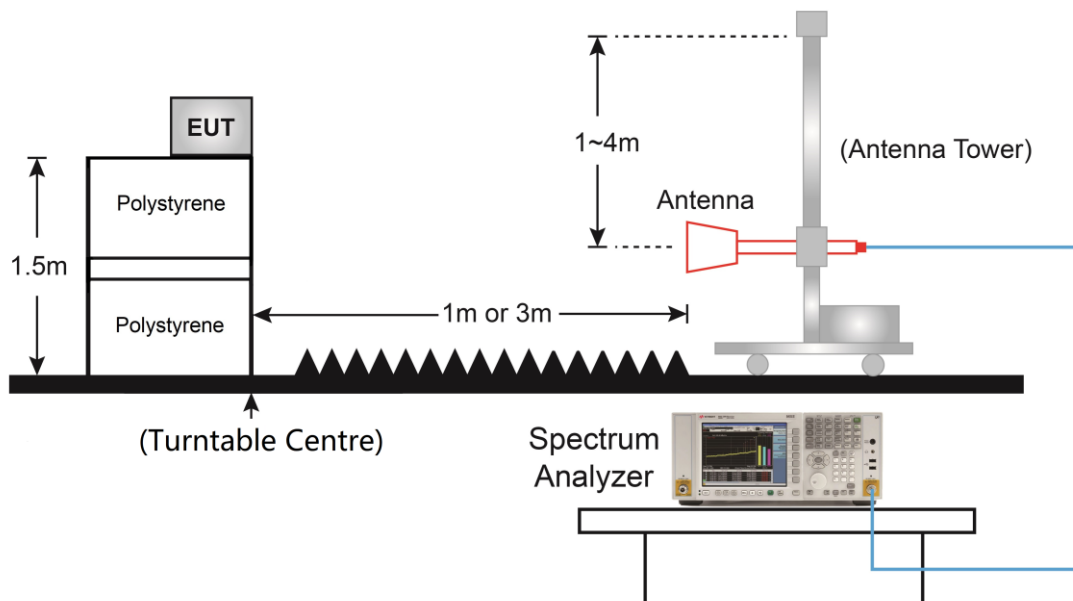

6.8.5. Test Result

EUT	AXE11000 Tri-Band Wi-Fi 6E Router	Date of Test	2022-12-21
Factor	VULB 9162	Temp. / Humidity	25°C /65%
Polarity	Horizontal	Site / Test Engineer	AC2 / Xuan
Test Mode	802.11ax-20MHz_TX_Band5_CH 33_ANT 0+1+2+3_NSS1	Test Voltage	AC 120V/60Hz

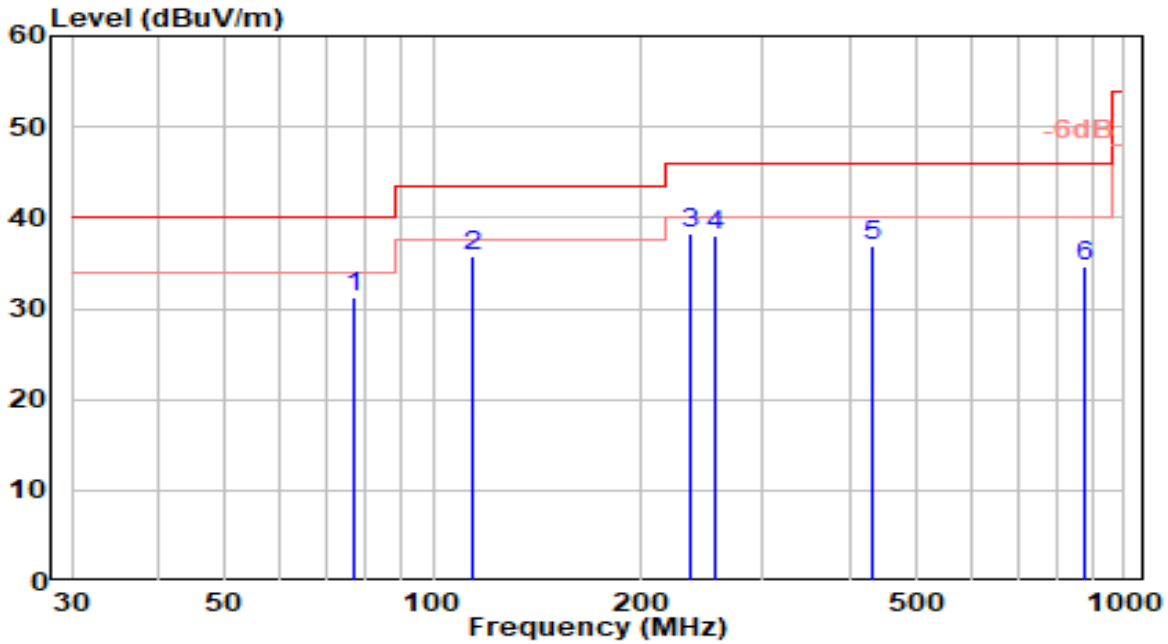

No	Frequency (MHz)	Reading (dBuV)	C.F (dB/m)	Measurement (dBuV/m)	Margin (dB)	Limit (dBuV/m)	Height (cm)	Angle (deg)	Remark (QP/PK/AV)
1	77.000	16.27	14.93	31.19	-8.81	40.00	200	300	QP
2	113.910	17.45	18.35	35.80	-7.70	43.50	100	194	QP
3	* 236.420	18.23	20.12	38.35	-7.65	46.00	200	127	QP
4	255.890	17.16	20.79	37.95	-8.05	46.00	200	116	QP
5	431.800	12.63	24.29	36.91	-9.09	46.00	100	98	QP
6	878.470	3.35	31.33	34.68	-11.32	46.00	100	145	QP

Note:

1. " *", means this data is the worst emission level.
2. C.F (Correction Factor) = Antenna Factor (dB/m) + Cable Loss (dB).
3. Measurement (dBuV/m) = Reading(dBuV) + C.F (Correction Factor).
4. The emission levels of other frequencies are very lower than the limit and not show in test report.

EUT	AXE11000 Tri-Band Wi-Fi 6E Router	Date of Test	2022-12-21
Factor	VULB 9162	Temp. / Humidity	25°C /65%
Polarity	Vertical	Site / Test Engineer	AC2 / Xuan
Test Mode	802.11ax-20MHz_TX_Band5_CH 33_ANT 0+1+2+3_NSS1	Test Voltage	AC 120V/60Hz

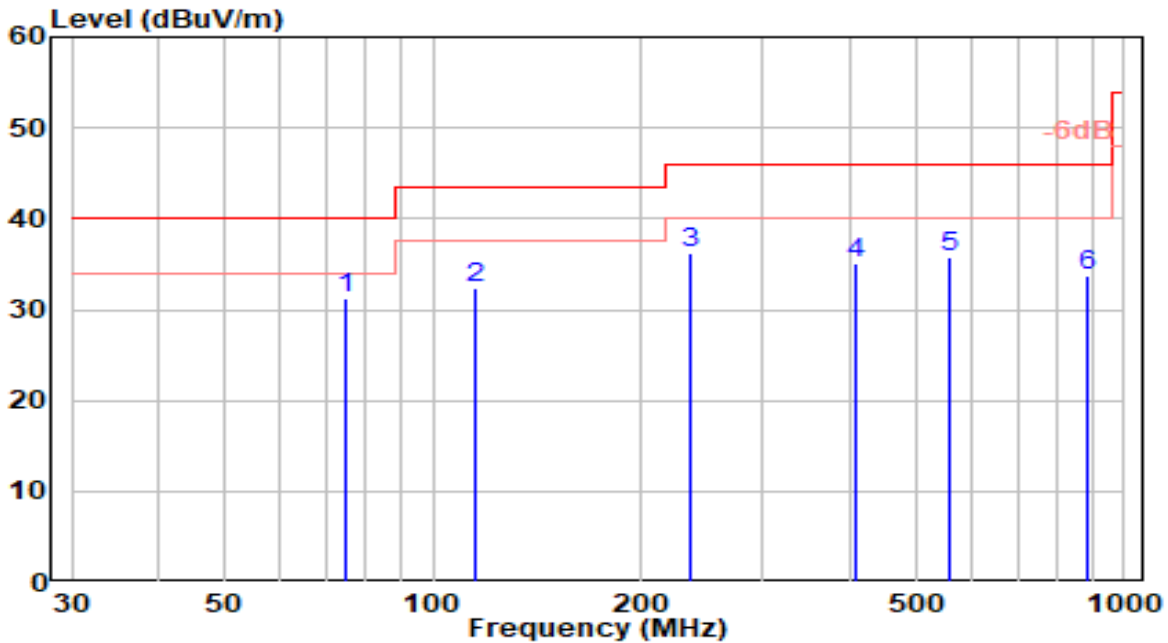

No	Frequency (MHz)	Reading (dBUV)	C.F (dB/m)	Measurement (dBUV/m)	Margin (dB)	Limit (dBUV/m)	Height (cm)	Angle (deg)	Remark (QP/PK/AV)
1	* 74.700	15.90	15.37	31.27	-8.73	40.00	200	200	QP
2	114.920	14.05	18.23	32.28	-11.22	43.50	150	191	QP
3	234.900	16.11	20.04	36.15	-9.85	46.00	100	144	QP
4	407.220	11.06	24.10	35.15	-10.85	46.00	150	179	QP
5	557.720	9.22	26.61	35.83	-10.17	46.00	200	96	QP
6	887.870	2.20	31.46	33.66	-12.34	46.00	150	62	QP

Note:

1. " *", means this data is the worst emission level.
2. C.F (Correction Factor) = Antenna Factor (dB/m) + Cable Loss (dB).
3. Measurement (dBUV/m) = Reading(dBUV) + C.F (Correction Factor).
4. The emission levels of other frequencies are very lower than the limit and not show in test report.

EUT	AXE11000 Tri-Band Wi-Fi 6E Router	Date of Test	2023-02-02
Factor	VULB 9162	Temp. / Humidity	25°C /65%
Polarity	Horizontal	Site / Test Engineer	AC2 / Xuan
Test Mode	802.11ax-20MHz_TX_Band5_CH 61_ANT 0+1+2+3_NSS4	Test Voltage	AC 120V/60Hz

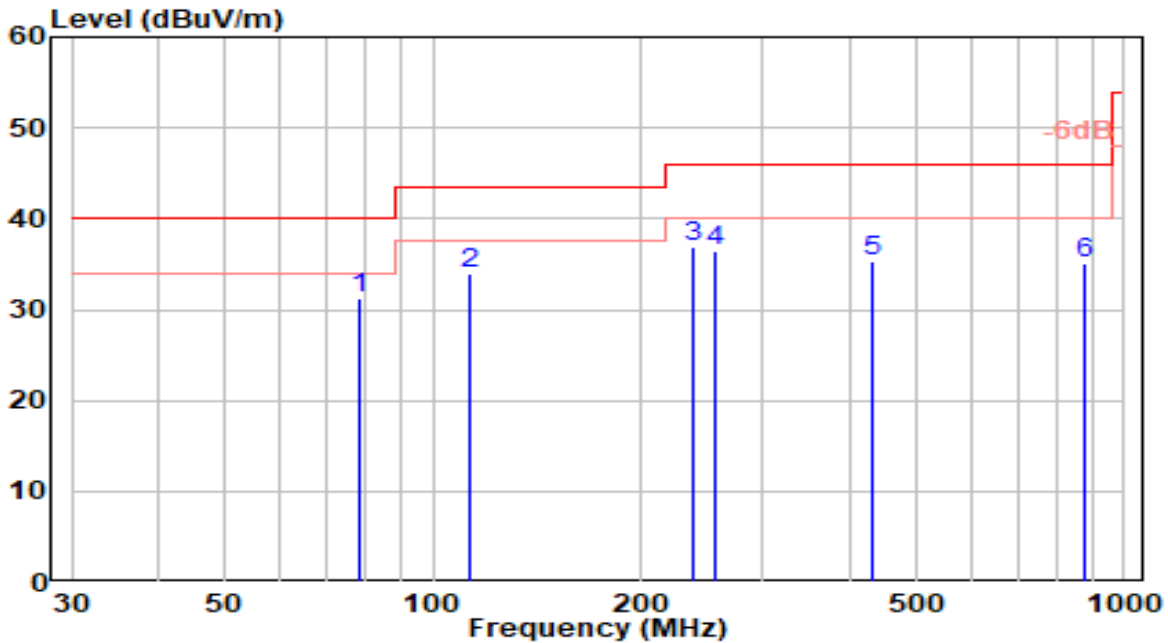

No	Frequency (MHz)	Reading (dBUV)	C.F (dB/m)	Measurement (dBUV/m)	Margin (dB)	Limit (dBUV/m)	Height (cm)	Angle (deg)	Remark (QP/PK/AV)
1	*	16.65	14.67	31.31	-8.69	40.00	150	314	QP
2		15.52	18.48	34.00	-9.50	43.50	100	208	QP
3		16.61	20.20	36.81	-9.19	46.00	150	141	QP
4		15.61	20.79	36.41	-9.59	46.00	200	130	QP
5		11.08	24.30	35.37	-10.63	46.00	100	112	QP
6		3.82	31.32	35.14	-10.86	46.00	100	159	QP

Note:

1. " *", means this data is the worst emission level.
2. C.F (Correction Factor) = Antenna Factor (dB/m) + Cable Loss (dB).
3. Measurement (dBUV/m) = Reading(dBUV) + C.F (Correction Factor).
4. The emission levels of other frequencies are very lower than the limit and not show in test report.

EUT	AXE11000 Tri-Band Wi-Fi 6E Router	Date of Test	2023-02-02
Factor	VULB 9162	Temp. / Humidity	25°C /65%
Polarity	Vertical	Site / Test Engineer	AC2 / Xuan
Test Mode	802.11ax-20MHz_TX_Band5_CH 61_ANT 0+1+2+3_NSS4	Test Voltage	AC 120V/60Hz

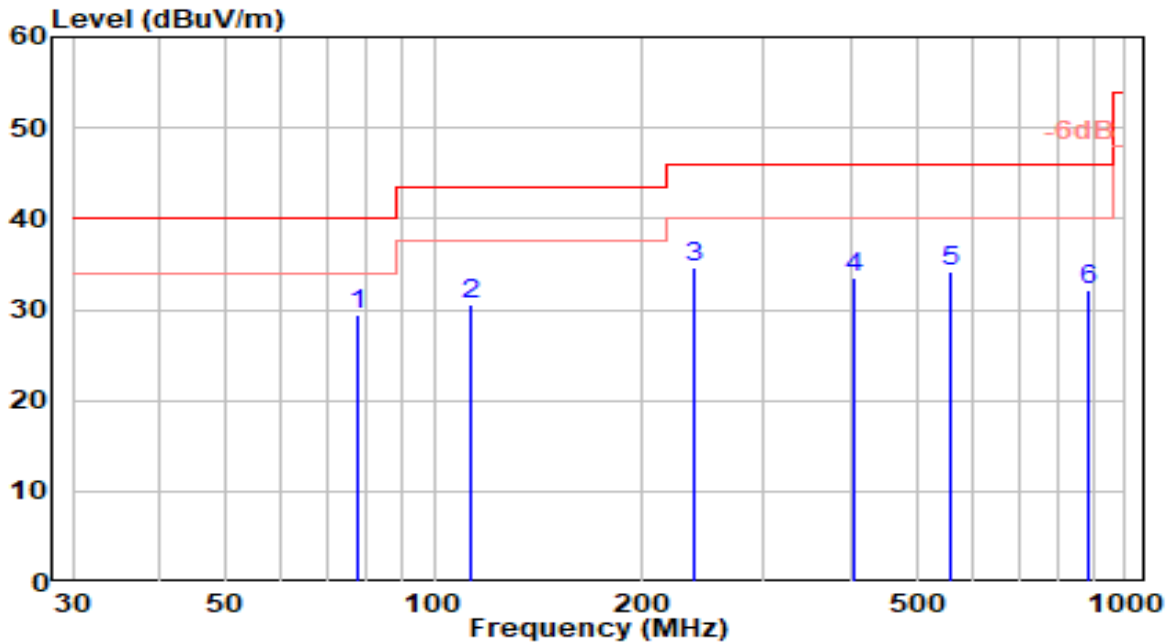

No	Frequency (MHz)	Reading (dBUV)	C.F (dB/m)	Measurement (dBUV/m)	Margin (dB)	Limit (dBUV/m)	Height (cm)	Angle (deg)	Remark (QP/PK/AV)
1	*	14.54	14.85	29.39	-10.61	40.00	100	214	QP
2		12.00	18.48	30.48	-13.02	43.50	100	205	QP
3		14.41	20.20	34.61	-11.39	46.00	100	158	QP
4		9.53	24.08	33.61	-12.39	46.00	150	193	QP
5		7.62	26.67	34.29	-11.71	46.00	150	110	QP
6		0.68	31.44	32.12	-13.88	46.00	200	76	QP

Note:

1. " *", means this data is the worst emission level.
2. C.F (Correction Factor) = Antenna Factor (dB/m) + Cable Loss (dB).
3. Measurement (dBUV/m) = Reading(dBUV) + C.F (Correction Factor).
4. The emission levels of other frequencies are very lower than the limit and not show in test report.

EUT	AXE11000 Tri-Band Wi-Fi 6E Router	Date of Test	2022-12-26
Factor	DRH18-E	Temp. / Humidity	25°C /65%
Polarity	Horizontal	Site / Test Engineer	AC2 / Xuan
Test Mode	802.11ax-20MHz_TX_Band5_CH 33_ANT 0+1+2+3_NSS1	Test Voltage	AC 120V/60Hz

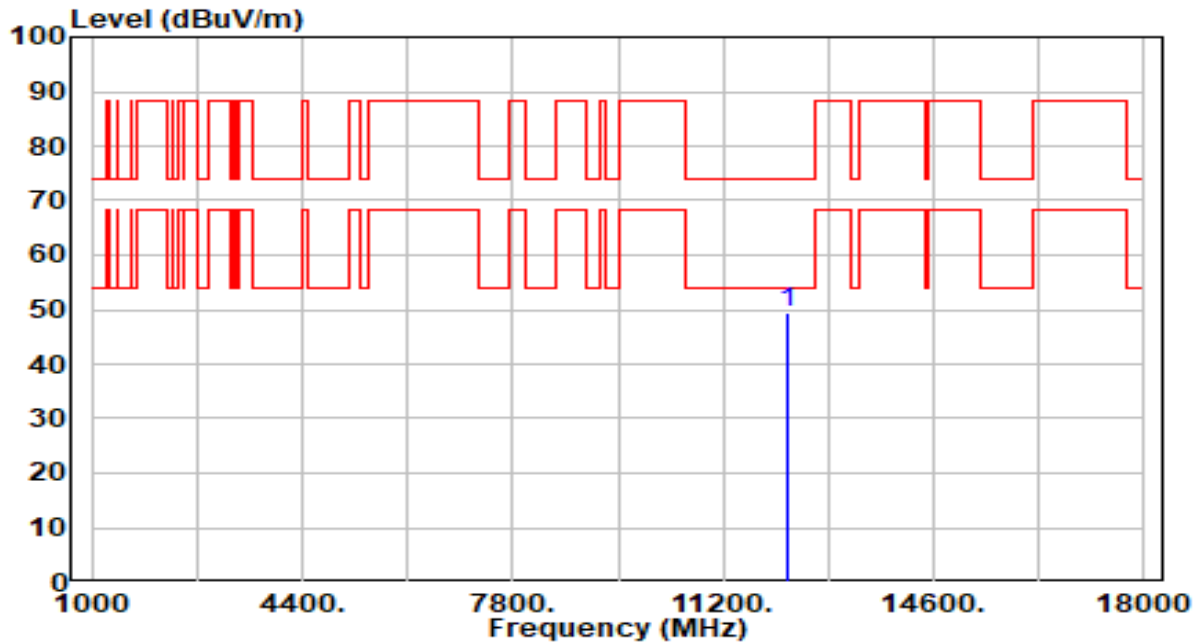

No	Frequency (MHz)	Reading (dBuV)	C.F (dB/m)	Measurement (dBuV/m)	Margin (dB)	Limit (dBuV/m)	Height (cm)	Angle (deg)	Remark (QP/PK/AV)
1	*	43.31	6.13	49.44	-24.56	74.00	100	54	Peak

Note:

1. " *", means this data is the worst emission level.
2. C.F (Correction Factor) = Antenna Factor (dB/m) + Cable Loss (dB) – Preamplifier(dB).
3. Measurement (dBuV/m) = Reading(dBuV) + C.F (Correction Factor).
4. The emission levels of other frequencies are very lower than the limit and not show in test report.

EUT	AXE11000 Tri-Band Wi-Fi 6E Router	Date of Test	2022-12-26
Factor	DRH18-E	Temp. / Humidity	25°C /65%
Polarity	Vertical	Site / Test Engineer	AC2 / Xuan
Test Mode	802.11ax-20MHz_TX_Band5_CH 33_ANT 0+1+2+3_NSS1	Test Voltage	AC 120V/60Hz

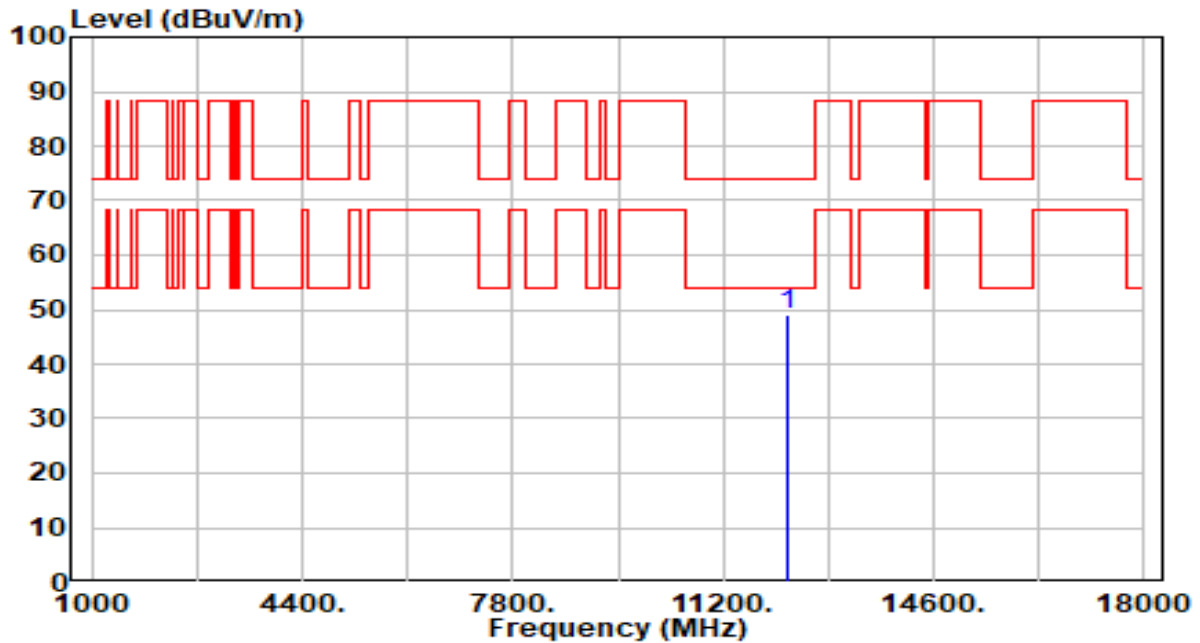

No	Frequency (MHz)	Reading (dBuV)	C.F (dB/m)	Measurement (dBuV/m)	Margin (dB)	Limit (dBuV/m)	Height (cm)	Angle (deg)	Remark (QP/PK/AV)
1	*	42.92	6.13	49.05	-24.95	74.00	200	125	Peak

Note:

1. " *", means this data is the worst emission level.
2. C.F (Correction Factor) = Antenna Factor (dB/m) + Cable Loss (dB) – Preamplifier(dB).
3. Measurement (dBuV/m) = Reading(dBuV) + C.F (Correction Factor).
4. The emission levels of other frequencies are very lower than the limit and not show in test report.

EUT	AXE11000 Tri-Band Wi-Fi 6E Router	Date of Test	2022-12-26
Factor	DRH18-E	Temp. / Humidity	25°C /65%
Polarity	Horizontal	Site / Test Engineer	AC2 / Xuan
Test Mode	802.11ax-20MHz_TX_Band5_CH 61_ANT 0+1+2+3_NSS1	Test Voltage	AC 120V/60Hz

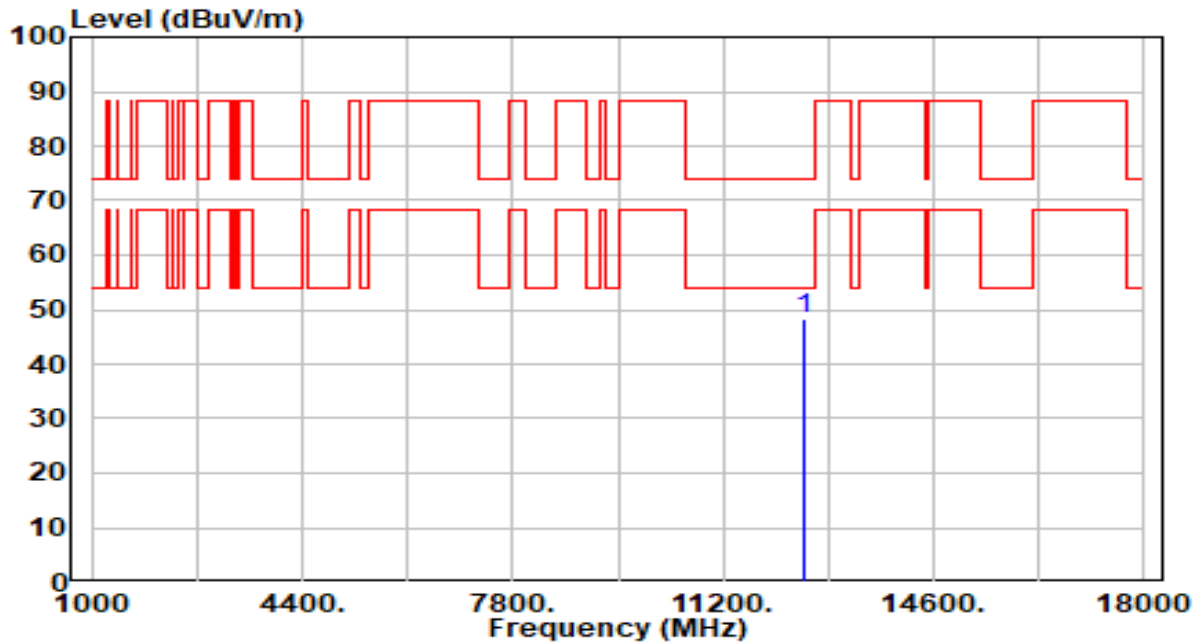

No	Frequency (MHz)	Reading (dBuV)	C.F (dB/m)	Measurement (dBuV/m)	Margin (dB)	Limit (dBuV/m)	Height (cm)	Angle (deg)	Remark (QP/PK/AV)
1	*	41.65	6.70	48.34	-25.66	74.00	100	216	Peak

Note:

1. " *", means this data is the worst emission level.
2. C.F (Correction Factor) = Antenna Factor (dB/m) + Cable Loss (dB) – Preamplifier(dB).
3. Measurement (dBuV/m) = Reading(dBuV) + C.F (Correction Factor).
4. The emission levels of other frequencies are very lower than the limit and not show in test report.

EUT	AXE11000 Tri-Band Wi-Fi 6E Router	Date of Test	2022-12-26
Factor	DRH18-E	Temp. / Humidity	25°C /65%
Polarity	Vertical	Site / Test Engineer	AC2 / Xuan
Test Mode	802.11ax-20MHz_TX_Band5_CH 61_ANT 0+1+2+3_NSS1	Test Voltage	AC 120V/60Hz

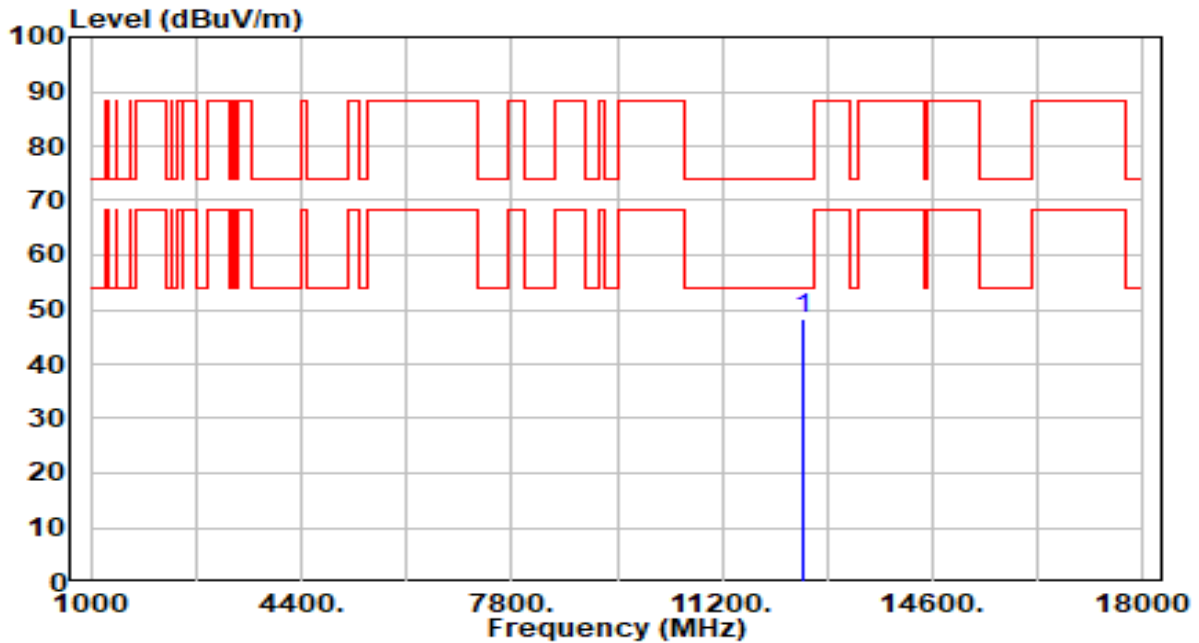

No	Frequency (MHz)	Reading (dBuV)	C.F (dB/m)	Measurement (dBuV/m)	Margin (dB)	Limit (dBuV/m)	Height (cm)	Angle (deg)	Remark (QP/PK/AV)
1	*	41.63	6.70	48.32	-25.68	74.00	200	320	Peak

Note:

1. " *", means this data is the worst emission level.
2. C.F (Correction Factor) = Antenna Factor (dB/m) + Cable Loss (dB) – Preamplifier(dB).
3. Measurement (dBuV/m) = Reading(dBuV) + C.F (Correction Factor).
4. The emission levels of other frequencies are very lower than the limit and not show in test report.

EUT	AXE11000 Tri-Band Wi-Fi 6E Router	Date of Test	2022-12-26
Factor	DRH18-E	Temp. / Humidity	25°C /65%
Polarity	Horizontal	Site / Test Engineer	AC2 / Xuan
Test Mode	802.11ax-20MHz_TX_Band5_CH 93_ANT 0+1+2+3_NSS1	Test Voltage	AC 120V/60Hz

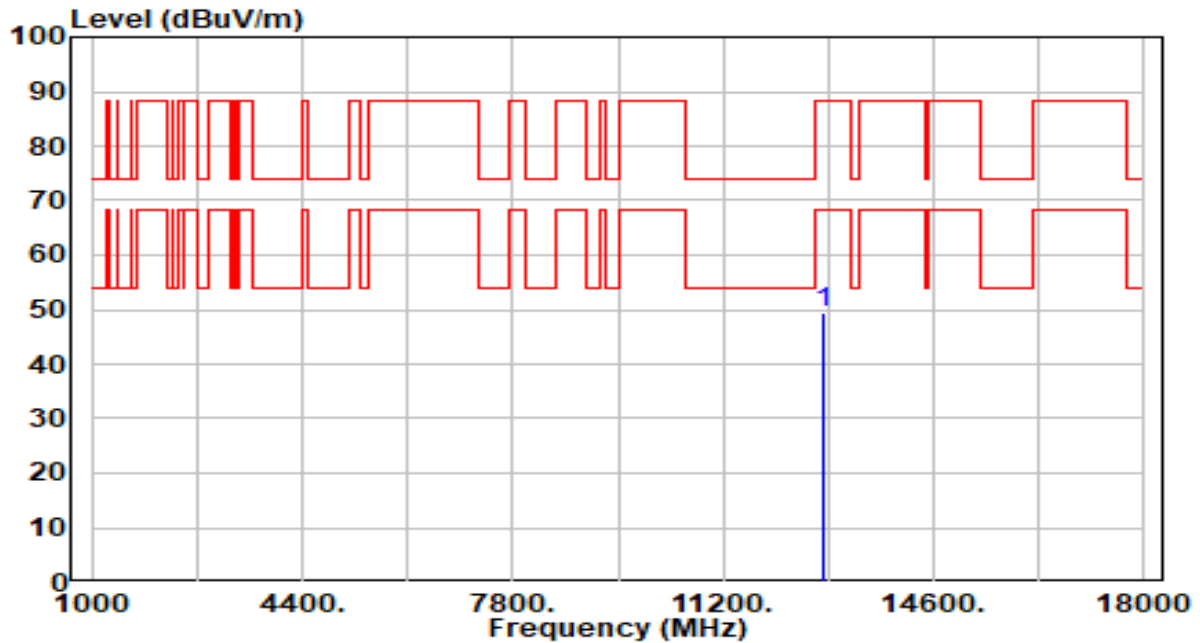

No	Frequency (MHz)	Reading (dBuV)	C.F (dB/m)	Measurement (dBuV/m)	Margin (dB)	Limit (dBuV/m)	Height (cm)	Angle (deg)	Remark (QP/PK/AV)
1	*	42.04	7.21	49.25	-38.95	88.20	100	123	Peak

Note:

1. " *", means this data is the worst emission level.
2. C.F (Correction Factor) = Antenna Factor (dB/m) + Cable Loss (dB) – Preamplifier(dB).
3. Measurement (dBuV/m) = Reading(dBuV) + C.F (Correction Factor).
4. The emission levels of other frequencies are very lower than the limit and not show in test report.

EUT	AXE11000 Tri-Band Wi-Fi 6E Router	Date of Test	2022-12-26
Factor	DRH18-E	Temp. / Humidity	25°C /65%
Polarity	Vertical	Site / Test Engineer	AC2 / Xuan
Test Mode	802.11ax-20MHz_TX_Band5_CH 93_ANT 0+1+2+3_NSS1	Test Voltage	AC 120V/60Hz

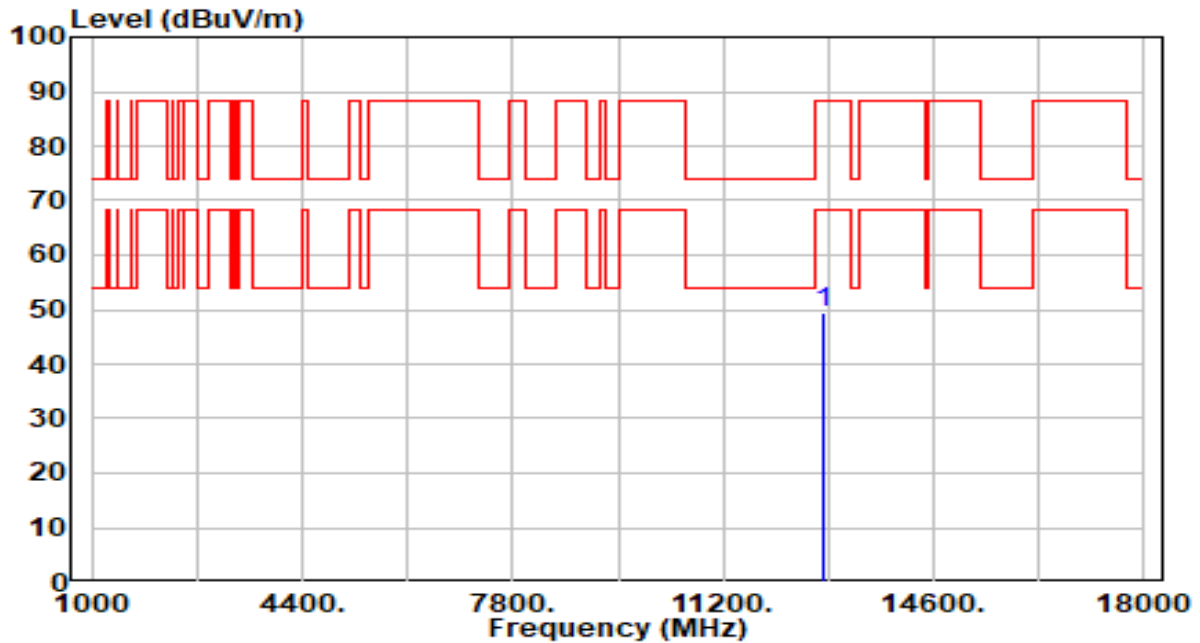

No	Frequency (MHz)	Reading (dBuV)	C.F (dB/m)	Measurement (dBuV/m)	Margin (dB)	Limit (dBuV/m)	Height (cm)	Angle (deg)	Remark (QP/PK/AV)
1	*	42.37	7.21	49.58	-38.62	88.20	200	3	Peak

Note:

1. " *", means this data is the worst emission level.
2. C.F (Correction Factor) = Antenna Factor (dB/m) + Cable Loss (dB) – Preamplifier(dB).
3. Measurement (dBuV/m) = Reading(dBuV) + C.F (Correction Factor).
4. The emission levels of other frequencies are very lower than the limit and not show in test report.

EUT	AXE11000 Tri-Band Wi-Fi 6E Router	Date of Test	2022-12-26
Factor	DRH18-E	Temp. / Humidity	25°C /65%
Polarity	Horizontal	Site / Test Engineer	AC2 / Xuan
Test Mode	802.11ax-20MHz_TX_Band6_CH 97_ANT 0+1+2+3_NSS1	Test Voltage	AC 120V/60Hz

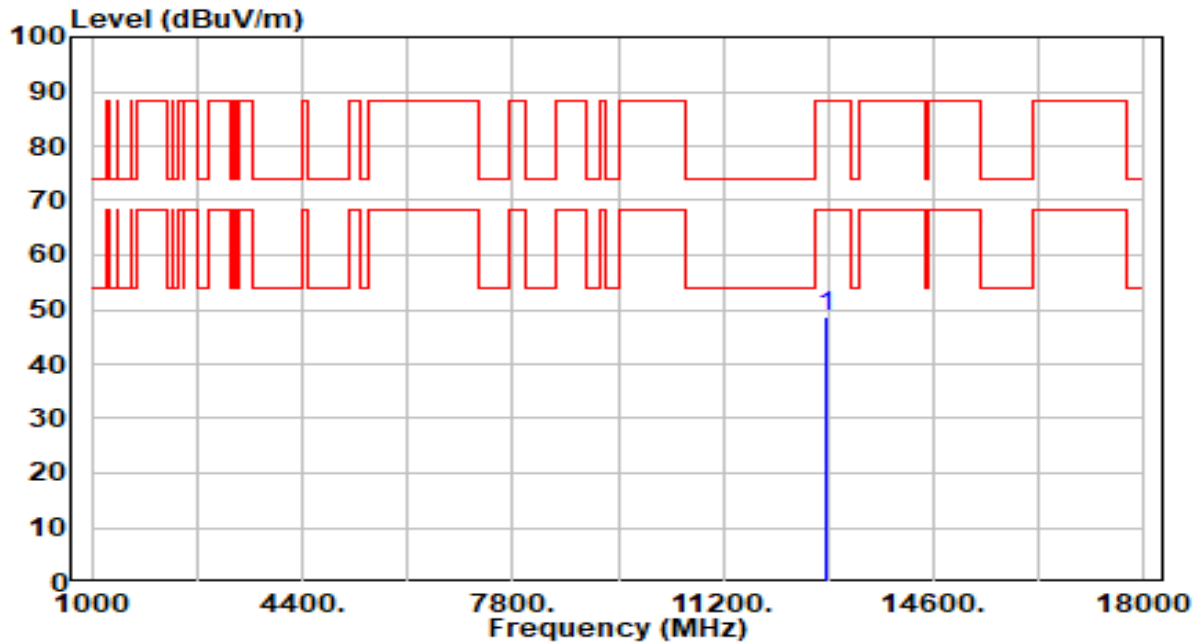

No	Frequency (MHz)	Reading (dBuV)	C.F (dB/m)	Measurement (dBuV/m)	Margin (dB)	Limit (dBuV/m)	Height (cm)	Angle (deg)	Remark (QP/PK/AV)
1	*	41.62	7.22	48.84	-39.36	88.20	100	115	Peak

Note:

1. " *", means this data is the worst emission level.
2. C.F (Correction Factor) = Antenna Factor (dB/m) + Cable Loss (dB) – Preamplifier(dB).
3. Measurement (dBuV/m) = Reading(dBuV) + C.F (Correction Factor).
4. The emission levels of other frequencies are very lower than the limit and not show in test report.

EUT	AXE11000 Tri-Band Wi-Fi 6E Router	Date of Test	2022-12-26
Factor	DRH18-E	Temp. / Humidity	25°C /65%
Polarity	Vertical	Site / Test Engineer	AC2 / Xuan
Test Mode	802.11ax-20MHz_TX_Band6_CH 97_ANT 0+1+2+3_NSS1	Test Voltage	AC 120V/60Hz

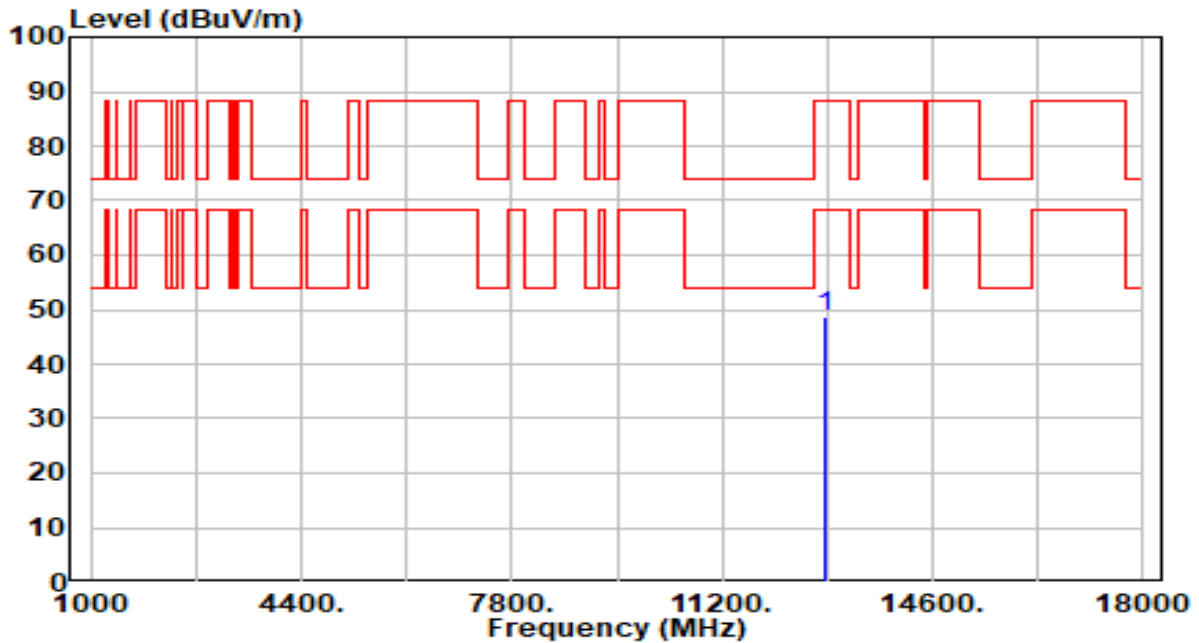

No	Frequency (MHz)	Reading (dBuV)	C.F (dB/m)	Measurement (dBuV/m)	Margin (dB)	Limit (dBuV/m)	Height (cm)	Angle (deg)	Remark (QP/PK/AV)
1	*	41.57	7.22	48.80	-39.40	88.20	200	70	Peak

Note:

1. " *", means this data is the worst emission level.
2. C.F (Correction Factor) = Antenna Factor (dB/m) + Cable Loss (dB) – Preamplifier(dB).
3. Measurement (dBuV/m) = Reading(dBuV) + C.F (Correction Factor).
4. The emission levels of other frequencies are very lower than the limit and not show in test report.

EUT	AXE11000 Tri-Band Wi-Fi 6E Router	Date of Test	2022-12-26
Factor	DRH18-E	Temp. / Humidity	25°C /65%
Polarity	Horizontal	Site / Test Engineer	AC2 / Xuan
Test Mode	802.11ax-20MHz_TX_Band6_CH 105_ANT 0+1+2+3_NSS1	Test Voltage	AC 120V/60Hz

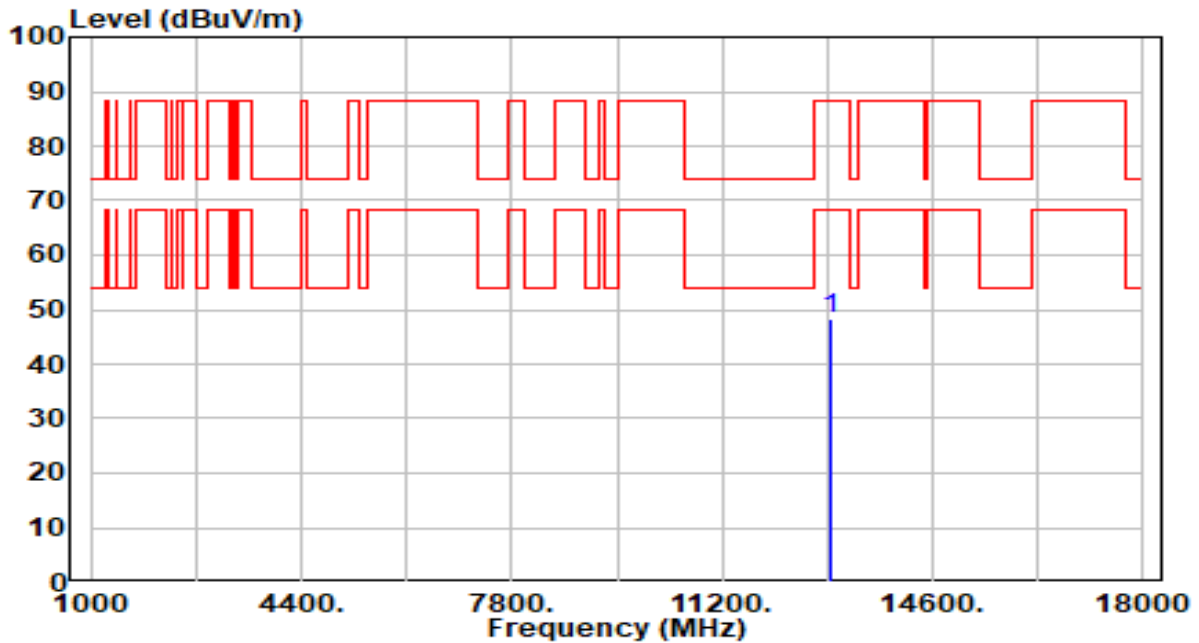

No	Frequency (MHz)	Reading (dBuV)	C.F (dB/m)	Measurement (dBuV/m)	Margin (dB)	Limit (dBuV/m)	Height (cm)	Angle (deg)	Remark (QP/PK/AV)	
1	*	12950.000	40.98	7.25	48.22	-39.98	88.20	100	337	Peak

Note:

1. " *", means this data is the worst emission level.
2. C.F (Correction Factor) = Antenna Factor (dB/m) + Cable Loss (dB) – Preamplifier(dB).
3. Measurement (dBuV/m) = Reading(dBuV) + C.F (Correction Factor).
4. The emission levels of other frequencies are very lower than the limit and not show in test report.

EUT	AXE11000 Tri-Band Wi-Fi 6E Router	Date of Test	2022-12-26
Factor	DRH18-E	Temp. / Humidity	25°C /65%
Polarity	Vertical	Site / Test Engineer	AC2 / Xuan
Test Mode	802.11ax-20MHz_TX_Band6_CH 105_ANT 0+1+2+3_NSS1	Test Voltage	AC 120V/60Hz

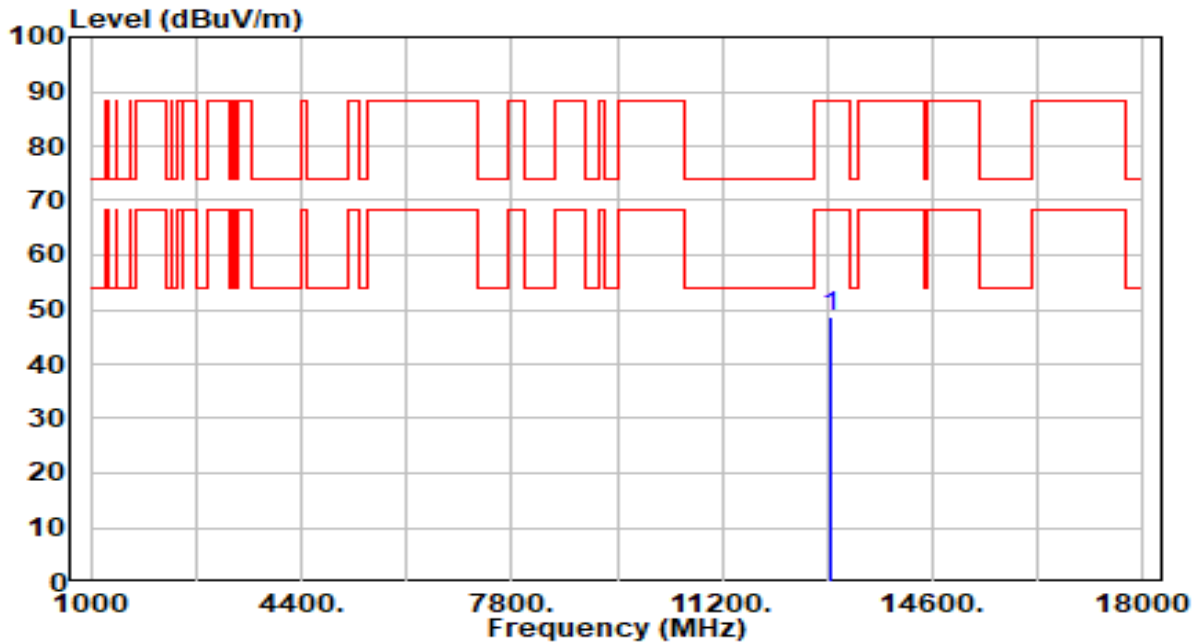

No	Frequency (MHz)	Reading (dBuV)	C.F (dB/m)	Measurement (dBuV/m)	Margin (dB)	Limit (dBuV/m)	Height (cm)	Angle (deg)	Remark (QP/PK/AV)
1	*	41.25	7.25	48.50	-39.70	88.20	200	332	Peak

Note:

1. " *", means this data is the worst emission level.
2. C.F (Correction Factor) = Antenna Factor (dB/m) + Cable Loss (dB) – Preamplifier(dB).
3. Measurement (dBuV/m) = Reading(dBuV) + C.F (Correction Factor).
4. The emission levels of other frequencies are very lower than the limit and not show in test report.

EUT	AXE11000 Tri-Band Wi-Fi 6E Router	Date of Test	2022-12-26
Factor	DRH18-E	Temp. / Humidity	25°C /65%
Polarity	Horizontal	Site / Test Engineer	AC2 / Xuan
Test Mode	802.11ax-20MHz_TX_Band6_CH 113_ANT 0+1+2+3_NSS1	Test Voltage	AC 120V/60Hz

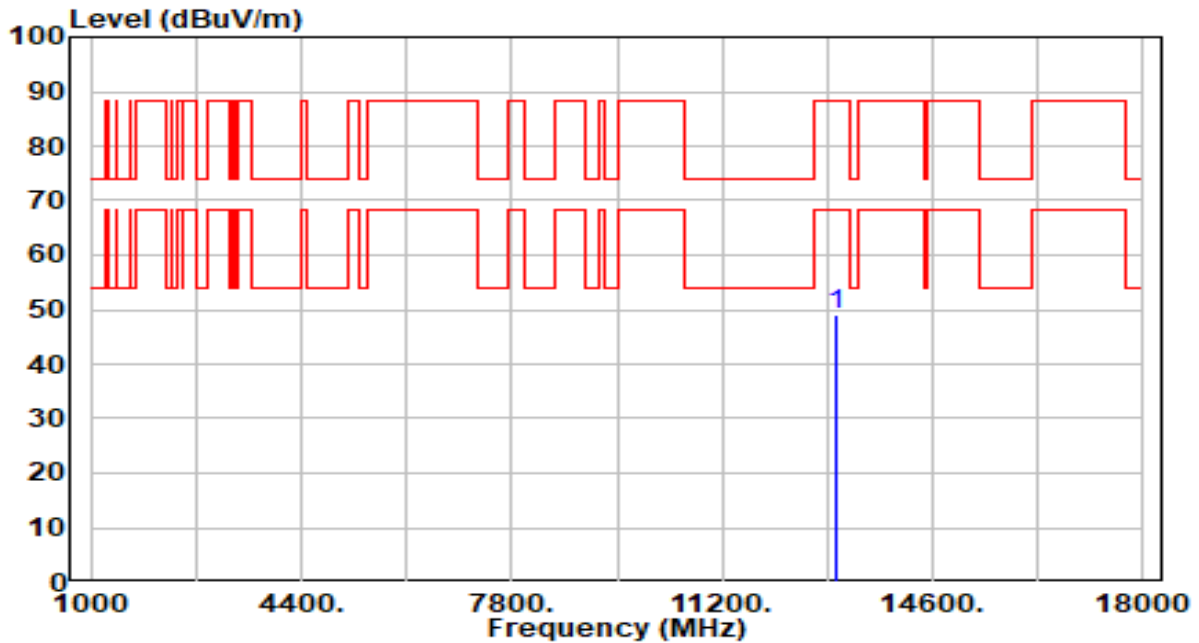

No	Frequency (MHz)	Reading (dBuV)	C.F (dB/m)	Measurement (dBuV/m)	Margin (dB)	Limit (dBuV/m)	Height (cm)	Angle (deg)	Remark (QP/PK/AV)
1	* 13030.000	41.67	7.24	48.91	-39.29	88.20	100	300	Peak

Note:

1. " *", means this data is the worst emission level.
2. C.F (Correction Factor) = Antenna Factor (dB/m) + Cable Loss (dB) – Preamplifier(dB).
3. Measurement (dBuV/m) = Reading(dBuV) + C.F (Correction Factor).
4. The emission levels of other frequencies are very lower than the limit and not show in test report.

EUT	AXE11000 Tri-Band Wi-Fi 6E Router	Date of Test	2022-12-26
Factor	DRH18-E	Temp. / Humidity	25°C /65%
Polarity	Vertical	Site / Test Engineer	AC2 / Xuan
Test Mode	802.11ax-20MHz_TX_Band6_CH 113_ANT 0+1+2+3_NSS1	Test Voltage	AC 120V/60Hz

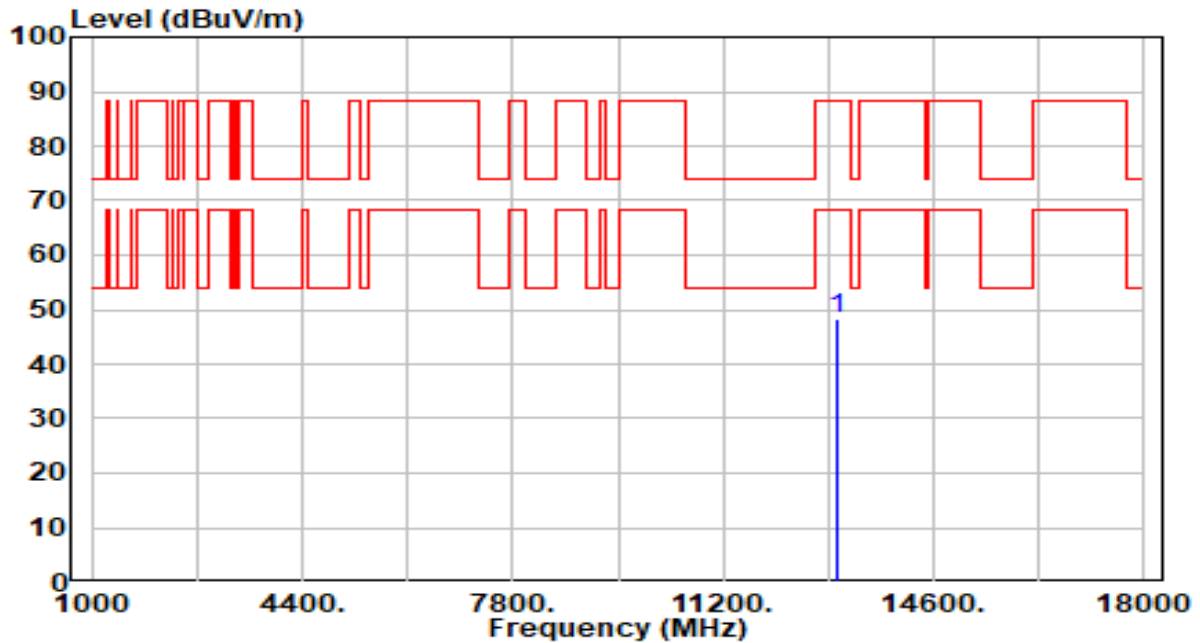

No	Frequency (MHz)	Reading (dBuV)	C.F (dB/m)	Measurement (dBuV/m)	Margin (dB)	Limit (dBuV/m)	Height (cm)	Angle (deg)	Remark (QP/PK/AV)
1	* 13030.000	41.19	7.24	48.43	-39.77	88.20	200	153	Peak

Note:

1. " *", means this data is the worst emission level.
2. C.F (Correction Factor) = Antenna Factor (dB/m) + Cable Loss (dB) – Preamplifier(dB).
3. Measurement (dBuV/m) = Reading(dBuV) + C.F (Correction Factor).
4. The emission levels of other frequencies are very lower than the limit and not show in test report.

EUT	AXE11000 Tri-Band Wi-Fi 6E Router	Date of Test	2022-12-27
Factor	DRH18-E	Temp. / Humidity	25°C /65%
Polarity	Horizontal	Site / Test Engineer	AC2 / Xuan
Test Mode	802.11ax-20MHz_TX_Band7_CH 117_ANT 0+1+2+3_NSS1	Test Voltage	AC 120V/60Hz

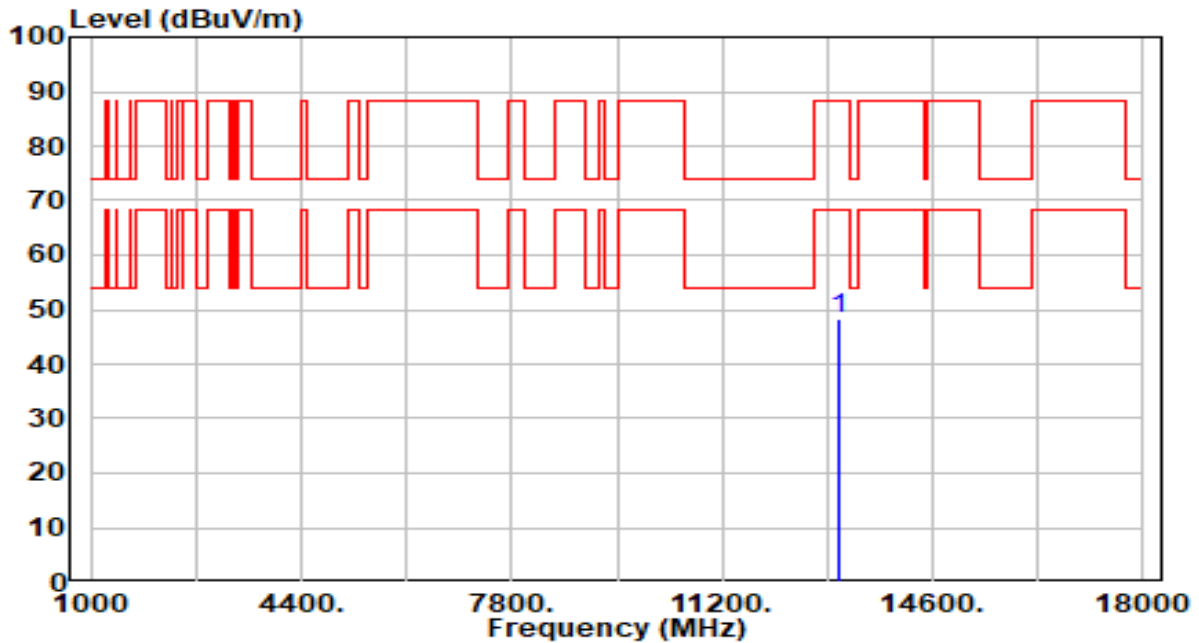

No	Frequency (MHz)	Reading (dBuV)	C.F (dB/m)	Measurement (dBuV/m)	Margin (dB)	Limit (dBuV/m)	Height (cm)	Angle (deg)	Remark (QP/PK/AV)	
1	*	13070.000	40.95	7.21	48.17	-40.03	88.20	100	242	Peak

Note:

1. " *", means this data is the worst emission level.
2. C.F (Correction Factor) = Antenna Factor (dB/m) + Cable Loss (dB) – Preamplifier(dB).
3. Measurement (dBuV/m) = Reading(dBuV) + C.F (Correction Factor).
4. The emission levels of other frequencies are very lower than the limit and not show in test report.

EUT	AXE11000 Tri-Band Wi-Fi 6E Router	Date of Test	2022-12-27
Factor	DRH18-E	Temp. / Humidity	25°C /65%
Polarity	Vertical	Site / Test Engineer	AC2 / Xuan
Test Mode	802.11ax-20MHz_TX_Band7_CH 117_ANT 0+1+2+3_NSS1	Test Voltage	AC 120V/60Hz

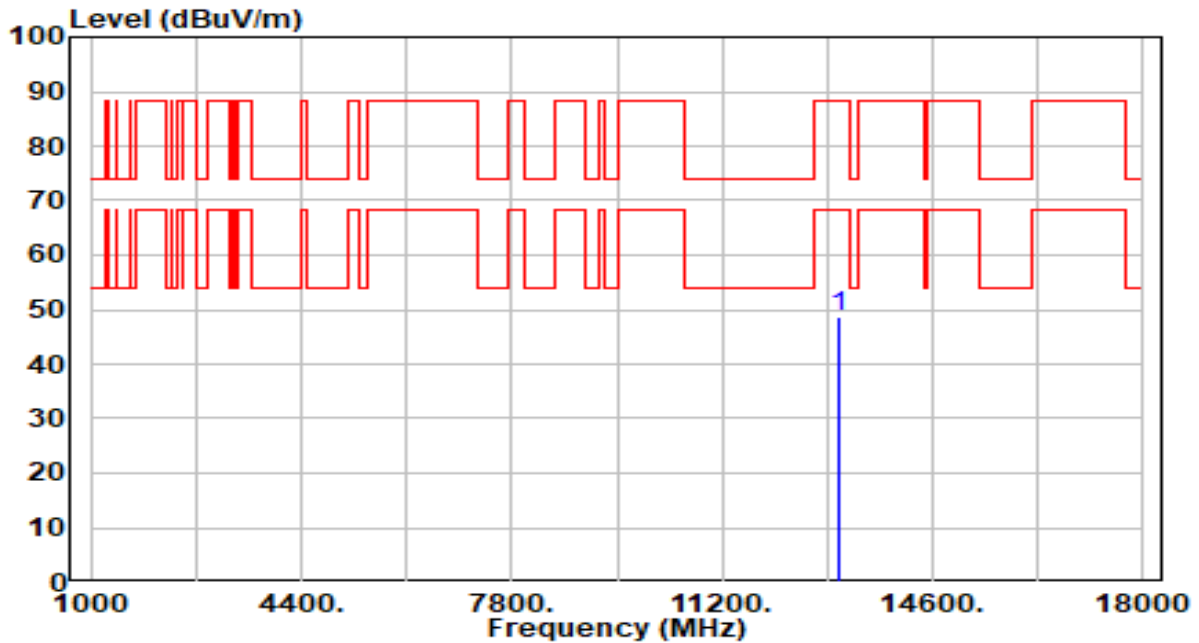

No	Frequency (MHz)	Reading (dBuV)	C.F (dB/m)	Measurement (dBuV/m)	Margin (dB)	Limit (dBuV/m)	Height (cm)	Angle (deg)	Remark (QP/PK/AV)
1	*	41.37	7.21	48.58	-39.62	88.20	200	62	Peak

Note:

1. " *", means this data is the worst emission level.
2. C.F (Correction Factor) = Antenna Factor (dB/m) + Cable Loss (dB) – Preamplifier(dB).
3. Measurement (dBuV/m) = Reading(dBuV) + C.F (Correction Factor).
4. The emission levels of other frequencies are very lower than the limit and not show in test report.

EUT	AXE11000 Tri-Band Wi-Fi 6E Router	Date of Test	2022-12-26
Factor	DRH18-E	Temp. / Humidity	25°C /65%
Polarity	Horizontal	Site / Test Engineer	AC2 / Xuan
Test Mode	802.11ax-20MHz_TX_Band7_CH 153_ANT 0+1+2+3_NSS1	Test Voltage	AC 120V/60Hz

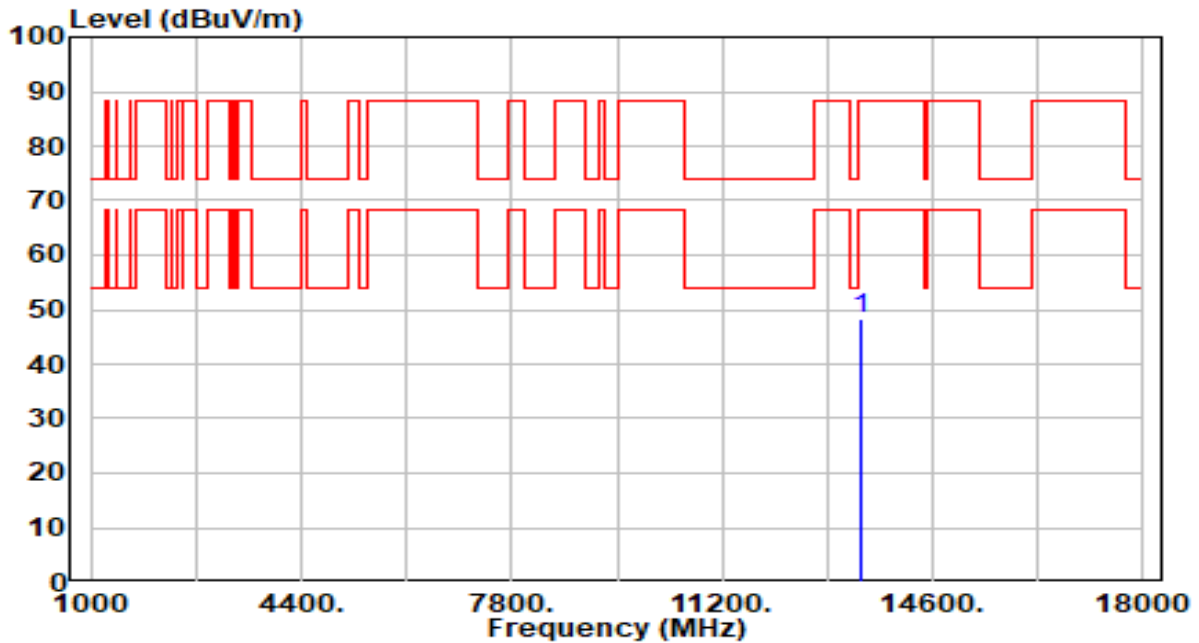

No	Frequency (MHz)	Reading (dBuV)	C.F (dB/m)	Measurement (dBuV/m)	Margin (dB)	Limit (dBuV/m)	Height (cm)	Angle (deg)	Remark (QP/PK/AV)
1	* 13430.000	41.24	7.06	48.30	-39.90	88.20	100	322	Peak

Note:

1. " *", means this data is the worst emission level.
2. C.F (Correction Factor) = Antenna Factor (dB/m) + Cable Loss (dB) – Preamplifier(dB).
3. Measurement (dBuV/m) = Reading(dBuV) + C.F (Correction Factor).
4. The emission levels of other frequencies are very lower than the limit and not show in test report.

EUT	AXE11000 Tri-Band Wi-Fi 6E Router	Date of Test	2022-12-26
Factor	DRH18-E	Temp. / Humidity	25°C /65%
Polarity	Vertical	Site / Test Engineer	AC2 / Xuan
Test Mode	802.11ax-20MHz_TX_Band7_CH 153_ANT 0+1+2+3_NSS1	Test Voltage	AC 120V/60Hz

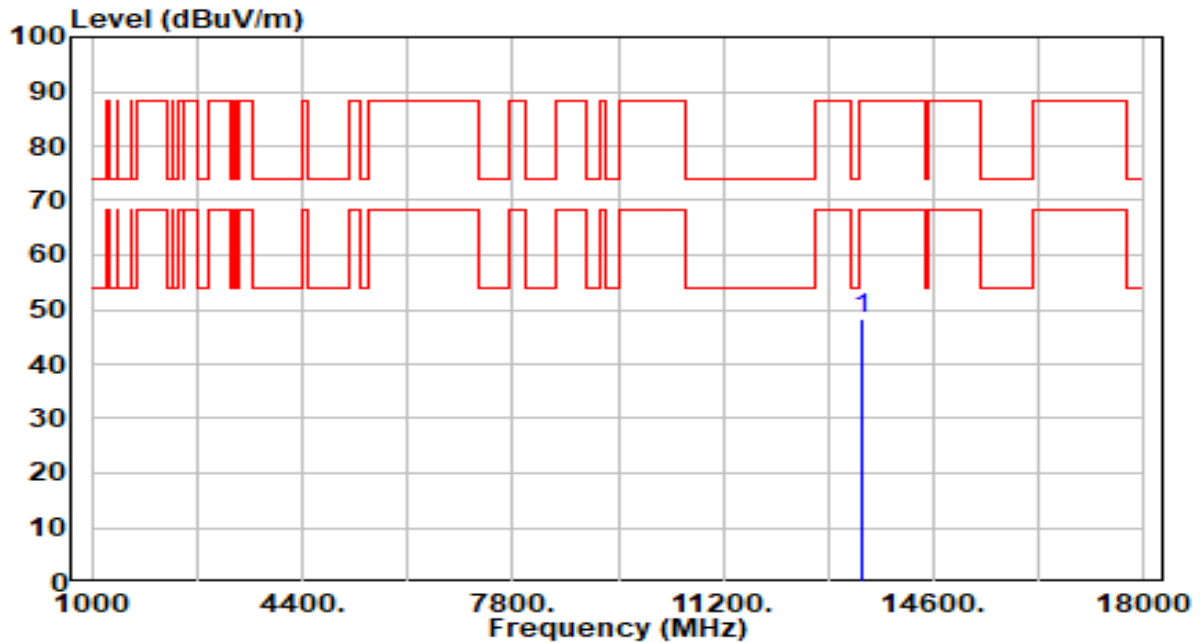

No	Frequency (MHz)	Reading (dBuV)	C.F (dB/m)	Measurement (dBuV/m)	Margin (dB)	Limit (dBuV/m)	Height (cm)	Angle (deg)	Remark (QP/PK/AV)
1	*	41.24	7.06	48.30	-39.90	88.20	200	320	Peak

Note:

1. " *", means this data is the worst emission level.
2. C.F (Correction Factor) = Antenna Factor (dB/m) + Cable Loss (dB) – Preamplifier(dB).
3. Measurement (dBuV/m) = Reading(dBuV) + C.F (Correction Factor).
4. The emission levels of other frequencies are very lower than the limit and not show in test report.

EUT	AXE11000 Tri-Band Wi-Fi 6E Router	Date of Test	2022-12-26
Factor	DRH18-E	Temp. / Humidity	25°C /65%
Polarity	Horizontal	Site / Test Engineer	AC2 / Xuan
Test Mode	802.11ax-20MHz_TX_Band7_CH 181_ANT 0+1+2+3_NSS1	Test Voltage	AC 120V/60Hz

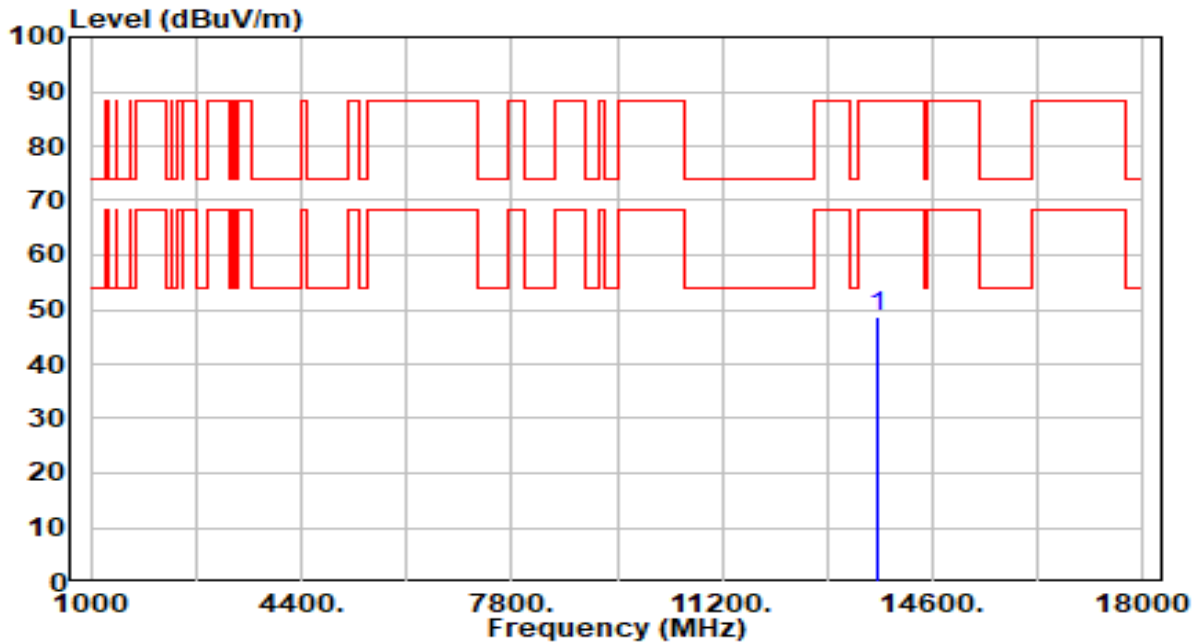

No	Frequency (MHz)	Reading (dBuV)	C.F (dB/m)	Measurement (dBuV/m)	Margin (dB)	Limit (dBuV/m)	Height (cm)	Angle (deg)	Remark (QP/PK/AV)
1	*	42.11	6.75	48.86	-39.34	88.20	100	75	Peak

Note:

1. " *", means this data is the worst emission level.
2. C.F (Correction Factor) = Antenna Factor (dB/m) + Cable Loss (dB) – Preamplifier(dB).
3. Measurement (dBuV/m) = Reading(dBuV) + C.F (Correction Factor).
4. The emission levels of other frequencies are very lower than the limit and not show in test report.

EUT	AXE11000 Tri-Band Wi-Fi 6E Router	Date of Test	2022-12-26
Factor	DRH18-E	Temp. / Humidity	25°C /65%
Polarity	Vertical	Site / Test Engineer	AC2 / Xuan
Test Mode	802.11ax-20MHz_TX_Band7_CH 181_ANT 0+1+2+3_NSS1	Test Voltage	AC 120V/60Hz

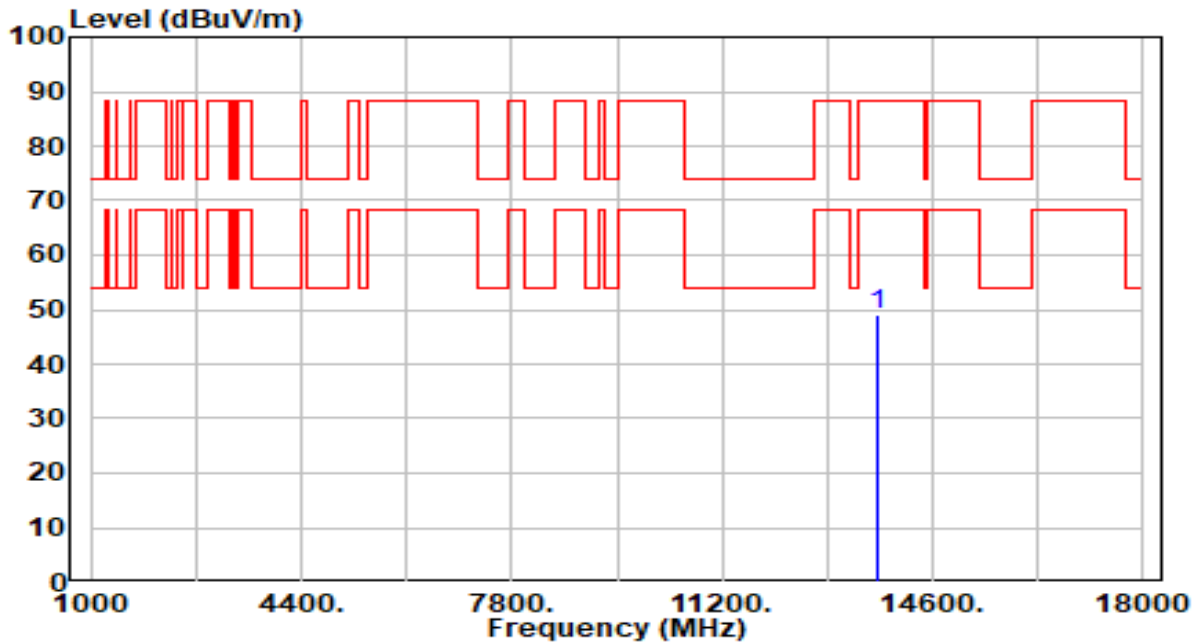

No	Frequency (MHz)	Reading (dBuV)	C.F (dB/m)	Measurement (dBuV/m)	Margin (dB)	Limit (dBuV/m)	Height (cm)	Angle (deg)	Remark (QP/PK/AV)
1	* 13710.000	42.14	6.75	48.89	-39.31	88.20	200	133	Peak

Note:

1. " *", means this data is the worst emission level.
2. C.F (Correction Factor) = Antenna Factor (dB/m) + Cable Loss (dB) – Preamplifier(dB).
3. Measurement (dBuV/m) = Reading(dBuV) + C.F (Correction Factor).
4. The emission levels of other frequencies are very lower than the limit and not show in test report.

EUT	AXE11000 Tri-Band Wi-Fi 6E Router	Date of Test	2022-12-26
Factor	DRH18-E	Temp. / Humidity	25°C /65%
Polarity	Horizontal	Site / Test Engineer	AC2 / Xuan
Test Mode	802.11ax-20MHz_TX_Band7_CH 185_ANT 0+1+2+3_NSS1	Test Voltage	AC 120V/60Hz

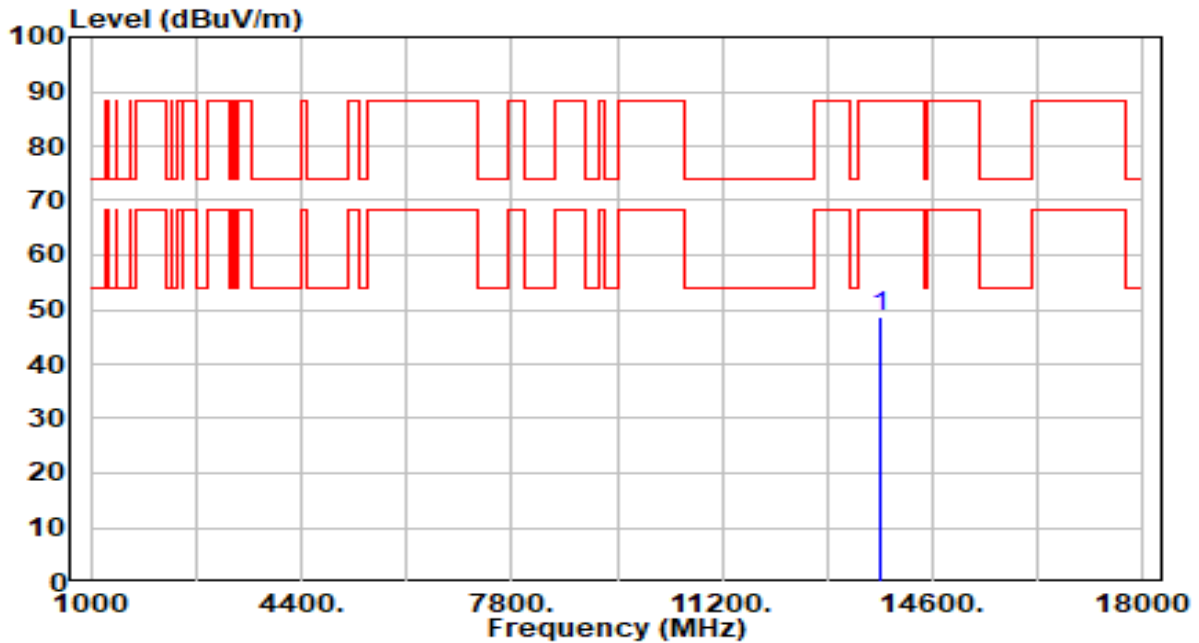

No	Frequency (MHz)	Reading (dBuV)	C.F (dB/m)	Measurement (dBuV/m)	Margin (dB)	Limit (dBuV/m)	Height (cm)	Angle (deg)	Remark (QP/PK/AV)
1	*	42.06	6.75	48.81	-39.39	88.20	100	327	Peak

Note:

1. " *", means this data is the worst emission level.
2. C.F (Correction Factor) = Antenna Factor (dB/m) + Cable Loss (dB) – Preamplifier(dB).
3. Measurement (dBuV/m) = Reading(dBuV) + C.F (Correction Factor).
4. The emission levels of other frequencies are very lower than the limit and not show in test report.

EUT	AXE11000 Tri-Band Wi-Fi 6E Router	Date of Test	2022-12-26
Factor	DRH18-E	Temp. / Humidity	25°C /65%
Polarity	Vertical	Site / Test Engineer	AC2 / Xuan
Test Mode	802.11ax-20MHz_TX_Band7_CH 185_ANT 0+1+2+3_NSS1	Test Voltage	AC 120V/60Hz

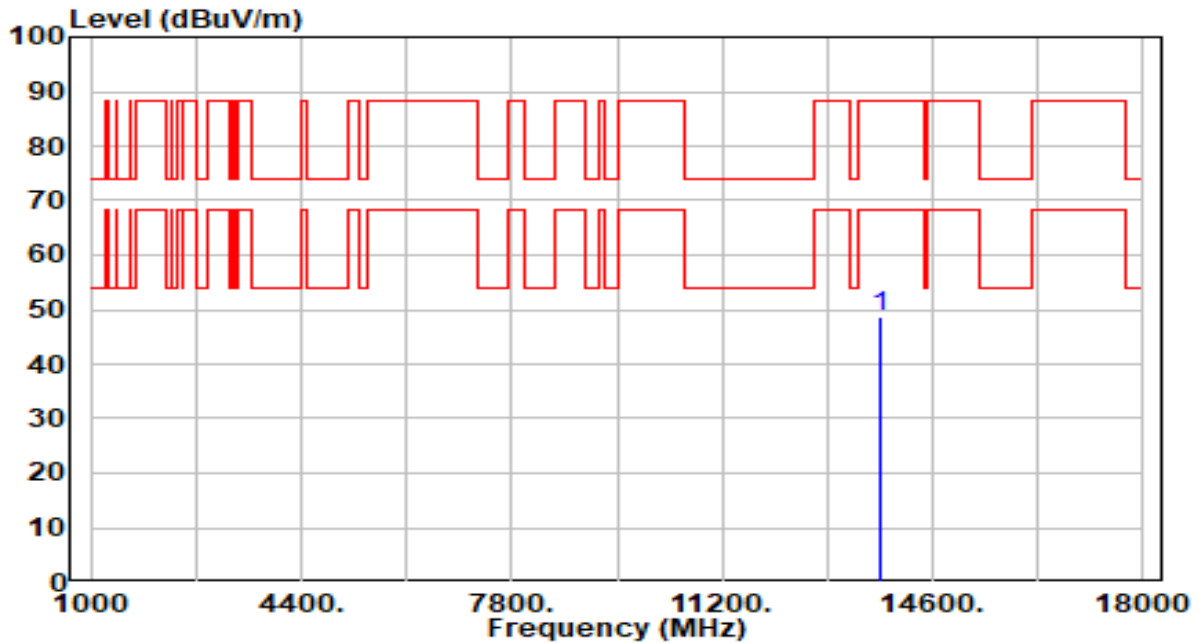

No	Frequency (MHz)	Reading (dBuV)	C.F (dB/m)	Measurement (dBuV/m)	Margin (dB)	Limit (dBuV/m)	Height (cm)	Angle (deg)	Remark (QP/PK/AV)
1	*	42.09	6.75	48.84	-39.36	88.20	200	18	Peak

Note:

1. " *", means this data is the worst emission level.
2. C.F (Correction Factor) = Antenna Factor (dB/m) + Cable Loss (dB) – Preamplifier(dB).
3. Measurement (dBuV/m) = Reading(dBuV) + C.F (Correction Factor).
4. The emission levels of other frequencies are very lower than the limit and not show in test report.

EUT	AXE11000 Tri-Band Wi-Fi 6E Router	Date of Test	2022-12-26
Factor	DRH18-E	Temp. / Humidity	25°C /65%
Polarity	Horizontal	Site / Test Engineer	AC2 / Xuan
Test Mode	802.11ax-20MHz_TX_Band8_CH 189_ANT 0+1+2+3_NSS1	Test Voltage	AC 120V/60Hz

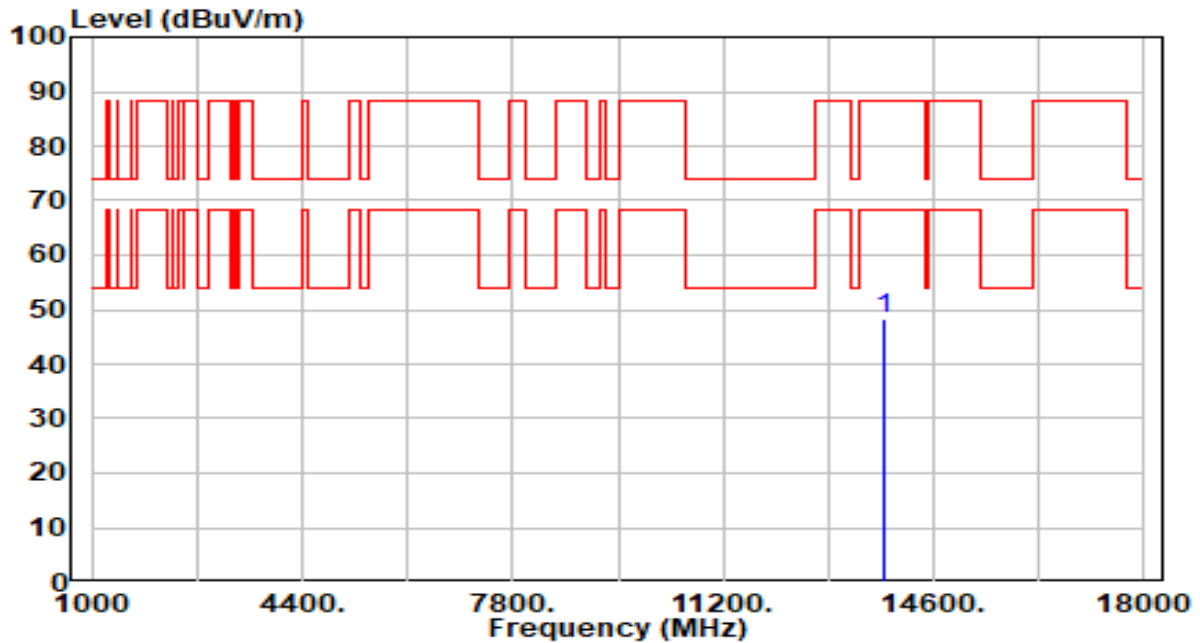

No	Frequency (MHz)	Reading (dBuV)	C.F (dB/m)	Measurement (dBuV/m)	Margin (dB)	Limit (dBuV/m)	Height (cm)	Angle (deg)	Remark (QP/PK/AV)
1	* 13790.000	41.44	6.76	48.19	-40.01	88.20	100	318	Peak

Note:

1. " *", means this data is the worst emission level.
2. C.F (Correction Factor) = Antenna Factor (dB/m) + Cable Loss (dB) – Preamplifier(dB).
3. Measurement (dBuV/m) = Reading(dBuV) + C.F (Correction Factor).
4. The emission levels of other frequencies are very lower than the limit and not show in test report.

EUT	AXE11000 Tri-Band Wi-Fi 6E Router	Date of Test	2022-12-26
Factor	DRH18-E	Temp. / Humidity	25°C /65%
Polarity	Vertical	Site / Test Engineer	AC2 / Xuan
Test Mode	802.11ax-20MHz_TX_Band8_CH 189_ANT 0+1+2+3_NSS1	Test Voltage	AC 120V/60Hz

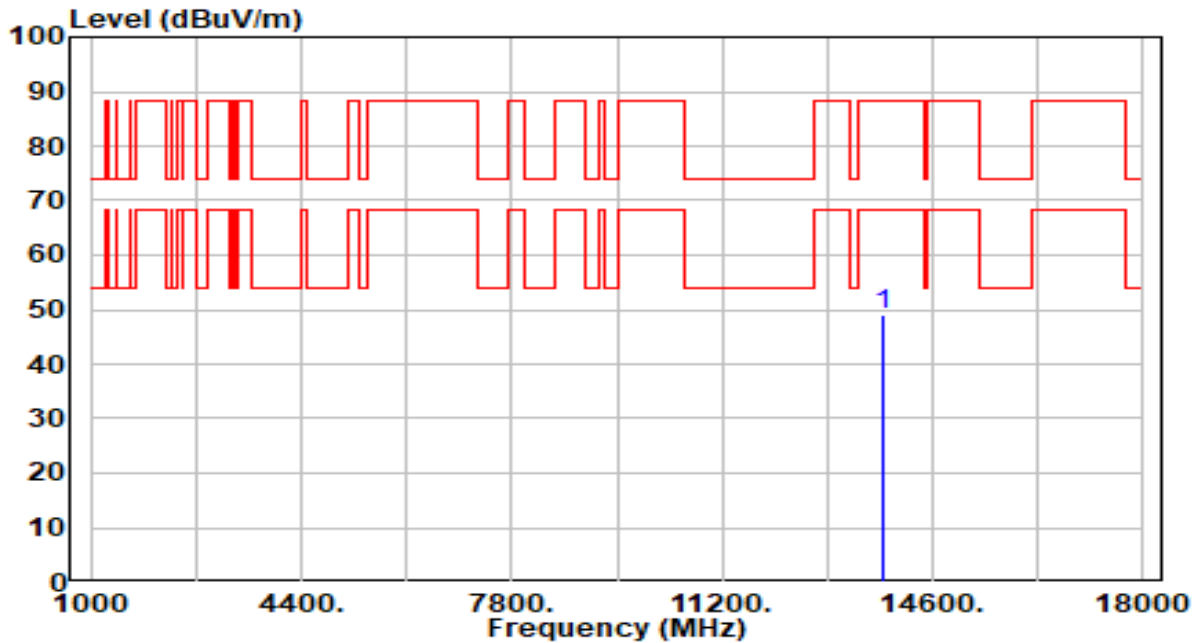

No	Frequency (MHz)	Reading (dBuV)	C.F (dB/m)	Measurement (dBuV/m)	Margin (dB)	Limit (dBuV/m)	Height (cm)	Angle (deg)	Remark (QP/PK/AV)
1	*	42.15	6.76	48.91	-39.29	88.20	200	256	Peak

Note:

- "*", means this data is the worst emission level.
- C.F (Correction Factor) = Antenna Factor (dB/m) + Cable Loss (dB) – Preamplifier(dB).
- Measurement (dBuV/m) = Reading(dBuV) + C.F (Correction Factor).
- The emission levels of other frequencies are very lower than the limit and not show in test report.

EUT	AXE11000 Tri-Band Wi-Fi 6E Router	Date of Test	2022-12-26
Factor	DRH18-E	Temp. / Humidity	25°C /65%
Polarity	Horizontal	Site / Test Engineer	AC2 / Xuan
Test Mode	802.11ax-20MHz_TX_Band8_CH 213_ANT 0+1+2+3_NSS1	Test Voltage	AC 120V/60Hz

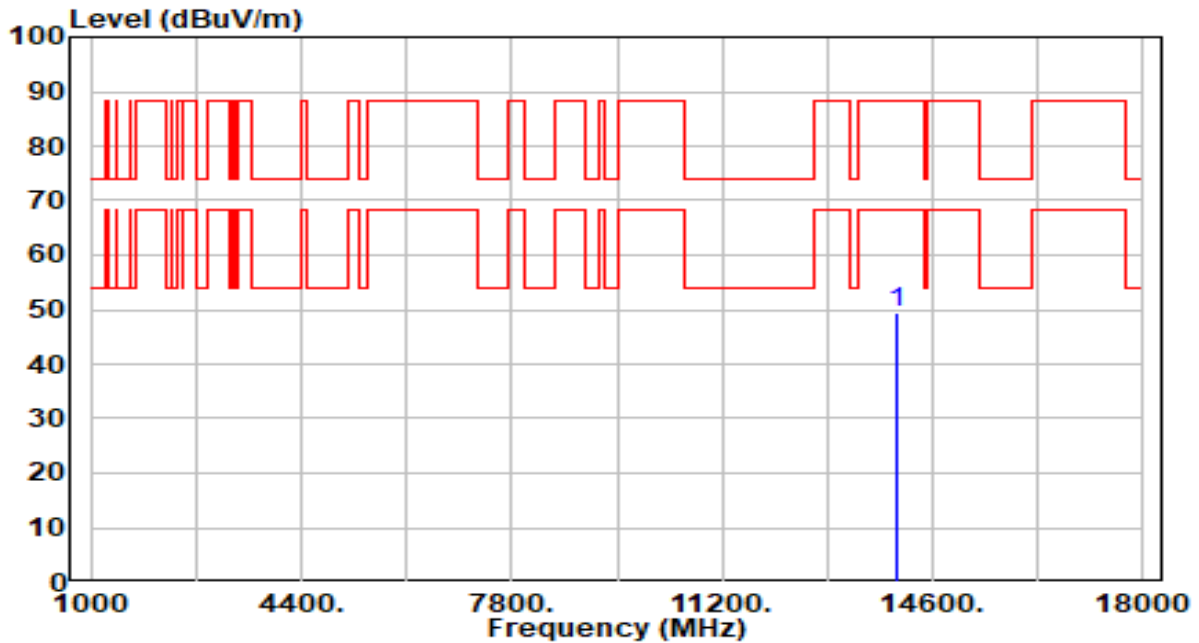

No	Frequency (MHz)	Reading (dBuV)	C.F (dB/m)	Measurement (dBuV/m)	Margin (dB)	Limit (dBuV/m)	Height (cm)	Angle (deg)	Remark (QP/PK/AV)
1	*	42.74	6.81	49.55	-38.65	88.20	100	323	Peak

Note:

1. " *", means this data is the worst emission level.
2. C.F (Correction Factor) = Antenna Factor (dB/m) + Cable Loss (dB) – Preamplifier(dB).
3. Measurement (dBuV/m) = Reading(dBuV) + C.F (Correction Factor).
4. The emission levels of other frequencies are very lower than the limit and not show in test report.

EUT	AXE11000 Tri-Band Wi-Fi 6E Router	Date of Test	2022-12-26
Factor	DRH18-E	Temp. / Humidity	25°C /65%
Polarity	Vertical	Site / Test Engineer	AC2 / Xuan
Test Mode	802.11ax-20MHz_TX_Band8_CH 213_ANT 0+1+2+3_NSS1	Test Voltage	AC 120V/60Hz

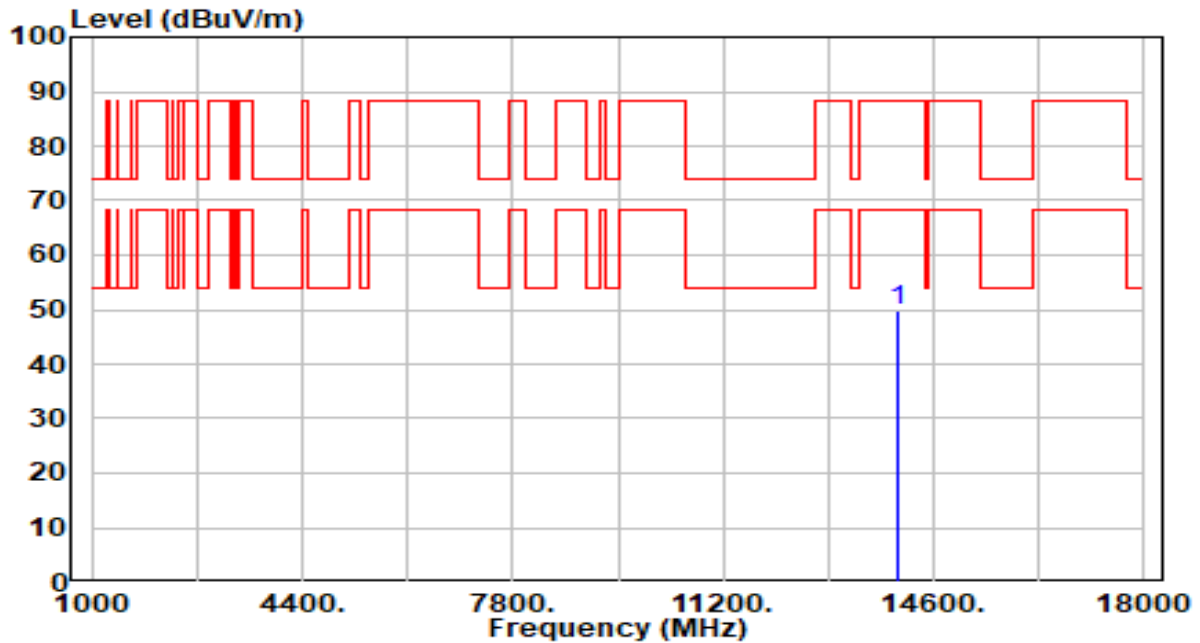

No	Frequency (MHz)	Reading (dBuV)	C.F (dB/m)	Measurement (dBuV/m)	Margin (dB)	Limit (dBuV/m)	Height (cm)	Angle (deg)	Remark (QP/PK/AV)
1	* 14030.000	42.94	6.81	49.74	-38.46	88.20	200	102	Peak

Note:

1. " *", means this data is the worst emission level.
2. C.F (Correction Factor) = Antenna Factor (dB/m) + Cable Loss (dB) – Preamplifier(dB).
3. Measurement (dBuV/m) = Reading(dBuV) + C.F (Correction Factor).
4. The emission levels of other frequencies are very lower than the limit and not show in test report.

EUT	AXE11000 Tri-Band Wi-Fi 6E Router	Date of Test	2022-12-26
Factor	DRH18-E	Temp. / Humidity	25°C /65%
Polarity	Horizontal	Site / Test Engineer	AC2 / Xuan
Test Mode	802.11ax-20MHz_TX_Band8_CH 229_ANT 0+1+2+3_NSS1	Test Voltage	AC 120V/60Hz

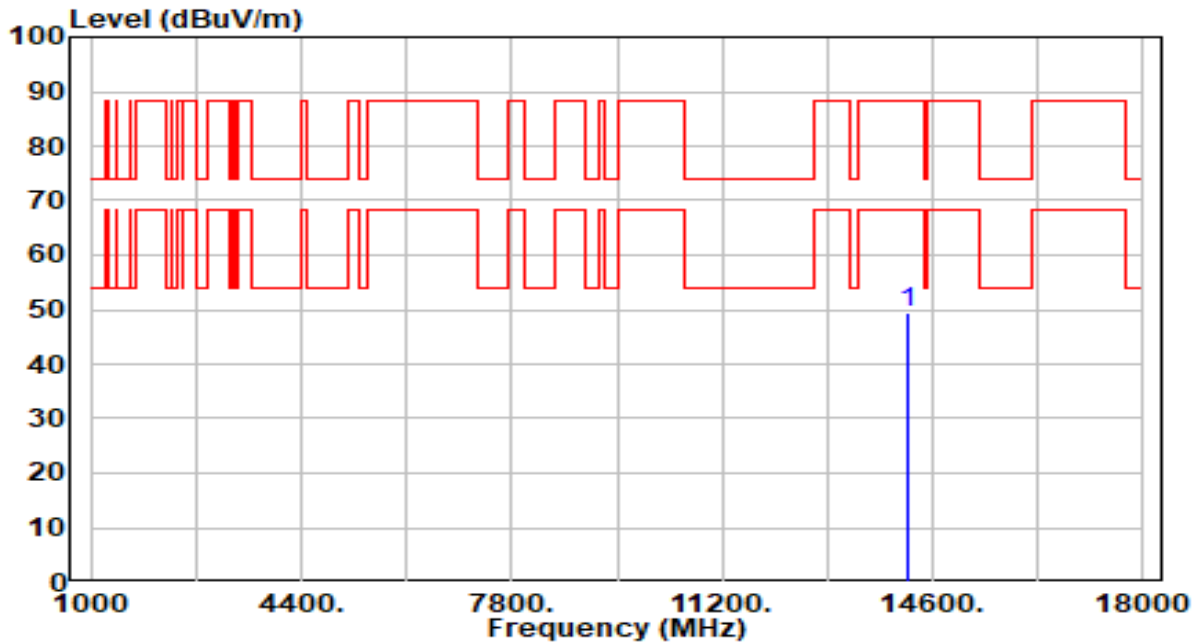

No	Frequency (MHz)	Reading (dBuV)	C.F (dB/m)	Measurement (dBuV/m)	Margin (dB)	Limit (dBuV/m)	Height (cm)	Angle (deg)	Remark (QP/PK/AV)
1	* 14190.000	42.64	6.94	49.58	-38.62	88.20	100	301	Peak

Note:

1. " *", means this data is the worst emission level.
2. C.F (Correction Factor) = Antenna Factor (dB/m) + Cable Loss (dB) – Preamplifier(dB).
3. Measurement (dBuV/m) = Reading(dBuV) + C.F (Correction Factor).
4. The emission levels of other frequencies are very lower than the limit and not show in test report.

EUT	AXE11000 Tri-Band Wi-Fi 6E Router	Date of Test	2022-12-26
Factor	DRH18-E	Temp. / Humidity	25°C /65%
Polarity	Vertical	Site / Test Engineer	AC2 / Xuan
Test Mode	802.11ax-20MHz_TX_Band8_CH 229_ANT 0+1+2+3_NSS1	Test Voltage	AC 120V/60Hz

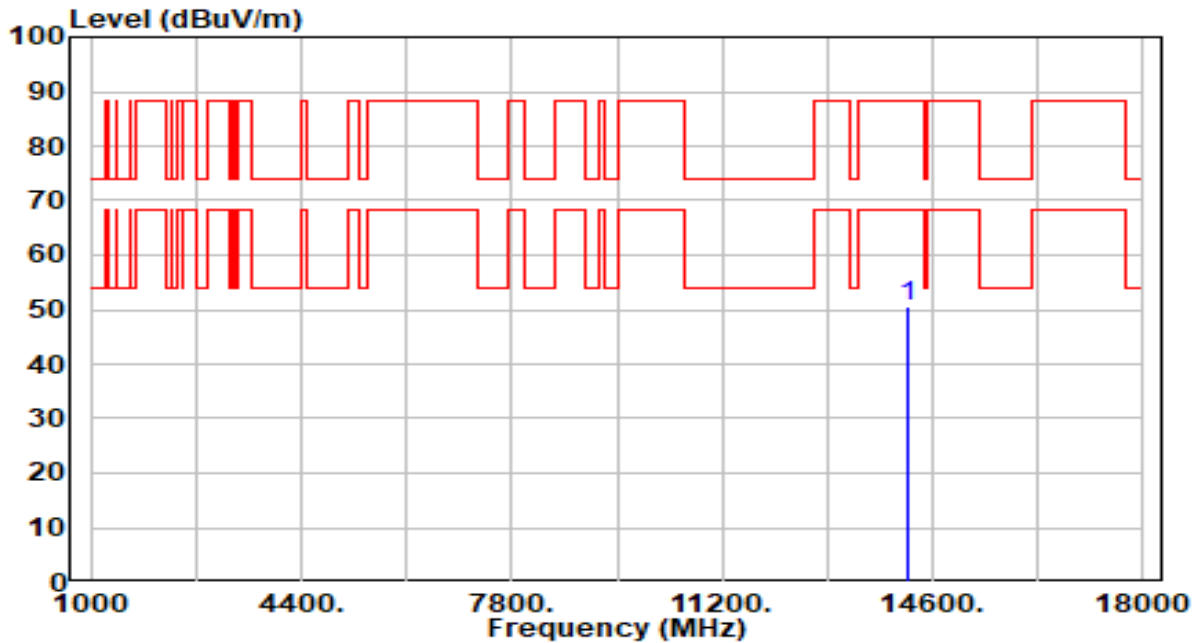

No	Frequency (MHz)	Reading (dBuV)	C.F (dB/m)	Measurement (dBuV/m)	Margin (dB)	Limit (dBuV/m)	Height (cm)	Angle (deg)	Remark (QP/PK/AV)
1	* 14190.000	43.46	6.94	50.40	-37.80	88.20	200	297	Peak

Note:

1. " *", means this data is the worst emission level.
2. C.F (Correction Factor) = Antenna Factor (dB/m) + Cable Loss (dB) – Preamplifier(dB).
3. Measurement (dBuV/m) = Reading(dBuV) + C.F (Correction Factor).
4. The emission levels of other frequencies are very lower than the limit and not show in test report.

EUT	AXE11000 Tri-Band Wi-Fi 6E Router	Date of Test	2022-12-26
Factor	DRH18-E	Temp. / Humidity	25°C /65%
Polarity	Horizontal	Site / Test Engineer	AC2 / Xuan
Test Mode	802.11ax-40MHz_TX_Band5_CH 35_ANT 0+1+2+3_NSS1	Test Voltage	AC 120V/60Hz

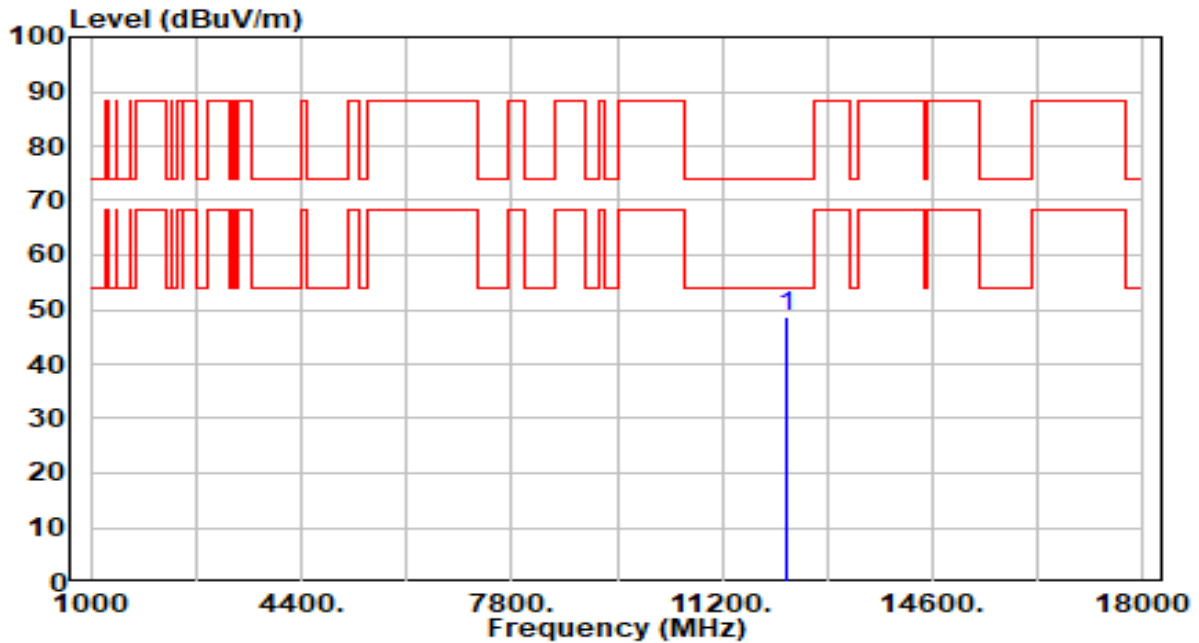

No	Frequency (MHz)	Reading (dBuV)	C.F (dB/m)	Measurement (dBuV/m)	Margin (dB)	Limit (dBuV/m)	Height (cm)	Angle (deg)	Remark (QP/PK/AV)
1	*	42.37	6.15	48.52	-25.48	74.00	100	92	Peak

Note:

1. " *", means this data is the worst emission level.
2. C.F (Correction Factor) = Antenna Factor (dB/m) + Cable Loss (dB) – Preamplifier(dB).
3. Measurement (dBuV/m) = Reading(dBuV) + C.F (Correction Factor).
4. The emission levels of other frequencies are very lower than the limit and not show in test report.

EUT	AXE11000 Tri-Band Wi-Fi 6E Router	Date of Test	2022-12-26
Factor	DRH18-E	Temp. / Humidity	25°C /65%
Polarity	Vertical	Site / Test Engineer	AC2 / Xuan
Test Mode	802.11ax-40MHz_TX_Band5_CH 35_ANT 0+1+2+3_NSS1	Test Voltage	AC 120V/60Hz

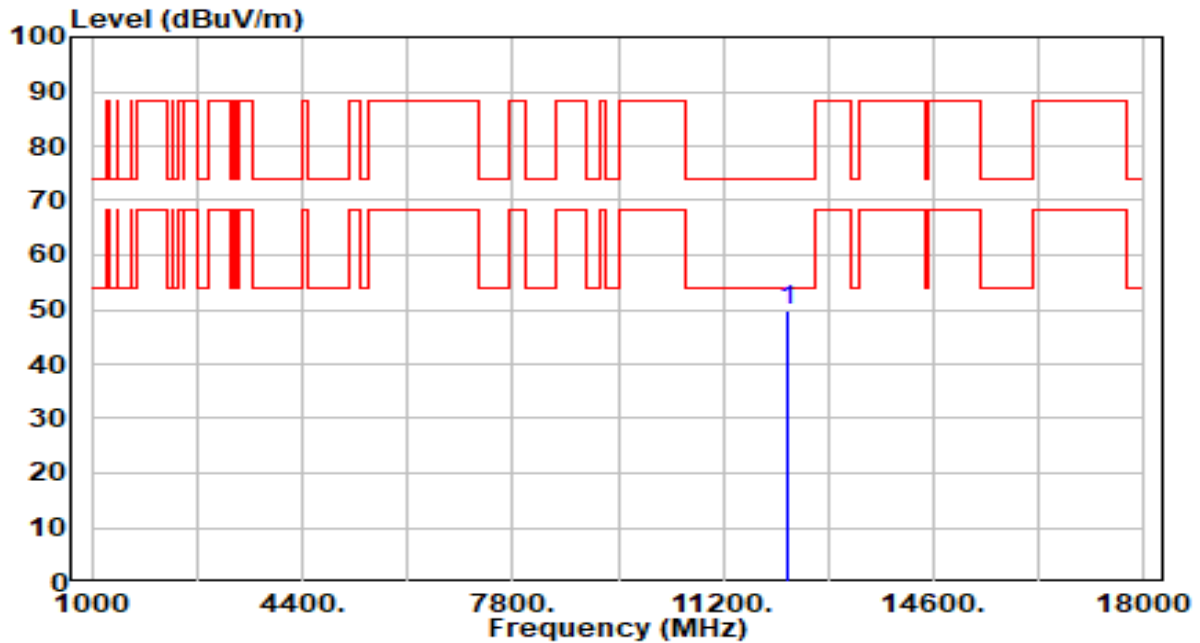

No	Frequency (MHz)	Reading (dBuV)	C.F (dB/m)	Measurement (dBuV/m)	Margin (dB)	Limit (dBuV/m)	Height (cm)	Angle (deg)	Remark (QP/PK/AV)
1	*	43.51	6.15	49.66	-24.34	74.00	200	276	Peak

Note:

1. " *", means this data is the worst emission level.
2. C.F (Correction Factor) = Antenna Factor (dB/m) + Cable Loss (dB) – Preamplifier(dB).
3. Measurement (dBuV/m) = Reading(dBuV) + C.F (Correction Factor).
4. The emission levels of other frequencies are very lower than the limit and not show in test report.

EUT	AXE11000 Tri-Band Wi-Fi 6E Router	Date of Test	2022-12-26
Factor	DRH18-E	Temp. / Humidity	25°C /65%
Polarity	Horizontal	Site / Test Engineer	AC2 / Xuan
Test Mode	802.11ax-40MHz_TX_Band5_CH 59_ANT 0+1+2+3_NSS1	Test Voltage	AC 120V/60Hz

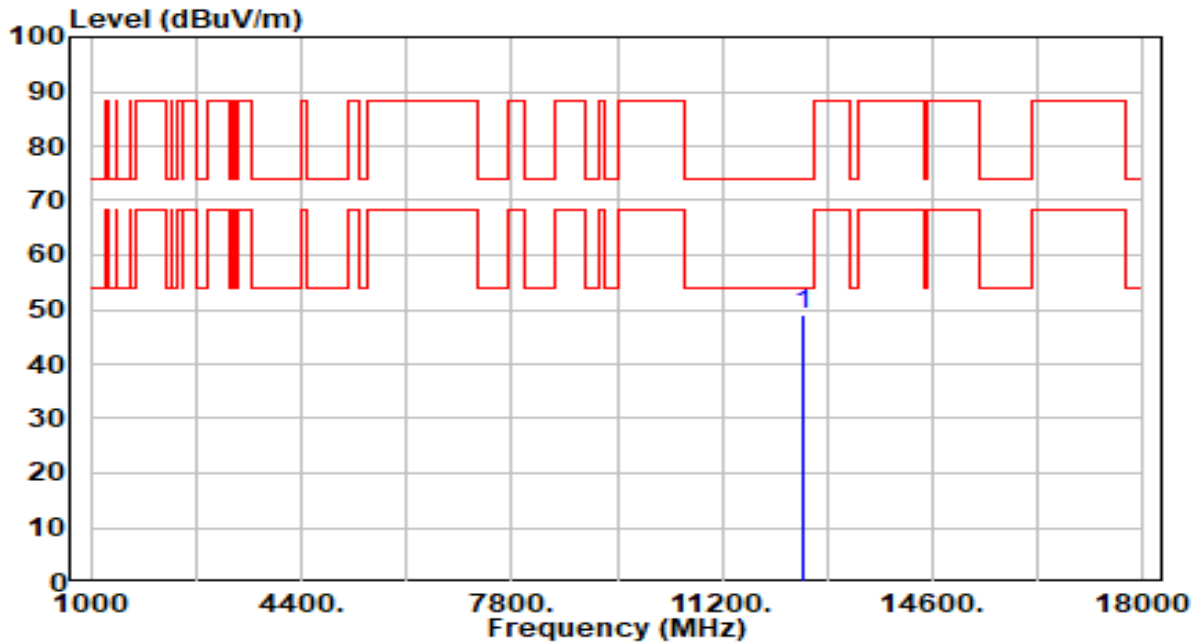

No	Frequency (MHz)	Reading (dBuV)	C.F (dB/m)	Measurement (dBuV/m)	Margin (dB)	Limit (dBuV/m)	Height (cm)	Angle (deg)	Remark (QP/PK/AV)
1	*	42.30	6.64	48.94	-25.06	74.00	100	28	Peak

Note:

1. " *", means this data is the worst emission level.
2. C.F (Correction Factor) = Antenna Factor (dB/m) + Cable Loss (dB) – Preamplifier(dB).
3. Measurement (dBuV/m) = Reading(dBuV) + C.F (Correction Factor).
4. The emission levels of other frequencies are very lower than the limit and not show in test report.

EUT	AXE11000 Tri-Band Wi-Fi 6E Router	Date of Test	2022-12-26
Factor	DRH18-E	Temp. / Humidity	25°C /65%
Polarity	Vertical	Site / Test Engineer	AC2 / Xuan
Test Mode	802.11ax-40MHz_TX_Band5_CH 59_ANT 0+1+2+3_NSS1	Test Voltage	AC 120V/60Hz

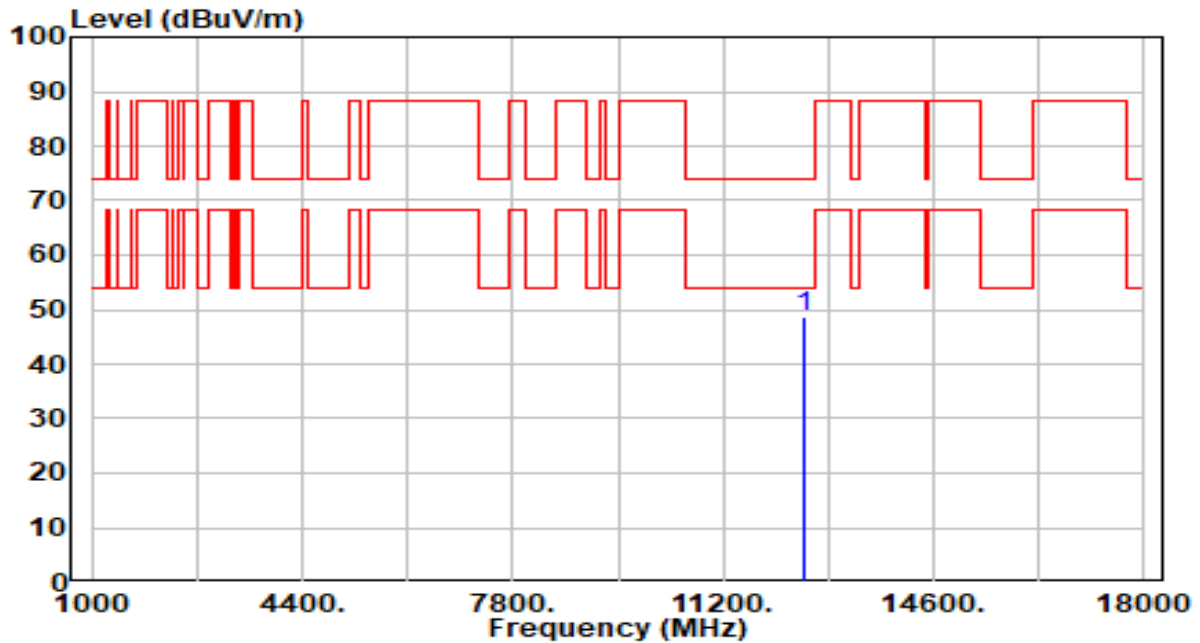

No	Frequency (MHz)	Reading (dBuV)	C.F (dB/m)	Measurement (dBuV/m)	Margin (dB)	Limit (dBuV/m)	Height (cm)	Angle (deg)	Remark (QP/PK/AV)
1	*	42.08	6.64	48.72	-25.28	74.00	200	128	Peak

Note:

1. " *", means this data is the worst emission level.
2. C.F (Correction Factor) = Antenna Factor (dB/m) + Cable Loss (dB) – Preamplifier(dB).
3. Measurement (dBuV/m) = Reading(dBuV) + C.F (Correction Factor).
4. The emission levels of other frequencies are very lower than the limit and not show in test report.

EUT	AXE11000 Tri-Band Wi-Fi 6E Router	Date of Test	2022-12-26
Factor	DRH18-E	Temp. / Humidity	25°C /65%
Polarity	Horizontal	Site / Test Engineer	AC2 / Xuan
Test Mode	802.11ax-40MHz_TX_Band5_CH 91_ANT 0+1+2+3_NSS1	Test Voltage	AC 120V/60Hz

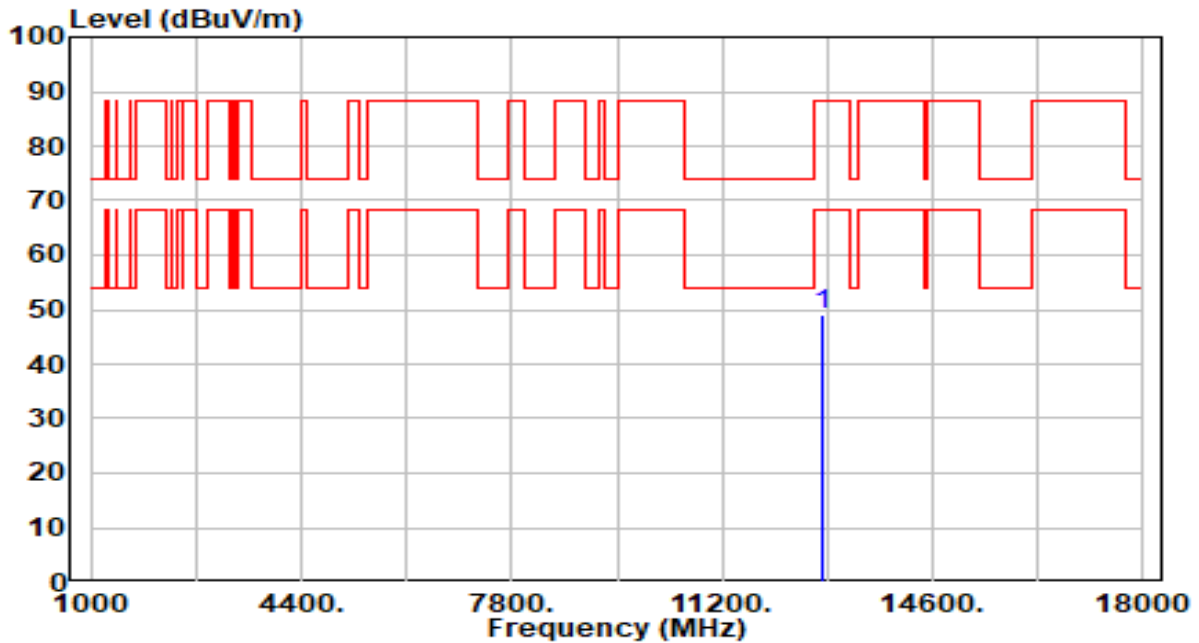

No	Frequency (MHz)	Reading (dBuV)	C.F (dB/m)	Measurement (dBuV/m)	Margin (dB)	Limit (dBuV/m)	Height (cm)	Angle (deg)	Remark (QP/PK/AV)
1	*	41.71	7.21	48.92	-39.28	88.20	100	78	Peak

Note:

1. " *", means this data is the worst emission level.
2. C.F (Correction Factor) = Antenna Factor (dB/m) + Cable Loss (dB) – Preamplifier(dB).
3. Measurement (dBuV/m) = Reading(dBuV) + C.F (Correction Factor).
4. The emission levels of other frequencies are very lower than the limit and not show in test report.

EUT	AXE11000 Tri-Band Wi-Fi 6E Router	Date of Test	2022-12-26
Factor	DRH18-E	Temp. / Humidity	25°C /65%
Polarity	Vertical	Site / Test Engineer	AC2 / Xuan
Test Mode	802.11ax-40MHz_TX_Band5_CH 91_ANT 0+1+2+3_NSS1	Test Voltage	AC 120V/60Hz

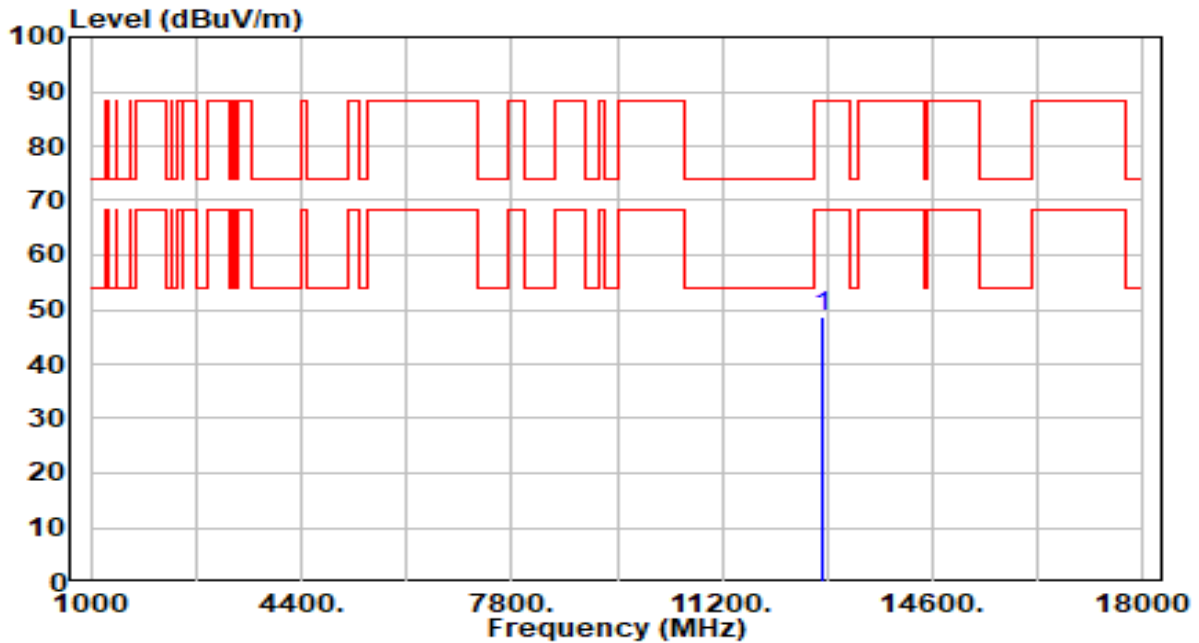

No	Frequency (MHz)	Reading (dBuV)	C.F (dB/m)	Measurement (dBuV/m)	Margin (dB)	Limit (dBuV/m)	Height (cm)	Angle (deg)	Remark (QP/PK/AV)
1	*	41.49	7.21	48.70	-39.50	88.20	200	0	Peak

Note:

1. " *", means this data is the worst emission level.
2. C.F (Correction Factor) = Antenna Factor (dB/m) + Cable Loss (dB) – Preamplifier(dB).
3. Measurement (dBuV/m) = Reading(dBuV) + C.F (Correction Factor).
4. The emission levels of other frequencies are very lower than the limit and not show in test report.

EUT	AXE11000 Tri-Band Wi-Fi 6E Router	Date of Test	2022-12-26
Factor	DRH18-E	Temp. / Humidity	25°C /65%
Polarity	Horizontal	Site / Test Engineer	AC2 / Xuan
Test Mode	802.11ax-40MHz_TX_Band6_CH 99_ANT 0+1+2+3_NSS1	Test Voltage	AC 120V/60Hz

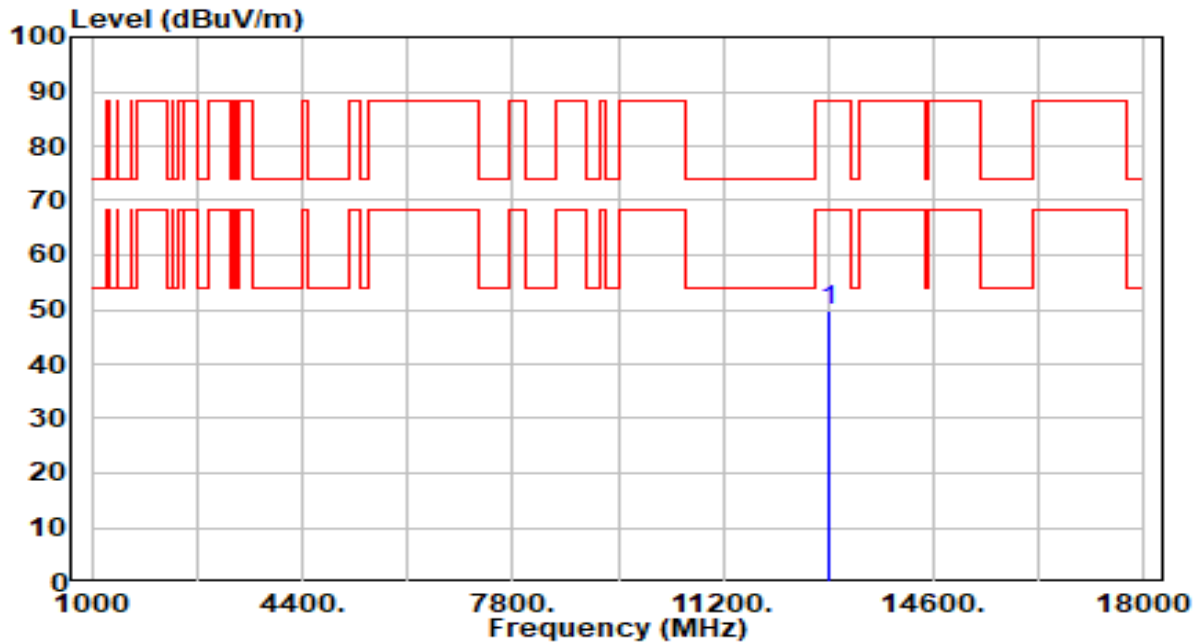

No	Frequency (MHz)	Reading (dBuV)	C.F (dB/m)	Measurement (dBuV/m)	Margin (dB)	Limit (dBuV/m)	Height (cm)	Angle (deg)	Remark (QP/PK/AV)
1	*	42.53	7.23	49.76	-38.44	88.20	100	193	Peak

Note:

1. " *", means this data is the worst emission level.
2. C.F (Correction Factor) = Antenna Factor (dB/m) + Cable Loss (dB) – Preamplifier(dB).
3. Measurement (dBuV/m) = Reading(dBuV) + C.F (Correction Factor).
4. The emission levels of other frequencies are very lower than the limit and not show in test report.

EUT	AXE11000 Tri-Band Wi-Fi 6E Router	Date of Test	2022-12-26
Factor	DRH18-E	Temp. / Humidity	25°C /65%
Polarity	Vertical	Site / Test Engineer	AC2 / Xuan
Test Mode	802.11ax-40MHz_TX_Band6_CH 99_ANT 0+1+2+3_NSS1	Test Voltage	AC 120V/60Hz

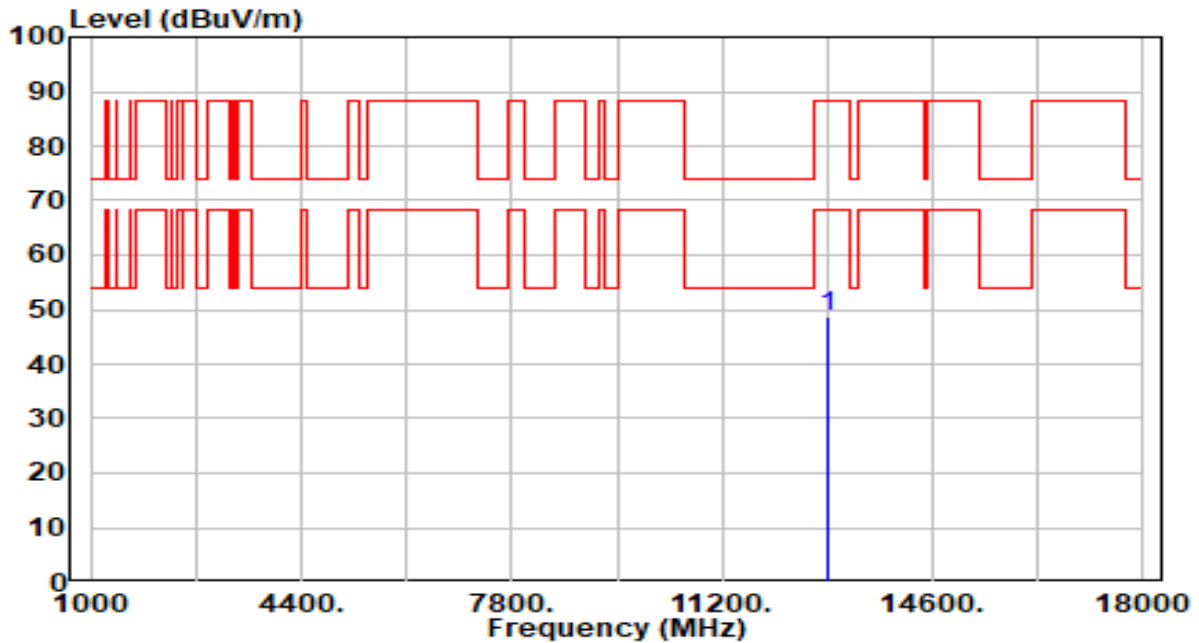

No	Frequency (MHz)	Reading (dBuV)	C.F (dB/m)	Measurement (dBuV/m)	Margin (dB)	Limit (dBuV/m)	Height (cm)	Angle (deg)	Remark (QP/PK/AV)
1	*	41.35	7.23	48.58	-39.62	88.20	200	92	Peak

Note:

1. " *", means this data is the worst emission level.
2. C.F (Correction Factor) = Antenna Factor (dB/m) + Cable Loss (dB) – Preamplifier(dB).
3. Measurement (dBuV/m) = Reading(dBuV) + C.F (Correction Factor).
4. The emission levels of other frequencies are very lower than the limit and not show in test report.

EUT	AXE11000 Tri-Band Wi-Fi 6E Router	Date of Test	2022-12-26
Factor	DRH18-E	Temp. / Humidity	25°C /65%
Polarity	Horizontal	Site / Test Engineer	AC2 / Xuan
Test Mode	802.11ax-40MHz_TX_Band6_CH 107_ANT 0+1+2+3_NSS1	Test Voltage	AC 120V/60Hz

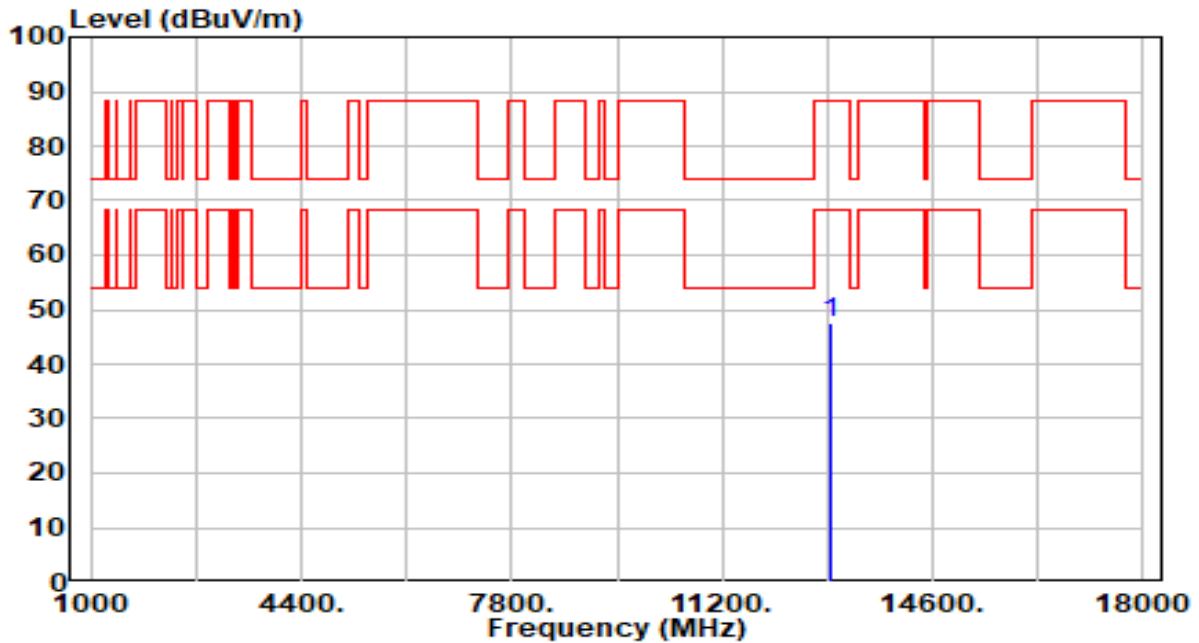

No	Frequency (MHz)	Reading (dBuV)	C.F (dB/m)	Measurement (dBuV/m)	Margin (dB)	Limit (dBuV/m)	Height (cm)	Angle (deg)	Remark (QP/PK/AV)
1	*	40.34	7.25	47.59	-40.61	88.20	100	89	Peak

Note:

1. " *", means this data is the worst emission level.
2. C.F (Correction Factor) = Antenna Factor (dB/m) + Cable Loss (dB) – Preamplifier(dB).
3. Measurement (dBuV/m) = Reading(dBuV) + C.F (Correction Factor).
4. The emission levels of other frequencies are very lower than the limit and not show in test report.

EUT	AXE11000 Tri-Band Wi-Fi 6E Router	Date of Test	2022-12-26
Factor	DRH18-E	Temp. / Humidity	25°C /65%
Polarity	Vertical	Site / Test Engineer	AC2 / Xuan
Test Mode	802.11ax-40MHz_TX_Band6_CH 107_ANT 0+1+2+3_NSS1	Test Voltage	AC 120V/60Hz

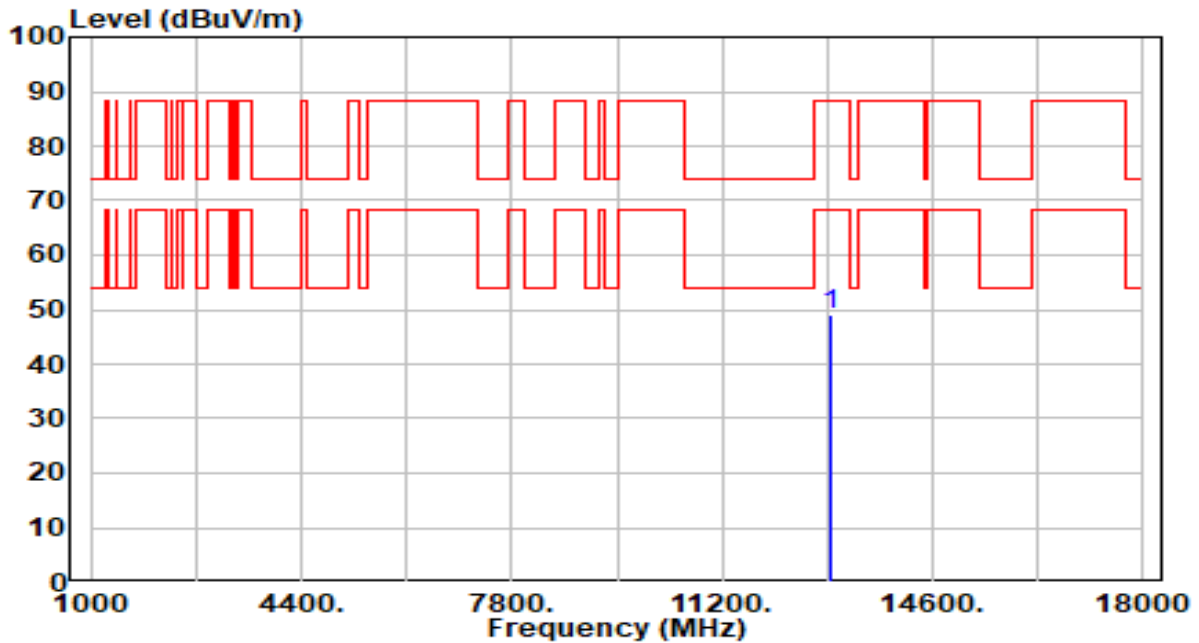

No	Frequency (MHz)	Reading (dBuV)	C.F (dB/m)	Measurement (dBuV/m)	Margin (dB)	Limit (dBuV/m)	Height (cm)	Angle (deg)	Remark (QP/PK/AV)
1	*	41.94	7.25	49.19	-39.01	88.20	200	240	Peak

Note:

1. " *", means this data is the worst emission level.
2. C.F (Correction Factor) = Antenna Factor (dB/m) + Cable Loss (dB) – Preamplifier(dB).
3. Measurement (dBuV/m) = Reading(dBuV) + C.F (Correction Factor).
4. The emission levels of other frequencies are very lower than the limit and not show in test report.

EUT	AXE11000 Tri-Band Wi-Fi 6E Router	Date of Test	2022-12-26
Factor	DRH18-E	Temp. / Humidity	25°C /65%
Polarity	Horizontal	Site / Test Engineer	AC2 / Xuan
Test Mode	802.11ax-40MHz_TX_Band6_CH 115_ANT 0+1+2+3_NSS1	Test Voltage	AC 120V/60Hz

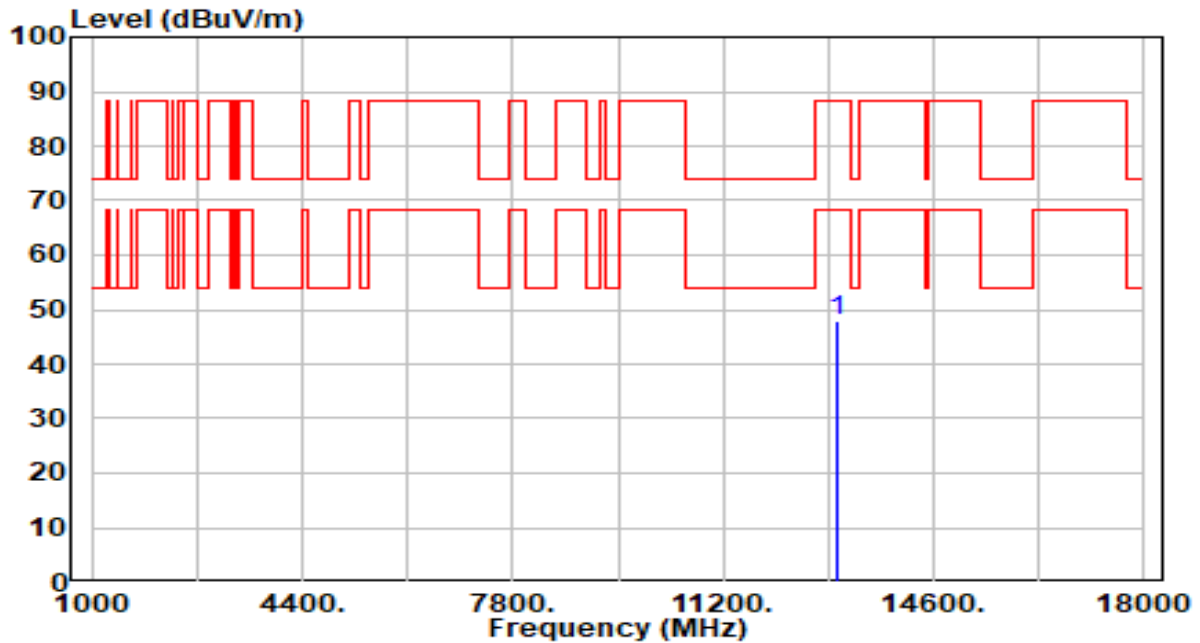

No	Frequency (MHz)	Reading (dBuV)	C.F (dB/m)	Measurement (dBuV/m)	Margin (dB)	Limit (dBuV/m)	Height (cm)	Angle (deg)	Remark (QP/PK/AV)	
1	*	13050.000	40.61	7.23	47.84	-40.36	88.20	100	360	Peak

Note:

1. " *", means this data is the worst emission level.
2. C.F (Correction Factor) = Antenna Factor (dB/m) + Cable Loss (dB) – Preamplifier(dB).
3. Measurement (dBuV/m) = Reading(dBuV) + C.F (Correction Factor).
4. The emission levels of other frequencies are very lower than the limit and not show in test report.

EUT	AXE11000 Tri-Band Wi-Fi 6E Router	Date of Test	2022-12-26
Factor	DRH18-E	Temp. / Humidity	25°C /65%
Polarity	Vertical	Site / Test Engineer	AC2 / Xuan
Test Mode	802.11ax-40MHz_TX_Band6_CH 115_ANT 0+1+2+3_NSS1	Test Voltage	AC 120V/60Hz

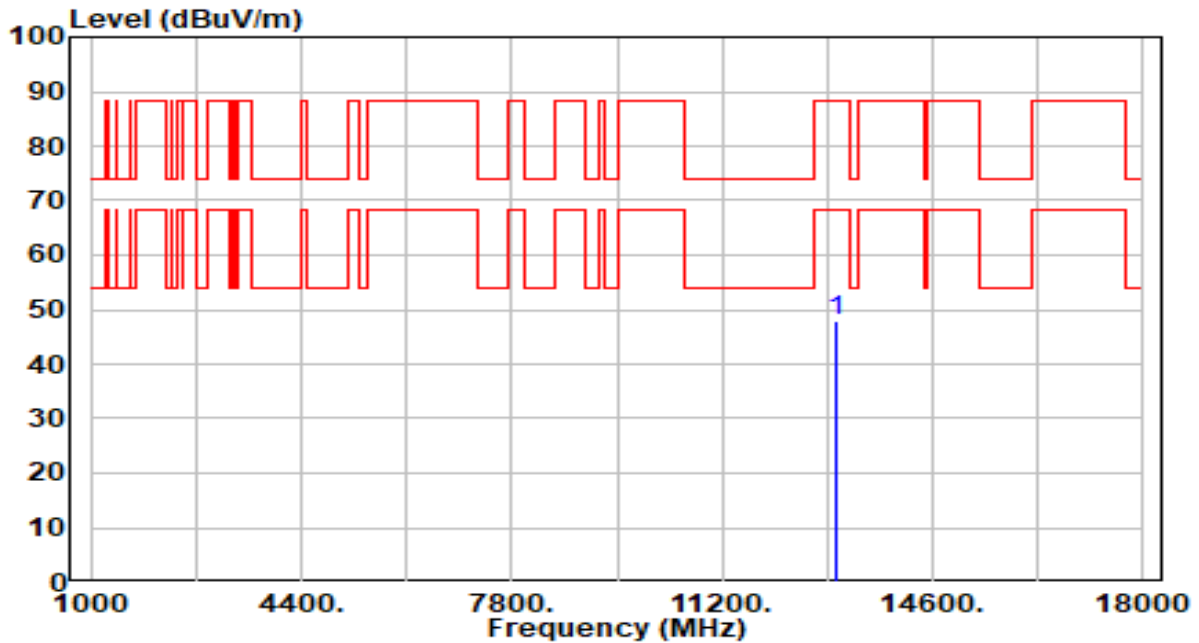

No	Frequency (MHz)	Reading (dBuV)	C.F (dB/m)	Measurement (dBuV/m)	Margin (dB)	Limit (dBuV/m)	Height (cm)	Angle (deg)	Remark (QP/PK/AV)	
1	*	13050.000	40.67	7.23	47.90	-40.30	88.20	200	236	Peak

Note:

1. " *", means this data is the worst emission level.
2. C.F (Correction Factor) = Antenna Factor (dB/m) + Cable Loss (dB) – Preamplifier(dB).
3. Measurement (dBuV/m) = Reading(dBuV) + C.F (Correction Factor).
4. The emission levels of other frequencies are very lower than the limit and not show in test report.

EUT	AXE11000 Tri-Band Wi-Fi 6E Router	Date of Test	2022-12-26
Factor	DRH18-E	Temp. / Humidity	25°C /65%
Polarity	Horizontal	Site / Test Engineer	AC2 / Xuan
Test Mode	802.11ax-40MHz_TX_Band7_CH 123_ANT 0+1+2+3_NSS1	Test Voltage	AC 120V/60Hz

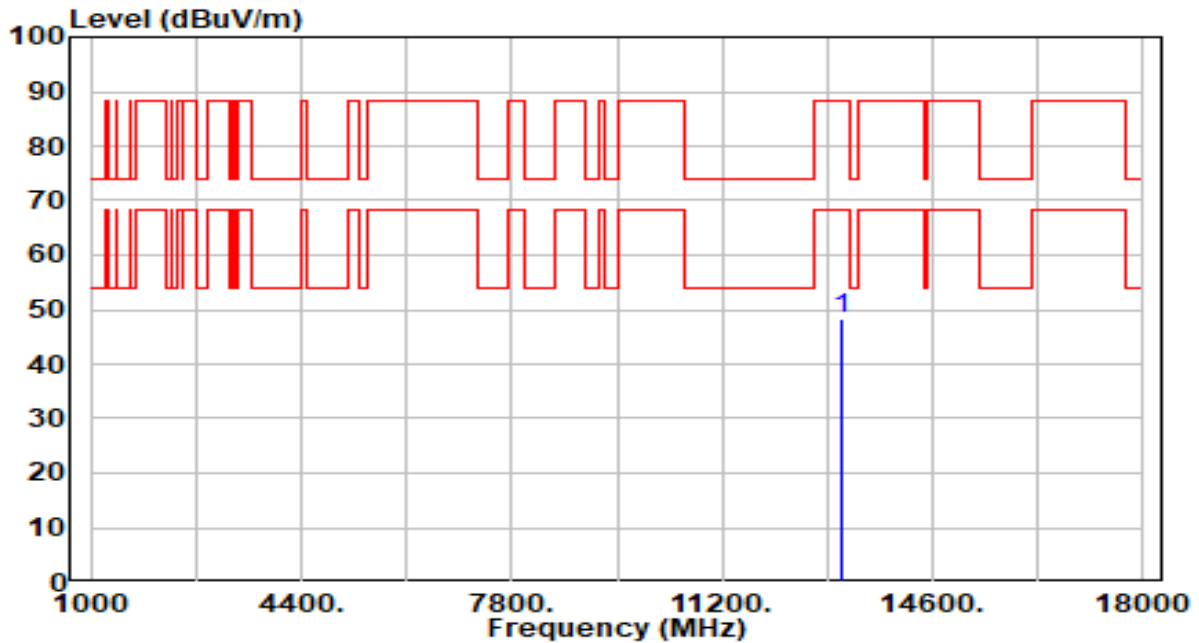

No	Frequency (MHz)	Reading (dBuV)	C.F (dB/m)	Measurement (dBuV/m)	Margin (dB)	Limit (dBuV/m)	Height (cm)	Angle (deg)	Remark (QP/PK/AV)	
1	*	13130.000	40.97	7.17	48.14	-40.06	88.20	100	292	Peak

Note:

1. " *", means this data is the worst emission level.
2. C.F (Correction Factor) = Antenna Factor (dB/m) + Cable Loss (dB) – Preamplifier(dB).
3. Measurement (dBuV/m) = Reading(dBuV) + C.F (Correction Factor).
4. The emission levels of other frequencies are very lower than the limit and not show in test report.