

## RF MEASUREMENT REPORT

---

**FCC ID** : 2AXJ4AXE200OMNI  
**Applicant** : TP-Link Corporation Limited  
**Application Type** : Certification  
**Product** : AXE11000 Tri-Band Wi-Fi 6E Router  
**Model No.** : Archer AXE200 Omni  
**Brand Name** : tp-link  
**FCC Classification** : 15E 6GHz Low Power Indoor Access Point (6ID)  
**FCC Rule Part(s)** : Part 15 Subpart E (Section 15.407)  
**Received Date** : December 12 ,2022  
**Test Date** : December 22 ,2022~January 02 ,2023

**Tested By** : Owen Tsai

( Owen Tsai )

**Reviewed By** : Paddy Chen

( Paddy Chen )

**Approved By** : Chenz Ker

( Chenz Ker )



The test results relate only to the samples tested.

This equipment has been shown to be capable of compliance with the applicable technical standards as indicated in the measurement report and was tested in accordance with the measurement procedures specified in KDB789033. Test results reported herein relate only to the item(s) tested.

The test report shall not be reproduced except in full without the written approval of MRT Technology ( Taiwan ) Co., Ltd.

### Revision History

Report No.	Version	Description	Issue Date	Note
2212TW0117-U5	1.0	Original Report	2023-03-30	Valid

---

## CONTENTS

Description	Page
<b>General Information.....</b>	<b>6</b>
<b>1. INTRODUCTION .....</b>	<b>7</b>
1.1. Scope.....	7
1.2. MRT Test Location.....	7
<b>2. Product Information .....</b>	<b>8</b>
2.1. Equipment Description.....	8
2.2. Radio Specification .....	8
2.3. Working Frequencies .....	9
2.4. Antenna Details.....	10
2.5. Test Mode .....	11
2.6. Test System Connection Diagram .....	12
2.7. Test System Details .....	12
2.8. Test Software.....	12
2.9. Applied Standards.....	13
2.10. Duty Cycle.....	13
2.11. Test Environment Condition .....	14
<b>3. Antenna Requirements .....</b>	<b>15</b>
<b>4. Measuring Instrument .....</b>	<b>16</b>
<b>5. Measurement Uncertainty.....</b>	<b>17</b>
<b>6. Test Result.....</b>	<b>18</b>
6.1. Summary.....	18
6.2. 26dB Bandwidth.....	19
6.2.1. Test Limit .....	19
6.2.2. Test Procedure.....	19
6.2.3. Test Setting .....	19
6.2.4. Test Setup .....	20
6.2.5. Test Result .....	21
6.3. Output Power .....	30
6.3.1. Test Limit.....	30
6.3.2. Test Procedure Used .....	30
6.3.3. Test Setting .....	30
6.3.4. Test Setup .....	30
6.3.5. Test Result .....	31
6.4. Power Spectral Density.....	37
6.4.1. Test Limit.....	37

---

6.4.2.	Test Procedure Used .....	37
6.4.3.	Test Setting .....	37
6.4.4.	Test Setup .....	38
6.4.5.	Test Result .....	39
6.5.	In-Band Emission Measurement.....	99
6.5.1.	Test Limit .....	99
6.5.2.	Test Procedure used .....	99
6.5.3.	Test Setting .....	99
6.5.4.	Test Setup .....	100
6.5.5.	Test Result .....	101
6.6.	Frequency Stability Measurement .....	157
6.6.1.	Test Limit .....	157
6.6.2.	Test Procedure.....	157
6.6.3.	Test Setup .....	158
6.6.4.	Test Result .....	159
6.7.	Contention Based Protocol .....	160
6.7.1.	Test Limit .....	160
6.7.2.	Test Procedure Used .....	160
6.7.3.	Test Setting .....	160
6.7.4.	Test Setup .....	161
6.7.5.	Test Result .....	162
6.8.	Radiated Spurious Emission.....	173
6.8.1.	Test Limit .....	173
6.8.2.	Test Procedure Used .....	173
6.8.3.	Test Setting .....	173
6.8.4.	Test Setup .....	175
6.8.5.	Test Result .....	176
6.9.	Radiated Restricted Band Edge .....	350
6.9.1.	Test Limit .....	350
6.9.2.	Test Procedure Used .....	351
6.9.3.	Test Setting .....	351
6.9.4.	Test Setup .....	352
6.9.5.	Test Result .....	353
6.10.	AC Conducted Emissions .....	417
6.10.1.	Test Limit.....	417
6.10.2.	Test Setup.....	417
6.10.3.	Test Result.....	418
<b>7.</b>	<b>Conclusion .....</b>	<b>422</b>

**Appendix A : Test Setup Photograph .....423**

**Appendix B : External Photograph .....424**

**Appendix C : Internal Photograph .....425**

## General Information

<b>Applicant</b>	TP-Link Corporation Limited
<b>Applicant Address</b>	Room 901, 9/F., New East Ocean Centre, 9 Science Museum Road, Tsim Sha Tsui, Kowloon, Hongkong
<b>Manufacturer</b>	TP-Link Corporation Limited
<b>Manufacturer Address</b>	Room 901, 9/F., New East Ocean Centre, 9 Science Museum Road, Tsim Sha Tsui, Kowloon, Hongkong
<b>Test Site</b>	MRT Technology (Taiwan) Co., Ltd
<b>Test Site Address</b>	No. 38, Fuxing Second Rd., Guishan Dist., Taoyuan City 333, Taiwan (R.O.C)
<b>MRT FCC Registration No.</b>	291082
<b>FCC Rule Part(s)</b>	Part 15.407

## Test Facility / Accreditations

1. MRT facility is a FCC registered (Reg. No. 291082) test facility with the site description report on file and is designated by the FCC as an Accredited Test Firm.
2. MRT facility is an IC registered (MRT Reg. No. 21723) test laboratory with the site description on file at Industry Canada.
3. MRT Lab is accredited to ISO 17025 by the Taiwan Accreditation Foundation (TAF Cert. No. 3261) in EMC, Telecommunications and Radio testing for FCC (Designation Number: TW3261), Industry Taiwan, EU and TELEC Rules.

## 1. INTRODUCTION

### 1.1. Scope

Measurement and determination of electromagnetic emissions (EMC) of radio frequency devices including intentional and/or unintentional radiators for compliance with the technical rules and regulations of the Federal Communications Commission and the Innovation, Science and Economic Development Canada and Certification and Engineering Bureau.

### 1.2. MRT Test Location

The map below shows the location of the MRT LABORATORY, its proximity to the Taoyuan City. These measurement tests were conducted at the MRT Technology (Taiwan) Co., Ltd. Facility located at No.38, Fuxing 2nd Rd., Guishan Dist., Taoyuan City 33377, Taiwan (R.O.C).

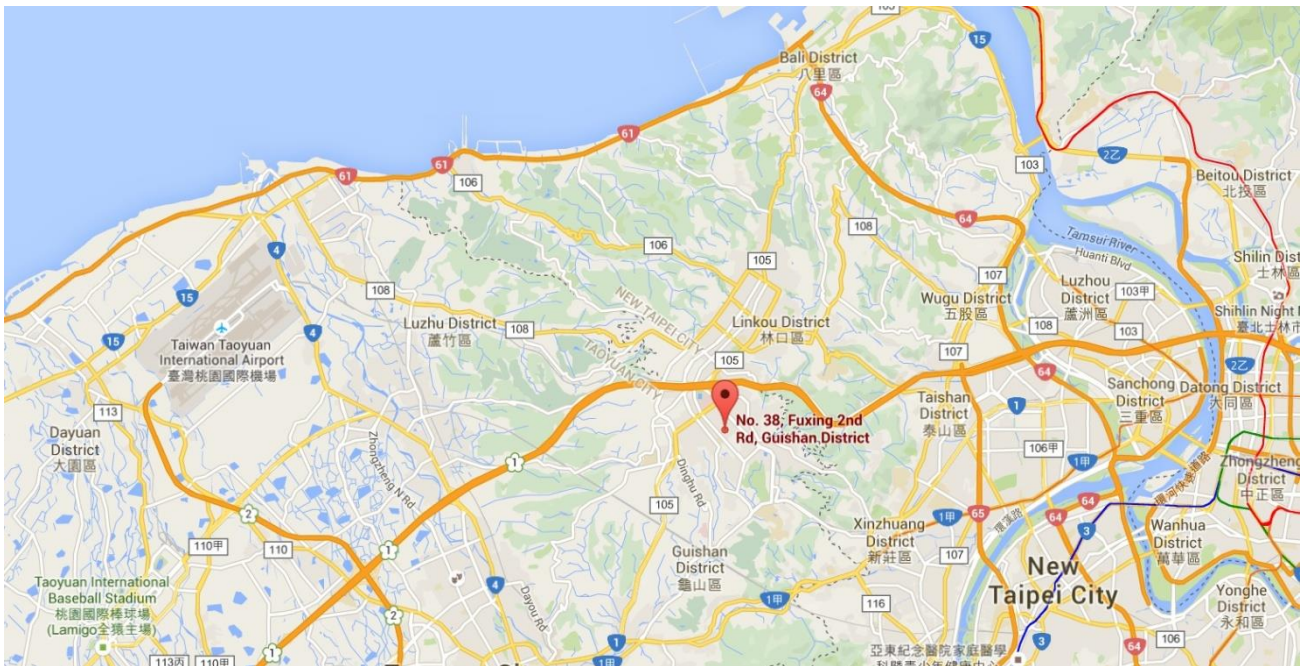

## 2. Product Information

### 2.1. Equipment Description

Product Name	AXE11000 Tri-Band Wi-Fi 6E Router
Model No.	Archer AXE200
Brand Name	tp-link
Specification	WLAN: 802.11a/b/g/n/ac/ax WPAN: Bluetooth Mode: V4.2
Power Supply	AC/DC Adapter
Accessory	
Adapter	MODEL: S065PQ1200500 INPUT: 100 - 240V ~ 50/60Hz 1.8A. OUTPUT: 12.0V=5.0A 60.0W Cable Out: Non-shielding, 1.2m

### 2.2. Radio Specification

Frequency Range	For 802.11ax-HE20: 6115 ~ 7095MHz For 802.11ax-HE40: 6125 ~ 7085MHz For 802.11ax-HE80: 6145 ~ 7025MHz For 802.11ax-HE160: 6185 ~ 6985MHz
Type of Modulation	802.11ax: OFDMA
Data Rate	802.11ax: up to 4804Mbps

Note: For other features of this EUT, test report will be issued separately.



## 2.3. Working Frequencies

### 802.11ax-HE20

Channel	Frequency	Channel	Frequency	Channel	Frequency
33	6115 MHz	37	6135 MHz	41	6155 MHz
45	6175 MHz	49	6195 MHz	53	6215 MHz
57	6235 MHz	61	6255 MHz	65	6275 MHz
69	6295 MHz	73	6315 MHz	77	6335 MHz
81	6355 MHz	85	6375 MHz	89	6395 MHz
93	6415 MHz	97	6435 MHz	101	6455 MHz
105	6475 MHz	109	5495 MHz	113	6515 MHz
117	6535 MHz	121	6555 MHz	125	6575 MHz
129	6595 MHz	133	6615 MHz	137	6635 MHz
141	6655 MHz	145	6675 MHz	149	6695 MHz
153	6715 MHz	157	6735 MHz	161	6755 MHz
165	6775 MHz	169	6795 MHz	173	6815 MHz
177	6835 MHz	181	6855 MHz	185	6875 MHz
189	6895 MHz	193	6915 MHz	197	6935 MHz
201	6955 MHz	205	6975 MHz	209	6995 MHz
213	7015 MHz	217	7035 MHz	221	7055 MHz
225	7075 MHz	229	7095 MHz	--	--

### 802.11ax-HE40

Channel	Frequency	Channel	Frequency	Channel	Frequency
35	6125 MHz	43	6165 MHz	51	6205 MHz
59	6245 MHz	67	6285 MHz	75	6325 MHz
83	6365 MHz	91	6405 MHz	99	6445 MHz
107	6485 MHz	115	6525 MHz	123	6565 MHz
131	6605 MHz	139	6645 MHz	147	6685 MHz
155	6725 MHz	163	6765 MHz	171	6805 MHz
179	6845 MHz	187	6885 MHz	195	6925 MHz
203	6965 MHz	211	7005 MHz	219	7045 MHz
227	7085 MHz	--	--	--	--

## 802.11ax-HE80

Channel	Frequency	Channel	Frequency	Channel	Frequency
39	6145 MHz	55	6225 MHz	71	6305 MHz
87	6385 MHz	103	6465 MHz	119	6545 MHz
135	6625 MHz	151	6705 MHz	167	6785 MHz
183	6865 MHz	199	6945 MHz	215	7025 MHz

## 802.11ax-HE160

Channel	Frequency	Channel	Frequency	Channel	Frequency
47	6185 MHz	79	6345 MHz	111	6505 MHz
143	6665 MHz	175	6825 MHz	207	6985 MHz

## 2.4. Antenna Details

Antenna Type	Frequency Band (MHz)	Tx Paths	Number of spatial streams	Antenna Gain (dBi)	Beamforming Directional Gain (dBi)	CDD Directional Gain (dBi)	
						For Power	For PSD
Dipole Antenna	2412 ~ 2462	4	1	3.00	9.02	3.00	9.02
	5180 ~ 5825	4	1	3.00	9.02	3.00	9.02
	6115 ~ 7095	4	1	3.00	9.02	3.00	9.02
	6115 ~ 7095	4	4	3.00	--	3.00	3.00

**Note:**

- The EUT supports Cyclic Delay Diversity (CDD) mode, and CDD signals are correlated.  
If all antennas have the same gain,  $G_{ANT}$ , Directional gain =  $G_{ANT} + \text{Array Gain}$ , where Array Gain is as follows.
  - For power spectral density (PSD) measurements on all devices,  
Array Gain =  $10 \log(N_{ANT}/N_{SS})$  dB;
  - For power measurements on IEEE 802.11 devices,  
Array Gain = 0 dB for  $N_{ANT} \leq 4$ ;
- The EUT also supports Beam Forming mode, and the Beam Forming support 802.11ac/ax, not include 802.11a/b/g/n. BF Directional gain =  $G_{ANT} + 10 \log(N_{ANT})$ .
- The information as above is from the antenna specifications.

Test Mode	T <sub>x</sub> Paths	CDD Mode	Beamforming Mode
802.11b/g/n (DTS)	4	√	X
802.11ax (DTS)	4	√	√
802.11a/n (NII)	4	√	X
802.11ac/ax (NII)	4	√	√
802.11ax (6ID)	4	√	√

## 2.5. Test Mode

CDD Mode
Mode 1: Transmit by 802.11ax-HE20_Nss=1 (MCS0)
Mode 2: Transmit by 802.11ax-HE40_Nss=1 (MCS0)
Mode 3: Transmit by 802.11ax-HE80_Nss=1 (MCS0)
Mode 4: Transmit by 802.11ax-HE160_Nss=1 (MCS0)
Mode 5: Transmit by 802.11ax-HE20_Nss=4 (MCS0)
Mode 6: Transmit by 802.11ax-HE40_Nss=4 (MCS0)
Mode 7: Transmit by 802.11ax-HE80_Nss=4 (MCS0)
Mode 8: Transmit by 802.11ax-HE160_Nss=4 (MCS0)
Beamforming Mode
Mode 9: Transmit by 802.11ax-HE20_Nss=1 (MCS0)
Mode 10: Transmit by 802.11ax-HE40_Nss=1 (MCS0)
Mode 11: Transmit by 802.11ax-HE80_Nss=1 (MCS0)
Mode 12: Transmit by 802.11ax-HE160_Nss=1 (MCS0)
Remark:
<ol style="list-style-type: none"> <li>For Radiated emission, the modulation and the data rate picked for testing are determined by the Max. RF conducted power.</li> <li>Due to CDD mode was the worst mode, so all test items were evaluated in this report. The beamforming mode only evaluated the RF output power.</li> <li>EUT supports one configuration only in 802.11ax full RU mode.</li> <li>As Designated by manufacturer, the lowest data rate was the worst condition, so all the tests were done with lowest data rate.</li> </ol>

## 2.6. Test System Connection Diagram

The device was tested per the guidance ANSI C63.10: 2013 was used to reference the appropriate EUT setup for radiated emissions testing and AC line conducted testing.

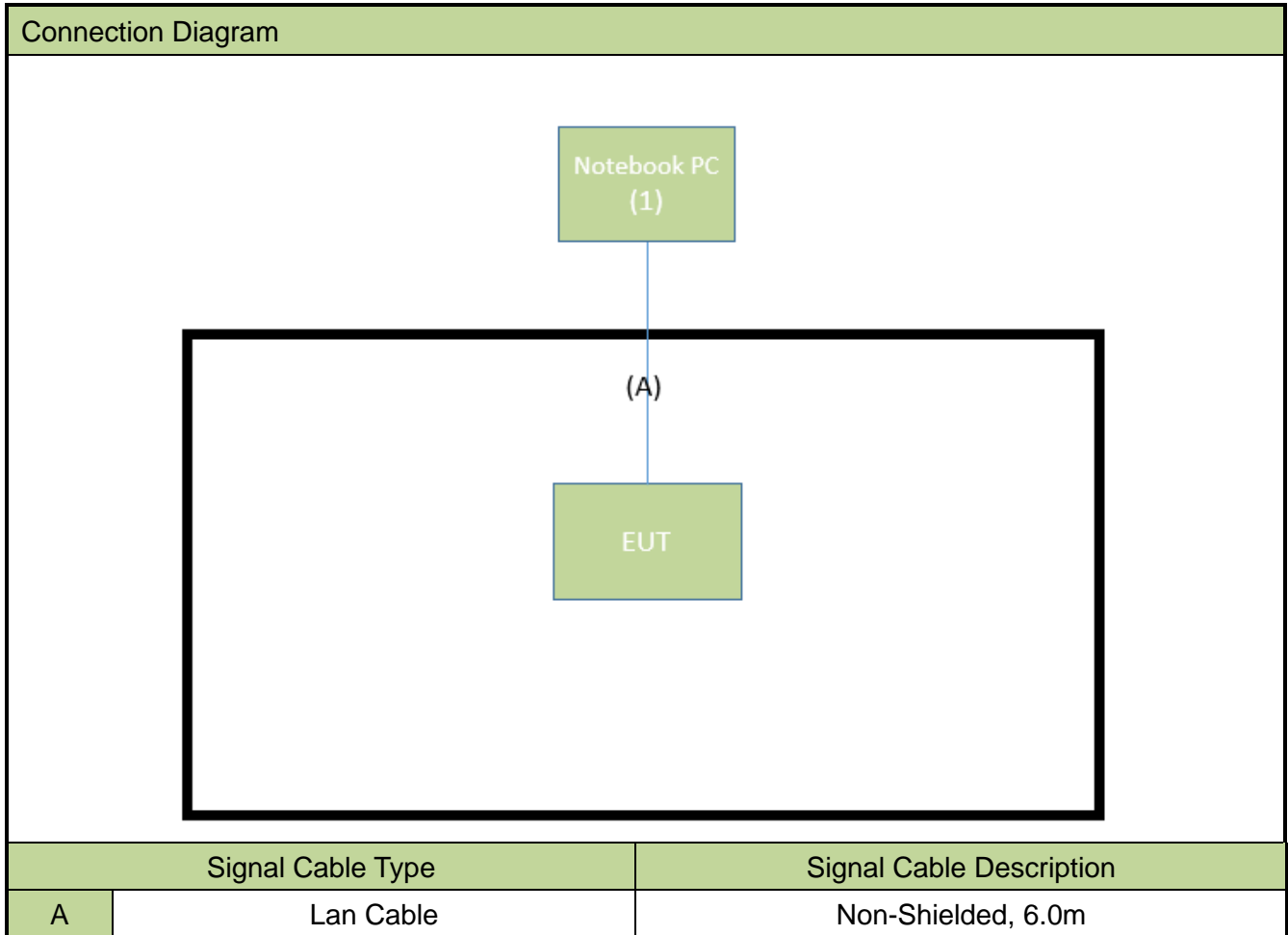

## 2.7. Test System Details

No.	Product	Brand	Model No.	Serial No.	Power Cord
1	Notebook PC	Lenovo	20Y7-006KTW	N/A	Non-shielded, 0.8m

## 2.8. Test Software

The test utility software used during testing was “accessMTool”, and the version was 3.2.1.2.

Note: Final power setting please refer to operational description.

## 2.9. Applied Standards

According to the specifications of the manufacturer, the EUT must comply with the requirements of the following standards:

- ANSI C63.10-2013
- FCC KDB 789033 D02v02r01
- FCC KDB 987594 D02v01
- FCC KDB 662911 D01v02r01
- FCC KDB 414788 D01v01r01
- FCC KDB 412172 D01v01r01

## 2.10. Duty Cycle

The maximum achievable duty cycles for all modes were determined based on measurements performed on a spectrum analyzer in zero-span mode with RBW = 8MHz, VBW = 50MHz. The RBW and VBW were both greater than  $50/T$ , where T is the minimum transmission duration, and the number of sweep points across T was greater than 100. The duty cycles are as follows:

Test Mode	Duty Cycle
802.11ax-HE20	98.08%
802.11ax-HE40	97.04%
802.11ax-HE80	93.88%
802.11ax-HE160	90.33%

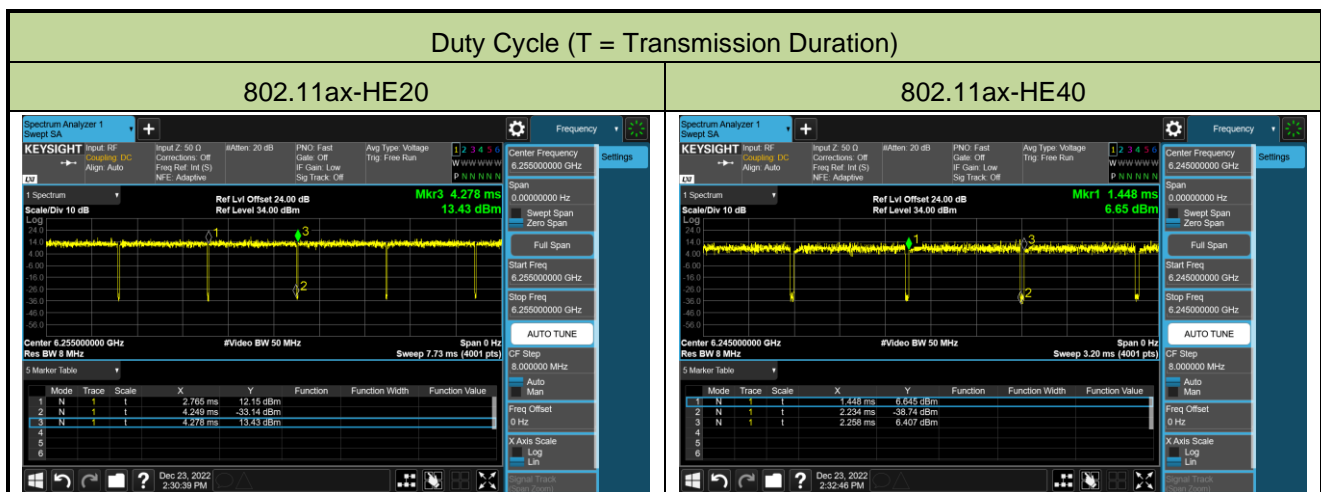

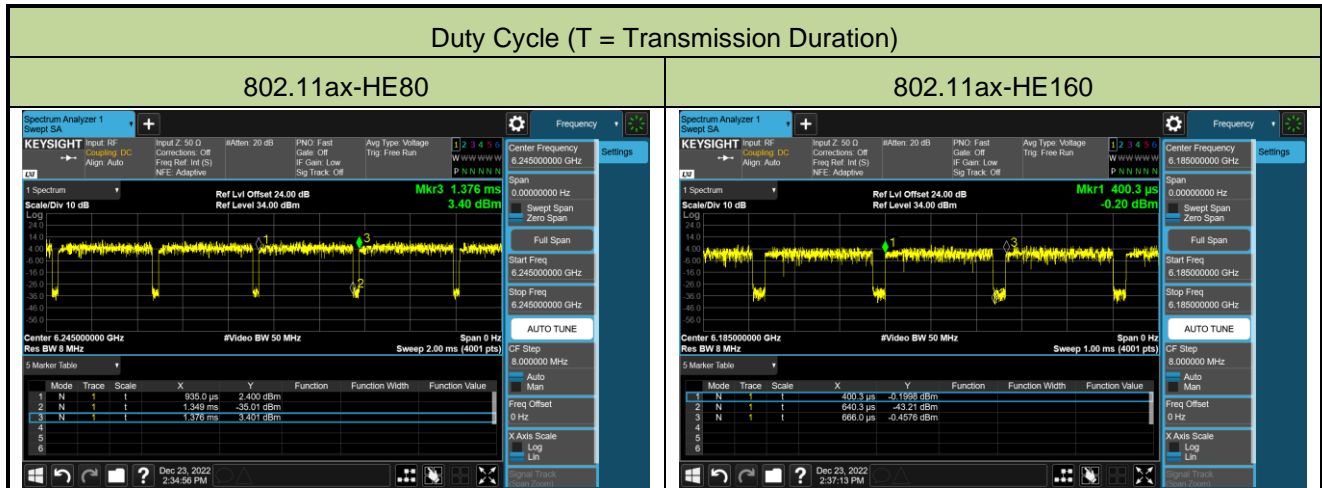

## 2.11. Test Environment Condition

Ambient Temperature	15°C~35°C
Relative Humidity	20%RH ~75%RH

### 3. Antenna Requirements

**Excerpt from §15.407(a)(9) of the FCC Rules/Regulations:**

Access points operating under the provisions of paragraphs (a)(5) and (a)(6) of this section must employ a permanently attached integrated antenna.

- The antenna of the device is built in and locked inside the enclosure.

**Conclusion:**

The device complies with the requirement of §15.407(a)(9).

## 4. Measuring Instrument

### Conducted Emissions

Instrument	Manufacturer	Type No.	Asset No.	Cali. Interval	Cali. Due Date
Two-Line V-Network	R&S	ENV216	MRTTWA00019	1 year	2023/3/7
Two-Line V-Network	R&S	ENV216	MRTTWA00020	1 year	2023/4/20
EMI Test Receiver	R&S	ESR3	MRTTWA00045	1 year	2023/5/9
DIVA PLUS Funk-Wetterstation	TFA	35.1083	MRTTWA00050	1 year	2023/6/16

### Radiated Emissions

Instrument	Manufacturer	Type No.	Asset No.	Cali. Interval	Cali. Due Date
Broadband TRILOG Antenna	SCHWARZBECK	VULB 9162	MRTTWA00001	1 year	2023/12/21
Active Loop Antenna	SCHWARZBECK	FMZB 1519B	MRTTWA00002	1 year	2023/5/24
Broadband Hornantenna	SCHWARZBECK	BBHA 9120D	MRTTWA00003	1 year	2023/3/30
BreitbandHornantenna	SCHWARZBECK	BBHA 9170	MRTTWA00004	1 year	2023/3/29
Broadband Preamplifier	SCHWARZBECK	BBV 9718	MRTTWA00005	1 year	2023/3/30
Broadband Amplifier	SCHWARZBECK	BBV 9721	MRTTWA00006	1 year	2023/3/30
Signal Analyzer	R&S	FSV40	MRTTWA00007	1 year	2023/3/16
EMI Test Receiver	R&S	ESR3	MRTTWA00009	1 year	2023/3/9
EXA Signal Analyzer	KEYSIGHT	N9010A	MRTTWA00012	1 year	2023/10/5
EXA Signal Analyzer	KEYSIGHT	N9010B	MRTTWA00074	1 year	2023/7/19
Antenna Cable	HUBERSUHNER	SF106	MRTTWE00010	1 year	2023/6/14
Temperature/Humidity Meter	TFA	35.1078.10.IT	MRTTWA00032	1 year	2023/6/5

### Conducted Test Equipment

Instrument	Manufacturer	Type No.	Asset No.	Cali. Interval	Cali. Due Date
X-Series USB Peak and Average Power Sensor	KEYSIGHT	U2021XA	MRTTWA00014	1 year	2023/4/20
EXA Signal Analyzer	KEYSIGHT	N9010A	MRTTWA00012	1 year	2023/10/5
EXA Signal Analyzer	KEYSIGHT	N9010B	MRTTWA00074	1 year	2023/7/19
Attenuator	WTI	218FS-20	MRTTWE00026	1 year	2023/11/18
Attenuator	WTI	218FS-10	MRTTWE00027	1 year	2023/6/15
Temperature & Humidity Chamber	TEN BILLION	TTH-B3UP	MRTTWA00036	1 year	2023/6/14
DIVA PLUS Funk-Wetterstation	TFA	35.1083	MRTTWA00050	1 year	2023/6/16

Software	Version	Function
e3	9.160520a	EMI Test Software



## 5. Measurement Uncertainty

Where relevant, the following test uncertainty levels have been estimated for tests performed on the EUT as specified in CISPR 16-4-2. This uncertainty represents an expanded uncertainty expressed at approximately the 95% confidence level using a coverage factor of  $k = 2$ .

<b>AC Conducted Emission Measurement</b>
Measuring Uncertainty for a Level of Confidence of 95% ( $U=2Uc(y)$ ): 150kHz~30MHz: $\pm 2.53\text{dB}$
<b>Radiated Emission Measurement</b>
Measuring Uncertainty for a Level of Confidence of 95% ( $U=2Uc(y)$ ): 9kHz ~ 1GHz: $\pm 4.25\text{dB}$ 1GHz ~ 40GHz: $\pm 4.45\text{dB}$
<b>Conducted Power (Carrier Power / Power Density)</b>
Measuring Uncertainty for a Level of Confidence of 95% ( $U=2Uc(y)$ ): $\pm 0.84\text{dB}$
<b>Conducted Spurious Emission</b>
Measuring Uncertainty for a Level of Confidence of 95% ( $U=2Uc(y)$ ): $\pm 2.65\text{ dB}$
<b>Occupied Bandwidth</b>
Measuring Uncertainty for a Level of Confidence of 95% ( $U=2Uc(y)$ ): $\pm 3.3\%$
<b>Temp. / Humidity</b>
Measuring Uncertainty for a Level of Confidence of 95% ( $U=2Uc(y)$ ): $\pm 0.82^\circ\text{C} / \pm 3\%$
<b>Frequency Error</b>
Measuring Uncertainty for a Level of Confidence of 95% ( $U=2Uc(y)$ ): $\pm 78.4\text{Hz}$

## 6. Test Result

### 6.1. Summary

FCC Section(s)	Test Description	Test Condition	Verdict
15.407(a)	26dB Bandwidth	Conducted	Pass
15.407(a)(5)	Maximum Equivalent Isotropically Radiated Power (E.I.R.P)		Pass
15.407(a)(5)	Peak Power Spectral Density (E.I.R.P)		Pass
15.407(b)(7)	In-Band Emission		Pass
15.407(g)	Frequency Stability		Pass
15.407(d)(6)	Contention-Based Protocol		Pass
15.407(b)(5)	Unwanted Emissions		Pass
15.407(b)(7), (8), (9)	General Field Strength (Restricted Bands and Radiated Emission)	Radiated	Pass
15.207	AC Conducted Emissions 150kHz - 30MHz	Line Conducted	Pass

**Notes:**

1. Determining compliance is based on the test results met the regulation limits or requirements declared by clients, and the test results don't take into account the value of measurement uncertainty.
2. The analyzer plots shown in this section were all taken with a correction table loaded into the analyzer. The correction table was used to account for the losses of the cables and attenuators used as part of the system to connect the EUT to the analyzer at all frequencies of interest.
3. For radiated emission test, the test results shown in the following sections represent the worst-case emissions.

## 6.2. 26dB Bandwidth

### 6.2.1. Test Limit

N/A

### 6.2.2. Test Procedure

KDB 789033 D02v02r01- Section II) C.1 (26dB Bandwidth)

KDB 789033 D02v02r01- Section II) D (99% Bandwidth)

### 6.2.3. Test Setting

#### 26dB Bandwidth

1. The analyzers' automatic bandwidth measurement capability was used to perform the 26dB bandwidth measurement. The "X" dB bandwidth parameter was set to  $X = 26$ . The automatic bandwidth measurement function also has the capability of simultaneously measuring the 99% occupied bandwidth. The bandwidth measurement was not influenced by any intermediated power nulls in the fundamental emission.
2. RBW = approximately 1% of the emission bandwidth.
3. VBW > RBW.
4. Detector = Peak.
5. Trace mode = max hold.

#### 99% Bandwidth

1. Set center frequency to the nominal EUT channel center frequency.
2. Set span = 1.5 times to 5.0 times the OBW.
3. Set RBW = 1% to 5% of the OBW
4. Set VBW  $\geq 3 \times$  RBW
5. Detector = Peak.
6. Use the 99% power bandwidth function of the instrument.

### 6.2.4. Test Setup

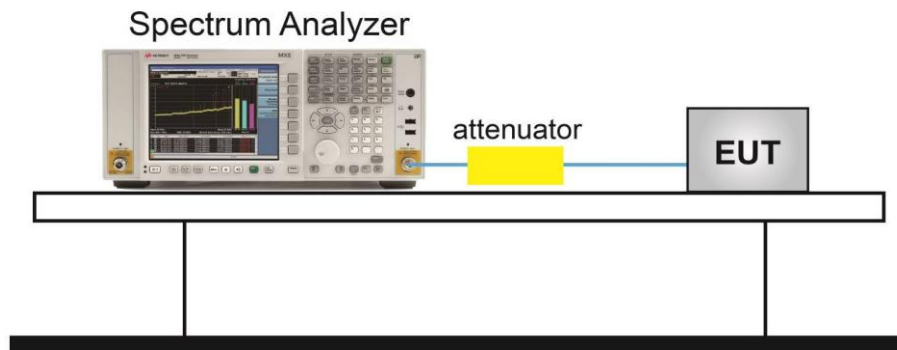

### 6.2.5. Test Result

Test Site	SR6	Test Engineer	Marvin
Test Date	2022/12/29		

Test Mode	Data Rate/ MCS	Channel No.	Frequency (MHz)	26dB Bandwidth (MHz)	99% Bandwidth (MHz)
802.11ax-HE20	MCS0	33	6115	21.550	19.108
802.11ax-HE20	MCS0	61	6255	21.930	19.115
802.11ax-HE20	MCS0	93	6415	22.420	19.100
802.11ax-HE20	MCS0	97	6435	25.220	19.169
802.11ax-HE20	MCS0	105	6475	22.600	19.097
802.11ax-HE20	MCS0	113	6515	21.460	19.144
802.11ax-HE20	MCS0	117	6535	24.780	19.133
802.11ax-HE20	MCS0	153	6715	22.700	19.228
802.11ax-HE20	MCS0	181	6855	23.380	19.059
802.11ax-HE20	MCS0	185	6875	22.610	19.104
802.11ax-HE20	MCS0	189	6895	25.860	19.160
802.11ax-HE20	MCS0	213	7015	22.390	19.211
802.11ax-HE20	MCS0	229	7095	21.330	19.120
802.11ax-HE40	MCS0	35	6125	41.000	37.783
802.11ax-HE40	MCS0	59	6245	40.890	37.847
802.11ax-HE40	MCS0	91	6405	41.710	37.822
802.11ax-HE40	MCS0	99	6445	42.900	37.788
802.11ax-HE40	MCS0	107	6485	41.650	37.771
802.11ax-HE40	MCS0	115	6525	41.750	37.917
802.11ax-HE40	MCS0	123	6565	41.580	37.810
802.11ax-HE40	MCS0	147	6685	42.410	37.786
802.11ax-HE40	MCS0	179	6845	49.660	37.863
802.11ax-HE40	MCS0	187	6885	44.930	37.838
802.11ax-HE40	MCS0	195	6925	42.030	37.790
802.11ax-HE40	MCS0	211	7005	41.230	37.838
802.11ax-HE40	MCS0	227	7085	40.750	37.925

Test Mode	Data Rate/ MCS	Channel No.	Frequency (MHz)	26dB Bandwidth (MHz)	99% Bandwidth (MHz)
802.11ax-HE80	MCS0	39	6145	84.680	77.576
802.11ax-HE80	MCS0	55	6225	81.720	77.644
802.11ax-HE80	MCS0	87	6385	84.000	77.521
802.11ax-HE80	MCS0	103	6465	80.820	77.575
802.11ax-HE80	MCS0	119	6545	81.460	77.472
802.11ax-HE80	MCS0	135	6625	83.060	77.486
802.11ax-HE80	MCS0	151	6705	82.470	77.410
802.11ax-HE80	MCS0	183	6865	82.830	77.588
802.11ax-HE80	MCS0	199	6945	82.900	77.510
802.11ax-HE80	MCS0	215	7025	82.190	77.516
802.11ax-HE160	MCS0	47	6185	163.100	156.360
802.11ax-HE160	MCS0	79	6345	163.800	156.780
802.11ax-HE160	MCS0	111	6505	162.200	156.980
802.11ax-HE160	MCS0	143	6665	164.500	156.690
802.11ax-HE160	MCS0	175	6825	162.900	156.450
802.11ax-HE160	MCS0	207	6985	164.100	156.970

## 802.11ax-HE20 26dB Bandwidth &amp; 99% Bandwidth

Channel 33 (6115MHz)

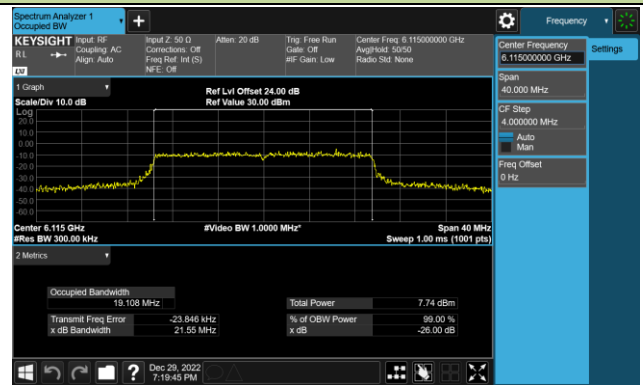

Channel 61 (6255MHz)

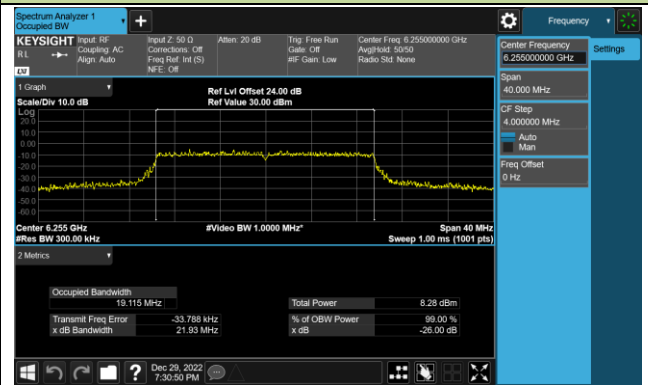

Channel 93 (6415MHz)

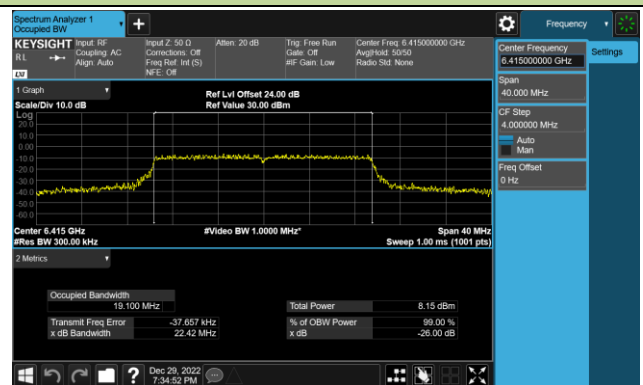

Channel 97 (6435MHz)

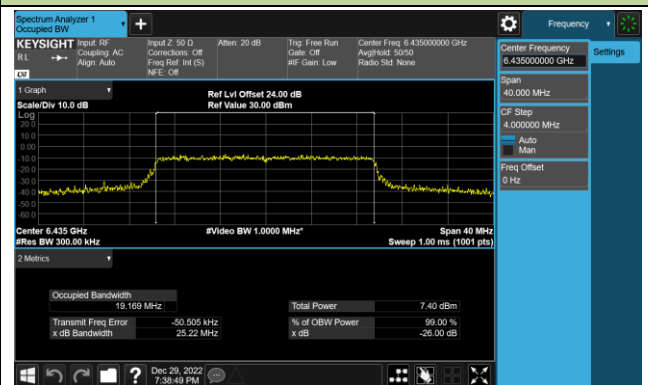

Channel 105 (6475MHz)

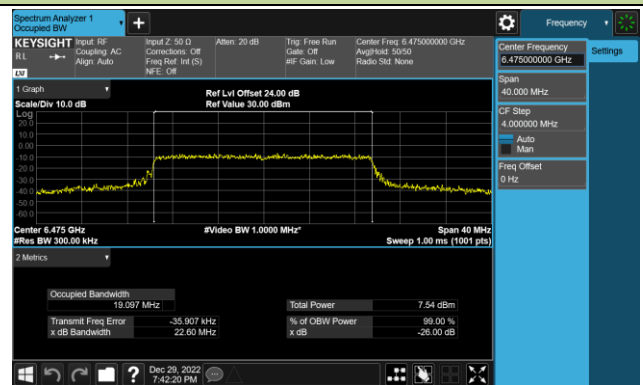

Channel 113 (6515MHz)

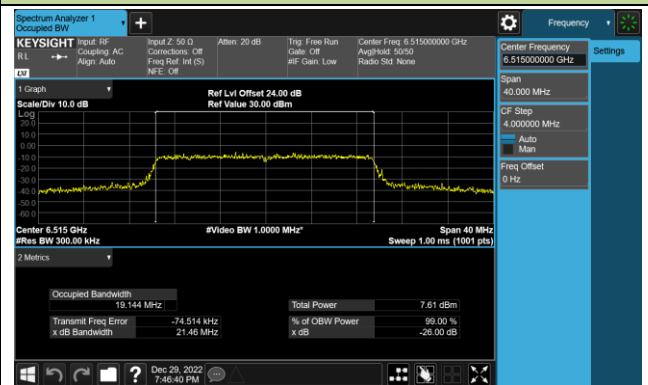

Channel 117 (6535MHz)

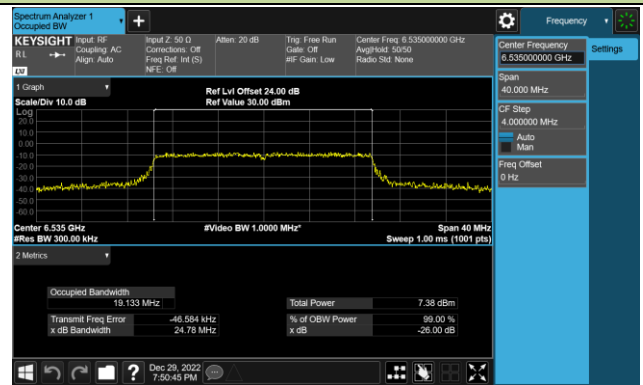

Channel 153 (6715MHz)

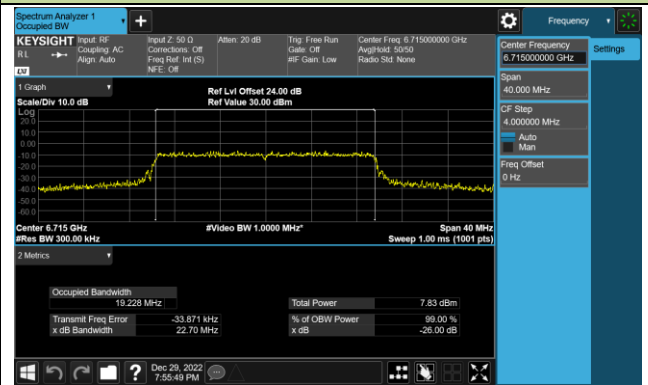

802.11ax-HE20 26dB Bandwidth & 99% Bandwidth

Channel 181 (6855MHz)

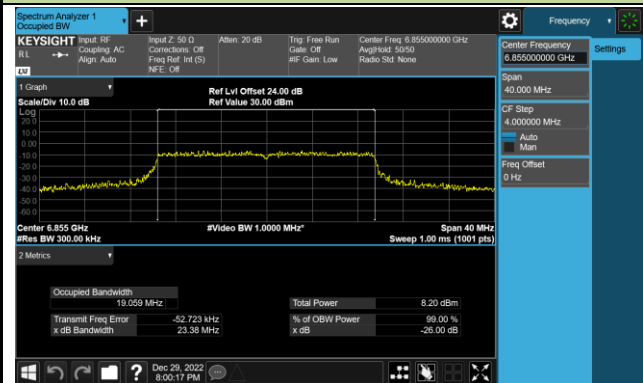

Channel 185 (6875MHz)

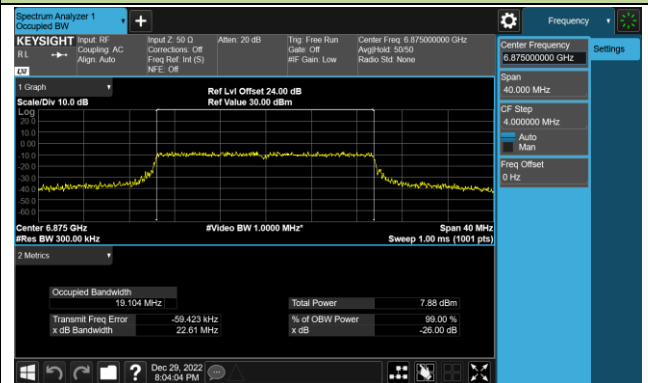

Channel 189 (6895MHz)

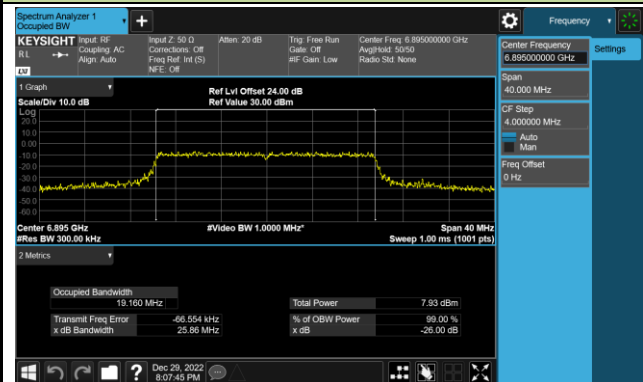

Channel 213 (7015MHz)

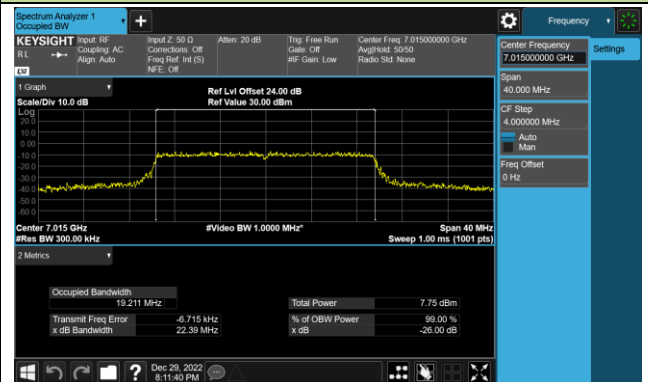

Channel 229 (7095MHz)

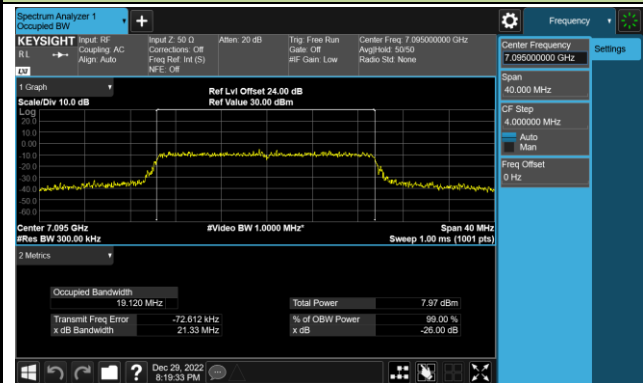



802.11ax-HE40 26dB Bandwidth & 99% Bandwidth

Channel 35 (6125MHz)

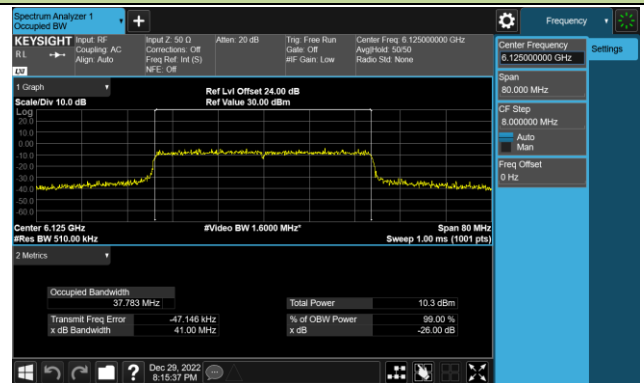

Channel 59 (6245MHz)

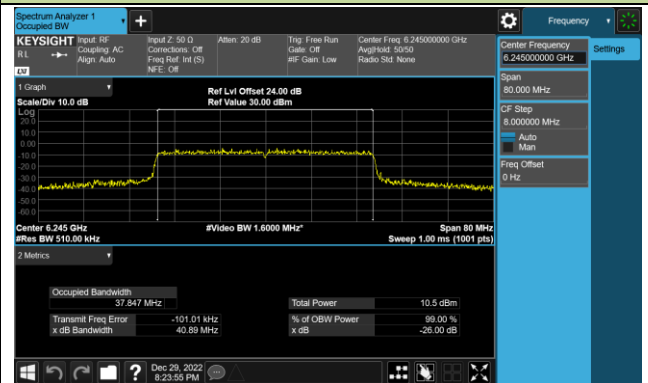

Channel 91 (6405MHz)

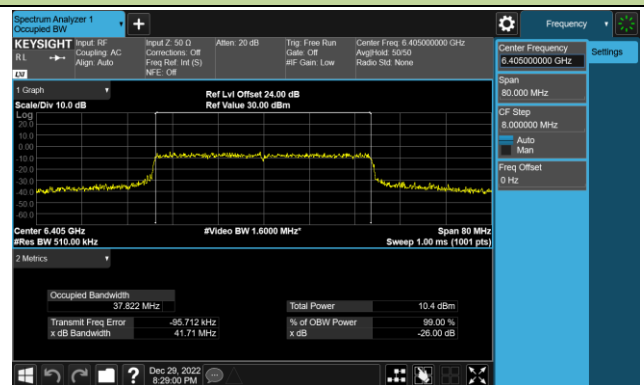

Channel 99 (6445MHz)

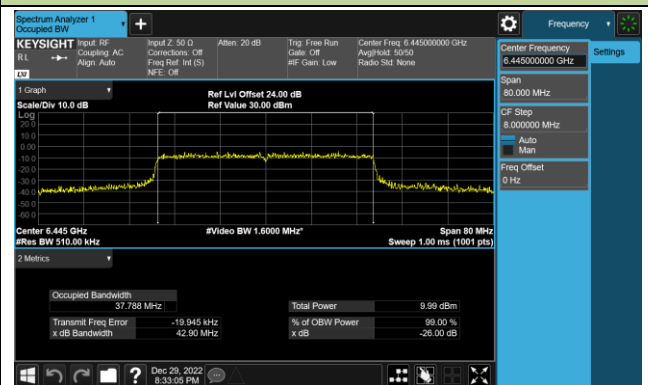

Channel 107 (6485MHz)

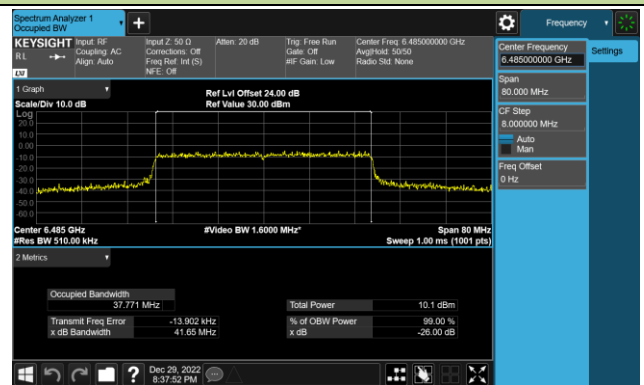

Channel 115 (6525MHz)

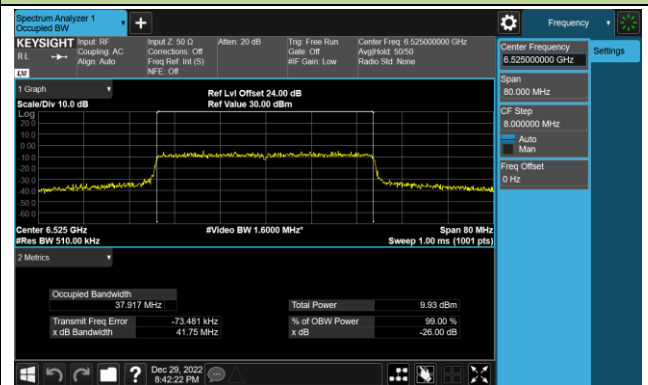

Channel 123 (6565MHz)

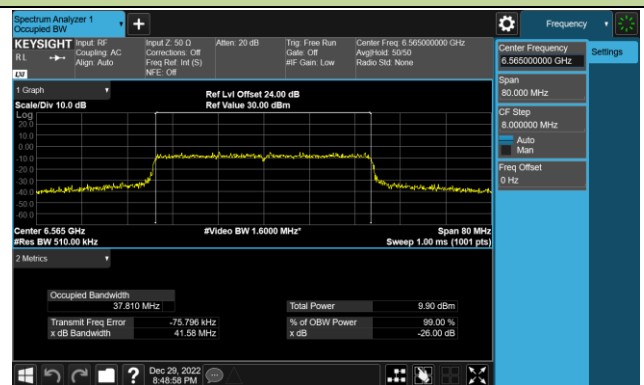

Channel 147 (6685MHz)

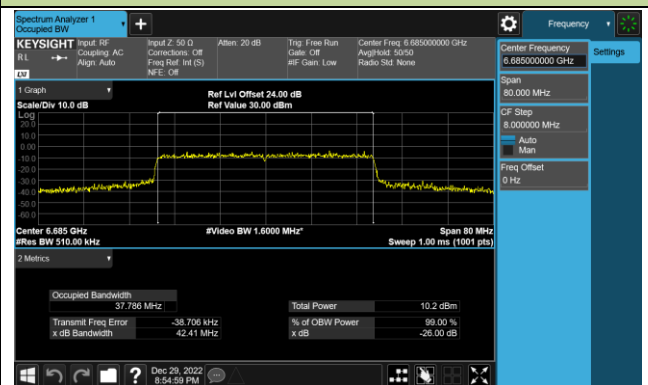

802.11ax-HE40 26dB Bandwidth & 99% Bandwidth

Channel 179 (6845MHz)

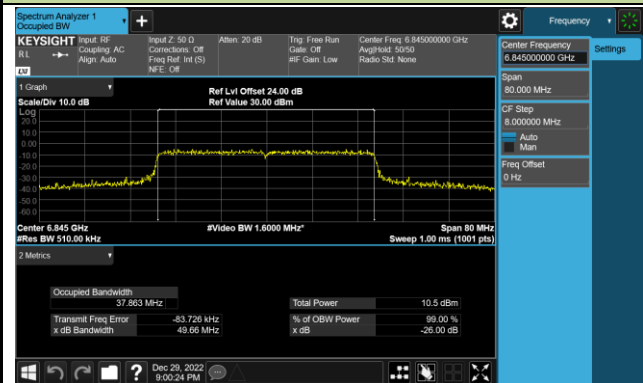

Channel 187 (6885MHz)

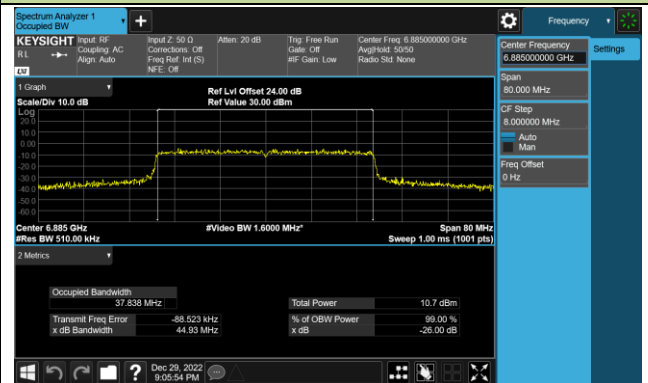

Channel 195 (6925MHz)

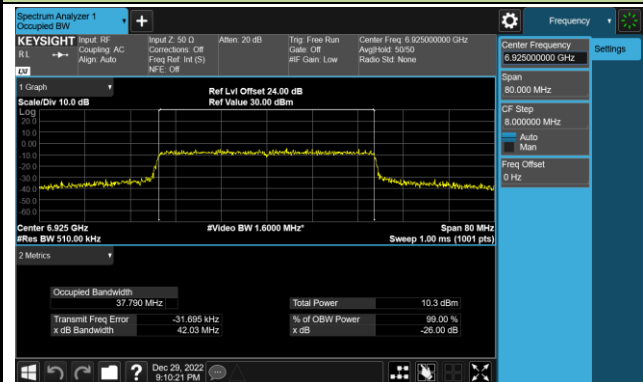

Channel 211 (7005MHz)

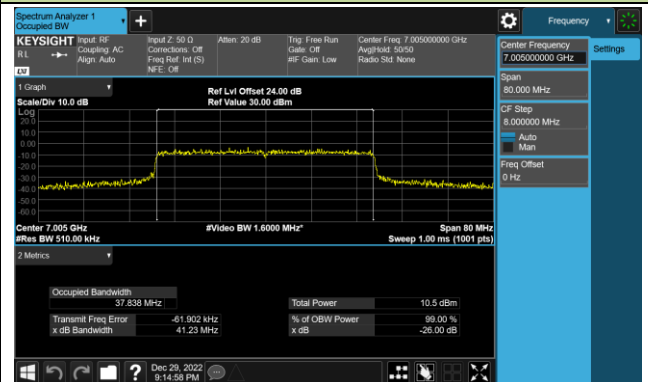

Channel 227 (7085MHz)

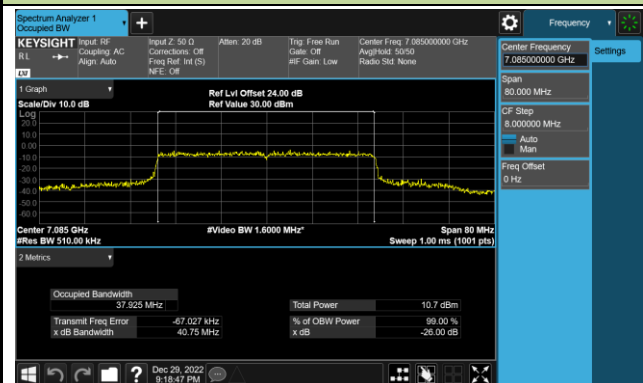

802.11ax-HE80 26dB Bandwidth & 99% Bandwidth

Channel 39 (6145MHz)

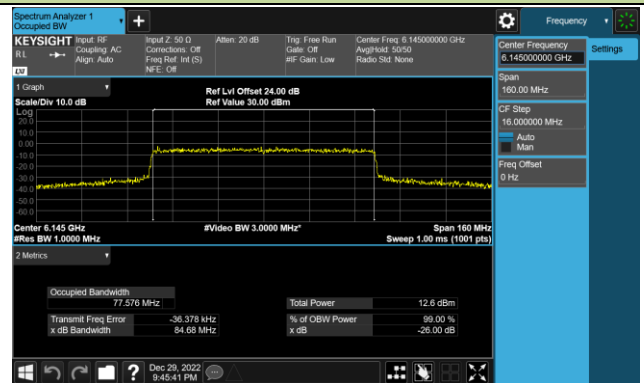

Channel 55 (6225MHz)

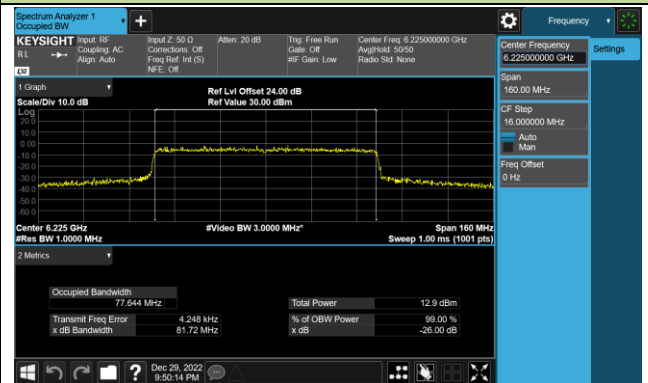

Channel 87 (6385MHz)

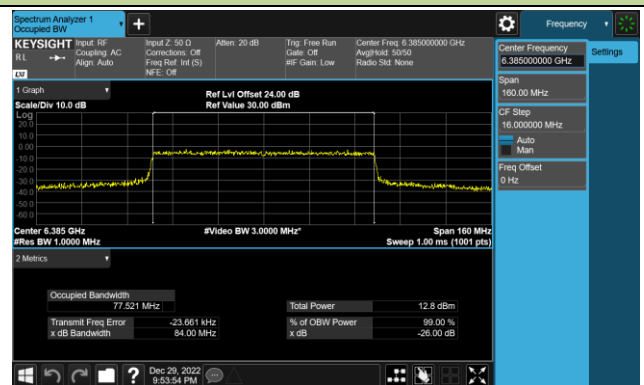

Channel 103 (6465MHz)

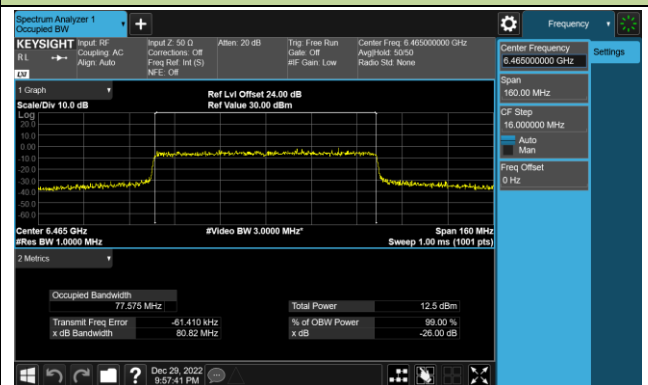

Channel 119 (6545MHz)

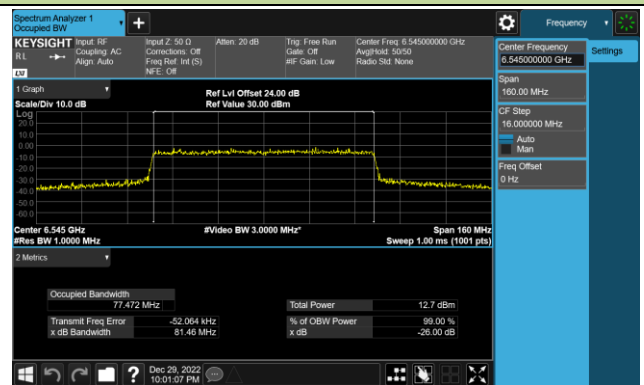

Channel 135 (6625MHz)

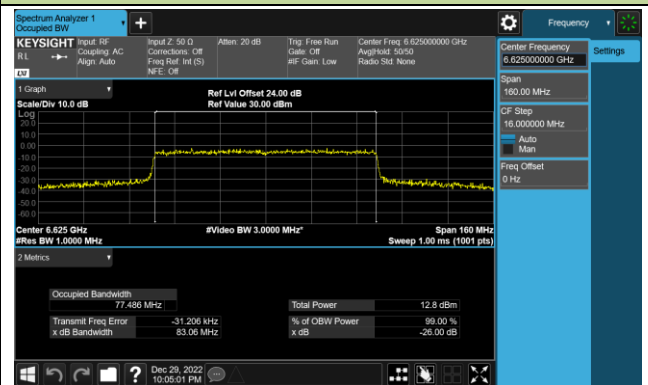

Channel 151 (6705MHz)

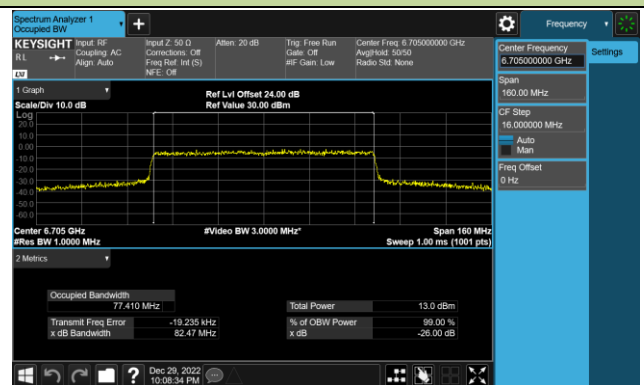

Channel 183 (6865MHz)

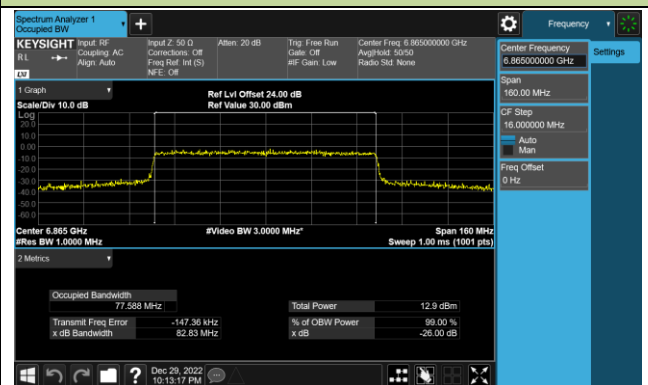

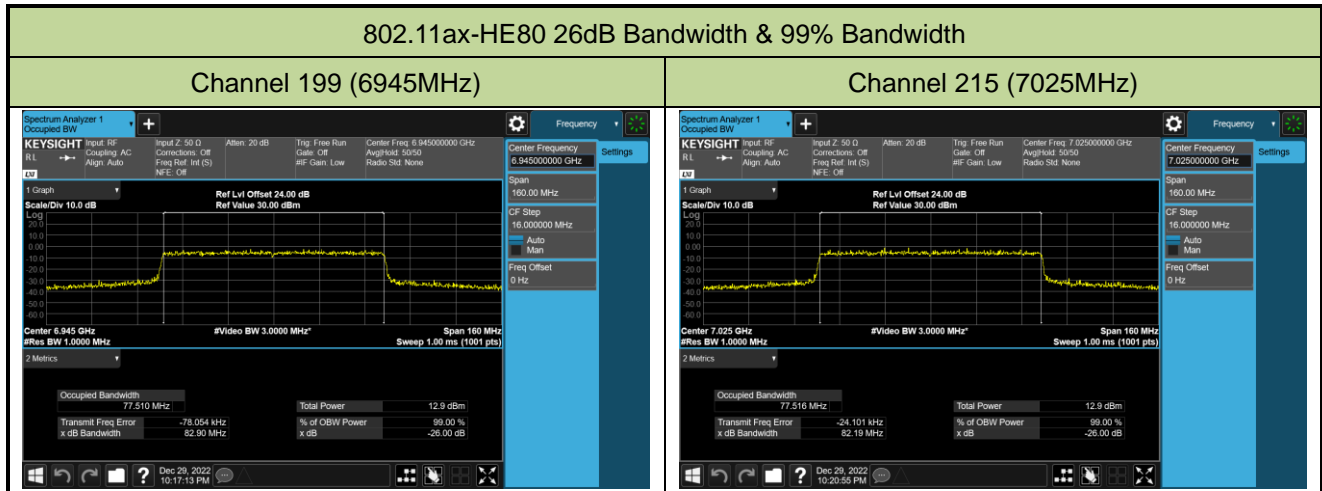



## 6.3. Output Power

### 6.3.1. Test Limit

For an indoor access point operating in the 5.925-7.125 GHz band, the maximum e.i.r.p. over the frequency band of operation must not exceed 30 dBm.

### 6.3.2. Test Procedure Used

KDB 789033 D02v02r01- Section II) E)3)b) Method PM-G

### 6.3.3. Test Setting

#### Average Power Measurement

Average power measurements were performed only when the EUT was transmitting at its maximum power control level using a broadband power meter with a pulse sensor. The power meter implemented triggering and gating capabilities which were set up such that power measurements were recorded only during the ON time of the transmitter.

### 6.3.4. Test Setup

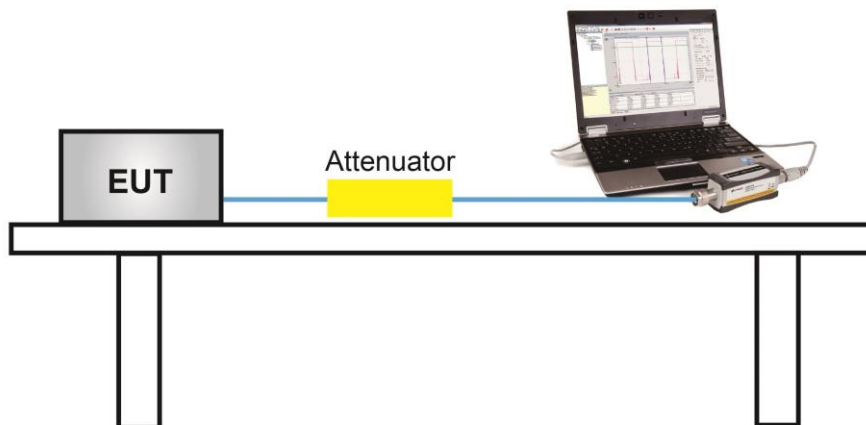

### 6.3.5. Test Result

Test Site	SR6	Test Engineer	Marvin
Test Date	2022/12/29		

Test Mode	Data Rate/ MCS	Channel No.	Freq. (MHz)	Average Power (dBm)				Total Average Power (dBm)	CDD Directional Gain (dBi)	EIRP (dBm)	EIRP Limit (dBm)
				Ant 0	Ant 1	Ant 2	Ant 3				
CDD Mode (Nss = 1)											
11ax-HE20	MCS0	33	6115	3.22	1.92	1.59	2.05	8.26	3.00	11.26	≤ 30.00
11ax-HE20	MCS0	61	6255	4.09	2.35	2.09	2.21	8.79	3.00	11.79	≤ 30.00
11ax-HE20	MCS0	93	6415	3.47	1.15	2.75	2.16	8.48	3.00	11.48	≤ 30.00
11ax-HE20	MCS0	97	6435	2.74	1.16	2.44	2.25	8.21	3.00	11.21	≤ 30.00
11ax-HE20	MCS0	105	6475	2.79	1.14	2.62	2.34	8.29	3.00	11.29	≤ 30.00
11ax-HE20	MCS0	113	6515	3.06	1.20	2.86	2.26	8.42	3.00	11.42	≤ 30.00
11ax-HE20	MCS0	117	6535	3.17	1.29	2.97	2.35	8.52	3.00	11.52	≤ 30.00
11ax-HE20	MCS0	153	6715	3.68	2.73	3.21	0.88	8.77	3.00	11.77	≤ 30.00
11ax-HE20	MCS0	181	6855	3.62	1.42	3.05	2.37	8.71	3.00	11.71	≤ 30.00
11ax-HE20	MCS0	185	6875	3.26	0.45	2.71	2.18	8.29	3.00	11.29	≤ 30.00
11ax-HE20	MCS0	189	6895	3.39	0.49	2.80	2.20	8.37	3.00	11.37	≤ 30.00
11ax-HE20	MCS0	213	7015	3.58	1.22	2.99	3.01	8.81	3.00	11.81	≤ 30.00
11ax-HE20	MCS0	229	7095	3.79	1.26	3.12	2.87	8.87	3.00	11.87	≤ 30.00
11ax-HE40	MCS0	35	6125	5.75	5.15	4.89	5.01	11.23	3.00	14.23	≤ 30.00
11ax-HE40	MCS0	59	6245	6.36	5.61	5.67	5.55	11.83	3.00	14.83	≤ 30.00
11ax-HE40	MCS0	91	6405	5.96	5.70	5.35	5.18	11.58	3.00	14.58	≤ 30.00
11ax-HE40	MCS0	99	6445	5.46	4.91	5.16	5.30	11.23	3.00	14.23	≤ 30.00
11ax-HE40	MCS0	107	6485	5.36	4.75	4.98	5.22	11.10	3.00	14.10	≤ 30.00
11ax-HE40	MCS0	115	6525	5.75	4.87	5.30	5.48	11.38	3.00	14.38	≤ 30.00
11ax-HE40	MCS0	123	6565	5.97	5.11	5.44	5.51	11.54	3.00	14.54	≤ 30.00
11ax-HE40	MCS0	147	6685	6.58	5.93	5.81	5.56	12.01	3.00	15.01	≤ 30.00
11ax-HE40	MCS0	179	6845	6.20	5.28	5.18	5.55	11.59	3.00	14.59	≤ 30.00
11ax-HE40	MCS0	187	6885	6.06	5.44	5.21	5.54	11.59	3.00	14.59	≤ 30.00
11ax-HE40	MCS0	195	6925	6.09	5.14	5.33	5.33	11.51	3.00	14.51	≤ 30.00
11ax-HE40	MCS0	211	7005	6.37	5.41	5.61	5.70	11.81	3.00	14.81	≤ 30.00
11ax-HE40	MCS0	227	7085	6.78	5.64	5.94	5.89	12.10	3.00	15.10	≤ 30.00

Test Mode	Data Rate/ MCS	Channel No.	Freq. (MHz)	Average Power (dBm)				Total Average Power (dBm)	CDD Directional Gain (dBi)	EIRP (dBm)	EIRP Limit (dBm)
				Ant 0	Ant 1	Ant 2	Ant 3				
CDD Mode (Nss = 1)											
11ax-HE80	MCS0	39	6145	8.72	7.97	8.09	7.92	14.21	3.00	17.21	≤ 30.00
11ax-HE80	MCS0	55	6225	9.27	8.29	8.51	8.31	14.63	3.00	17.63	≤ 30.00
11ax-HE80	MCS0	87	6385	8.89	8.27	8.61	8.42	14.57	3.00	17.57	≤ 30.00
11ax-HE80	MCS0	103	6465	8.43	7.51	8.03	8.12	14.06	3.00	17.06	≤ 30.00
11ax-HE80	MCS0	119	6545	8.95	7.97	8.32	8.29	14.42	3.00	17.42	≤ 30.00
11ax-HE80	MCS0	135	6625	9.37	8.52	8.42	8.22	14.68	3.00	17.68	≤ 30.00
11ax-HE80	MCS0	151	6705	9.39	8.76	8.90	8.42	14.90	3.00	17.90	≤ 30.00
11ax-HE80	MCS0	183	6865	8.81	8.27	8.43	8.20	14.45	3.00	17.45	≤ 30.00
11ax-HE80	MCS0	199	6945	8.94	8.16	8.28	8.28	14.45	3.00	17.45	≤ 30.00
11ax-HE80	MCS0	215	7025	9.35	8.70	8.49	8.64	14.83	3.00	17.83	≤ 30.00
11ax-HE160	MCS0	47	6185	11.33	10.68	10.71	10.40	16.81	3.00	19.81	≤ 30.00
11ax-HE160	MCS0	79	6345	10.97	10.34	10.77	10.63	16.70	3.00	19.70	≤ 30.00
11ax-HE160	MCS0	111	6505	10.98	10.14	10.24	10.21	16.43	3.00	19.43	≤ 30.00
11ax-HE160	MCS0	143	6665	11.59	10.78	11.01	10.45	17.00	3.00	20.00	≤ 30.00
11ax-HE160	MCS0	175	6825	10.97	9.95	10.38	10.11	16.39	3.00	19.39	≤ 30.00
11ax-HE160	MCS0	207	6985	11.14	10.24	10.83	10.60	16.74	3.00	19.74	≤ 30.00

Note 1: Total Average Power (dBm) =  $10 \cdot \log \{ 10^{(\text{Ant 0 Average Power} / 10)} + 10^{(\text{Ant 1 Average Power} / 10)} + 10^{(\text{Ant 2 Average Power} / 10)} + 10^{(\text{Ant 3 Average Power} / 10)} \}$ .

Note 2: CDD EIRP Power (dBm) = Total Average Power (dBm) + CDD Directional Gain (dBi).



Test Mode	Data Rate/ MCS	Channel No.	Freq. (MHz)	Average Power (dBm)				Total Average Power (dBm)	Beamforming Directional Gain (dBi)	EIRP (dBm)	EIRP Limit (dBm)
				Ant 0	Ant 1	Ant 2	Ant 3				
Beamforming Mode (Nss = 1)											
11ax-HE20	MCS0	33	6115	3.22	1.92	1.59	2.05	8.26	9.02	17.28	≤ 30.00
11ax-HE20	MCS0	61	6255	4.09	2.35	2.09	2.21	8.79	9.02	17.81	≤ 30.00
11ax-HE20	MCS0	93	6415	3.47	1.15	2.75	2.16	8.48	9.02	17.51	≤ 30.00
11ax-HE20	MCS0	97	6435	2.74	1.16	2.44	2.25	8.21	9.02	17.23	≤ 30.00
11ax-HE20	MCS0	105	6475	2.79	1.14	2.62	2.34	8.29	9.02	17.31	≤ 30.00
11ax-HE20	MCS0	113	6515	3.06	1.20	2.86	2.26	8.42	9.02	17.44	≤ 30.00
11ax-HE20	MCS0	117	6535	3.17	1.29	2.97	2.35	8.52	9.02	17.54	≤ 30.00
11ax-HE20	MCS0	153	6715	3.68	2.73	3.21	0.88	8.77	9.02	17.79	≤ 30.00
11ax-HE20	MCS0	181	6855	3.62	1.42	3.05	2.37	8.71	9.02	17.73	≤ 30.00
11ax-HE20	MCS0	185	6875	3.26	0.45	2.71	2.18	8.29	9.02	17.31	≤ 30.00
11ax-HE20	MCS0	189	6895	3.39	0.49	2.80	2.20	8.37	9.02	17.39	≤ 30.00
11ax-HE20	MCS0	213	7015	3.58	1.22	2.99	3.01	8.81	9.02	17.83	≤ 30.00
11ax-HE20	MCS0	229	7095	3.79	1.26	3.12	2.87	8.87	9.02	17.89	≤ 30.00
11ax-HE40	MCS0	35	6125	5.75	5.15	4.89	5.01	11.23	9.02	20.25	≤ 30.00
11ax-HE40	MCS0	59	6245	6.36	5.61	5.67	5.55	11.83	9.02	20.85	≤ 30.00
11ax-HE40	MCS0	91	6405	5.96	5.70	5.35	5.18	11.58	9.02	20.60	≤ 30.00
11ax-HE40	MCS0	99	6445	5.46	4.91	5.16	5.30	11.23	9.02	20.25	≤ 30.00
11ax-HE40	MCS0	107	6485	5.36	4.75	4.98	5.22	11.10	9.02	20.12	≤ 30.00
11ax-HE40	MCS0	115	6525	5.75	4.87	5.30	5.48	11.38	9.02	20.40	≤ 30.00
11ax-HE40	MCS0	123	6565	5.97	5.11	5.44	5.51	11.54	9.02	20.56	≤ 30.00
11ax-HE40	MCS0	147	6685	6.58	5.93	5.81	5.56	12.01	9.02	21.03	≤ 30.00
11ax-HE40	MCS0	179	6845	6.20	5.28	5.18	5.55	11.59	9.02	20.61	≤ 30.00
11ax-HE40	MCS0	187	6885	6.06	5.44	5.21	5.54	11.59	9.02	20.61	≤ 30.00
11ax-HE40	MCS0	195	6925	6.09	5.14	5.33	5.33	11.51	9.02	20.53	≤ 30.00
11ax-HE40	MCS0	211	7005	6.37	5.41	5.61	5.70	11.81	9.02	20.83	≤ 30.00
11ax-HE40	MCS0	227	7085	6.78	5.64	5.94	5.89	12.10	9.02	21.12	≤ 30.00

Test Mode	Data Rate/ MCS	Channel No.	Freq. (MHz)	Average Power (dBm)				Total Average Power (dBm)	Beamforming Directional Gain (dBi)	EIRP (dBm)	EIRP Limit (dBm)
				Ant 0	Ant 1	Ant 2	Ant 3				
Beamforming Mode (Nss = 1)											
11ax-HE80	MCS0	39	6145	8.72	7.97	8.09	7.92	14.21	9.02	23.23	≤ 30.00
11ax-HE80	MCS0	55	6225	9.27	8.29	8.51	8.31	14.63	9.02	23.65	≤ 30.00
11ax-HE80	MCS0	87	6385	8.89	8.27	8.61	8.42	14.57	9.02	23.59	≤ 30.00
11ax-HE80	MCS0	103	6465	8.43	7.51	8.03	8.12	14.06	9.02	23.08	≤ 30.00
11ax-HE80	MCS0	119	6545	8.95	7.97	8.32	8.29	14.42	9.02	23.44	≤ 30.00
11ax-HE80	MCS0	135	6625	9.37	8.52	8.42	8.22	14.68	9.02	23.70	≤ 30.00
11ax-HE80	MCS0	151	6705	9.39	8.76	8.90	8.42	14.90	9.02	23.92	≤ 30.00
11ax-HE80	MCS0	183	6865	8.81	8.27	8.43	8.20	14.45	9.02	23.47	≤ 30.00
11ax-HE80	MCS0	199	6945	8.94	8.16	8.28	8.28	14.45	9.02	23.47	≤ 30.00
11ax-HE80	MCS0	215	7025	9.35	8.70	8.49	8.64	14.83	9.02	23.85	≤ 30.00
11ax-HE160	MCS0	47	6185	11.33	10.68	10.71	10.40	16.81	9.02	25.83	≤ 30.00
11ax-HE160	MCS0	79	6345	10.97	10.34	10.77	10.63	16.70	9.02	25.72	≤ 30.00
11ax-HE160	MCS0	111	6505	10.98	10.14	10.24	10.21	16.43	9.02	25.45	≤ 30.00
11ax-HE160	MCS0	143	6665	11.59	10.78	11.01	10.45	17.00	9.02	26.02	≤ 30.00
11ax-HE160	MCS0	175	6825	10.97	9.95	10.38	10.11	16.39	9.02	25.41	≤ 30.00
11ax-HE160	MCS0	207	6985	11.14	10.24	10.83	10.60	16.74	9.02	25.76	≤ 30.00

Note 1: Total Average Power (dBm) =  $10 \cdot \log \{10^{(\text{Ant 0 Average Power} / 10)} + 10^{(\text{Ant 1 Average Power} / 10)} + 10^{(\text{Ant 2 Average Power} / 10)} + 10^{(\text{Ant 3 Average Power} / 10)}\}$ .

Note 2: Beamforming EIRP Power (dBm) = Total Average Power (dBm) + Beamforming Directional Gain (dBi).

Test Site	SR5	Test Engineer	Jay
Test Date	2022/7/29		

Test Mode	Data Rate/ MCS	Channel No.	Freq. (MHz)	Average Power (dBm)				Total Average Power (dBm)	CDD Directional Gain (dBi)	EIRP (dBm)	EIRP Limit (dBm)
				Ant 0	Ant 1	Ant 2	Ant 3				
CDD Mode (Nss = 4)											
11ax-HE20	MCS0	33	6115	9.50	8.22	8.76	8.35	14.76	3.00	17.76	≤ 30.00
11ax-HE20	MCS0	61	6255	9.50	8.26	8.89	7.88	14.70	3.00	17.70	≤ 30.00
11ax-HE20	MCS0	93	6415	8.58	7.59	8.55	7.28	14.06	3.00	17.06	≤ 30.00
11ax-HE20	MCS0	97	6435	8.37	7.55	8.18	7.31	13.89	3.00	16.89	≤ 30.00
11ax-HE20	MCS0	105	6475	8.47	7.78	8.27	7.45	14.03	3.00	17.03	≤ 30.00
11ax-HE20	MCS0	113	6515	8.76	7.80	8.51	7.43	14.18	3.00	17.18	≤ 30.00
11ax-HE20	MCS0	117	6535	8.91	8.01	8.51	7.71	14.33	3.00	17.33	≤ 30.00
11ax-HE20	MCS0	153	6715	9.64	8.39	8.81	7.90	14.75	3.00	17.75	≤ 30.00
11ax-HE20	MCS0	181	6855	9.12	7.77	8.02	7.64	14.20	3.00	17.20	≤ 30.00
11ax-HE20	MCS0	185	6875	9.59	7.89	8.39	8.04	14.55	3.00	17.55	≤ 30.00
11ax-HE20	MCS0	189	6895	9.44	7.76	8.34	8.22	14.51	3.00	17.51	≤ 30.00
11ax-HE20	MCS0	213	7015	9.51	8.24	8.33	8.18	14.62	3.00	17.62	≤ 30.00
11ax-HE20	MCS0	229	7095	9.51	8.36	8.48	7.94	14.63	3.00	17.63	≤ 30.00
11ax-HE40	MCS0	33	6125	11.94	9.06	11.13	10.55	16.81	3.00	19.81	≤ 30.00
11ax-HE40	MCS0	57	6245	12.21	10.58	11.41	10.53	17.26	3.00	20.26	≤ 30.00
11ax-HE40	MCS0	89	6405	12.10	10.86	11.42	10.66	17.32	3.00	20.32	≤ 30.00
11ax-HE40	MCS0	97	6445	11.51	10.87	11.19	10.04	16.96	3.00	19.96	≤ 30.00
11ax-HE40	MCS0	105	6485	11.39	10.39	10.55	10.19	16.68	3.00	19.68	≤ 30.00
11ax-HE40	MCS0	113	6525	11.69	10.65	10.75	10.34	16.91	3.00	19.91	≤ 30.00
11ax-HE40	MCS0	121	6565	11.95	10.27	11.18	10.54	17.05	3.00	20.05	≤ 30.00
11ax-HE40	MCS0	145	6685	13.13	11.83	12.02	10.94	18.07	3.00	21.07	≤ 30.00
11ax-HE40	MCS0	177	6845	12.26	10.77	11.25	10.63	17.30	3.00	20.30	≤ 30.00
11ax-HE40	MCS0	185	6885	12.64	11.15	11.52	10.66	17.58	3.00	20.58	≤ 30.00
11ax-HE40	MCS0	193	6925	12.49	10.90	11.24	10.98	17.47	3.00	20.47	≤ 30.00
11ax-HE40	MCS0	209	7005	12.77	11.14	10.95	11.17	17.59	3.00	20.59	≤ 30.00
11ax-HE40	MCS0	225	7085	12.91	11.57	11.17	11.53	17.87	3.00	20.87	≤ 30.00

Test Mode	Data Rate/ MCS	Channel No.	Freq. (MHz)	Average Power (dBm)				Total Average Power (dBm)	CDD Directional Gain (dBi)	EIRP (dBm)	EIRP Limit (dBm)
				Ant 0	Ant 1	Ant 2	Ant 3				
CDD Mode (Nss = 4)											
11ax-HE80	MCS0	33	6145	15.29	13.57	14.37	13.65	20.30	3.00	23.30	≤ 30.00
11ax-HE80	MCS0	49	6225	15.66	14.01	14.76	14.01	20.69	3.00	23.69	≤ 30.00
11ax-HE80	MCS0	81	6385	15.28	14.64	14.83	13.92	20.72	3.00	23.72	≤ 30.00
11ax-HE80	MCS0	97	6465	14.85	13.78	14.05	13.12	20.02	3.00	23.02	≤ 30.00
11ax-HE80	MCS0	113	6545	15.06	14.31	14.04	13.34	20.25	3.00	23.25	≤ 30.00
11ax-HE80	MCS0	129	6625	16.01	14.64	15.00	14.08	21.01	3.00	24.01	≤ 30.00
11ax-HE80	MCS0	145	6705	16.01	14.55	14.90	14.03	20.96	3.00	23.96	≤ 30.00
11ax-HE80	MCS0	177	6865	15.58	14.06	14.24	13.79	20.50	3.00	23.50	≤ 30.00
11ax-HE80	MCS0	193	6945	15.54	14.26	14.45	14.06	20.64	3.00	23.64	≤ 30.00
11ax-HE80	MCS0	209	7025	15.59	14.37	14.50	14.23	20.73	3.00	23.73	≤ 30.00
11ax-HE160	MCS0	33	6185	17.91	16.06	16.91	16.19	22.85	3.00	25.85	≤ 30.00
11ax-HE160	MCS0	65	6345	17.60	16.57	16.87	15.94	22.81	3.00	25.81	≤ 30.00
11ax-HE160	MCS0	97	6505	17.66	16.69	16.82	15.88	22.83	3.00	25.83	≤ 30.00
11ax-HE160	MCS0	129	6665	18.43	17.01	17.33	16.42	23.38	3.00	26.38	≤ 30.00
11ax-HE160	MCS0	161	6825	17.70	16.47	16.48	15.88	22.71	3.00	25.71	≤ 30.00
11ax-HE160	MCS0	193	6985	17.98	16.51	16.67	15.66	22.81	3.00	25.81	≤ 30.00

Note 1: Total Average Power (dBm) =  $10 \cdot \log \{10^{(\text{Ant 0 Average Power} / 10)} + 10^{(\text{Ant 1 Average Power} / 10)} + 10^{(\text{Ant 2 Average Power} / 10)} + 10^{(\text{Ant 3 Average Power} / 10)}\}$ .

Note 2: CDD EIRP Power (dBm) = Total Average Power (dBm) + CDD Directional Gain (dBi).

## 6.4. Power Spectral Density

### 6.4.1. Test Limit

For an indoor access point operating in the 5.925-7.125 GHz band, the maximum power spectral density must not exceed 5 dBm e.i.r.p. in any 1-megahertz band.

### 6.4.2. Test Procedure Used

KDB 789033 D02v02r01-Section II) F

### 6.4.3. Test Setting

1. Analyzer was set to the center frequency of the UNII channel under investigation
2. Span was set to encompass the entire 26dB EBW of the signal.
3. RBW = 1MHz
4. VBW = 3MHz
5. Number of sweep points  $\geq 2 \times (\text{span} / \text{RBW})$
6. Detector = power averaging (Average)
7. Sweep time = auto
8. Trigger = free run
9. Use the peak search function on the instrument to find the peak of the spectrum and record its value.
10. Add  $10 \cdot \log(1/x)$ , where x is the duty cycle, to the measured power in order to compute the average power during the actual transmission times (because the measurement represents an average over both the on and off times of the transmission). For example, add  $10 \cdot \log(1/0.25) = 6$  dB if the duty cycle is 25 percent.

### 6.4.4. Test Setup

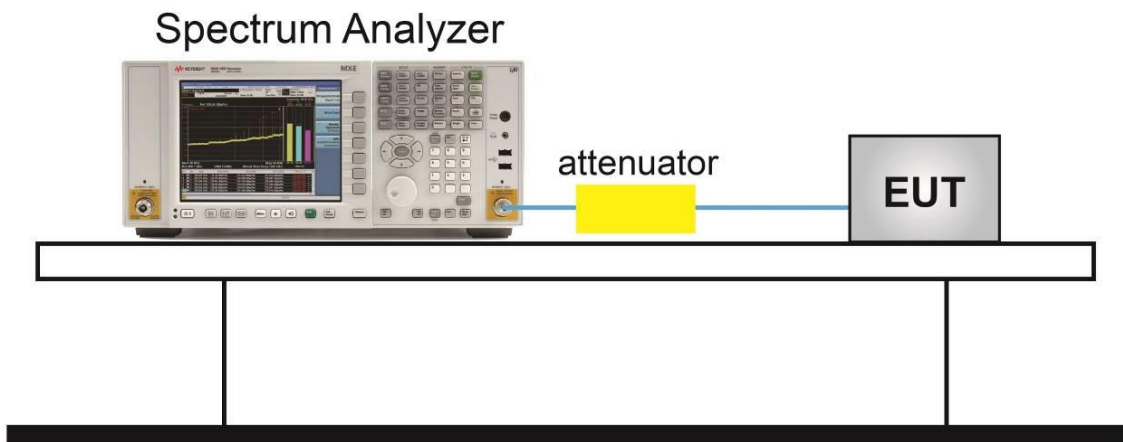

### 6.4.5. Test Result

Test Site	SR6	Test Engineer	Marvin
Test Date	2022/12/23		

Test Mode	Data Rate/MCS	Channel No.	Freq. (MHz)	PSD (dBm/MHz)				Total PSD (dBm/MHz)	Duty Cycle (%)	Directional Gain (dBi)	EIRP PSD (dBm/MHz)	EIRP PSD Limit (dBm/MHz)
				Ant 0	Ant 1	Ant 2	Ant 3					
CDD Mode (Nss = 1)												
11ax-HE20	MCS0	33	6115	-9.381	-11.060	-10.939	-10.857	-4.482	98.08%	9.02	4.62	≤ 5.00
11ax-HE20	MCS0	61	6255	-9.006	-10.580	-10.818	-10.786	-4.208	98.08%	9.02	4.90	≤ 5.00
11ax-HE20	MCS0	93	6415	-9.326	-11.696	-9.966	-10.672	-4.307	98.08%	9.02	4.80	≤ 5.00
11ax-HE20	MCS0	97	6435	-9.653	-11.676	-9.763	-10.621	-4.335	98.08%	9.02	4.77	≤ 5.00
11ax-HE20	MCS0	105	6475	-9.911	-12.020	-10.112	-10.447	-4.528	98.08%	9.02	4.58	≤ 5.00
11ax-HE20	MCS0	113	6515	-9.451	-11.544	-10.032	-10.752	-4.354	98.08%	9.02	4.75	≤ 5.00
11ax-HE20	MCS0	117	6535	-9.713	-11.642	-9.960	-10.697	-4.420	98.08%	9.02	4.69	≤ 5.00
11ax-HE20	MCS0	153	6715	-9.560	-10.808	-9.972	-12.202	-4.503	98.08%	9.02	4.60	≤ 5.00
11ax-HE20	MCS0	181	6855	-9.019	-11.749	-9.900	-10.809	-4.231	98.08%	9.02	4.87	≤ 5.00
11ax-HE20	MCS0	185	6875	-9.399	-12.170	-9.824	-10.933	-4.433	98.08%	9.02	4.67	≤ 5.00
11ax-HE20	MCS0	189	6895	-9.462	-12.278	-9.927	-10.856	-4.483	98.08%	9.02	4.62	≤ 5.00
11ax-HE20	MCS0	213	7015	-9.321	-12.153	-10.138	-10.444	-4.377	98.08%	9.02	4.73	≤ 5.00
11ax-HE20	MCS0	229	7095	-9.203	-12.166	-9.914	-10.712	-4.344	98.08%	9.02	4.76	≤ 5.00
11ax-HE40	MCS0	35	6125	-9.801	-10.932	-10.613	-10.904	-4.517	97.04%	9.02	4.63	≤ 5.00
11ax-HE40	MCS0	59	6245	-9.580	-10.521	-10.440	-10.693	-4.266	97.04%	9.02	4.89	≤ 5.00
11ax-HE40	MCS0	91	6405	-9.671	-10.567	-10.461	-10.450	-4.251	97.04%	9.02	4.90	≤ 5.00
11ax-HE40	MCS0	99	6445	-10.013	-10.531	-10.597	-10.414	-4.362	97.04%	9.02	4.79	≤ 5.00
11ax-HE40	MCS0	107	6485	-10.069	-11.221	-10.794	-10.579	-4.625	97.04%	9.02	4.53	≤ 5.00
11ax-HE40	MCS0	115	6525	-9.515	-11.010	-10.263	-10.446	-4.255	97.04%	9.02	4.90	≤ 5.00
11ax-HE40	MCS0	123	6565	-9.895	-11.167	-10.689	-10.765	-4.583	97.04%	9.02	4.57	≤ 5.00
11ax-HE40	MCS0	147	6685	-9.797	-10.758	-10.730	-11.049	-4.537	97.04%	9.02	4.61	≤ 5.00
11ax-HE40	MCS0	179	6845	-9.348	-10.753	-10.724	-10.672	-4.311	97.04%	9.02	4.84	≤ 5.00
11ax-HE40	MCS0	187	6885	-9.890	-11.062	-10.606	-10.627	-4.505	97.04%	9.02	4.65	≤ 5.00
11ax-HE40	MCS0	195	6925	-9.890	-10.798	-10.611	-10.570	-4.433	97.04%	9.02	4.72	≤ 5.00
11ax-HE40	MCS0	211	7005	-9.801	-10.766	-10.711	-10.406	-4.383	97.04%	9.02	4.77	≤ 5.00
11ax-HE40	MCS0	227	7085	-9.700	-10.582	-10.658	-10.503	-4.323	97.04%	9.02	4.83	≤ 5.00

Test Mode	Data Rate/MCS	Channel No.	Freq. (MHz)	PSD (dBm/MHz)				Total PSD (dBm/MHz)	Duty Cycle (%)	Directional Gain (dBi)	EIRP PSD (dBm/MHz)	EIRP PSD Limit (dBm/MHz)
				Ant 0	Ant 1	Ant 2	Ant 3					
CDD Mode (Nss = 1) and Beamforming Mode												
11ax-HE80	MCS0	39	6145	-9.907	-11.023	-10.619	-10.947	-4.580	93.88%	9.02	4.71	≤ 5.00
11ax-HE80	MCS0	55	6225	-9.855	-10.933	-10.587	-11.290	-4.613	93.88%	9.02	4.68	≤ 5.00
11ax-HE80	MCS0	87	6385	-10.152	-10.634	-10.396	-10.723	-4.450	93.88%	9.02	4.84	≤ 5.00
11ax-HE80	MCS0	103	6465	-10.164	-10.965	-10.538	-11.004	-4.633	93.88%	9.02	4.66	≤ 5.00
11ax-HE80	MCS0	119	6545	-10.079	-11.205	-10.568	-10.961	-4.662	93.88%	9.02	4.63	≤ 5.00
11ax-HE80	MCS0	135	6625	-9.998	-10.958	-11.033	-11.171	-4.744	93.88%	9.02	4.55	≤ 5.00
11ax-HE80	MCS0	151	6705	-9.740	-10.743	-10.550	-10.963	-4.453	93.88%	9.02	4.84	≤ 5.00
11ax-HE80	MCS0	183	6865	-9.862	-10.706	-10.478	-10.834	-4.433	93.88%	9.02	4.86	≤ 5.00
11ax-HE80	MCS0	199	6945	-9.719	-11.073	-10.618	-10.827	-4.508	93.88%	9.02	4.79	≤ 5.00
11ax-HE80	MCS0	215	7025	-9.843	-10.631	-10.686	-10.643	-4.415	93.88%	9.02	4.88	≤ 5.00
11ax-HE160	MCS0	47	6185	-10.073	-11.110	-10.533	-11.050	-4.650	90.33%	9.02	4.81	≤ 5.00
11ax-HE160	MCS0	79	6345	-10.089	-10.805	-10.598	-11.078	-4.607	90.33%	9.02	4.86	≤ 5.00
11ax-HE160	MCS0	111	6505	-9.868	-11.397	-10.657	-11.012	-4.676	90.33%	9.02	4.79	≤ 5.00
11ax-HE160	MCS0	143	6665	-10.018	-10.882	-10.479	-11.076	-4.574	90.33%	9.02	4.89	≤ 5.00
11ax-HE160	MCS0	175	6825	-10.519	-11.238	-10.274	-10.992	-4.719	90.33%	9.02	4.74	≤ 5.00
11ax-HE160	MCS0	207	6985	-10.105	-11.119	-10.654	-10.941	-4.667	90.33%	9.02	4.80	≤ 5.00

Note 1: Total PSD (dBm/MHz) =  $10 \cdot \log \{10^{(\text{Ant 0 PSD}/10)} + 10^{(\text{Ant 1 PSD}/10)} + 10^{(\text{Ant 2 PSD}/10)} + 10^{(\text{Ant 3 PSD}/10)}\}$

Note 2: When EUT duty cycle ≥ 98%, EIRP PSD (dBm/MHz) = Total PSD (dBm/MHz) + Directional Gain (dBi).

When EUT duty cycle < 98%, EIRP PSD (dBm/MHz) = Total PSD (dBm/MHz) +  $10 \cdot \log (1/\text{Duty Cycle})$  + Directional Gain (dBi).



Test Site	SR6	Test Engineer	Marvin
Test Date	2023/2/1		

Test Mode	Data Rate/MCS	Channel No.	Freq. (MHz)	PSD (dBm/MHz)				Total PSD (dBm/MHz)	Duty Cycle (%)	Directional Gain (dBi)	EIRP PSD (dBm/MHz)	EIRP PSD Limit (dBm/MHz)
				Ant 0	Ant 1	Ant 2	Ant 3					
CDD Mode (Nss = 4)												
11ax-HE20	MCS0	33	6115	-3.150	-5.954	-4.095	-5.142	1.564	98.08%	3.00	4.65	≤ 5.00
11ax-HE20	MCS0	61	6255	-3.380	-4.530	-4.104	-5.050	1.798	98.08%	3.00	4.88	≤ 5.00
11ax-HE20	MCS0	93	6415	-3.515	-4.714	-3.893	-5.034	1.774	98.08%	3.00	4.86	≤ 5.00
11ax-HE20	MCS0	97	6435	-3.813	-5.013	-4.068	-4.956	1.590	98.08%	3.00	4.67	≤ 5.00
11ax-HE20	MCS0	105	6475	-3.374	-4.709	-3.873	-5.071	1.816	98.08%	3.00	4.90	≤ 5.00
11ax-HE20	MCS0	113	6515	-3.777	-4.872	-4.269	-4.604	1.660	98.08%	3.00	4.74	≤ 5.00
11ax-HE20	MCS0	117	6535	-3.491	-4.525	-4.084	-5.045	1.772	98.08%	3.00	4.86	≤ 5.00
11ax-HE20	MCS0	153	6715	-3.330	-4.399	-4.299	-4.981	1.810	98.08%	3.00	4.89	≤ 5.00
11ax-HE20	MCS0	181	6855	-3.424	-4.326	-4.434	-5.000	1.762	98.08%	3.00	4.85	≤ 5.00
11ax-HE20	MCS0	185	6875	-3.240	-4.570	-4.481	-4.758	1.802	98.08%	3.00	4.89	≤ 5.00
11ax-HE20	MCS0	189	6895	-3.218	-4.702	-4.590	-4.738	1.757	98.08%	3.00	4.84	≤ 5.00
11ax-HE20	MCS0	213	7015	-3.140	-4.731	-4.539	-4.762	1.782	98.08%	3.00	4.87	≤ 5.00
11ax-HE20	MCS0	229	7095	-3.513	-4.925	-4.763	-4.904	1.536	98.08%	3.00	4.62	≤ 5.00
11ax-HE40	MCS0	35	6125	-3.687	-5.170	-4.526	-4.944	1.477	97.04%	3.00	4.61	≤ 5.00
11ax-HE40	MCS0	59	6245	-3.542	-4.623	-4.814	-5.303	1.499	97.04%	3.00	4.63	≤ 5.00
11ax-HE40	MCS0	91	6405	-3.415	-4.636	-4.302	-4.911	1.742	97.04%	3.00	4.87	≤ 5.00
11ax-HE40	MCS0	99	6445	-3.820	-4.620	-4.291	-5.162	1.575	97.04%	3.00	4.71	≤ 5.00
11ax-HE40	MCS0	107	6485	-3.566	-4.585	-4.526	-5.040	1.625	97.04%	3.00	4.76	≤ 5.00
11ax-HE40	MCS0	115	6525	-3.689	-5.018	-4.583	-5.226	1.433	97.04%	3.00	4.56	≤ 5.00
11ax-HE40	MCS0	123	6565	-3.465	-4.673	-4.660	-5.270	1.555	97.04%	3.00	4.69	≤ 5.00
11ax-HE40	MCS0	147	6685	-3.262	-5.034	-4.744	-4.878	1.603	97.04%	3.00	4.73	≤ 5.00
11ax-HE40	MCS0	179	6845	-3.325	-4.838	-4.444	-5.151	1.638	97.04%	3.00	4.77	≤ 5.00
11ax-HE40	MCS0	187	6885	-3.318	-4.838	-4.449	-4.881	1.697	97.04%	3.00	4.83	≤ 5.00
11ax-HE40	MCS0	195	6925	-3.249	-5.016	-4.803	-5.024	1.565	97.04%	3.00	4.70	≤ 5.00
11ax-HE40	MCS0	211	7005	-3.321	-5.017	-5.237	-5.090	1.429	97.04%	3.00	4.56	≤ 5.00
11ax-HE40	MCS0	227	7085	-3.360	-4.674	-4.974	-4.934	1.588	97.04%	3.00	4.72	≤ 5.00

Test Mode	Data Rate/MCS	Channel No.	Freq. (MHz)	PSD (dBm/MHz)				Total PSD (dBm/MHz)	Duty Cycle (%)	Directional Gain (dBi)	EIRP PSD (dBm/MHz)	EIRP PSD Limit (dBm/MHz)
				Ant 0	Ant 1	Ant 2	Ant 3					
CDD Mode (Nss = 4)												
11ax-HE80	MCS0	39	6145	-3.666	-5.216	-4.665	-5.335	1.352	93.88%	3.00	4.63	≤ 5.00
11ax-HE80	MCS0	55	6225	-3.371	-4.958	-4.569	-5.270	1.541	93.88%	3.00	4.81	≤ 5.00
11ax-HE80	MCS0	87	6385	-3.751	-4.819	-4.224	-5.321	1.532	93.88%	3.00	4.81	≤ 5.00
11ax-HE80	MCS0	103	6465	-3.720	-4.996	-4.849	-5.627	1.278	93.88%	3.00	4.55	≤ 5.00
11ax-HE80	MCS0	119	6545	-3.736	-5.105	-4.516	-5.653	1.327	93.88%	3.00	4.60	≤ 5.00
11ax-HE80	MCS0	135	6625	-3.360	-5.033	-4.708	-5.884	1.372	93.88%	3.00	4.65	≤ 5.00
11ax-HE80	MCS0	151	6705	-3.576	-4.882	-4.705	-5.770	1.358	93.88%	3.00	4.63	≤ 5.00
11ax-HE80	MCS0	183	6865	-3.596	-5.057	-4.962	-5.229	1.361	93.88%	3.00	4.64	≤ 5.00
11ax-HE80	MCS0	199	6945	-3.437	-4.783	-4.910	-5.025	1.532	93.88%	3.00	4.81	≤ 5.00
11ax-HE80	MCS0	215	7025	-4.045	-5.224	-5.082	-4.869	1.240	93.88%	3.00	4.51	≤ 5.00
11ax-HE160	MCS0	47	6185	-4.067	-4.901	-4.731	-5.877	1.174	90.33%	3.00	4.62	≤ 5.00
11ax-HE160	MCS0	79	6345	-4.017	-4.760	-4.762	-5.851	1.221	90.33%	3.00	4.66	≤ 5.00
11ax-HE160	MCS0	111	6505	-3.829	-4.804	-4.401	-5.490	1.431	90.33%	3.00	4.87	≤ 5.00
11ax-HE160	MCS0	143	6665	-3.292	-4.749	-4.867	-5.803	1.438	90.33%	3.00	4.88	≤ 5.00
11ax-HE160	MCS0	175	6825	-3.727	-5.279	-4.749	-5.249	1.317	90.33%	3.00	4.76	≤ 5.00
11ax-HE160	MCS0	207	6985	-3.799	-5.525	-5.391	-5.354	1.064	90.33%	3.00	4.51	≤ 5.00

Note 1: Total PSD (dBm/MHz) =  $10 \cdot \log \{10^{(\text{Ant 0 PSD}/10)} + 10^{(\text{Ant 1 PSD}/10)} + 10^{(\text{Ant 2 PSD}/10)} + 10^{(\text{Ant 3 PSD}/10)}\}$

Note 2: When EUT duty cycle ≥ 98%, EIRP PSD (dBm/MHz) = Total PSD (dBm/MHz) + Directional Gain (dBi).

When EUT duty cycle < 98%, EIRP PSD (dBm/MHz) = Total PSD (dBm/MHz) +  $10 \cdot \log (1/\text{Duty Cycle})$  + Directional Gain (dBi).

## 802.11ax-HE20 Power Spectral Density – Ant 0 (Nss=1)

Channel 33 (6115MHz)

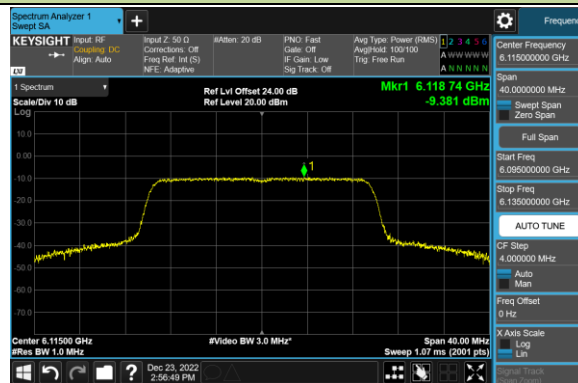

Channel 61 (6255MHz)

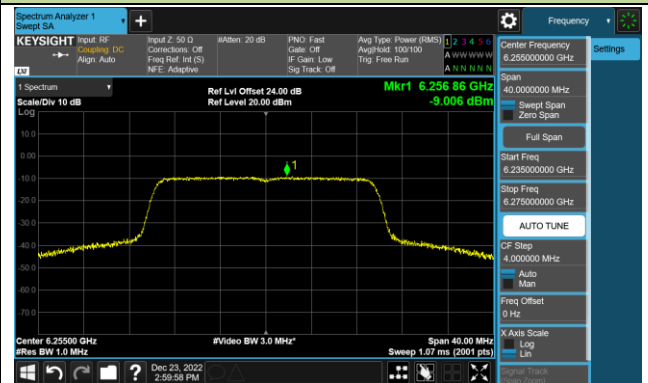

Channel 93 (6415MHz)

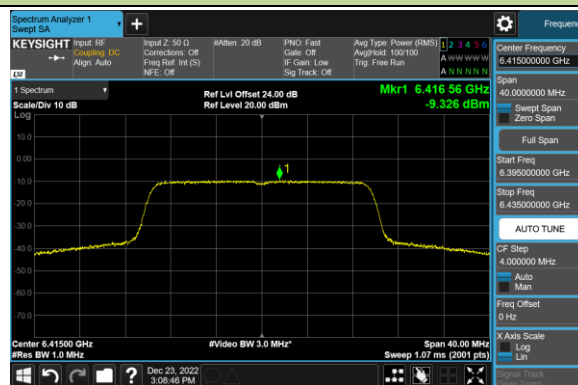

Channel 97 (6435MHz)

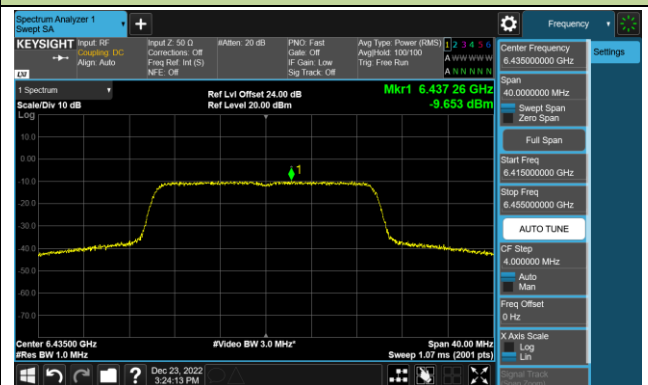

Channel 105 (6475MHz)

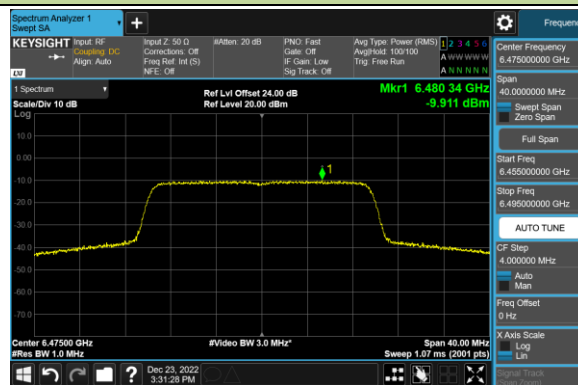

Channel 113 (6515MHz)

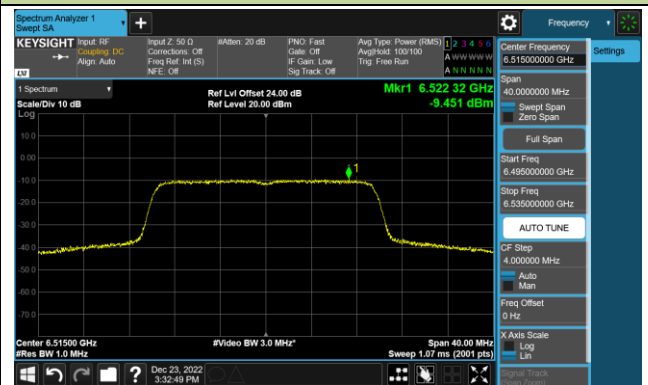

Channel 117 (6535MHz)

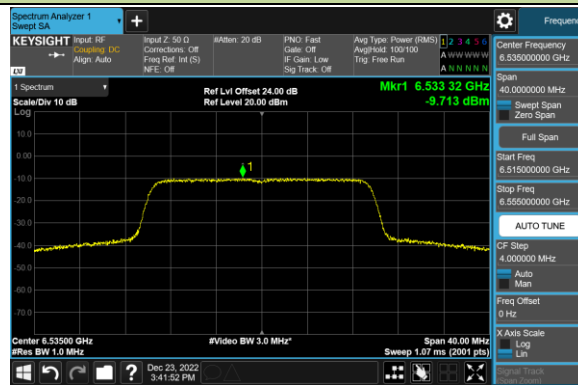

Channel 153 (6715MHz)

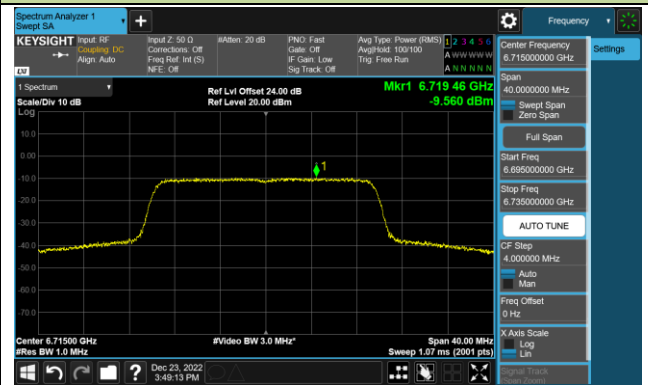

802.11ax-HE20 Power Spectral Density – Ant 0 (Nss=1)

Channel 181 (6855MHz)

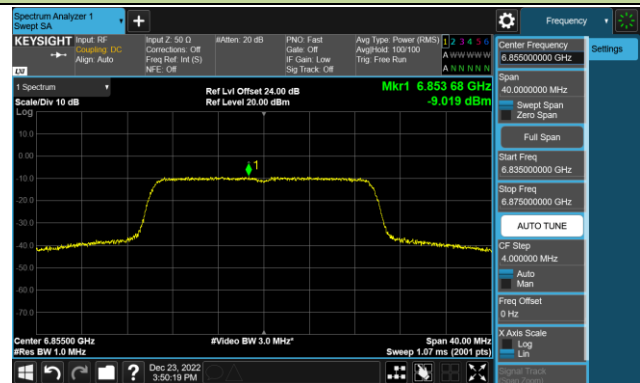

Channel 185 (6875MHz)

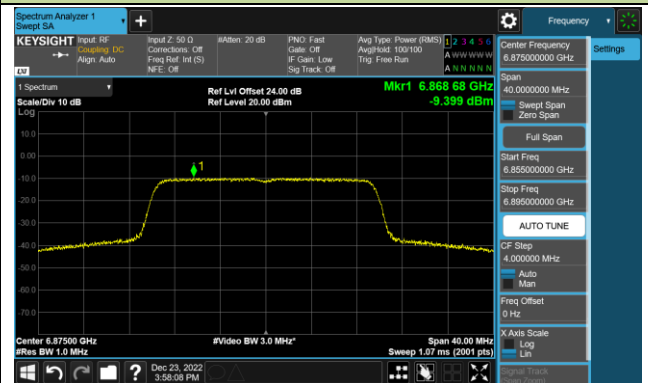

Channel 189 (6895MHz)

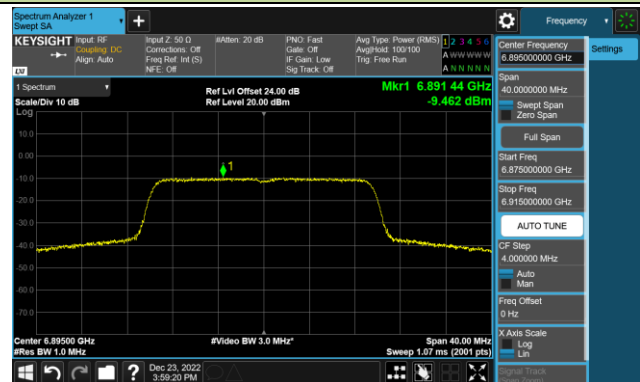

Channel 213 (7015MHz)

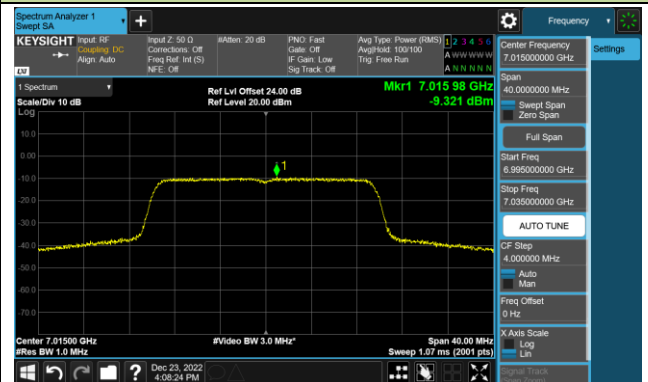

Channel 229 (7095MHz)

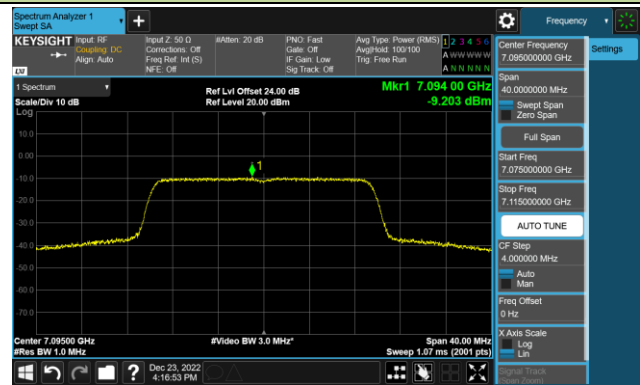

802.11ax-HE40 Power Spectral Density – Ant 0 (Nss=1)

Channel 35 (6125MHz)

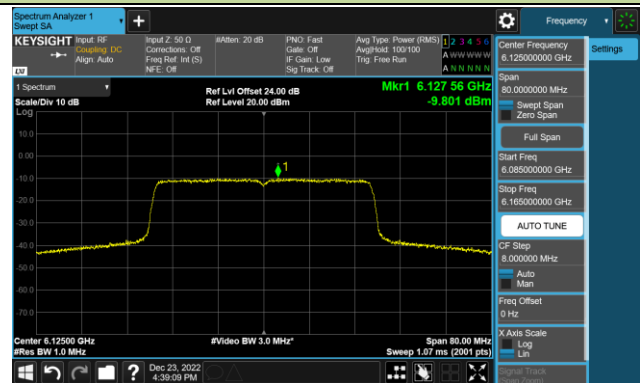

Channel 59 (6245MHz)

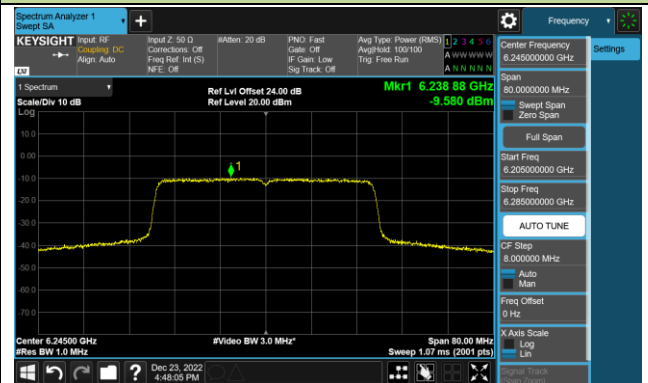

Channel 91 (6405MHz)

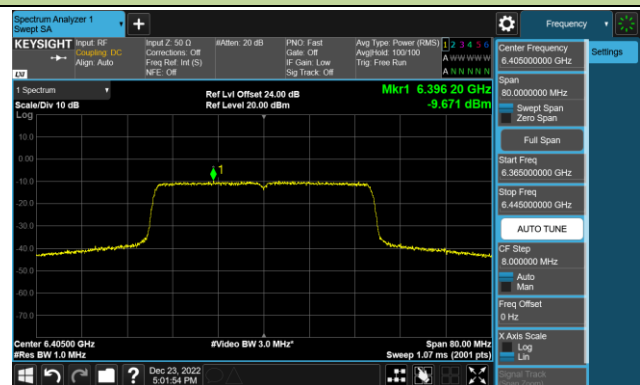

Channel 99 (6445MHz)

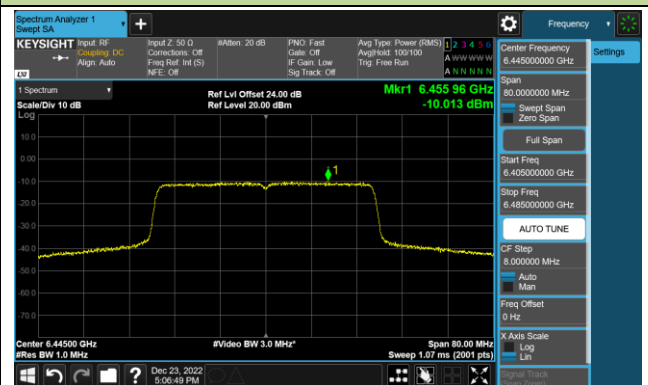

Channel 107 (6485MHz)

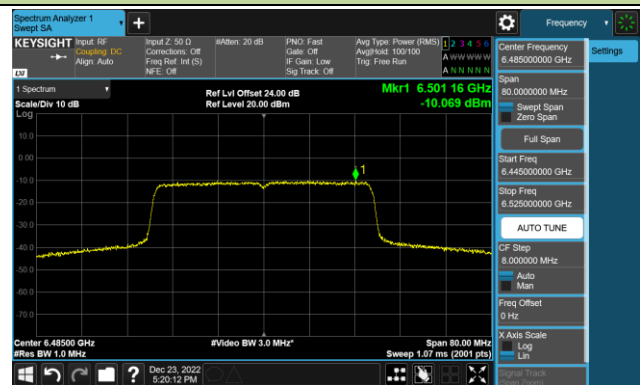

Channel 115 (6525MHz)

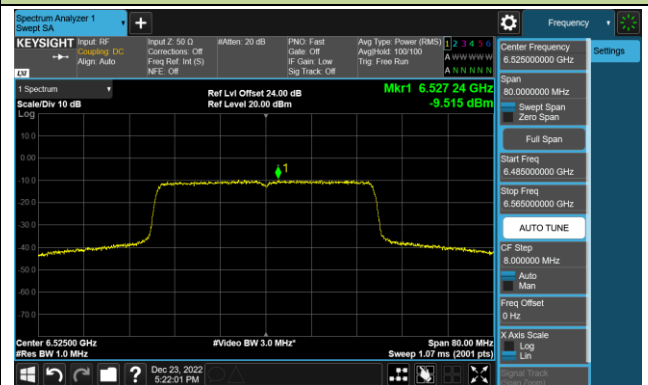

Channel 123 (6565MHz)

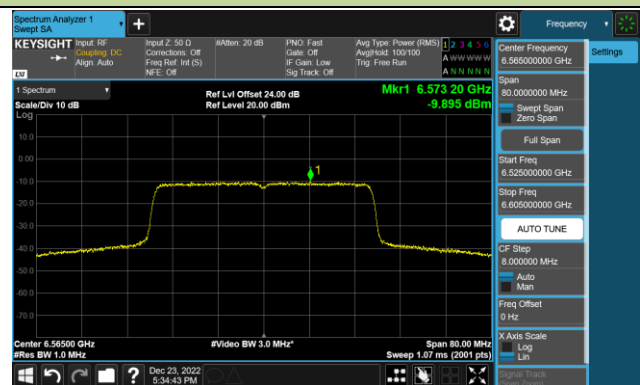

Channel 147 (6685MHz)

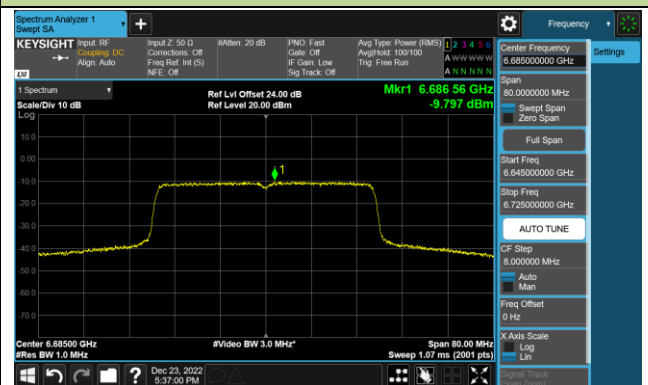

802.11ax-HE40 Power Spectral Density – Ant 0 (Nss=1)

Channel 179 (6845MHz)

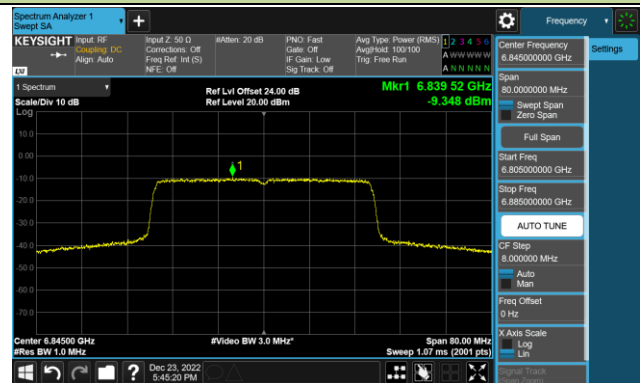

Channel 187 (6885MHz)

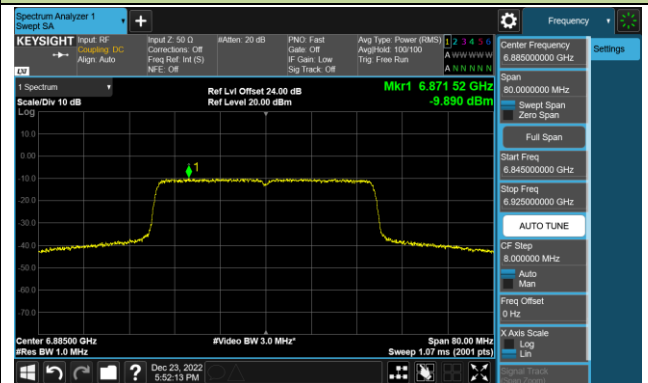

Channel 195 (6925MHz)

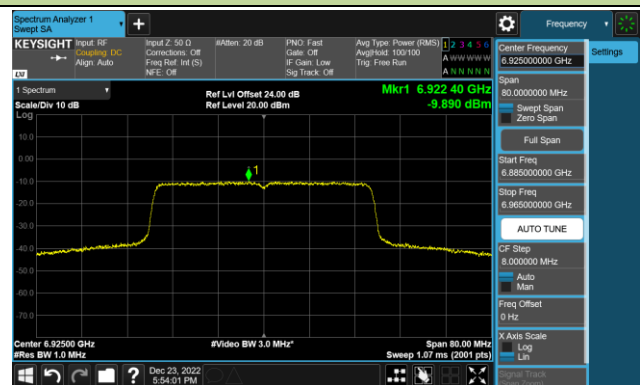

Channel 211 (7005MHz)

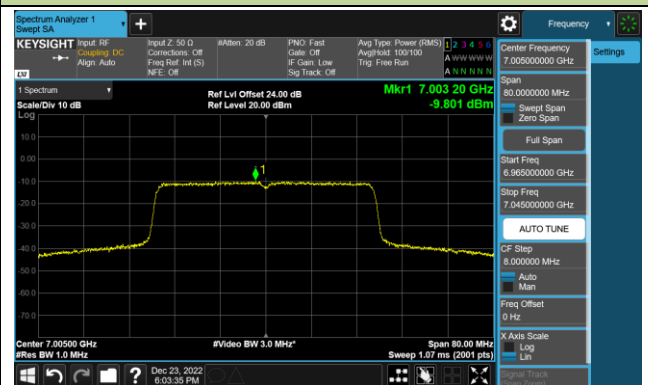

Channel 227 (7085MHz)

