

**CFR 47 FCC PART 15 SUBPART C  
ISED RSS-247 ISSUE 3**

**TEST REPORT**

*For*

**BE22000 Ceiling Mount Wi-Fi 7 Access Point**

**MODEL NUMBER: AP9778**

**REPORT NUMBER: 4790887256-1-RF-2**

**ISSUE DATE: July 27, 2023**

**FCC ID:2AXJ4AP9778  
IC:26583-AP9778**

*Prepared for*

**TP-Link Corporation Limited  
Room 901, 9/F. , New East Ocean Centre, 9 Science Museum Road, Tsim Sha Tsui,  
Kowloon, Hong Kong**

*Prepared by*

**UL Verification Services (Guangzhou) Co., Ltd, Song Shan Lake Branch**

**Building 10, Innovation Technology Park, No. 1, Li Bin Road, Song Shan Lake Hi-Tech Development Zone Dongguan, 523808, People's Republic of China**

**Tel: +86 769 22038881**

**Fax: +86 769 33244054**

**Website: [www.ul.com](http://www.ul.com)**

## Revision History

Rev.	Issue Date	Revisions	Revised By
V0	July 27, 2023	Initial Issue	

### Summary of Test Results

Test Item	Clause	Limit/Requirement	Result
Antenna Requirement	N/A	FCC Part 15.203/15.247 (c) RSS-GEN Clause 6.8	Pass
AC Power Line Conducted Emission	ANSI C63.10-2013, Clause 6.2	FCC Part 15.207 RSS-GEN Clause 8.8	Pass
Conducted Output Power	ANSI C63.10-2013, Clause 11.9.1.3	FCC Part 15.247 (b)(3) RSS-247 Clause 5.4 (d)	Pass
6dB Bandwidth and 99% Occupied Bandwidth	ANSI C63.10-2013, Clause 11.8.1	FCC Part 15.247 (a)(2) RSS-247 Clause 5.2 (a) ISED RSS-Gen Clause 6.7	Pass
Power Spectral Density	ANSI C63.10-2013, Clause 11.10.2	FCC Part 15.247 (e) RSS-247 Clause 5.2 (b)	Pass
Conducted Band edge and spurious emission	ANSI C63.10-2013, Clause 11.11	FCC Part 15.247(d) RSS-247 Clause 5.5	Pass
Radiated Band edge and Spurious Emission	ANSI C63.10-2013, Clause 11.12 & Clause 11.13	FCC Part 15.247 (d) FCC Part 15.205/15.209 RSS-247 Clause 5.5 RSS-GEN Clause 8.9	Pass
Duty Cycle	ANSI C63.10-2013, Clause 11.6	None; for reporting purposes only.	Pass

\*This test report is only published to and used by the applicant, and it is not for evidence purpose in China.

\*The measurement result for the sample received is <Pass> according to <CFR 47 FCC PART 15 SUBPART C><ISED RSS-247 ISSUE 3> when <Accuracy Method> decision rule is applied.

## CONTENTS

<b>1. ATTESTATION OF TEST RESULTS.....</b>	<b>6</b>
<b>2. TEST METHODOLOGY.....</b>	<b>7</b>
<b>3. FACILITIES AND ACCREDITATION.....</b>	<b>7</b>
<b>4. CALIBRATION AND UNCERTAINTY .....</b>	<b>8</b>
4.1. <i>MEASURING INSTRUMENT CALIBRATION .....</i>	<i>8</i>
4.2. <i>MEASUREMENT UNCERTAINTY.....</i>	<i>8</i>
<b>5. EQUIPMENT UNDER TEST .....</b>	<b>9</b>
5.1. <i>DESCRIPTION OF EUT .....</i>	<i>9</i>
5.2. <i>CHANNEL LIST .....</i>	<i>9</i>
5.3. <i>MAXIMUM EIRP .....</i>	<i>10</i>
5.4. <i>TEST CHANNEL CONFIGURATION.....</i>	<i>10</i>
5.5. <i>THE WORSE CASE POWER SETTING PARAMETER.....</i>	<i>11</i>
5.6. <i>WORST-CASE CONFIGURATIONS.....</i>	<i>12</i>
5.7. <i>DESCRIPTION OF AVAILABLE ANTENNAS .....</i>	<i>13</i>
5.8. <i>SUPPORT UNITS FOR SYSTEM TEST .....</i>	<i>14</i>
<b>6. MEASURING EQUIPMENT AND SOFTWARE USED.....</b>	<b>15</b>
<b>7. ANTENNA PORT TEST RESULTS .....</b>	<b>18</b>
7.1. <i>CONDUCTED OUTPUT POWER .....</i>	<i>18</i>
7.2. <i>6DB BANDWIDTH AND 99% OCCUPIED BANDWIDTH.....</i>	<i>19</i>
7.3. <i>POWER SPECTRAL DENSITY .....</i>	<i>21</i>
7.4. <i>CONDUCTED BAND EDGE AND SPURIOUS EMISSION.....</i>	<i>23</i>
7.5. <i>DUTY CYCLE .....</i>	<i>25</i>
<b>8. RADIATED TEST RESULTS.....</b>	<b>26</b>
8.1. <i>RESTRICTED BANDEDGE .....</i>	<i>34</i>
8.2. <i>SPURIOUS EMISSIONS(1 GHZ~3 GHZ) .....</i>	<i>65</i>
8.3. <i>SPURIOUS EMISSIONS(3 GHZ~18 GHZ) .....</i>	<i>71</i>
8.4. <i>SPURIOUS EMISSIONS(9 KHZ~30 MHZ) .....</i>	<i>105</i>
8.5. <i>SPURIOUS EMISSIONS(18 GHZ~26 GHZ) .....</i>	<i>108</i>
8.6. <i>SPURIOUS EMISSIONS(30 MHZ~1 GHZ).....</i>	<i>110</i>
<b>9. ANTENNA REQUIREMENT .....</b>	<b>112</b>
<b>10. AC POWER LINE CONDUCTED EMISSION .....</b>	<b>113</b>

<b>11.</b>	<b>TEST DATA.....</b>	<b>117</b>
11.1.	<i>APPENDIX A: DTS BANDWIDTH.....</i>	<i>117</i>
11.1.1.	Test Result.....	117
11.1.2.	Test Graphs .....	119
11.2.	<i>APPENDIX B: OCCUPIED CHANNEL BANDWIDTH.....</i>	<i>146</i>
11.2.1.	Test Result.....	146
11.2.2.	Test Graphs .....	148
11.3.	<i>APPENDIX C: MAXIMUM CONDUCTED OUTPUT POWER.....</i>	<i>175</i>
11.3.1.	Test Result.....	175
11.4.	<i>APPENDIX D: MAXIMUM POWER SPECTRAL DENSITY.....</i>	<i>177</i>
11.4.1.	Test Result.....	177
11.4.2.	Test Graphs .....	179
11.5.	<i>APPENDIX E: BAND EDGE MEASUREMENTS.....</i>	<i>206</i>
11.5.1.	Test Result.....	206
11.5.2.	Test Graphs .....	207
11.6.	<i>APPENDIX F: CONDUCTED SPURIOUS EMISSION .....</i>	<i>213</i>
11.6.1.	Test Result.....	213
11.6.2.	Test Graphs .....	215
11.7.	<i>APPENDIX G: DUTY CYCLE.....</i>	<i>235</i>
11.7.1.	Test Result.....	235
11.7.2.	Test Graphs .....	236

## 1. ATTESTATION OF TEST RESULTS

### Applicant Information

Company Name: TP-Link Corporation Limited  
Address: Room 901, 9/F. , New East Ocean Centre, 9 Science Museum Road, Tsim Sha Tsui, Kowloon, Hong Kong

### Manufacturer Information

Company Name: TP-Link Corporation Limited  
Address: Room 901, 9/F. , New East Ocean Centre, 9 Science Museum Road, Tsim Sha Tsui, Kowloon, Hong Kong

### EUT Information

EUT Name: BE22000 Ceiling Mount Wi-Fi 7 Access Point  
Model: AP9778  
Brand: tp-link  
Sample Received Date: June 8, 2023  
Sample Status: Normal  
Sample ID: 6163500  
Date of Tested: July 4, 2023 to July 27, 2023

APPLICABLE STANDARDS	
STANDARD	TEST RESULTS
CFR 47 FCC PART 15 SUBPART C ISED RSS-247 ISSUE 3	Pass

Prepared By:



Fanny Huang  
Engineer Project Associate

Checked By:

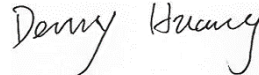

Denny Huang  
Senior Project Engineer

Approved By:



Stephen Guo  
Operations Manager

## 2. TEST METHODOLOGY

All tests were performed in accordance with the standard CFR 47 FCC PART 15 SUBPART C ISED RSS-247 ISSUE 3, KDB 558074 D01 15.247 Meas Guidance v05r02, KDB 414788 D01 Radiated Test Site v01r01, KDB 662911 D01 Multiple Transmitter Output v02r01, CFR 47 FCC Part 2, ANSI C63.10-2013 and ISED RSS-GEN Issue 5 and and KDB 662911 D02 MIMO with Cross-Polarized Antennas v01.

## 3. FACILITIES AND ACCREDITATION

Accreditation Certificate	<p><b>A2LA (Certificate No.: 4102.01)</b>                  UL Verification Services (Guangzhou) Co., Ltd. Song Shan Lake Branch. has been assessed and proved to be in compliance with A2LA.</p> <p><b>FCC (FCC Designation No.: CN1187)</b>                  UL Verification Services (Guangzhou) Co., Ltd. Song Shan Lake Branch. Has been recognized to perform compliance testing on equipment subject to the Commission's Declaration of Conformity (DoC) and Certification rules</p> <p><b>ISED (Company No.: 21320)</b>                  UL Verification Services (Guangzhou) Co., Ltd. Song Shan Lake Branch. has been registered and fully described in a report filed with ISED. The Company Number is 21320 and the test lab Conformity Assessment Body Identifier (CABID) is CN0046.</p> <p><b>VCCI (Registration No.: G-20019, R-20004, C-20012 and T-20011)</b>                  UL Verification Services (Guangzhou) Co., Ltd. Song Shan Lake Branch. has been assessed and proved to be in compliance with VCCI, the Membership No. is 3793.                  Facility Name:                  Chamber D, the VCCI registration No. is G-20019 and R-20004                  Shielding Room B , the VCCI registration No. is C-20012 and T-20011</p>
---------------------------	--

**Note 1:**

All tests measurement facilities use to collect the measurement data are located at Building 10, Innovation Technology Park, No. 1, Li Bin Road, Song Shan Lake Hi-Tech Development Zone Dongguan, 523808, People's Republic of China.

**Note 2:**

The test anechoic chamber in UL Verification Services (Guangzhou) Co., Ltd. Song Shan Lake Branch had been calibrated and compared to the open field sites and the test anechoic chamber is shown to be equivalent to or worst case from the open field site.

**Note 3:**

For below 30 MHz, lab had performed measurements at test anechoic chamber and comparing to measurements obtained on an open field site. And these measurements below 30 MHz had been correlated to measurements performed on an OFS.

## 4. CALIBRATION AND UNCERTAINTY

### 4.1. MEASURING INSTRUMENT CALIBRATION

The measuring equipment utilized to perform the tests documented in this report has been calibrated in accordance with the manufacturer's recommendations and is traceable to recognized national standards.

### 4.2. MEASUREMENT UNCERTAINTY

Where relevant, the following measurement uncertainty levels have been estimated for tests performed on the apparatus:

Test Item	Uncertainty
Conduction emission	3.62 dB
Radiated Emission (Included Fundamental Emission) (9 kHz ~ 30 MHz)	2.2 dB
Radiated Emission (Included Fundamental Emission) (30 MHz ~ 1 GHz)	4.00 dB
Radiated Emission (Included Fundamental Emission) (1 GHz to 26 GHz)	5.78 dB (1 GHz ~ 18 GHz)
	5.23 dB (18 GHz ~ 26 GHz)
Duty Cycle	±0.028%
DTS and 99% Occupied Bandwidth	±0.0196%
Maximum Conducted Output Power	±0.686 dB
Maximum Power Spectral Density Level	±0.743 dB
Conducted Band-edge Compliance	±1.328 dB
Conducted Unwanted Emissions In Non-restricted Frequency Bands	±0.746 dB (9 kHz ~ 1 GHz)
	±1.328dB (1 GHz ~ 26 GHz)
Note: This uncertainty represents an expanded uncertainty expressed at approximately the 95% confidence level using a coverage factor of k=2.	



## 5. EQUIPMENT UNDER TEST

### 5.1. DESCRIPTION OF EUT

EUT Name/PMN:	BE22000 Ceiling Mount Wi-Fi 7 Access Point
Model/HVIN1:	AP9778
FVIN:	V1.0

Frequency Range:	2412 MHz to 2462 MHz
Type of Modulation:	IEEE 802.11b: DSSS(CCK, DQPSK, DBPSK) IEEE 802.11g: OFDM(64-QAM, 16-QAM, QPSK, BPSK) IEEE 802.11n: OFDM(256-QAM, 64-QAM, 16-QAM, QPSK, BPSK) IEEE 802.11ax: OFDMA(1024-QAM, 256-QAM, 64-QAM, 16-QAM, QPSK, BPSK) IEEE 802.11be: OFDMA(4096-QAM,1024-QAM, 256-QAM, 64-QAM, 16-QAM, QPSK, BPSK)
Radio Technology:	IEEE802.11b/g/n HT20/n HT40/n VHT20/n VHT40/ ax HE20/ax HE40/be EHT20/be EHT40
Normal Test Voltage:	DC 12 V via adapter/ DC 12 V via POE adapter

### 5.2. CHANNEL LIST

Channel List for (20 MHz)							
Channel	Frequency (MHz)	Channel	Frequency (MHz)	Channel	Frequency (MHz)	Channel	Frequency (MHz)
1	2412	4	2427	7	2442	10	2457
2	2417	5	2432	8	2447	11	2462
3	2422	6	2437	9	2452	/	/

Channel List for (40 MHz)							
Channel	Frequency (MHz)	Channel	Frequency (MHz)	Channel	Frequency (MHz)	Channel	Frequency (MHz)
3	2422	5	2432	7	2442	9	2452
4	2427	6	2437	8	2447	/	/

### 5.3. MAXIMUM POWER

IEEE Std. 802.11	Frequency (MHz)	Channel Number	Maximum Conducted AVG Output Power (dBm)	Maximum EIRP Output Power (dBm)
b	2412 ~ 2462	1-11[11]	29.44	31.44
g	2412 ~ 2462	1-11[11]	29.38	31.38
be EHT20	2412 ~ 2462	1-11[11]	28.94	30.94
be EHT40	2422 ~ 2452	3-9[7]	27.26	29.26

### 5.4. TEST CHANNEL CONFIGURATION

IEEE Std. 802.11	Test Channel Number	Frequency
b	CH 1(Low Channel), CH 6(MID Channel), CH 11(High Channel)	2412 MHz, 2437 MHz, 2462 MHz
g	CH 1(Low Channel), CH 6(MID Channel), CH 11(High Channel)	2412 MHz, 2437 MHz, 2462 MHz
be EHT20	CH 1(Low Channel), CH 6(MID Channel), CH 11(High Channel)	2412 MHz, 2437 MHz, 2462 MHz
be EHT40	CH 3(Low Channel), CH 6(MID Channel), CH 9(High Channel)	2422 MHz, 2437 MHz, 2452 MHz

## 5.5. THE WORSE CASE POWER SETTING PARAMETER

The Worse Case Power Setting Parameter	
Test Software	QSPR

Mode	Frequency (MHz)	Soft set value ANT5&5&8&11
802.11b-CDD	2412	24
	2417	24
	2437	24
	2457	24
	2462	24
802.11g-CDD	2412	24
	2417	24
	2437	24
	2457	24
	2462	23.5
802.11be 20M	2412	23
	2417	23
	2437	24
	2457	23.5
	2462	22.5
802.11be 40M	2422	19.5
	2427	20.5
	2437	22
	2447	20.5
	2452	20

## 5.6. WORST-CASE CONFIGURATIONS

The EUT was tested in the following configuration(s):

Controlled in test mode using a software application on the EUT supplied by customer. The application was used to enable a continuous transmission and to select the mode, test channels, bandwidth, data rates as required.

Test channels referring to section 5.4.

Maximum power setting referring to section 5.5.

Worst-case data rates as provided by the client were:

802.11b CDD mode: 1 Mbps  
802.11g CDD mode: 6 Mbps  
802.11n HT20 CDD mode: MCS0  
802.11n HT40 CDD mode: MCS0  
802.11n VHT20 CDD mode: MCS0  
802.11n VHT40 CDD mode: MCS0  
802.11ax HE20 CDD mode: MCS0  
802.11ax HE40 CDD mode: MCS0  
802.11be EHT20 CDD mode: MCS0  
802.11be EHT40 CDD mode: MCS0

All modes support CDD mode.

All modes support TX beamforming mode except 802.11b/g.

The EUT support Cyclic Shift Diversity (CDD) and TX Beamforming. The conducted power of CDD mode is higher than TX Beamforming mode, so we only chose the worst-case mode CDD for final testing.

EHT20/ EHT40 covers HT20/HT40/VHT20/ HE20/ HE40 due to similar modulation.

The power setting for HT20/ HT40/ VHT20/ VHT40/ HE20/ HE40 is the same or lower than EHT20/EHT40.

The EUT has 12 antennas, ANT5, ANT5, ANT8, ANT11 support 2.4G band, ANT2, ANT6, ANT7, ANT12 support 5G band and ANT8, ANT11, ANT9, ANT10 support 6G band.

The measured additional path loss was included in any path loss calculations for all RF cable used during tested.

## 5.7. DESCRIPTION OF AVAILABLE ANTENNAS

Antenna	Frequency (MHz)	Antenna Type	MAX Antenna Gain (dBi)
2- vertical polarized	2412-2462	Dipole	2
5- vertical polarized	2412-2462	Dipole	2
8- horizontal polarized	2412-2462	Dipole	2
11- horizontal polarized	2412-2462	Dipole	2

The polarization of 2.4G band antennas was cross-polarized.

For Cross-polarized antennas with  $N_{ANT} = 2$ . In the case of a transmitter with only two outputs driving a pair of antennas that are cross-polarized (e.g., vertical and horizontal or left-circular and right-circular), directional gain is the gain of an individual antenna. If the two antennas have different gains, the larger gain applies.

For output power measurements:

Directional gain =  $G_{ANT} + \text{Array Gain} = 2 \text{ dBi}$

$G_{ANT}$  : equal to the gain of the antenna having the highest gain

Array Gain = 0 dB (i.e., no array gain) for  $N_{ANT} \leq 4$

For power spectral density (PSD) measurements:

Directional gain =  $G_{ANT} + \text{Array Gain} = 5.01 \text{ dBi}$

Array Gain =  $10 \log(N_{ANT}/N_{SS}) \text{ dB}$ .

$N_{ANT}$  : number of transmit antennas

$N_{SS}$  : number of spatial streams, The worst case directional gain will occur when  $N_{SS} = 1$

For TX Beamforming:

Directional gain =  $G_{ANT} + 10 \log(N_{ANT}/N_{SS}) = 5.01 \text{ dBi}$

## 5.8. SUPPORT UNITS FOR SYSTEM TEST

### SUPPORT EQUIPMENT

Item	Equipment	Brand Name	Model Name	Remarks
1	Laptop	ThinkPad	X230i	/
2	I.T.E POWER SUPPLY	tp-link	TL-POE4824G	Input: AC 100-240 V, 50 / 60 Hz, 0.8 A Output: DC 48.0 V, 0.5 A, 24.0 W

### I/O CABLES

Cable No	Port	Connector Type	Cable Type	Cable Length(m)	Remarks
1	LAN1	RJ45	Unshielded	1.0 m	/

### ACCESSORIES

Item	Accessory	Brand Name	Model Name	Description
1	I.T.E POWER SUPPLY	tp-link	T120200-2B4	Input: AC 100-240 V, 50 / 60 Hz, 0.8 A Output: DC 12.0 V, 2.0 A

Note: We have pre-test the two I.T.E POWER SUPPLY, only the worst data on T120200-2B4 I.T.E POWER SUPPLY usage was recorded in the report.

### TEST SETUP

The EUT can work in engineering mode with a software through a laptop.

### SETUP DIAGRAM FOR TESTS

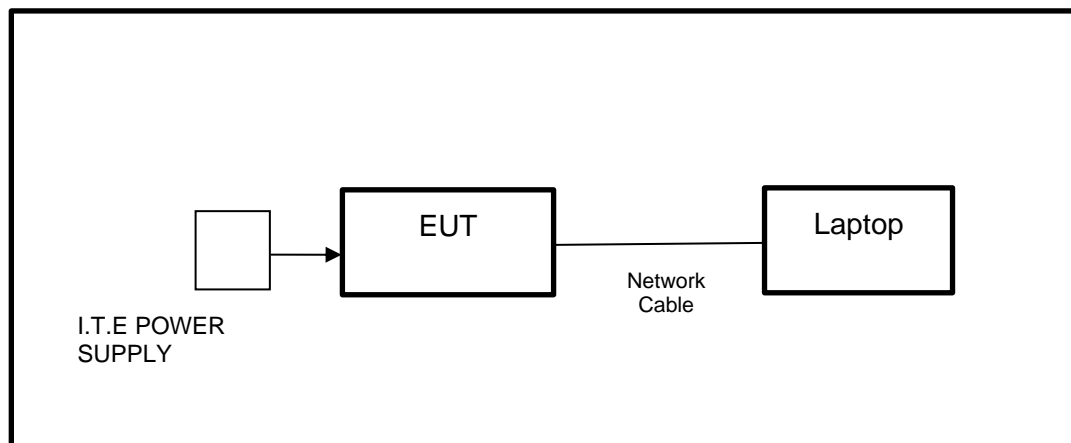

## 6. MEASURING EQUIPMENT AND SOFTWARE USED

R&S TS 8997 Test System					
Equipment	Manufacturer	Model No.	Serial No.	Last Cal.	Due. Date
Power sensor, Power Meter	R&S	OSP120	100921	Mar.31,2023	Mar.30,2024
Vector Signal Generator	R&S	SMBV100A	261637	Oct.17, 2022	Oct.16, 2023
Signal Generator	R&S	SMB100A	178553	Oct.17, 2022	Oct.16, 2023
Signal Analyzer	R&S	FSV40	101118	Oct.17, 2022	Oct.16, 2023
Software					
Description	Manufacturer	Name		Version	
For R&S TS 8997 Test System	Rohde & Schwarz	EMC 32		10.60.10	
Tonsend RF Test System					
Equipment	Manufacturer	Model No.	Serial No.	Last Cal.	Due. Date
Wideband Radio Communication Tester	R&S	CMW500	155523	Oct.17, 2022	Oct.16, 2023
Wireless Connectivity Tester	R&S	CMW270	1201.0002N75-102	Sep.28, 2022	Sep.27, 2023
PXA Signal Analyzer	Keysight	N9030A	MY55410512	Oct.17, 2022	Oct.16, 2023
MXG Vector Signal Generator	Keysight	N5182B	MY56200284	Oct.17, 2022	Oct.16, 2023
MXG Vector Signal Generator	Keysight	N5172B	MY56200301	Oct.17, 2022	Oct.16, 2023
DC power supply	Keysight	E3642A	MY55159130	Oct.17, 2022	Oct.16, 2023
Temperature & Humidity Chamber	SANMOOD	SG-80-CC-2	2088	Oct.17, 2022	Oct.16, 2023
Attenuator	Aglient	8495B	2814a12853	Oct.18, 2022	Oct.17, 2023
RF Control Unit	Tonscend	JS0806-2	23B80620666	April 18,2023	April 17,2024
Software					
Description	Manufacturer	Name		Version	
Tonsend SRD Test System	Tonsend	JS1120-3 RF Test System		V3.2.22	

Conducted Emissions					
Equipment	Manufacturer	Model No.	Serial No.	Last Cal.	Due Date
EMI Test Receiver	R&S	ESR3	101961	Oct.17, 2022	Oct.16, 2023
Two-Line V-Network	R&S	ENV216	101983	Oct.17, 2022	Oct.16, 2023
Artificial Mains Networks	Schwarzbeck	NSLK 8126	8126465	Oct.17, 2022	Oct.16, 2023
Software					
Description			Manufacturer	Name	Version
Test Software for Conducted Emissions			Farad	EZ-EMC	Ver. UL-3A1

Radiated Emissions					
Equipment	Manufacturer	Model No.	Serial No.	Last Cal.	Due Date
MXE EMI Receiver	KESIGHT	N9038A	MY56400036	Oct.17, 2022	Oct.16, 2023
Hybrid Log Periodic Antenna	TDK	HLP-3003C	130959	Aug.02, 2021	Aug.01, 2024
Preamplifier	HP	8447D	2944A09099	Oct.17, 2022	Oct.16, 2023
EMI Measurement Receiver	R&S	ESR26	101377	Oct.17, 2022	Oct.16, 2023
Horn Antenna	TDK	HRN-0118	130940	July 20, 2021	July 19, 2024
Preamplifier	TDK	PA-02-0118	TRS-305-00067	Oct.17, 2022	Oct.16, 2023
Horn Antenna	Schwarzbeck	BBHA9170	697	July 20, 2021	July 19, 2024
Preamplifier	TDK	PA-02-2	TRS-307-00003	Oct.17, 2022	Oct.16, 2023
Preamplifier	TDK	PA-02-3	TRS-308-00002	Oct.17, 2022	Oct.16, 2023
Loop antenna	Schwarzbeck	1519B	00008	Dec.14, 2021	Dec.13, 2024
Preamplifier	TDK	PA-02-001-3000	TRS-302-00050	Oct.17, 2022	Oct.16, 2023
Preamplifier	Mini-Circuits	ZX60-83LN-S+	SUP01202035	Oct.17, 2022	Oct.16, 2023
High Pass Filter	Wi	WHKX10-2700-3000-18000-40SS	23	Dec.01,2022	Nov.30,2023
Highpass Filter	Wainwright	WHKX10-5850-6500-1800-40SS	4	Dec.01,2022	Nov.30,2023
Band Reject Filter	Wainwright	WRCJV12-5695-5725-5850-5880-40SS	4	Dec.01,2022	Nov.30,2023



Band Reject Filter	Wainwright	WRCJV20-5120-5150-5350-5380-60SS	2	Dec.01,2022	Nov.30,2023
Band Reject Filter	Wainwright	WRCJV20-5440-5470-5725-5755-60SS	1	Dec.01,2022	Nov.30,2023
Band Reject Filter	Wainwright	WRCJV8-2350-2400-2483.5-2533.5-40SS	4	Dec.01,2022	Nov.30,2023
Band Reject Filter	Wainwright	WRCD5-1879-1879.85-1880.15-1881-40SS	1	Dec.01,2022	Nov.30,2023
Notch Filter	Wainwright	WHJ10-882-980-7000-40SS	1	Dec.01,2022	Nov.30,2023
<b>Software</b>					
Description			Manufacturer	Name	Version
Test Software for Radiated Emissions			Farad	EZ-EMC	Ver. UL-3A1

<b>Other Instrument</b>					
Equipment	Manufacturer	Model No.	Serial No.	Last Cal.	Due Date
Temperature humidity probe	OMEGA	ITHX-SD-5	18470007	Oct.22, 2022	Oct.21, 2023
Barometer	Yiyi	Baro	N/A	Oct.24, 2022	Oct.23, 2023
Attenuator	Agilent	8495B	2814a12853	Oct.18, 2022	Oct.17, 2023

## 7. ANTENNA PORT TEST RESULTS

### 7.1. CONDUCTED OUTPUT POWER

#### LIMITS

CFR 47 FCC Part15 (15.247) Subpart C ISED RSS-247 ISSUE 3			
Section	Test Item	Limit	Frequency Range (MHz)
CFR 47 FCC 15.247(b)(3) ISED RSS-247 5.4 (d)	AVG Output Power	1 watt or 30 dBm	2400-2483.5

#### TEST PROCEDURE

Refer to ANSI C63.10-2013 clause 11.9.2.3.1.

Connect the EUT to a low loss RF cable from the antenna port to the power sensor (video bandwidth is greater than the occupied bandwidth).

Measure peak emission level, the indicated level is the average output power, after any corrections for external attenuators and cables.

The test result in dBm by adding  $[10 \log (1 / D)]$ , where D is the duty cycle.

#### TEST SETUP

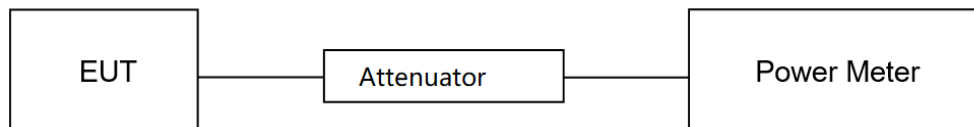

#### TEST ENVIRONMENT

Temperature	24.2°C	Relative Humidity	55%
Atmosphere Pressure	101kPa	Test Voltage	DC 12 V

#### TEST DATE / ENGINEER

Test Date	July 4, 2023	Test By	Fanny Huang
-----------	--------------	---------	-------------

#### TEST RESULTS

Please refer to section "Test Data" - Appendix C

## 7.2. 6DB BANDWIDTH AND 99% OCCUPIED BANDWIDTH

### LIMITS

CFR 47 FCC Part15 (15.247) Subpart C ISED RSS-247 ISSUE 3			
Section	Test Item	Limit	Frequency Range (MHz)
CFR 47 FCC 15.247(a)(2) ISED RSS-247 5.2 (a)	6 dB Bandwidth	≥ 500 kHz	2400-2483.5
ISED RSS-Gen Clause 6.7	99 % Occupied Bandwidth	For reporting purposes only.	2400-2483.5

### TEST PROCEDURE

Refer to ANSI C63.10-2013 clause 11.8 for DTS bandwidth and clause 6.9 for Occupied Bandwidth.

Connect the EUT to the spectrum analyser and use the following settings:

Center Frequency	The center frequency of the channel under test
Frequency Span	For 6 dB Bandwidth: Enough to capture all products of the modulation carrier emission For 99 % Occupied Bandwidth: Between 1.5 times and 5.0 times the OBW
Detector	Peak
RBW	For 6 dB Bandwidth: 100 kHz For 99 % Occupied Bandwidth: 1 % to 5 % of the occupied bandwidth
VBW	For 6 dB Bandwidth: ≥3 × RBW For 99 % Occupied Bandwidth: ≥3 × RBW
Trace	Max hold
Sweep	Auto couple

a) Use the 99 % power bandwidth function of the instrument, allow the trace to stabilize and report the measured bandwidth.

b) Allow the trace to stabilize and measure the maximum width of the emission that is constrained by the frequencies associated with the two outermost amplitude points (upper and lower frequencies) that are attenuated by 6 dB relative to the maximum level measured in the fundamental emission.

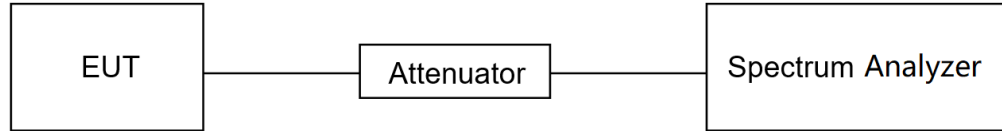
**TEST SETUP****TEST ENVIRONMENT**

Temperature	24.2°C	Relative Humidity	55%
Atmosphere Pressure	101kPa	Test Voltage	DC 12 V

**TEST DATE / ENGINEER**

Test Date	July 4, 2023	Test By	Fanny Huang
-----------	--------------	---------	-------------

**TEST RESULTS**

Please refer to section "Test Data" - Appendix A&B

### 7.3. POWER SPECTRAL DENSITY

#### LIMITS

CFR 47 FCC Part15 (15.247) Subpart C ISED RSS-247 ISSUE 3			
Section	Test Item	Limit	Frequency Range (MHz)
CFR 47 FCC §15.247 (e) ISED RSS-247 5.2 (b)	Power Spectral Density	8 dBm in any 3 kHz band	2400-2483.5

#### TEST PROCEDURE

Refer to ANSI C63.10-2013 clause 11.10.5.

Connect the EUT to the spectrum analyser and use the following settings:

Center Frequency	The center frequency of the channel under test
Detector	power averaging (rms)
RBW	$3 \text{ kHz} \leq \text{RBW} \leq 100 \text{ kHz}$
VBW	$\geq 3 \times \text{RBW}$
Span	1.5 x OBW bandwidth
Trace	Average
Sweep time	Auto couple

Allow trace to fully stabilize and use the peak marker function to determine the maximum amplitude level within the RBW.

If measured value exceeds limit, reduce RBW (no less than 3 kHz) and repeat.

#### TEST SETUP

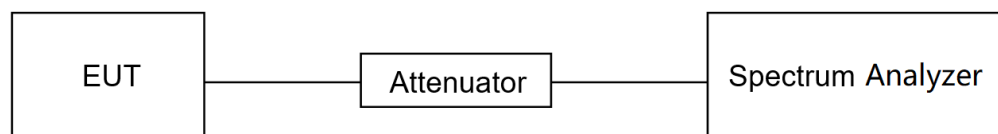

#### TEST ENVIRONMENT

Temperature	24.2°C	Relative Humidity	55%
Atmosphere Pressure	101kPa	Test Voltage	DC 12 V

#### TEST DATE / ENGINEER

Test Date	July 4, 2023	Test By	Fanny Huang
-----------	--------------	---------	-------------

**TEST RESULTS**

Please refer to section "Test Data" - Appendix D

## 7.4. CONDUCTED BAND EDGE AND SPURIOUS EMISSION

### LIMITS

CFR 47 FCC Part15 (15.247) Subpart C ISED RSS-247 ISSUE 3		
Section	Test Item	Limit
CFR 47 FCC §15.247 (d) ISED RSS-247 5.5	Conducted Bandedge and Spurious Emissions	at least 30 dB below that in the 100 kHz bandwidth within the band that contains the highest level of the desired power

### TEST PROCEDURE

Refer to ANSI C63.10-2013 clause 11.11 and 11.13.

Connect the EUT to the spectrum analyser and use the following settings for reference level measurement:

Center Frequency	The center frequency of the channel under test
Detector	Peak
RBW	100 kHz
VBW	$\geq 3 \times \text{RBW}$
Span	1.5 x DTS bandwidth
Trace	Max hold
Sweep time	Auto couple.

Allow trace to fully stabilize and use the peak marker function to determine the maximum PSD level.

Change the settings for emission level measurement:

Span	Set the center frequency and span to encompass frequency range to be measured
Detector	Peak
RBW	100 kHz
VBW	$\geq 3 \times \text{RBW}$
measurement points	$\geq \text{span}/\text{RBW}$
Trace	Max hold
Sweep time	Auto couple.

Allow trace to fully stabilize and use the peak marker function to determine the maximum PSD level. Ensure that the amplitude of all unwanted emissions outside of the authorized frequency band (excluding restricted frequency bands) is attenuated by at least the minimum requirements specified in 11.11.

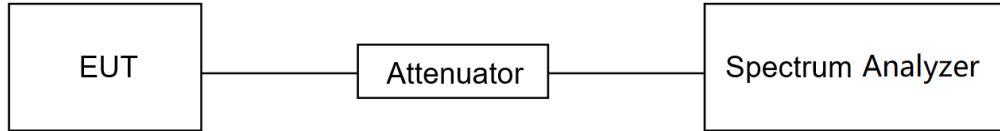
**TEST SETUP****TEST ENVIRONMENT**

Temperature	24.2°C	Relative Humidity	55%
Atmosphere Pressure	101kPa	Test Voltage	DC 12 V

**TEST DATE / ENGINEER**

Test Date	July 4, 2023	Test By	Fanny Huang
-----------	--------------	---------	-------------

**TEST RESULTS**

Please refer to section "Test Data" - Appendix E&F



## 7.5. DUTY CYCLE

### LIMITS

None; for reporting purposes only.

### TEST PROCEDURE

Refer to ANSI C63.10-2013 clause 11.6 Zero – Span Spectrum Analyzer method.

### TEST SETUP

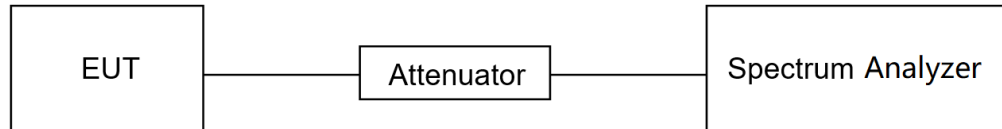

### TEST ENVIRONMENT

Temperature	24.2°C	Relative Humidity	55%
Atmosphere Pressure	101kPa	Test Voltage	DC 12 V

### TEST DATE / ENGINEER

Test Date	July 4, 2023	Test By	Fanny Huang
-----------	--------------	---------	-------------

### TEST RESULTS

Please refer to section "Test Data" - Appendix G

## 8. RADIATED TEST RESULTS

### LIMITS

Please refer to CFR 47 FCC §15.205 and §15.209.

Please refer to ISED RSS-GEN Clause 8.9 and Clause 8.10.

Radiation Disturbance Test Limit for FCC (Class B) (9 kHz ~ 1 GHz)

Emissions radiated outside of the specified frequency bands above 30 MHz			
Frequency Range (MHz)	Field Strength Limit (uV/m) at 3 m	Field Strength Limit (dBuV/m) at 3 m	
		Quasi-Peak	
30 - 88	100	40	
88 - 216	150	43.5	
216 - 960	200	46	
Above 960	500	54	
Above 1000	500	Peak	Average
		74	54

FCC Emissions radiated outside of the specified frequency bands below 30 MHz		
Frequency (MHz)	Field strength (microvolts/meter)	Measurement distance (meters)
0.009-0.490	2400/F(kHz)	300
0.490-1.705	24000/F(kHz)	30
1.705-30.0	30	30

ISED General field strength limits at frequencies below 30 MHz

Table 6 – General field strength limits at frequencies below 30 MHz		
Frequency	Magnetic field strength (H-Field) (uA/m)	Measurement distance (m)
9 - 490 kHz <sup>Note 1</sup>	6.37/F (F in kHz)	300
490 - 1705 kHz	63.7/F (F in kHz)	30
1.705 - 30 MHz	0.08	30

**Note 1:** The emission limits for the ranges 9-90 kHz and 110-490 kHz are based on measurements employing a linear average detector.

ISED Restricted bands please refer to ISED RSS-GEN Clause 8.10

Table 7 – Restricted frequency bands <sup>Note 1</sup>		
MHz	MHz	GHz
0.090 - 0.110	149.9 - 150.05	9.0 - 9.2
0.495 - 0.505	156.52475 - 156.52525	9.3 - 9.5
2.1735 - 2.1905	156.7 - 156.9	10.6 - 12.7
3.020 - 3.026	162.0125 - 167.17	13.25 - 13.4
4.125 - 4.128	167.72 - 173.2	14.47 - 14.5
4.17725 - 4.17775	240 - 285	15.35 - 16.2
4.20725 - 4.20775	322 - 335.4	17.7 - 21.4
5.677 - 5.683	399.9 - 410	22.01 - 23.12
6.215 - 6.218	608 - 614	23.6 - 24.0
6.26775 - 6.26825	960 - 1427	31.2 - 31.8
6.31175 - 6.31225	1435 - 1626.5	36.43 - 36.5
8.291 - 8.294	1645.5 - 1646.5	Above 38.6
8.362 - 8.366	1660 - 1710	
8.37625 - 8.38675	1718.8 - 1722.2	
8.41425 - 8.41475	2200 - 2300	
12.29 - 12.293	2310 - 2390	
12.51975 - 12.52025	2483.5 - 2500	
12.57675 - 12.57725	2655 - 2900	
13.36 - 13.41	3260 - 3267	
16.42 - 16.423	3332 - 3339	
16.80475 - 16.80525	3345.8 - 3358	
16.80425 - 16.80475	3500 - 4400	
25.5 - 25.67	4500 - 5150	
37.5 - 38.25	5350 - 5460	
73 - 74.6	7250 - 7750	
74.8 - 75.2	8025 - 8500	
108 - 138		

**Note 1:** Certain frequency bands listed in table 7 and in bands above 38.6 GHz are designated for licence-exempt applications. These frequency bands and the requirements that apply to related devices are set out in the 200 and 300 series of RSSs.

FCC Restricted bands of operation refer to FCC §15.205 (a):

MHz	MHz	MHz	GHz
0.090-0.110	16.42-16.423	399.9-410	4.5-5.15
<sup>1</sup> 0.495-0.505	16.69475-16.69525	608-614	5.35-5.46
2.1735-2.1905	16.80425-16.80475	960-1240	7.25-7.75
4.125-4.128	25.5-25.67	1300-1427	8.025-8.5
4.17725-4.17775	37.5-38.25	1435-1626.5	9.0-9.2
4.20725-4.20775	73-74.6	1645.5-1646.5	9.3-9.5
6.215-6.218	74.8-75.2	1660-1710	10.6-12.7
6.26775-6.26825	108-121.94	1718.8-1722.2	13.25-13.4
6.31175-6.31225	123-138	2200-2300	14.47-14.5
8.291-8.294	149.9-150.05	2310-2390	15.35-16.2
8.362-8.366	156.52475-156.52525	2483.5-2500	17.7-21.4
8.37625-8.38675	156.7-156.9	2690-2900	22.01-23.12
8.41425-8.41475	162.0125-167.17	3260-3267	23.6-24.0
12.29-12.293	167.72-173.2	3332-3339	31.2-31.8
12.51975-12.52025	240-285	3345.8-3358	36.43-36.5
12.57675-12.57725	322-335.4	3600-4400	( <sup>2</sup> )
13.36-13.41			

Note: <sup>1</sup>Until February 1, 1999, this restricted band shall be 0.490-0.510 MHz.

<sup>2</sup>Above 38.6c

## **TEST PROCEDURE**

Below 30 MHz

The setting of the spectrum analyser

RBW	200 Hz (From 9 kHz to 0.15 MHz)/ 9 kHz (From 0.15 MHz to 30 MHz)
VBW	200 Hz (From 9 kHz to 0.15 MHz)/ 9 kHz (From 0.15 MHz to 30 MHz)
Sweep	Auto

1. The testing follows the guidelines in ANSI C63.10-2013 clause 6.4.
2. The EUT was arranged to its worst case and then turntable (from 0 degree to 360 degrees) to find the maximum reading. A pre-amp and a high pass filter are used for the test in order to get better signal level. Both Horizontal, Face-on and Face-off polarizations of the antenna are set to make the measurement.
3. The EUT was placed on a turntable with 80 cm above ground.
4. The EUT was set 3 meters from the interference receiving antenna, which was mounted on the top of a 1 m height antenna tower.
5. The radiated emission limits are based on measurements employing a CISPR quasi-peak detector except for the frequency bands 9-90 kHz, 110-490 kHz and above 1000 MHz Radiated emission limits in these three bands are based on measurements employing an average detector.
6. For measurement below 1 GHz, the initial step in collecting conducted emission data is a spectrum analyzer peak detector mode pre-scanning the measurement frequency range. Significant peaks are then marked and then Quasi Peak and average detector mode re-measured. If the emission level of the EUT measured by the peak detector is 3 dB lower than the applicable limit, the peak emission level will be reported. Otherwise, the emission measurement will be repeated using the quasi-peak and average detector and reported.
7. Although these tests were performed other than open field site, adequate comparison measurements were confirmed against 30m open field site. Therefore sufficient tests were made to demonstrate that the alternative site produces results that correlate with the ones of tests made in an open field site based on KDB 414788.
8. The limits in CFR 47, Part 15, Subpart C, paragraph 15.209 (a), are identical to those in RSS-GEN Section 8.9, Table 6, since the measurements are performed in terms of magnetic field strength and converted to electric field strength levels (as reported in the table) using the free space impedance of  $377\Omega$ . For example, the measurement frequency X KHz resulted in a level of Y dBuV/m, which is equivalent to  $Y-51.5 = Z$  dBuA/m, which has the same margin, W dB, to the corresponding RSS-GEN Table 6 limit as it has to be 15.209(a) limit.

Below 1 GHz and above 30 MHz

The setting of the spectrum analyser

RBW	120 kHz
VBW	300 kHz
Sweep	Auto

Detector	Peak/QP
Trace	Max hold

1. The testing follows the guidelines in ANSI C63.10-2013 clause 6.5.
2. The EUT was arranged to its worst case and then tune the antenna tower (from 1 m to 4 m) and turntable (from 0 degree to 360 degrees) to find the maximum reading. A pre-amp and a high pass filter are used for the test in order to get better signal level. Both horizontal and vertical polarizations of the antenna are set to make the measurement.
3. The EUT was placed on a turntable with 80 cm above ground.
4. The EUT was set 3 meters from the interference receiving antenna, which was mounted on the top of a variable height antenna tower.
5. For measurement below 1 GHz, the initial step in collecting conducted emission data is a spectrum analyzer peak detector mode pre-scanning the measurement frequency range. Significant peaks are then marked and then Quasi Peak detector mode re-measured. If the emission level of the EUT measured by the peak detector is 3 dB lower than the applicable limit, the peak emission level will be reported. Otherwise, the emission measurement will be repeated using the quasi-peak detector and reported.

Above 1G

The setting of the spectrum analyser

RBW	1 MHz
VBW	PEAK: 3 MHz AVG: see note 6
Sweep	Auto
Detector	Peak
Trace	Max hold

1. The testing follows the guidelines in ANSI C63.10-2013 clause 6.6.
2. The EUT was arranged to its worst case and then tune the antenna tower (from 1 m to 4 m) and turntable (from 0 degree to 360 degrees) to find the maximum reading. A pre-amp and a high pass filter are used for the test in order to get better signal level. Both horizontal and vertical polarizations of the antenna are set to make the measurement.
3. The EUT was placed on a turntable with 1.5 m above ground.
4. The EUT was set 3 meters from the interference receiving antenna, which was mounted on the top of a variable height antenna tower.
5. For measurement above 1 GHz, the emission measurement will be measured by the peak detector. This peak level, once corrected, must comply with the limit specified in Section 15.209.
6. For measurements above 1 GHz the resolution bandwidth is set to 1 MHz, then the video bandwidth is set to 3 MHz for peak measurements and 1 MHz resolution bandwidth with 1/T video bandwidth with peak detector for average measurements. For the Duty Cycle please refer to clause 7.5.ON TIME AND DUTY CYCLE.

X axis, Y axis, Z axis positions:

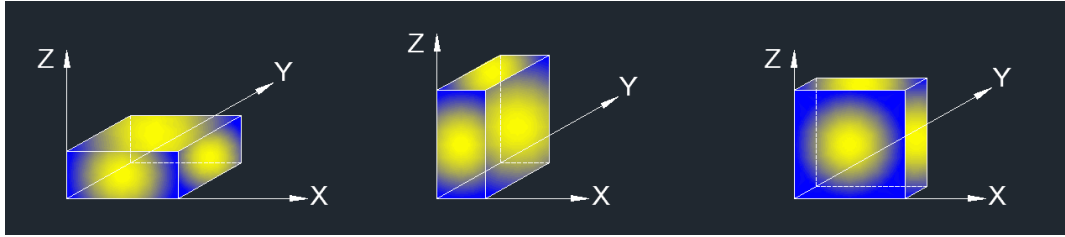

Note 1: For all radiated test, EUT in each of three orthogonal axis emissions had been tested, but only the worst case (X axis) data recorded in the report.

Note 2: The EUT was fully exercised with external accessories during the test. In the case of multiple accessory external ports, an external accessory shall be connected to one of each type of port.

For Band edge:

Note:

1. Measurement = Reading Level + Correct Factor.
2. If the peak values are less than the average limit of 54 dBuV/m, the average result is deemed to comply with average limit.
3. Peak: Peak detector.
4. AVG:  $VBW=1/T_{on}$ , where:  $T_{on}$  is the transmitting duration.
5. For the transmitting duration, please refer to clause 7.5.
6. Only the worst data was recorded, if it complies with the limit, the other emissions deemed to comply with the limit.
7. Horizontal and Vertical have been tested, only the worst data was recorded in the report.
8. All modes, channels and antennas have been tested, only the worst data was recorded in the report.

For Radiate Spurious emission 1GHz-3GHz:

Note:

1. Measurement = Reading Level + Correct Factor.
2. If the Peak values are less than the Average limit of 54 dBuV/m, the Average result is deemed to comply with Average limit.
3. Peak: Peak detector.
4. AVG:  $VBW=1/T_{on}$ , where:  $T_{on}$  is the transmitting duration.
5. For the transmitting duration, please refer to clause 7.5.
6. Filter losses were only considered in the spurious frequency bands and the authorized band was not corrected for Band reject filter losses.
7. Proper operation of the transmitter prior to adding the filter to the measurement chain.
8. All modes, channels and antennas have been tested, only the worst data was recorded in the report.

For Radiate Spurious emission 3GHz-18GHz:

Note:

1. Peak Result = Reading Level + Correct Factor.
2. If the Peak values are less than the Average limit of 54 dBuV/m, the Average result is deemed to comply with Average limit.
3. Peak: Peak detector.
4. AVG:  $VBW=1/Ton$ , where: Ton is the transmitting duration.
5. For the transmitting duration, please refer to clause 7.5.
6. Filter losses were only considered in the spurious frequency bands and the authorized band was not corrected for High Pass Filter losses.
7. Proper operation of the transmitter prior to adding the filter to the measurement chain.
8. All modes, channels and antennas have been tested, only the worst data was recorded in the report.

For Radiate Spurious emission 9kHz-30MHz:

Note:

1. Measurement = Reading Level + Correct Factor.  
( $\text{dBuA/m} = \text{dBuV/m} - 20\text{Log}_{10}[120\pi] = \text{dBuV/m} - 51.5$ ).
2. If the Peak values are less than the QP limit, the QP result is deemed to comply with QP limit.
3. All 3 polarizations (Horizontal, Face-on and Face-off) of the loop antenna had been tested, but only the worst data recorded in the report.
4. All modes, channels and antennas have been tested, only the worst data was recorded in the report.

For Radiate Spurious emission 18GHz-26GHz:

Note:

1. Measurement = Reading Level + Correct Factor.
2. If the Peak values are less than the Average limit of 54 dBuV/m, the Average result is deemed to comply with Average limit.
3. Peak: Peak detector.
4. All modes, channels and antennas have been tested, only the worst data was recorded in the report.

For Radiate Spurious emission 30MHz-1GHz:

Note:

1. Result Level = Read Level + Correct Factor.
2. If the Peak values are less than the QP limit, the QP result is deemed to comply with QP limit.
3. Test setup: RBW: 120 kHz, VBW: 300 kHz, Sweep time: auto.
4. All modes, channels and antennas have been tested, only the worst data was recorded in the report.

**TEST SETUP**

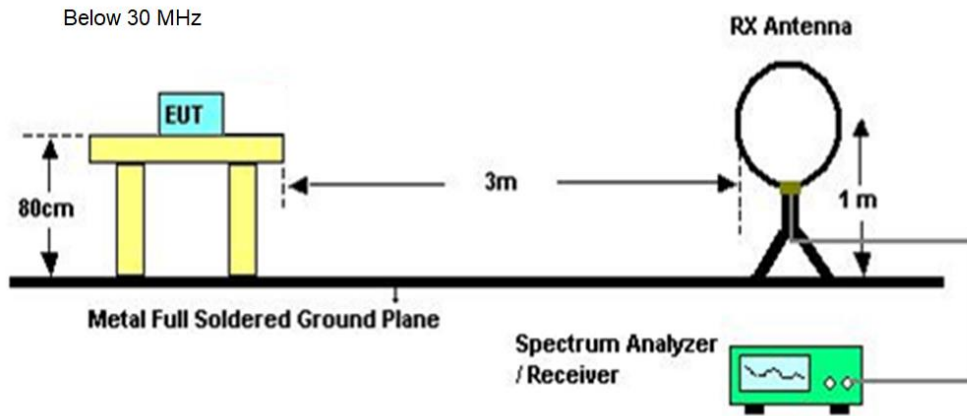

Below 1 GHz and above 30 MHz

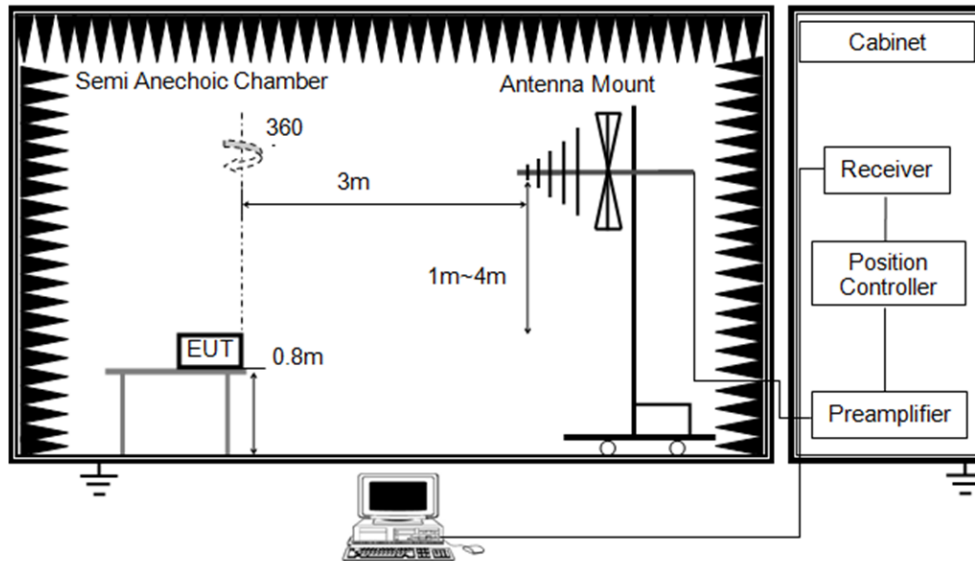

Above 1 GHz

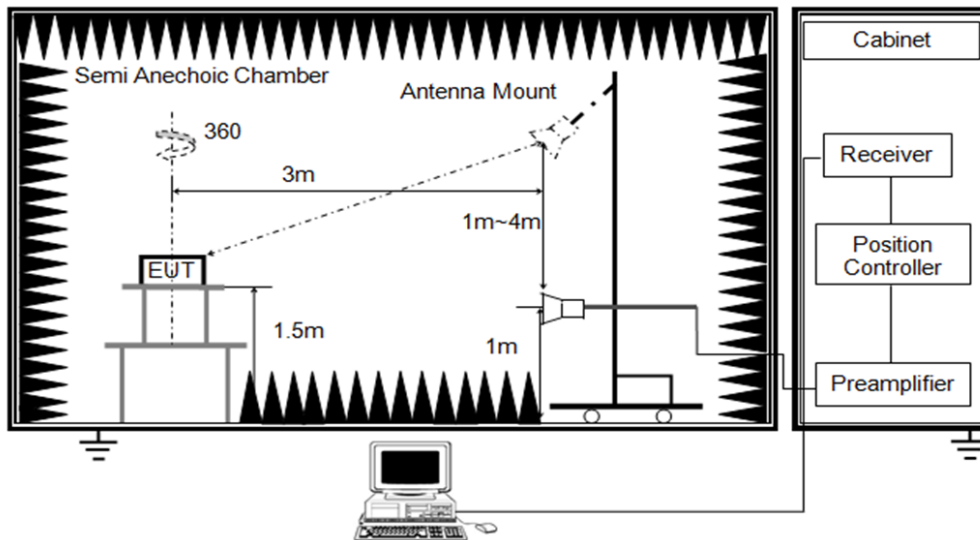



**TEST ENVIRONMENT**

Temperature	24.3°C	Relative Humidity	55%
Atmosphere Pressure	101kPa	Test Voltage	

**TEST DATE / ENGINEER**

Test Date	July 22, 2023	Test By	Rex Huang
-----------	---------------	---------	-----------

**TEST RESULTS**

## 8.1. RESTRICTED BANDEDGE

Test Mode:	802.11b PK	Frequency(MHz):	2412
Polarity:	Horizontal	Test Voltage:	DC 12 V

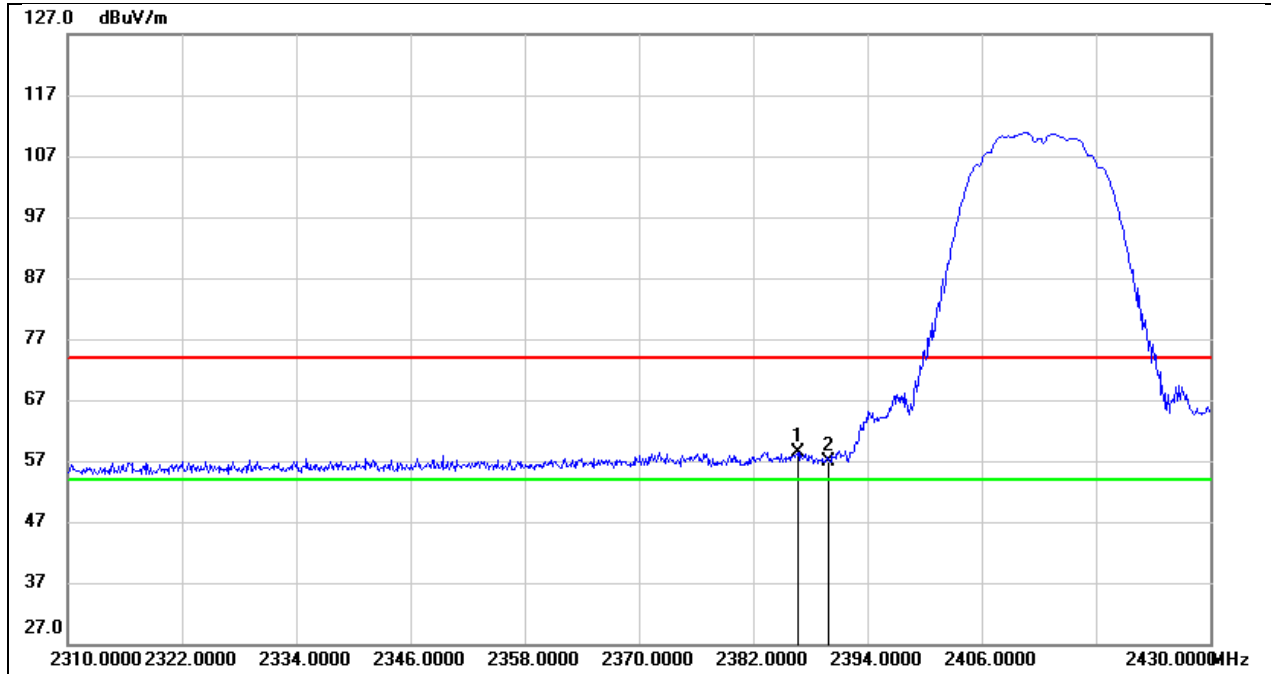

No.	Frequency (MHz)	Reading (dBuV)	Correct (dB/m)	Result (dBuV/m)	Limit (dBuV/m)	Margin (dB)	Remark
1	2386.680	26.26	32.15	58.41	74.00	-15.59	peak
2	2390.000	24.66	32.16	56.82	74.00	-17.18	peak

Test Mode:	802.11b PK	Frequency(MHz):	2412
Polarity:	Vertical	Test Voltage:	DC 12 V

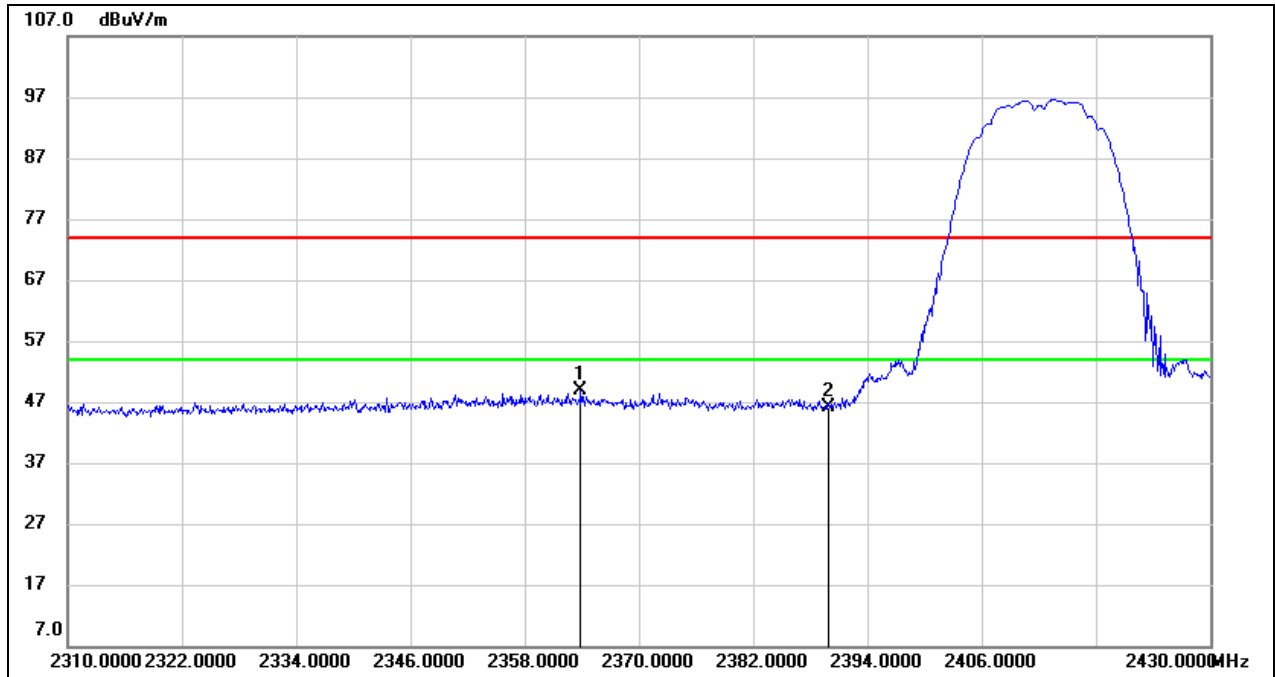

No.	Frequency (MHz)	Reading (dBuV)	Correct (dB/m)	Result (dBuV/m)	Limit (dBuV/m)	Margin (dB)	Remark
1	2363.880	16.79	32.09	48.88	74.00	-25.12	peak
2	2390.000	13.86	32.16	46.02	74.00	-27.98	peak

Test Mode:	802.11b AV	Frequency(MHz):	2412
Polarity:	Horizontal	Test Voltage:	DC 12 V

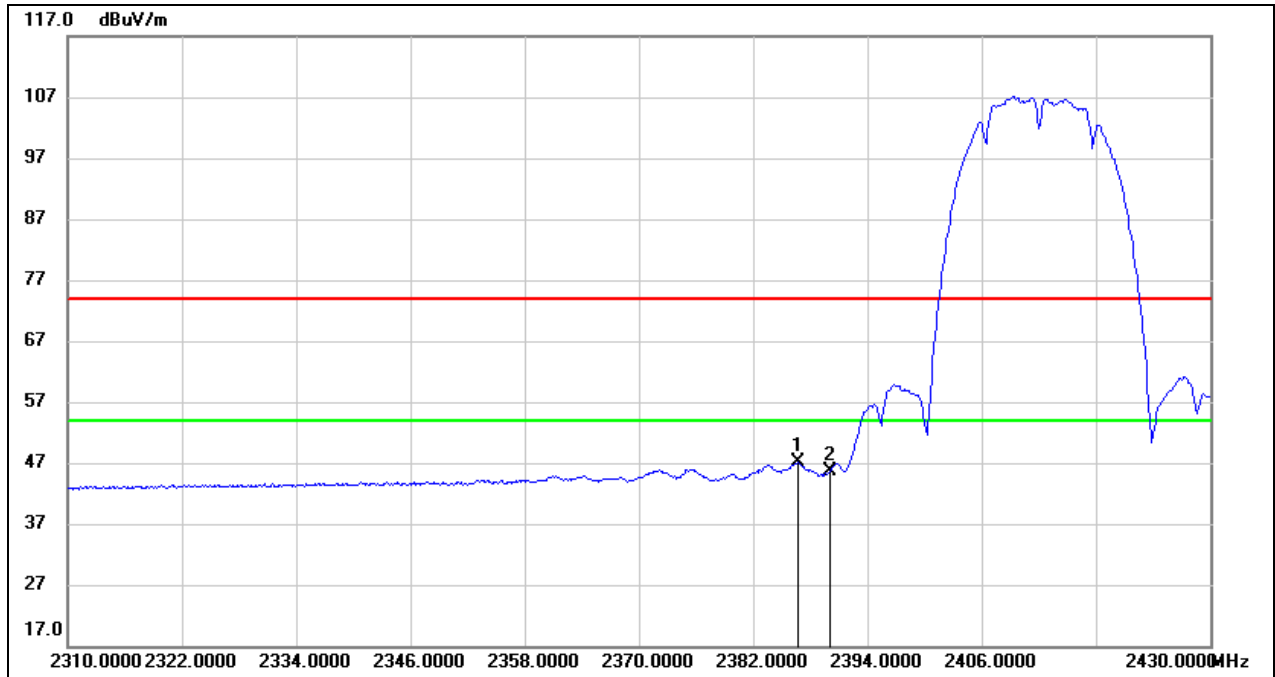

No.	Frequency (MHz)	Reading (dBuV)	Correct (dB/m)	Result (dBuV/m)	Limit (dBuV/m)	Margin (dB)	Remark
1	2386.680	14.87	32.15	47.02	54.00	-6.98	AVG
2	2390.000	13.40	32.16	45.56	54.00	-8.44	AVG

Test Mode:	802.11b PK	Frequency(MHz):	2462
Polarity:	Horizontal	Test Voltage:	DC 12 V

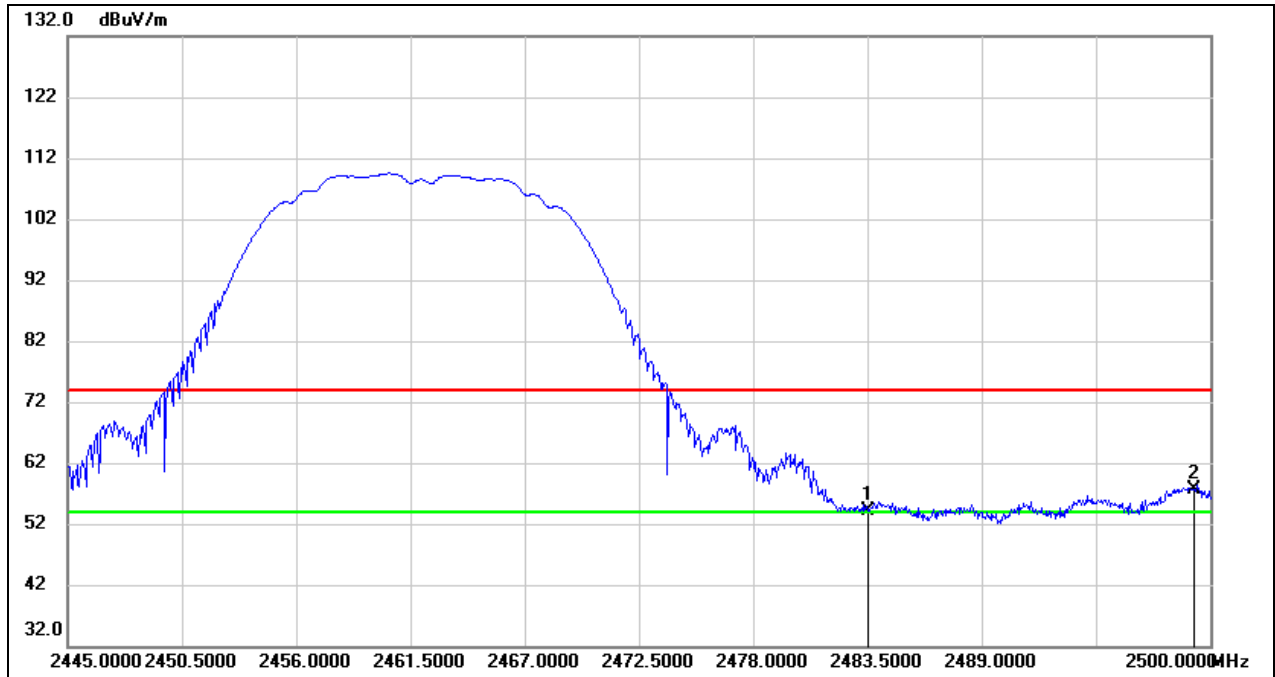

No.	Frequency (MHz)	Reading (dBuV)	Correct (dB/m)	Result (dBuV/m)	Limit (dBuV/m)	Margin (dB)	Remark
1	2483.500	21.69	32.44	54.13	74.00	-19.87	peak
2	2499.230	25.20	32.49	57.69	74.00	-16.31	peak

Test Mode:	802.11b AV	Frequency(MHz):	2462
Polarity:	Horizontal	Test Voltage:	DC 12 V

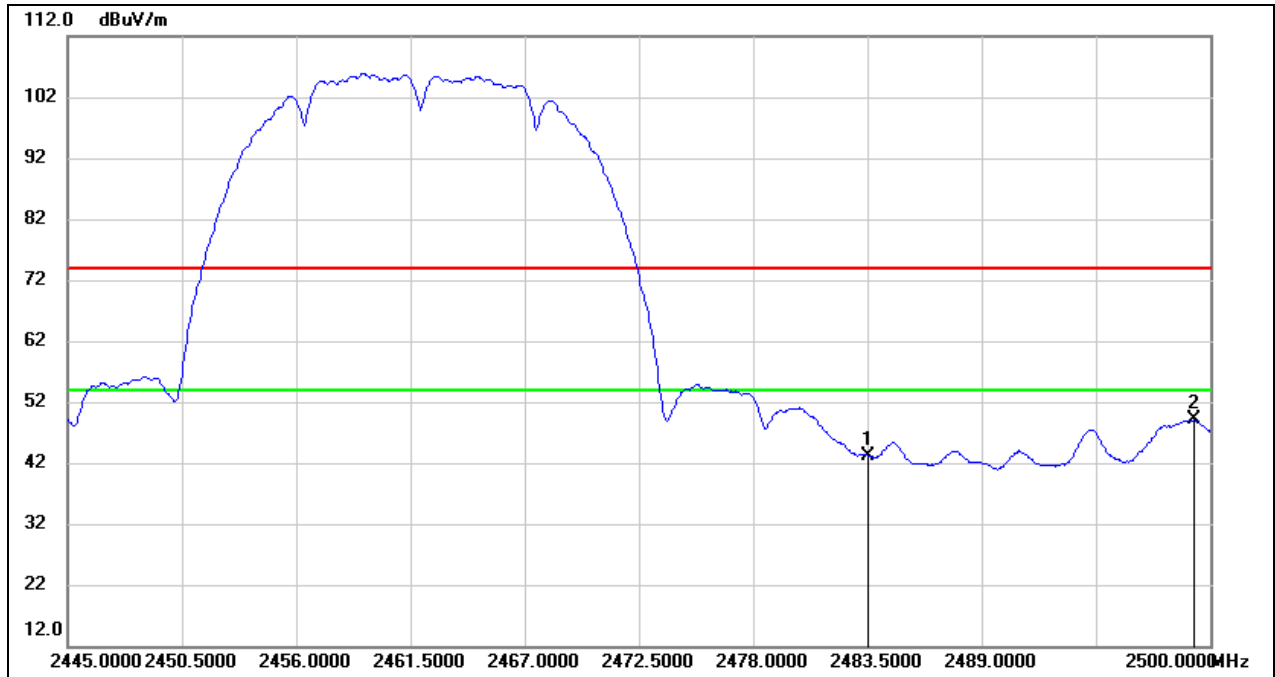

No.	Frequency (MHz)	Reading (dBuV)	Correct (dB/m)	Result (dBuV/m)	Limit (dBuV/m)	Margin (dB)	Remark
1	2483.500	10.79	32.44	43.23	54.00	-10.77	AVG
2	2499.230	16.57	32.49	49.06	54.00	-4.94	AVG

Test Mode:	802.11g PK	Frequency(MHz):	2412
Polarity:	Horizontal	Test Voltage:	DC 12 V

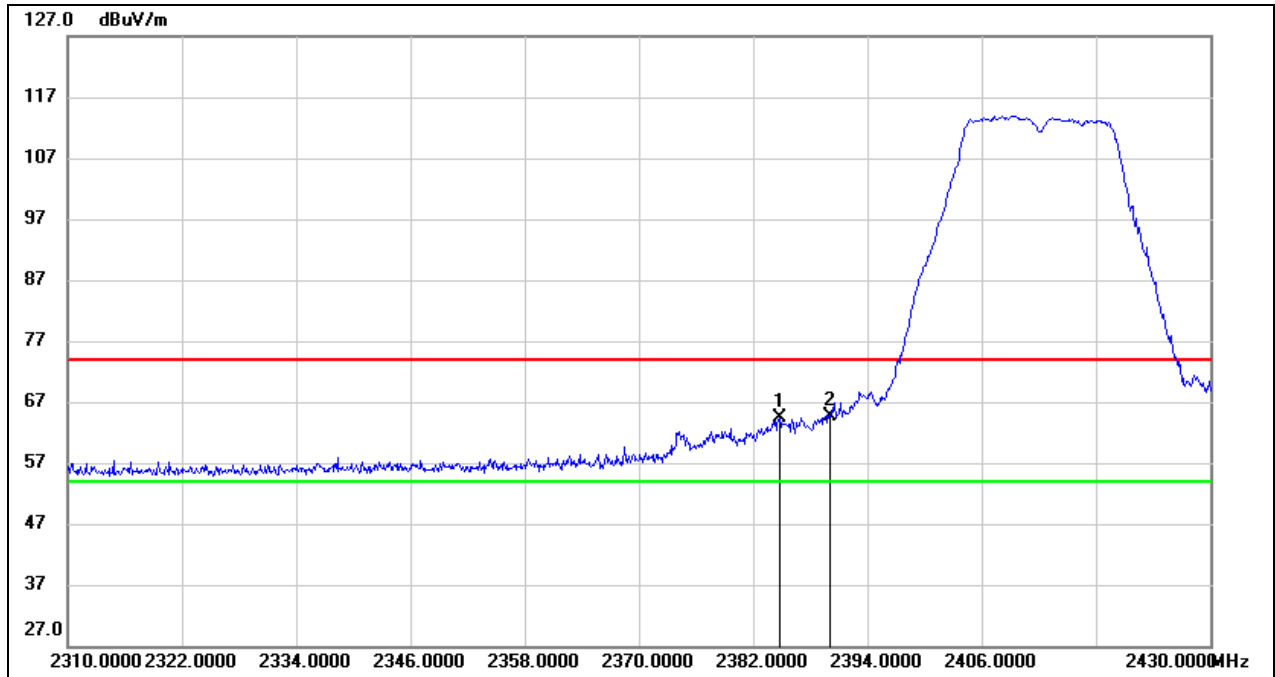

No.	Frequency (MHz)	Reading (dBuV)	Correct (dB/m)	Result (dBuV/m)	Limit (dBuV/m)	Margin (dB)	Remark
1	2384.760	32.32	32.14	64.46	74.00	-9.54	peak
2	2390.000	32.52	32.16	64.68	74.00	-9.32	peak

Test Mode:	802.11g AV	Frequency(MHz):	2412
Polarity:	Horizontal	Test Voltage:	DC 12 V

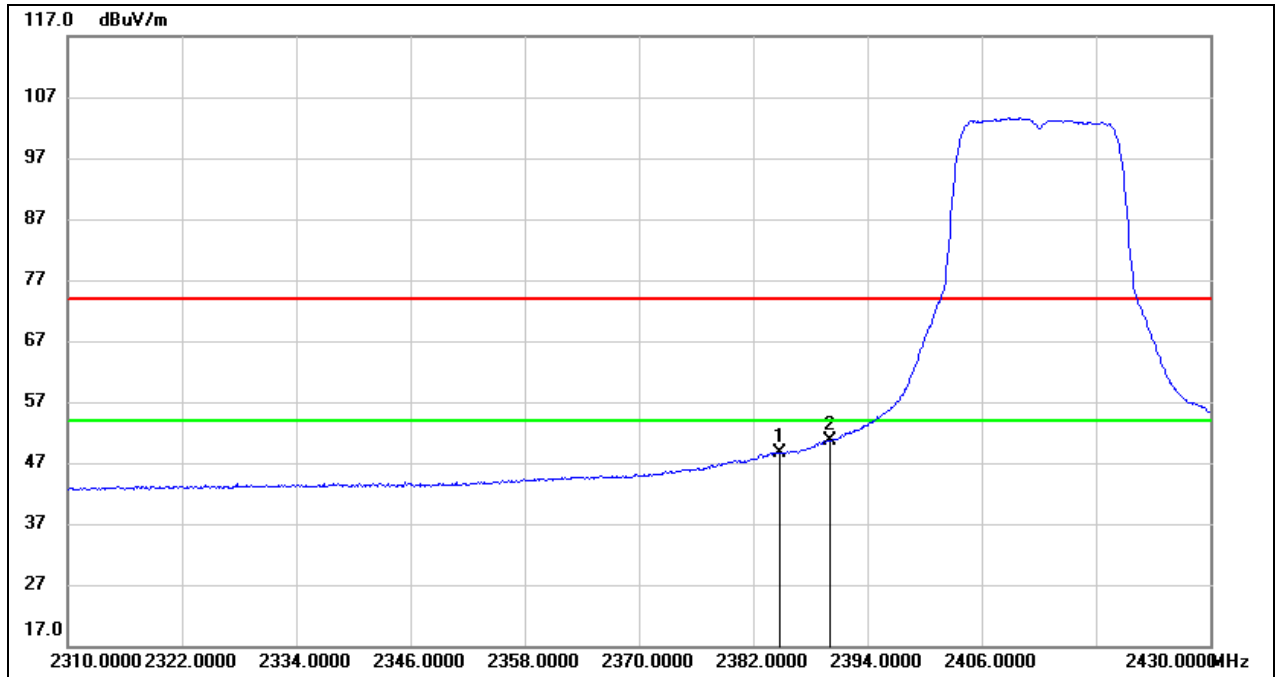

No.	Frequency (MHz)	Reading (dBuV)	Correct (dB/m)	Result (dBuV/m)	Limit (dBuV/m)	Margin (dB)	Remark
1	2384.760	16.42	32.14	48.56	54.00	-5.44	AVG
2	2390.000	18.53	32.16	50.69	54.00	-3.31	AVG



Test Mode:	802.11g PK	Frequency(MHz):	2457
Polarity:	Horizontal	Test Voltage:	DC 12 V

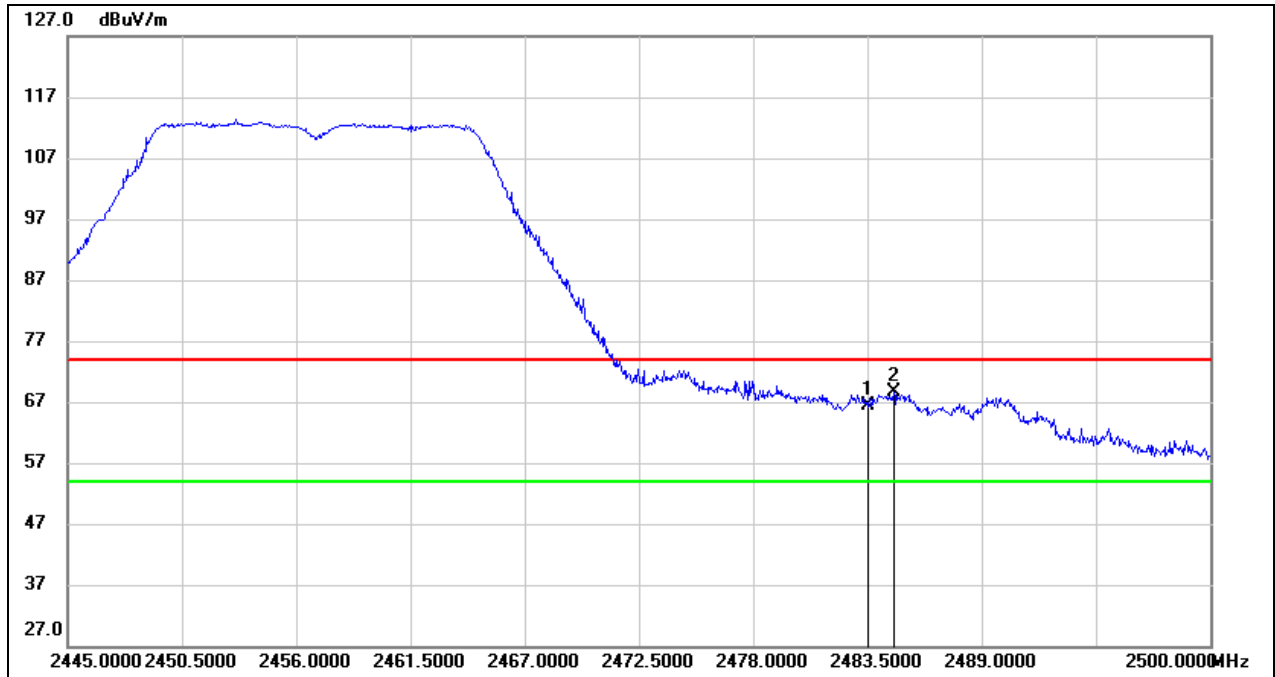

No.	Frequency (MHz)	Reading (dBuV)	Correct (dB/m)	Result (dBuV/m)	Limit (dBuV/m)	Margin (dB)	Remark
1	2483.500	33.95	32.44	66.39	74.00	-7.61	peak
2	2484.765	36.27	32.44	68.71	74.00	-5.29	peak

Test Mode:	802.11g AV	Frequency(MHz):	2457
Polarity:	Horizontal	Test Voltage:	DC 12 V

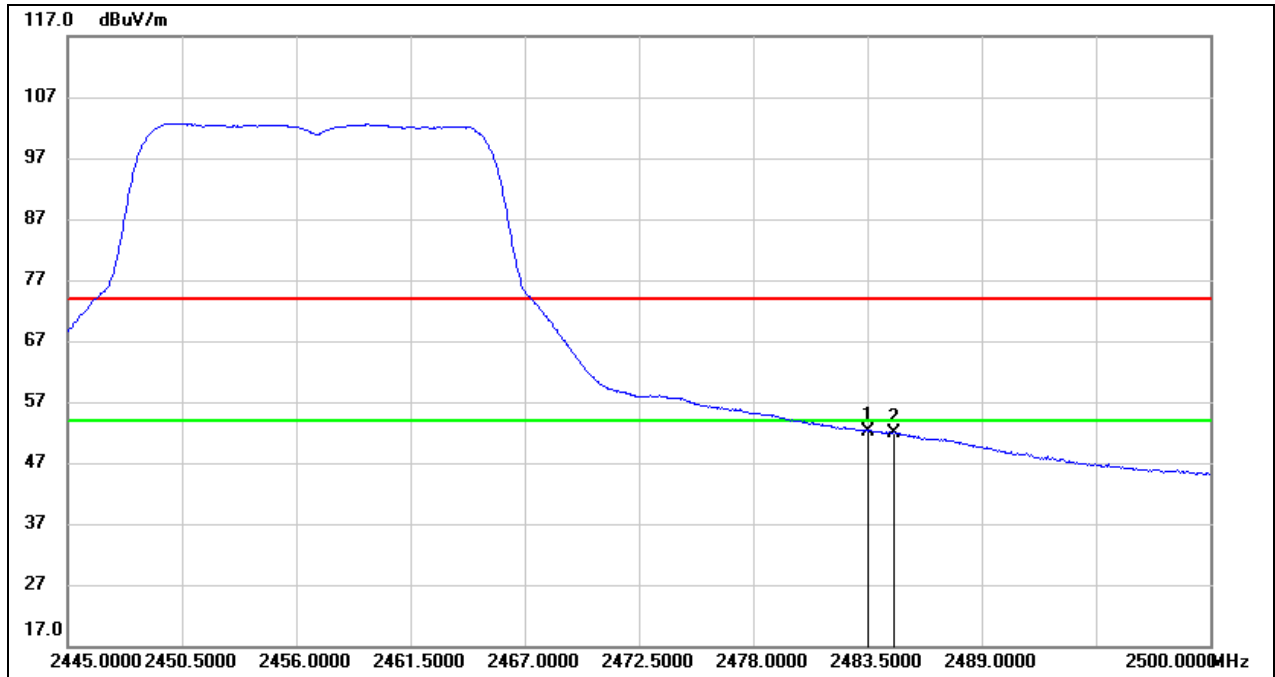

No.	Frequency (MHz)	Reading (dBuV)	Correct (dB/m)	Result (dBuV/m)	Limit (dBuV/m)	Margin (dB)	Remark
1	2483.500	19.81	32.44	52.25	54.00	-1.75	AVG
2	2484.765	19.56	32.44	52.00	54.00	-2.00	AVG

Test Mode:	802.11g PK	Frequency(MHz):	2462
Polarity:	Horizontal	Test Voltage:	DC 12 V

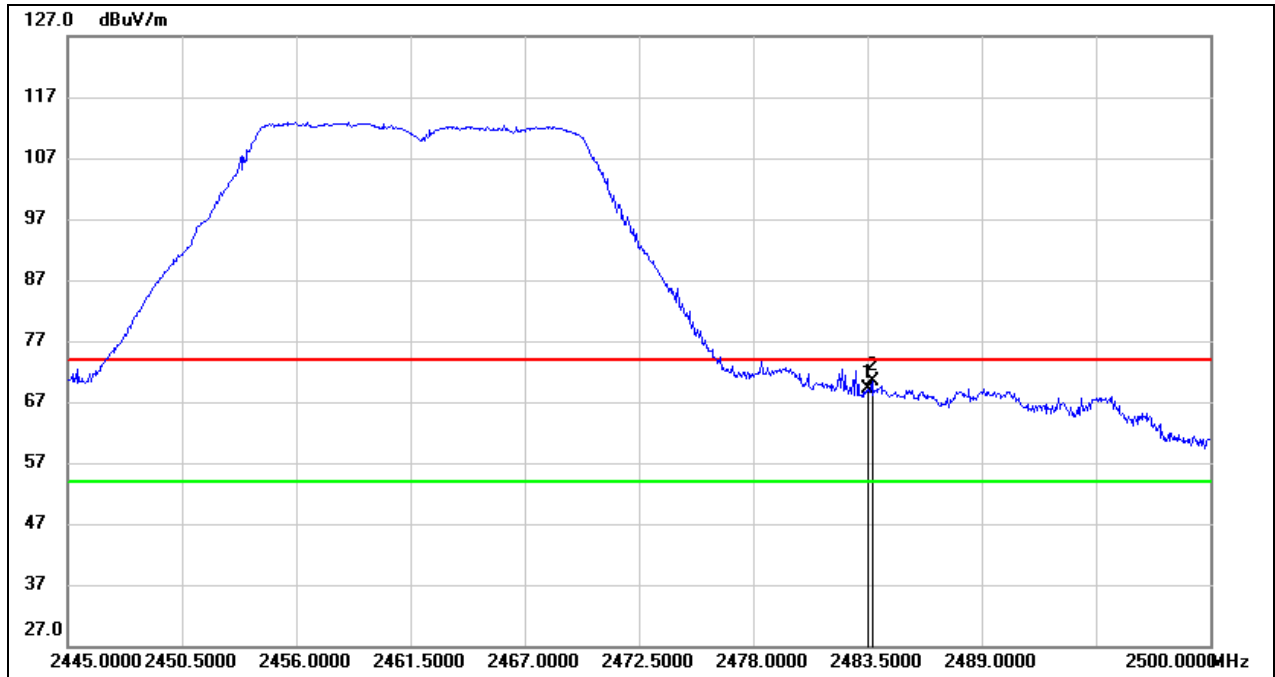

No.	Frequency (MHz)	Reading (dBuV)	Correct (dB/m)	Result (dBuV/m)	Limit (dBuV/m)	Margin (dB)	Remark
1	2483.500	36.63	32.44	69.07	74.00	-4.93	peak
2	2483.720	38.06	32.44	70.50	74.00	-3.50	peak

Test Mode:	802.11g AV	Frequency(MHz):	2462
Polarity:	Horizontal	Test Voltage:	DC 12 V

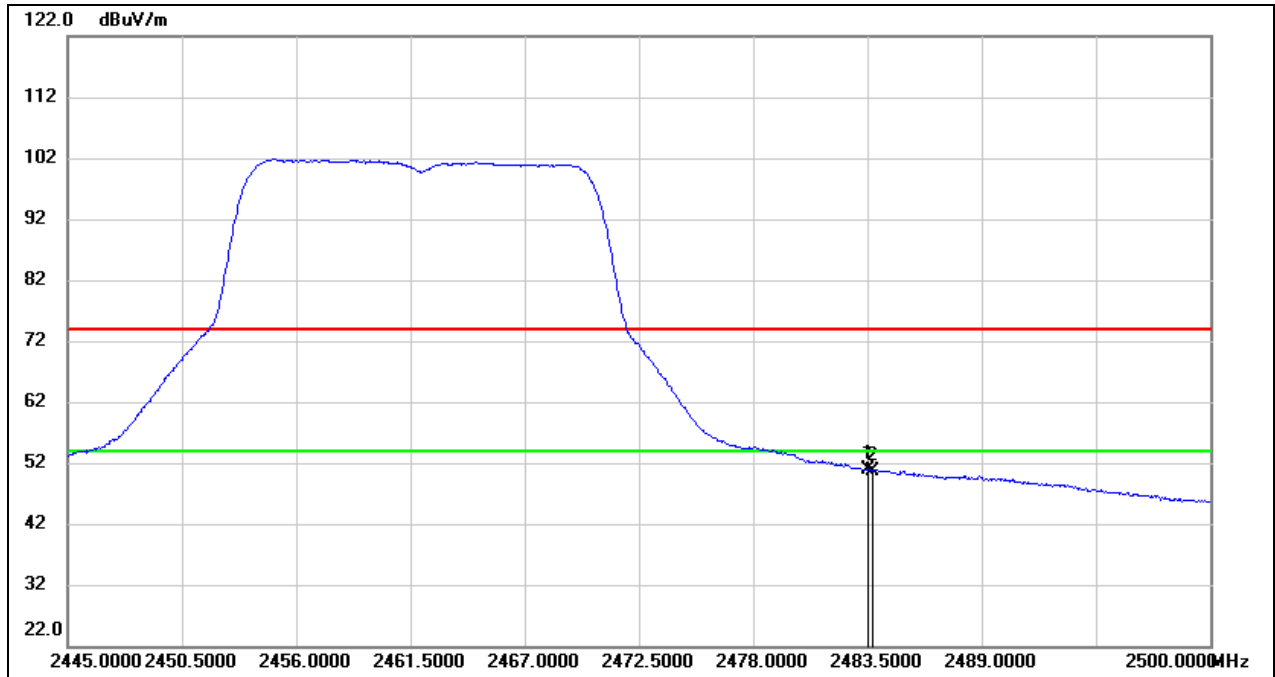

No.	Frequency (MHz)	Reading (dBuV)	Correct (dB/m)	Result (dBuV/m)	Limit (dBuV/m)	Margin (dB)	Remark
1	2483.500	18.49	32.44	50.93	54.00	-3.07	AVG
2	2483.720	18.30	32.44	50.74	54.00	-3.26	AVG

Test Mode:	802.11be EHT20 PK	Frequency(MHz):	2412
Polarity:	Horizontal	Test Voltage:	DC 12 V

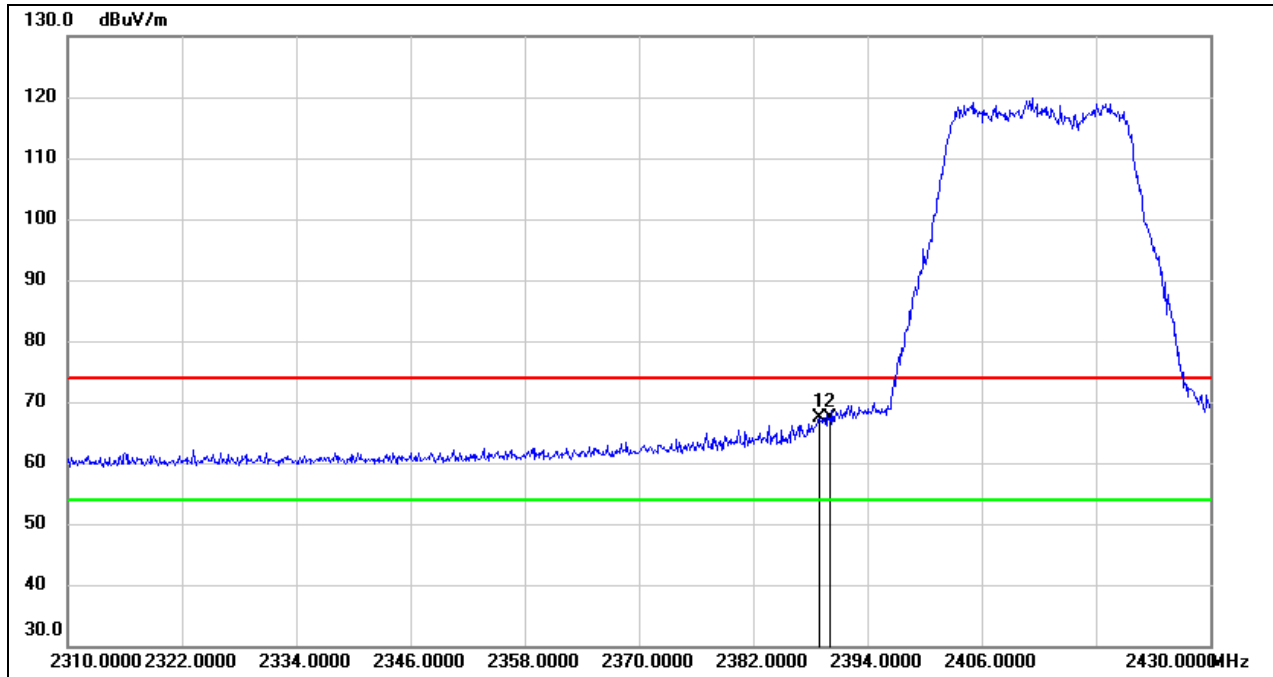

No.	Frequency (MHz)	Reading (dBuV)	Correct (dB/m)	Result (dBuV/m)	Limit (dBuV/m)	Margin (dB)	Remark
1	2388.960	35.22	32.16	67.38	74.00	-6.62	peak
2	2390.000	35.11	32.16	67.27	74.00	-6.73	peak

Test Mode:	802.11be EHT20 AV	Frequency(MHz):	2412
Polarity:	Horizontal	Test Voltage:	DC 12 V

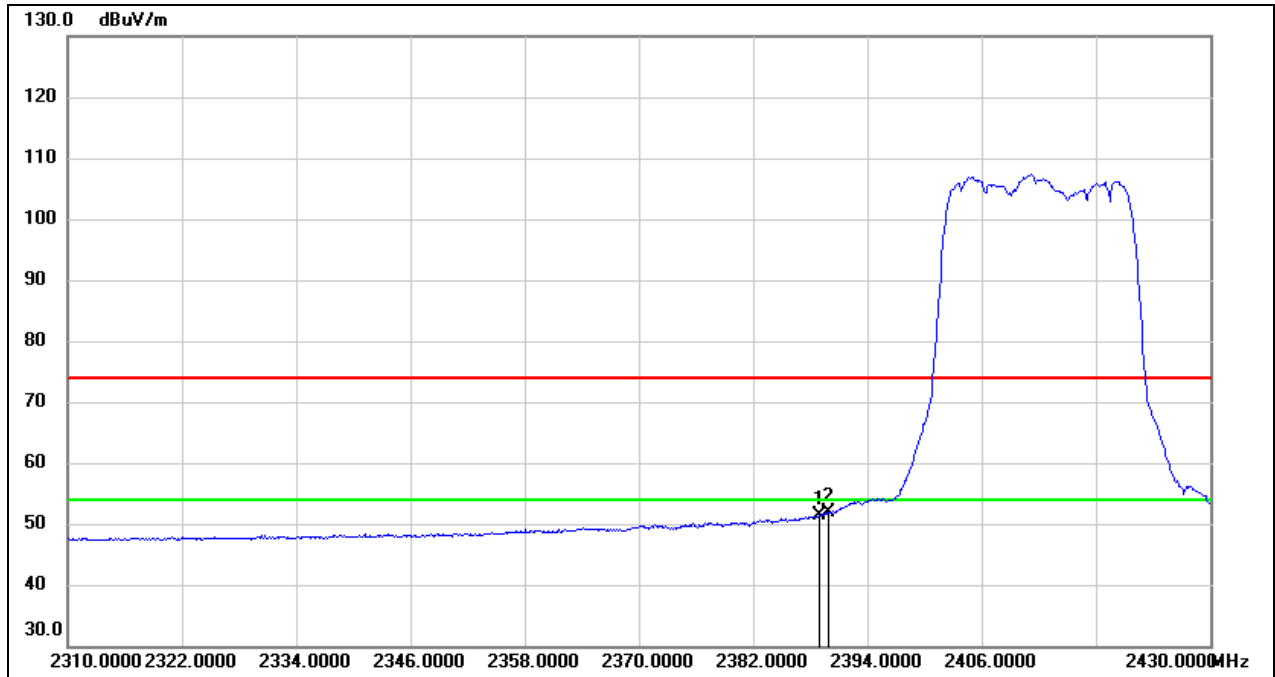

No.	Frequency (MHz)	Reading (dBuV)	Correct (dB/m)	Result (dBuV/m)	Limit (dBuV/m)	Margin (dB)	Remark
1	2388.960	19.17	32.16	51.33	54.00	-2.67	AVG
2	2390.000	19.60	32.16	51.76	54.00	-2.24	AVG

Test Mode:	802.11be EHT20 PK	Frequency(MHz):	2417
Polarity:	Horizontal	Test Voltage:	DC 12 V

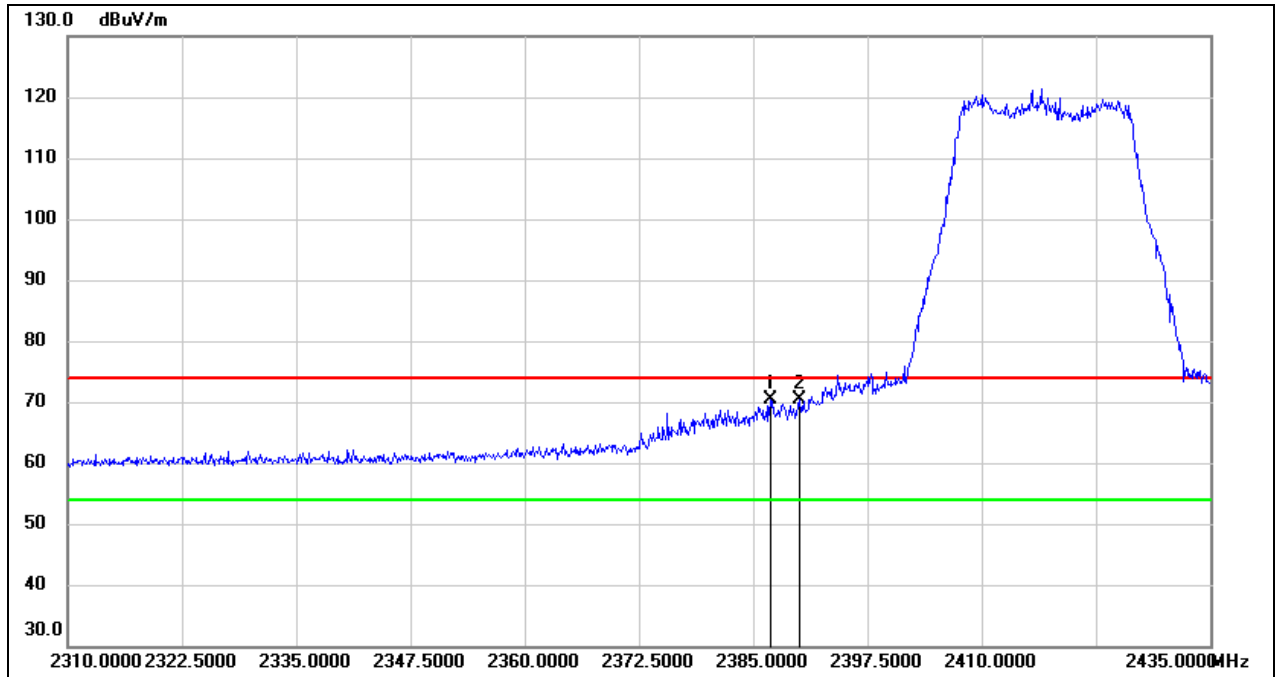

No.	Frequency (MHz)	Reading (dBuV)	Correct (dB/m)	Result (dBuV/m)	Limit (dBuV/m)	Margin (dB)	Remark
1	2386.875	38.21	32.15	70.36	74.00	-3.64	peak
2	2390.000	38.18	32.16	70.34	74.00	-3.66	peak

Test Mode:	802.11be EHT20 AV	Frequency(MHz):	2417
Polarity:	Horizontal	Test Voltage:	DC 12 V

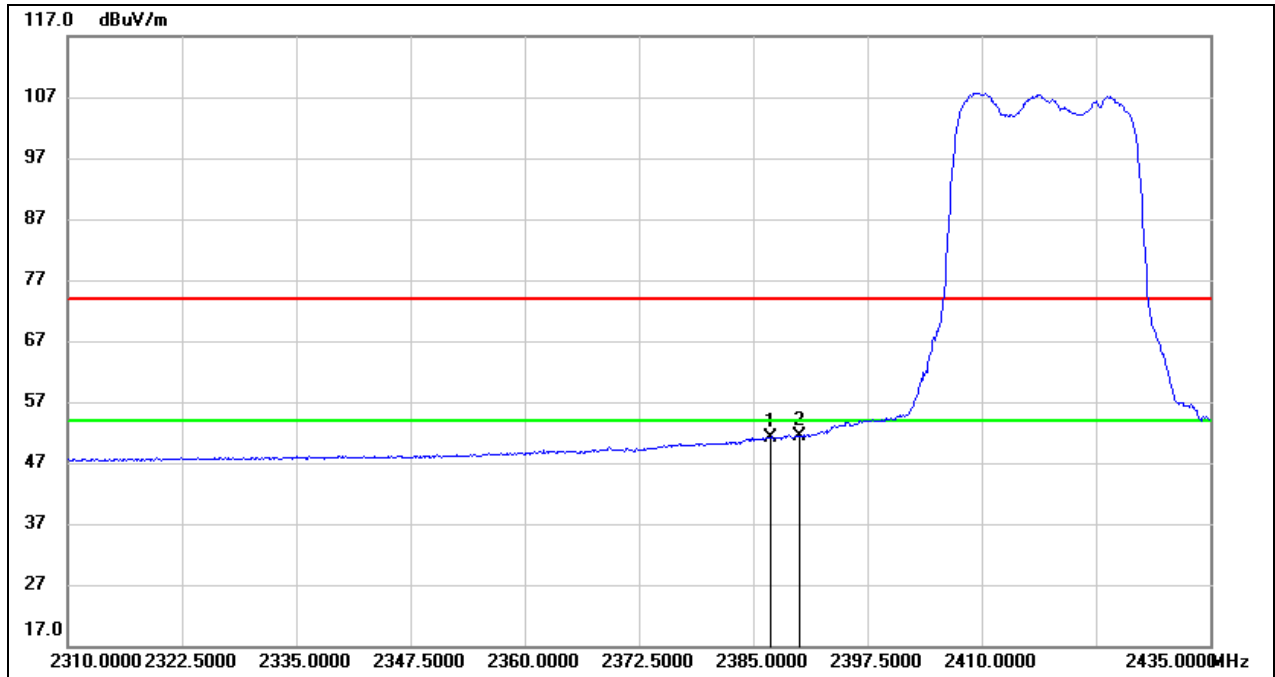

No.	Frequency (MHz)	Reading (dBuV)	Correct (dB/m)	Result (dBuV/m)	Limit (dBuV/m)	Margin (dB)	Remark
1	2386.875	18.92	32.15	51.07	54.00	-2.93	AVG
2	2390.000	19.28	32.16	51.44	54.00	-2.56	AVG



Test Mode:	802.11be EHT20 PK	Frequency(MHz):	2437
Polarity:	Horizontal	Test Voltage:	DC 12 V

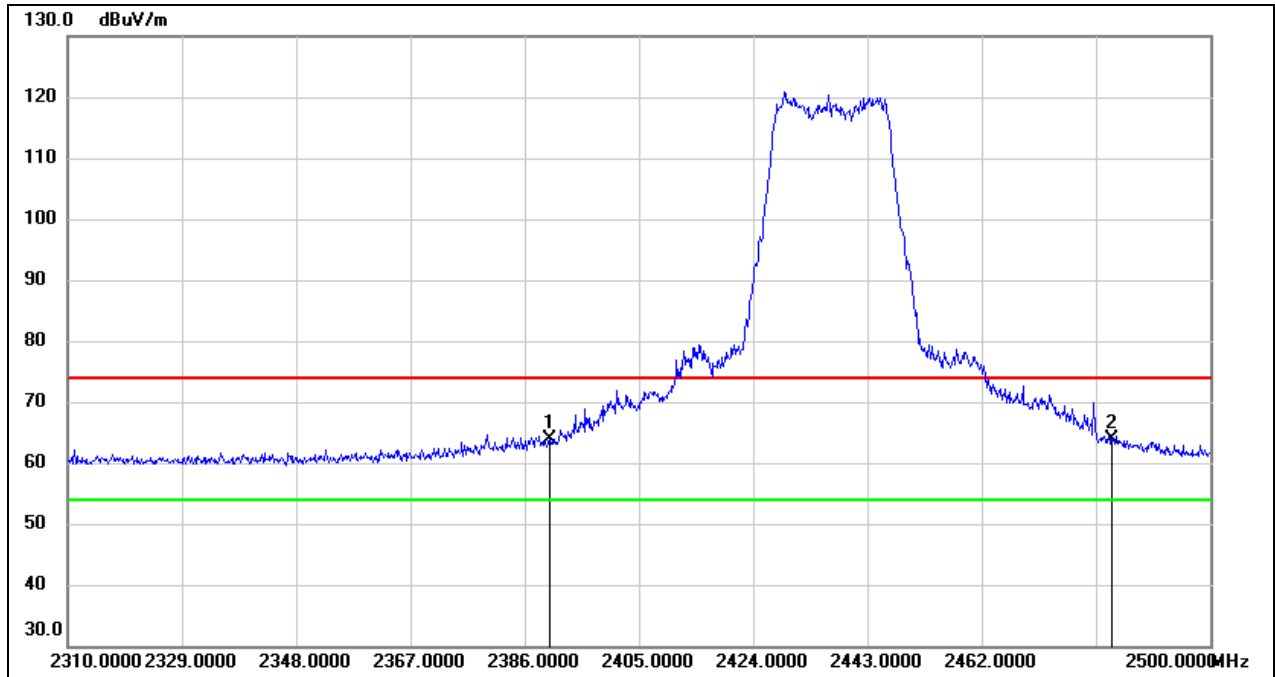

No.	Frequency (MHz)	Reading (dBuV)	Correct (dB/m)	Result (dBuV/m)	Limit (dBuV/m)	Margin (dB)	Remark
1	2390.000	31.66	32.16	63.82	74.00	-10.18	peak
2	2483.500	31.38	32.44	63.82	74.00	-10.18	peak

Test Mode:	802.11be EHT20 AV	Frequency(MHz):	2437
Polarity:	Horizontal	Test Voltage:	DC 12 V

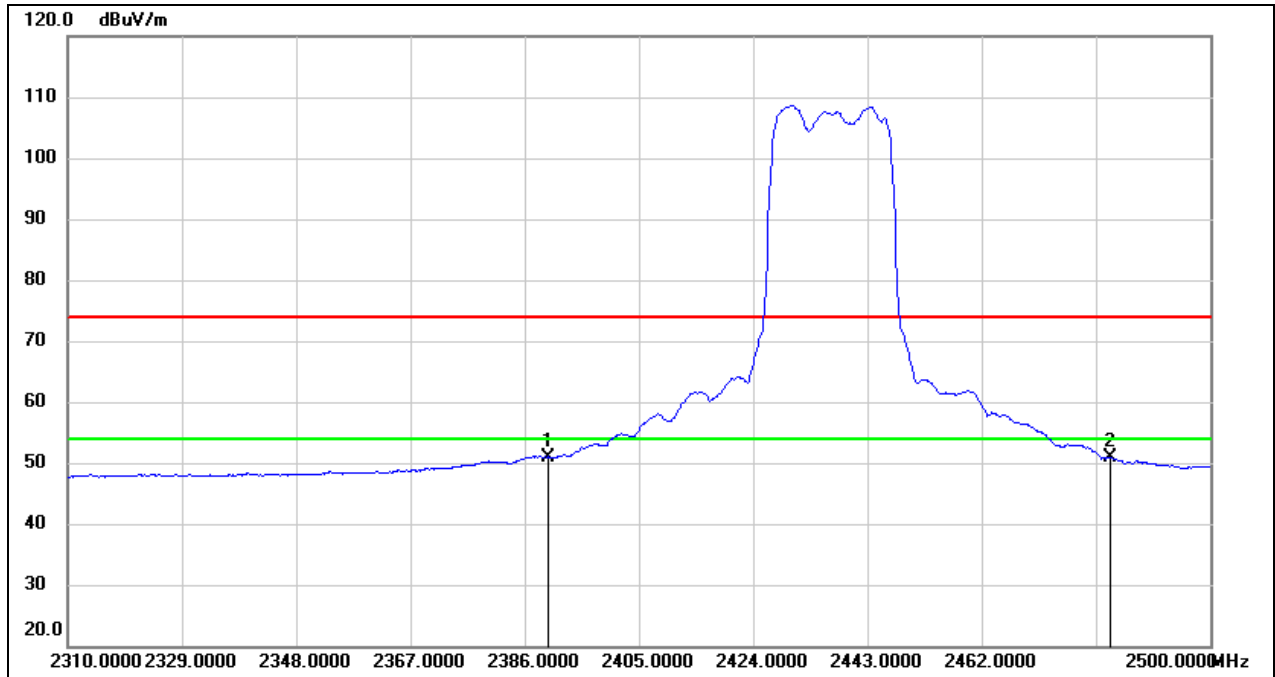

No.	Frequency (MHz)	Reading (dBuV)	Correct (dB/m)	Result (dBuV/m)	Limit (dBuV/m)	Margin (dB)	Remark
1	2390.000	18.77	32.16	50.93	54.00	-3.07	AVG
2	2483.500	18.41	32.44	50.85	54.00	-3.15	AVG

Test Mode:	802.11be EHT20 PK	Frequency(MHz):	2457
Polarity:	Horizontal	Test Voltage:	DC 12 V

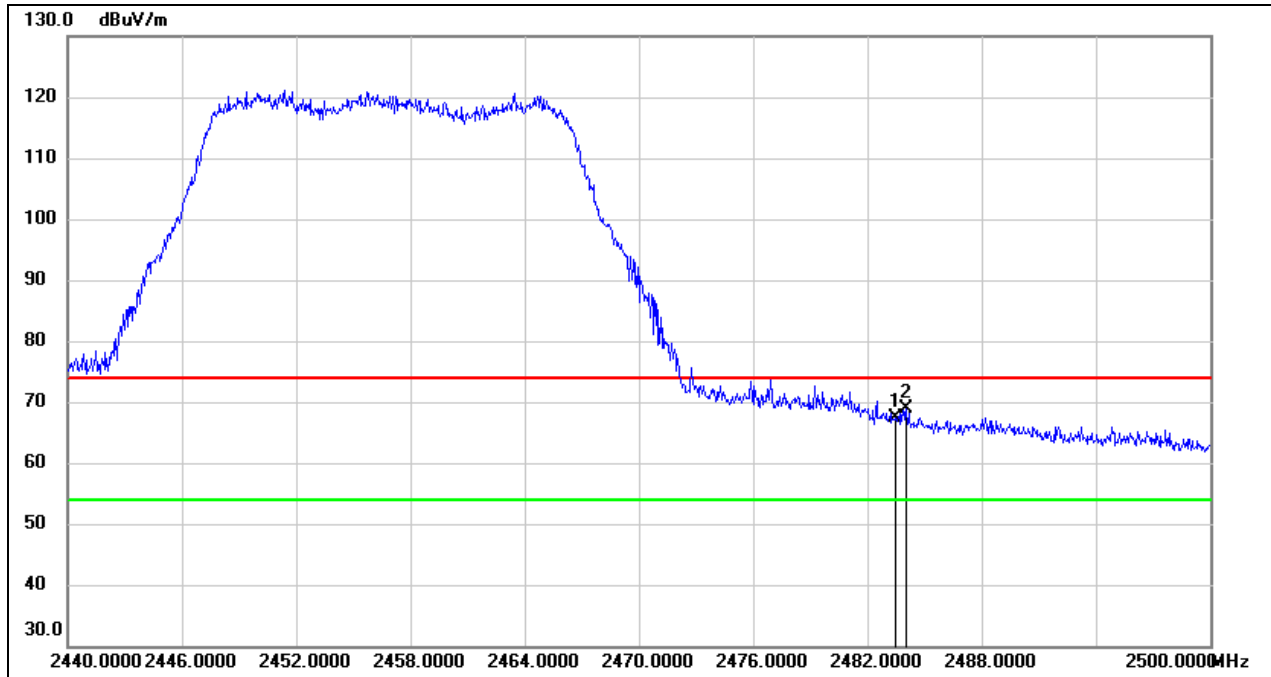

No.	Frequency (MHz)	Reading (dBuV)	Correct (dB/m)	Result (dBuV/m)	Limit (dBuV/m)	Margin (dB)	Remark
1	2483.500	34.94	32.44	67.38	74.00	-6.62	peak
2	2484.040	36.44	32.44	68.88	74.00	-5.12	peak

Test Mode:	802.11be EHT20 AV	Frequency(MHz):	2457
Polarity:	Horizontal	Test Voltage:	DC 12 V

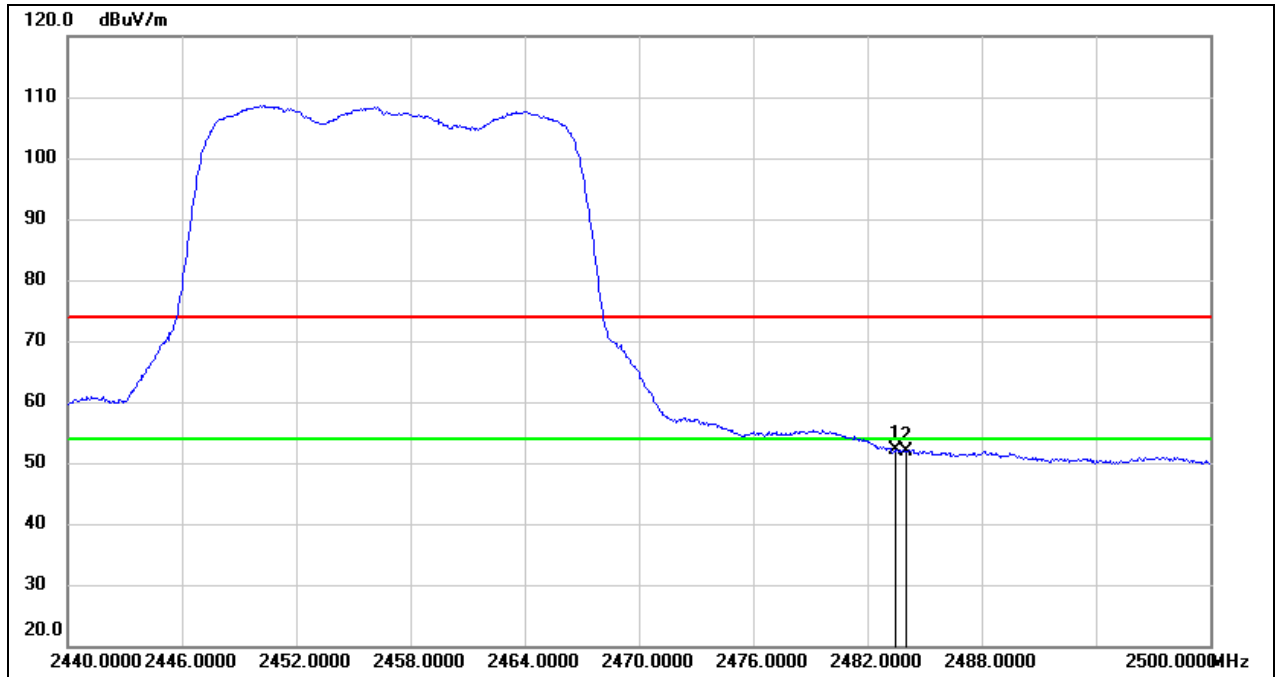

No.	Frequency (MHz)	Reading (dBuV)	Correct (dB/m)	Result (dBuV/m)	Limit (dBuV/m)	Margin (dB)	Remark
1	2483.500	19.65	32.44	52.09	54.00	-1.91	AVG
2	2484.040	19.33	32.44	51.77	54.00	-2.23	AVG

Test Mode:	802.11be EHT20 PK	Frequency(MHz):	2462
Polarity:	Horizontal	Test Voltage:	DC 12 V

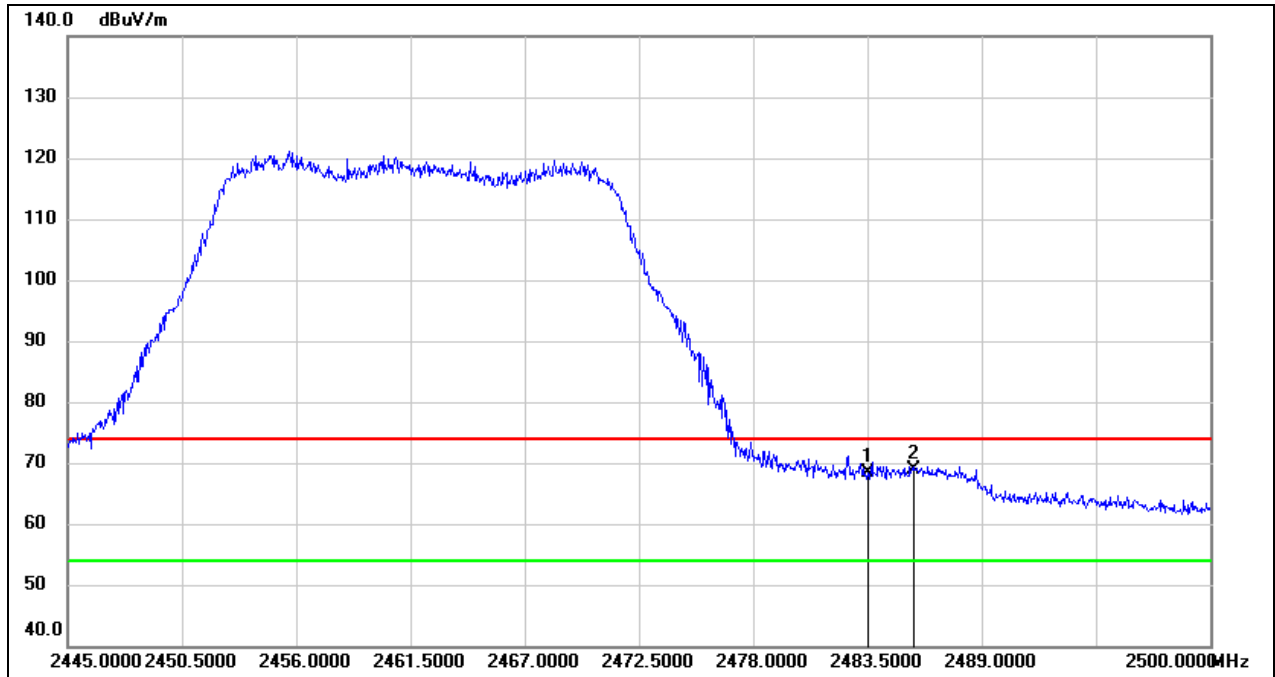

No.	Frequency (MHz)	Reading (dBuV)	Correct (dB/m)	Result (dBuV/m)	Limit (dBuV/m)	Margin (dB)	Remark
1	2483.500	35.84	32.44	68.28	74.00	-5.72	peak
2	2485.755	36.51	32.44	68.95	74.00	-5.05	peak

Test Mode:	802.11be EHT20 AV	Frequency(MHz):	2462
Polarity:	Horizontal	Test Voltage:	DC 12 V

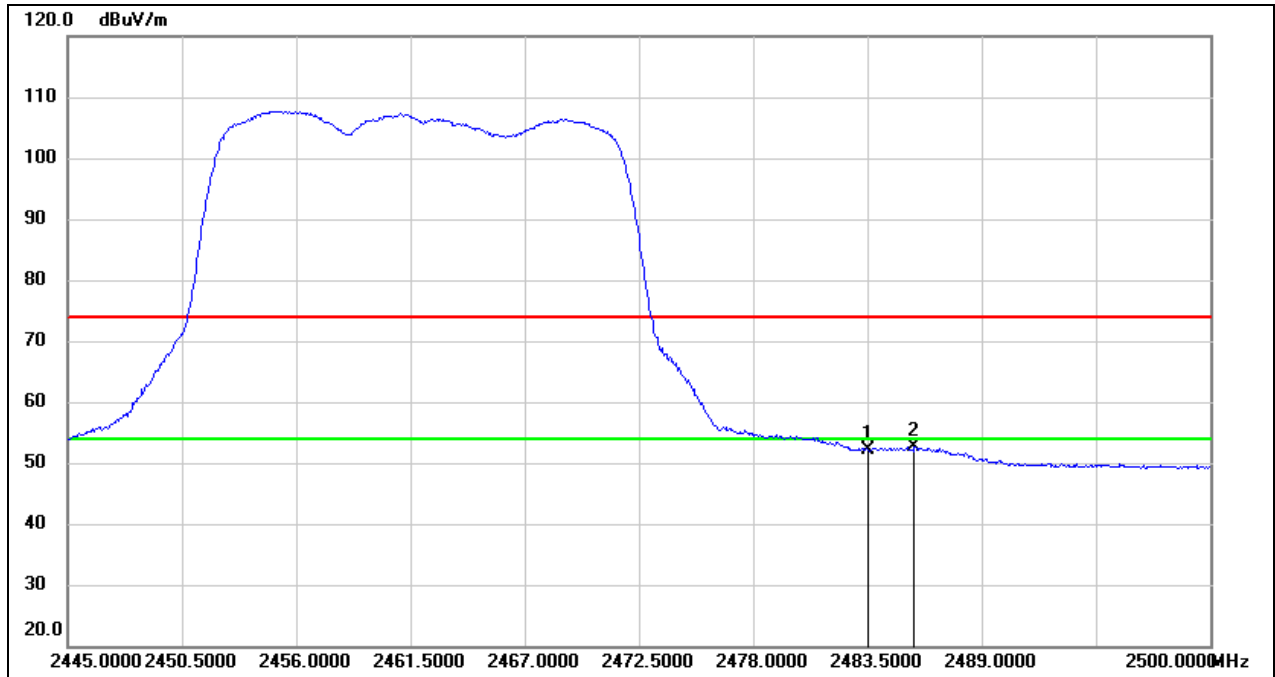

No.	Frequency (MHz)	Reading (dBuV)	Correct (dB/m)	Result (dBuV/m)	Limit (dBuV/m)	Margin (dB)	Remark
1	2483.500	19.74	32.44	52.18	54.00	-1.82	AVG
2	2485.755	20.11	32.44	52.55	54.00	-1.45	AVG

Test Mode:	802.11be EHT40 PK	Frequency(MHz):	2422
Polarity:	Horizontal	Test Voltage:	DC 12 V

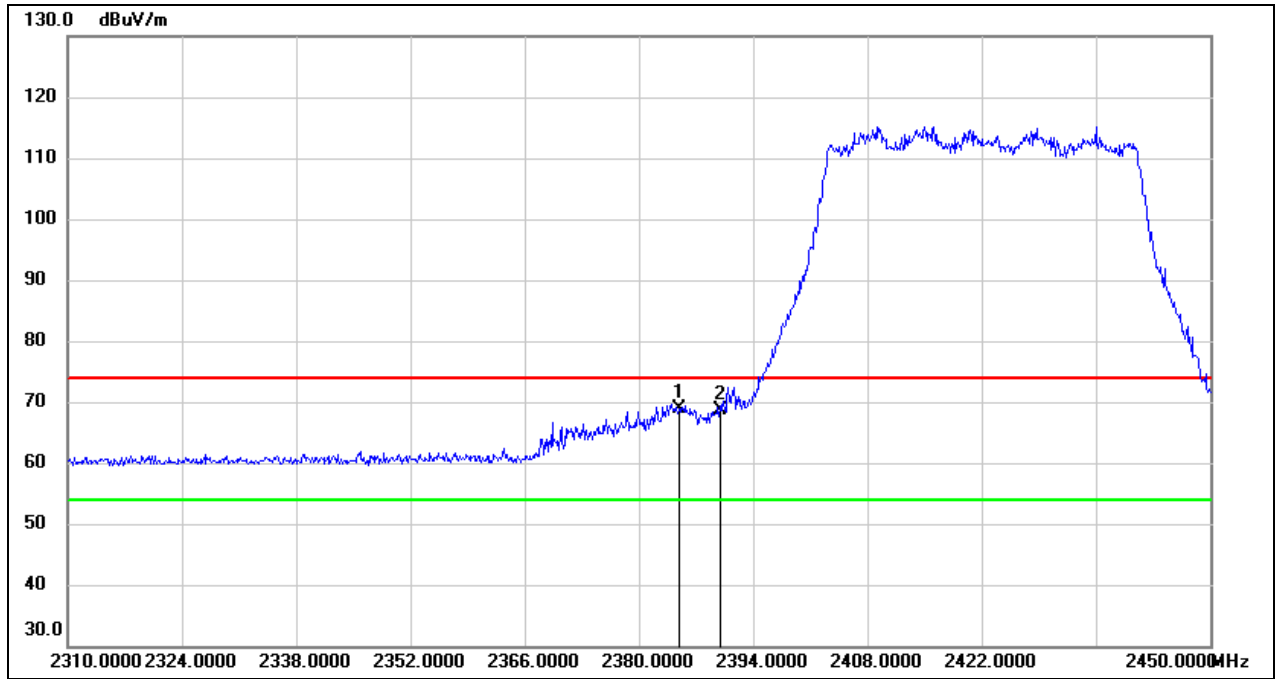

No.	Frequency (MHz)	Reading (dBuV)	Correct (dB/m)	Result (dBuV/m)	Limit (dBuV/m)	Margin (dB)	Remark
1	2384.900	36.67	32.14	68.81	74.00	-5.19	peak
2	2390.000	36.51	32.16	68.67	74.00	-5.33	peak

Test Mode:	802.11be EHT40 AV	Frequency(MHz):	2422
Polarity:	Horizontal	Test Voltage:	DC 12 V

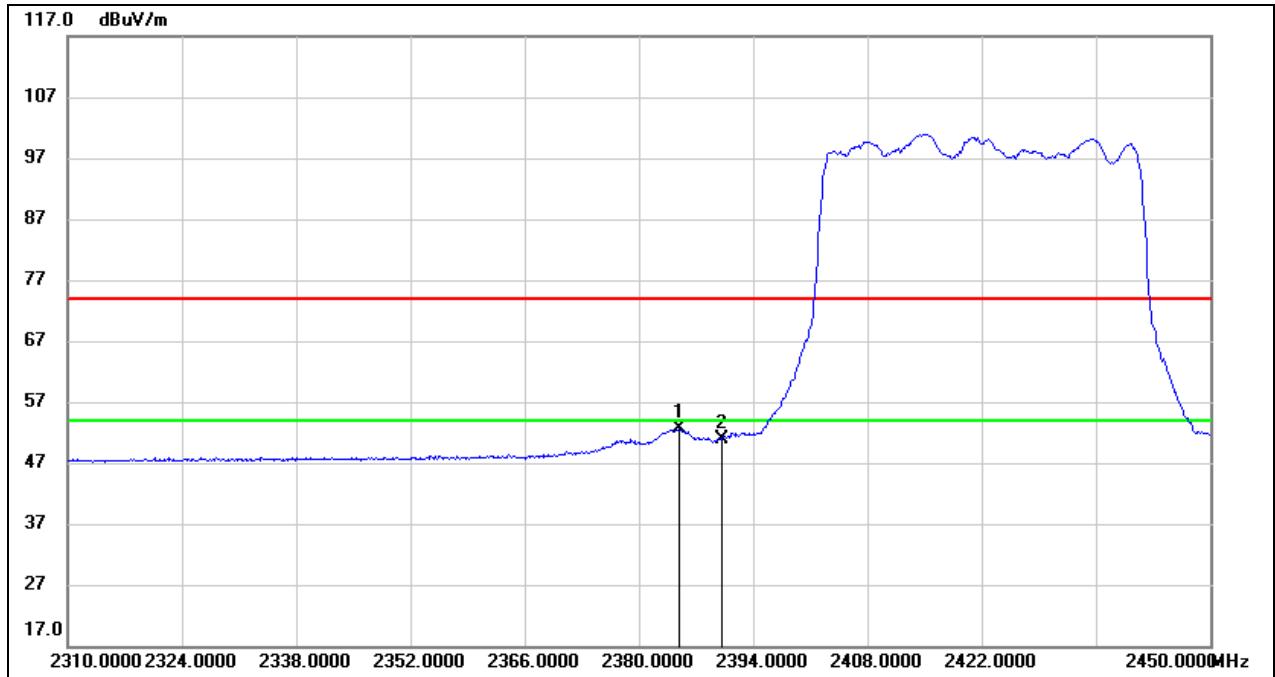

No.	Frequency (MHz)	Reading (dBuV)	Correct (dB/m)	Result (dBuV/m)	Limit (dBuV/m)	Margin (dB)	Remark
1	2384.900	20.45	32.14	52.59	54.00	-1.41	AVG
2	2390.000	18.84	32.16	51.00	54.00	-3.00	AVG



Test Mode:	802.11be EHT40 PK	Frequency(MHz):	2427
Polarity:	Horizontal	Test Voltage:	DC 12 V

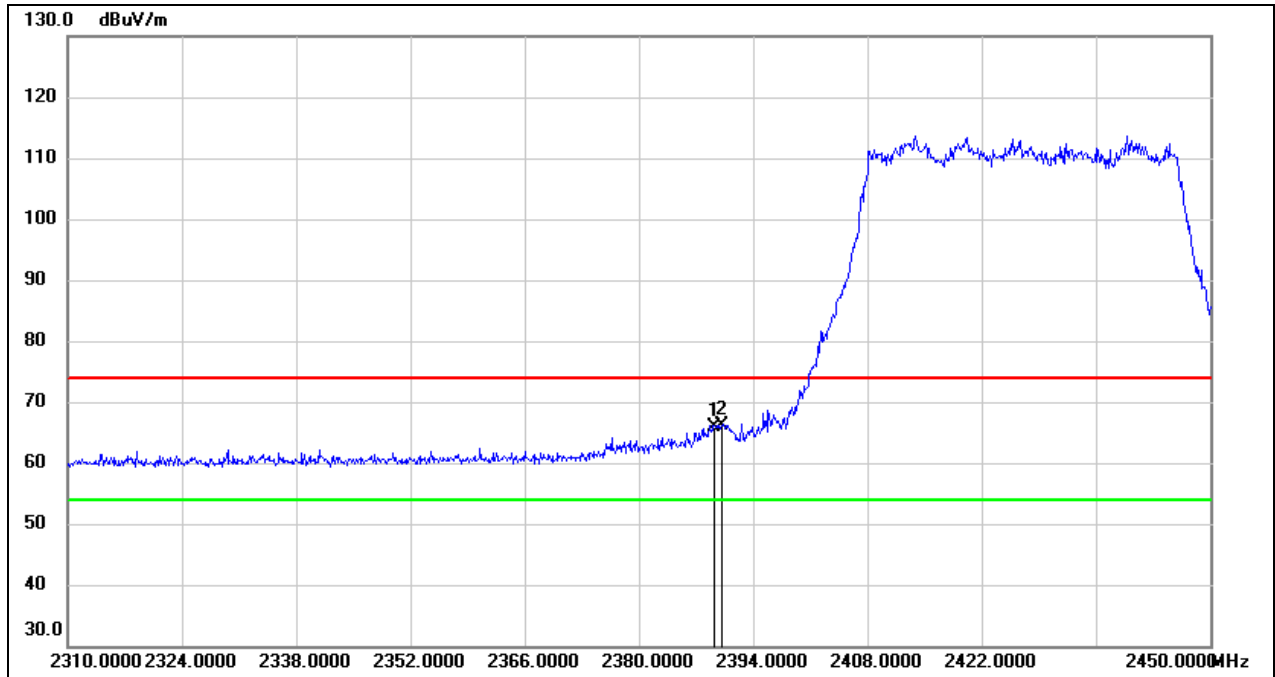

No.	Frequency (MHz)	Reading (dBuV)	Correct (dB/m)	Result (dBuV/m)	Limit (dBuV/m)	Margin (dB)	Remark
1	2389.380	33.80	32.16	65.96	74.00	-8.04	peak
2	2390.000	34.05	32.16	66.21	74.00	-7.79	peak

Test Mode:	802.11be EHT40 AV	Frequency(MHz):	2427
Polarity:	Horizontal	Test Voltage:	DC 12 V

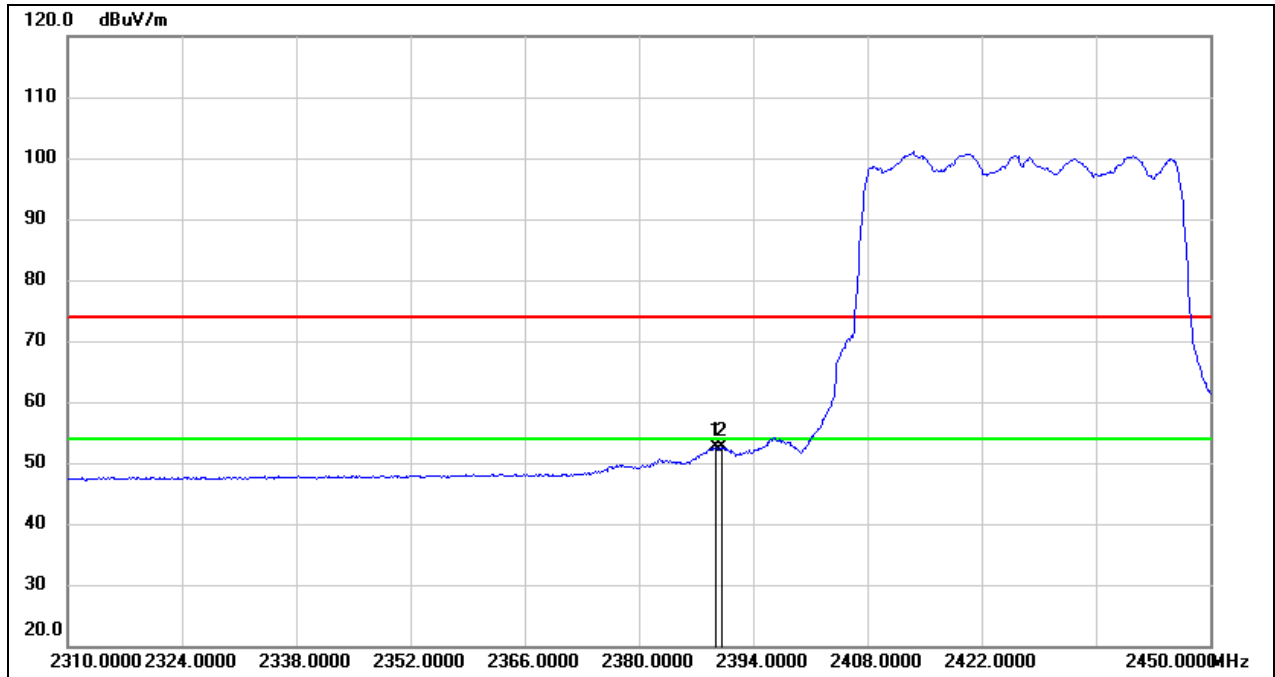

No.	Frequency (MHz)	Reading (dBuV)	Correct (dB/m)	Result (dBuV/m)	Limit (dBuV/m)	Margin (dB)	Remark
1	2389.380	20.39	32.16	52.55	54.00	-1.45	AVG
2	2390.000	20.38	32.16	52.54	54.00	-1.46	AVG

Test Mode:	802.11be EHT40 PK	Frequency(MHz):	2437
Polarity:	Horizontal	Test Voltage:	DC 12 V

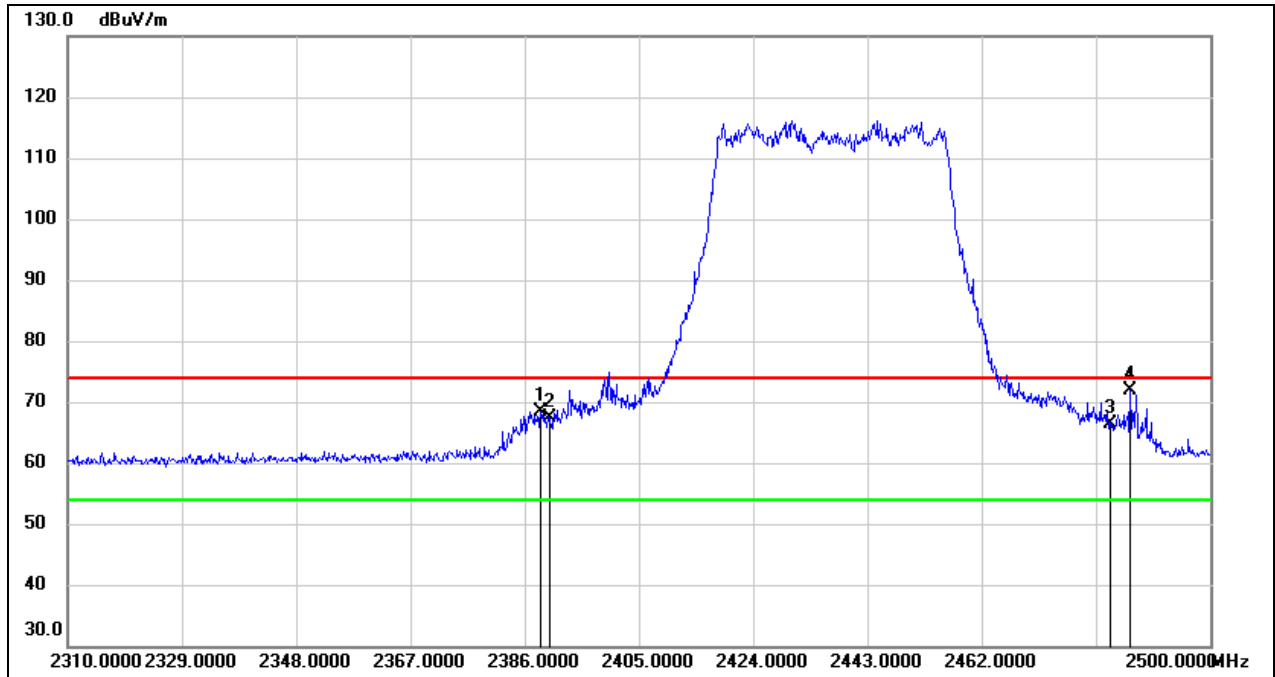

No.	Frequency (MHz)	Reading (dBuV)	Correct (dB/m)	Result (dBuV/m)	Limit (dBuV/m)	Margin (dB)	Remark
1	2388.660	36.19	32.16	68.35	74.00	-5.65	peak
2	2390.000	35.28	32.16	67.44	74.00	-6.56	peak
3	2483.500	33.94	32.44	66.38	74.00	-7.62	peak
4	2486.700	39.53	32.45	71.98	74.00	-2.02	peak

Test Mode:	802.11be EHT40 AV	Frequency(MHz):	2437
Polarity:	Horizontal	Test Voltage:	DC 12 V

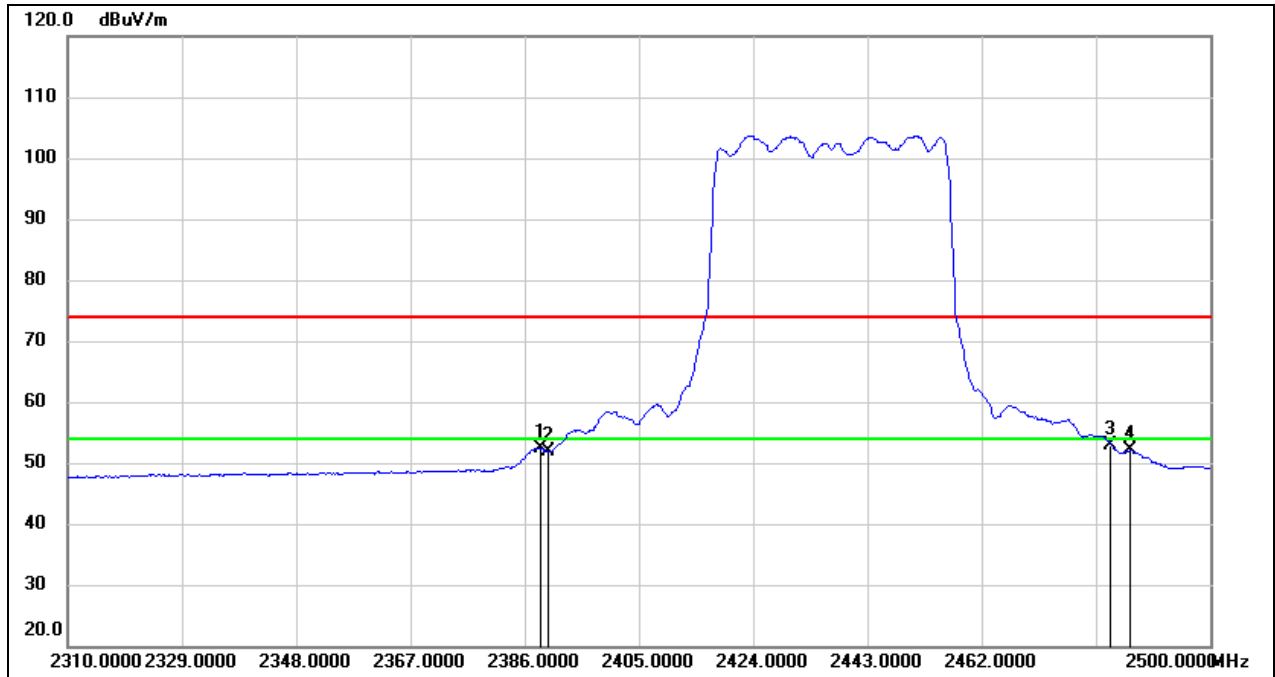

No.	Frequency (MHz)	Reading (dBuV)	Correct (dB/m)	Result (dBuV/m)	Limit (dBuV/m)	Margin (dB)	Remark
1	2388.660	20.30	32.16	52.46	54.00	-1.54	AVG
2	2390.000	19.66	32.16	51.82	54.00	-2.18	AVG
3	2483.500	20.33	32.44	52.77	54.00	-1.23	AVG
4	2486.700	19.59	32.45	52.04	54.00	-1.96	AVG

Test Mode:	802.11be EHT40 PK	Frequency(MHz):	2447
Polarity:	Horizontal	Test Voltage:	DC 12 V

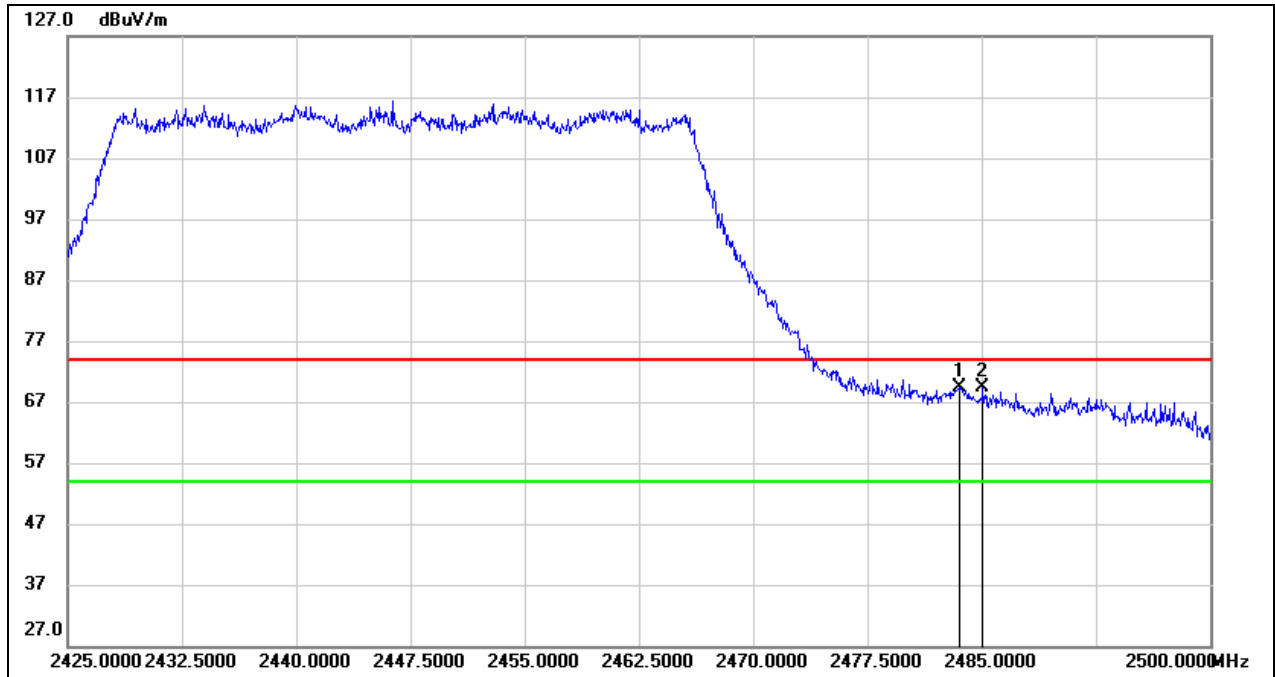

No.	Frequency (MHz)	Reading (dBuV)	Correct (dB/m)	Result (dBuV/m)	Limit (dBuV/m)	Margin (dB)	Remark
1	2483.500	36.95	32.44	69.39	74.00	-4.61	peak
2	2485.075	36.83	32.44	69.27	74.00	-4.73	peak

Test Mode:	802.11be EHT40 AV	Frequency(MHz):	2447
Polarity:	Horizontal	Test Voltage:	DC 12 V

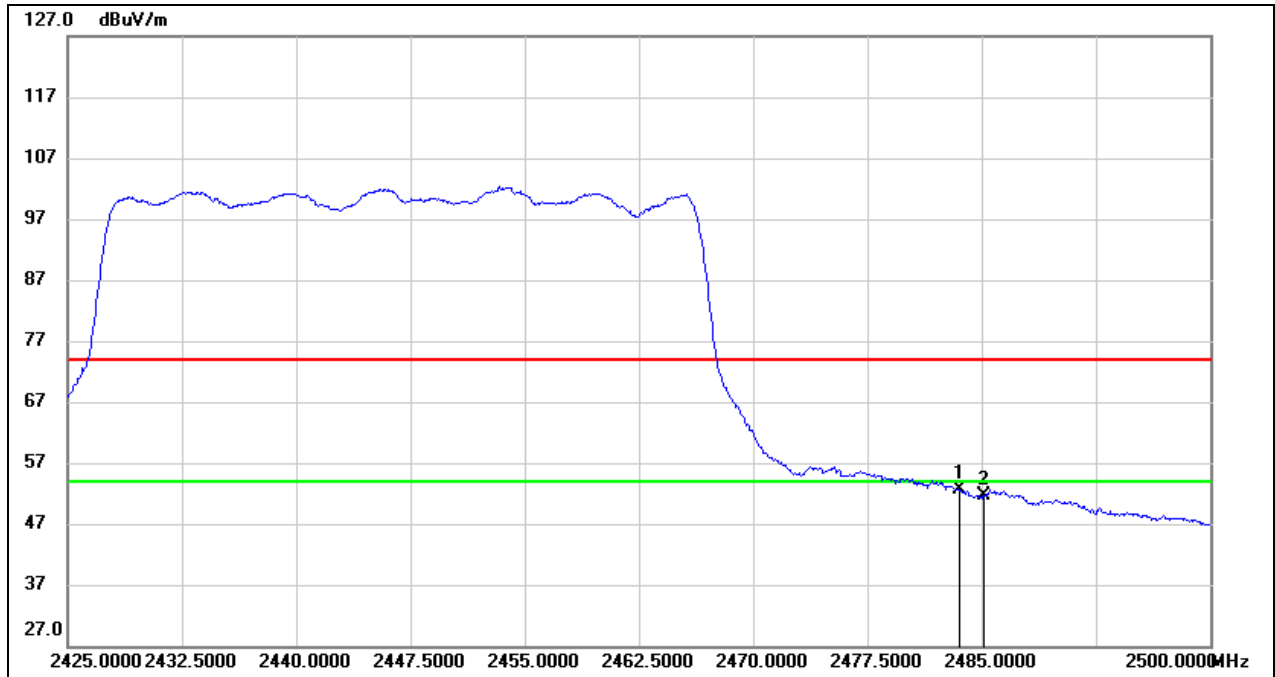

No.	Frequency (MHz)	Reading (dBuV)	Correct (dB/m)	Result (dBuV/m)	Limit (dBuV/m)	Margin (dB)	Remark
1	2483.500	20.22	32.44	52.66	54.00	-1.34	AVG
2	2485.075	19.22	32.44	51.66	54.00	-2.34	AVG

Test Mode:	802.11be EHT40 PK	Frequency(MHz):	2452
Polarity:	Horizontal	Test Voltage:	DC 12 V

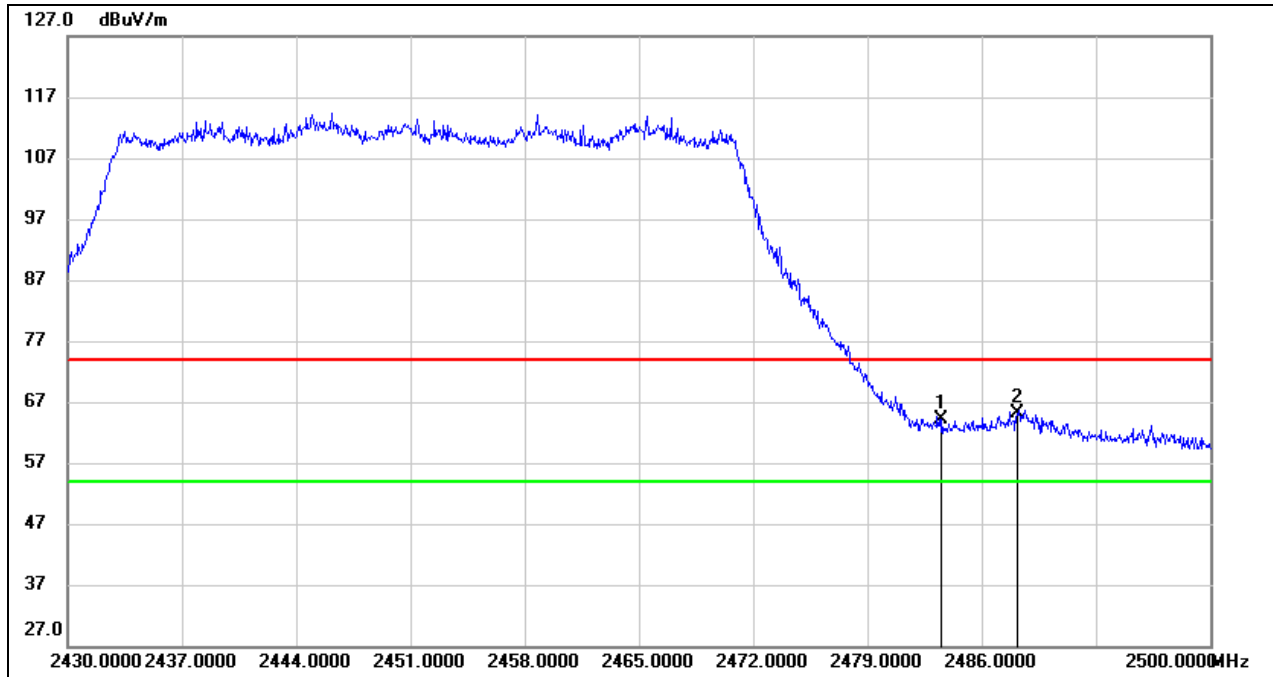

No.	Frequency (MHz)	Reading (dBuV)	Correct (dB/m)	Result (dBuV/m)	Limit (dBuV/m)	Margin (dB)	Remark
1	2483.500	31.57	32.44	64.01	74.00	-9.99	peak
2	2488.170	32.77	32.46	65.23	74.00	-8.77	peak

Test Mode:	802.11be EHT40 AV	Frequency(MHz):	2452
Polarity:	Horizontal	Test Voltage:	DC 12 V

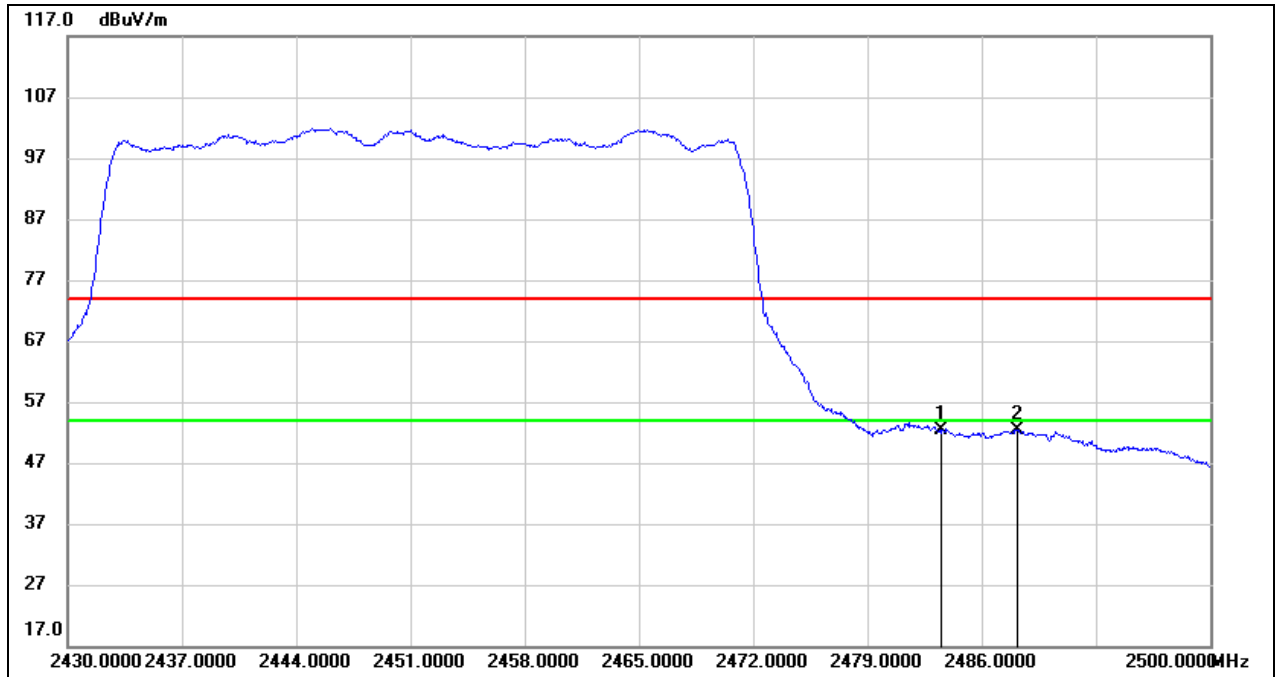

No.	Frequency (MHz)	Reading (dBuV)	Correct (dB/m)	Result (dBuV/m)	Limit (dBuV/m)	Margin (dB)	Remark
1	2483.500	19.87	32.44	52.31	54.00	-1.69	AVG
2	2488.170	19.88	32.46	52.34	54.00	-1.66	AVG



## 8.2. SPURIOUS EMISSIONS(1 GHZ~3 GHZ)

Test Mode:	802.11b	Frequency(MHz):	2412
Polarity:	Horizontal	Test Voltage:	DC 12 V

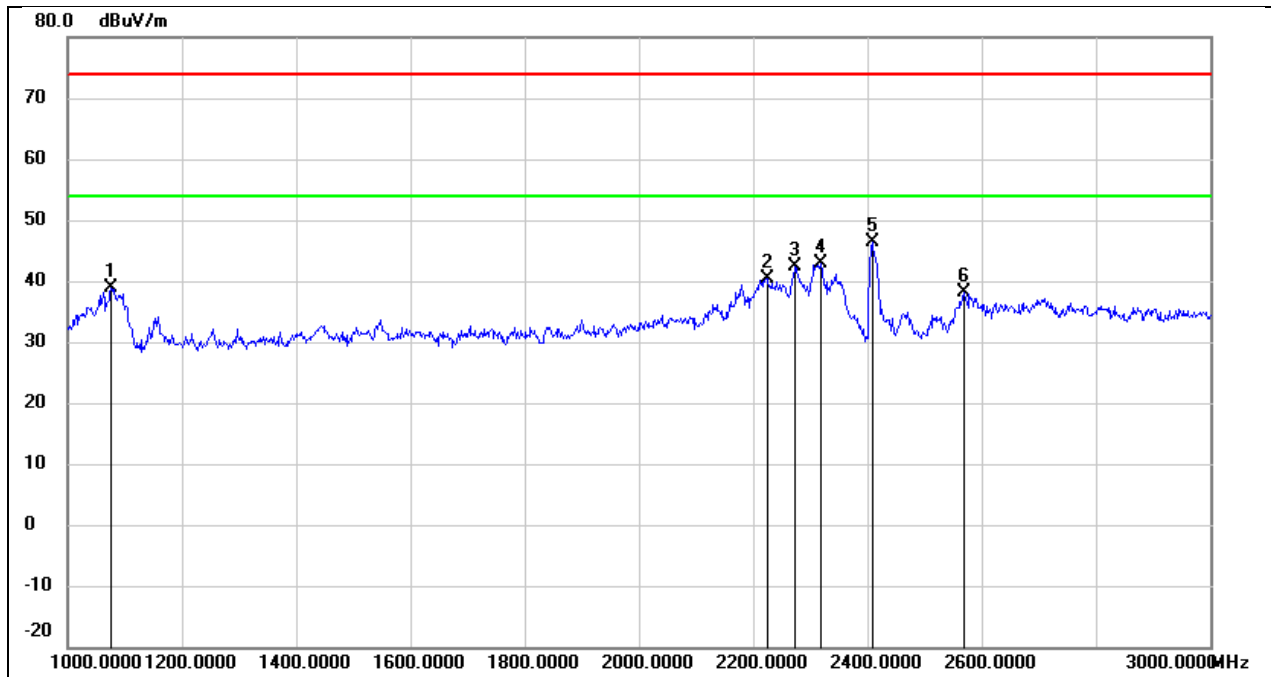

No.	Frequency (MHz)	Reading (dBuV)	Correct (dB/m)	Result (dBuV/m)	Limit (dBuV/m)	Margin (dB)	Remark
1	1076.000	53.65	-14.68	38.97	74.00	-35.03	peak
2	2224.000	50.27	-9.91	40.36	74.00	-33.64	peak
3	2274.000	52.07	-9.66	42.41	74.00	-31.59	peak
4	2318.000	52.24	-9.42	42.82	74.00	-31.18	peak
5	2408.000	55.31	-8.96	46.35	74.00	-27.65	peak
6	2568.000	46.36	-8.28	38.08	74.00	-35.92	peak

Test Mode:	802.11b	Frequency(MHz):	2412
Polarity:	Vertical	Test Voltage:	DC 12 V

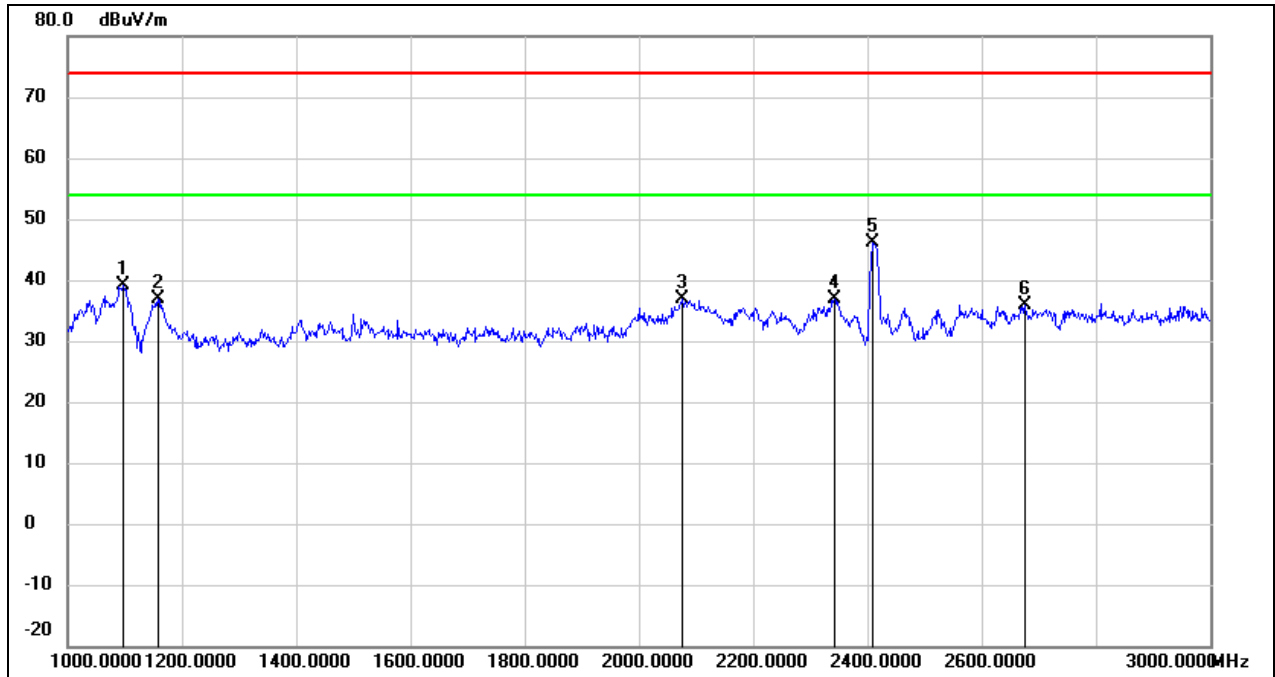

No.	Frequency (MHz)	Reading (dBuV)	Correct (dB/m)	Result (dBuV/m)	Limit (dBuV/m)	Margin (dB)	Remark
1	1098.000	53.65	-14.58	39.07	74.00	-34.93	peak
2	1158.000	51.20	-14.29	36.91	74.00	-37.09	peak
3	2076.000	47.52	-10.67	36.85	74.00	-37.15	peak
4	2342.000	46.26	-9.30	36.96	74.00	-37.04	peak
5	2408.000	55.01	-8.96	46.05	74.00	-27.95	peak
6	2676.000	43.79	-7.96	35.83	74.00	-38.17	peak

Test Mode:	802.11b	Frequency(MHz):	2437
Polarity:	Horizontal	Test Voltage:	DC 12 V

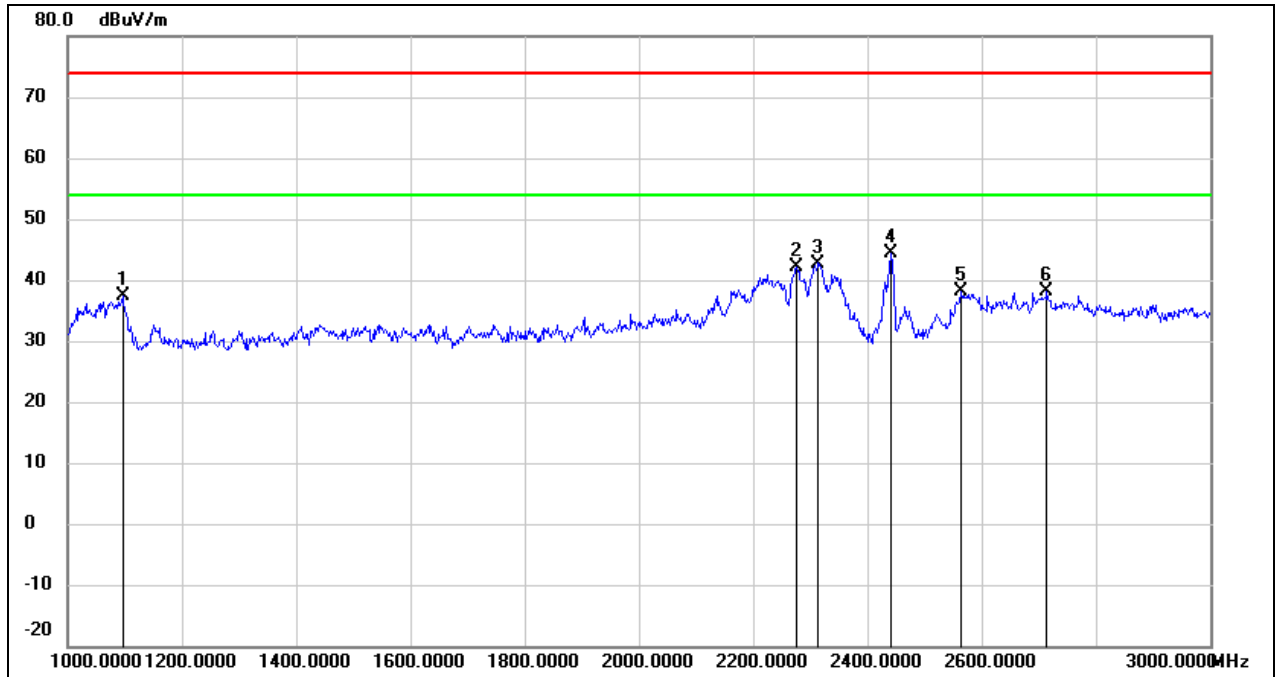

No.	Frequency (MHz)	Reading (dBuV)	Correct (dB/m)	Result (dBuV/m)	Limit (dBuV/m)	Margin (dB)	Remark
1	1096.000	51.88	-14.58	37.30	74.00	-36.70	peak
2	2276.000	51.79	-9.64	42.15	74.00	-31.85	peak
3	2314.000	52.19	-9.44	42.75	74.00	-31.25	peak
4	2442.000	53.09	-8.79	44.30	74.00	-29.70	peak
5	2564.000	46.40	-8.30	38.10	74.00	-35.90	peak
6	2714.000	45.88	-7.84	38.04	74.00	-35.96	peak

Test Mode:	802.11b	Frequency(MHz):	2437
Polarity:	Vertical	Test Voltage:	DC 12 V

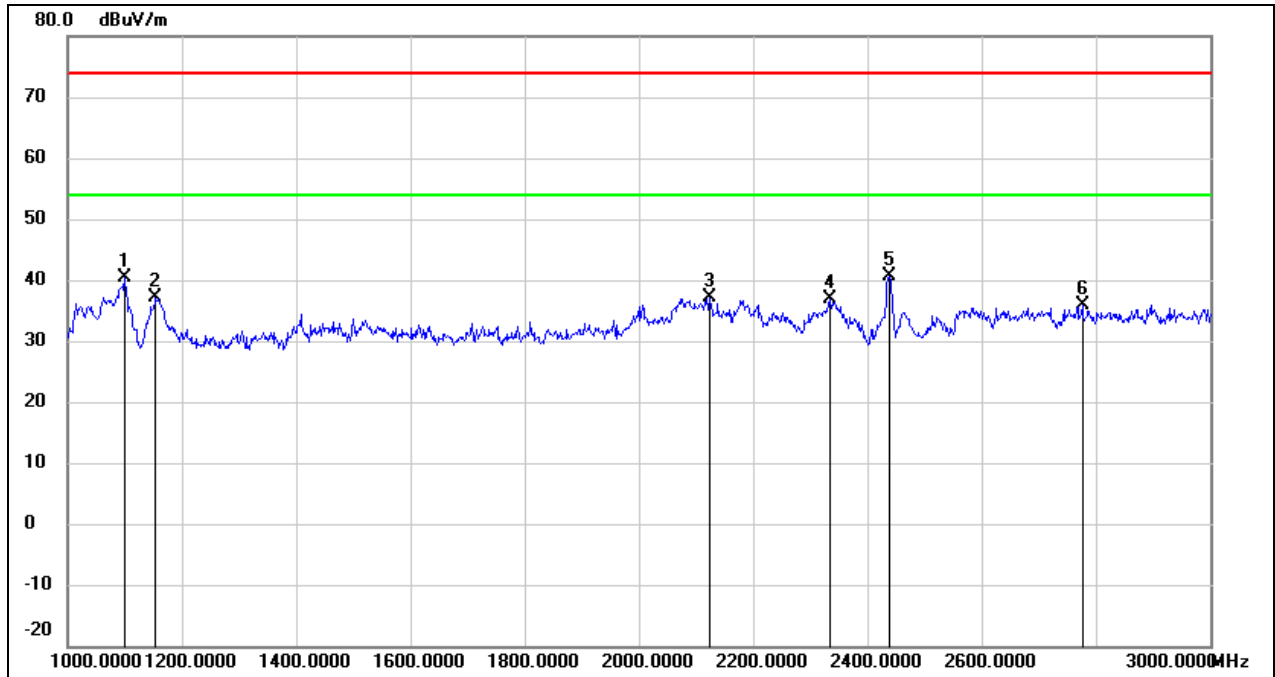

No.	Frequency (MHz)	Reading (dBuV)	Correct (dB/m)	Result (dBuV/m)	Limit (dBuV/m)	Margin (dB)	Remark
1	1100.000	54.95	-14.57	40.38	74.00	-33.62	peak
2	1154.000	51.48	-14.32	37.16	74.00	-36.84	peak
3	2124.000	47.55	-10.42	37.13	74.00	-36.87	peak
4	2334.000	46.27	-9.35	36.92	74.00	-37.08	peak
5	2438.000	49.35	-8.80	40.55	74.00	-33.45	peak
6	2776.000	43.45	-7.66	35.79	74.00	-38.21	peak

Test Mode:	802.11b	Frequency(MHz):	2462
Polarity:	Horizontal	Test Voltage:	DC 12 V

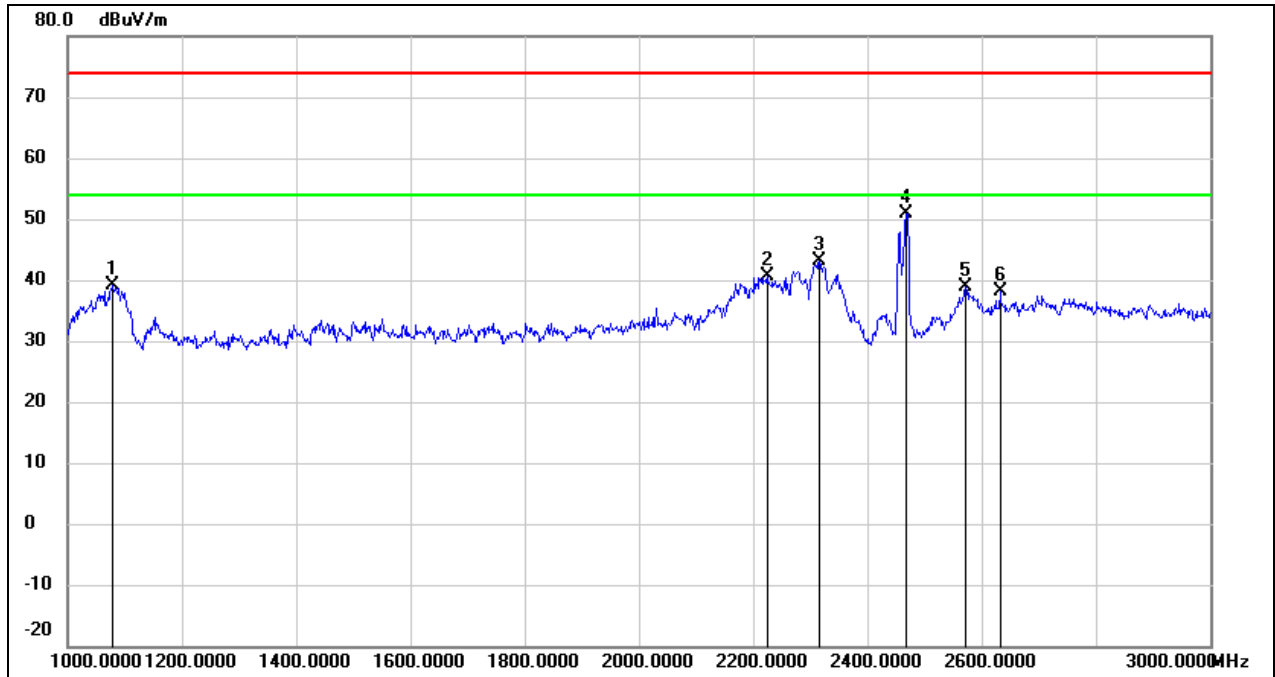

No.	Frequency (MHz)	Reading (dBuV)	Correct (dB/m)	Result (dBuV/m)	Limit (dBuV/m)	Margin (dB)	Remark
1	1078.000	53.70	-14.66	39.04	74.00	-34.96	peak
2	2224.000	50.57	-9.91	40.66	74.00	-33.34	peak
3	2316.000	52.53	-9.44	43.09	74.00	-30.91	peak
4	2468.000	59.58	-8.65	50.93	74.00	-23.07	peak
5	2572.000	47.13	-8.27	38.86	74.00	-35.14	peak
6	2632.000	46.34	-8.09	38.25	74.00	-35.75	peak

Test Mode:	802.11b	Frequency(MHz):	2462
Polarity:	Vertical	Test Voltage:	DC 12 V

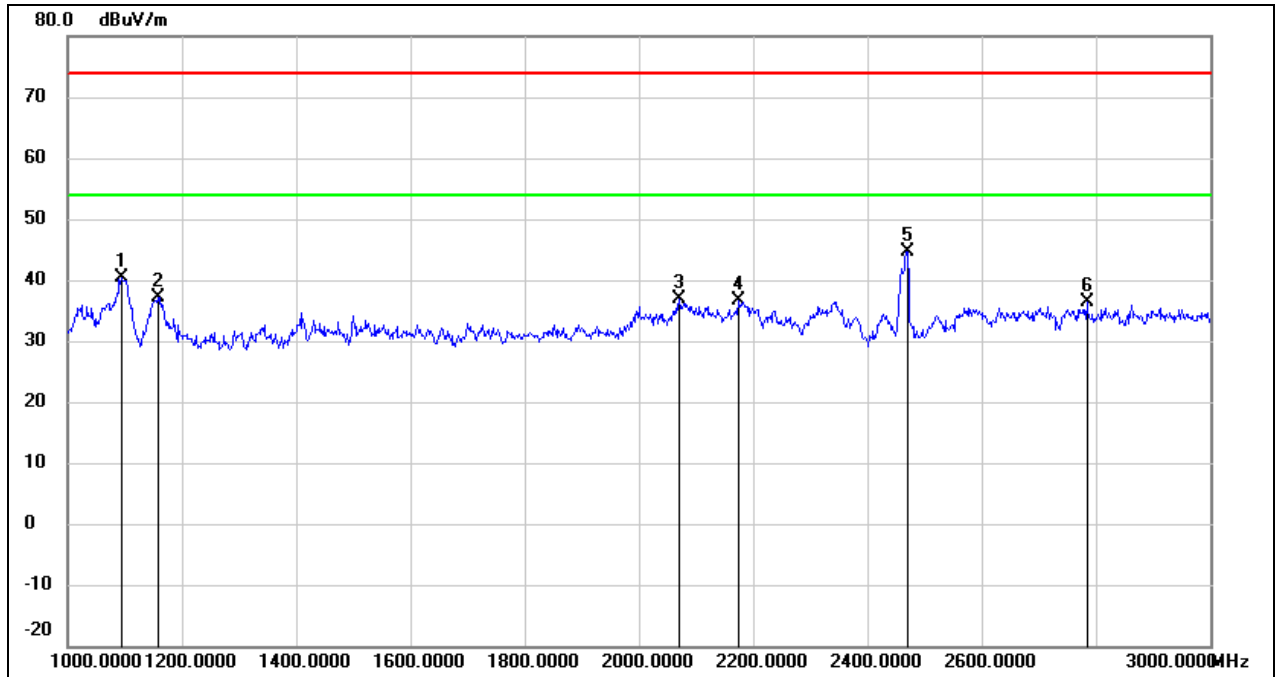

No.	Frequency (MHz)	Reading (dBuV)	Correct (dB/m)	Result (dBuV/m)	Limit (dBuV/m)	Margin (dB)	Remark
1	1094.000	54.89	-14.59	40.30	74.00	-33.70	peak
2	1158.000	51.36	-14.29	37.07	74.00	-36.93	peak
3	2070.000	47.47	-10.70	36.77	74.00	-37.23	peak
4	2174.000	46.80	-10.17	36.63	74.00	-37.37	peak
5	2470.000	53.31	-8.65	44.66	74.00	-29.34	peak
6	2784.000	43.96	-7.63	36.33	74.00	-37.67	peak

### 8.3. SPURIOUS EMISSIONS(3 GHZ~18 GHZ)

Test Mode:	802.11b	Frequency(MHz):	2412
Polarity:	Horizontal	Test Voltage:	DC 12 V

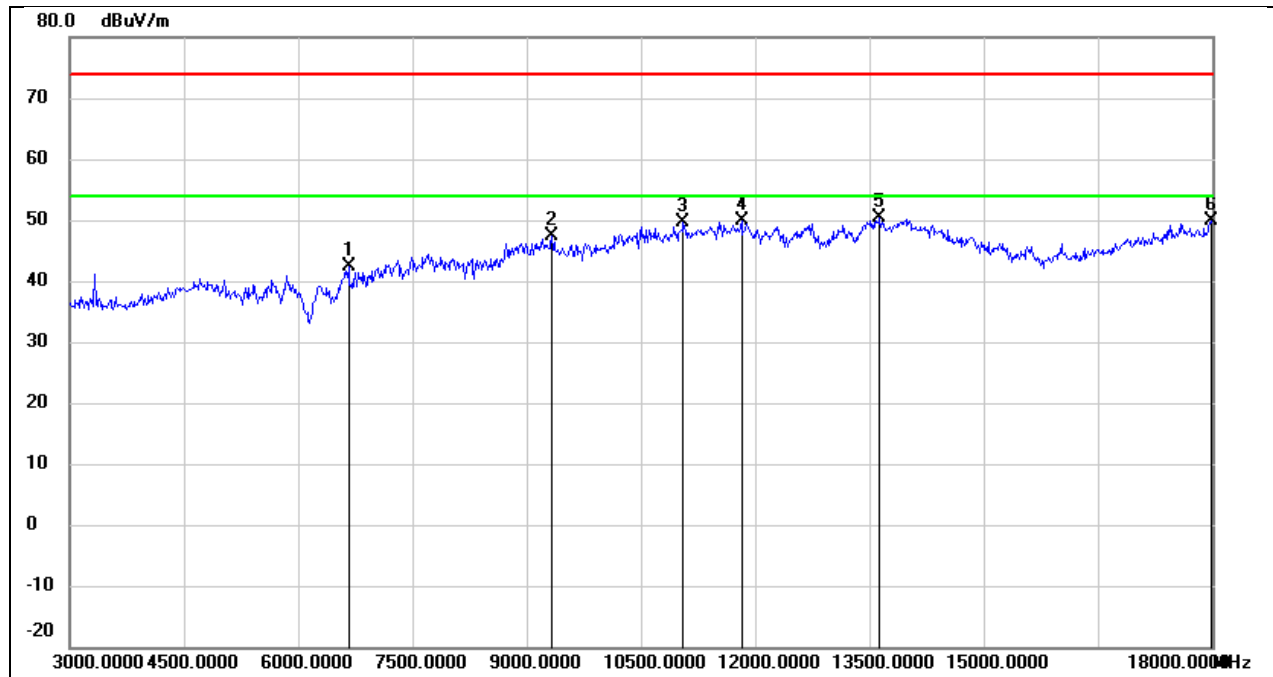

No.	Frequency (MHz)	Reading (dBuV)	Correct (dB/m)	Result (dBuV/m)	Limit (dBuV/m)	Margin (dB)	Remark
1	6660.000	37.34	5.02	42.36	74.00	-31.64	peak
2	9330.000	36.86	10.62	47.48	74.00	-26.52	peak
3	11055.000	34.74	14.96	49.70	74.00	-24.30	peak
4	11820.000	32.31	17.47	49.78	74.00	-24.22	peak
5	13635.000	29.22	21.19	50.41	74.00	-23.59	peak
6	17985.000	24.38	25.60	49.98	74.00	-24.02	peak

Test Mode:	802.11b	Frequency(MHz):	2412
Polarity:	Vertical	Test Voltage:	DC 12 V

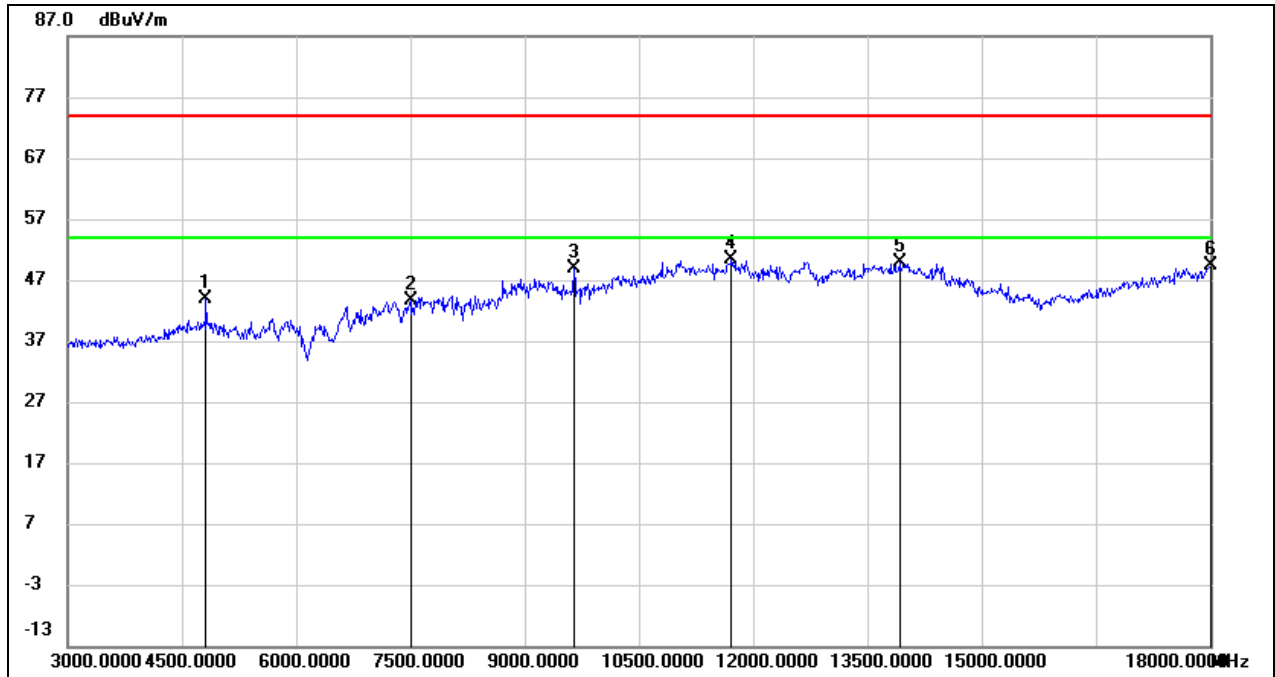

No.	Frequency (MHz)	Reading (dBuV)	Correct (dB/m)	Result (dBuV/m)	Limit (dBuV/m)	Margin (dB)	Remark
1	4815.000	44.06	-0.26	43.80	74.00	-30.20	peak
2	7500.000	37.18	6.33	43.51	74.00	-30.49	peak
3	9645.000	37.76	11.08	48.84	74.00	-25.16	peak
4	11715.000	33.16	17.19	50.35	74.00	-23.65	peak
5	13920.000	28.09	21.79	49.88	74.00	-24.12	peak
6	18000.000	23.64	25.69	49.33	74.00	-24.67	peak



Test Mode:	802.11b	Frequency(MHz):	2437
Polarity:	Horizontal	Test Voltage:	DC 12 V

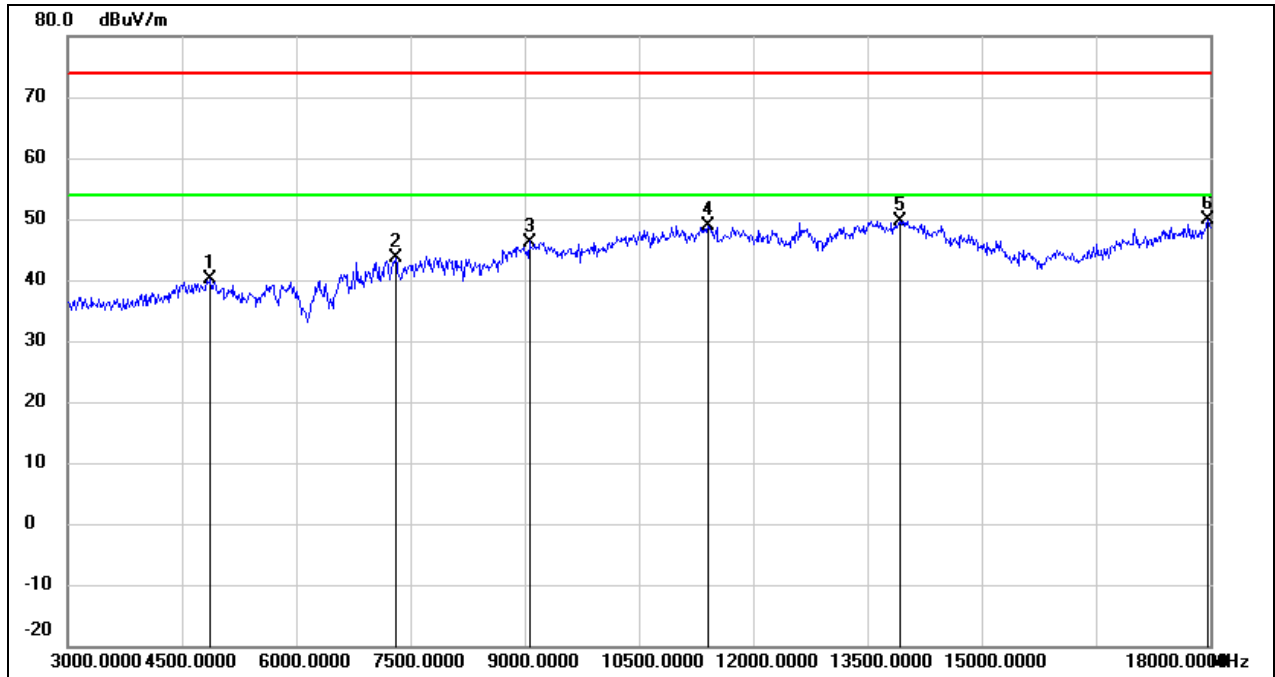

No.	Frequency (MHz)	Reading (dBuV)	Correct (dB/m)	Result (dBuV/m)	Limit (dBuV/m)	Margin (dB)	Remark
1	4875.000	40.09	-0.03	40.06	74.00	-33.94	peak
2	7305.000	37.23	6.47	43.70	74.00	-30.30	peak
3	9060.000	35.74	10.51	46.25	74.00	-27.75	peak
4	11415.000	32.64	16.29	48.93	74.00	-25.07	peak
5	13935.000	27.78	21.82	49.60	74.00	-24.40	peak
6	17970.000	24.30	25.51	49.81	74.00	-24.19	peak

Test Mode:	802.11b	Frequency(MHz):	2437
Polarity:	Vertical	Test Voltage:	DC 12 V

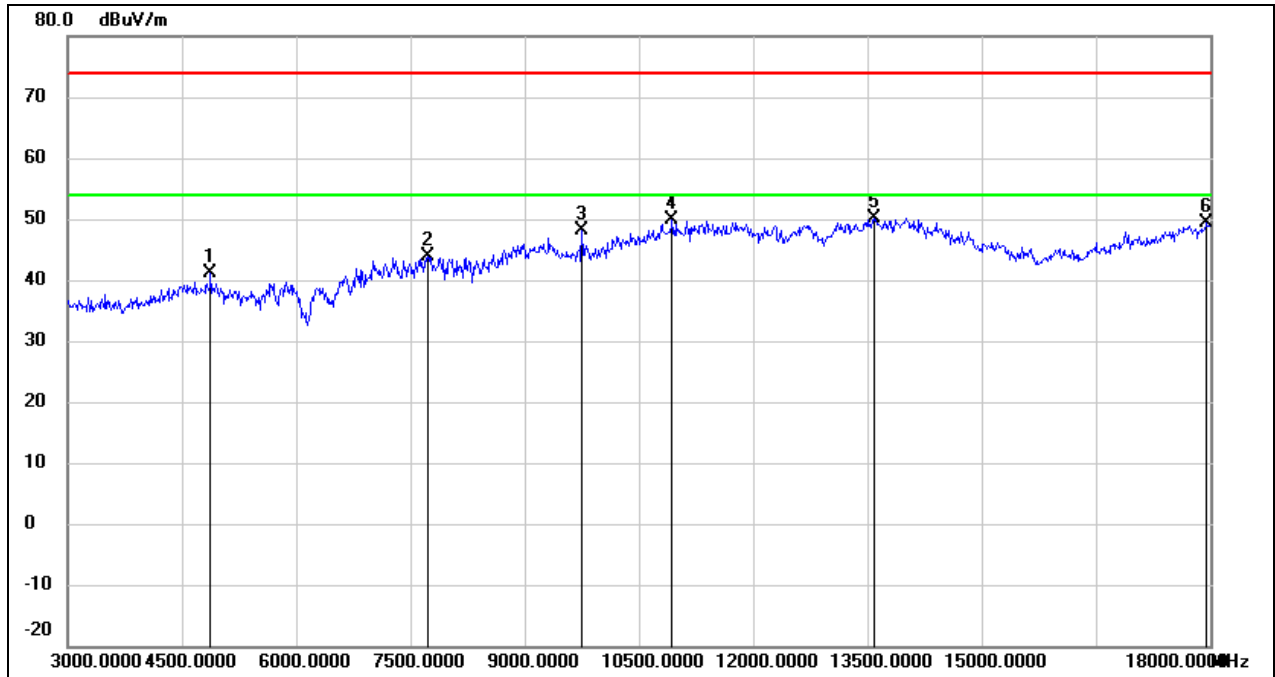

No.	Frequency (MHz)	Reading (dBuV)	Correct (dB/m)	Result (dBuV/m)	Limit (dBuV/m)	Margin (dB)	Remark
1	4875.000	41.23	-0.03	41.20	74.00	-32.80	peak
2	7725.000	37.58	6.32	43.90	74.00	-30.10	peak
3	9750.000	36.70	11.35	48.05	74.00	-25.95	peak
4	10935.000	35.37	14.54	49.91	74.00	-24.09	peak
5	13590.000	29.14	21.09	50.23	74.00	-23.77	peak
6	17955.000	23.93	25.42	49.35	74.00	-24.65	peak

Test Mode:	802.11b	Frequency(MHz):	2462
Polarity:	Horizontal	Test Voltage:	DC 12 V

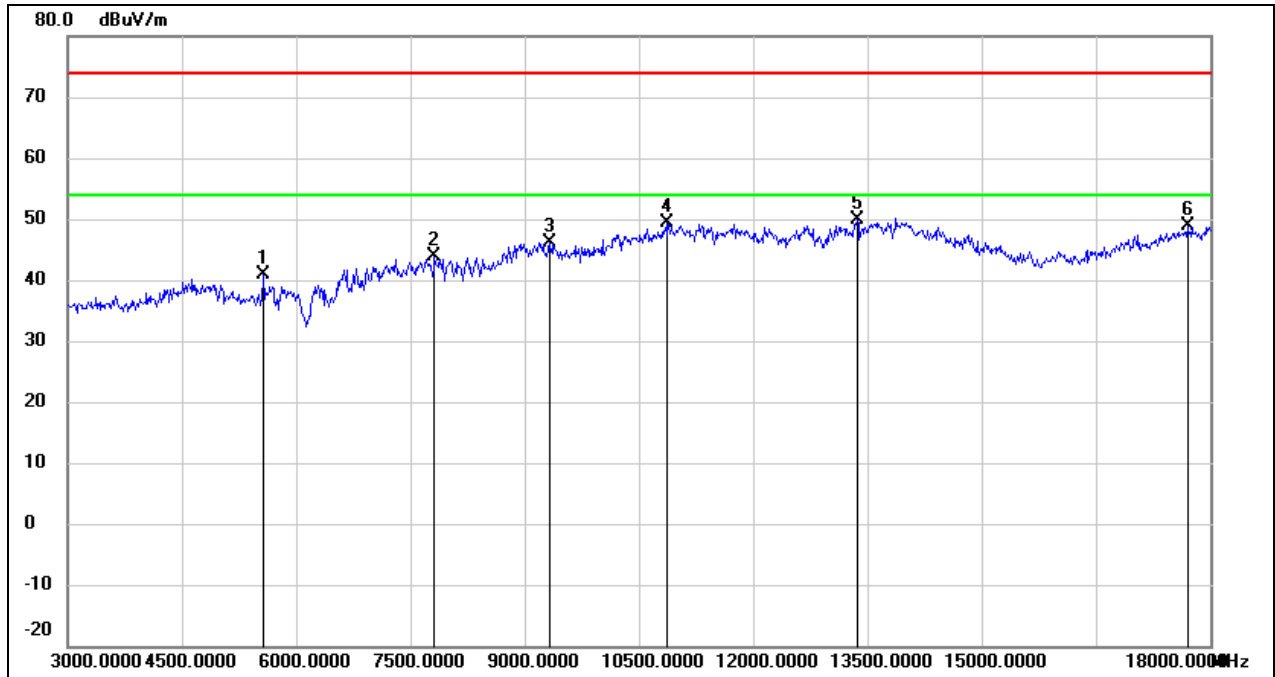

No.	Frequency (MHz)	Reading (dBuV)	Correct (dB/m)	Result (dBuV/m)	Limit (dBuV/m)	Margin (dB)	Remark
1	5565.000	39.90	1.04	40.94	74.00	-33.06	peak
2	7815.000	37.62	6.32	43.94	74.00	-30.06	peak
3	9330.000	35.57	10.62	46.19	74.00	-27.81	peak
4	10875.000	35.01	14.32	49.33	74.00	-24.67	peak
5	13365.000	29.56	20.31	49.87	74.00	-24.13	peak
6	17700.000	24.95	23.91	48.86	74.00	-25.14	peak

Test Mode:	802.11b	Frequency(MHz):	2462
Polarity:	Vertical	Test Voltage:	DC 12 V

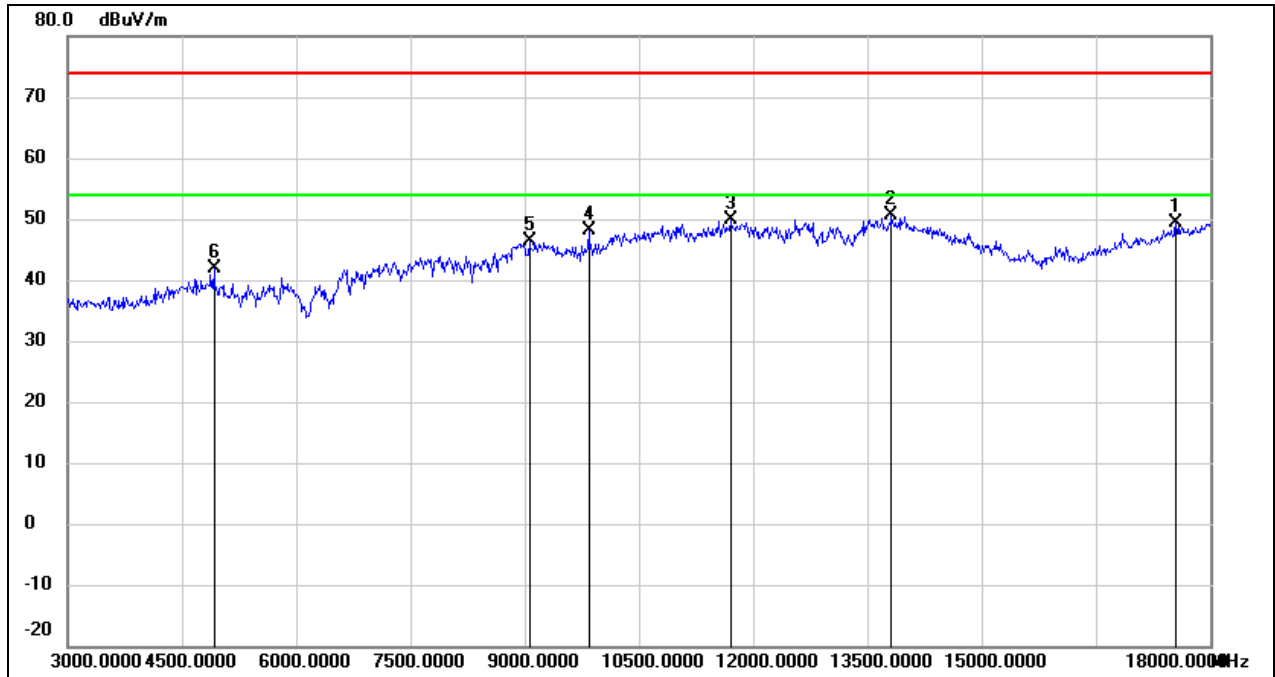

No.	Frequency (MHz)	Reading (dBuV)	Correct (dB/m)	Result (dBuV/m)	Limit (dBuV/m)	Margin (dB)	Remark
1	17550.000	26.41	23.03	49.44	74.00	-24.56	peak
2	13815.000	28.96	21.56	50.52	74.00	-23.48	peak
3	11700.000	32.67	17.14	49.81	74.00	-24.19	peak
4	9840.000	36.53	11.59	48.12	74.00	-25.88	peak
5	9060.000	35.83	10.51	46.34	74.00	-27.66	peak
6	4920.000	41.84	0.14	41.98	74.00	-32.02	peak

Test Mode:	802.11g	Frequency(MHz):	2412
Polarity:	Horizontal	Test Voltage:	DC 12 V

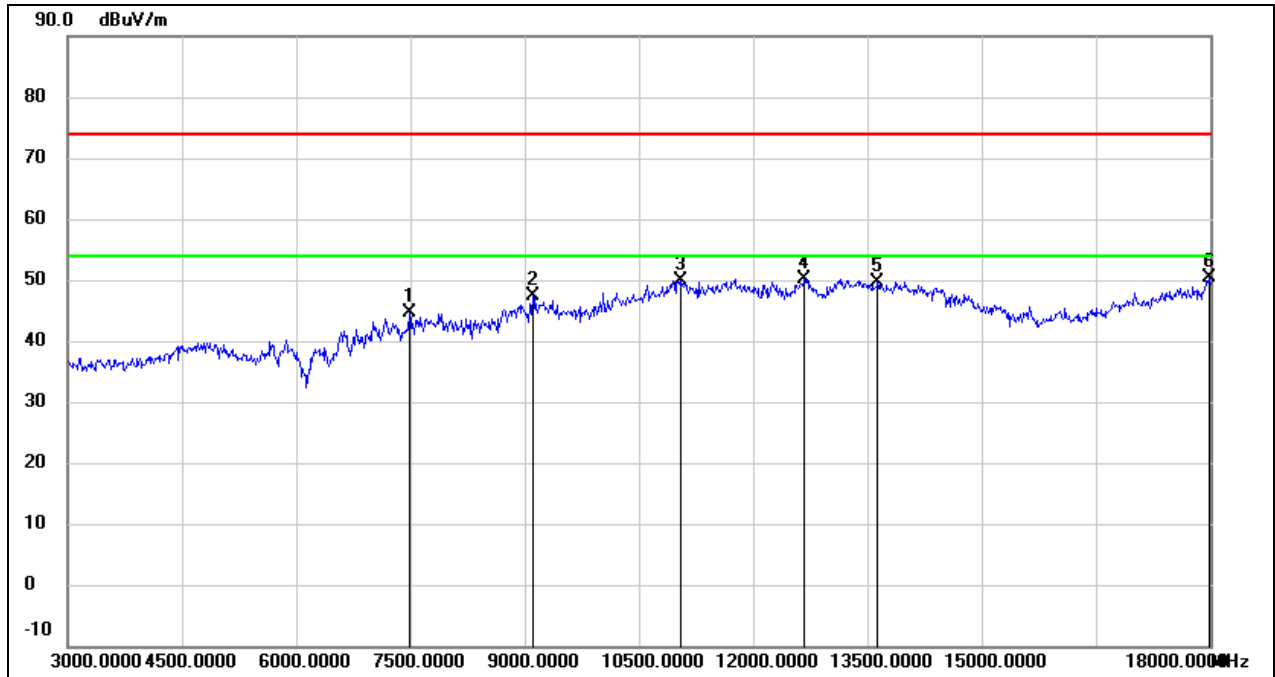

No.	Frequency (MHz)	Reading (dBuV)	Correct (dB/m)	Result (dBuV/m)	Limit (dBuV/m)	Margin (dB)	Remark
1	7485.000	38.29	6.34	44.63	74.00	-29.37	peak
2	9105.000	36.80	10.53	47.33	74.00	-26.67	peak
3	11055.000	34.87	14.96	49.83	74.00	-24.17	peak
4	12675.000	32.25	17.99	50.24	74.00	-23.76	peak
5	13635.000	28.56	21.19	49.75	74.00	-24.25	peak
6	17985.000	24.74	25.60	50.34	74.00	-23.66	peak

Test Mode:	802.11g	Frequency(MHz):	2412
Polarity:	Vertical	Test Voltage:	DC 12 V

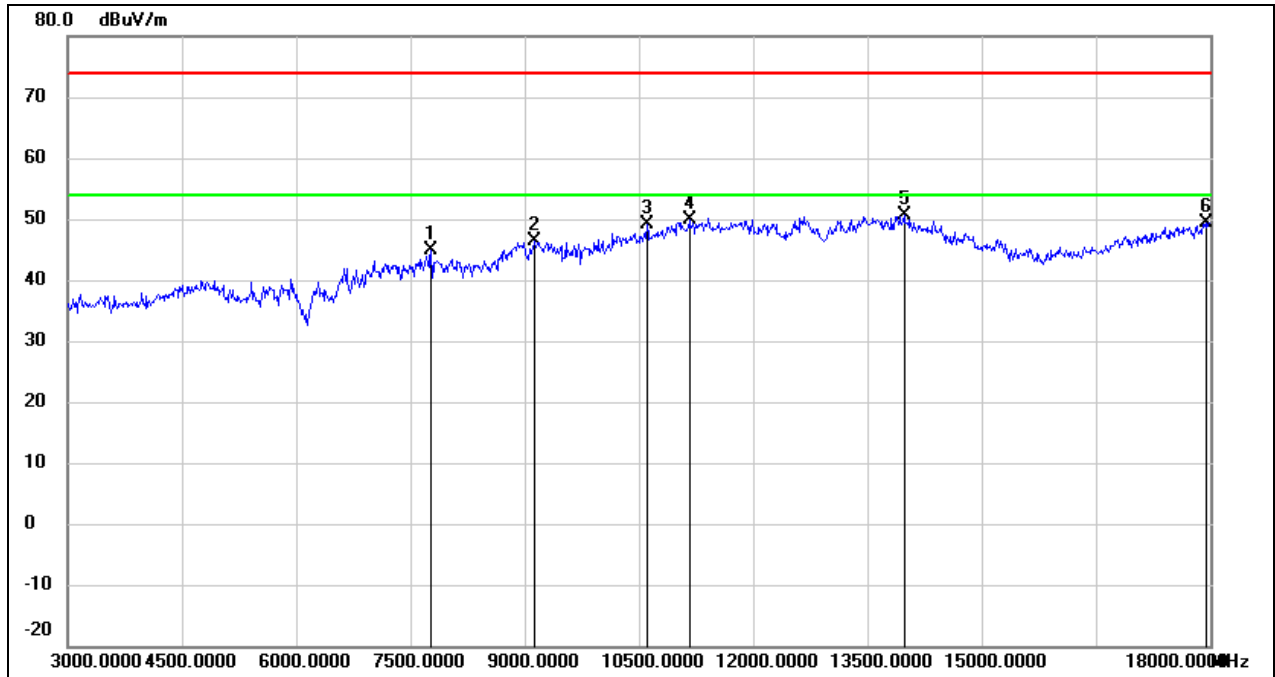

No.	Frequency (MHz)	Reading (dBuV)	Correct (dB/m)	Result (dBuV/m)	Limit (dBuV/m)	Margin (dB)	Remark
1	7770.000	38.59	6.31	44.90	74.00	-29.10	peak
2	9135.000	35.85	10.55	46.40	74.00	-27.60	peak
3	10605.000	35.81	13.37	49.18	74.00	-24.82	peak
4	11160.000	34.55	15.36	49.91	74.00	-24.09	peak
5	13980.000	28.77	21.92	50.69	74.00	-23.31	peak
6	17940.000	23.96	25.34	49.30	74.00	-24.70	peak

Test Mode:	802.11g	Frequency(MHz):	2437
Polarity:	Horizontal	Test Voltage:	DC 12 V

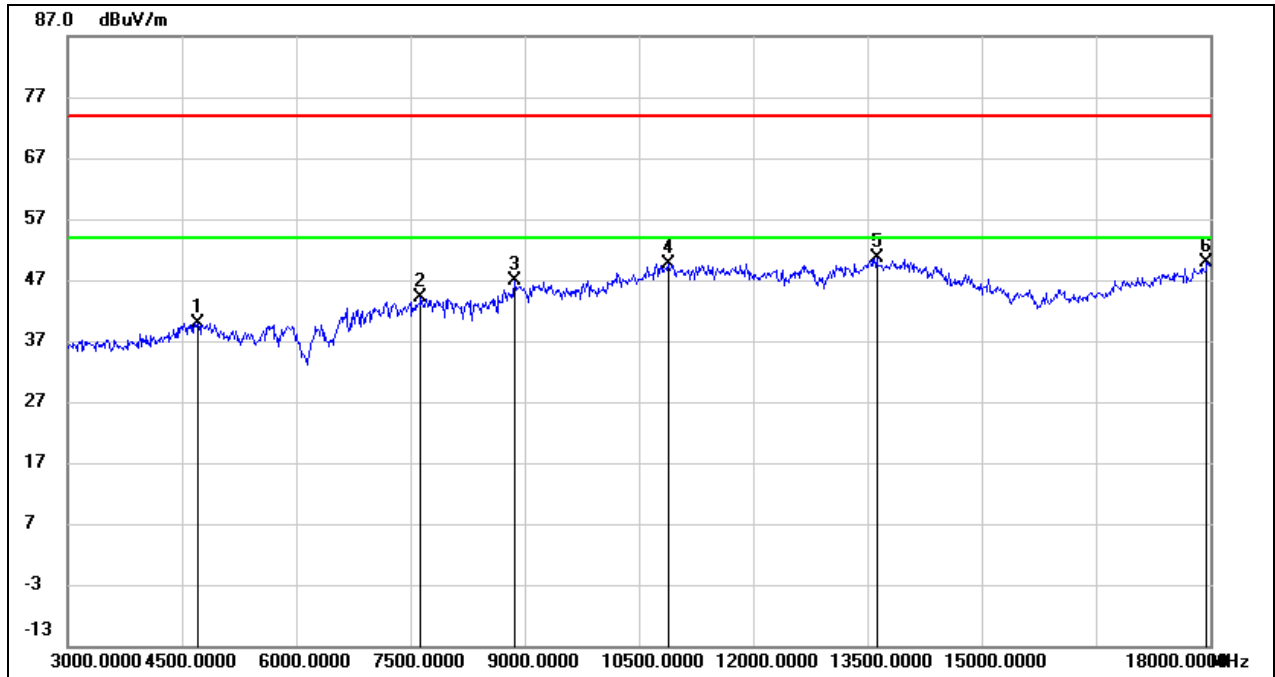

No.	Frequency (MHz)	Reading (dBuV)	Correct (dB/m)	Result (dBuV/m)	Limit (dBuV/m)	Margin (dB)	Remark
1	4710.000	40.64	-0.66	39.98	74.00	-34.02	peak
2	7635.000	37.84	6.33	44.17	74.00	-29.83	peak
3	8865.000	37.27	9.50	46.77	74.00	-27.23	peak
4	10890.000	35.34	14.39	49.73	74.00	-24.27	peak
5	13620.000	29.47	21.15	50.62	74.00	-23.38	peak
6	17955.000	24.48	25.42	49.90	74.00	-24.10	peak

Test Mode:	802.11g	Frequency(MHz):	2437
Polarity:	Vertical	Test Voltage:	DC 12 V

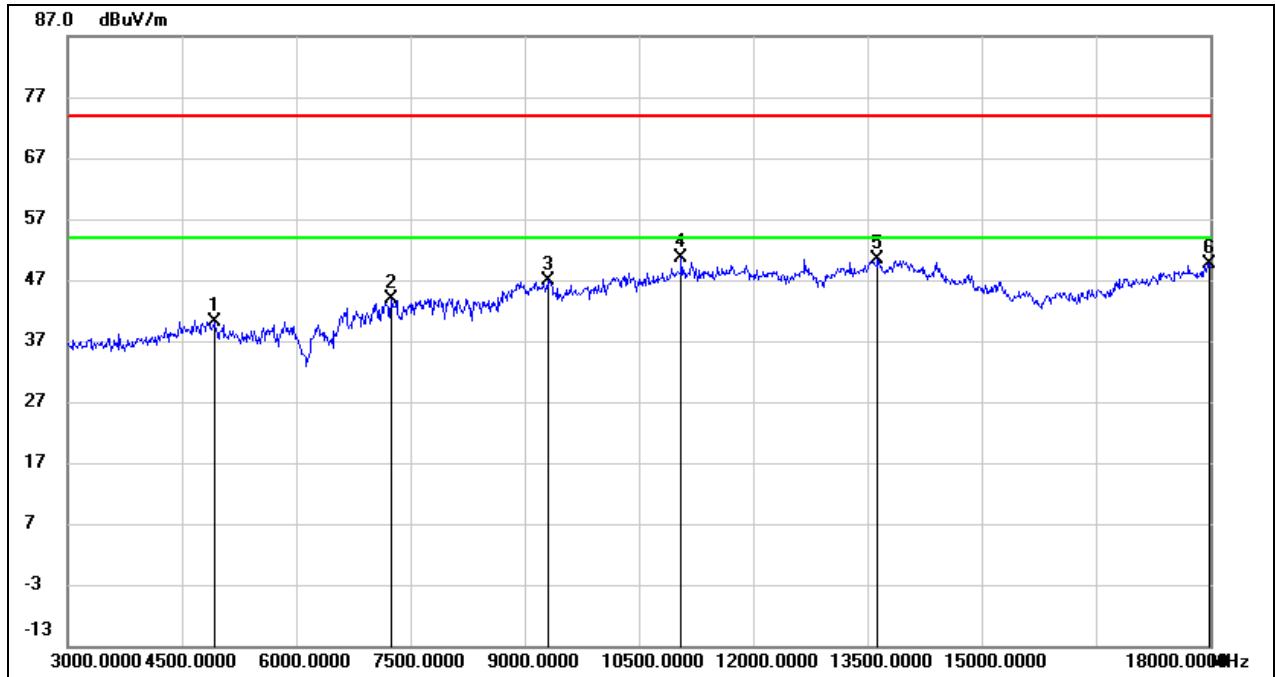

No.	Frequency (MHz)	Reading (dBuV)	Correct (dB/m)	Result (dBuV/m)	Limit (dBuV/m)	Margin (dB)	Remark
1	4920.000	40.08	0.14	40.22	74.00	-33.78	peak
2	7245.000	37.27	6.51	43.78	74.00	-30.22	peak
3	9300.000	36.17	10.61	46.78	74.00	-27.22	peak
4	11055.000	35.60	14.96	50.56	74.00	-23.44	peak
5	13635.000	29.11	21.19	50.30	74.00	-23.70	peak
6	17985.000	24.02	25.60	49.62	74.00	-24.38	peak



Test Mode:	802.11g	Frequency(MHz):	2457
Polarity:	Horizontal	Test Voltage:	DC 12 V

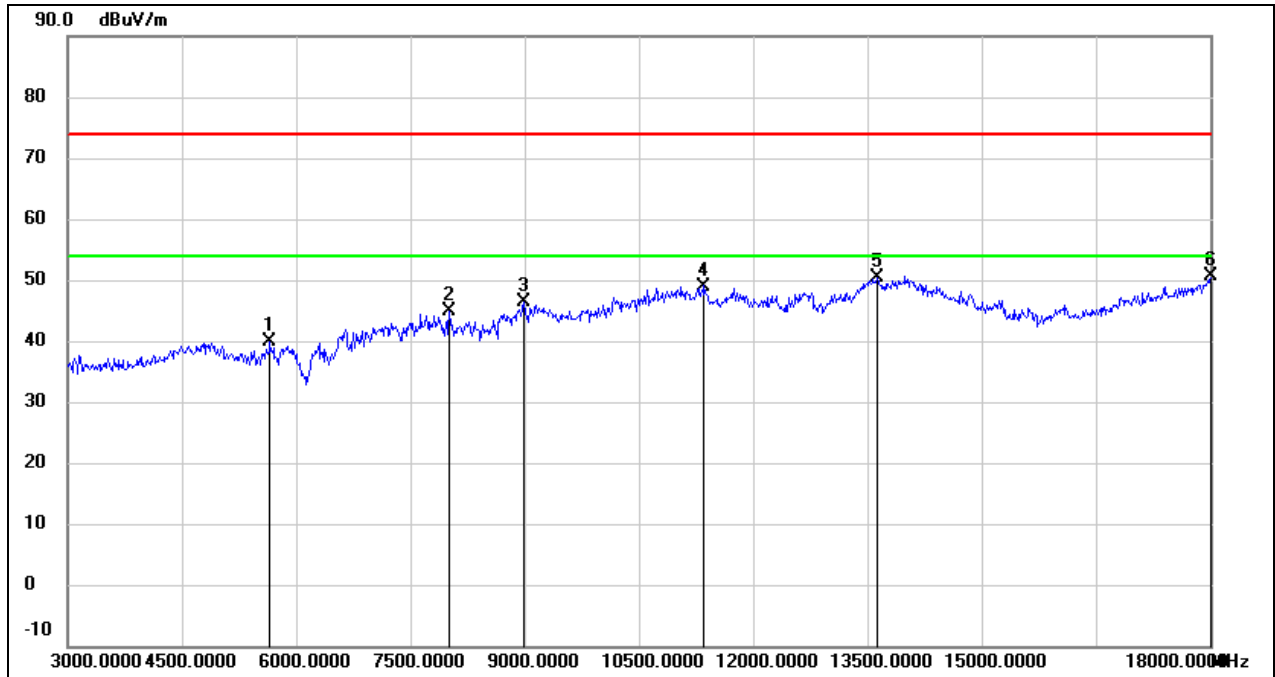

No.	Frequency (MHz)	Reading (dBuV)	Correct (dB/m)	Result (dBuV/m)	Limit (dBuV/m)	Margin (dB)	Remark
1	5655.000	38.66	1.29	39.95	74.00	-34.05	peak
2	8010.000	38.64	6.32	44.96	74.00	-29.04	peak
3	8985.000	36.02	10.37	46.39	74.00	-27.61	peak
4	11355.000	32.94	16.06	49.00	74.00	-25.00	peak
5	13620.000	29.29	21.15	50.44	74.00	-23.56	peak
6	18000.000	24.83	25.69	50.52	74.00	-23.48	peak

Test Mode:	802.11g	Frequency(MHz):	2457
Polarity:	Vertical	Test Voltage:	DC 12 V

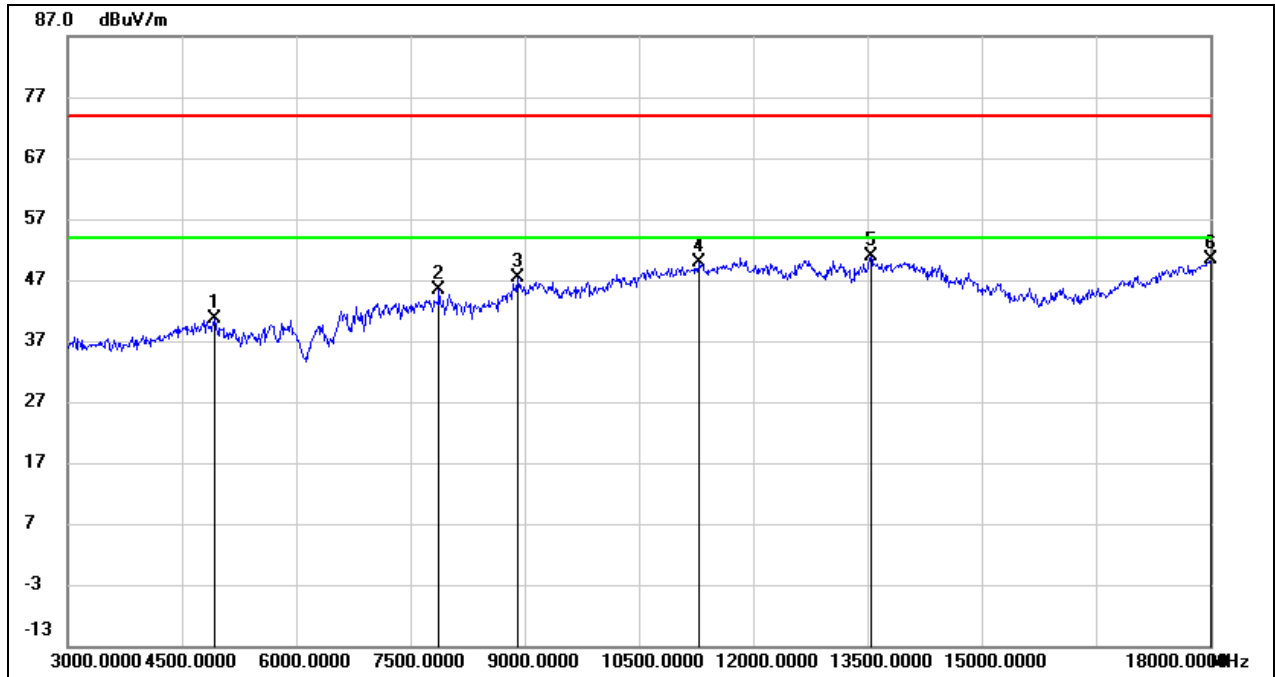

No.	Frequency (MHz)	Reading (dBuV)	Correct (dB/m)	Result (dBuV/m)	Limit (dBuV/m)	Margin (dB)	Remark
1	4935.000	40.42	0.20	40.62	74.00	-33.38	peak
2	7875.000	39.05	6.31	45.36	74.00	-28.64	peak
3	8910.000	37.49	9.82	47.31	74.00	-26.69	peak
4	11295.000	34.02	15.85	49.87	74.00	-24.13	peak
5	13545.000	29.84	20.99	50.83	74.00	-23.17	peak
6	18000.000	24.59	25.69	50.28	74.00	-23.72	peak

Test Mode:	802.11g	Frequency(MHz):	2462
Polarity:	Horizontal	Test Voltage:	DC 12 V

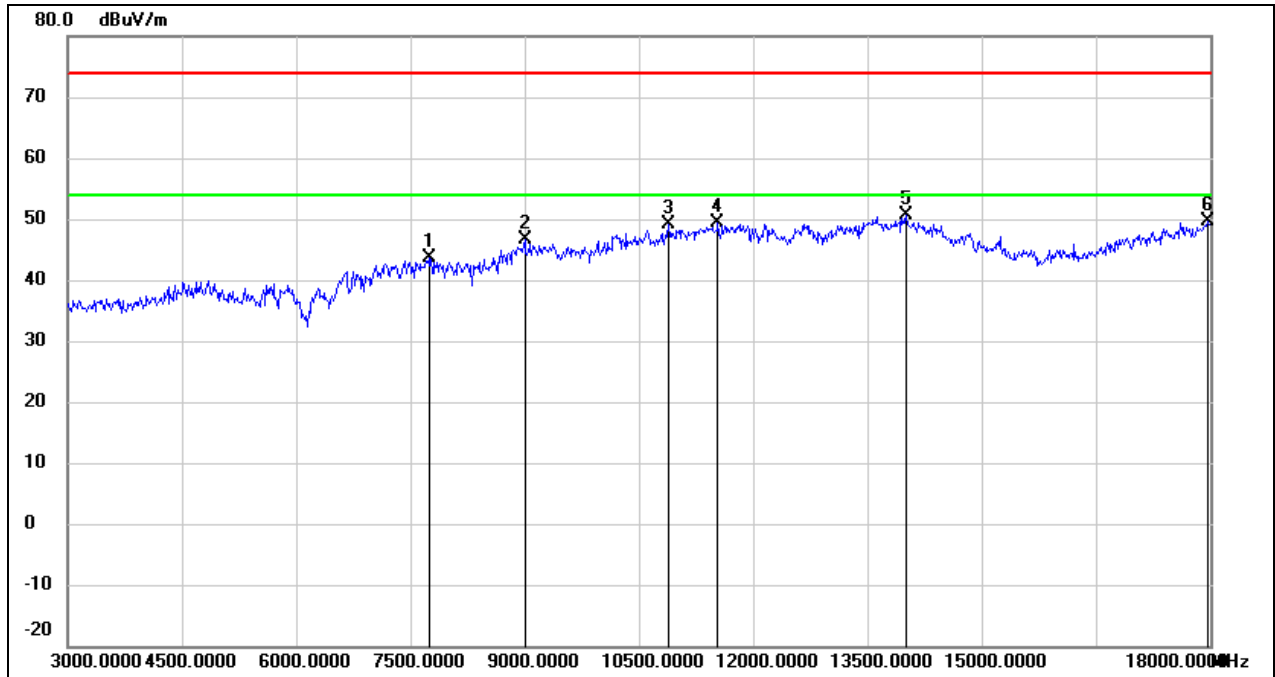

No.	Frequency (MHz)	Reading (dBuV)	Correct (dB/m)	Result (dBuV/m)	Limit (dBuV/m)	Margin (dB)	Remark
1	7755.000	37.24	6.31	43.55	74.00	-30.45	peak
2	9000.000	36.04	10.48	46.52	74.00	-27.48	peak
3	10890.000	34.74	14.39	49.13	74.00	-24.87	peak
4	11535.000	32.74	16.70	49.44	74.00	-24.56	peak
5	14010.000	28.75	21.93	50.68	74.00	-23.32	peak
6	17970.000	24.15	25.51	49.66	74.00	-24.34	peak

Test Mode:	802.11g	Frequency(MHz):	2462
Polarity:	Vertical	Test Voltage:	DC 12 V

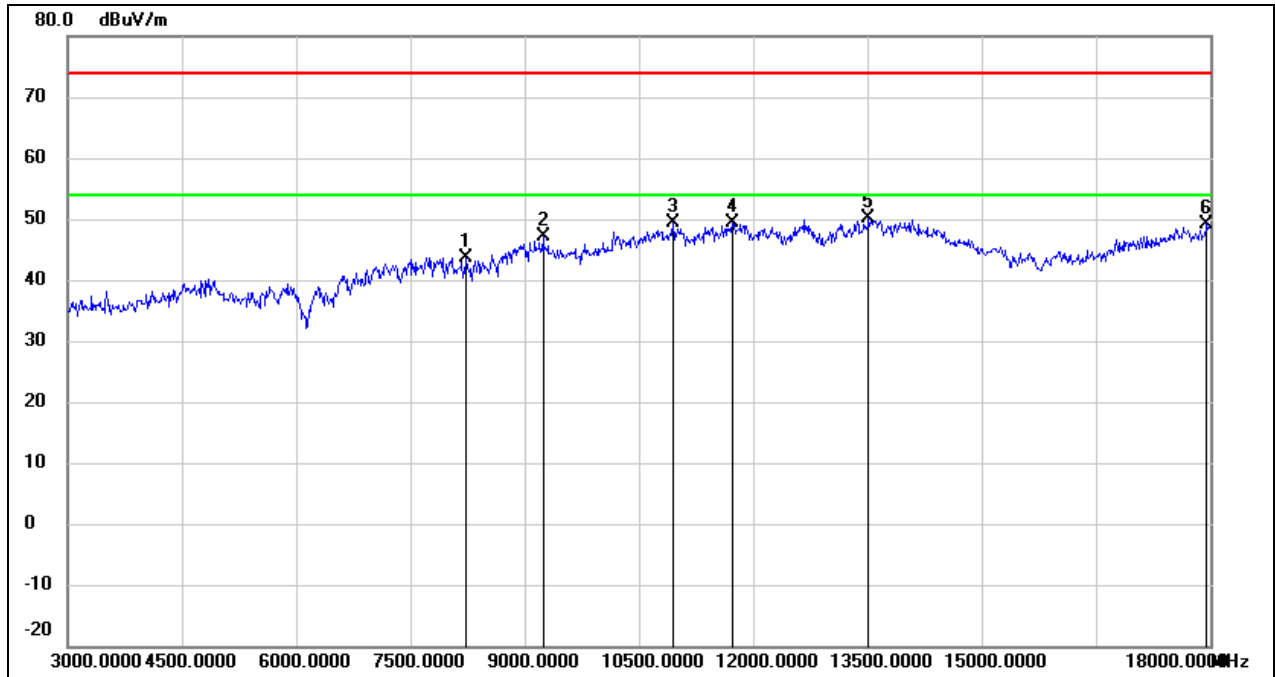

No.	Frequency (MHz)	Reading (dBuV)	Correct (dB/m)	Result (dBuV/m)	Limit (dBuV/m)	Margin (dB)	Remark
1	8235.000	37.10	6.56	43.66	74.00	-30.34	peak
2	9240.000	36.64	10.58	47.22	74.00	-26.78	peak
3	10950.000	34.75	14.60	49.35	74.00	-24.65	peak
4	11730.000	32.23	17.22	49.45	74.00	-24.55	peak
5	13515.000	29.17	20.93	50.10	74.00	-23.90	peak
6	17955.000	23.83	25.42	49.25	74.00	-24.75	peak

Test Mode:	802.11ax HE20	Frequency(MHz):	2412
Polarity:	Horizontal	Test Voltage:	DC 12 V

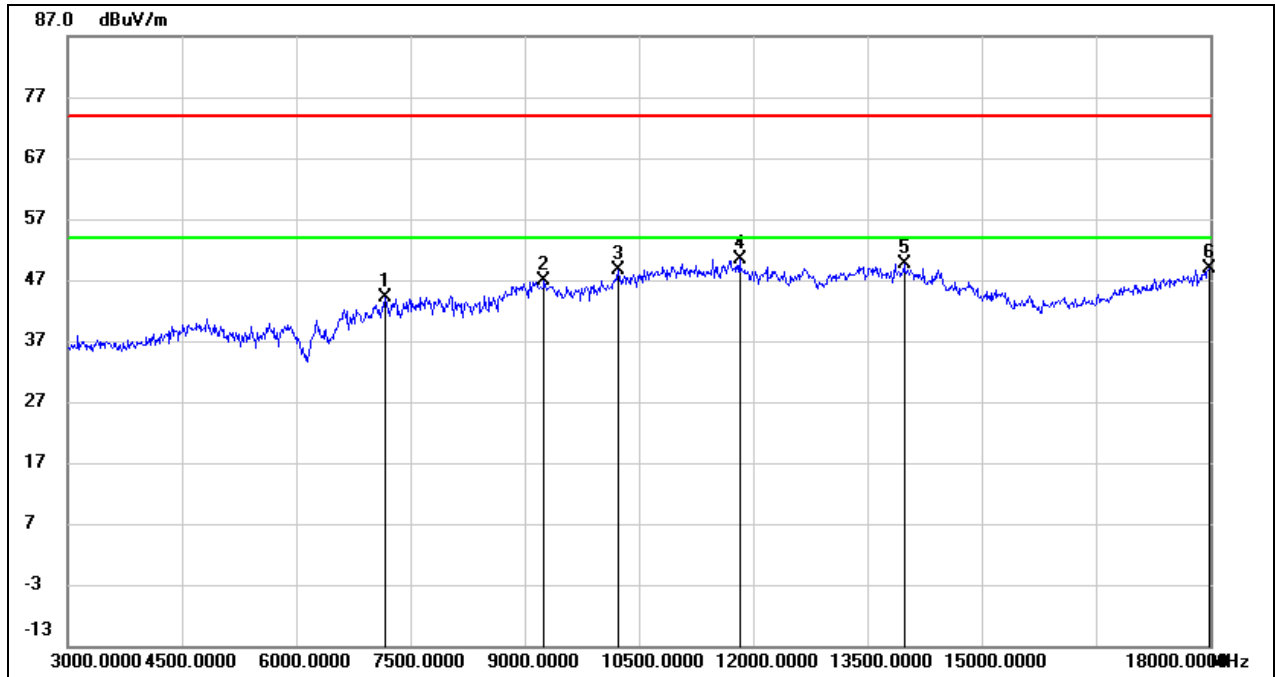

No.	Frequency (MHz)	Reading (dBuV)	Correct (dB/m)	Result (dBuV/m)	Limit (dBuV/m)	Margin (dB)	Remark
1	7170.000	37.61	6.56	44.17	74.00	-29.83	peak
2	9255.000	36.35	10.59	46.94	74.00	-27.06	peak
3	10230.000	36.20	12.46	48.66	74.00	-25.34	peak
4	11820.000	32.90	17.47	50.37	74.00	-23.63	peak
5	13980.000	27.69	21.92	49.61	74.00	-24.39	peak
6	17985.000	23.21	25.60	48.81	74.00	-25.19	peak

Test Mode:	802.11ax HE20	Frequency(MHz):	2412
Polarity:	Vertical	Test Voltage:	DC 12 V

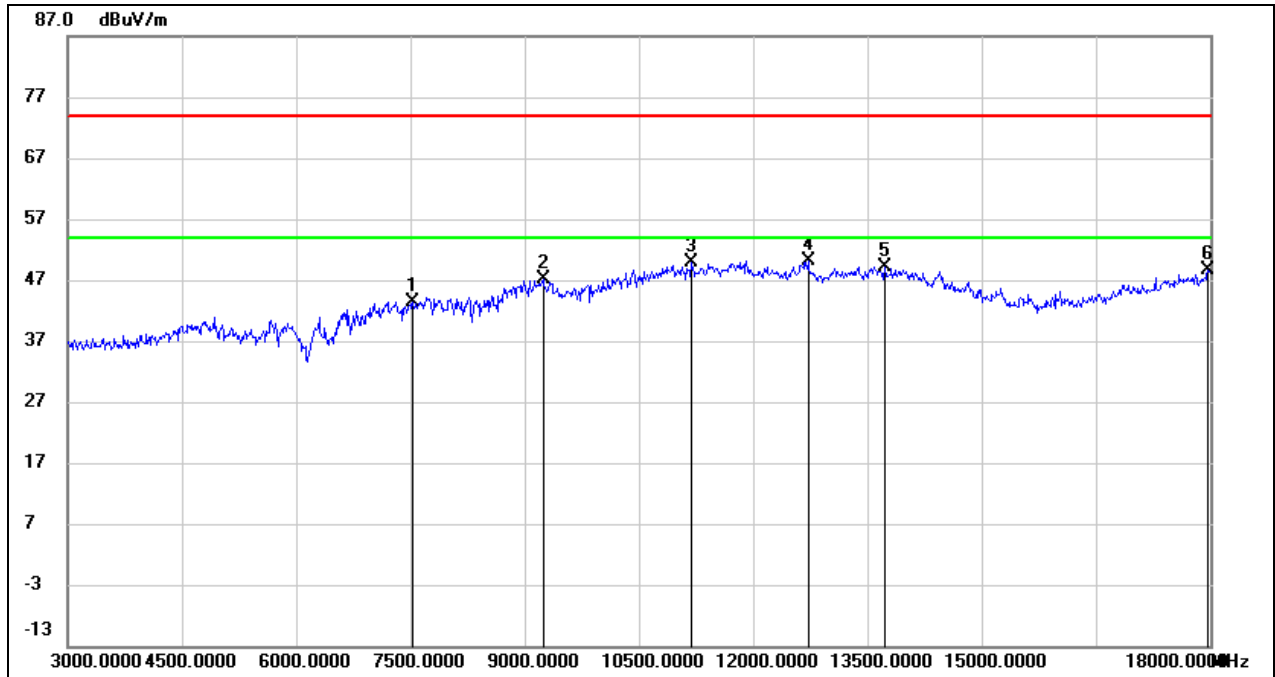

No.	Frequency (MHz)	Reading (dBuV)	Correct (dB/m)	Result (dBuV/m)	Limit (dBuV/m)	Margin (dB)	Remark
1	7530.000	37.17	6.33	43.50	74.00	-30.50	peak
2	9240.000	36.65	10.58	47.23	74.00	-26.77	peak
3	11190.000	34.41	15.46	49.87	74.00	-24.13	peak
4	12720.000	31.95	18.08	50.03	74.00	-23.97	peak
5	13725.000	27.84	21.37	49.21	74.00	-24.79	peak
6	17970.000	23.04	25.51	48.55	74.00	-25.45	peak

Test Mode:	802.11ax HE20	Frequency(MHz):	2417
Polarity:	Horizontal	Test Voltage:	DC 12 V

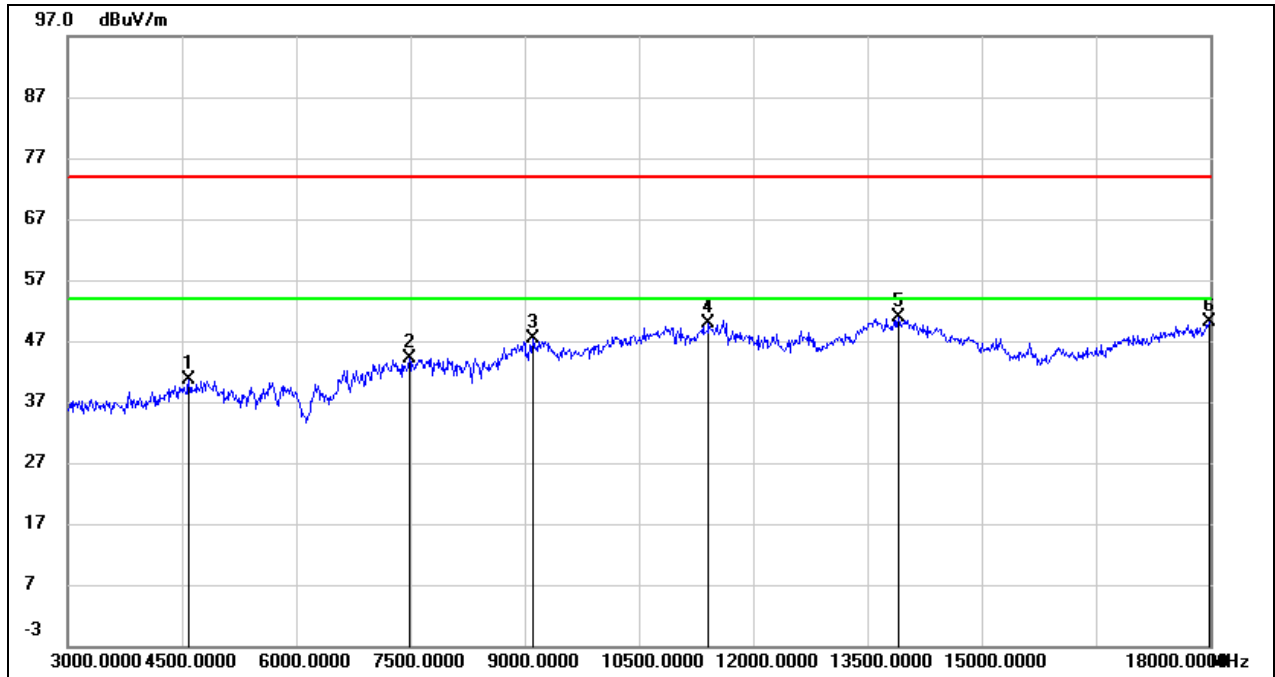

No.	Frequency (MHz)	Reading (dBuV)	Correct (dB/m)	Result (dBuV/m)	Limit (dBuV/m)	Margin (dB)	Remark
1	4590.000	41.65	-1.12	40.53	74.00	-33.47	peak
2	7485.000	37.82	6.34	44.16	74.00	-29.84	peak
3	9105.000	36.92	10.53	47.45	74.00	-26.55	peak
4	11415.000	33.54	16.29	49.83	74.00	-24.17	peak
5	13905.000	29.01	21.76	50.77	74.00	-23.23	peak
6	17985.000	24.44	25.60	50.04	74.00	-23.96	peak

Test Mode:	802.11ax HE20	Frequency(MHz):	2417
Polarity:	Vertical	Test Voltage:	DC 12 V

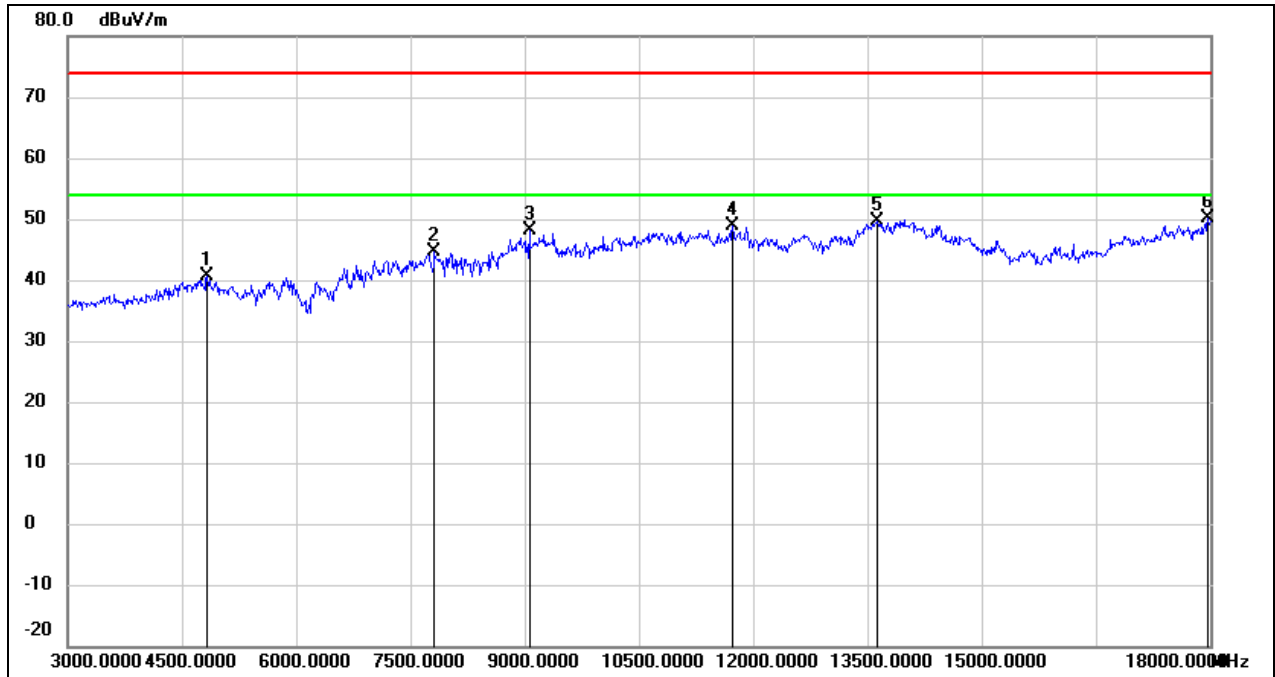

No.	Frequency (MHz)	Reading (dBuV)	Correct (dB/m)	Result (dBuV/m)	Limit (dBuV/m)	Margin (dB)	Remark
1	4830.000	40.80	-0.20	40.60	74.00	-33.40	peak
2	7815.000	38.32	6.32	44.64	74.00	-29.36	peak
3	9060.000	37.50	10.51	48.01	74.00	-25.99	peak
4	11730.000	31.58	17.22	48.80	74.00	-25.20	peak
5	13620.000	28.56	21.15	49.71	74.00	-24.29	peak
6	17970.000	24.57	25.51	50.08	74.00	-23.92	peak



Test Mode:	802.11ax HE20	Frequency(MHz):	2437
Polarity:	Horizontal	Test Voltage:	DC 12 V

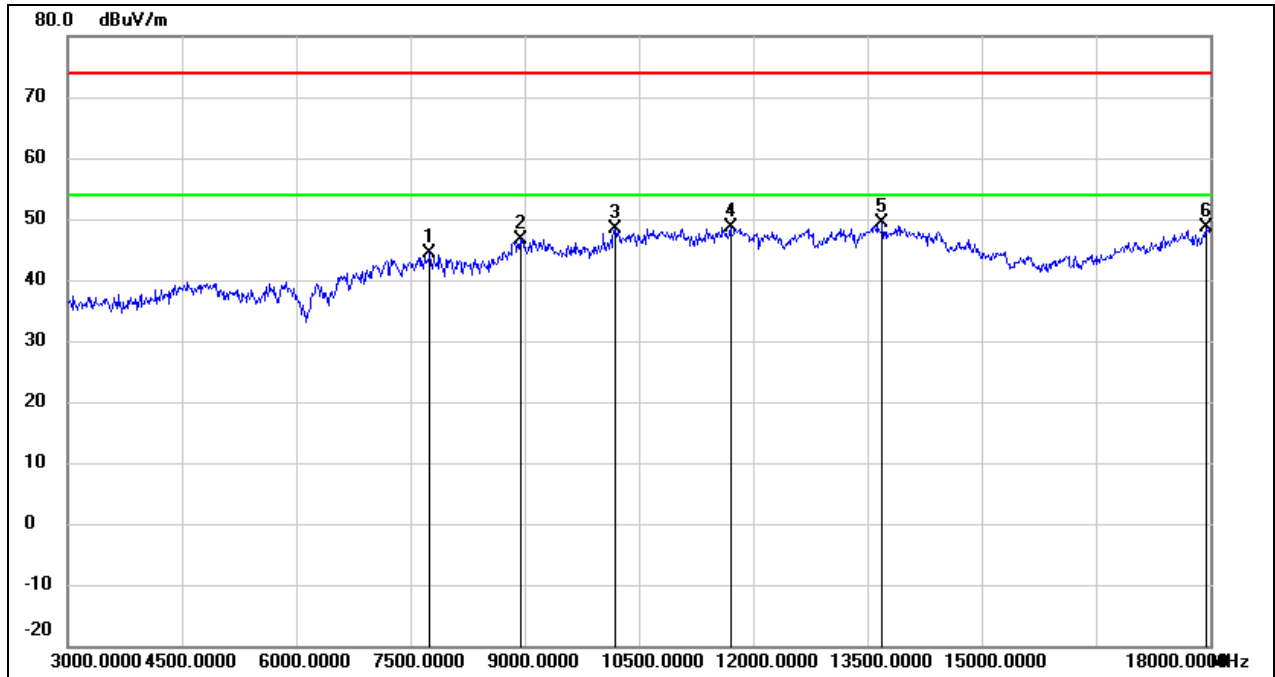

No.	Frequency (MHz)	Reading (dBuV)	Correct (dB/m)	Result (dBuV/m)	Limit (dBuV/m)	Margin (dB)	Remark
1	7755.000	38.06	6.31	44.37	74.00	-29.63	peak
2	8940.000	36.63	10.04	46.67	74.00	-27.33	peak
3	10185.000	35.92	12.38	48.30	74.00	-25.70	peak
4	11700.000	31.59	17.14	48.73	74.00	-25.27	peak
5	13695.000	28.01	21.31	49.32	74.00	-24.68	peak
6	17940.000	23.24	25.34	48.58	74.00	-25.42	peak

Test Mode:	802.11ax HE20	Frequency(MHz):	2437
Polarity:	Vertical	Test Voltage:	DC 12 V

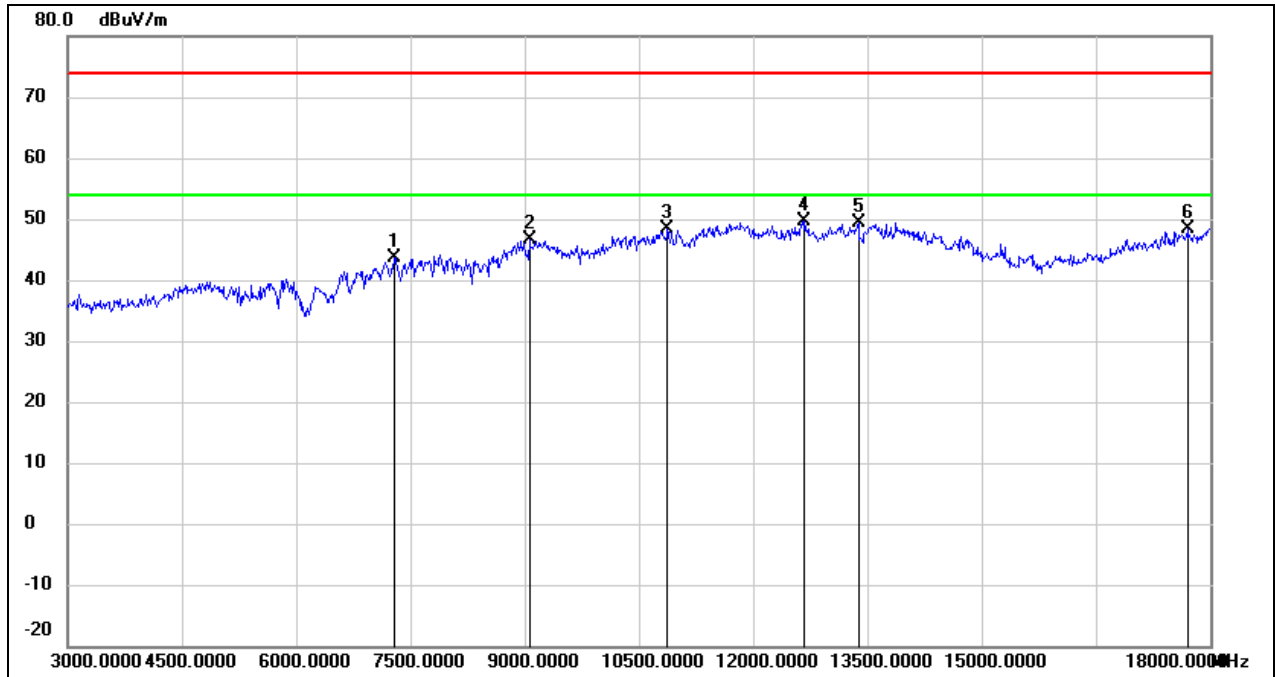

No.	Frequency (MHz)	Reading (dBuV)	Correct (dB/m)	Result (dBuV/m)	Limit (dBuV/m)	Margin (dB)	Remark
1	7290.000	37.23	6.48	43.71	74.00	-30.29	peak
2	9060.000	36.13	10.51	46.64	74.00	-27.36	peak
3	10875.000	34.17	14.32	48.49	74.00	-25.51	peak
4	12675.000	31.61	17.99	49.60	74.00	-24.40	peak
5	13380.000	29.01	20.38	49.39	74.00	-24.61	peak
6	17700.000	24.45	23.91	48.36	74.00	-25.64	peak

Test Mode:	802.11ax HE20	Frequency(MHz):	2457
Polarity:	Horizontal	Test Voltage:	DC 12 V

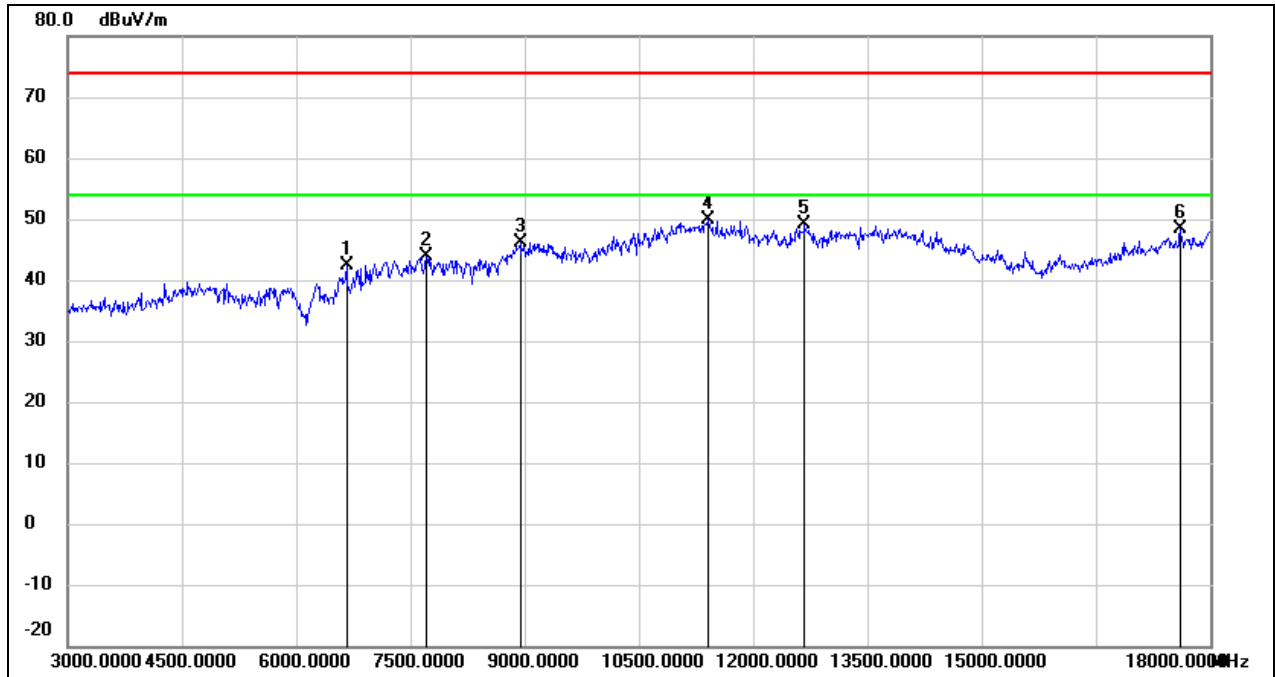

No.	Frequency (MHz)	Reading (dBuV)	Correct (dB/m)	Result (dBuV/m)	Limit (dBuV/m)	Margin (dB)	Remark
1	6660.000	37.26	5.02	42.28	74.00	-31.72	peak
2	7710.000	37.44	6.33	43.77	74.00	-30.23	peak
3	8940.000	36.19	10.04	46.23	74.00	-27.77	peak
4	11415.000	33.55	16.29	49.84	74.00	-24.16	peak
5	12675.000	31.17	17.99	49.16	74.00	-24.84	peak
6	17610.000	25.06	23.38	48.44	74.00	-25.56	peak

Test Mode:	802.11ax HE20	Frequency(MHz):	2457
Polarity:	Vertical	Test Voltage:	DC 12 V

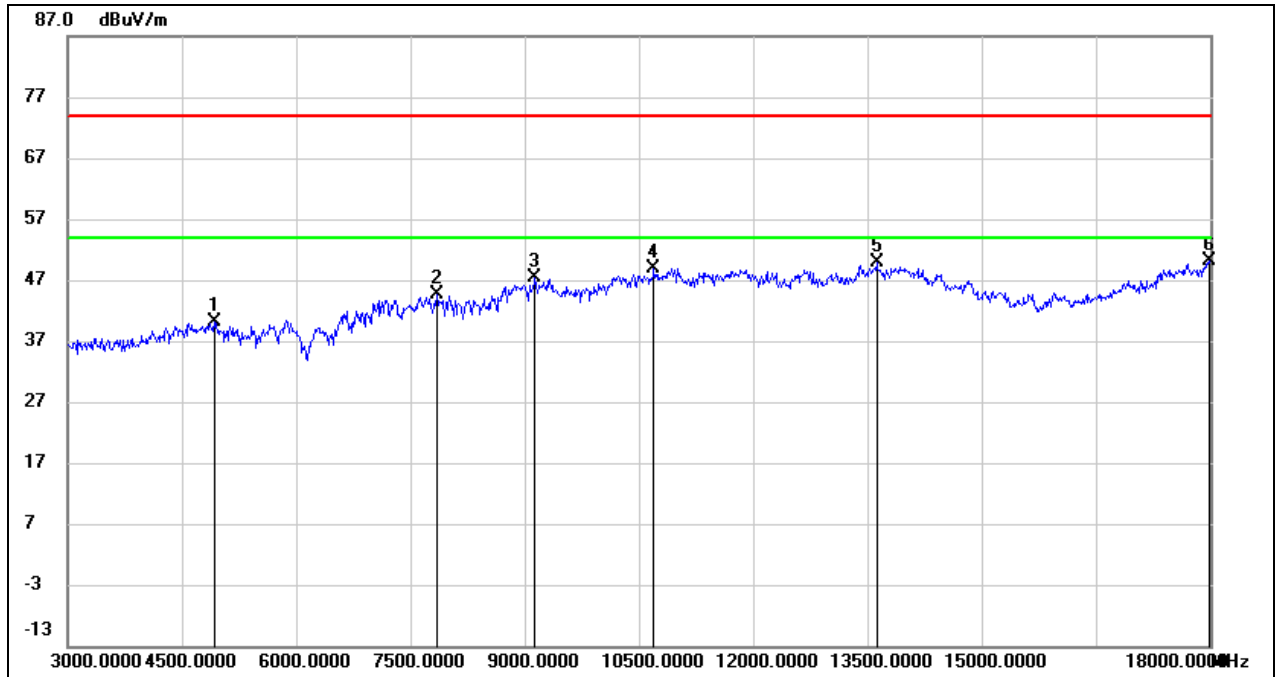

No.	Frequency (MHz)	Reading (dBuV)	Correct (dB/m)	Result (dBuV/m)	Limit (dBuV/m)	Margin (dB)	Remark
1	4920.000	39.87	0.14	40.01	74.00	-33.99	peak
2	7845.000	38.20	6.32	44.52	74.00	-29.48	peak
3	9135.000	36.82	10.55	47.37	74.00	-26.63	peak
4	10695.000	35.29	13.68	48.97	74.00	-25.03	peak
5	13620.000	28.61	21.15	49.76	74.00	-24.24	peak
6	17985.000	24.61	25.60	50.21	74.00	-23.79	peak

Test Mode:	802.11ax HE20	Frequency(MHz):	2462
Polarity:	Horizontal	Test Voltage:	DC 12 V

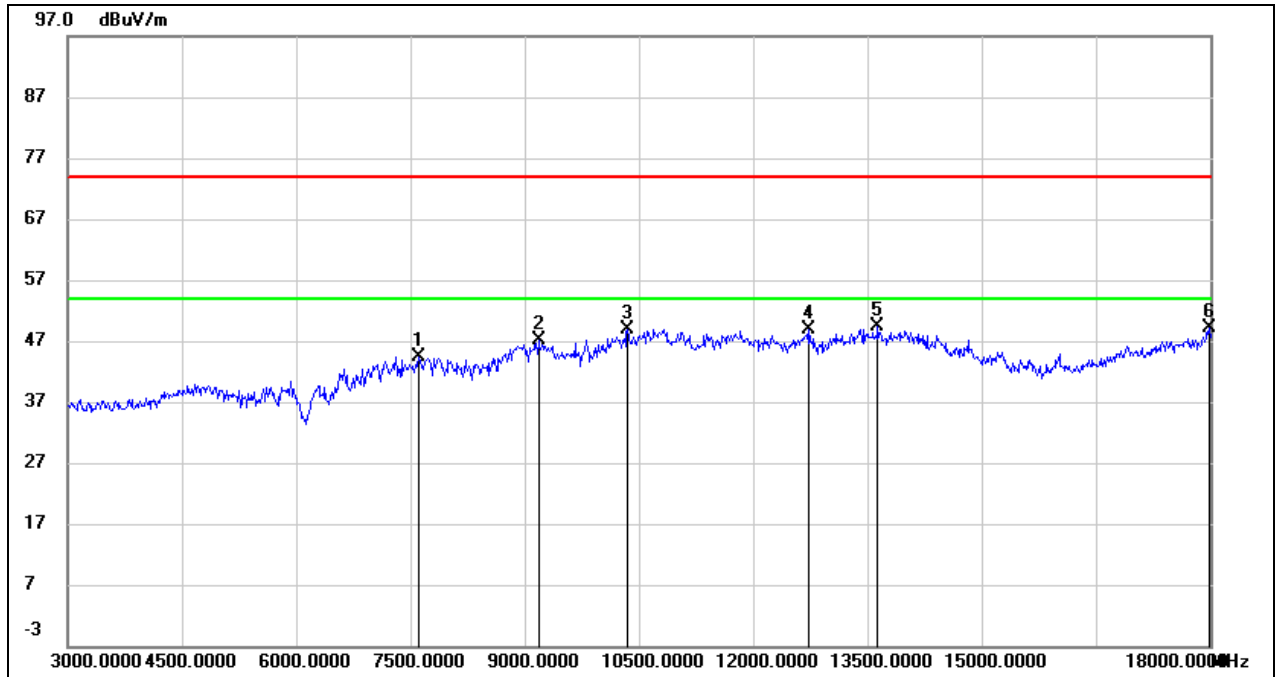

No.	Frequency (MHz)	Reading (dBuV)	Correct (dB/m)	Result (dBuV/m)	Limit (dBuV/m)	Margin (dB)	Remark
1	7605.000	38.12	6.32	44.44	74.00	-29.56	peak
2	9180.000	36.64	10.56	47.20	74.00	-26.80	peak
3	10350.000	36.12	12.70	48.82	74.00	-25.18	peak
4	12735.000	30.87	18.12	48.99	74.00	-25.01	peak
5	13635.000	28.14	21.19	49.33	74.00	-24.67	peak
6	17985.000	23.55	25.60	49.15	74.00	-24.85	peak

Test Mode:	802.11ax HE20	Frequency(MHz):	2462
Polarity:	Vertical	Test Voltage:	DC 12 V

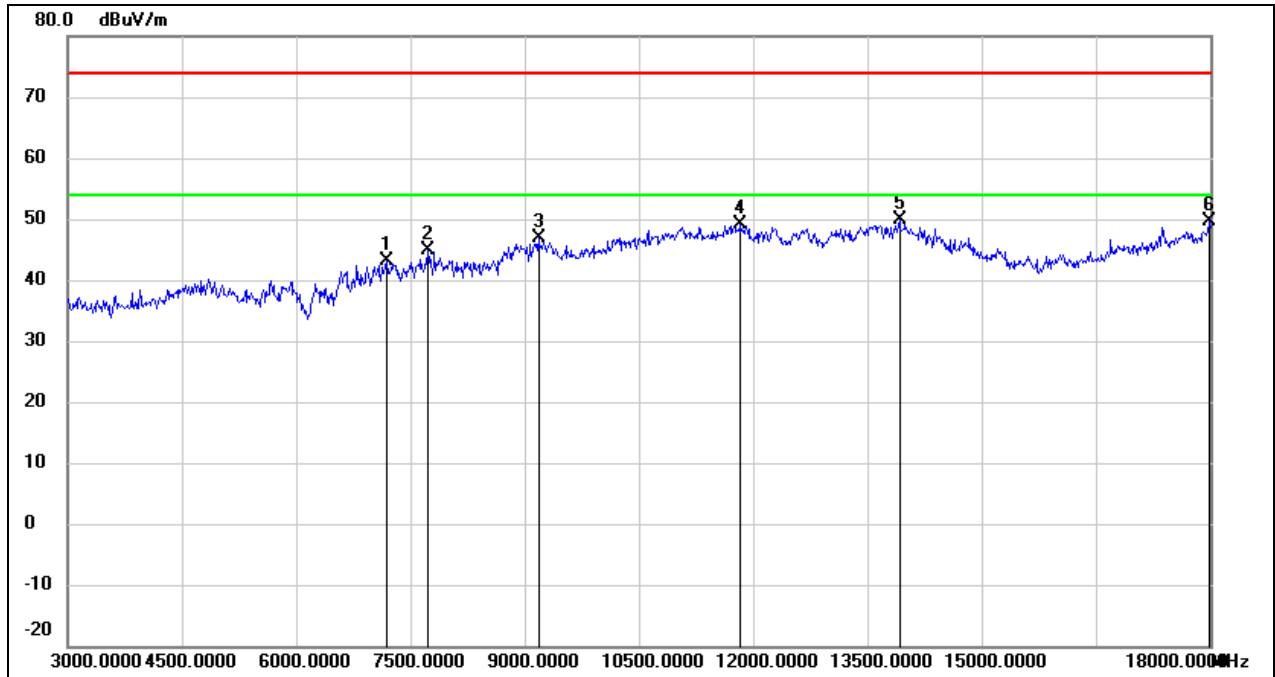

No.	Frequency (MHz)	Reading (dBuV)	Correct (dB/m)	Result (dBuV/m)	Limit (dBuV/m)	Margin (dB)	Remark
1	7185.000	36.65	6.55	43.20	74.00	-30.80	peak
2	7725.000	38.51	6.32	44.83	74.00	-29.17	peak
3	9180.000	36.34	10.56	46.90	74.00	-27.10	peak
4	11835.000	31.56	17.51	49.07	74.00	-24.93	peak
5	13920.000	28.05	21.79	49.84	74.00	-24.16	peak
6	17985.000	23.93	25.60	49.53	74.00	-24.47	peak

Test Mode:	802.11ax HE40	Frequency(MHz):	2422
Polarity:	Horizontal	Test Voltage:	DC 12 V

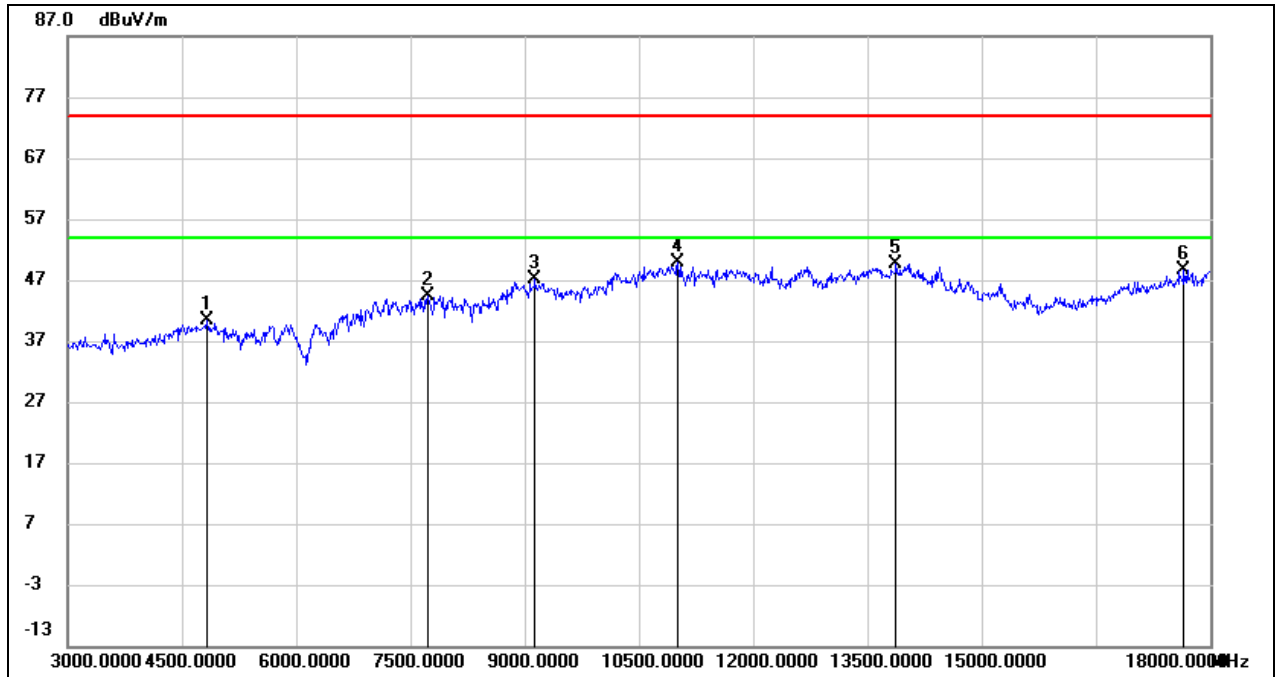

No.	Frequency (MHz)	Reading (dBuV)	Correct (dB/m)	Result (dBuV/m)	Limit (dBuV/m)	Margin (dB)	Remark
1	4830.000	40.55	-0.20	40.35	74.00	-33.65	peak
2	7725.000	38.17	6.32	44.49	74.00	-29.51	peak
3	9135.000	36.58	10.55	47.13	74.00	-26.87	peak
4	11010.000	35.16	14.81	49.97	74.00	-24.03	peak
5	13875.000	27.83	21.70	49.53	74.00	-24.47	peak
6	17655.000	24.90	23.64	48.54	74.00	-25.46	peak

Test Mode:	802.11ax HE40	Frequency(MHz):	2422
Polarity:	Vertical	Test Voltage:	DC 12 V

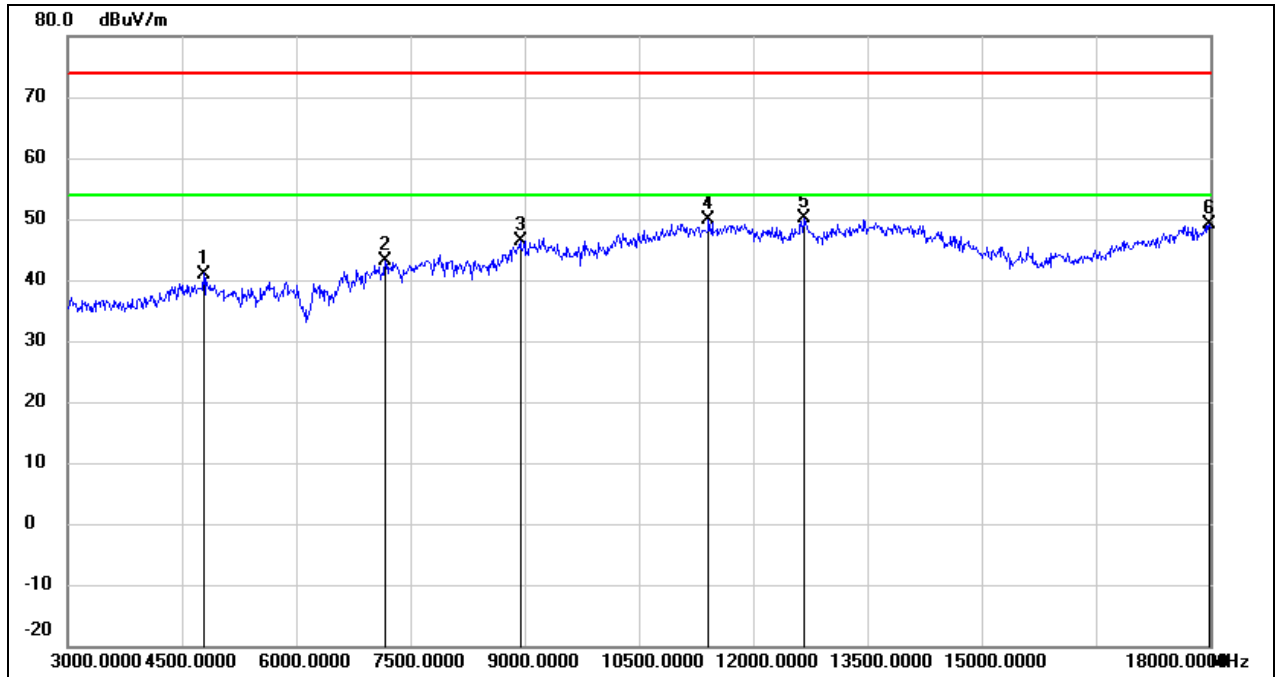

No.	Frequency (MHz)	Reading (dBuV)	Correct (dB/m)	Result (dBuV/m)	Limit (dBuV/m)	Margin (dB)	Remark
1	4785.000	41.37	-0.37	41.00	74.00	-33.00	peak
2	7170.000	36.59	6.56	43.15	74.00	-30.85	peak
3	8940.000	36.33	10.04	46.37	74.00	-27.63	peak
4	11415.000	33.63	16.29	49.92	74.00	-24.08	peak
5	12660.000	32.14	17.95	50.09	74.00	-23.91	peak
6	17985.000	23.51	25.60	49.11	74.00	-24.89	peak



Test Mode:	802.11ax HE40	Frequency(MHz):	2427
Polarity:	Horizontal	Test Voltage:	DC 12 V

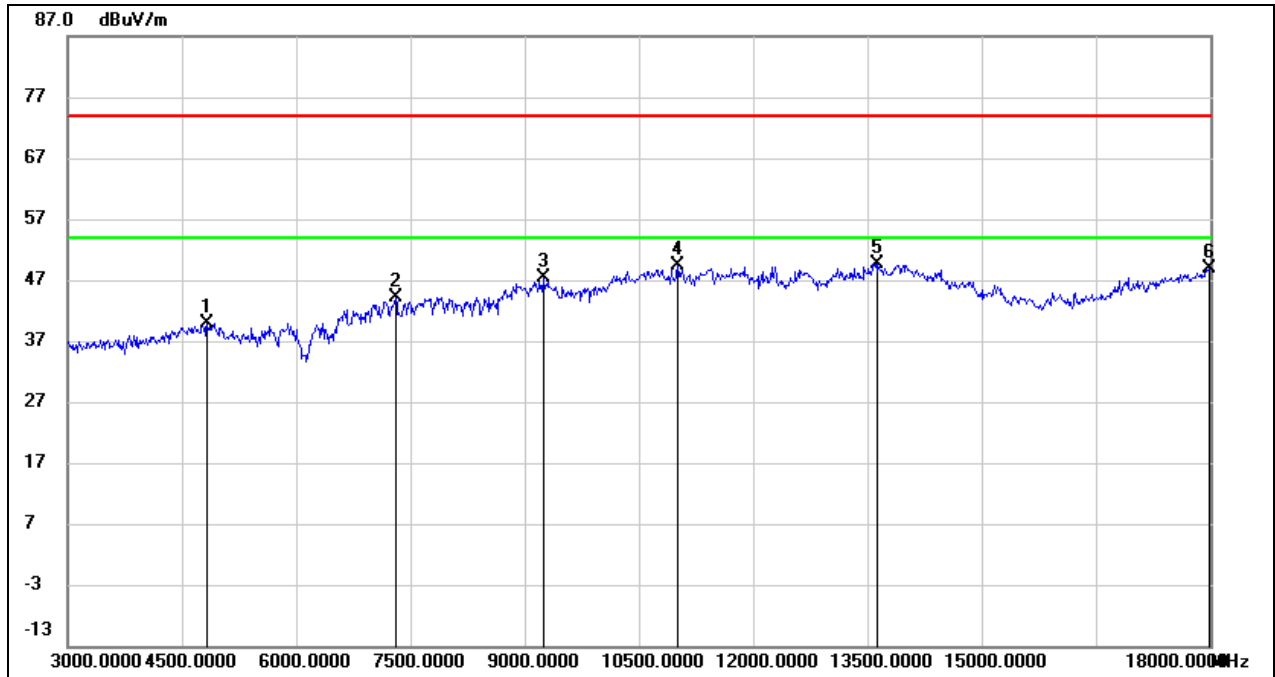

No.	Frequency (MHz)	Reading (dBuV)	Correct (dB/m)	Result (dBuV/m)	Limit (dBuV/m)	Margin (dB)	Remark
1	4830.000	40.14	-0.20	39.94	74.00	-34.06	peak
2	7305.000	37.69	6.47	44.16	74.00	-29.84	peak
3	9240.000	36.69	10.58	47.27	74.00	-26.73	peak
4	11010.000	34.50	14.81	49.31	74.00	-24.69	peak
5	13635.000	28.53	21.19	49.72	74.00	-24.28	peak
6	17985.000	23.26	25.60	48.86	74.00	-25.14	peak

Test Mode:	802.11ax HE40	Frequency(MHz):	2427
Polarity:	Vertical	Test Voltage:	DC 12 V

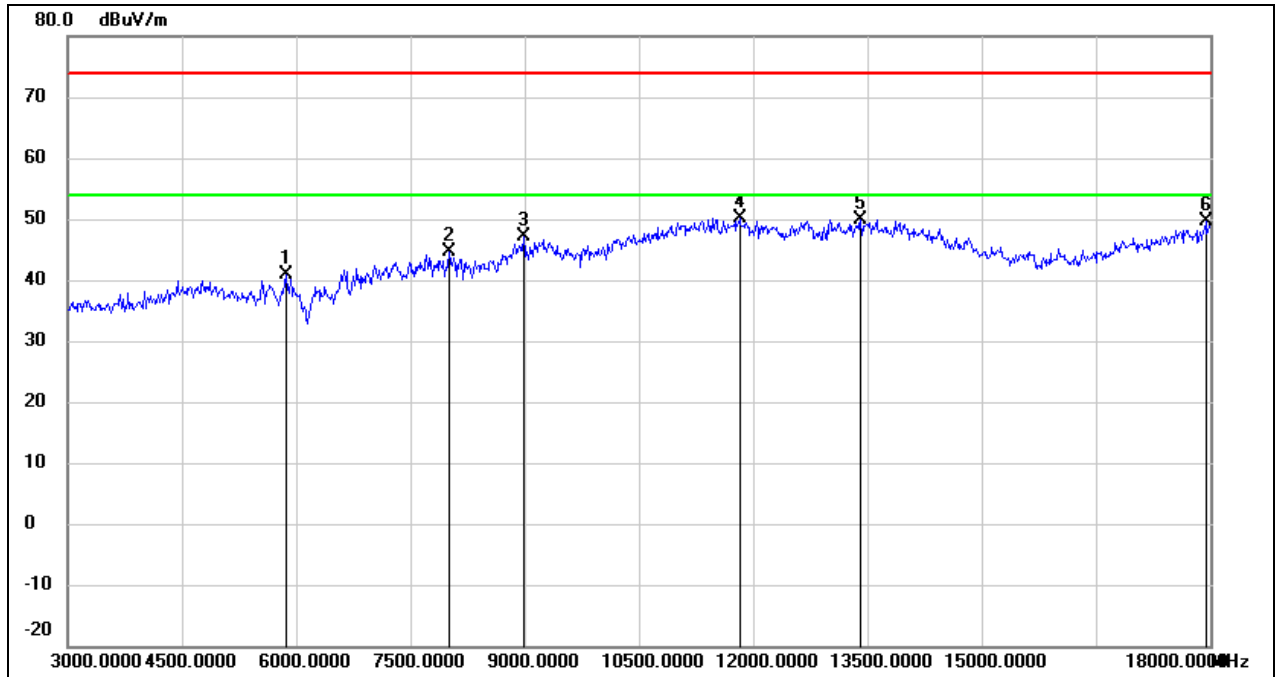

No.	Frequency (MHz)	Reading (dBuV)	Correct (dB/m)	Result (dBuV/m)	Limit (dBuV/m)	Margin (dB)	Remark
1	5865.000	38.98	1.88	40.86	74.00	-33.14	peak
2	8010.000	38.26	6.32	44.58	74.00	-29.42	peak
3	8985.000	36.69	10.37	47.06	74.00	-26.94	peak
4	11820.000	32.68	17.47	50.15	74.00	-23.85	peak
5	13410.000	29.44	20.50	49.94	74.00	-24.06	peak
6	17940.000	24.31	25.34	49.65	74.00	-24.35	peak

Test Mode:	802.11ax HE40	Frequency(MHz):	2437
Polarity:	Horizontal	Test Voltage:	DC 12 V

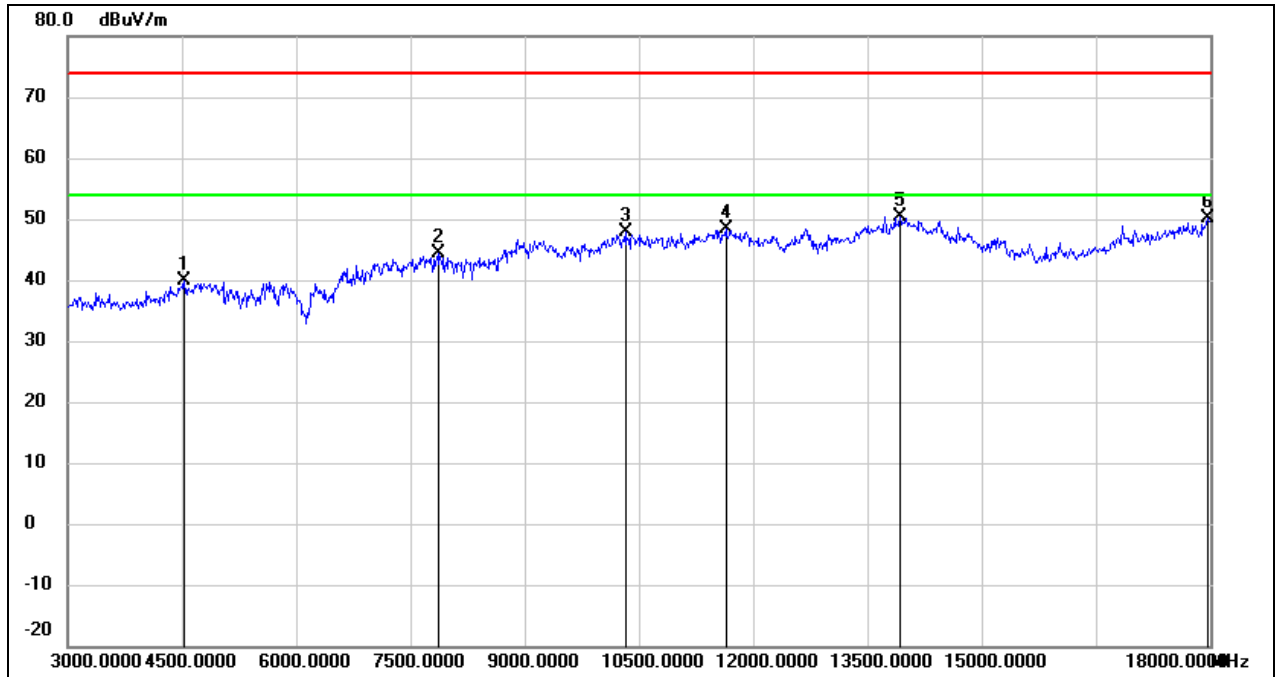

No.	Frequency (MHz)	Reading (dBuV)	Correct (dB/m)	Result (dBuV/m)	Limit (dBuV/m)	Margin (dB)	Remark
1	4530.000	41.18	-1.35	39.83	74.00	-34.17	peak
2	7875.000	37.97	6.31	44.28	74.00	-29.72	peak
3	10320.000	35.15	12.64	47.79	74.00	-26.21	peak
4	11640.000	31.45	16.98	48.43	74.00	-25.57	peak
5	13920.000	28.69	21.79	50.48	74.00	-23.52	peak
6	17970.000	24.63	25.51	50.14	74.00	-23.86	peak

Test Mode:	802.11ax HE40	Frequency(MHz):	2437
Polarity:	Vertical	Test Voltage:	DC 12 V

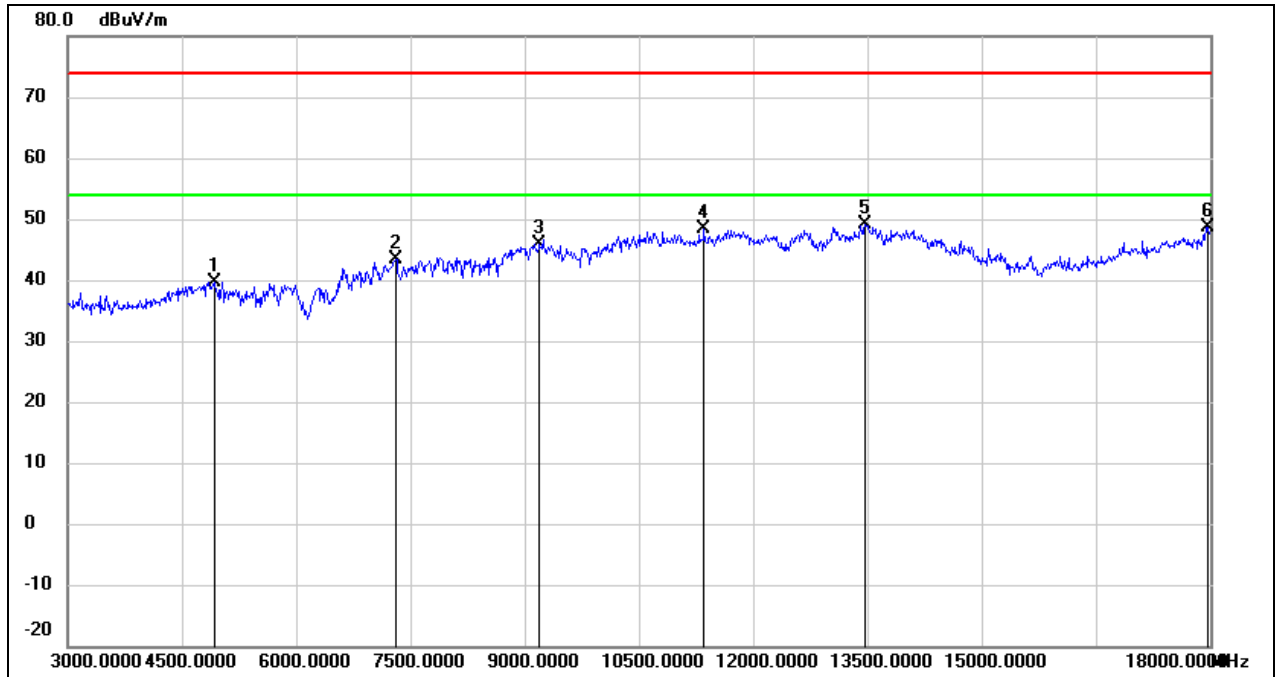

No.	Frequency (MHz)	Reading (dBuV)	Correct (dB/m)	Result (dBuV/m)	Limit (dBuV/m)	Margin (dB)	Remark
1	4920.000	39.53	0.14	39.67	74.00	-34.33	peak
2	7305.000	36.83	6.47	43.30	74.00	-30.70	peak
3	9195.000	35.40	10.56	45.96	74.00	-28.04	peak
4	11355.000	32.44	16.06	48.50	74.00	-25.50	peak
5	13470.000	28.37	20.77	49.14	74.00	-24.86	peak
6	17970.000	23.08	25.51	48.59	74.00	-25.41	peak

Test Mode:	802.11ax HE40	Frequency(MHz):	2447
Polarity:	Horizontal	Test Voltage:	DC 12 V

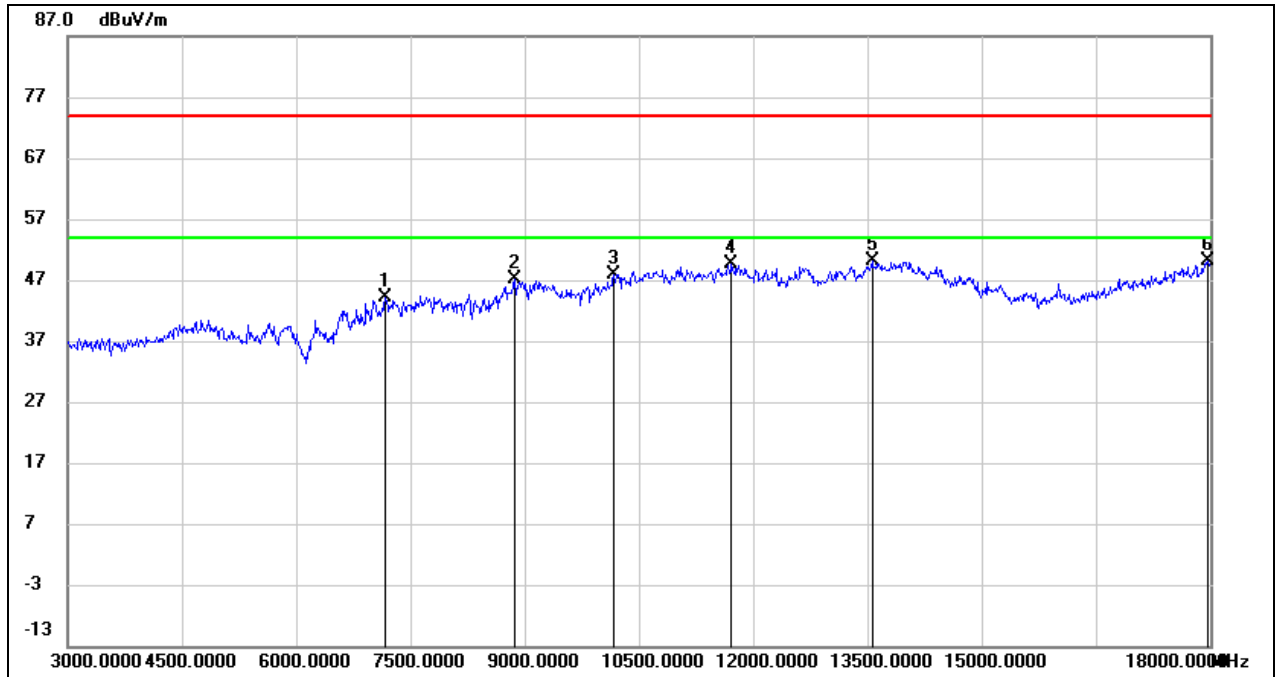

No.	Frequency (MHz)	Reading (dBuV)	Correct (dB/m)	Result (dBuV/m)	Limit (dBuV/m)	Margin (dB)	Remark
1	7170.000	37.53	6.56	44.09	74.00	-29.91	peak
2	8865.000	37.61	9.50	47.11	74.00	-26.89	peak
3	10170.000	35.62	12.34	47.96	74.00	-26.04	peak
4	11715.000	32.39	17.19	49.58	74.00	-24.42	peak
5	13560.000	29.02	21.04	50.06	74.00	-23.94	peak
6	17970.000	24.54	25.51	50.05	74.00	-23.95	peak

Test Mode:	802.11ax HE40	Frequency(MHz):	2447
Polarity:	Vertical	Test Voltage:	DC 12 V

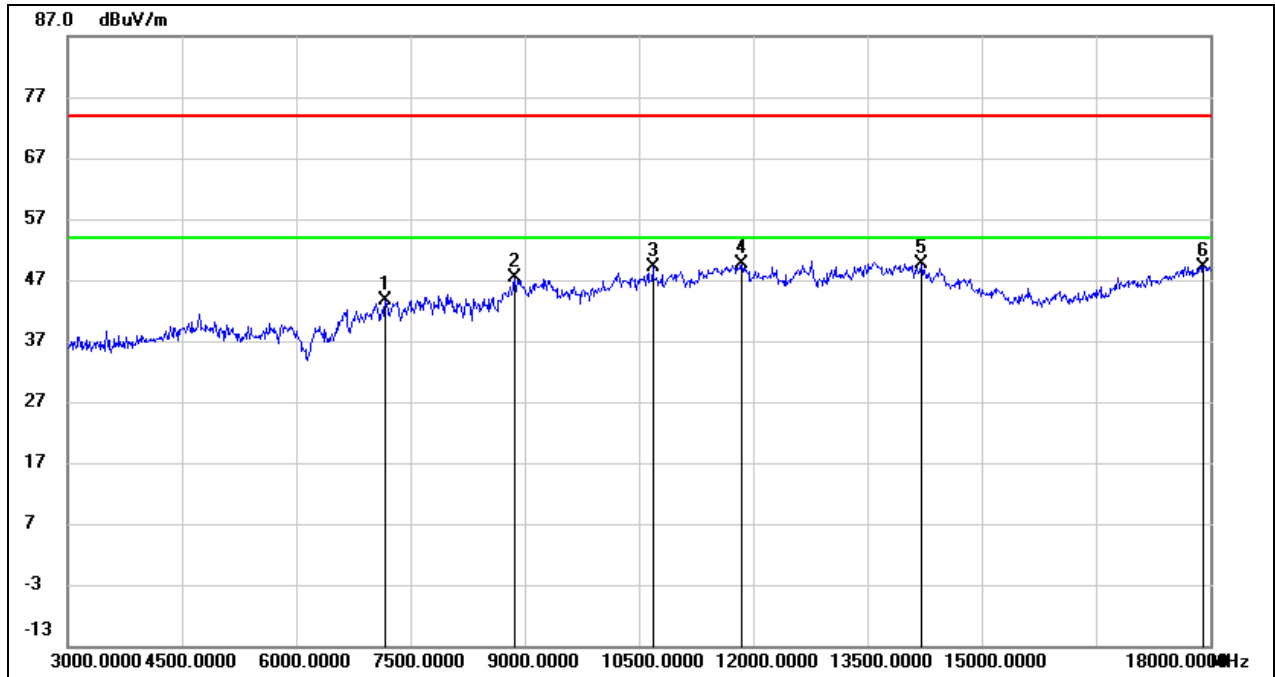

No.	Frequency (MHz)	Reading (dBuV)	Correct (dB/m)	Result (dBuV/m)	Limit (dBuV/m)	Margin (dB)	Remark
1	7170.000	37.03	6.56	43.59	74.00	-30.41	peak
2	8865.000	37.99	9.50	47.49	74.00	-26.51	peak
3	10680.000	35.57	13.62	49.19	74.00	-24.81	peak
4	11850.000	32.12	17.56	49.68	74.00	-24.32	peak
5	14205.000	28.62	21.11	49.73	74.00	-24.27	peak
6	17910.000	24.07	25.16	49.23	74.00	-24.77	peak

Test Mode:	802.11ax HE40	Frequency(MHz):	2452
Polarity:	Horizontal	Test Voltage:	DC 12 V

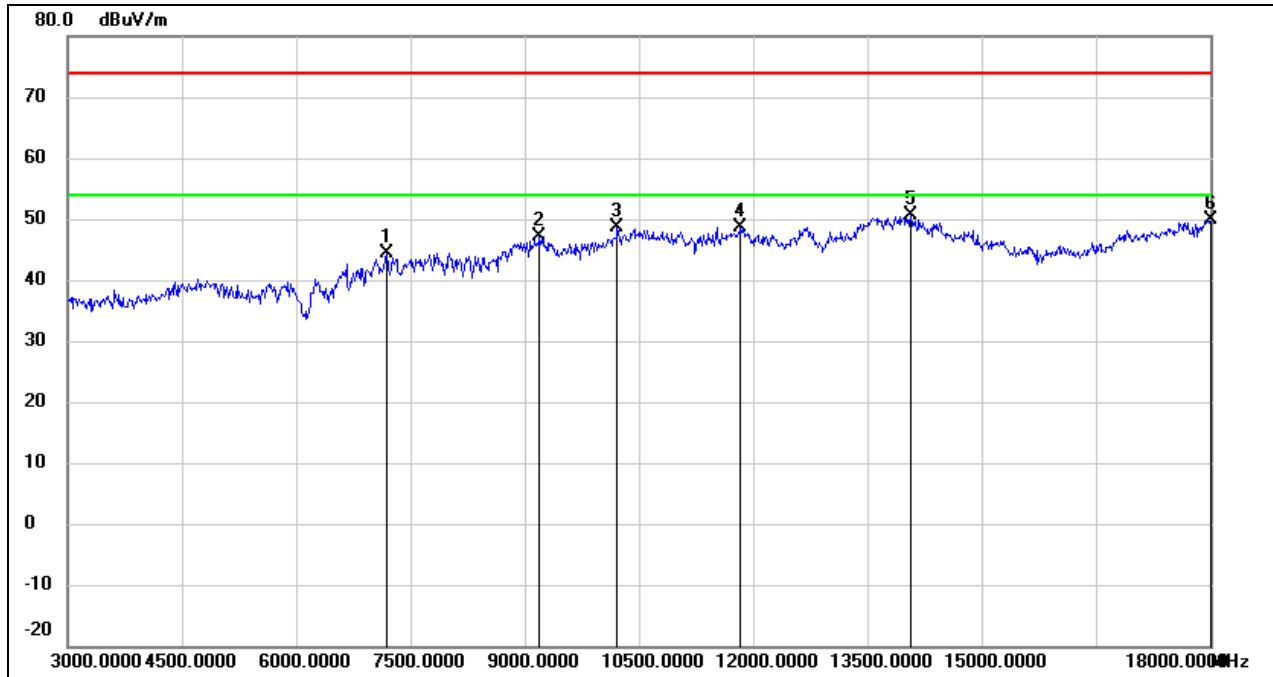

No.	Frequency (MHz)	Reading (dBuV)	Correct (dB/m)	Result (dBuV/m)	Limit (dBuV/m)	Margin (dB)	Remark
1	7185.000	37.74	6.55	44.29	74.00	-29.71	peak
2	9195.000	36.64	10.56	47.20	74.00	-26.80	peak
3	10215.000	36.26	12.43	48.69	74.00	-25.31	peak
4	11835.000	31.15	17.51	48.66	74.00	-25.34	peak
5	14070.000	28.96	21.67	50.63	74.00	-23.37	peak
6	18000.000	24.26	25.69	49.95	74.00	-24.05	peak

Test Mode:	802.11ax HE40	Frequency(MHz):	2452
Polarity:	Vertical	Test Voltage:	DC 12 V

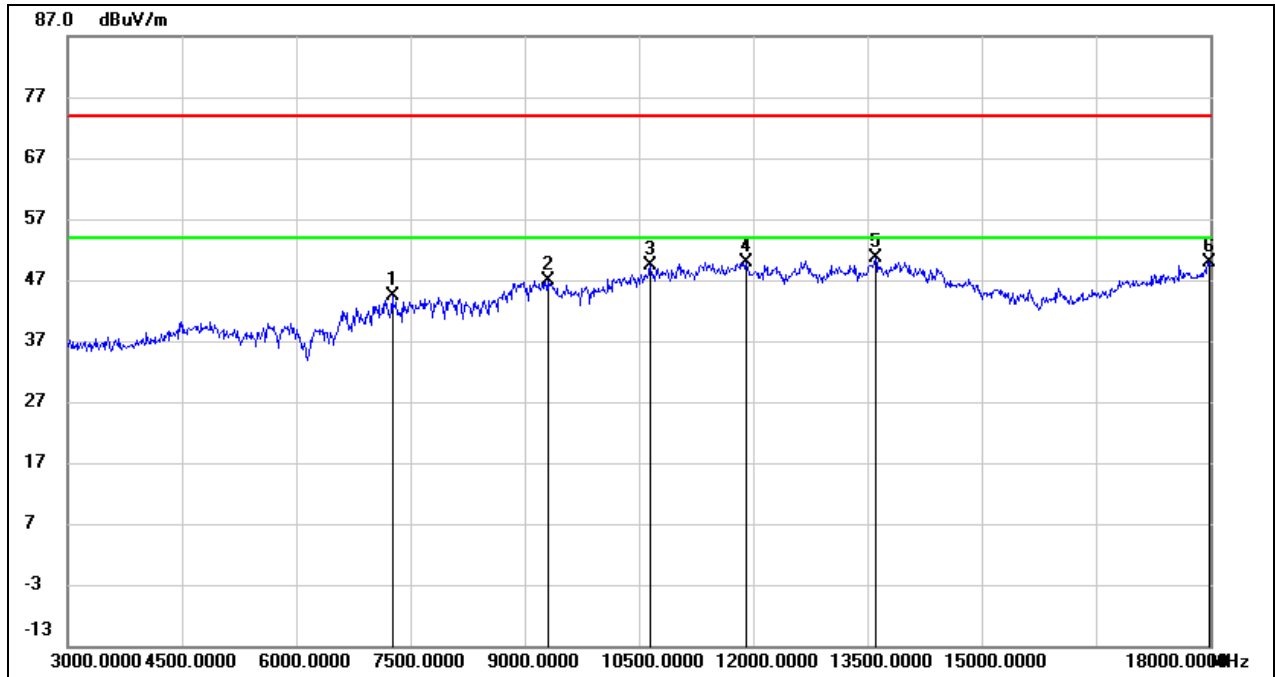

No.	Frequency (MHz)	Reading (dBuV)	Correct (dB/m)	Result (dBuV/m)	Limit (dBuV/m)	Margin (dB)	Remark
1	7260.000	37.86	6.50	44.36	74.00	-29.64	peak
2	9300.000	36.20	10.61	46.81	74.00	-27.19	peak
3	10650.000	35.92	13.53	49.45	74.00	-24.55	peak
4	11910.000	32.25	17.72	49.97	74.00	-24.03	peak
5	13605.000	29.42	21.12	50.54	74.00	-23.46	peak
6	17985.000	24.39	25.60	49.99	74.00	-24.01	peak



### 8.4. SPURIOUS EMISSIONS(9 KHZ~30 MHZ)

Test Mode:	802.11b	Frequency(MHz):	2412
Polarity:	Horizontal	Test Voltage:	DC 12 V

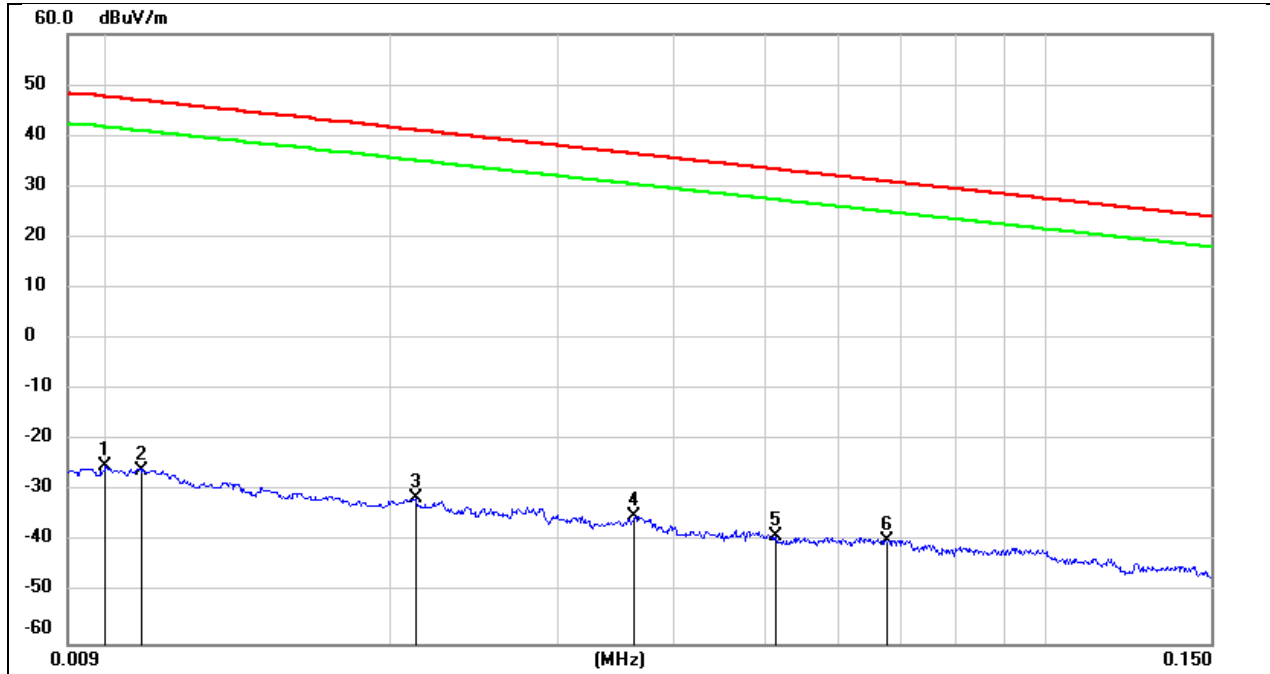

No.	Frequency (MHz)	Reading (dBuV)	Correct (dB/m)	Result (dBuV/m)	Limit (dBuV/m)	Margin (dB)	Remark
1	0.0100	76.22	-101.40	-25.18	47.60	-72.78	peak
2	0.0108	75.51	-101.39	-25.88	46.93	-72.81	peak
3	0.0212	70.04	-101.35	-31.31	41.07	-72.38	peak
4	0.0362	66.38	-101.42	-35.04	36.43	-71.47	peak
5	0.0514	62.68	-101.48	-38.80	33.38	-72.18	peak
6	0.0675	61.85	-101.56	-39.71	31.02	-70.73	peak

Test Mode:	802.11b	Frequency(MHz):	2412
Polarity:	Horizontal	Test Voltage:	DC 12 V

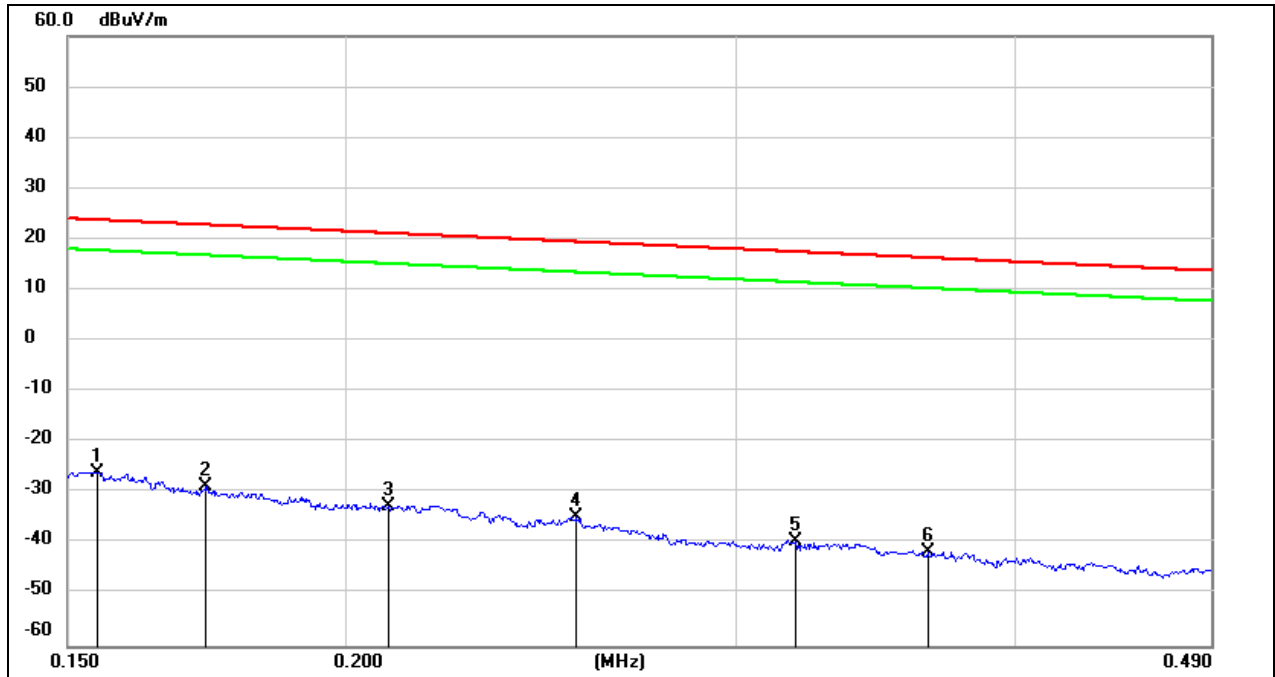

No.	Frequency (MHz)	Reading (dBuV)	Correct (dB/m)	Result (dBuV/m)	Limit (dBuV/m)	Margin (dB)	Remark
1	0.1547	75.81	-101.65	-25.84	23.81	-49.65	peak
2	0.1731	72.96	-101.67	-28.71	22.84	-51.55	peak
3	0.2091	69.32	-101.73	-32.41	21.19	-53.60	peak
4	0.2540	67.10	-101.80	-34.70	19.50	-54.20	peak
5	0.3190	62.29	-101.88	-39.59	17.53	-57.12	peak
6	0.3654	60.31	-101.93	-41.62	16.35	-57.97	peak

Test Mode:	802.11b	Frequency(MHz):	2412
Polarity:	Horizontal	Test Voltage:	DC 12 V

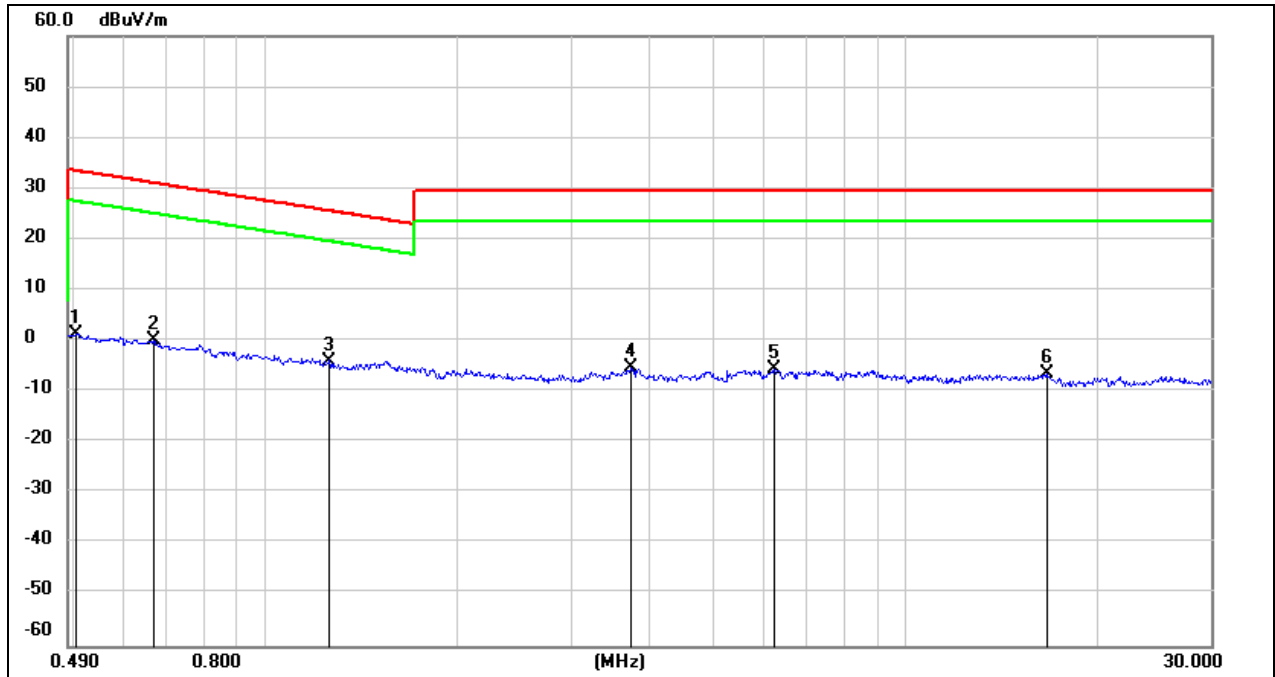

No.	Frequency (MHz)	Reading (dBuV)	Correct (dB/m)	Result (dBuV/m)	Limit (dBuV/m)	Margin (dB)	Remark
1	0.5039	63.43	-62.07	1.36	33.56	-32.20	peak
2	0.6671	62.25	-62.10	0.15	31.12	-30.97	peak
3	1.2573	58.25	-62.15	-3.90	25.62	-29.52	peak
4	3.7100	56.20	-61.41	-5.21	29.54	-34.75	peak
5	6.2445	55.63	-61.32	-5.69	29.54	-35.23	peak
6	16.6021	54.52	-60.96	-6.44	29.54	-35.98	peak

### 8.5. SPURIOUS EMISSIONS(18 GHZ~26 GHZ)

Test Mode:	802.11b	Frequency(MHz):	2412
Polarity:	Horizontal	Test Voltage:	DC 12 V

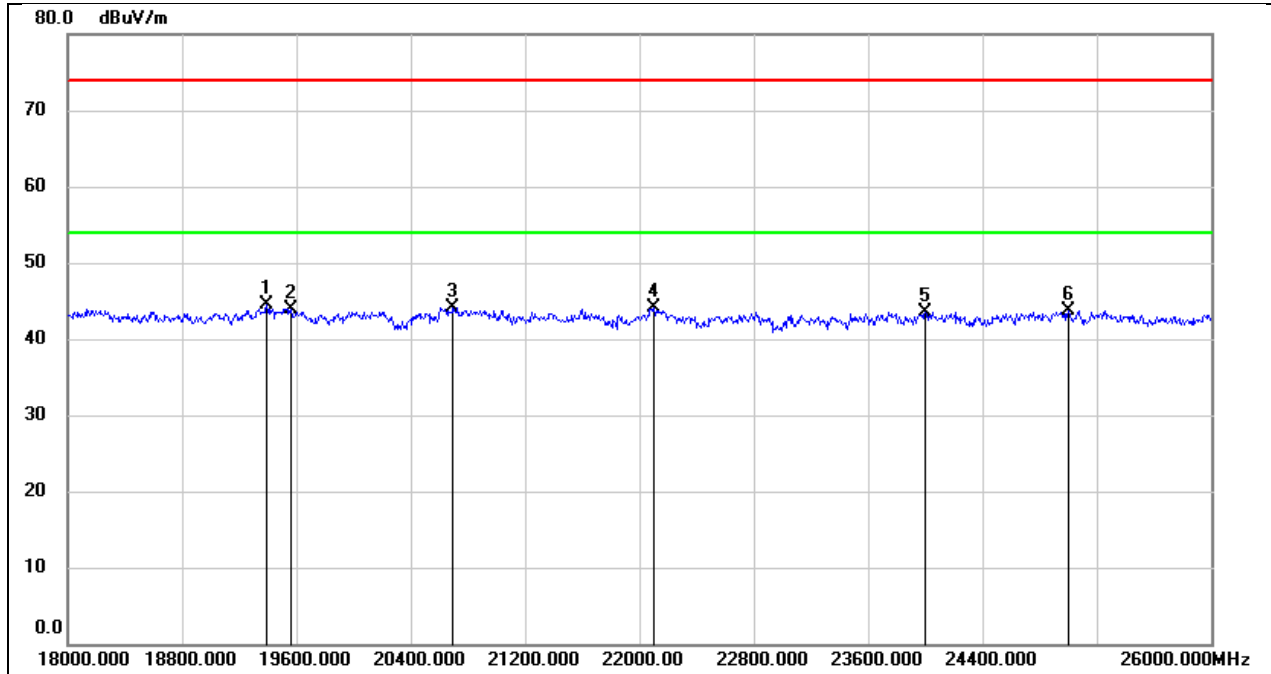

No.	Frequency (MHz)	Reading (dBuV)	Correct (dB/m)	Result (dBuV/m)	Limit (dBuV/m)	Margin (dB)	Remark
1	19392.000	50.12	-5.57	44.55	74.00	-29.45	peak
2	19560.000	49.36	-5.48	43.88	74.00	-30.12	peak
3	20696.000	49.21	-5.16	44.05	74.00	-29.95	peak
4	22096.000	48.54	-4.38	44.16	74.00	-29.84	peak
5	24000.000	46.21	-2.75	43.46	74.00	-30.54	peak
6	25000.000	45.86	-2.10	43.76	74.00	-30.24	peak

Test Mode:	802.11b	Frequency(MHz):	2412
Polarity:	Vertical	Test Voltage:	DC 12 V

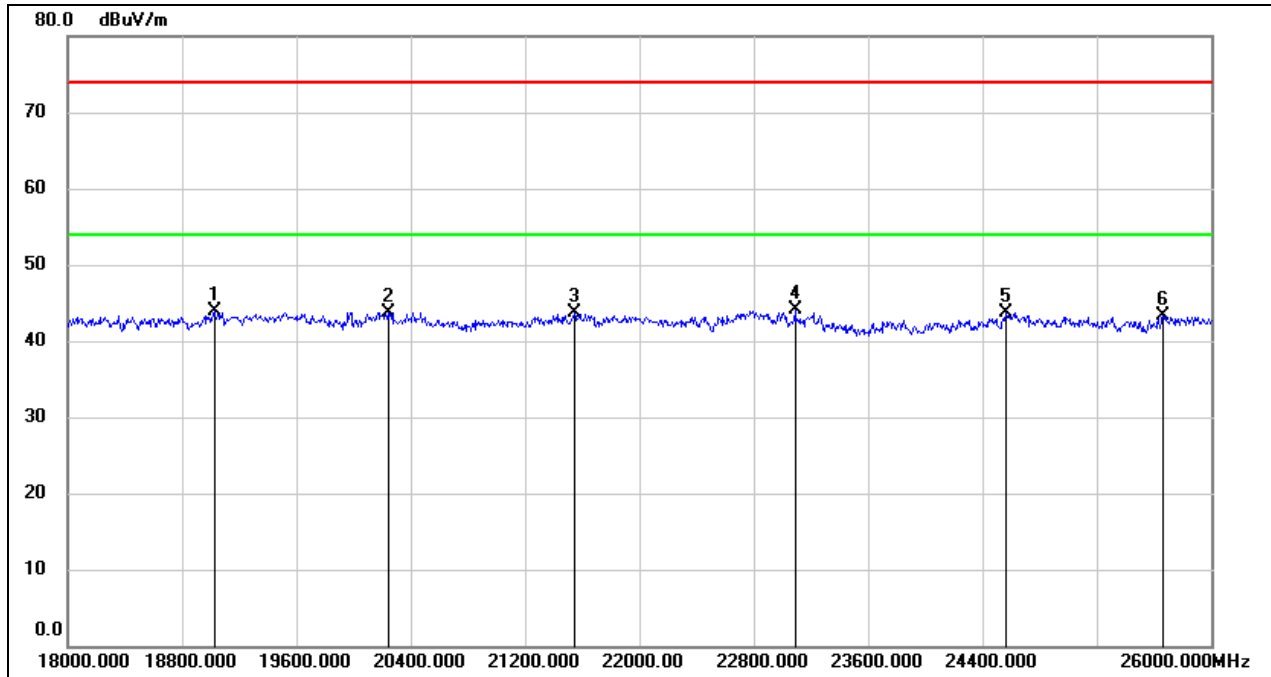

No.	Frequency (MHz)	Reading (dBuV)	Correct (dB/m)	Result (dBuV/m)	Limit (dBuV/m)	Margin (dB)	Remark
1	19024.000	49.20	-5.24	43.96	74.00	-30.04	peak
2	20240.000	49.32	-5.61	43.71	74.00	-30.29	peak
3	21544.000	48.26	-4.63	43.63	74.00	-30.37	peak
4	23088.000	47.52	-3.41	44.11	74.00	-29.89	peak
5	24568.000	46.10	-2.33	43.77	74.00	-30.23	peak
6	25664.000	44.39	-1.01	43.38	74.00	-30.62	peak

### 8.6. SPURIOUS EMISSIONS(30 MHZ~1 GHZ)

Test Mode:	802.11b	Frequency(MHz):	2412
Polarity:	Horizontal	Test Voltage:	DC 12 V

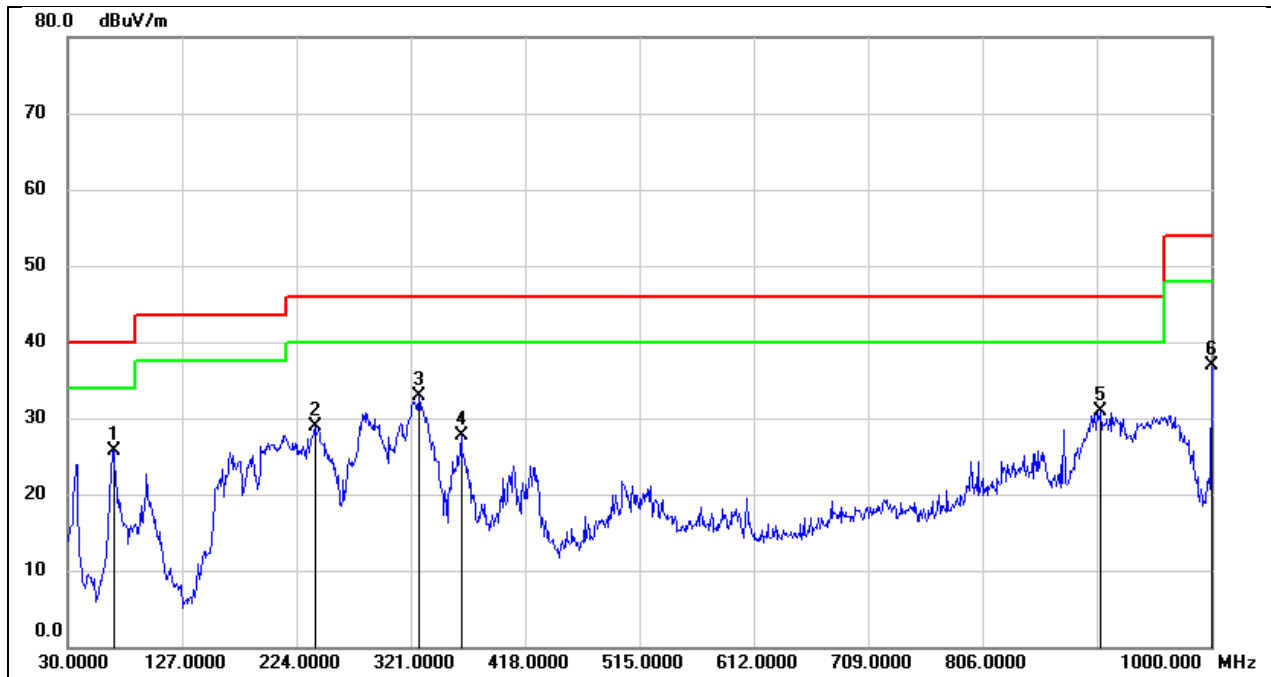

No.	Frequency (MHz)	Reading (dBuV)	Correct (dB/m)	Result (dBuV/m)	Limit (dBuV/m)	Margin (dB)	Remark
1	68.8000	46.50	-20.71	25.79	40.00	-14.21	QP
2	239.5200	47.24	-18.40	28.84	46.00	-17.16	QP
3	327.7900	46.81	-13.95	32.86	46.00	-13.14	QP
4	363.6800	40.65	-12.96	27.69	46.00	-18.31	QP
5	905.9100	35.73	-4.75	30.98	46.00	-15.02	QP
6	1000.0000	40.82	-3.95	36.87	54.00	-17.13	QP

Test Mode:	802.11b	Frequency(MHz):	2412
Polarity:	Vertical	Test Voltage:	DC 12 V

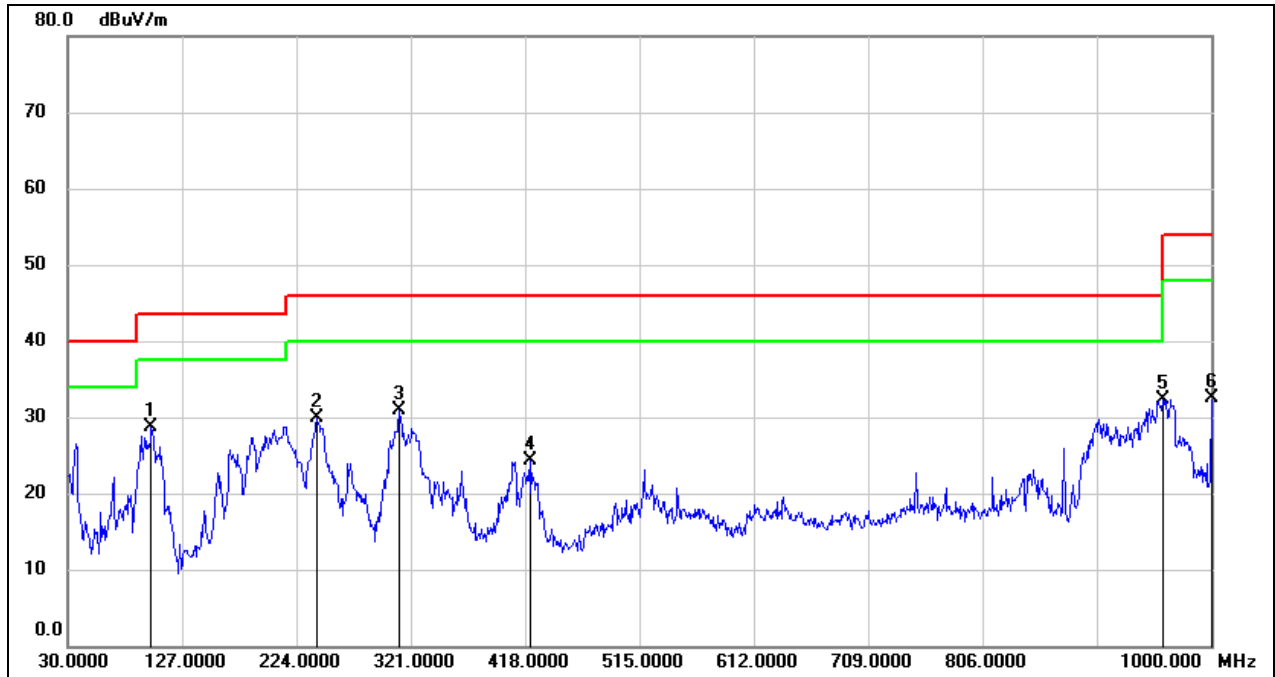

No.	Frequency (MHz)	Reading (dBuV)	Correct (dB/m)	Result (dBuV/m)	Limit (dBuV/m)	Margin (dB)	Remark
1	100.8100	49.99	-21.25	28.74	43.50	-14.76	QP
2	241.4600	48.34	-18.50	29.84	46.00	-16.16	QP
3	311.3000	45.71	-14.73	30.98	46.00	-15.02	QP
4	422.8500	36.63	-12.40	24.23	46.00	-21.77	QP
5	959.2600	37.02	-4.69	32.33	46.00	-13.67	QP
6	1000.0000	36.39	-3.95	32.44	54.00	-21.56	QP

## 9. ANTENNA REQUIREMENT

### REQUIREMENT

Please refer to FCC part 15.203

An intentional radiator shall be designed to ensure that no antenna other than that furnished by the responsible party shall be used with the device. The use of a permanently attached antenna or of an antenna that uses a unique coupling to the intentional radiator shall be considered sufficient to comply with the provisions of this section. The manufacturer may design the unit so that a broken antenna can be replaced by the user, but the use of a standard antenna jack or electrical connector is prohibited.

Please refer to FCC part 15.247(b)(4)

The conducted output power limit specified in paragraph (b) of this section is based on the use of antennas with directional gains that do not exceed 6 dBi. Except as shown in paragraph (c) of this section, if transmitting antennas of directional gain greater than 6 dBi are used, the conducted output power from the intentional radiator shall be reduced below the stated values in paragraphs (b)(1), (b)(2), and (b)(3) of this section, as appropriate, by the amount in dB that the directional gain of the antenna exceeds 6 dBi.

### DESCRIPTION

Pass



## 10. AC POWER LINE CONDUCTED EMISSION

### LIMITS

Please refer to CFR 47 FCC §15.207 (a) and ISED RSS-Gen Clause 8.8

FREQUENCY (MHz)	Quasi-peak	Average
0.15 -0.5	66 - 56 *	56 - 46 *
0.50 -5.0	56.00	46.00
5.0 -30.0	60.00	50.00

### TEST PROCEDURE

The EUT is put on a table of non-conducting material that is 80 cm high. The vertical conducting wall of shielding is located 40 cm to the rear of the EUT. The power line of the EUT is connected to the AC mains through a Artificial Mains Network (A.M.N.). A EMI Measurement Receiver (R&S Test Receiver ESR3) is used to test the emissions from both sides of AC line. According to the requirements in Section 6.2 of ANSI C63.10-2013. Conducted emissions from the EUT measured in the frequency range between 0.15 MHz and 30 MHz using CISPR Quasi-Peak and average detector mode. The bandwidth of EMI test receiver is set at 9 kHz.

The arrangement of the equipment is installed to meet the standards and operating in a manner, which tends to maximize its emission characteristics in a normal application.

### TEST SETUP

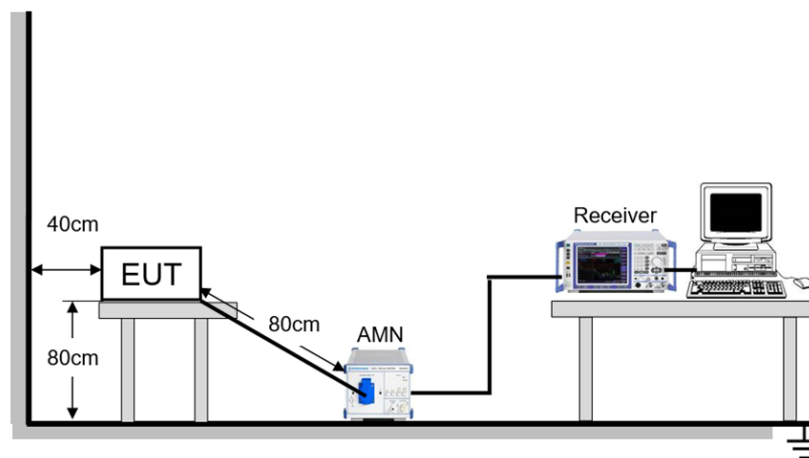

**TEST ENVIRONMENT**

Temperature	23.8°C	Relative Humidity	58%
Atmosphere Pressure	101kPa	Test Voltage	AC 120 V, 60 Hz

**TEST DATE / ENGINEER**

Test Date	July 22, 2023	Test By	Wite Chen
-----------	---------------	---------	-----------

**TEST RESULTS**

Test Mode:	802.11b	Channel:	2412
Line:	Line	Test Voltage:	AC 120 V, 60 Hz

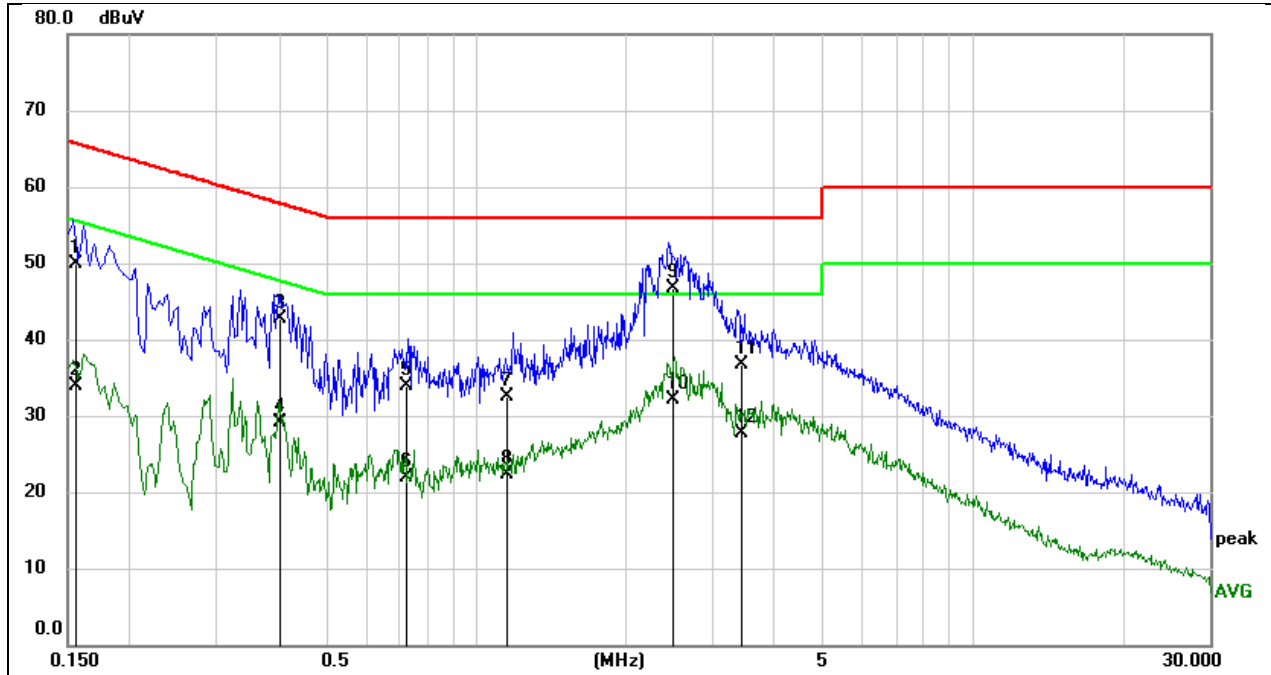

No.	Frequency (MHz)	Reading (dBuV)	Correct (dB)	Result (dBuV)	Limit (dBuV)	Margin (dB)	Remark
1	0.1560	40.31	9.50	49.81	65.67	-15.86	QP
2	0.1560	24.31	9.50	33.81	55.67	-21.86	AVG
3	0.4012	33.20	9.53	42.73	57.83	-15.10	QP
4	0.4012	19.52	9.53	29.05	47.83	-18.78	AVG
5	0.7198	24.46	9.50	33.96	56.00	-22.04	QP
6	0.7198	12.35	9.50	21.85	46.00	-24.15	AVG
7	1.1591	22.89	9.53	32.42	56.00	-23.58	QP
8	1.1591	12.72	9.53	22.25	46.00	-23.75	AVG
9	2.4982	37.09	9.62	46.71	56.00	-9.29	QP
10	2.4982	22.50	9.62	32.12	46.00	-13.88	AVG
11	3.4345	27.02	9.61	36.63	56.00	-19.37	QP
12	3.4345	18.01	9.61	27.62	46.00	-18.38	AVG

**Note:**

1. Result = Reading + Correct Factor.
2. If QP Result complies with AV limit, AV Result is deemed to comply with AV limit.
3. Test setup: RBW: 200 Hz (9 kHz ~ 150 kHz), 9 kHz (150 kHz ~ 30 MHz).
4. Step size: 80 Hz (0.009 MHz ~ 0.15 MHz), 4 kHz (0.15 MHz ~ 30 MHz), Scan time: auto.

Note: All the modes have been tested, only the worst data was recorded in the report.

Test Mode:	802.11b	Channel:	2412
Line:	Neutral	Test Voltage:	AC 120 V, 60 Hz

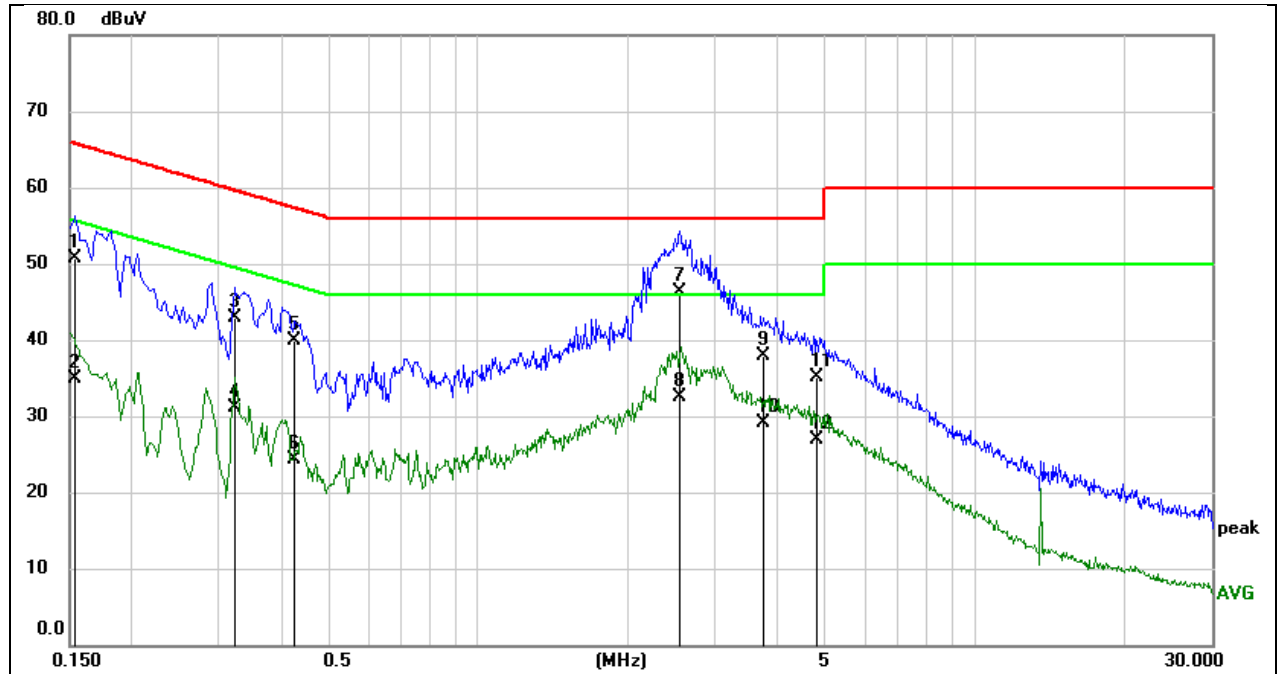

No.	Frequency (MHz)	Reading (dBuV)	Correct (dB)	Result (dBuV)	Limit (dBuV)	Margin (dB)	Remark
1	0.1527	41.24	9.50	50.74	65.85	-15.11	QP
2	0.1527	25.43	9.50	34.93	55.85	-20.92	AVG
3	0.3234	33.31	9.55	42.86	59.62	-16.76	QP
4	0.3234	21.62	9.55	31.17	49.62	-18.45	AVG
5	0.4240	30.34	9.53	39.87	57.37	-17.50	QP
6	0.4240	14.80	9.53	24.33	47.37	-23.04	AVG
7	2.5579	36.65	9.62	46.27	56.00	-9.73	QP
8	2.5579	22.93	9.62	32.55	46.00	-13.45	AVG
9	3.7518	28.20	9.61	37.81	56.00	-18.19	QP
10	3.7518	19.47	9.61	29.08	46.00	-16.92	AVG
11	4.8081	25.57	9.61	35.18	56.00	-20.82	QP
12	4.8081	17.29	9.61	26.90	46.00	-19.10	AVG

**Note:**

1. Result = Reading + Correct Factor.
2. If QP Result complies with AV limit, AV Result is deemed to comply with AV limit.
3. Test setup: RBW: 200 Hz (9 kHz ~ 150 kHz), 9 kHz (150 kHz ~ 30 MHz).
4. Step size: 80 Hz (0.009 MHz ~ 0.15 MHz), 4 kHz (0.15 MHz ~ 30 MHz), Scan time: auto.

Note: All the modes have been tested, only the worst data was recorded in the report.

## 11. TEST DATA

### 11.1. APPENDIX A: DTS BANDWIDTH

#### 11.1.1. Test Result

Test Mode	Antenna	Channel	DTS BW [MHz]	FL[MHz]	FH[MHz]	Limit[MHz]	Verdict
11B-CDD	Ant2	2412	13.52	2405.24	2418.76	0.5	PASS
	Ant5	2412	13.36	2405.40	2418.76	0.5	PASS
	Ant8	2412	13.52	2405.24	2418.76	0.5	PASS
	Ant11	2412	13.36	2405.40	2418.76	0.5	PASS
	Ant2	2417	13.36	2410.40	2423.76	0.5	PASS
	Ant5	2417	13.32	2410.40	2423.72	0.5	PASS
	Ant8	2417	13.32	2410.44	2423.76	0.5	PASS
	Ant11	2417	13.32	2410.44	2423.76	0.5	PASS
	Ant2	2437	13.32	2430.40	2443.72	0.5	PASS
	Ant5	2437	13.36	2430.40	2443.76	0.5	PASS
	Ant8	2437	12.88	2430.88	2443.76	0.5	PASS
	Ant11	2437	13.36	2430.40	2443.76	0.5	PASS
	Ant2	2457	13.36	2450.40	2463.76	0.5	PASS
	Ant5	2457	13.36	2450.40	2463.76	0.5	PASS
	Ant8	2457	13.28	2450.44	2463.72	0.5	PASS
	Ant11	2457	13.80	2449.96	2463.76	0.5	PASS
Ant2	2462	12.96	2455.80	2468.76	0.5	PASS	
Ant5	2462	13.36	2455.40	2468.76	0.5	PASS	
Ant8	2462	13.32	2455.44	2468.76	0.5	PASS	
Ant11	2462	13.36	2455.40	2468.76	0.5	PASS	
11G-CDD	Ant2	2412	16.48	2403.76	2420.24	0.5	PASS
	Ant5	2412	16.48	2403.76	2420.24	0.5	PASS
	Ant8	2412	16.48	2403.76	2420.24	0.5	PASS
	Ant11	2412	16.48	2403.76	2420.24	0.5	PASS
	Ant2	2417	16.48	2408.76	2425.24	0.5	PASS
	Ant5	2417	16.48	2408.76	2425.24	0.5	PASS
	Ant8	2417	16.44	2408.76	2425.20	0.5	PASS
	Ant11	2417	16.44	2408.76	2425.20	0.5	PASS
	Ant2	2437	16.44	2428.76	2445.20	0.5	PASS
	Ant5	2437	16.48	2428.76	2445.24	0.5	PASS
	Ant8	2437	16.48	2428.76	2445.24	0.5	PASS
	Ant11	2437	16.48	2428.76	2445.24	0.5	PASS
	Ant2	2457	16.48	2448.76	2465.24	0.5	PASS
	Ant5	2457	16.48	2448.76	2465.24	0.5	PASS
	Ant8	2457	16.48	2448.76	2465.24	0.5	PASS
	Ant11	2457	16.48	2448.76	2465.24	0.5	PASS
Ant2	2462	16.48	2453.76	2470.24	0.5	PASS	
Ant5	2462	16.48	2453.76	2470.24	0.5	PASS	
Ant8	2462	16.48	2453.76	2470.24	0.5	PASS	
Ant11	2462	16.48	2453.76	2470.24	0.5	PASS	
11BE20MIMO	Ant2	2412	18.96	2402.52	2421.48	0.5	PASS
	Ant5	2412	18.92	2402.56	2421.48	0.5	PASS
	Ant8	2412	19.16	2402.40	2421.56	0.5	PASS
	Ant11	2412	18.92	2402.56	2421.48	0.5	PASS
	Ant2	2417	19.00	2407.48	2426.48	0.5	PASS
	Ant5	2417	18.96	2407.48	2426.44	0.5	PASS
	Ant8	2417	18.92	2407.52	2426.44	0.5	PASS
	Ant11	2417	19.08	2407.48	2426.56	0.5	PASS
	Ant2	2437	18.88	2427.60	2446.48	0.5	PASS
	Ant5	2437	18.92	2427.48	2446.40	0.5	PASS
	Ant8	2437	18.96	2427.48	2446.44	0.5	PASS
	Ant11	2437	18.88	2427.56	2446.44	0.5	PASS
Ant2	2457	18.92	2447.48	2466.40	0.5	PASS	

	Ant5	2457	19.04	2447.48	2466.52	0.5	PASS
	Ant8	2457	19.04	2447.44	2466.48	0.5	PASS
	Ant11	2457	19.12	2447.44	2466.56	0.5	PASS
	Ant2	2462	18.84	2452.56	2471.40	0.5	PASS
	Ant5	2462	18.80	2452.48	2471.28	0.5	PASS
	Ant8	2462	19.00	2452.48	2471.48	0.5	PASS
11BE40MIMO	Ant11	2462	19.00	2452.48	2471.48	0.5	PASS
	Ant2	2422	38.32	2402.88	2441.20	0.5	PASS
	Ant5	2422	38.32	2402.88	2441.20	0.5	PASS
	Ant8	2422	38.24	2402.88	2441.12	0.5	PASS
	Ant11	2422	38.24	2402.88	2441.12	0.5	PASS
	Ant2	2427	38.16	2407.88	2446.04	0.5	PASS
	Ant5	2427	38.24	2407.88	2446.12	0.5	PASS
	Ant8	2427	38.16	2407.96	2446.12	0.5	PASS
	Ant11	2427	38.16	2407.88	2446.04	0.5	PASS
	Ant2	2437	38.24	2417.88	2456.12	0.5	PASS
	Ant5	2437	38.24	2417.88	2456.12	0.5	PASS
	Ant8	2437	38.24	2417.88	2456.12	0.5	PASS
	Ant11	2437	38.16	2417.96	2456.12	0.5	PASS
	Ant2	2447	38.16	2427.96	2466.12	0.5	PASS
	Ant5	2447	38.32	2427.88	2466.20	0.5	PASS
	Ant8	2447	38.24	2427.88	2466.12	0.5	PASS
	Ant11	2447	38.24	2427.88	2466.12	0.5	PASS
	Ant2	2452	38.24	2432.88	2471.12	0.5	PASS
	Ant5	2452	38.32	2432.88	2471.20	0.5	PASS
	Ant8	2452	38.24	2432.88	2471.12	0.5	PASS
Ant11	2452	38.16	2432.96	2471.12	0.5	PASS	

### 11.1.2. Test Graphs

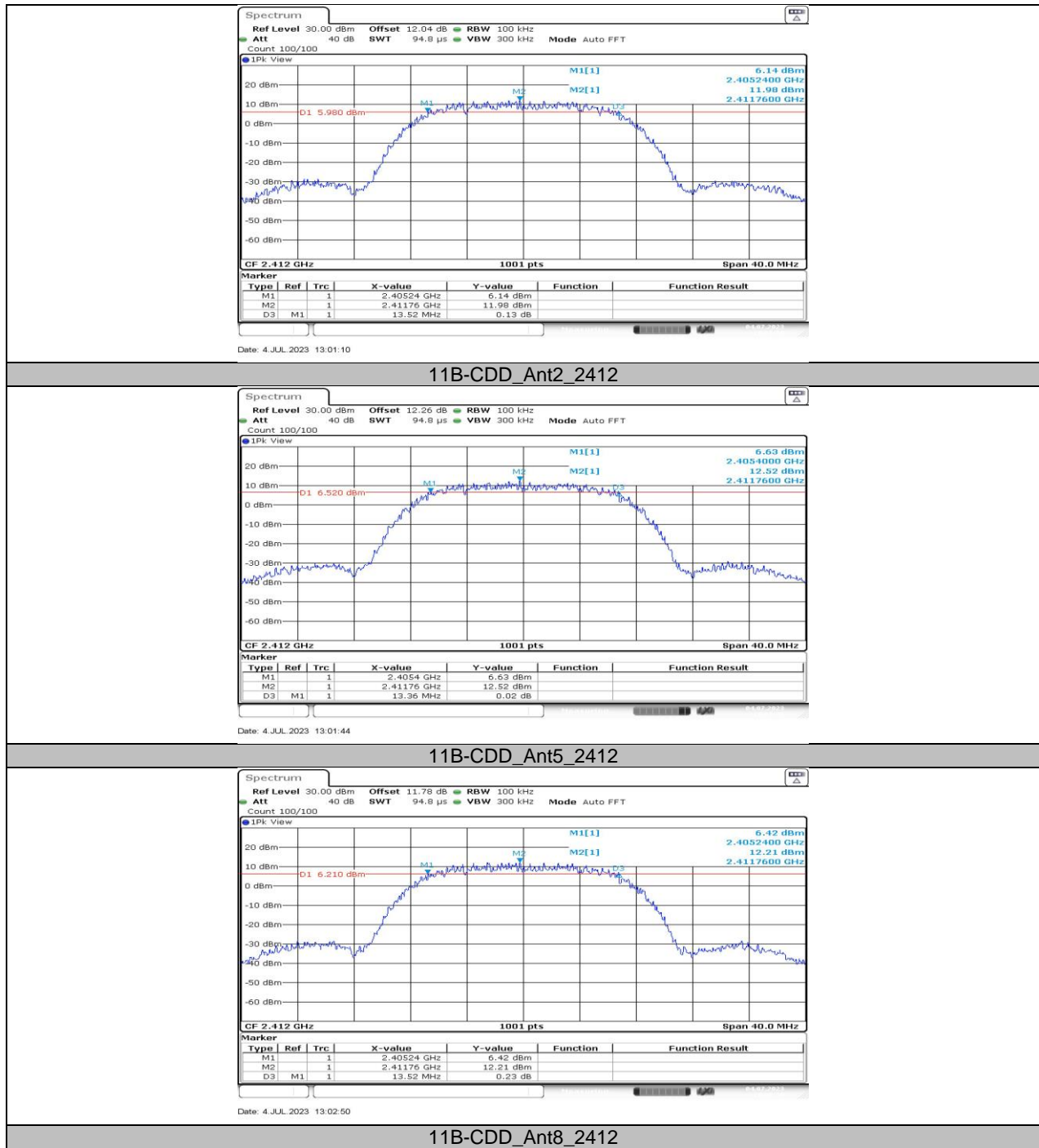

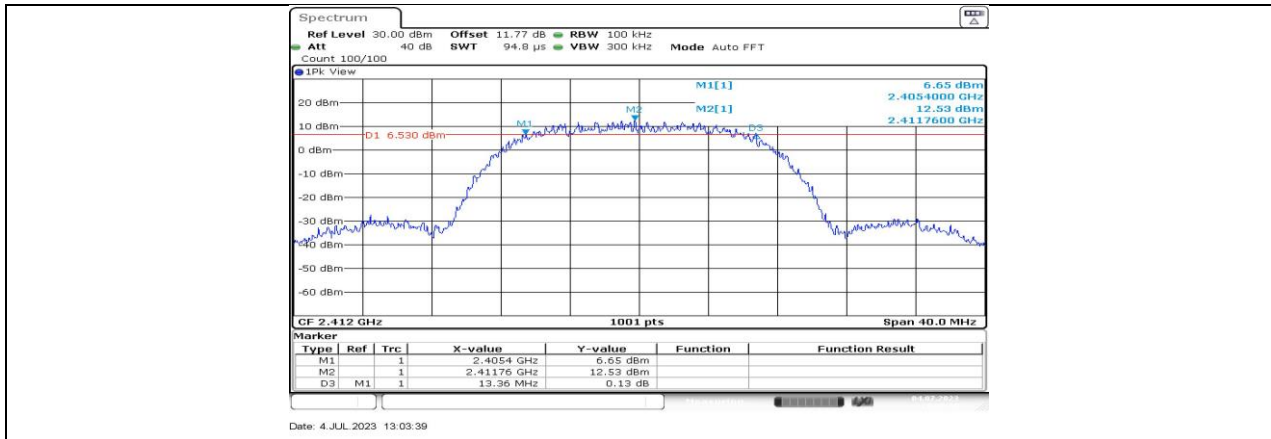

11B-CDD\_Ant11\_2412

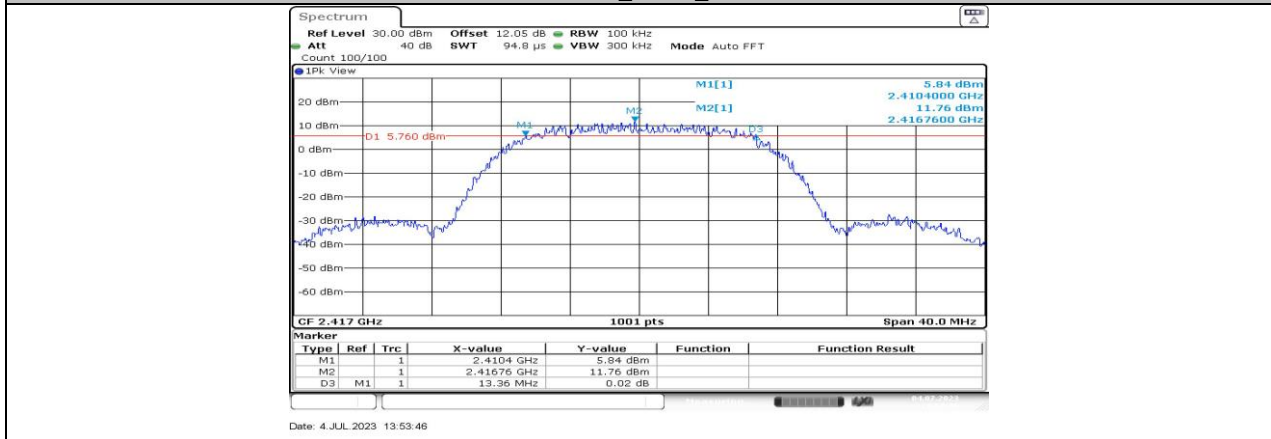

11B-CDD\_Ant2\_2417

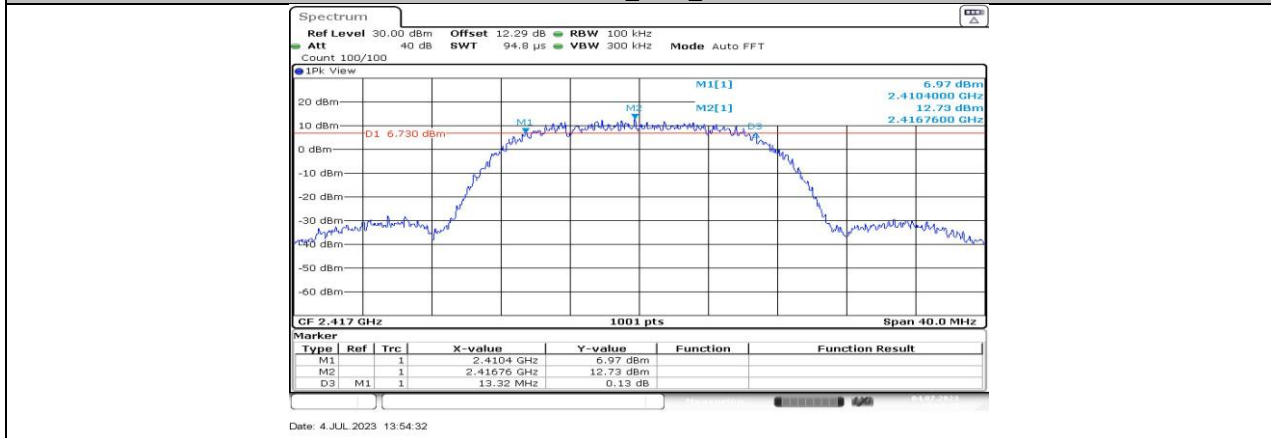

11B-CDD\_Ant5\_2417



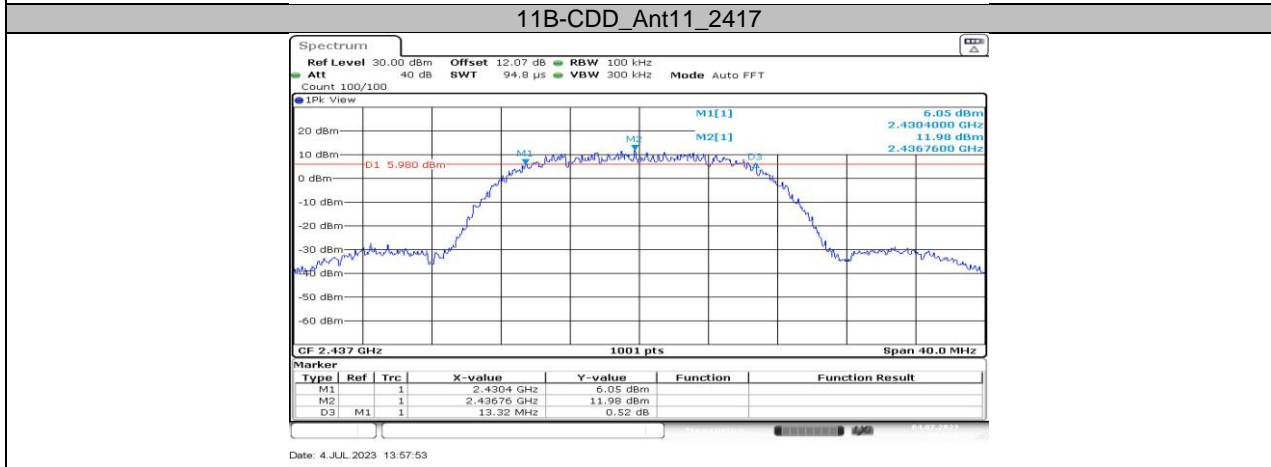
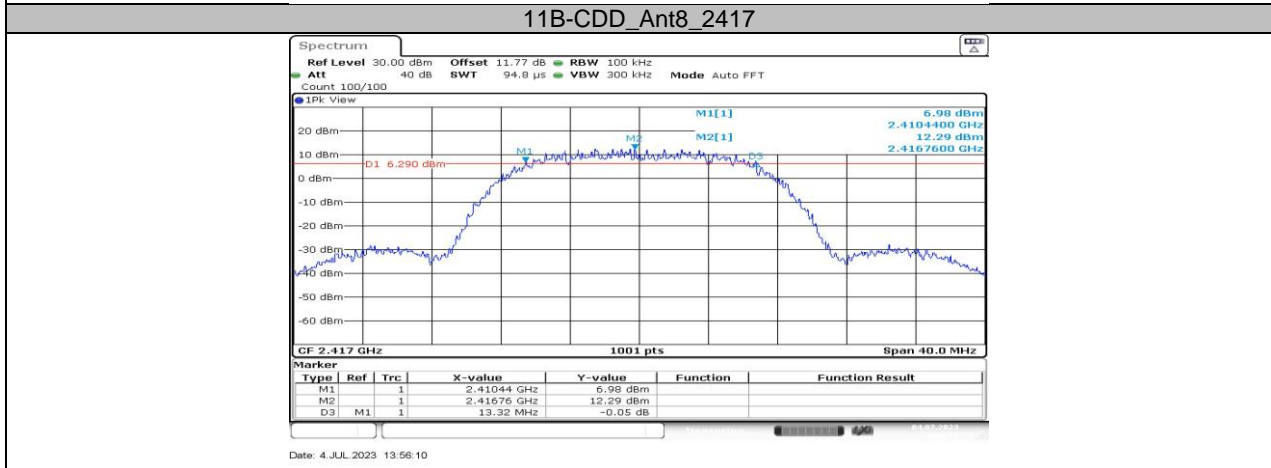
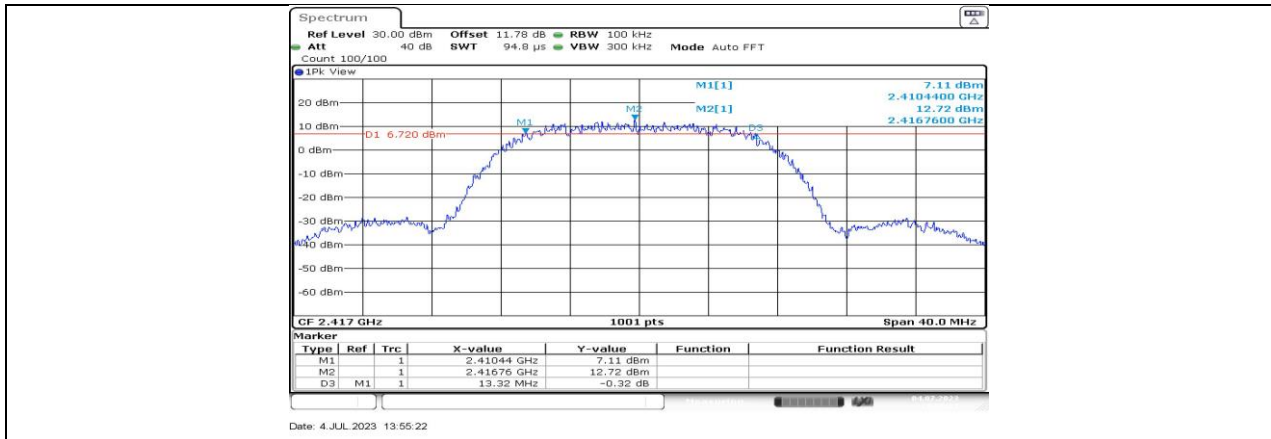

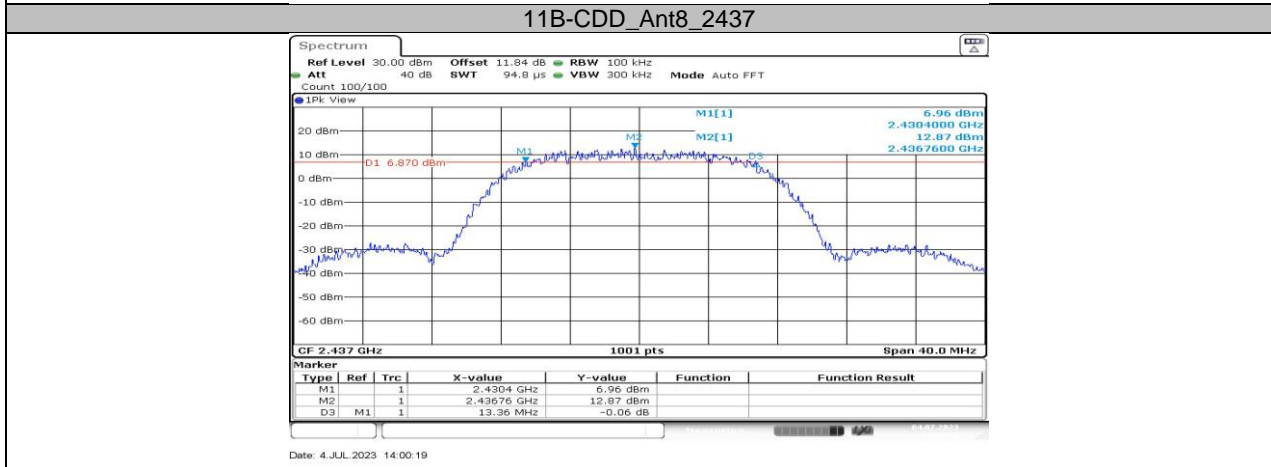
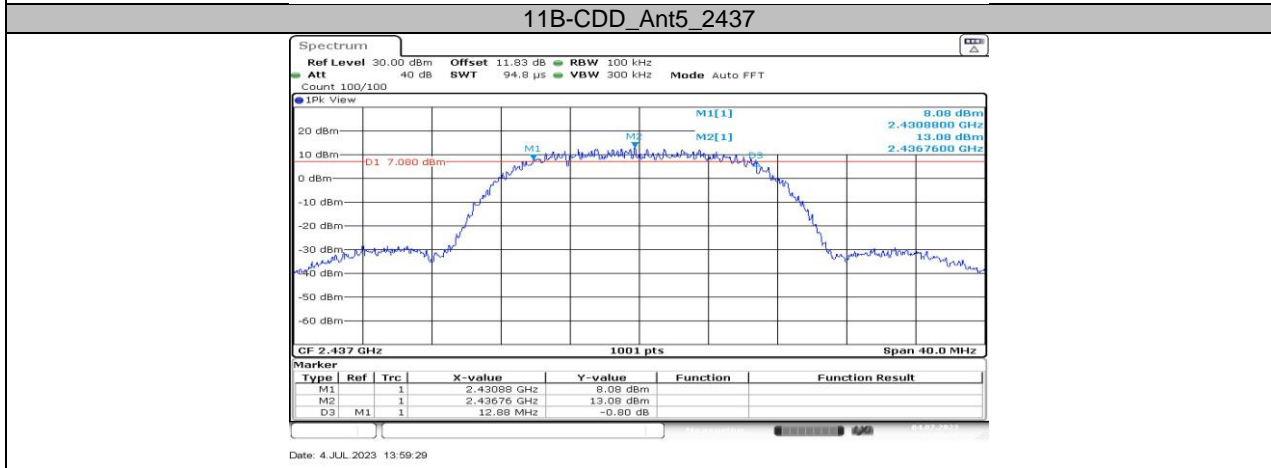
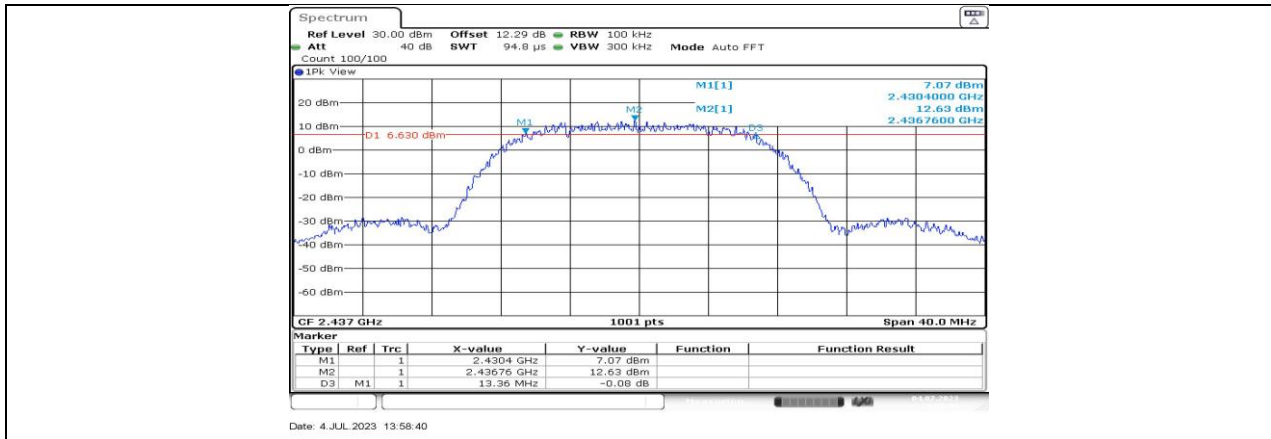

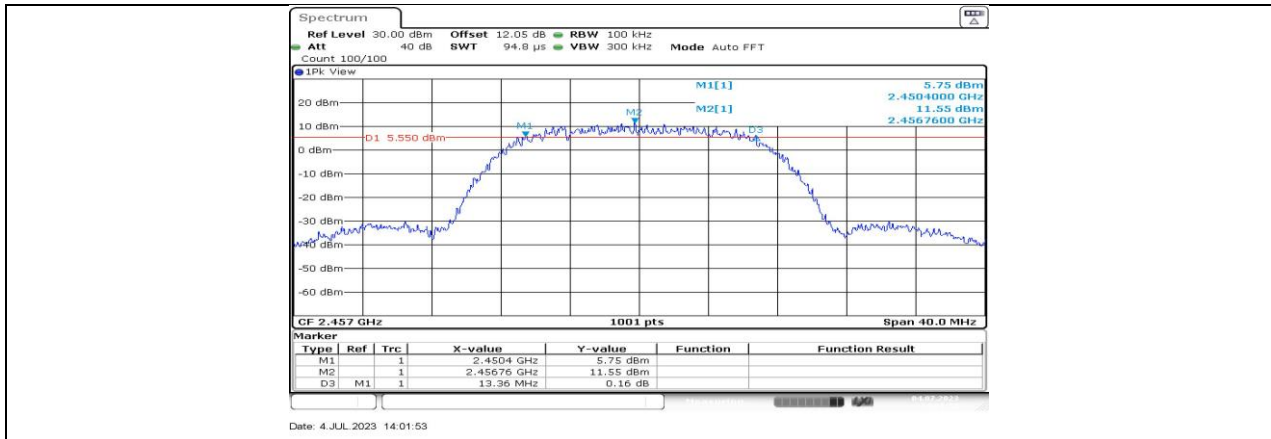

11B-CDD\_Ant2\_2457

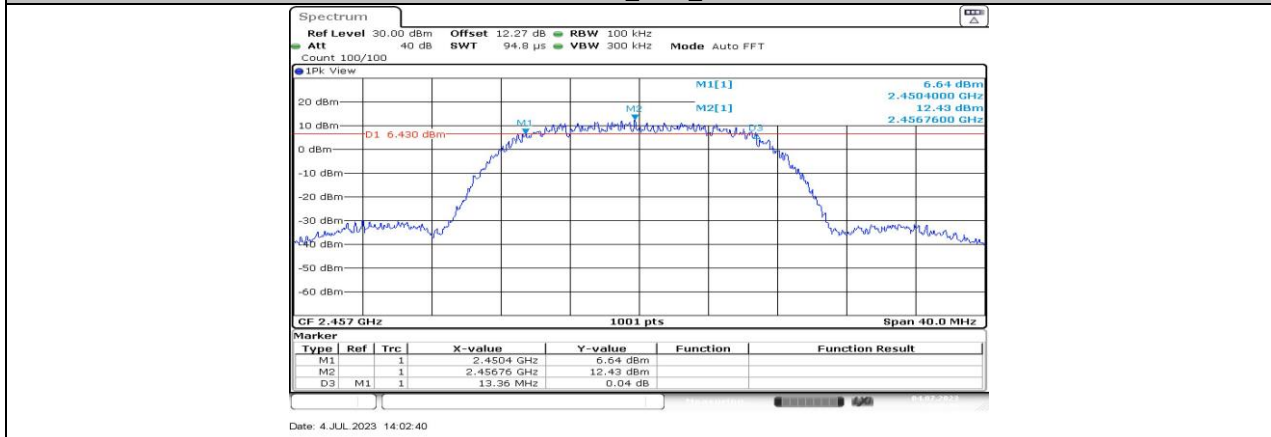

11B-CDD\_Ant5\_2457

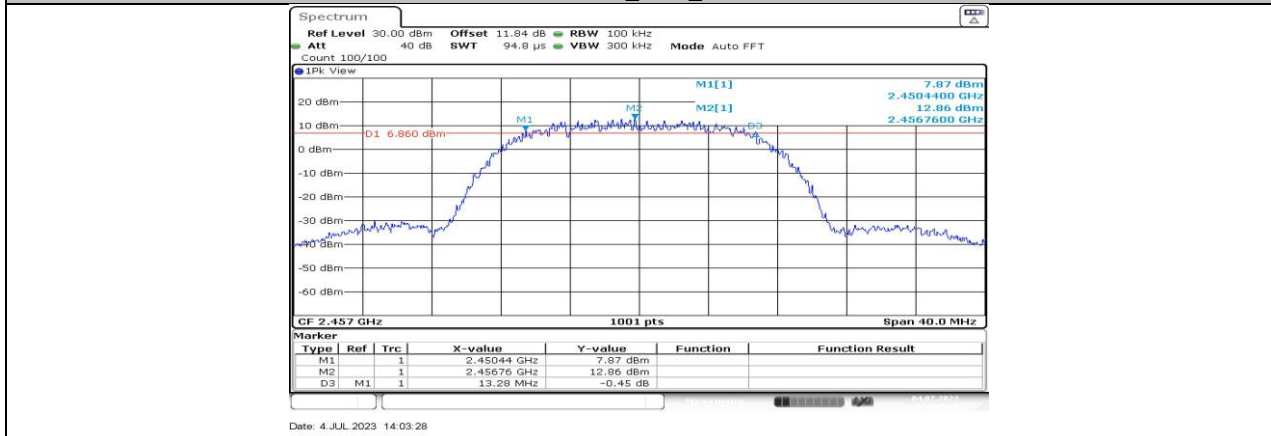

11B-CDD\_Ant8\_2457

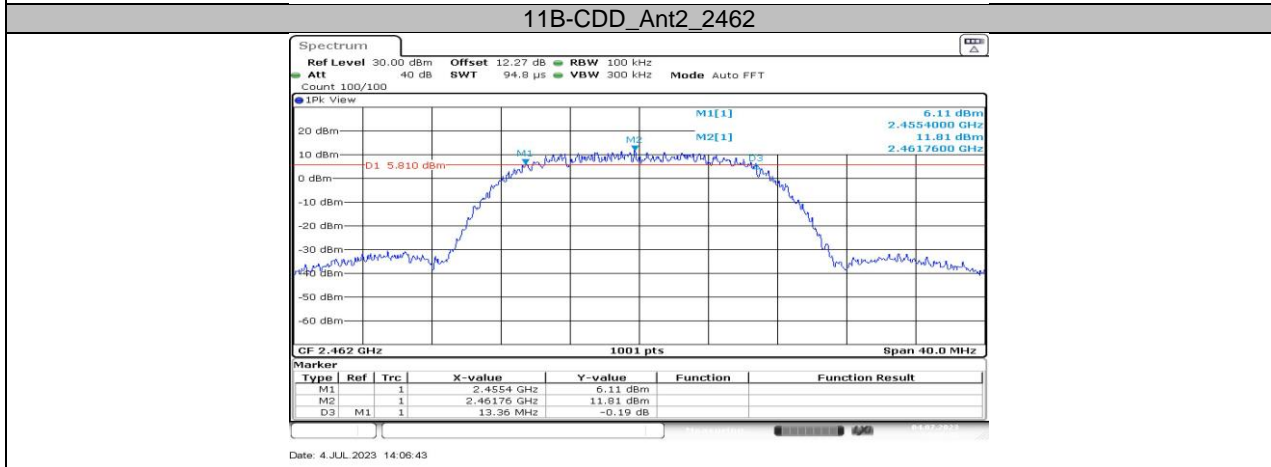
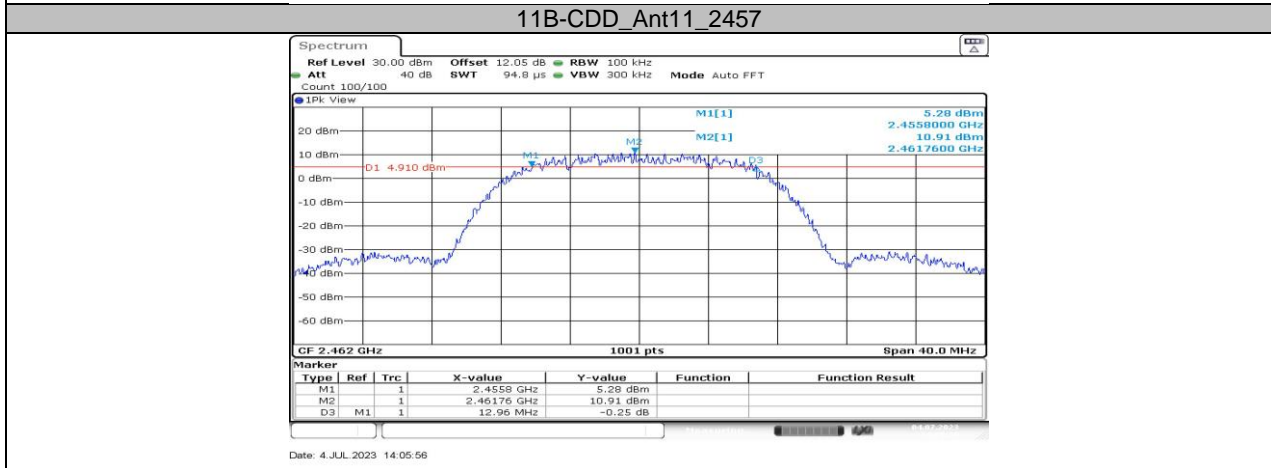
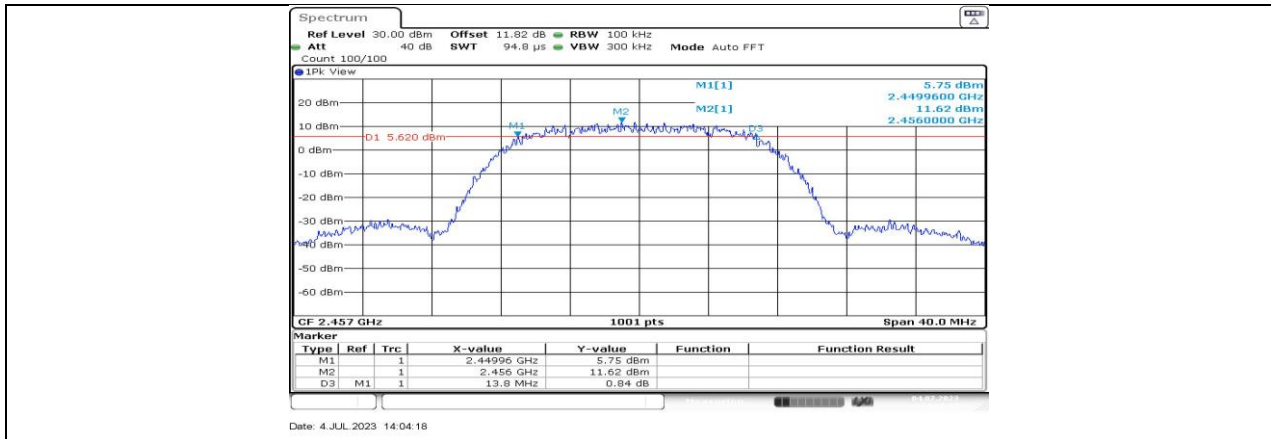

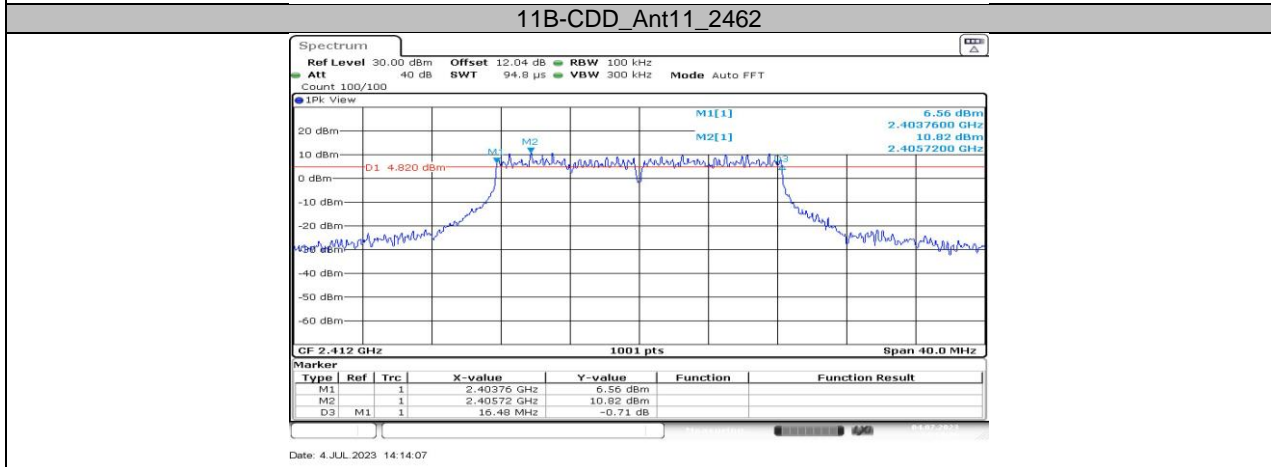
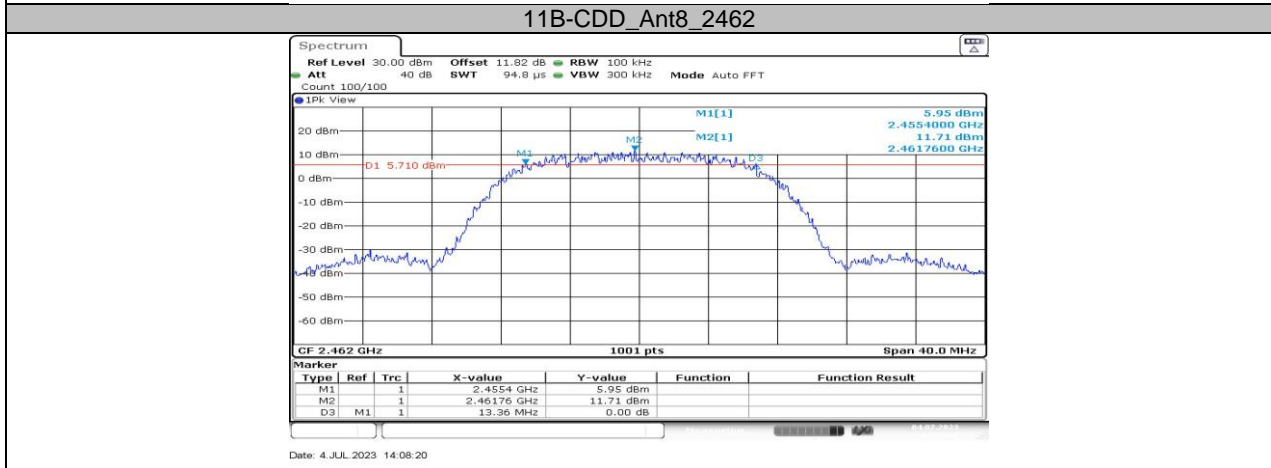
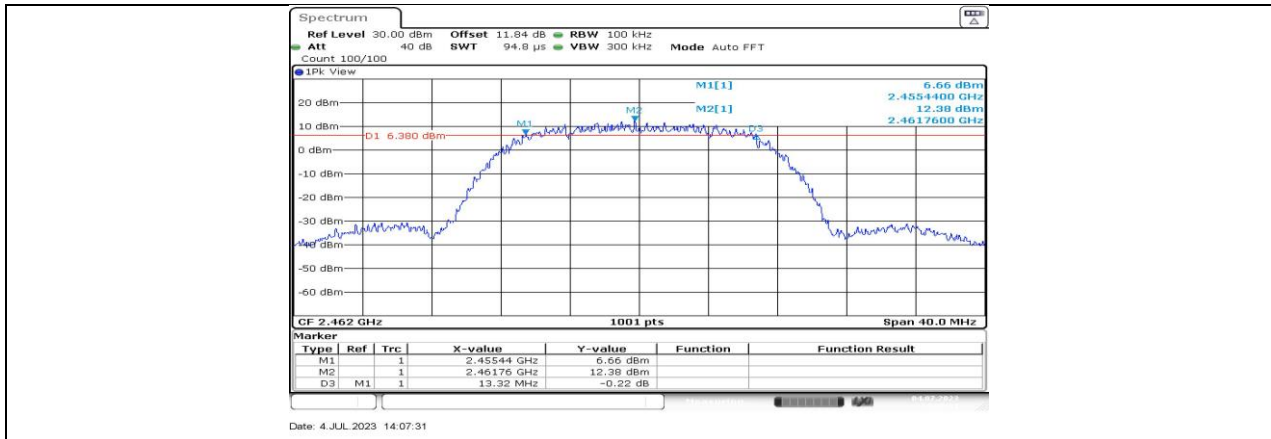

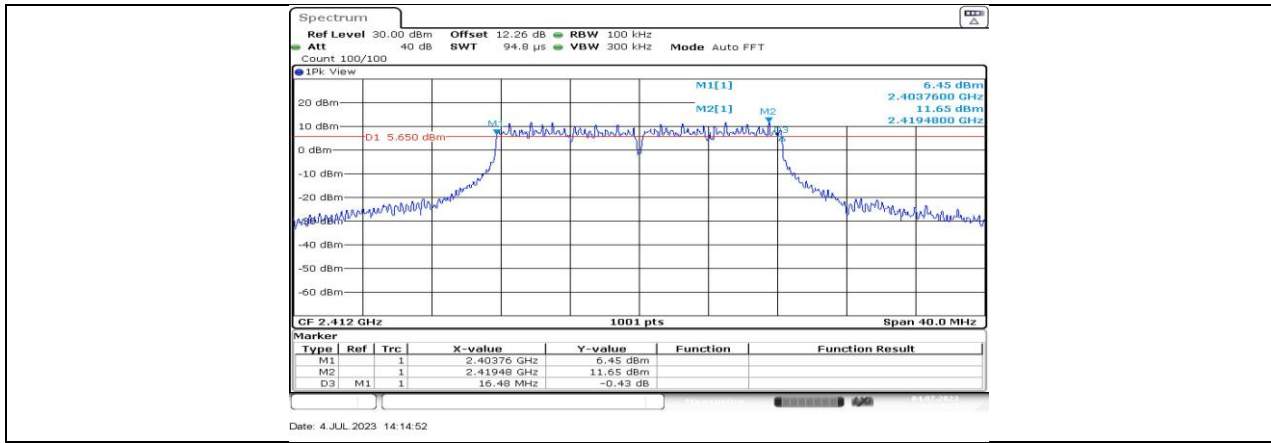

11G-CDD\_Ant5\_2412

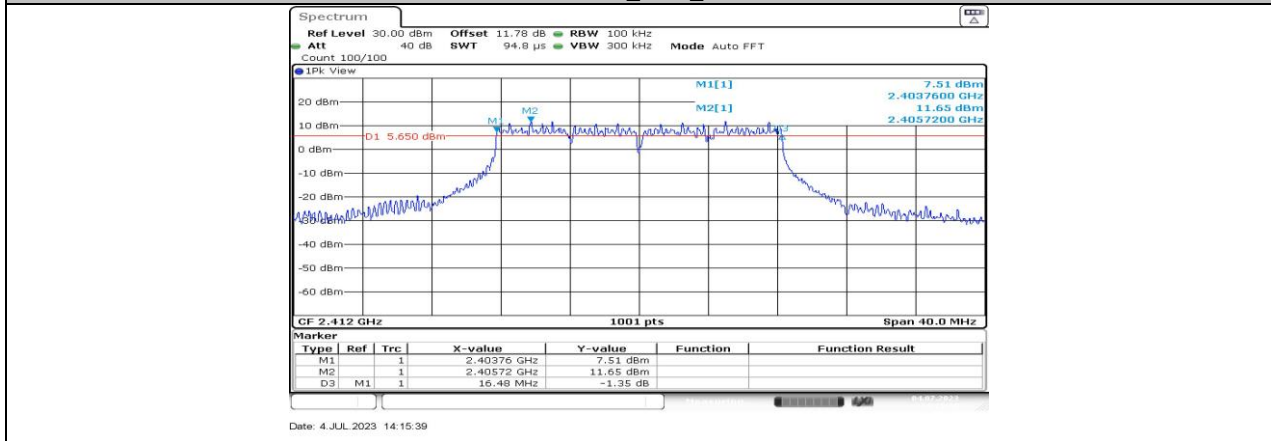

11G-CDD\_Ant8\_2412

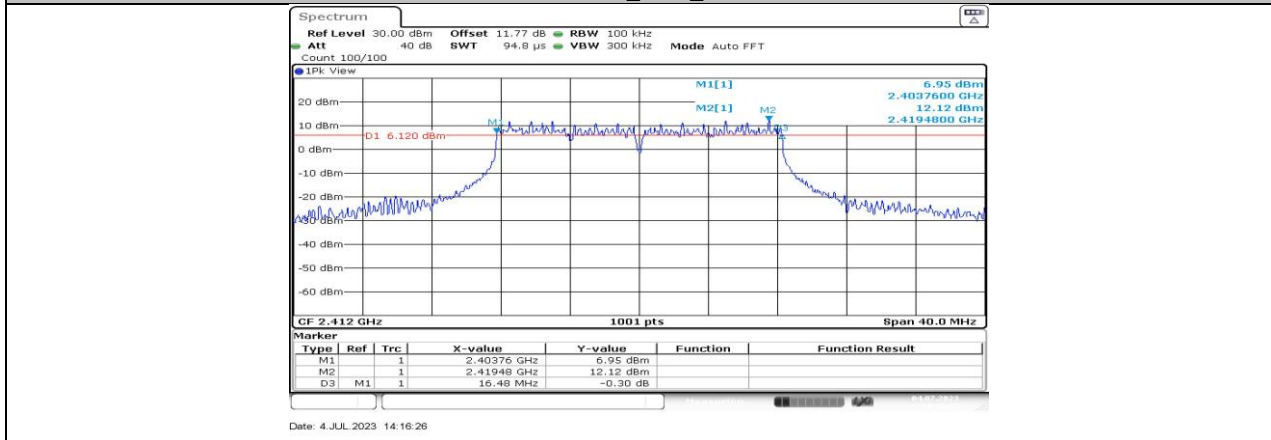

11G-CDD\_Ant11\_2412

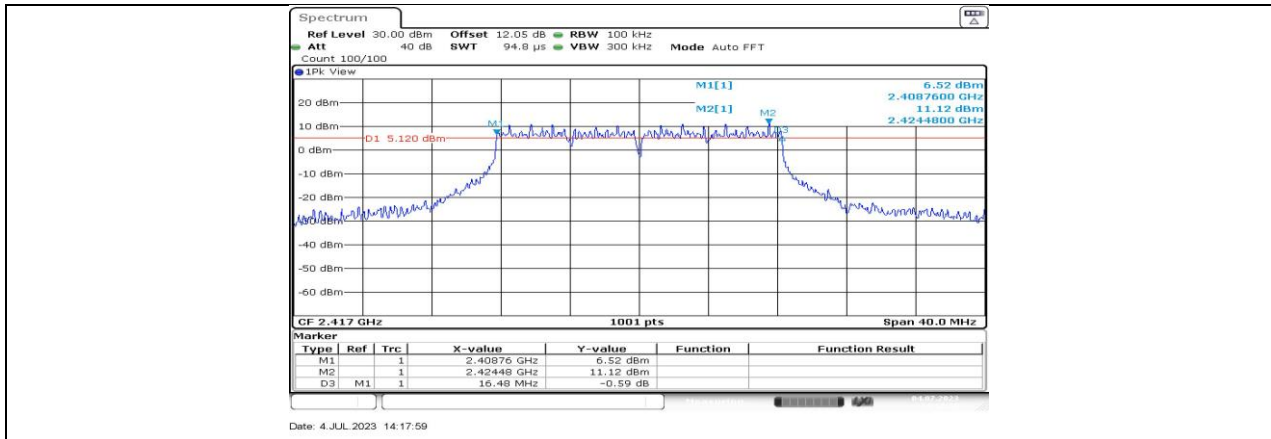

11G-CDD\_Ant2\_2417

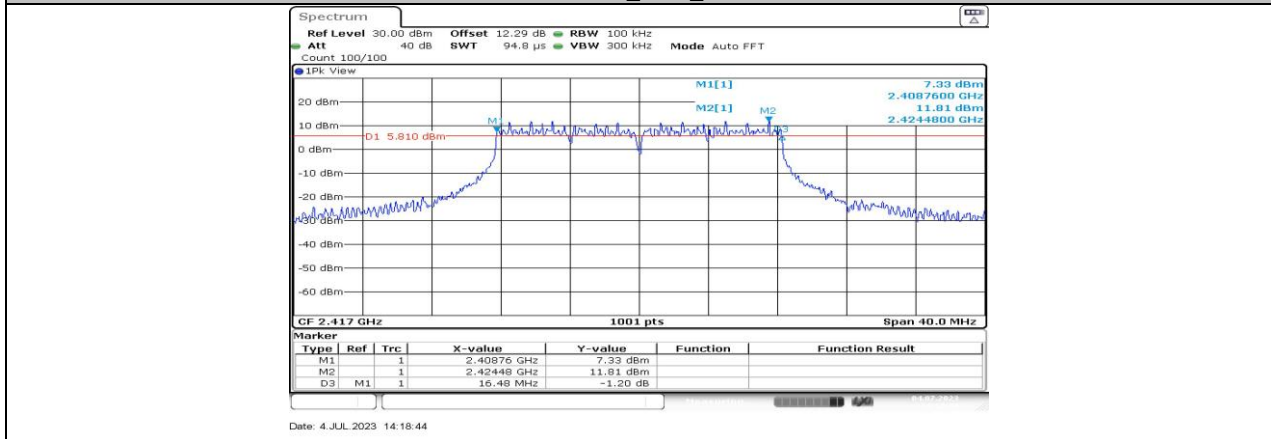

11G-CDD\_Ant5\_2417

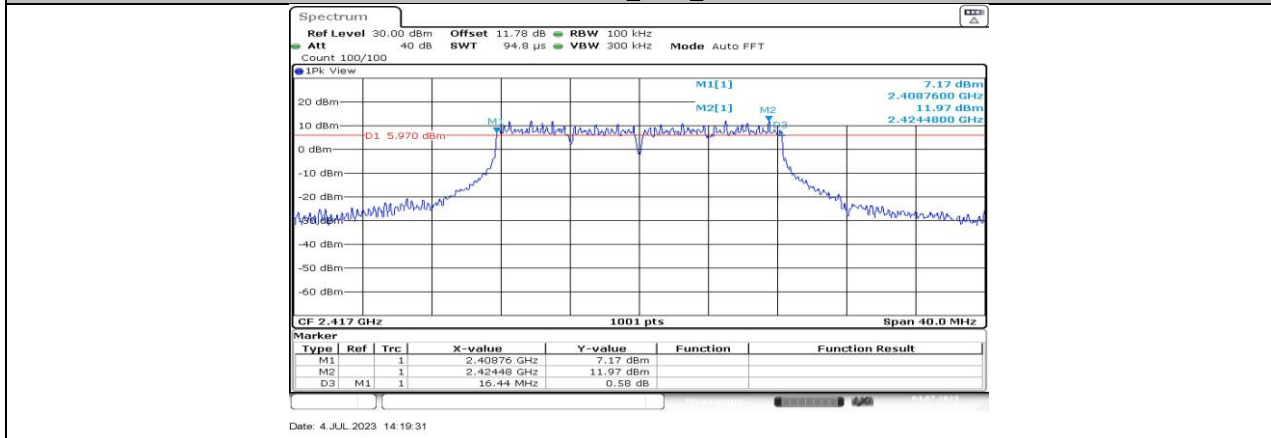

11G-CDD\_Ant8\_2417

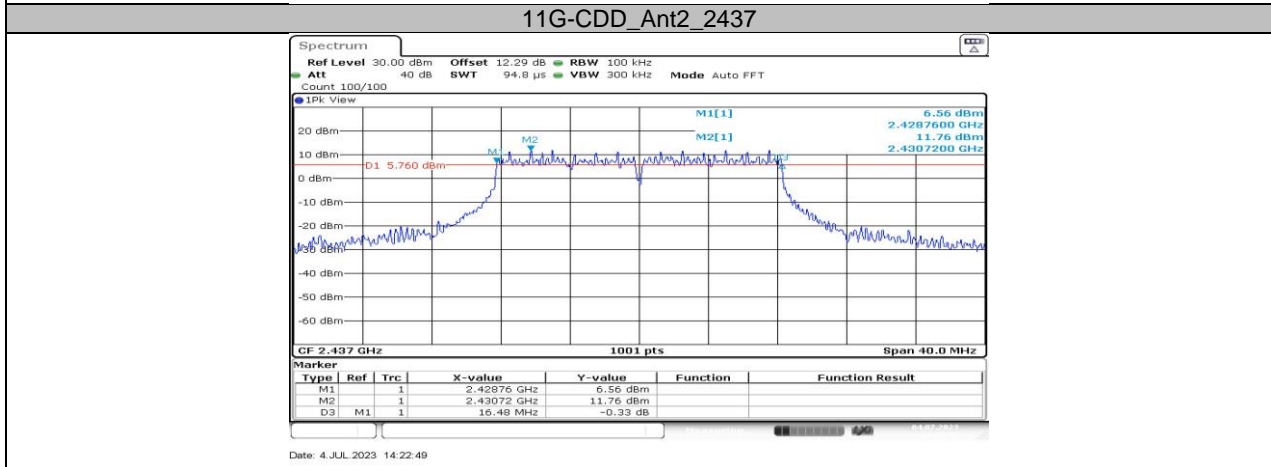
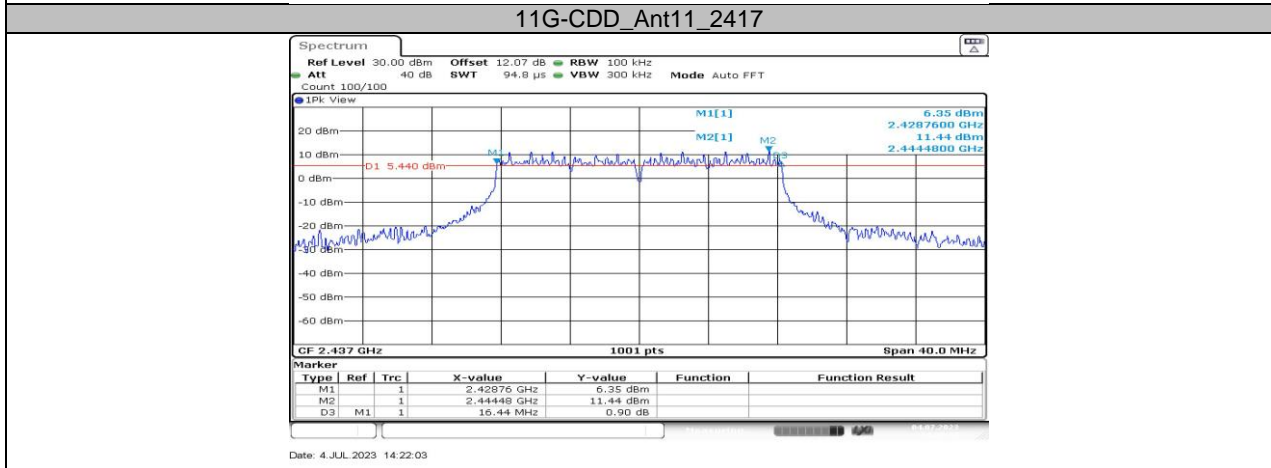
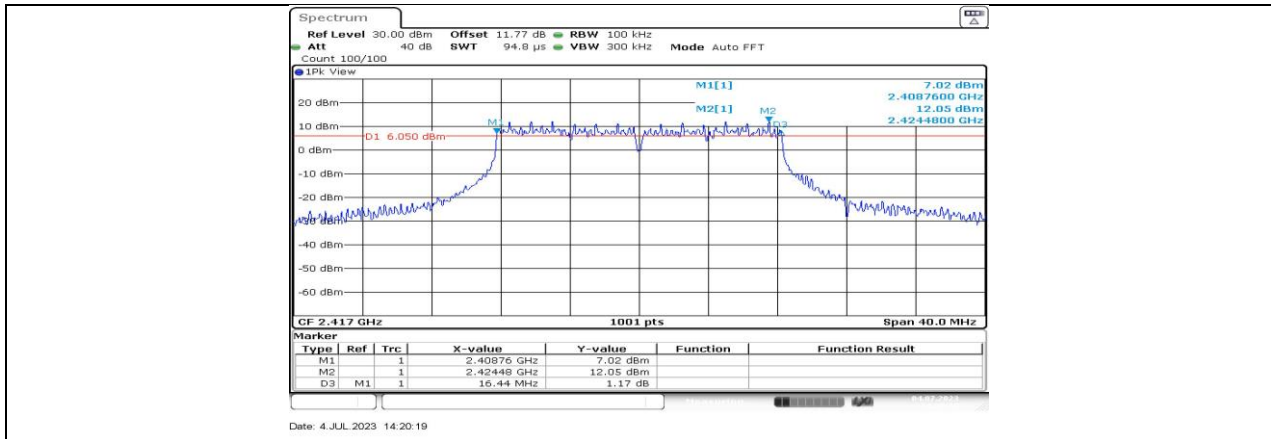



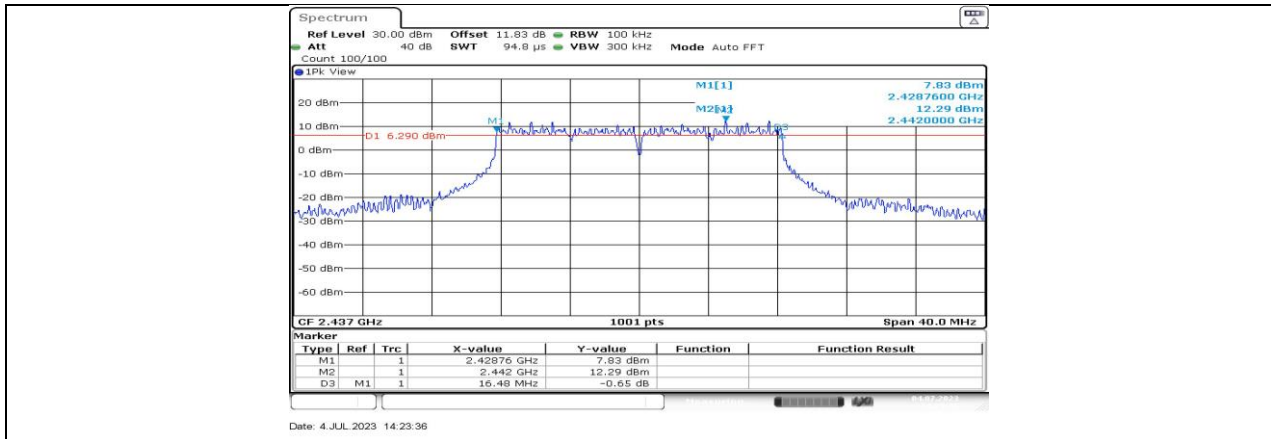

11G-CDD\_Ant8\_2437

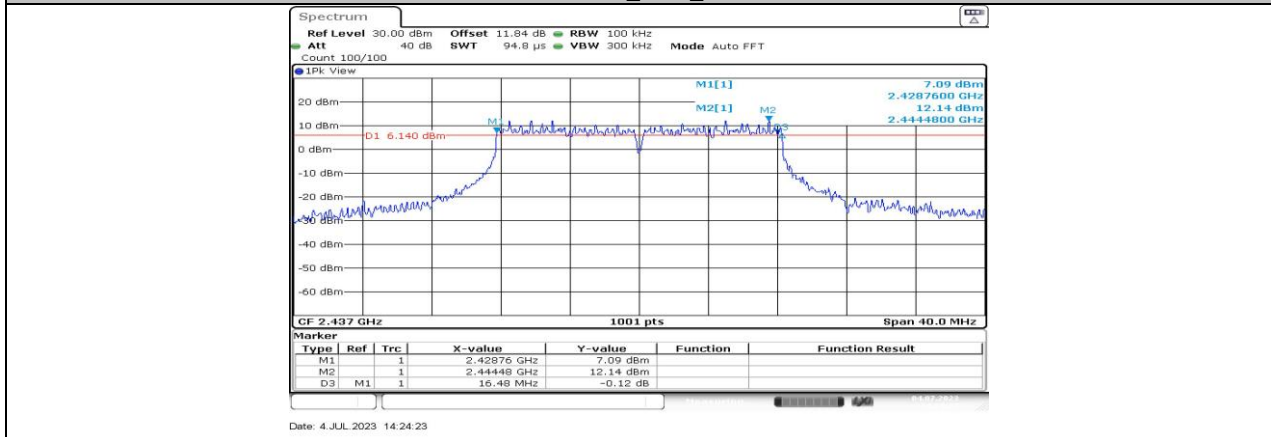

11G-CDD\_Ant11\_2437

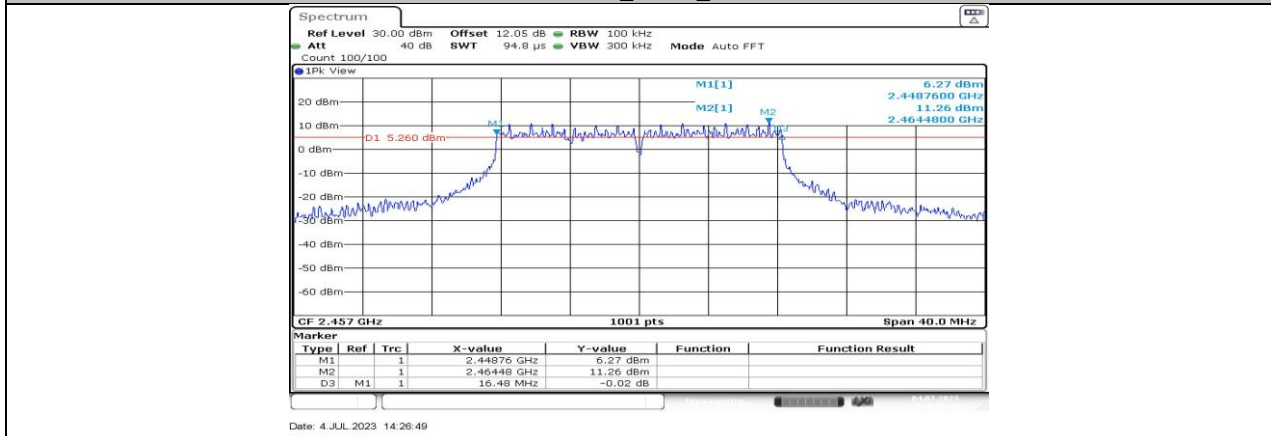

11G-CDD\_Ant2\_2457

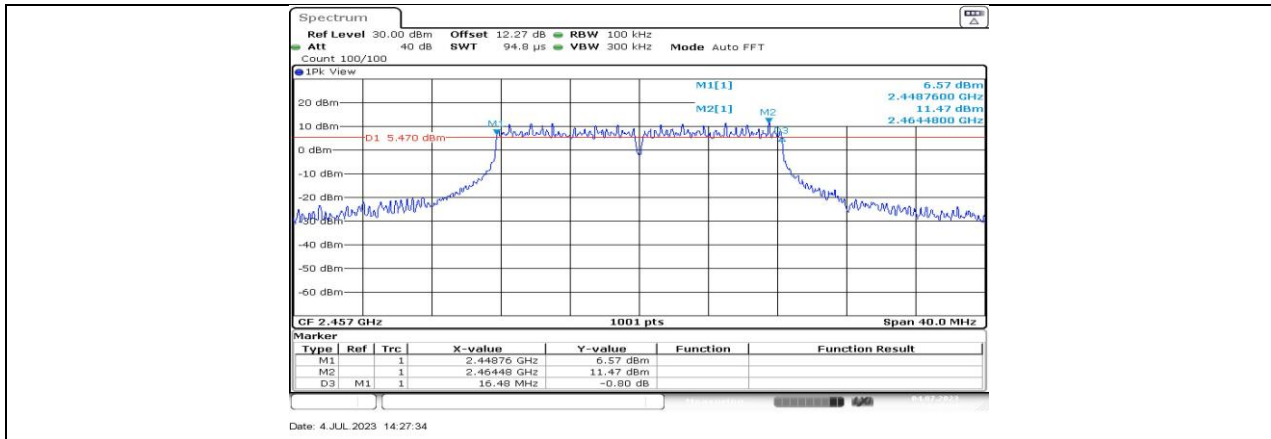

11G-CDD\_Ant5\_2457

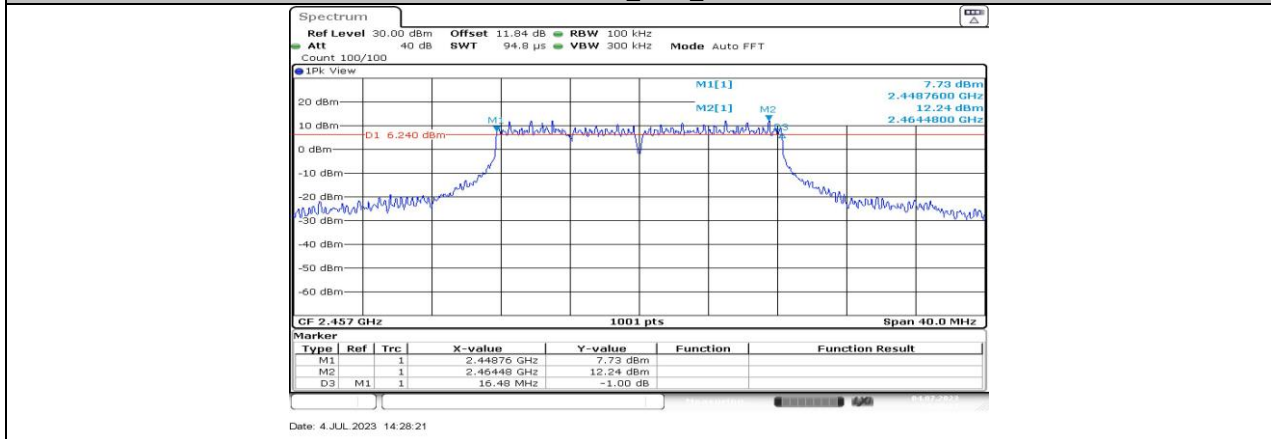

11G-CDD\_Ant8\_2457

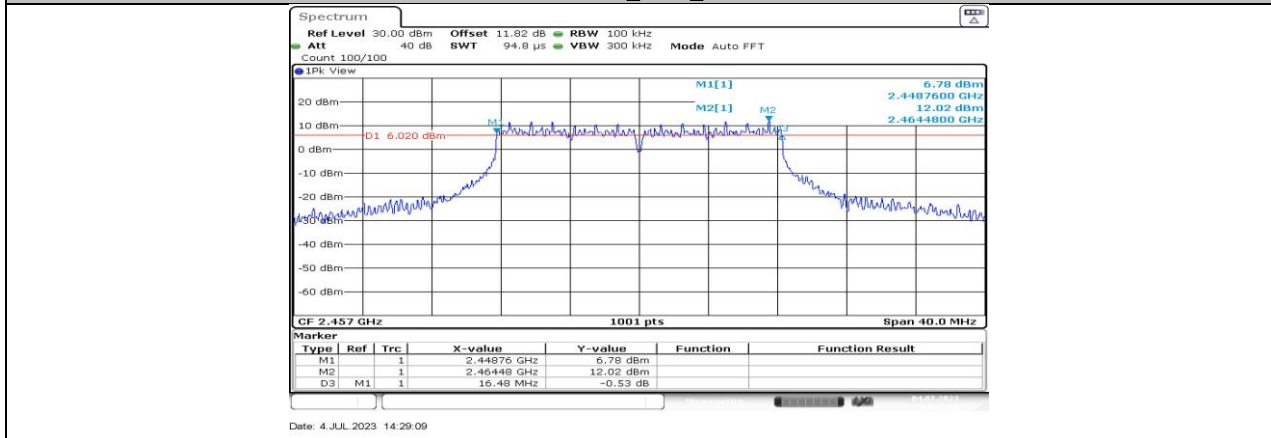

11G-CDD\_Ant11\_2457

