

Test Report

FCC ID: 2AXIE-SW02WU

Date of issue: Oct. 28, 2020

Report number: MTi20082708-2E1

Sample description: SMART MINI CORD

Model(s): HKWL-SW02WU, CS-MINI-CORD

Applicant: HANK SMART TECH CO., LTD

Address: Unit 1419, floor 14th, Block5, Cloud Park Phase 2, Bantian street,
Longgang District, Shenzhen China

Date of test: Oct. 19, 2020 to Oct. 28, 2020

Shenzhen Microtest Co., Ltd.
<http://www.mtitest.com>

This test report is valid for the tested samples only. It cannot be reproduced except in full without prior written consent of Shenzhen Microtest Co., Ltd.

Tel: (86-755) 88850135

Fax: (86-755) 88850136

Web: <http://www.mtitest.com>

E-mail: mti@51mti.com

Address: 101, No. 7, Zone 2, Xinxing Industrial Park, Fuhai Avenue, Xinhe Community, Fuhai Street, Bao' an District, Shenzhen, Guangdong, China.

Table of Contents

1	GENERAL INFORMATION	5
1.1	DESCRIPTION OF EUT	5
1.2	OPERATION CHANNEL LIST	6
1.3	TEST CHANNEL LIST	6
1.4	ANCILLARY EQUIPMENT LIST	6
1.5	DESCRIPTION OF SUPPORT UNITS	7
2	SUMMARY OF TEST RESULTS	8
3	TEST FACILITIES AND ACCREDITATIONS	9
3.1	TEST LABORATORY	9
3.2	ENVIRONMENTAL CONDITIONS	9
3.3	MEASUREMENT UNCERTAINTY	9
3.4	TEST SOFTWARE	9
4	EQUIPMENT LIST	10
5	TEST RESULT	11
5.1	ANTENNA REQUIREMENT	11
5.1.1	<i>Standard requirement</i>	11
5.1.2	<i>EUT antenna</i>	11
5.2	PEAK OUTPUT POWER	12
5.2.1	<i>Limit</i>	12
5.2.2	<i>Test setup</i>	12
5.2.3	<i>Test procedure</i>	12
5.2.4	<i>Test results</i>	13
5.3	POWER SPECTRAL DENSITY	14
5.3.1	<i>Limit</i>	14
5.3.2	<i>Test setup</i>	14
5.3.3	<i>Test procedure</i>	14
5.3.4	<i>Test results</i>	15
5.4	CONDUCTED EMISSION	19
5.4.1	<i>Limits</i>	19
5.4.2	<i>Test setup</i>	19
5.4.3	<i>Test procedure</i>	20
5.4.4	<i>Test results</i>	20
5.5	RADIATED SPURIOUS	23
5.5.1	<i>Limits</i>	23
5.5.2	<i>Test setup</i>	24
5.5.3	<i>Test procedure</i>	25
5.5.4	<i>Test results</i>	26
5.5.4.1	<i>Radiation emission</i>	26
5.5.4.2	<i>Band edge - radiated</i>	30
5.5.5	<i>Spurious Emission in Restricted Band 3260MHz-18000MHz</i>	32
5.6	BAND EDGE - CONDUCTED	33
5.6.1	<i>Limits</i>	33
5.6.2	<i>Test setup</i>	33
5.6.3	<i>Test procedure</i>	33
5.6.4	<i>Test results</i>	34
5.7	6dB BANDWIDTH	38
5.7.1	<i>Limit</i>	38
5.7.2	<i>Test setup</i>	38
5.7.3	<i>Test procedure</i>	38
5.7.4	<i>Test results</i>	38
5.8	DUTY CYCLE	47
5.8.1	<i>Limit</i>	47



5.8.2	Measuring instruments	47
5.8.3	Test setup	47
5.8.4	Test procedure	47
5.8.5	Test Results.....	48
5.9	SPURIOUS RF CONDUCTED EMISSIONS	49
5.9.1	Limit	49
5.9.2	Measuring instruments	49
5.9.3	Test setup	49
5.9.4	Test procedure.....	49
5.9.5	Test results.....	49
PHOTOGRAPHS OF THE TEST SETUP		52
PHOTOGRAPHS OF THE EUT.....		54

Test Result Certification

Applicant's name: HANK SMART TECH CO., LTD

Address: Unit 1419, floor 14th, Block5, Cloud Park Phase 2, Bantian street, Longgang District, Shenzhen China

Manufacture's name: HANK SMART TECH CO., LTD

Address: Unit 1419, floor 14th, Block5, Cloud Park Phase 2, Bantian street, Longgang District, Shenzhen China

Product name: SMART MINI CORD

Trademark: N/A

Model name: HKWL-SW02WU, CS-MINI-CORD

Standards: FCC Part 15.247

Test procedure: ANSI C63.10-2013
KDB 558074 D01 D15.247 Meas Guidance v05r02

This device described above has been tested by Shenzhen Microtest Co., Ltd. and the test results show that the equipment under test (EUT) compliance with the FCC requirements. And it is applicable only to the tested sample identified in the report.

Tested by:



Demi Mu

Oct. 28, 2020

Reviewed by:

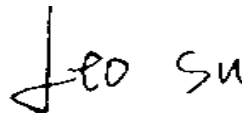

Leo Su

Oct. 28, 2020

Approved by:



Tom Xue

Oct. 28, 2020

1 General information

1.1 Description of EUT

Product name:	SMART MINI CORD
Model name:	HKWL-SW02WU
Serial model:	CS-MINI-CORD
Model difference:	All the model are the same circuit and RF module, except the appearance and model No..
Operation frequency:	802.11b/g/n20:2412~2462 MHz 802.11n40:2422~2452 MHz
Modulation type:	IEEE 802.11b : DSSS (DBPSK, DQPSK, CCK) IEEE 802.11g/n (HT20/HT40) : OFDM (64QAM, 16QAM, QPSK, BPSK)
Bit Rate of transmitter:	802.11b:11/5.5/2/1 Mbps 802.11g:54/48/36/24/18/12/9/6Mbps 802.11n(20MHz) use 800 ns GI: 65.0/58.5/52.0/39.0/26.0/19.5/13.0/6.5 Mbps (MCS0~MCS7) 802.11n(40MHz) use 800 ns GI: 13.5/27/40.5/54/81/108/121.5/135Mbps
Antenna type:	PCB Antenna
Antenna gain:	0dBi
Max. output power:	16.39dBm
Power supply:	AC 120V/60Hz
Battery:	N/A
Adapter information:	N/A
Hardware version:	HKWL_SO09W_P_V1.1
Software version:	Wi-Fi Module: 1.0.0
Serial number:	MTi20082708-2-S0001

1.2 Operation channel list

Channel List for 802.11b/g/n (20)

Channel	Frequency (MHz)	Channel	Frequency (MHz)
01	2412	07	2442
02	2417	08	2447
03	2422	09	2452
04	2427	10	2457
05	2432	11	2462
06	2437	\	\

Channel List for 802.11n (40)

Channel	Frequency (MHz)	Channel	Frequency (MHz)
03	2422	07	2442
04	2427	08	2447
05	2432	09	2452
06	2437	\	\

1.3 Test channel list

Channel List for 802.11b/g/n (20)

Channel	Channel	Frequency (MHz)
Low	01	2412
Middle	06	2437
High	11	2462

Channel List for 802.11n (40)

Channel	Channel	Frequency (MHz)
Low	03	2422
Middle	06	2437
High	09	2452

1.4 Ancillary equipment list

Equipment	Model	S/N	Manufacturer	Certificate type
Light bulb	/	/	/	/

This test report is valid for the tested samples only. It cannot be reproduced except in full without prior written consent of Shenzhen Microtest Co., Ltd.

1.5 Description of Support Units

The EUT has been tested as an independent unit together with other necessary accessories or support units. The following support units or accessories were used to form a representative test configuration during the tests.

Item	Equipment	Brand	Model/Type No.	Series No.	Note
/	/	/	/	/	/
/	/	/	/	/	/

Note:

- (1) The support equipment was authorized by Declaration of Confirmation.
- (2) For detachable type I/O cable should be specified the length in cm in 『Length』 column.

2 Summary of Test Results

Test procedures according to the technical standards:

No.	Standard Section	Test Item	Result	Remark
1	15.203	Antenna Requirement	Pass	
2	15.247 (b)	Peak Output Power	Pass	
3	15.247 (e)	Power Spectral Density	Pass	
4	15.207	Conducted Emission	Pass	
5	15.247 (d) & 15.209	Radiated Spurious Emission	Pass	
6	15.205	Band Edge Emission	Pass	
7	15.247 (a)(2)	6dB Bandwidth	Pass	
8	558074 D01 15.247 Meas Guidance v05r02 Chapter 6	Duty Cycle	Pass	
9	15.247(d)	Spurious RF Conducted Emissions	Pass	

3 Test Facilities and Accreditations

3.1 Test laboratory

Test Laboratory	Shenzhen Microtest Co., Ltd
Location	101, No. 7, Zone 2, Xinxing Industrial Park, Fuhai Avenue, Xinhe Community, Fuhai Street, Bao' an District, Shenzhen, Guangdong, China.
FCC Registration No.:	448573

3.2 Environmental conditions

Temperature:	15°C~35°C
Humidity	20%~75%
Atmospheric pressure	98kPa~101kPa

3.3 Measurement uncertainty

The reported uncertainty of measurement $y \pm U$ where expanded uncertainty U is based on a standard uncertainty multiplied by a coverage factor of $k=2$ providing a level of confidence of approximately 95 %

No.	Item	Uncertainty
1	Conducted Emission Test	$\pm 1.38\text{dB}$
2	RF power, conducted	$\pm 0.16\text{dB}$
3	Spurious emissions, conducted	$\pm 0.21\text{dB}$
4	All emissions, radiated(<1G)	$\pm 4.68\text{dB}$
5	All emissions, radiated(>1G)	$\pm 4.89\text{dB}$
6	Temperature	$\pm 0.5^\circ\text{C}$
7	Humidity	$\pm 2\%$

3.4 Test software

Software Name	Manufacturer	Model	Version
Bluetooth and WiFi Test System	Shenzhen JS tonskend co., ltd	JS1120-3	2.5.77.0418

4 Equipment list

Equipment No.	Equipment Name	Manufacturer	Model	Serial No.	Calibration date	Due date
MTI-E043	EMI Test Receiver	Rohde&schwarz	ESCI7	101166	2020/06/04	2021/06/03
MTI-E044	TRILOG Broadband Antenna	schwarzbeck	VULB 9163	9163-1338	2020/06/05	2021/06/04
MTI-E047	Amplifier	Hewlett-Packard	8447F	3113A06150	2020/06/04	2021/06/03
MTI-E089	ESG Vector Signal Generator	Agilent	N5182A	MY49060455	2020/06/03	2021/06/02
MTI-E058	ESG Series Analog Ssignal Generator	Agilent	E4421B	GB40051240	2020/07/03	2021/07/04
MTI-E062	PXA Signal Analyzer	Agilent	N9030A	MY51350296	2020/06/04	2021/06/03
MTI-E066	MXA Signal Analyzer	Agilent	N9020A	MY50143483	2020/06/04	2021/06/03
MTI-E078	Synthesized Sweeper	Agilent	83752A	3610A01957	2020/06/04	2021/06/03
MTI-E079	DC Power Supply	Agilent	E3632A	MY40027695	2020/06/04	2021/06/03
MTI-E045	Double Ridged Broadband Horn Antenna	schwarzbeck	BBHA 9120D	9120D-2278	2020/06/05	2021/06/04
MTI-E021	EMI Test Receiver	Rohde&schwarz	ESCS30	100210	2020/06/04	2021/06/03
MTI-E022	Pulse Limiter	Schwarzbeck	VSTD 9561-F	00679	2020/06/03	2021/06/02
MTI-E023	Artificial mains network	Schwarzbeck	NSLK 8127	NSLK 8127 #841	2020/06/04	2021/06/03
MTI-E046	Active Loop Antenna	Schwarzbeck	FMZB 1519B	00044	2020/06/05	2021/06/04
MTI-E048	Amplifier	Agilent	8449B	3008A02400	2020/07/03	2021/07/04
MTI-E072	Thermometer Clock Humidity Monitor	-	HTC-1	/	2020/06/07	2021/06/06

Note: the calibration interval of the above test instruments is 12 months and the calibrations are traceable to international system unit (SI).

5 Test Result

5.1 Antenna requirement

5.1.1 Standard requirement

15.203 requirement: For intentional device, according to 15.203: an intentional radiator shall be designed to ensure that no antenna other than that furnished by the responsible party shall be used with the device

5.1.2 EUT antenna

The EUT antenna is PCB antenna (0dBi). It comply with the standard requirement. In case of replacement of broken antenna the same antenna type must be used.

5.2 Peak output power

5.2.1 Limit

Section	Test Item	Limit	Frequency Range (MHz)
15.247(b)(3)	Peak output power	1 watt or 30dBm	2400-2483.5

5.2.2 Test setup

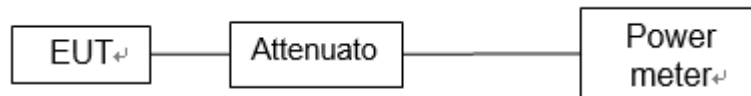

5.2.3 Test procedure

The EUT was directly connected to the Power meter.

5.2.4 Test results
802.11b

Test Channel	Frequency (MHz)	Maximum Peak Conducted Output Power(dBm)	Limit (dBm)
CH01	2412	16.39	30
CH06	2437	15.58	30
CH11	2462	15.67	30

802.11g

Test Channel	Frequency (MHz)	Maximum Peak Conducted Output Power(dBm)	Limit (dBm)
CH01	2412	14.90	30
CH06	2437	14.93	30
CH11	2462	14.75	30

802.11n20

Test Channel	Frequency (MHz)	Maximum Peak Conducted Output Power(dBm)	Limit (dBm)
CH01	2412	15.04	30
CH06	2437	14.95	30
CH11	2462	14.77	30

802.11n40

Test Channel	Frequency (MHz)	Maximum Peak Conducted Output Power(dBm)	Limit (dBm)
CH03	2422	15.15	30
CH06	2437	15.03	30
CH09	2452	15.07	30

5.3 Power spectral density

5.3.1 Limit

Section	Test Item	Limit	Frequency Range (MHz)
15.247(e)	Power Spectral Density	8 dBm (in any 3kHz)	2400-2483.5

5.3.2 Test setup



5.3.3 Test procedure

- a. The EUT tested system was configured as the statements of 2.1 unless otherwise a special operating condition is specified in the follows during the testing.
- b. Set analyzer center frequency to DTS channel center frequency.
- c. Set the span to 1.5 times the DTS channel bandwidth.
- d. Set the RBW ≥ 3 kHz.
- e. Set the VBW $\geq 3 \times$ RBW.
- f. Detector = peak.
- g. Sweep time = auto couple.
- h. Trace mode = max hold.
- i. Allow trace to fully stabilize.
- j. Use the peak marker function to determine the maximum amplitude level.
- k. If measured value exceeds limit, reduce RBW (no less than 3 kHz) and repeat.

5.3.4 Test results

802.11b			
Frequency	Power Density (dBm/3kHz)	Limit (dBm/3kHz)	Result
2412 MHz	-10.598	8	Pass
2437 MHz	-10.174	8	Pass
2462 MHz	-10.267	8	Pass

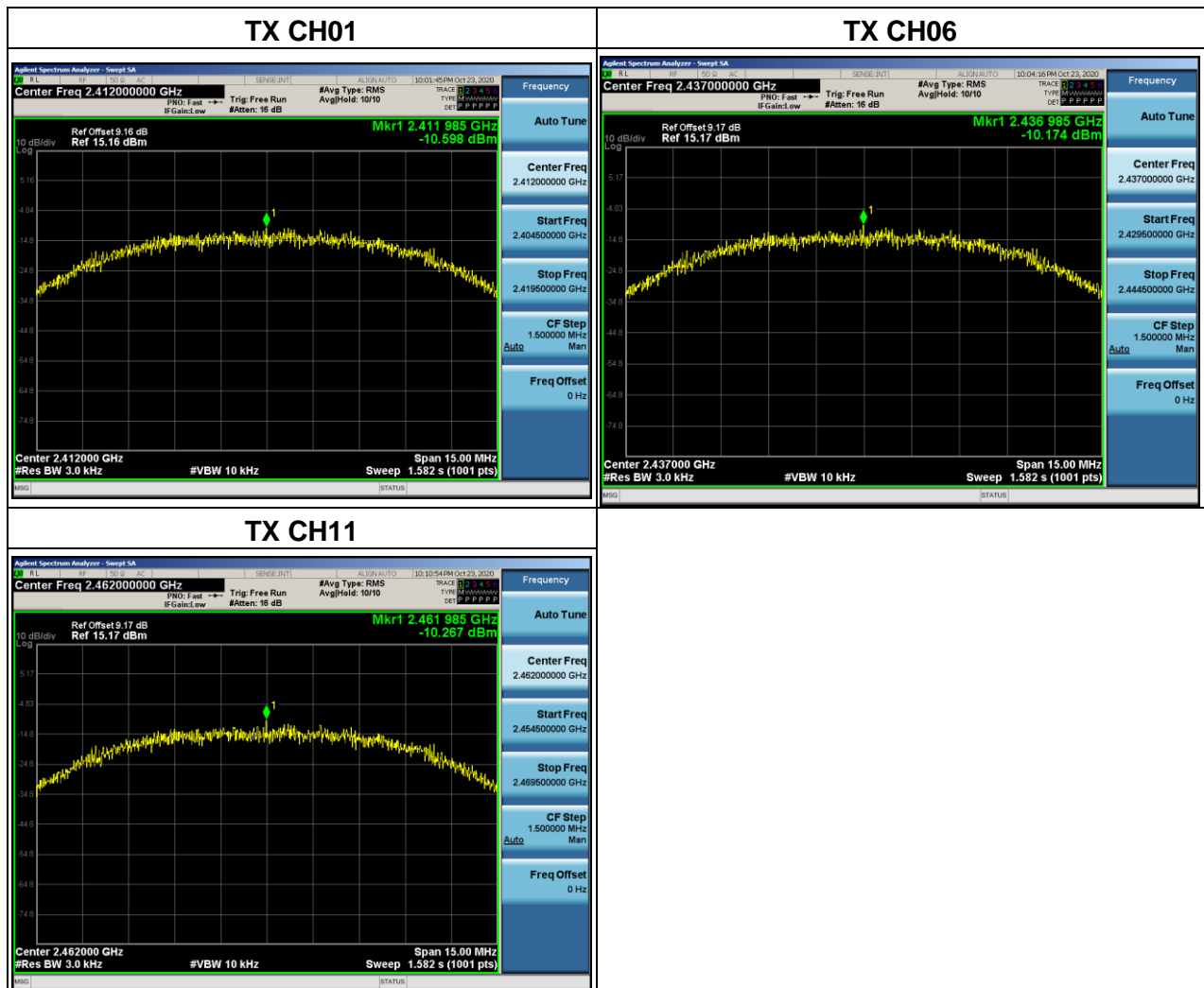

802.11g			
Frequency	Power Density (dBm/3kHz)	Limit (dBm/3kHz)	Result
2412 MHz	-15.587	8	Pass
2437 MHz	-14.864	8	Pass
2462 MHz	-14.883	8	Pass

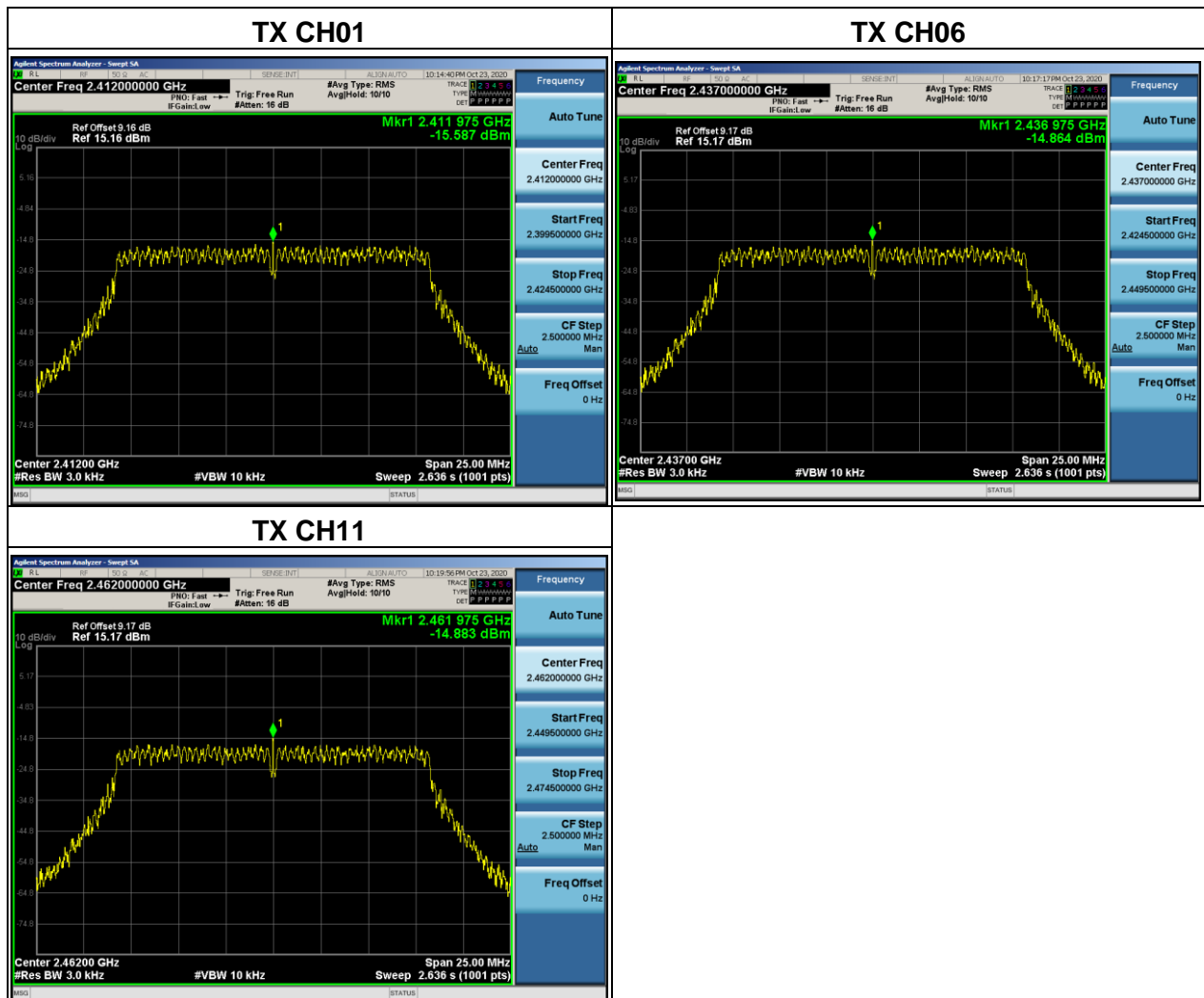

802.11n20			
Frequency	Power Density (dBm/3kHz)	Limit (dBm/3kHz)	Result
2412 MHz	-15.350	8	Pass
2437 MHz	-14.785	8	Pass
2462 MHz	-14.903	8	Pass

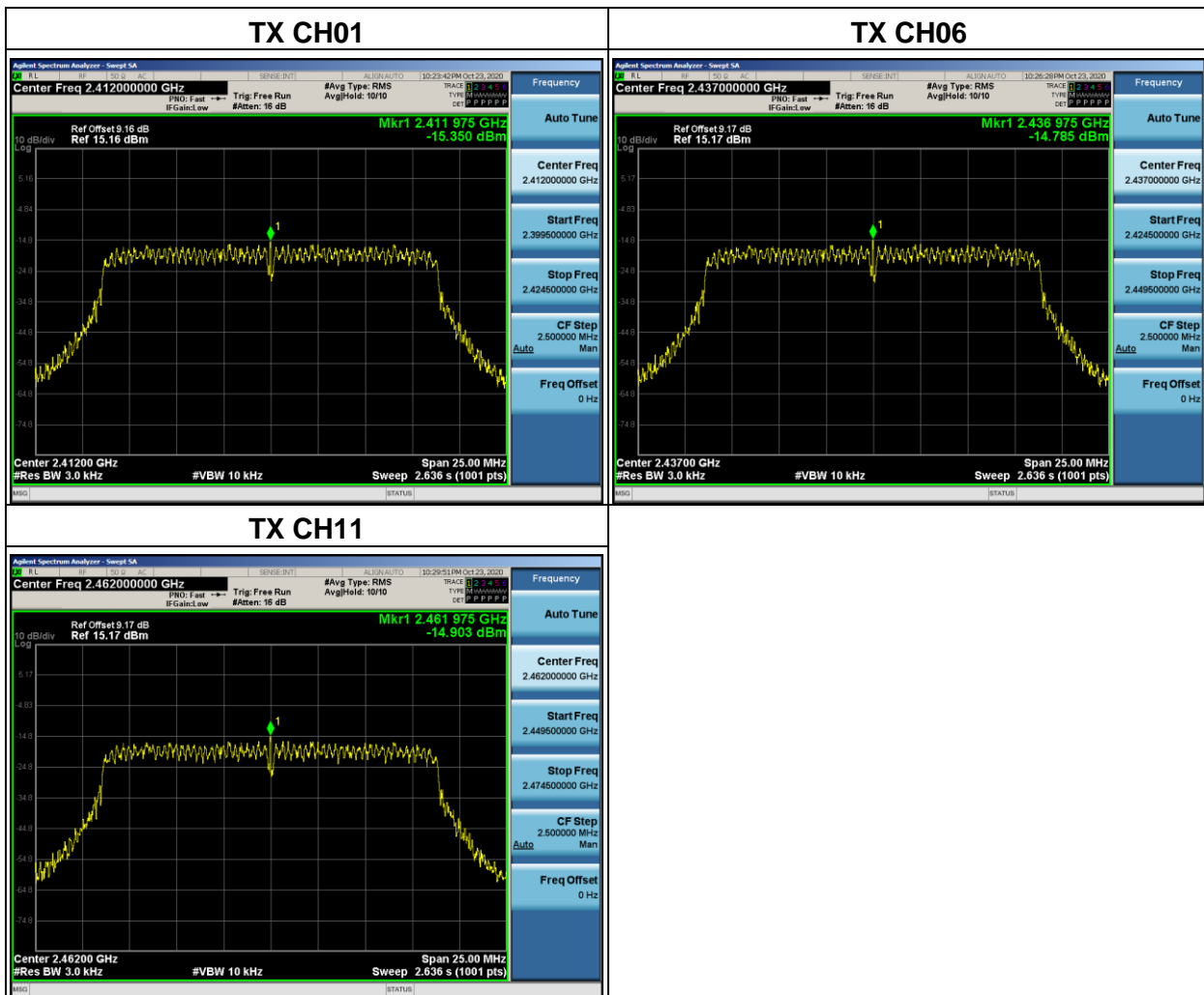

802.11n40			
Frequency	Power Density (dBm/3kHz)	Limit (dBm/3kHz)	Result
2422 MHz	-16.101	8	Pass
2437 MHz	-15.697	8	Pass
2452 MHz	-15.748	8	Pass

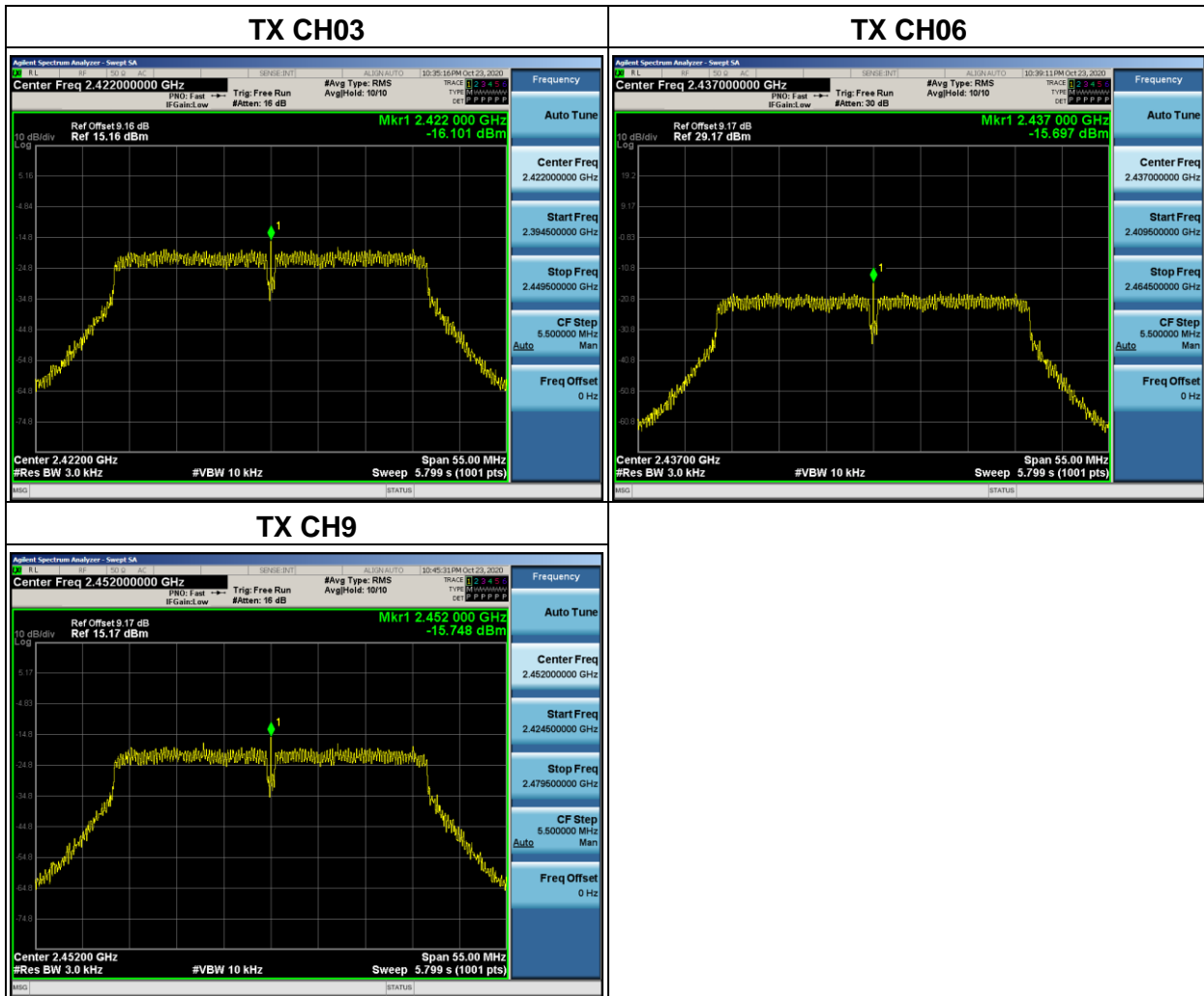

5.4 Conducted emission

5.4.1 Limits

According to FCC Part 15.207(a) and KDB 174176 D01 Line Conducted FAQ v01r01.

FREQUENCY (MHz)	Class B (dBuV)	
	Quasi-peak	Average
0.15 -0.5	66 - 56 *	56 - 46 *
0.50 -5.0	56.00	46.00
5.0 -30.0	60.00	50.00

Note: *Decreases with the logarithm of the frequency..

5.4.2 Test setup

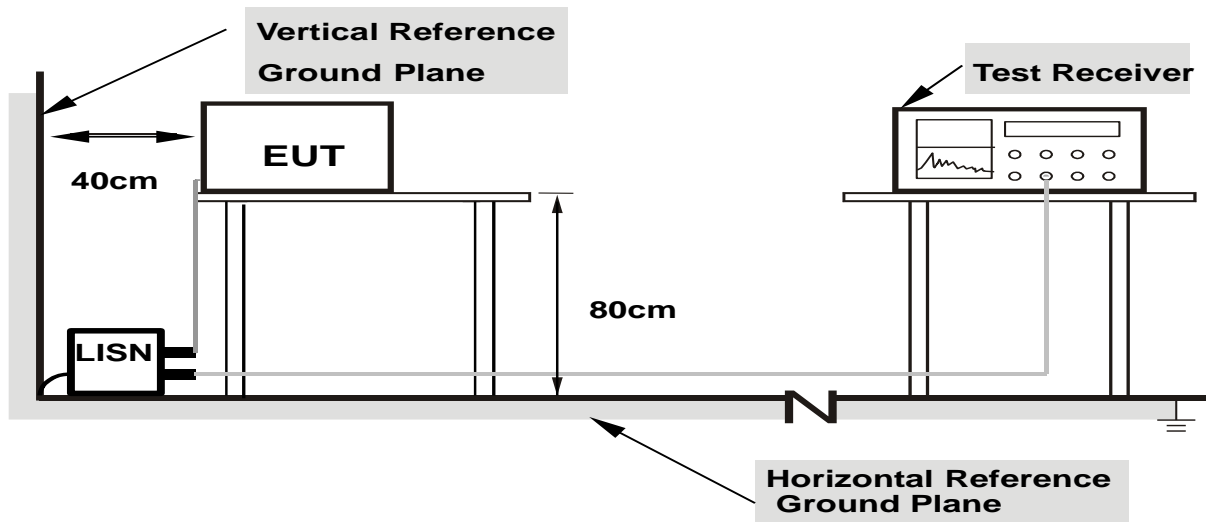

Note: 1.Support units were connected to second LISN.

2.Both of LISNs (AMN) are 80 cm from EUT and at least 80 from other units and other metal planes

5.4.3 Test procedure

a. EUT Operating Conditions

The EUT was configured for testing in a typical fashion (as a customer would normally use it). The EUT has been programmed to continuously transmit during test. This operating condition was tested and used to collect the included data.

b. The following table is the setting of the receiver

Receiver Parameters	Setting
Attenuation	10 dB
Start Frequency	0.15 MHz
Stop Frequency	30 MHz
IF Bandwidth	9 kHz

- c. The EUT was placed 0.8 meters from the horizontal ground plane with EUT being connected to the power mains through a line impedance stabilization network (LISN). All other support equipments powered from additional LISN(s). The LISN provide 50 Ohm/ 50uH of coupling impedance for the measuring instrument.
- d. Interconnecting cables that hang closer than 40 cm to the ground plane shall be folded back and forth in the center forming a bundle 30 to 40 cm long.
- e. I/O cables that are not connected to a peripheral shall be bundled in the center. The end of the cable may be terminated, if required, using the correct terminating impedance. The overall length shall not exceed 1 m.
- f. LISN at least 80 cm from nearest part of EUT chassis.

For the actual test configuration, please refer to the related Item –EUT Test Photos.

5.4.4 Test results

Note:

1: All the modulation modes have been tested, the report only shows the worst mode. The worst mode is 802.11b CH01.

2: Emission Level = Reading Level + Factor, Margin = Emission Level - Limit, Factor = LISN modulus + Cable Loss

3: This product does not support 240V voltage.

Test data

EUT:	SMART MINI CORD	Model Name:	HKWL-SW02WU
Pressure:	1010hPa	Phase::	L
Test Voltage:	AC 120V/60Hz	Test Mode:	TX

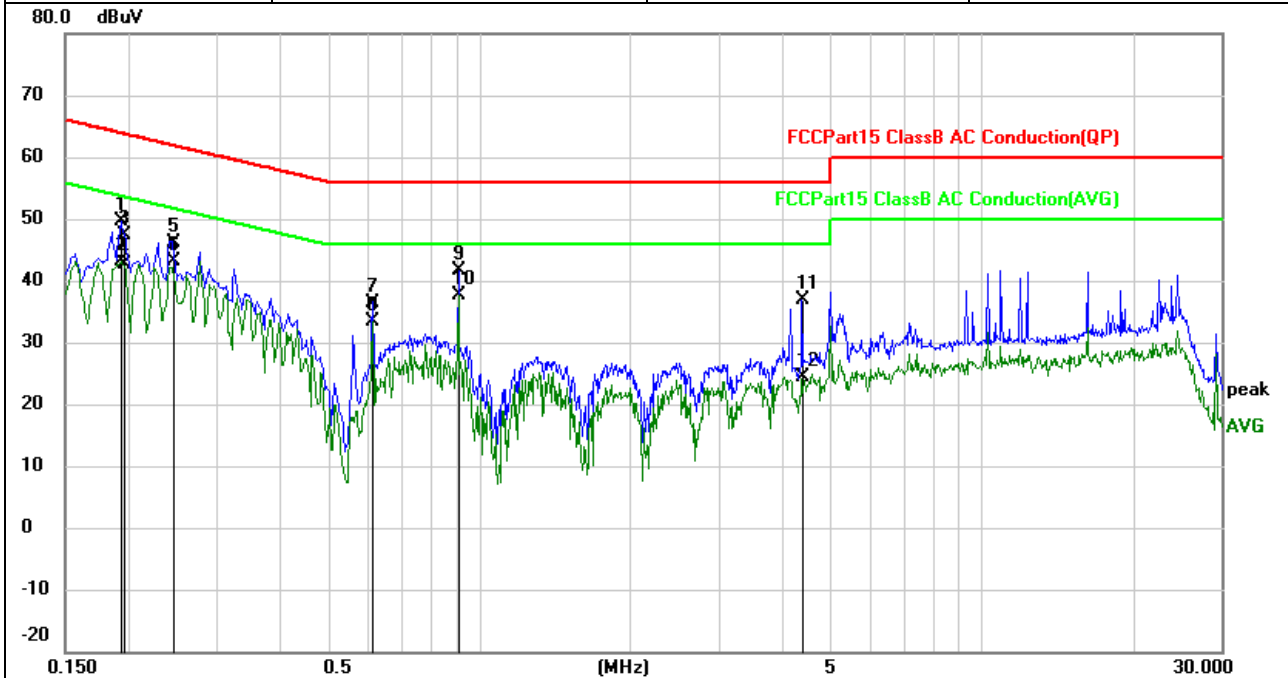

No.	Mk.	Freq. MHz	Reading Level dBuV	Correct Factor dB	Measure- ment dBuV	Limit dBuV	Over dB	Detector
1	*	0.1539	41.70	9.73	51.43	65.79	-14.36	QP
2		0.1539	7.83	9.73	17.56	55.79	-38.23	AVG
3		0.5299	27.55	9.92	37.47	56.00	-18.53	QP
4		0.5299	3.61	9.92	13.53	46.00	-32.47	AVG
5		1.0339	22.95	9.98	32.93	56.00	-23.07	QP
6		1.0339	8.29	9.98	18.27	46.00	-27.73	AVG
7		3.0980	21.76	10.03	31.79	56.00	-24.21	QP
8		3.0980	7.15	10.03	17.18	46.00	-28.82	AVG
9		9.8060	26.19	10.32	36.51	60.00	-23.49	QP
10		9.8060	14.57	10.32	24.89	50.00	-25.11	AVG
11		14.5100	26.63	10.28	36.91	60.00	-23.09	QP
12		14.5100	13.68	10.28	23.96	50.00	-26.04	AVG

EUT:	SMART MINI CORD	Model Name:	HKWL-SW02WU
Pressure:	1010hPa	Phase::	N
Test Voltage:	AC 120V/60Hz	Test Mode:	TX

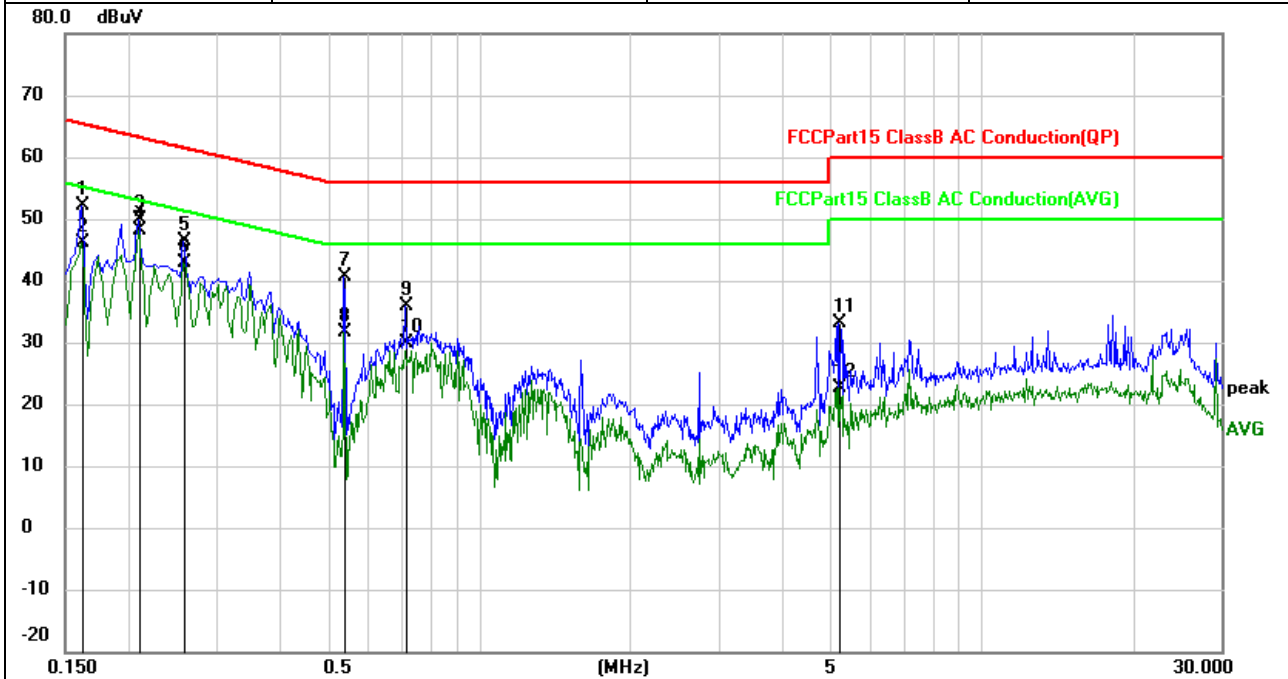

No.	Mk.	Freq.	Reading Level	Correct Factor	Measurement	Limit	Over	Detector
		MHz	dBuV	dB	dBuV	dBuV	dB	
1		0.1620	42.46	9.74	52.20	65.36	-13.16	QP
2		0.1620	36.49	9.74	46.23	55.36	-9.13	AVG
3		0.2100	40.06	9.74	49.80	63.21	-13.41	QP
4	*	0.2100	38.27	9.74	48.01	53.21	-5.20	AVG
5		0.2580	36.58	9.75	46.33	61.50	-15.17	QP
6		0.2580	33.18	9.75	42.93	51.50	-8.57	AVG
7		0.5380	30.66	9.93	40.59	56.00	-15.41	QP
8		0.5380	21.68	9.93	31.61	46.00	-14.39	AVG
9		0.7140	25.85	9.96	35.81	56.00	-20.19	QP
10		0.7140	19.81	9.96	29.77	46.00	-16.23	AVG
11		5.2060	22.97	10.19	33.16	60.00	-26.84	QP
12		5.2060	12.38	10.19	22.57	50.00	-27.43	AVG

5.5 Radiated spurious

5.5.1 Limits

20dBc in any 100 kHz bandwidth outside the operating frequency band. In case the emission fall within the restricted band specified on 15.205(a), then the 15.209(a) limit in the table below has to be followed.

Frequency (MHz)	Field Strength (micovolts/meter)	Measurement Distance (meters)
0.009~0.490	2400/F(kHz)	300
0.490~1.705	24000/F(kHz)	30
1.705~30.0	30	30
30~88	100	3
88~216	150	3
216~960	200	3
Above 960	500	3

Spectrum Parameter	Setting
Attenuation	Auto
Start Frequency	1000 MHz
Stop Frequency	10th carrier harmonic
RB / VB (emission in restricted band)	1 MHz / 1 MHz for Peak, 1 MHz / 10Hz for Average

Receiver Parameter	Setting
Attenuation	Auto
Start ~ Stop Frequency	9kHz~150kHz / RB 200Hz for QP
Start ~ Stop Frequency	150kHz~30MHz / RB 9kHz for QP
Start ~ Stop Frequency	30MHz~1000MHz / RB 120kHz for QP

5.5.2 Test setup

Radiated emission test-up frequency below 30MHz

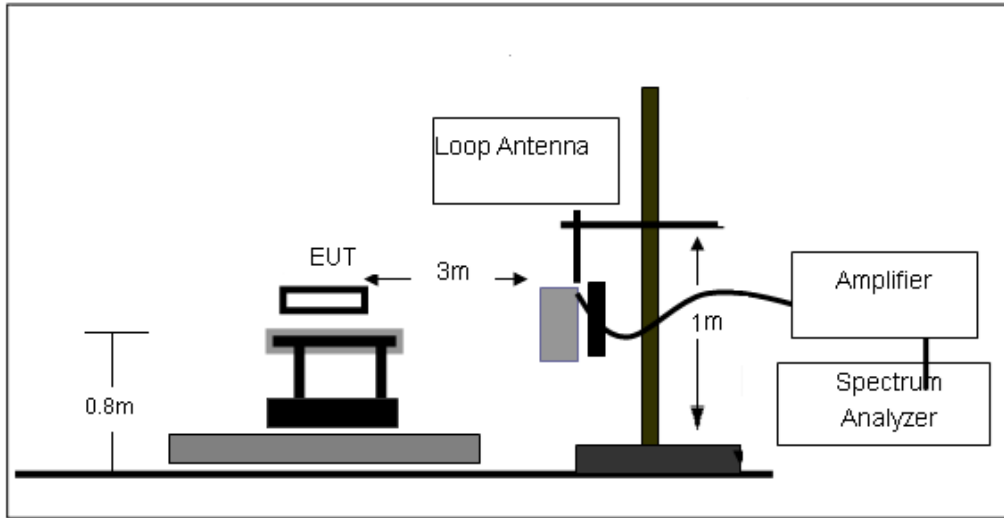

Radiated emission test-up frequency 30MHz~1GHz

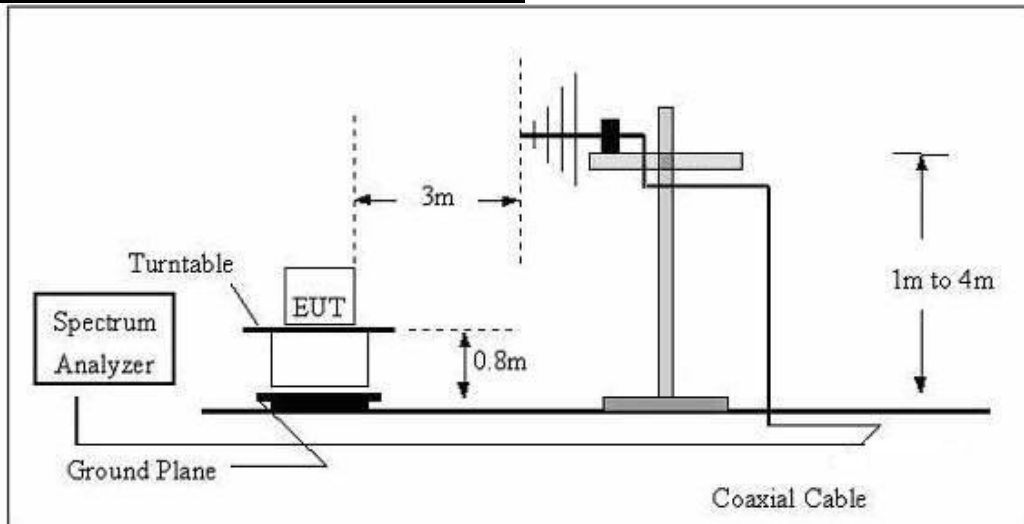

Radiated emission test-up frequency above 1GHz

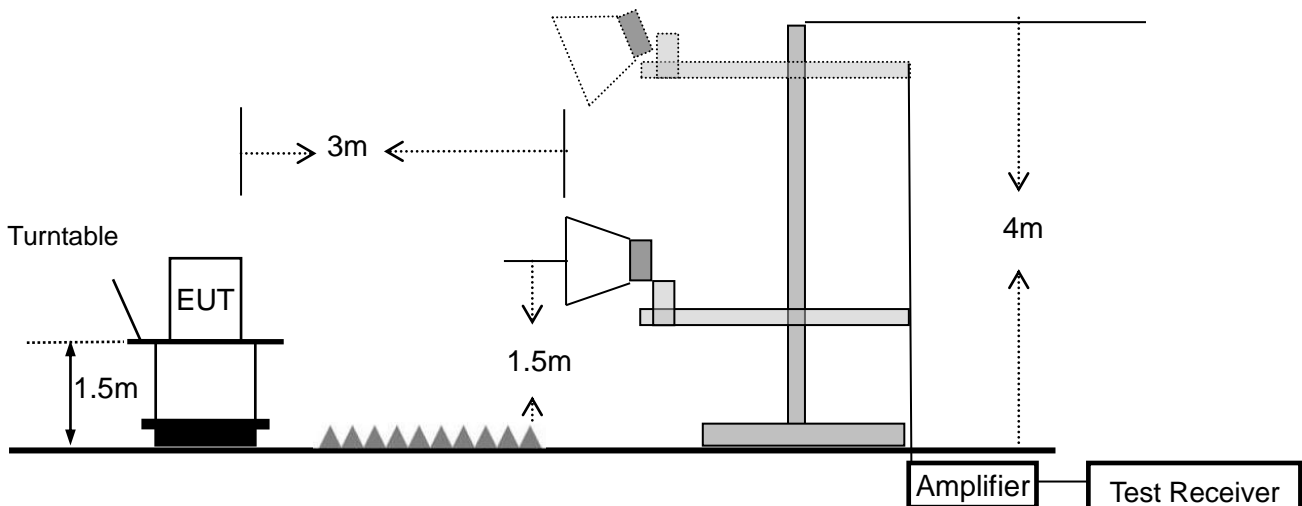

5.5.3 Test procedure

- a. EUT operating conditions. The EUT tested system was configured as the statements of 2.4 unless otherwise a special operating condition is specified in the follows during the testing.
- b. The measuring distance of at 3 m shall be used for measurements at frequency up to 1GHz. For frequencies above 1GHz, any suitable measuring distance may be used.
- c. The EUT was placed on the top of a rotating table 0.8 meters above the ground at a 3 meter open area test site. The table was rotated 360 degrees to determine the position of the highest radiation.
- d. The height of the equipment or of the substitution antenna shall be 0.8 m; the height of the test antenna shall vary between 1 m to 4 m. Both horizontal and vertical polarizations of the antenna are set to make the measurement.
- e. For emission measurements above 1 GHz, the EUT shall be placed at a height of 1.5 m above the floor on a support that is RF transparent for the frequencies of interest. Final measurements for the EUT require a measurement antenna height scan of 1 m to 4 m.
- f. The initial step in collecting conducted emission data is a spectrum analyzer peak detector mode pre-scanning the measurement frequency range. Significant peaks are then marked and then Quasi Peak detector mode re-measured.
- g. If the Peak Mode measured value compliance with and lower than Quasi Peak Mode Limit, the EUT shall be deemed to meet QP Limits and then no additional QP Mode measurement performed.
- h. For the actual test configuration, please refer to the related Item –EUT Test photos.

Note: Both horizontal and vertical antenna polarities were tested and performed pretest to three orthogonal axis. The worst case emissions were reported

5.5.4 Test results

5.5.4.1 Radiation emission

Below 30MHz

EUT:	SMART MINI CORD	Model Name:	HKWL-SW02WU
Pressure:	1010 hPa	Phase:	H
Test Mode:	TX	Test Voltage:	AC 120V/60Hz

Freq.	Reading	Limit	Margin	State
(MHz)	(dBuV/m)	(dBuV/m)	(dB)	P/F
--	--	--	--	Pass
--	--	--	--	Pass

Note:

For 9k-30MHz, the amplitude of spurious emissions which are attenuated by more than 20dB below the permissible value has no need to be reported.

Distance extrapolation factor = $40 \log(\text{specific distance}/\text{test distance})$ (dB);

Limit line = specific limits (dBuV) + distance extrapolation factor.

Between 30MHz – 1GHz

Note1: Emission Level = Meter Reading + Factor, Margin= Emission Level- Limit, Factor = Antenna Factor + Cable Loss – Pre-amplifier.

Note2: The three modulated high, medium and low channels have been tested. The report only shows the worst mode. The worst mode is 802.11b CH01.

EUT:	SMART MINI CORD	Model Name:	HKWL-SW02WU
Pressure:	1010 hPa	Phase:	H
Test Mode:	TX	Test Voltage:	AC 120V/60Hz

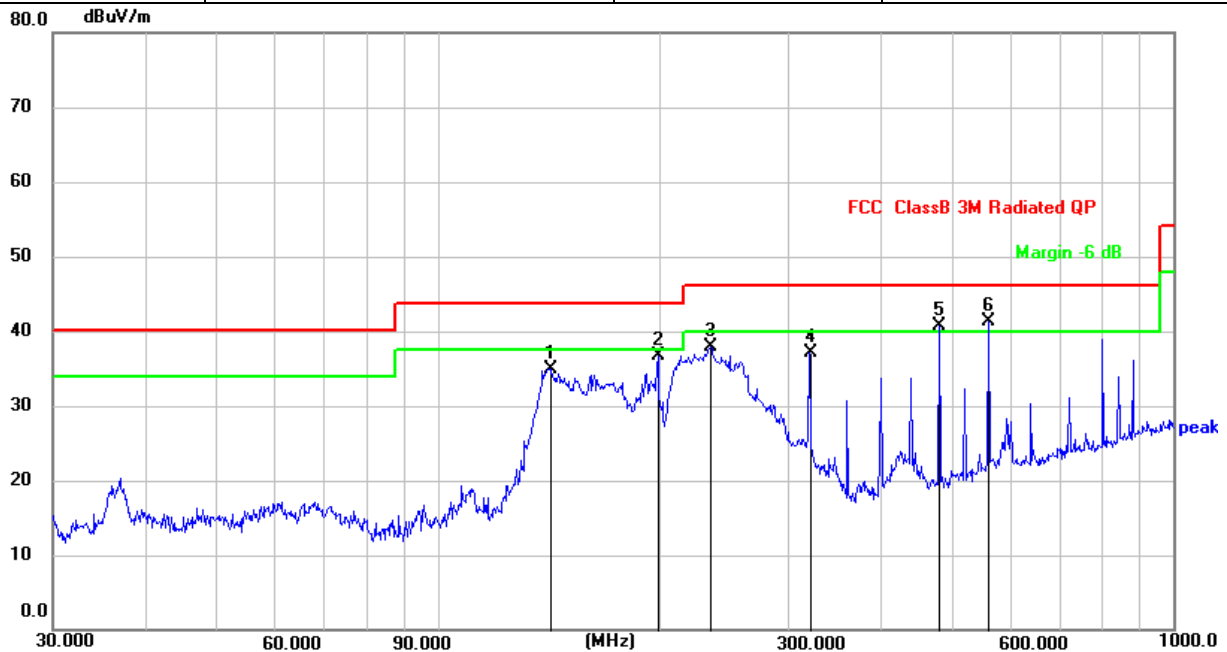

No.	Frequency (MHz)	Reading (dBuV)	Factor (dB/m)	Level (dBuV/m)	Limit (dBuV/m)	Margin (dB)	Detector
1	142.3243	52.42	-17.43	34.99	43.50	-8.51	QP
2	199.2855	50.53	-13.81	36.72	43.50	-6.78	QP
3	234.9909	50.44	-12.59	37.85	46.00	-8.15	QP
4	319.9370	47.31	-10.15	37.16	46.00	-8.84	QP
5 !	480.5276	48.03	-7.36	40.67	46.00	-5.33	QP
6 *	560.6928	47.06	-5.73	41.33	46.00	-4.67	QP

EUT:	SMART MINI CORD	Model Name:	HKWL-SW02WU
Pressure:	1010 hPa	Phase:	V
Test Mode:	TX	Test Voltage:	AC 120V/60Hz

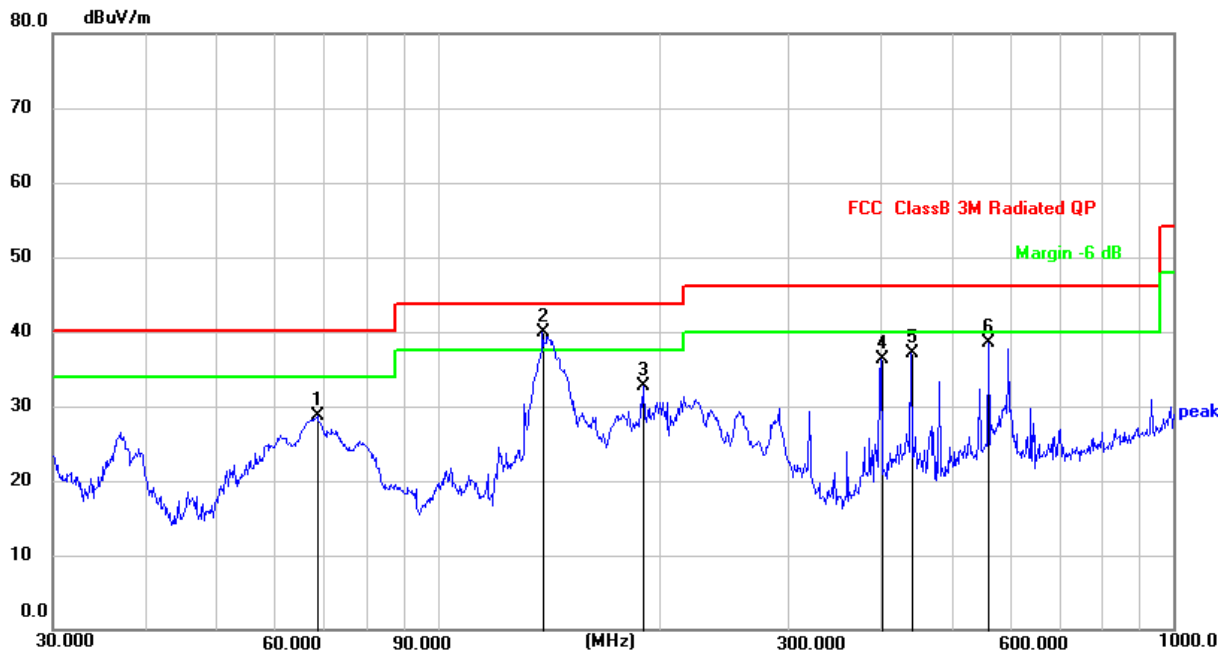

No.	Frequency (MHz)	Reading (dBuV)	Factor (dB/m)	Level (dBuV/m)	Limit (dBuV/m)	Margin (dB)	Detector
1	68.6310	46.05	-17.26	28.79	40.00	-11.21	QP
2 *	138.8735	57.27	-17.36	39.91	43.50	-3.59	QP
3	190.4050	47.04	-14.35	32.69	43.50	-10.81	QP
4	400.4319	45.40	-9.00	36.40	46.00	-9.60	QP
5	440.1963	45.24	-8.20	37.04	46.00	-8.96	QP
6	560.6928	44.20	-5.73	38.47	46.00	-7.53	QP

1-25GHz

Note:

- (1) Emission Level= Antenna Factor + Cable Loss + Read Level - Preamp Factor
- (2) All other emissions more than 20dB below the limit.
- (3) The three modulated high, medium and low channels have been tested. The report only shows the worst mode. The worst mode is 802.11b.

All the modulation modes have been tested, and the worst result was report as below:

Frequency (MHz)	Read Level (dBμV)	Cable loss (dB)	Antenna Factor dB/m	Preamp Factor (dB)	Emission Level (dBμV/m)	Limits (dBμV/m)	Margin (dB)	Remark	Comment
Low Channel (2412 MHz)(802.11b)--Above 1G									
4824.161	63.23	4.36	32.92	45.53	54.98	74.00	-19.02	Pk	Vertical
4824.161	43.52	4.36	32.92	45.53	35.27	54.00	-18.73	AV	Vertical
7236.396	59.89	5.02	37.63	45.56	56.98	74.00	-17.02	Pk	Vertical
7236.396	41.21	5.02	37.63	45.56	38.30	54.00	-15.70	AV	Vertical
4824.154	62.69	4.36	32.92	45.53	54.44	74.00	-19.56	Pk	Horizontal
4824.154	43.17	4.36	32.92	45.53	34.92	54.00	-19.08	AV	Horizontal
7236.168	64.29	5.02	37.63	45.56	61.38	74.00	-12.62	Pk	Horizontal
7236.168	43.12	5.02	37.63	45.56	40.21	54.00	-13.79	AV	Horizontal
Middle Channel (2437 MHz)(802.11b)--Above 1G									
4874.112	62.96	4.41	33.01	45.76	54.62	74.00	-19.38	Pk	Vertical
4874.112	43.65	4.41	33.01	45.76	35.31	54.00	-18.69	AV	Vertical
7311.247	60.10	5.02	37.68	45.59	57.21	74.00	-16.79	Pk	Vertical
7311.247	41.49	5.02	37.68	45.59	38.60	54.00	-15.40	AV	Vertical
4874.132	62.40	4.41	33.01	45.76	54.06	74.00	-19.94	Pk	Horizontal
4874.132	44.67	4.41	33.01	45.76	36.33	54.00	-17.67	AV	Horizontal
7311.085	61.98	5.02	37.68	45.59	59.09	74.00	-14.91	Pk	Horizontal
7311.085	43.18	5.02	37.68	45.59	40.29	54.00	-13.71	AV	Horizontal
High Channel (2462 MHz)(802.11b)--Above 1G									
4924.169	64.22	4.50	33.26	46.07	55.91	74.00	-18.09	Pk	Vertical
4924.169	43.62	4.50	33.26	46.07	35.31	54.00	-18.69	AV	Vertical
7386.215	61.30	5.02	37.78	45.77	58.33	74.00	-15.67	Pk	Vertical
7386.215	40.80	5.02	37.78	45.77	37.83	54.00	-16.17	AV	Vertical
4924.045	63.34	4.50	33.26	46.07	55.03	74.00	-18.97	Pk	Horizontal
4924.045	45.39	4.50	33.26	46.07	37.08	54.00	-16.92	AV	Horizontal
7386.132	61.15	5.02	37.78	45.77	58.18	74.00	-15.82	Pk	Horizontal
7386.132	42.58	5.02	37.78	45.77	39.61	54.00	-14.39	AV	Horizontal

5.5.4.2 Band edge - radiated

- Note: (1) All Readings are Peak Value (VBW=3MHz) and AV Value (VBW=10Hz).
 (2) Emission Level= Antenna Factor + Cable Loss + Read Level - Preamp Factor
 (3) All other emissions more than 20dB below the limit.

All the modulation modes have been tested, and the worst result was report as below:

Frequency	Meter Reading	Cable Loss	Antenna Factor	Preamp Factor	Emission Level	Limits	Margin	Detector	Comment
(MHz)	(dB μ V)	(dB)	dB/m	(dB)	(dB μ V/m)	(dB μ V/m)	(dB)	Type	
802.11b									
2310.00	58.88	2.40	27.70	40.40	48.58	74	-25.42	Pk	Horizontal
2310.00	43.10	2.40	27.70	40.40	32.80	54	-21.20	AV	Horizontal
2310.00	59.14	2.40	27.70	40.40	48.84	74	-25.16	Pk	Vertical
2310.00	42.10	2.40	27.70	40.40	31.80	54	-22.20	AV	Vertical
2390.00	57.60	2.44	28.30	40.10	48.24	74	-25.76	Pk	Vertical
2390.00	42.21	2.44	28.30	40.10	32.85	54	-21.15	AV	Vertical
2390.00	56.77	2.44	28.30	40.10	47.41	74	-26.59	Pk	Horizontal
2390.00	41.37	2.44	28.30	40.10	32.01	54	-21.99	AV	Horizontal
2483.50	58.24	2.48	28.70	39.80	49.62	74	-24.38	Pk	Vertical
2483.50	43.45	2.48	28.70	39.80	34.83	54	-19.17	AV	Vertical
2483.50	58.53	2.48	28.70	39.80	49.91	74	-24.09	Pk	Horizontal
2483.50	41.91	2.48	28.70	39.80	33.29	54	-20.71	AV	Horizontal
802.11g									
2310.00	58.72	2.40	27.70	40.40	48.42	74	-25.58	Pk	Horizontal
2310.00	44.45	2.40	27.70	40.40	34.15	54	-19.85	AV	Horizontal
2310.00	57.16	2.40	27.70	40.40	46.86	74	-27.14	Pk	Vertical
2310.00	42.41	2.40	27.70	40.40	32.11	54	-21.89	AV	Vertical
2390.00	58.11	2.44	28.30	40.10	48.75	74	-25.25	Pk	Vertical
2390.00	41.79	2.44	28.30	40.10	32.43	54	-21.57	AV	Vertical
2390.00	58.46	2.44	28.30	40.10	49.10	74	-24.90	Pk	Horizontal
2390.00	44.17	2.44	28.30	40.10	34.81	54	-19.19	AV	Horizontal
2483.50	58.81	2.48	28.70	39.80	50.19	74	-23.81	Pk	Vertical
2483.50	43.92	2.48	28.70	39.80	35.30	54	-18.70	AV	Vertical
2483.50	58.67	2.48	28.70	39.80	50.05	74	-23.95	Pk	Horizontal
2483.50	41.91	2.48	28.70	39.80	33.29	54	-20.71	AV	Horizontal

802.11n20									
2310.00	58.12	2.40	27.70	40.40	47.82	74	-26.18	Pk	Horizontal
2310.00	44.27	2.40	27.70	40.40	33.97	54	-20.03	AV	Horizontal
2310.00	58.34	2.40	27.70	40.40	48.04	74	-25.96	Pk	Vertical
2310.00	42.42	2.40	27.70	40.40	32.12	54	-21.88	AV	Vertical
2390.00	57.35	2.44	28.30	40.10	47.99	74	-26.01	Pk	Vertical
2390.00	41.79	2.44	28.30	40.10	32.43	54	-21.57	AV	Vertical
2390.00	56.44	2.44	28.30	40.10	47.08	74	-26.92	Pk	Horizontal
2390.00	42.01	2.44	28.30	40.10	32.65	54	-21.35	AV	Horizontal
2483.50	57.70	2.48	28.70	39.80	49.08	74	-24.92	Pk	Vertical
2483.50	42.32	2.48	28.70	39.80	33.70	54	-20.30	AV	Vertical
2483.50	58.91	2.48	28.70	39.80	50.29	74	-23.71	Pk	Horizontal
2483.50	42.23	2.48	28.70	39.80	33.61	54	-20.39	AV	Horizontal
802.11n40									
2310.00	59.53	2.40	27.70	40.40	49.23	74	-24.77	Pk	Horizontal
2310.00	44.25	2.40	27.70	40.40	33.95	54	-20.05	AV	Horizontal
2310.00	56.60	2.40	27.70	40.40	46.30	74	-27.70	Pk	Vertical
2310.00	43.46	2.40	27.70	40.40	33.16	54	-20.84	AV	Vertical
2390.00	57.49	2.44	28.30	40.10	48.13	74	-25.87	Pk	Vertical
2390.00	42.16	2.44	28.30	40.10	32.80	54	-21.20	AV	Vertical
2390.00	58.62	2.44	28.30	40.10	49.26	74	-24.74	Pk	Horizontal
2390.00	43.81	2.44	28.30	40.10	34.45	54	-19.55	AV	Horizontal
2483.50	58.45	2.48	28.70	39.80	49.83	74	-24.17	Pk	Vertical
2483.50	44.07	2.48	28.70	39.80	35.45	54	-18.55	AV	Vertical
2483.50	58.90	2.48	28.70	39.80	50.28	74	-23.72	Pk	Horizontal
2483.50	42.22	2.48	28.70	39.80	33.60	54	-20.40	AV	Horizontal

5.5.5 Spurious Emission in Restricted Band 3260MHz-18000MHz

All the modulation modes have been tested, and the worst result was report as below:

Frequency	Reading Level	Cable Loss	Antenna Factor	Preamp Factor	Emission Level	Limits	Margin	Detector	Comment
(MHz)	(dB μ V)	(dB)	dB/m	(dB)	(dB μ V/m)	(dB μ V/m)	(dB)	Type	
3260	60.83	3.27	30.02	38.05	56.07	74	-17.93	Pk	Vertical
3260	39.26	3.27	30.02	38.05	34.50	54	-19.50	AV	Vertical
3260	60.07	3.27	30.02	38.05	55.31	74	-18.69	Pk	Horizontal
3260	36.65	3.27	30.02	38.05	31.89	54	-22.11	AV	Horizontal
3332	60.52	3.31	30.00	37.91	55.92	74	-18.08	Pk	Vertical
3332	38.65	3.31	30.00	37.91	34.05	54	-19.95	AV	Vertical
3332	60.43	3.31	30.00	37.91	55.83	74	-18.17	Pk	Horizontal
3332	35.95	3.31	30.00	37.91	31.35	54	-22.65	AV	Horizontal
17797	43.33	8.63	44.23	39.60	56.59	74	-17.41	Pk	Vertical
17797	29.00	8.63	44.23	39.60	42.26	54	-11.74	AV	Vertical
17788	42.87	8.63	44.23	39.60	56.13	74	-17.87	Pk	Horizontal
17788	27.57	8.63	44.23	39.60	40.83	54	-13.17	AV	Horizontal

5.6 Band edge - Conducted

5.6.1 Limits

In any 100 kHz bandwidth outside the frequency band in which the spread spectrum or digitally modulated intentional radiator is operating, the radio frequency power that is produced by the intentional radiator shall be at least 20 dB below that in the 100 kHz bandwidth within the band that contains the highest level of the desired power, based on either an RF conducted or a radiated measurement, provided the transmitter demonstrates compliance with the peak conducted power limits. If the transmitter complies with the conducted power limits based on the use of RMS averaging over a time interval, as permitted under paragraph (b)(3) of this section, the attenuation required under this paragraph shall be 30 dB instead of 20 dB. Attenuation below the general limits specified in §15.209(a) is not required. In addition, radiated emissions which fall in the restricted bands, as defined in §15.205(a), must also comply with the radiated emission limits specified in §15.209(a) (see §15.205(c)).

5.6.2 Test setup



5.6.3 Test procedure

- a) Check the calibration of the measuring instrument using either an internal calibrator or a known signal from an external generator.
- b) Position the EUT without connection to measurement instrument. Turn on the EUT and connect its antenna terminal to measurement instrument via a low loss cable. Then set it to any one measured frequency within its operating range, and make sure the instrument is operated in its linear range.
- c) Set RBW to 100 kHz and VBW of spectrum analyzer to 300 kHz with a convenient frequency span including 100 kHz bandwidth from band edge.
- d) Measure the highest amplitude appearing on spectral display and set it as a reference level. Plot the graph with marking the highest point and edge frequency.
- e) Repeat above procedures until all measured frequencies were complete.

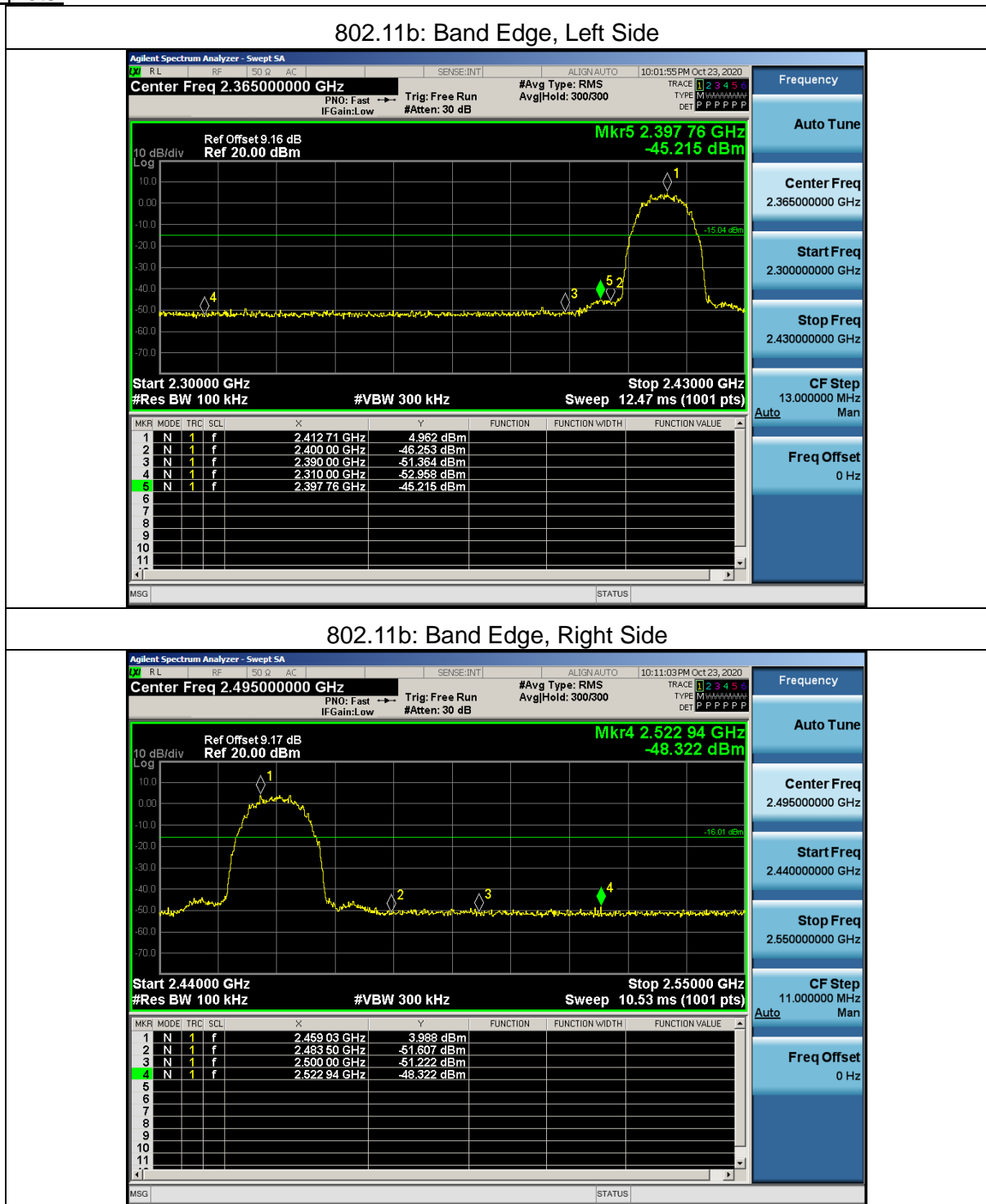
5.6.4 Test results
Test plots:



802.11g: Band Edge, Left Side

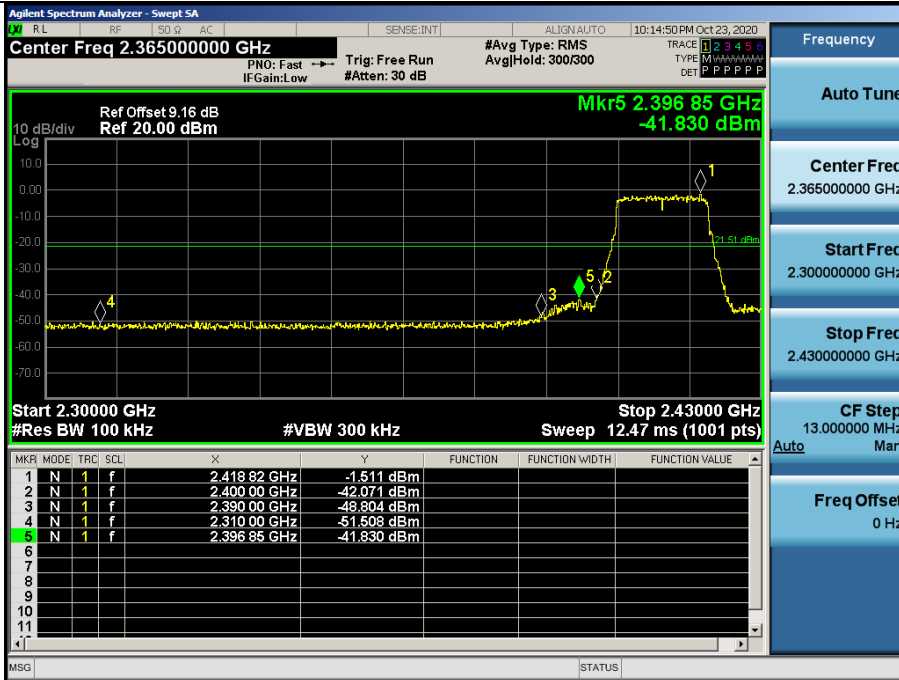

802.11g: Band Edge, Right Side

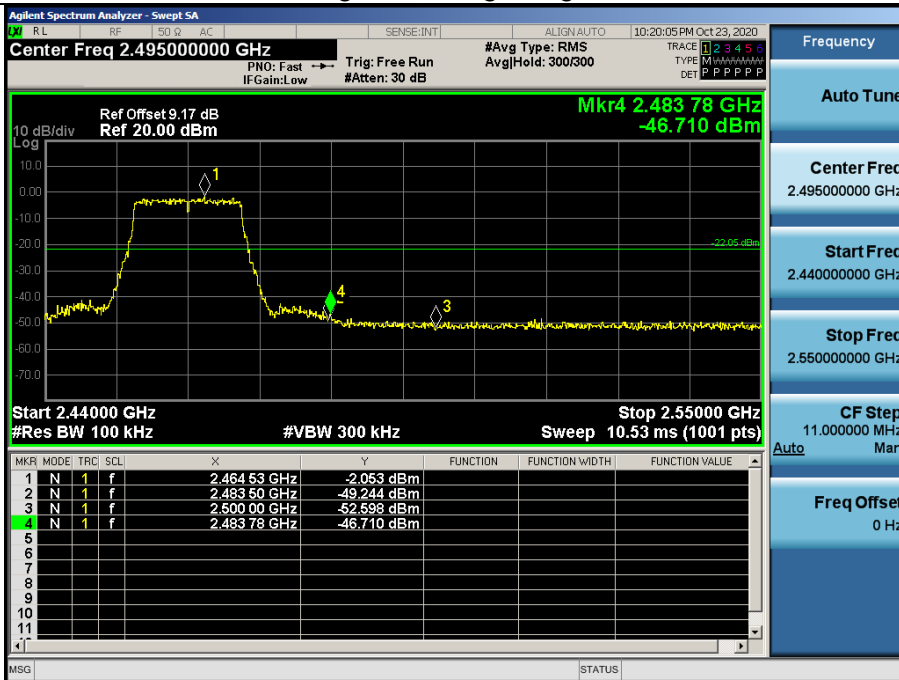



802.11n20: Band Edge, Left Side

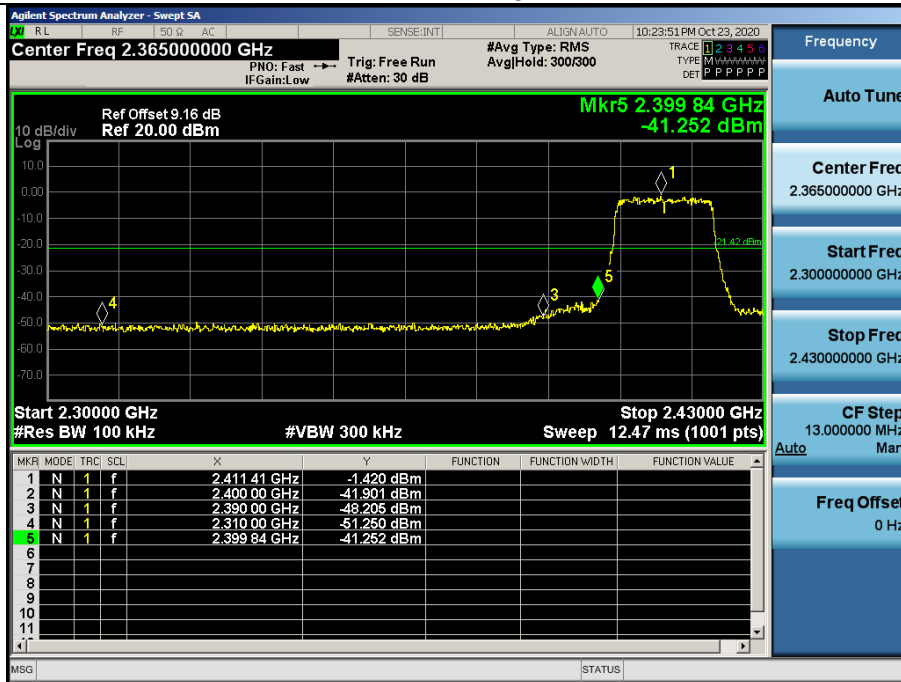

802.11n20: Band Edge, Right Side

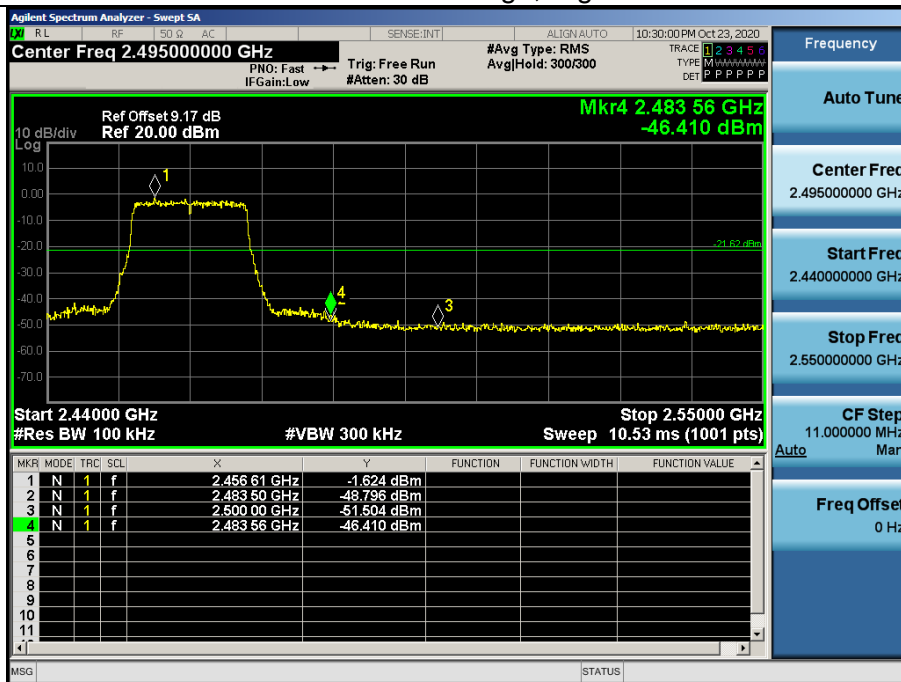



802.11n40: Band Edge, Left Side

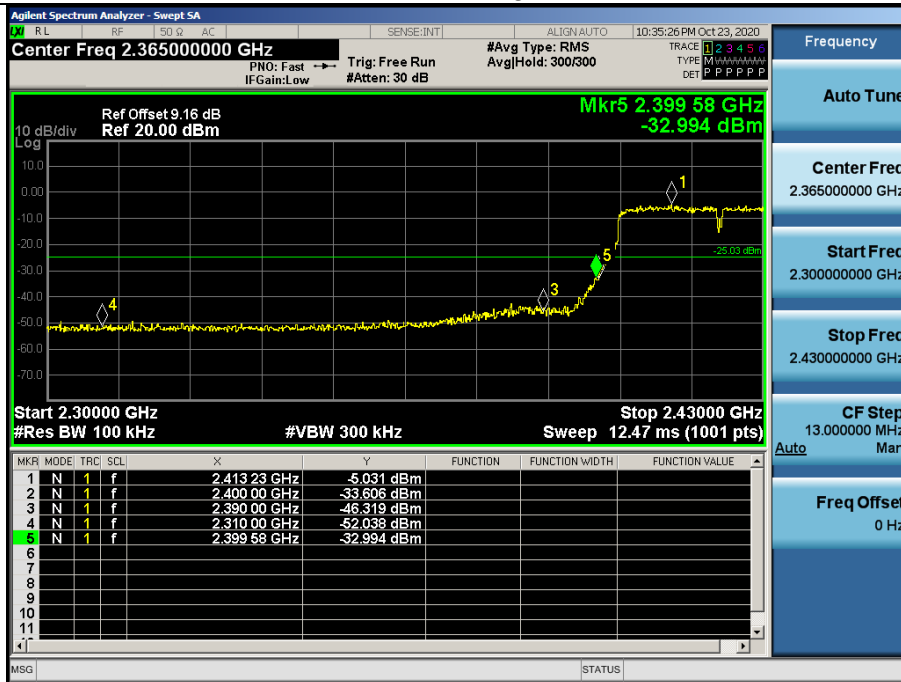

802.11n40: Band Edge, Right Side



5.7 6dB bandwidth

5.7.1 Limit

Section	Test Item	Limit	Frequency Range (MHz)
15.247(a)(2)	Bandwidth	$\geq 500\text{kHz}$ (6dB bandwidth)	2400-2483.5

5.7.2 Test setup



5.7.3 Test procedure

- Set RBW= 100 kHz.
- Set the video bandwidth (VBW) $\geq 3 \times$ RBW.
- Detector = Peak.
- Trace mode = max hold.
- Sweep = auto couple.
- Allow the trace to stabilize.
- Measure the maximum width of the emission that is constrained by the frequencies associated with the two outermost amplitude points (upper and lower) that are attenuated by 6 dB relative to the maximum level measured in the fundamental emission.

5.7.4 Test results

This test report is valid for the tested samples only. It cannot be reproduced except in full without prior written consent of Shenzhen Microtest Co., Ltd.

EUT:	SMART MINI CORD	Model Name:	HKWL-SW02WU
Pressure:	1012 hPa	Test Voltage:	AC 120V/60Hz
Test Mode:	TX b Mode /CH01, CH06, CH11		

Channel	Frequency (MHz)	6dB bandwidth (MHz)	Limit (kHz)	Result
Low	2412	10.09	500	Pass
Middle	2437	9.557	500	Pass
High	2462	9.623	500	Pass

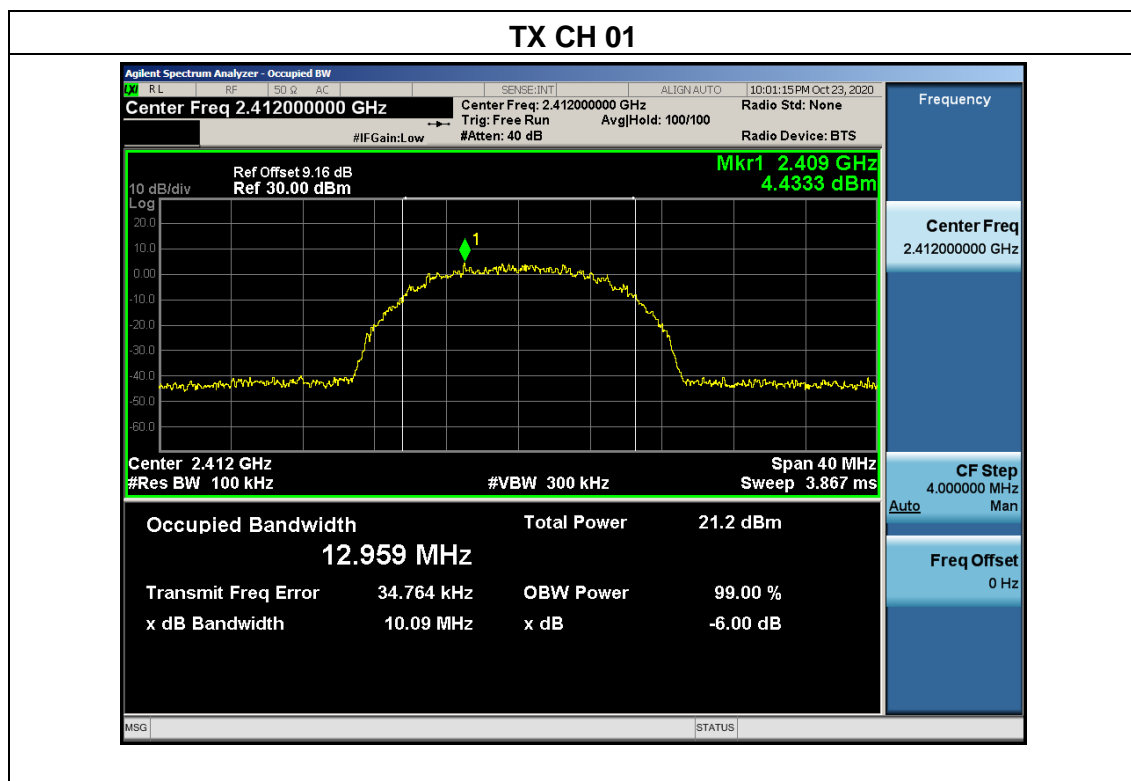

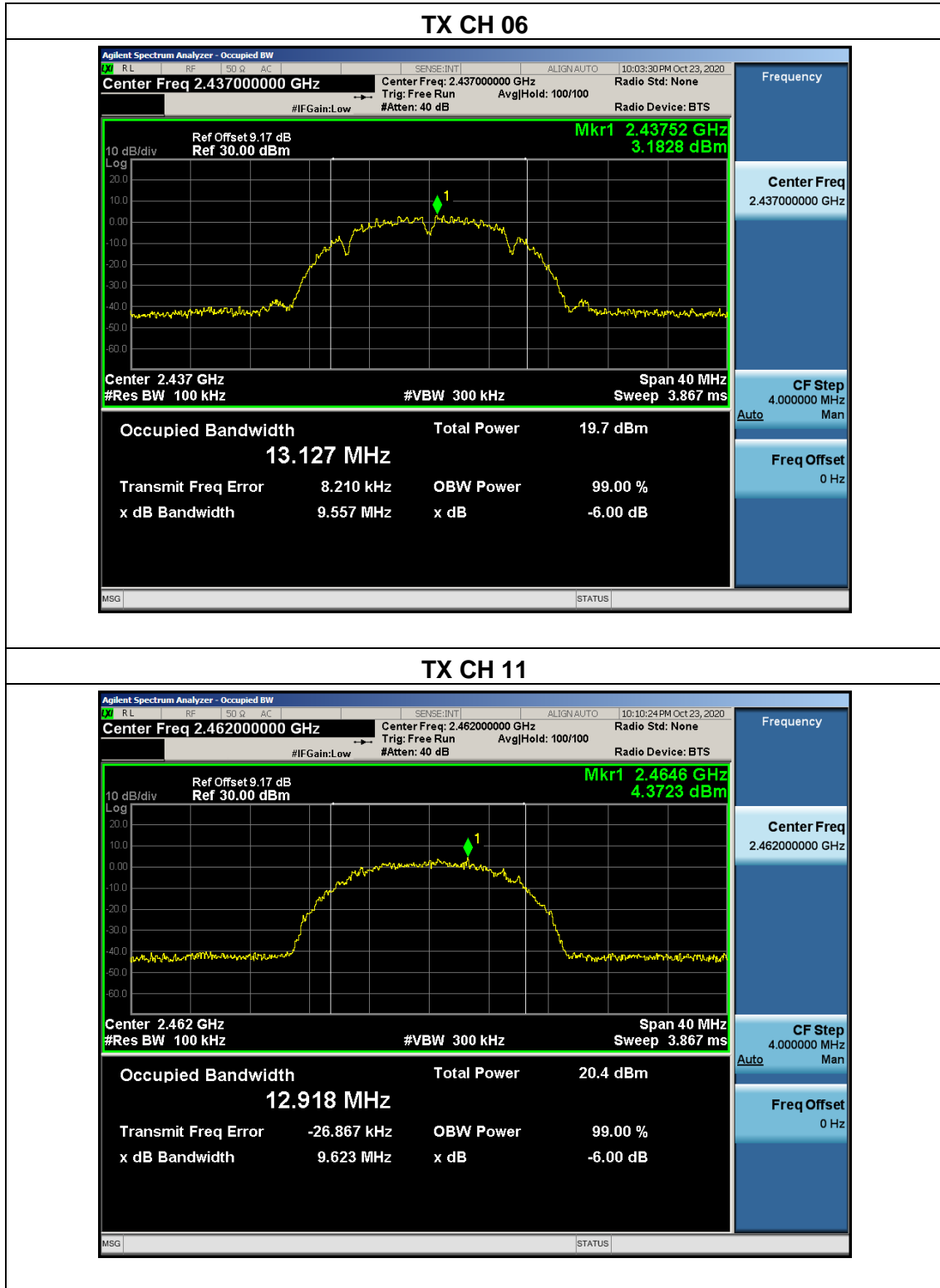

EUT:	SMART MINI CORD	Model Name:	HKWL-SW02WU
Pressure:	1012 hPa	Test Voltage:	AC 120V/60Hz
Test Mode:	TX g Mode /CH01, CH06, CH11		

Channel	Frequency (MHz)	6dB bandwidth (MHz)	Limit (kHz)	Result
Low	2412	16.51	500	Pass
Middle	2437	16.46	500	Pass
High	2462	16.48	500	Pass

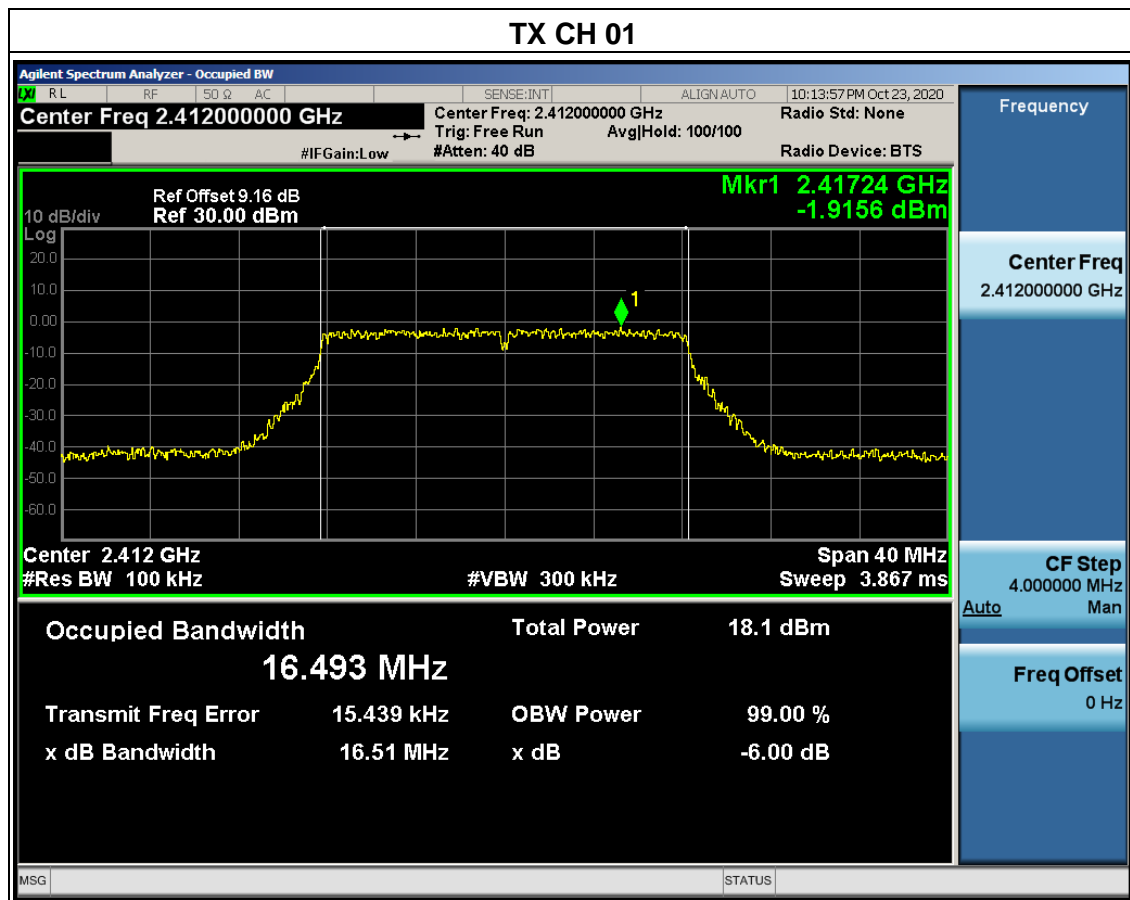

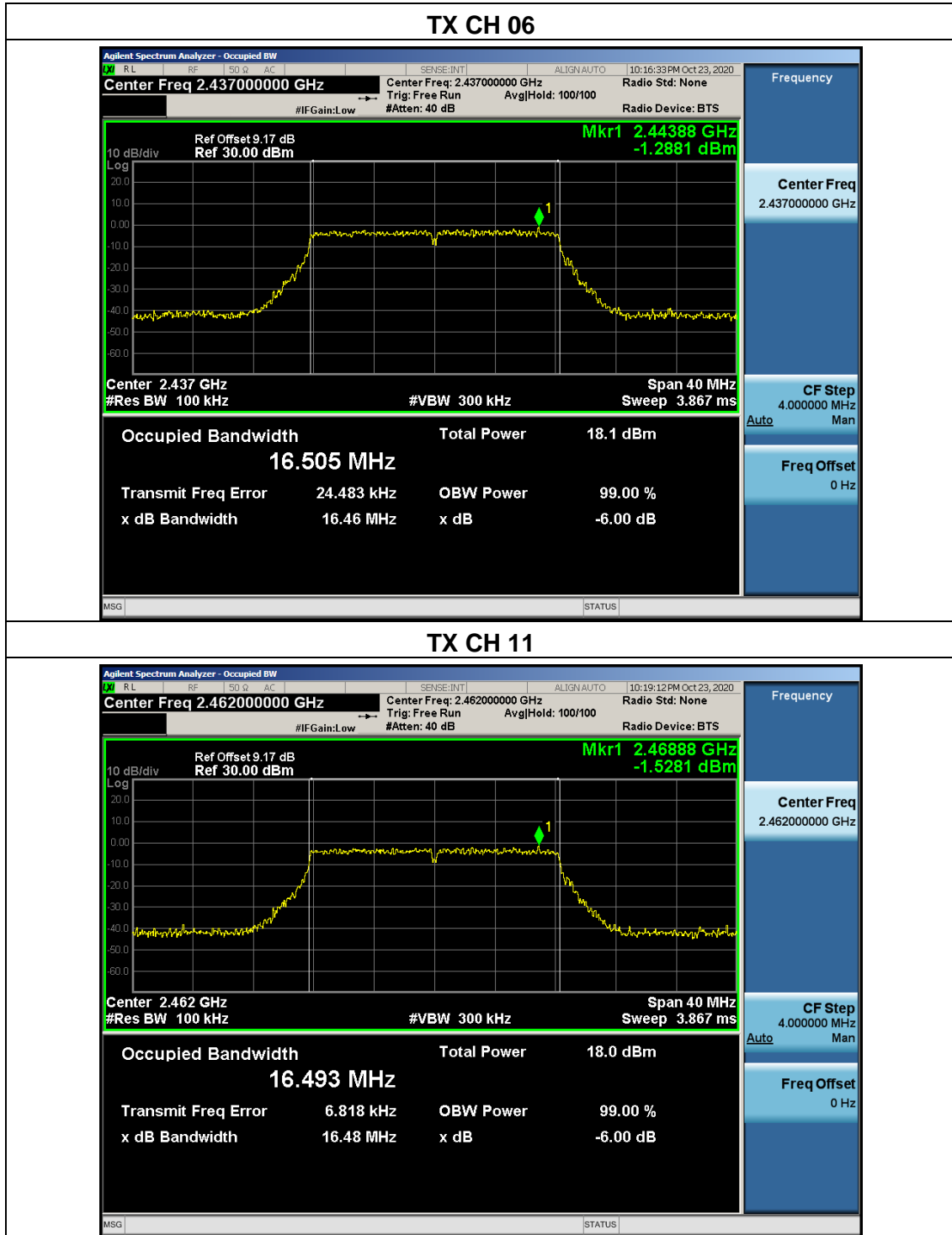

EUT:	SMART MINI CORD	Model Name:	HKWL-SW02WU
Pressure:	1012 hPa	Test Voltage:	AC 120V/60Hz
Test Mode:	TX n20 Mode /CH01, CH06, CH11		

Channel	Frequency (MHz)	6dB bandwidth (MHz)	Limit (kHz)	Result
Low	2412	17.59	500	Pass
Middle	2437	17.60	500	Pass
High	2462	17.59	500	Pass

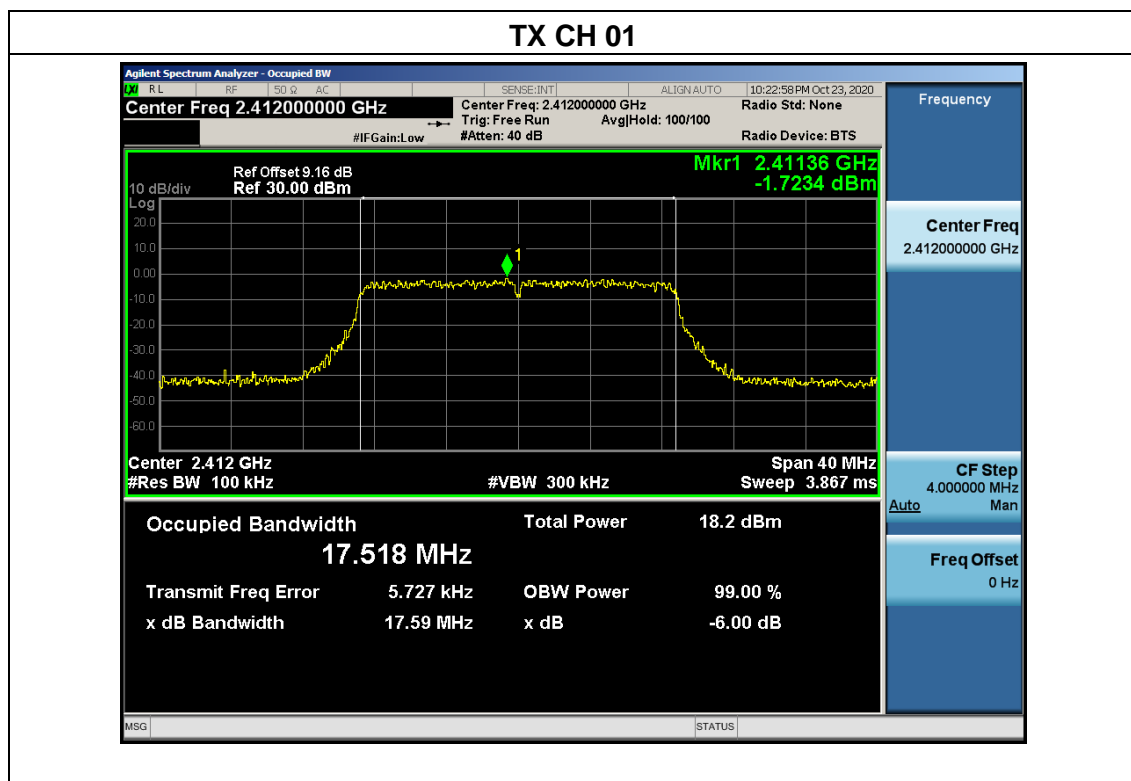

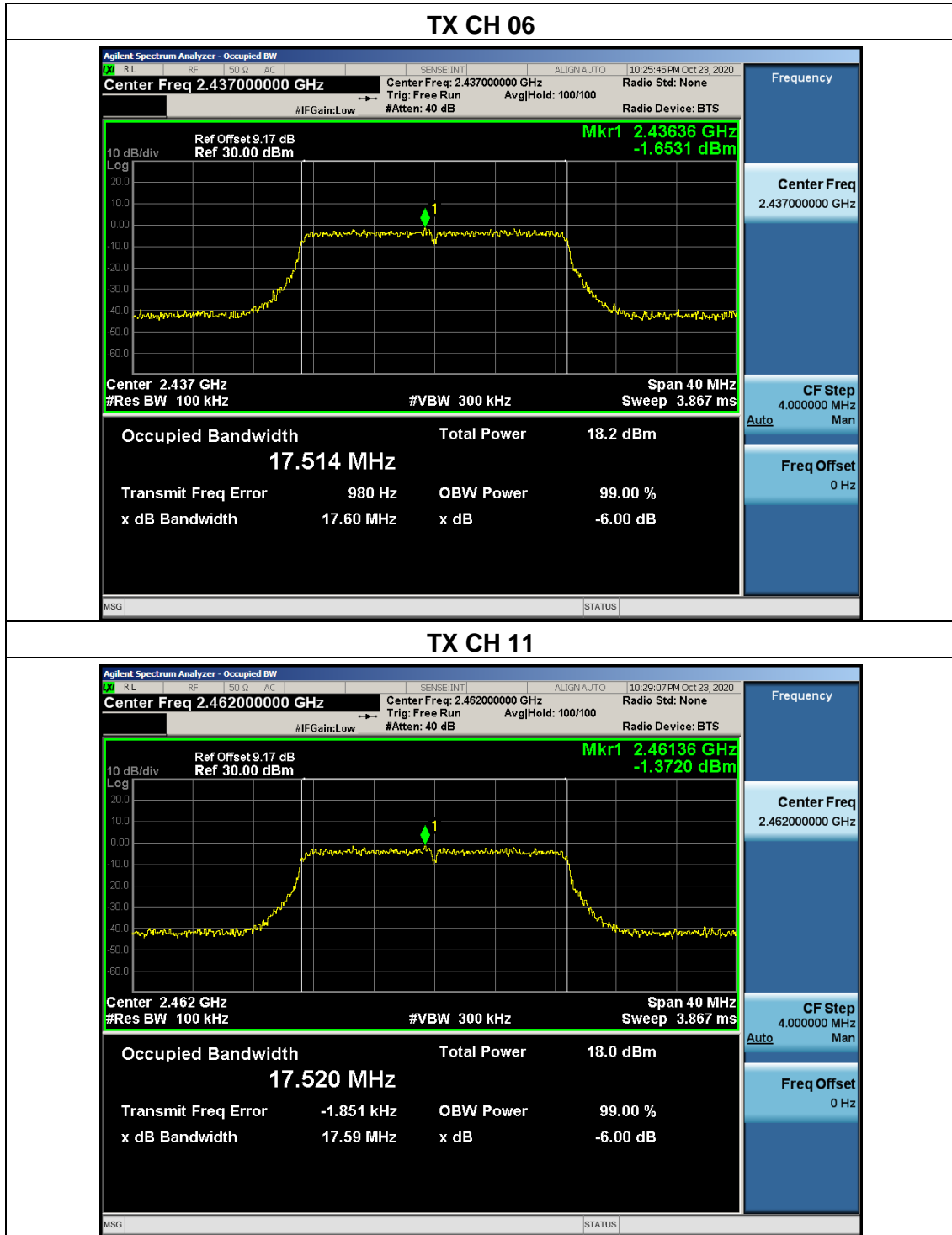

EUT:	SMART MINI CORD	Model Name:	HKWL-SW02WU
Pressure:	1012 hPa	Test Voltage:	AC 120V/60Hz
Test Mode:	TX n40 Mode /CH03, CH06, CH09		

Channel	Frequency (MHz)	6dB bandwidth (MHz)	Limit (kHz)	Result
Low	2422	36.47	500	Pass
Middle	2437	36.48	500	Pass
High	2452	36.49	500	Pass

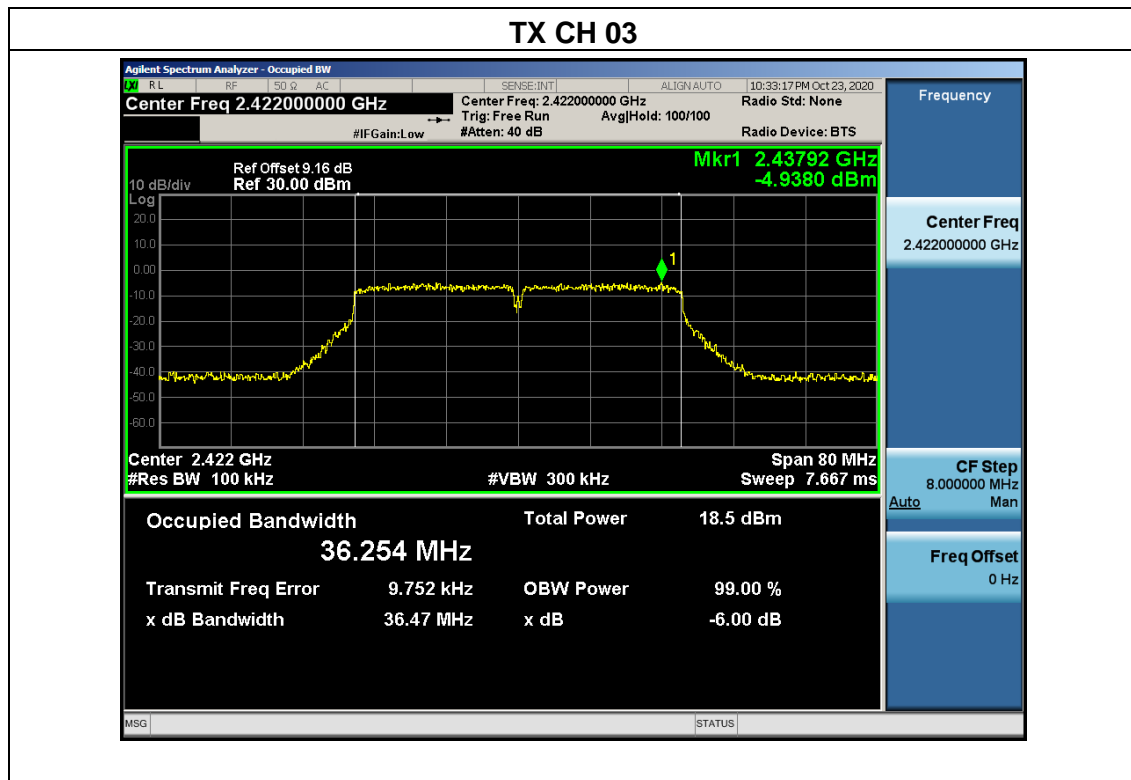

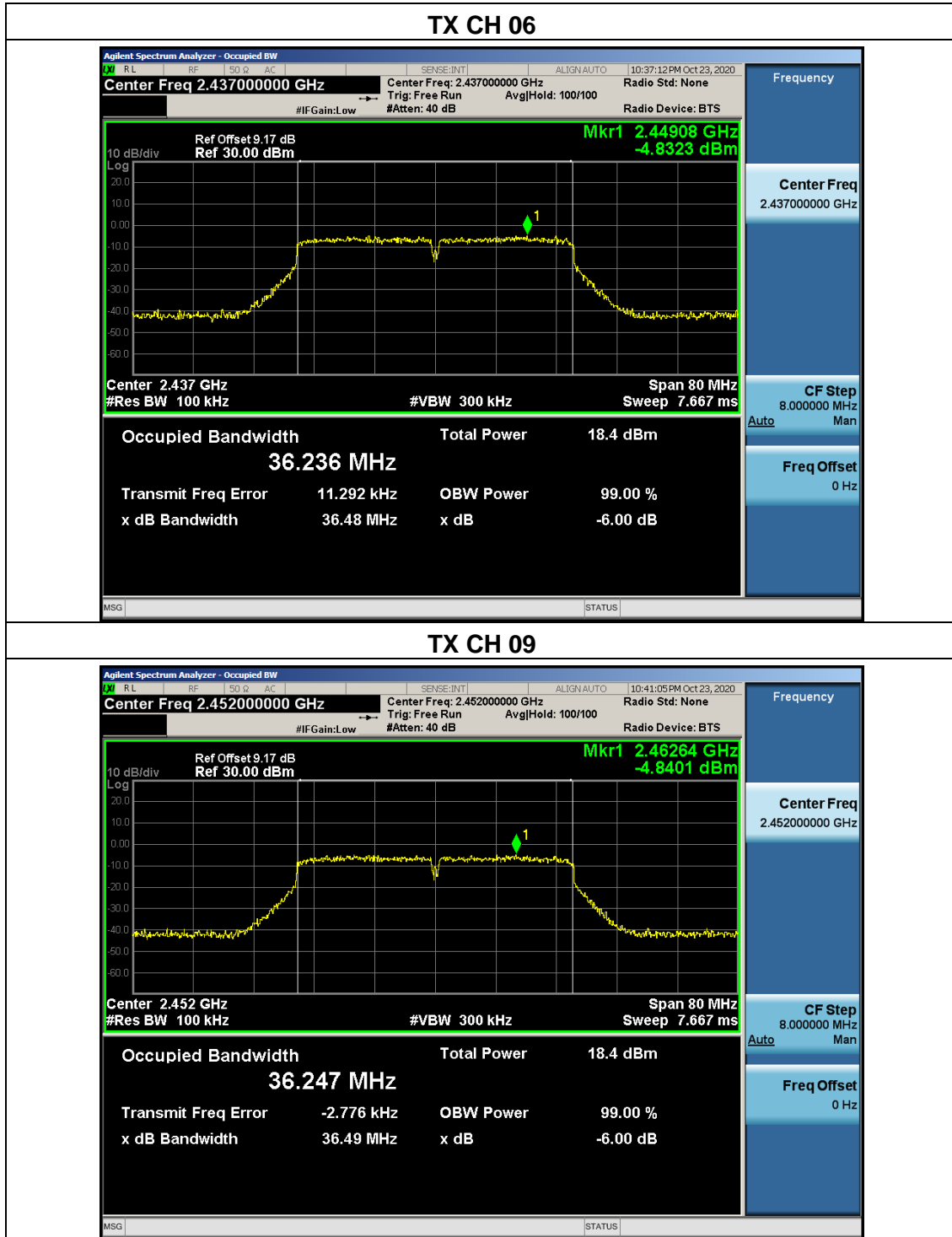

5.8 Duty Cycle

5.8.1 Limit

No limit requirement.

5.8.2 Measuring instruments

The Measuring equipment is listed in the section 4 of this test report.

5.8.3 Test setup

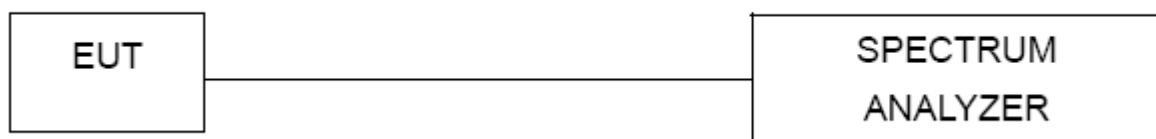

5.8.4 Test procedure

The zero-span mode on a spectrum analyzer or EMI receiver if the response time and spacing between bins on the sweep are sufficient to permit accurate measurements of the on and off times of the transmitted signal. Set the center frequency of the instrument to the center frequency of the transmission. Set $RBW \geq OBW$ if possible; otherwise, set RBW to the largest available value. Set $VBW \geq RBW$. Set detector = peak or average. The zero-span measurement method shall not be used unless both RBW and VBW are $> 50/T$ and the number of sweep points across duration T exceeds 100. (For example, if VBW and/or RBW are limited to 3 MHz, then the zero-span method of measuring duty cycle shall not be used if $T \leq 16.7$ microseconds.)

The transmitter output is connected to the Spectrum Analyzer. We tested according to the zero-span measurement method, 6.0(b) in KDB 558074

The largest available value of RBW is 8 MHz and VBW is 50 MHz. The zero-span method of measuring duty cycle shall not be used if $T \leq 6.25$ microseconds. ($50/6.25 = 8$)

The zero-span method was used because all measured T data are > 6.25 microseconds and both RBW and VBW are $> 50/T$.

The RF output of EUT was connected to the spectrum analyzer by RF cable and attenuator.

The path loss was compensated to the results for each measurement.

Set to the maximum power setting and enable the EUT transmit continuously.

The EUT was operating in controlled its channel.

Use the following spectrum analyzer settings:

Span = Zero Span

RBW = 8MHz (the largest available value)

VBW = 8MHz (\geq RBW)

Number of points in Sweep > 100

Detector function = peak

Trace = Clear write

Measure T total and Ton

Calculate Duty Cycle = Ton / T total

5.8.5 Test Results

EUT:	SMART MINI CORD	Model Name:	HKWL-SW02WU
Pressure:	1012 hPa	Test Voltage:	AC 120V/60Hz
Test Mode:	TX b/g/n(20/40) Mode / CH06		

Mode	Data rate	Channel	Ton	Ttotal	Duty Cycle	Duty Cycle Factor (dB)	VBW Setting
802.11b	1Mbps	6	-	-	100%	0	10Hz
802.11g	6Mbps	6	-	-	100%	0	1kHz
802.11n HT20	MCS0	6	-	-	100%	0	1kHz
802.11n HT40	MCS0	6	-	-	100%	0	3kHz

5.9 Spurious RF Conducted Emissions

5.9.1 Limit

Below -20dB of the highest emission level in operating band.

5.9.2 Measuring instruments

The Measuring equipment is listed in the section 4 of this test report.

5.9.3 Test setup



5.9.4 Test procedure

The Spurious RF conducted emissions compliance of RF radiated emission should be measured by following the guidance in ANSI C63.10-2013 with respect to maximizing the emission by rotating the EUT, measuring the emission while the EUT is situated in three orthogonal planes (if appropriate), adjusting the measurement antenna height and polarization etc. Set RBW=100kHz and VBW= 300kHz to measure the peak field strength, and measure frequency range from 9kHz to 26.5GHz.

5.9.5 Test results

Note:

1: The measurement frequency range is from 9kHz to the 10th harmonic of the fundamental frequency. The lowest, middle and highest channels are tested to verify the spurious emissions and band edge measurement data.

2: The three modulated high, medium and low channels have been tested. The report only shows the worst mode. The worst mode is 802.11b CH01/06/11.

802.11b on Channel 01

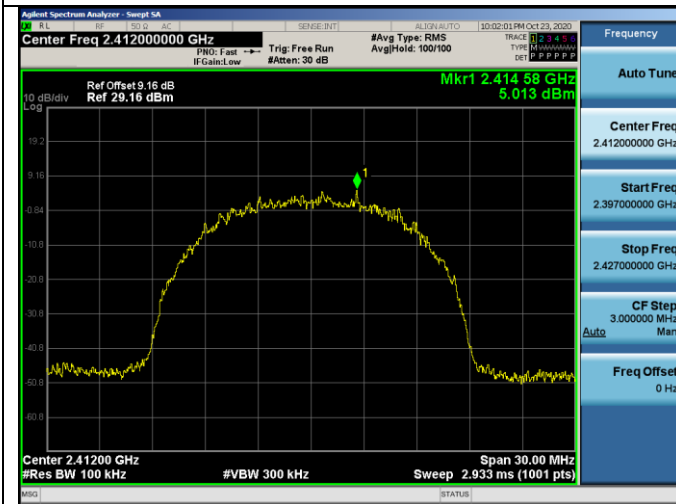

802.11b on Channel 01

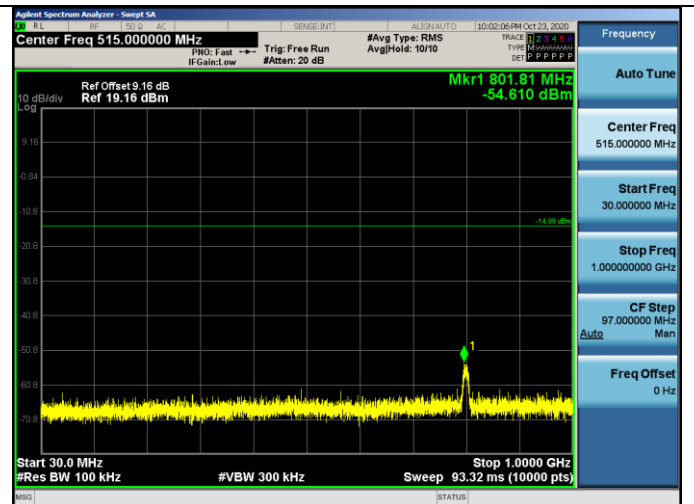

802.11b on Channel 01

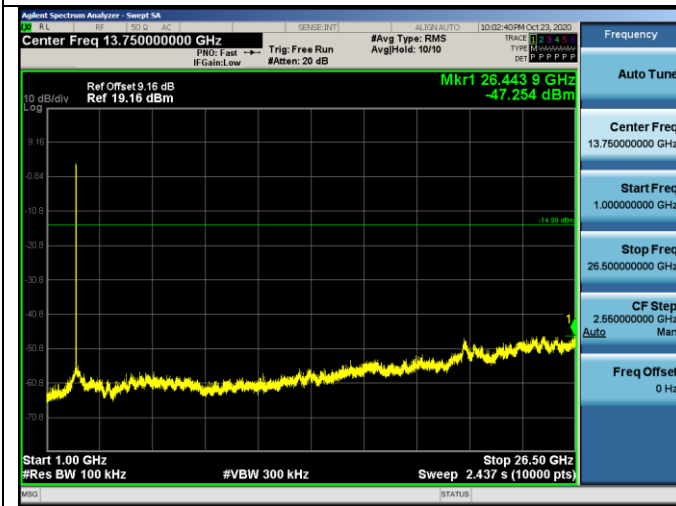

802.11b on Channel 06



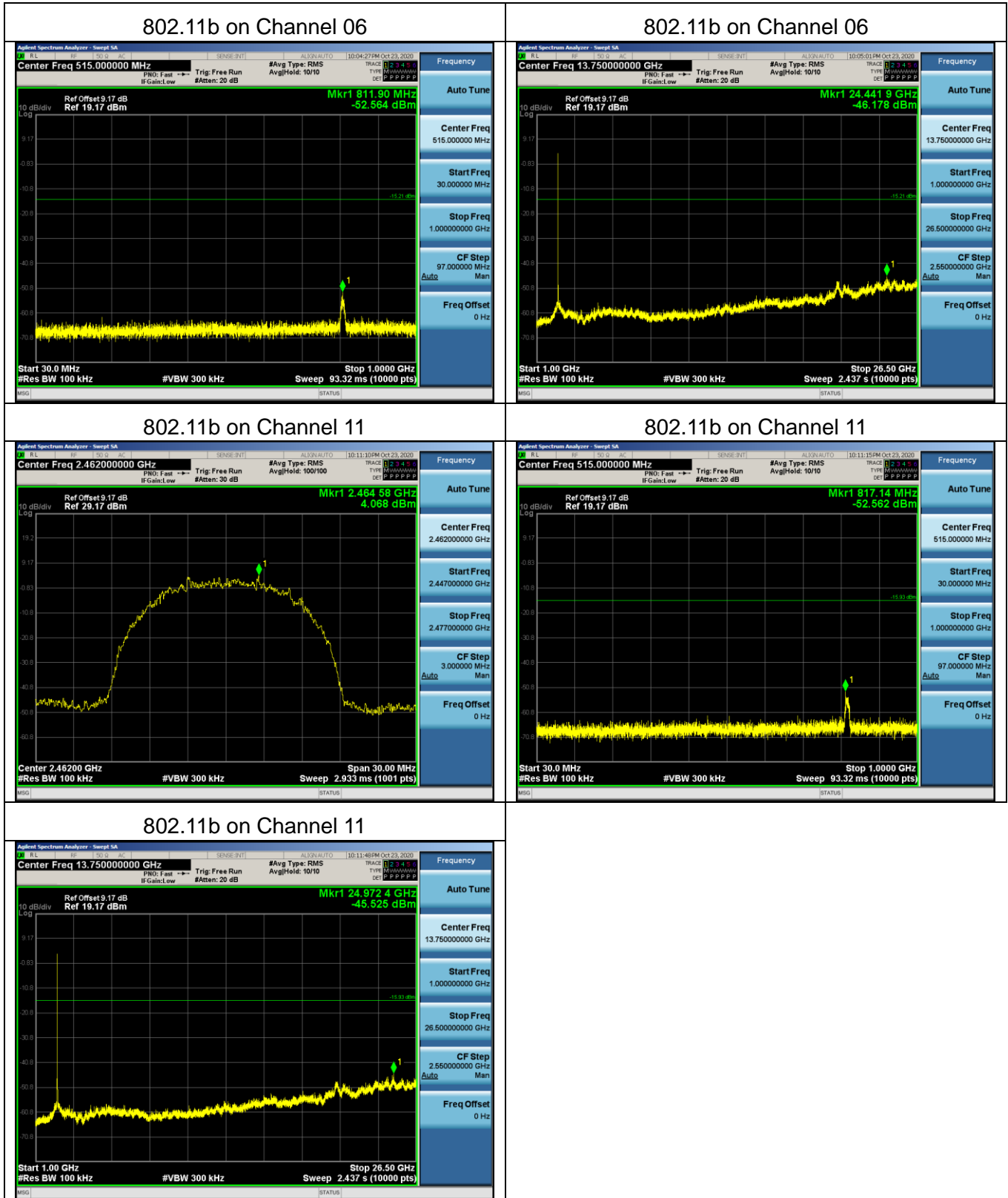



Photographs of the Test Setup

Radiated emission





Conducted emission





Photographs of the EUT

See the APPENDIX 1: EUT PHOTO in the report No.: MTi20082708-2E1-1.

----END OF REPORT----