

SPECIFICATION

Ceramic Antenna 2012 Size

2400-2500 MHz

P/N: HM2012ANT2450-HM1

1. Frequency

2400-2500 MHz

2. Applications

For Miniaturized Bluetooth System

3. Dimensions (Unit : mm)

1). Over View :

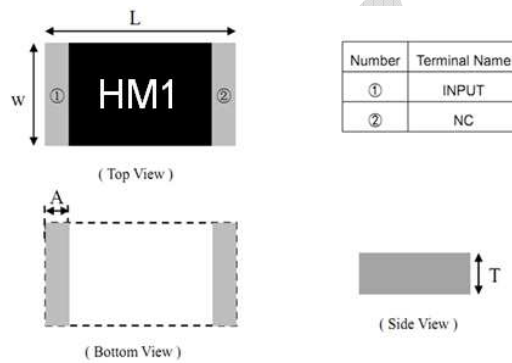

Symbols	L	W	T	A
Dimensions	2.0+/-0.2	1.2+/-0.2	0.5+/-0.1	0.3+/-0.2

2). PCB Layout (Unit : mm) :

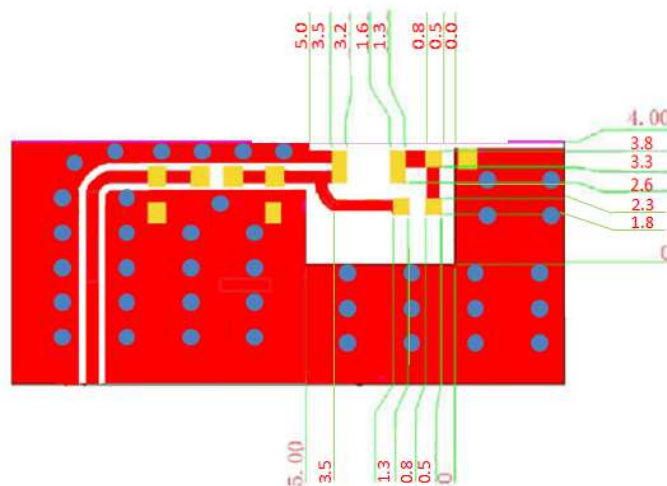

4. Evaluation Board Size and Matching Circuits

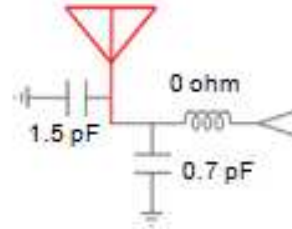
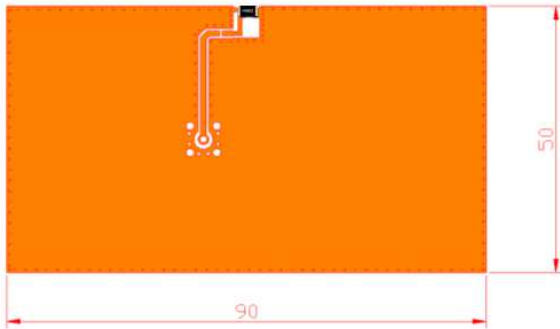

5. Electrical Characteristics

Part Number	HM2012ANT2450-HM1
Central Frequency	2450 MHz
Bandwidth	100(typ.) MHz
V.S.W.R	≤2.0
Peak Gain	3.12 dBi
Impedance	50 Ohm
Polarization	Linear
Azimuth Beamwidth	Omni-directional

6. Return Loss (S11)

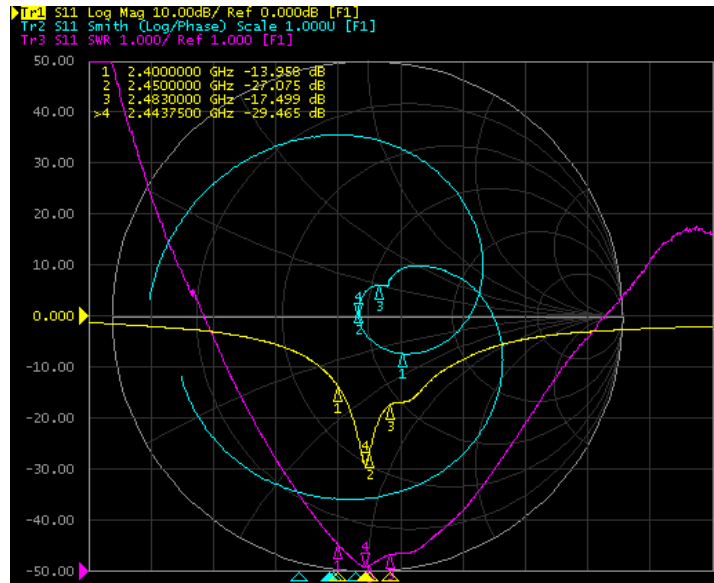

7. Radiation Pattern & Efficiency

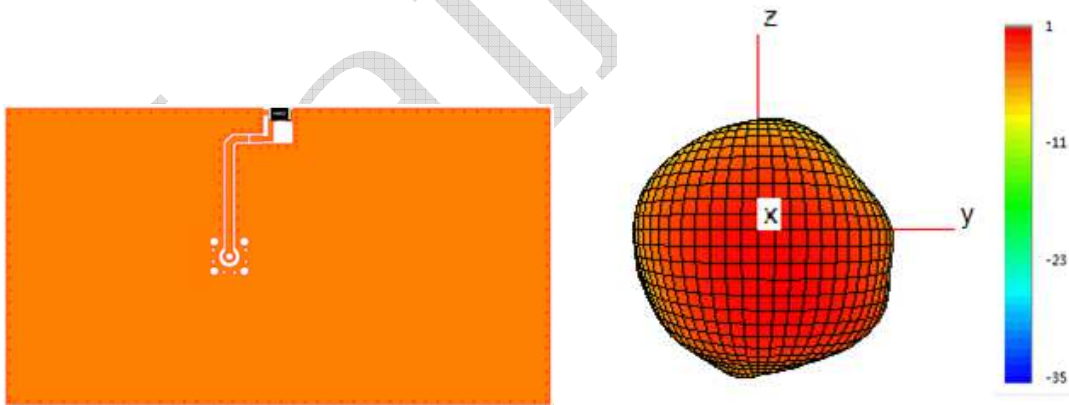

Frequency (MHz)	2400	2450	2500
Efficiency (dB)	-2.22	-1.87	-2.08
Efficiency (%)	60	65	62
Gain (dBi)	2.75	3.12	3.01

8. Reflow Soldering Standard Condition

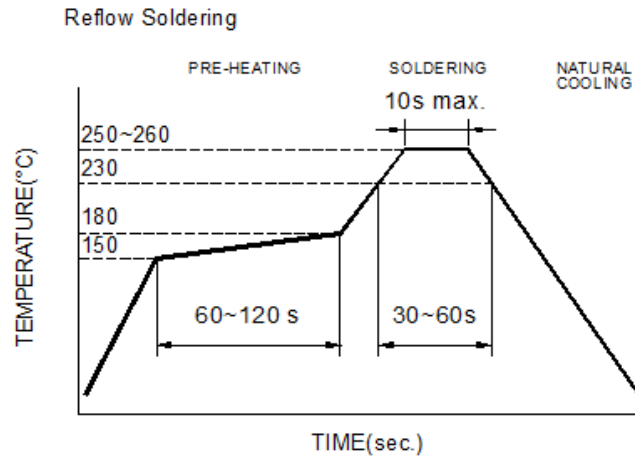

9. Packaging and Dimensions

- Plastic Tape

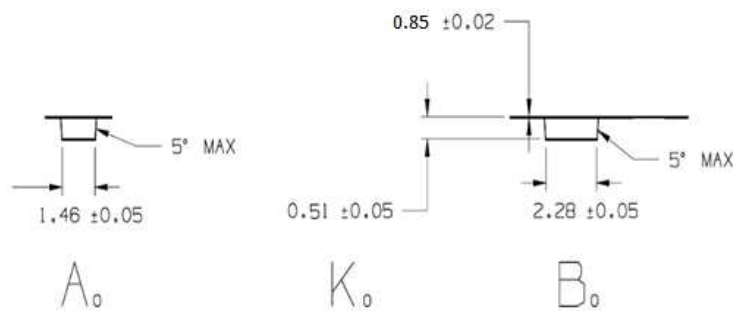
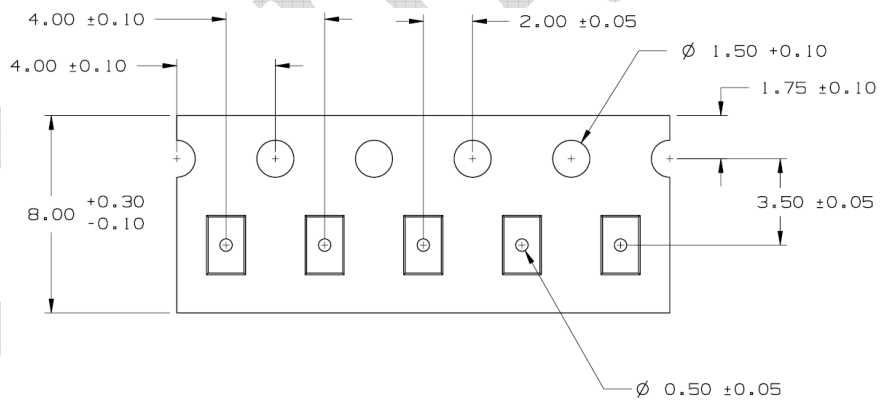

- **Remarks for Package**

Reserve a length of 150~200mm for the trailer of the carrier and 250~300 mm for the leader of the carrier and further 250mm of cover tape at the leading part of the carrier.

- **Reel (6000 pcs/Reel)**

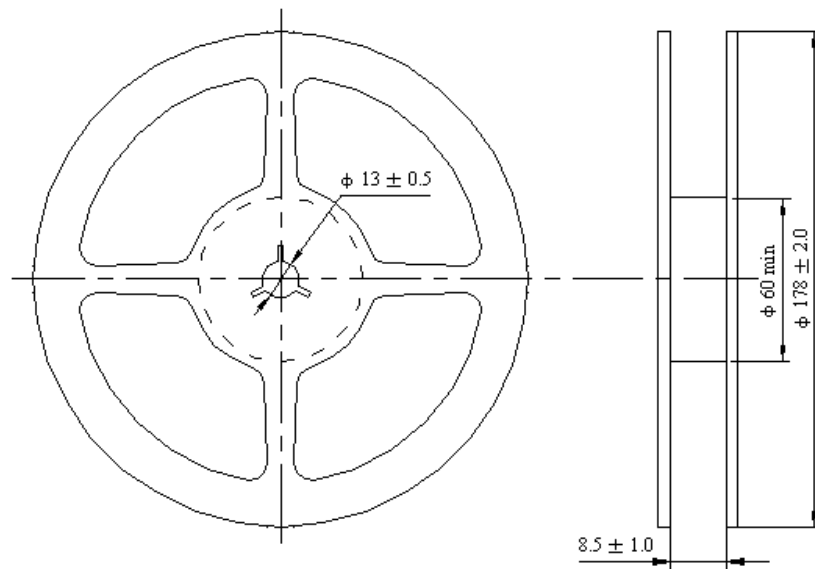

- **Storage Period**

Oxidizable Material, 12 months in vacuum sealed bag, please repack within 168 hours by re-seal the package treatment after using.

Storage Temperature Range : <30 degree C, Humidity : <60%RH

10. Dependability Test

Test item	Test condition / Test method	Specification
Solderability IEC 60068-2-58 GB/T2423.28	*Solder bath temperature : 240±5°C *Immersion time : 2±0.5 sec Solder : Sn96.5Ag3.0Gu0.5 for lead-free.	At least 95% of a surface of each terminal electrode must be covered by fresh solder.
Leaching (Resistance to dissolution of metallization) JIS C5101	*Solder bath temperature : 260±5°C *Leaching immersion time : 10±1 sec Solder : Sn96.5 Ag3.0 Gu0.5 for lead-free.	Loss of metallization on the edges of each electrode shall not exceed 25%.
Resistance to soldering heat IEC 60068-2-58 GB/T2423.28	*Preheating temperature : 120~150°C, 1 minute. *Solder temperature : 260±5°C *Immersion time : 10±1 sec Solder : Sn96.5Ag3.0Gu0.5 for lead-free Measurement to be made after keeping at room temperature for 24±2 hrs.	No mechanical damage. Electrical specification shall satisfy the descriptions in electrical characteristics at the room temperature. Loss of metallization on the edges of each electrode shall not exceed 25%.
Drop Test IEC 60068-2-32 GB/T2423.8 Customer' s specification.	*Height : 50 cm *Test Surface: Rigid surface of concrete or steel. *Times : 6 surfaces for each units ; 2 times for each side.	No mechanical damage. Electrical specification shall satisfy the descriptions in electrical characteristics at the room temperature.
Vibration IEC 60068-2-6 GB/T 2423.10	*Frequency : 10Hz~55Hz~10Hz(1min) *Total amplitude : 1.5mm *Test times : 6hrs.(Two hrs each in three mutually perpendicular directions)	No mechanical damage. Electrical specification shall satisfy the descriptions in electrical characteristics at the room temperature.
Adhesive Strength of Termination IEC60068-2-21 GB/T 2423.6	*Pressurizing force : 5N(≤0603) ; 10N(>0603) *Test time:10±1 sec	No remarkable damage or removal of the termination.

<p>Bending test IEC 60068-2-21 GB/T 2423.29</p>	<p>The middle part of substrate shall be pressurized by means of the pressurizing rod at a rate of about 1 mm/s per second until the deflection becomes 2mm and then pressure shall be maintained for 10±1 sec. Measurement to be made after keeping at room temperature for 24±2 hours.</p>	<p>No mechanical damage. Electrical specification shall satisfy the descriptions in electrical characteristics at the room temperature.</p>
<p>Temperature cycle IEC60068-2-14 GB/T 2423.22</p>	<p>30 minutes at -40°C±2°C. 10~15 minutes at room temperature. 30minutes at +85°C±2°C. 10~15 minutes at room temperature. Total 100 continuous cycles Measurement to be made after keeping at room temperature for 24±2 hrs.</p>	<p>No mechanical damage. Electrical specification shall satisfy the descriptions in electrical characteristics at the room temperature.</p>
<p>High temperature IEC 60068-2-2 GB/T2423.2</p>	<p>*Temperature : 85±2°C. *Test duration : 500+24/-0 hours. Measurement to be made after keeping at room temperature for 24±2 hrs.</p>	<p>No mechanical damage. Electrical specification shall satisfy the descriptions in electrical characteristics.</p>
<p>Humidity (steady conditions) IEC60068-2-3 GB/T 2423.3</p>	<p>*Humidity : 85±5%R.H. *Temperature : 85±2°C. *Time : 500+24/-0 hrs. Measurement to be made after keeping at room temperature for 24±2 hrs ※ 200hrs measuring the first data then 300hrs data.</p>	<p>No mechanical damage. Electrical specification shall satisfy the descriptions in electrical characteristics at the room temperature.</p>
<p>Low temperature IEC 60068-2-1 GB/T2423.1</p>	<p>*Temperature : -40±2°C. *Test duration : 500+24/-0 hours Measurement to be made after keeping at room temperature for 24±2 hrs.</p>	<p>No mechanical damage. Electrical specification shall satisfy the descriptions in electrical characteristics at the room temperature.</p>