

13. Pairing via Bluetooth 蓝牙配网

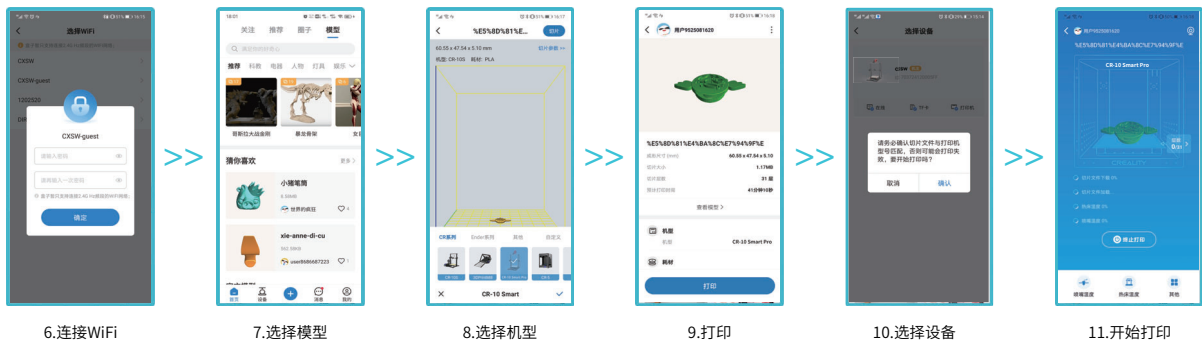

14. Creality Cloud print 创想云打印

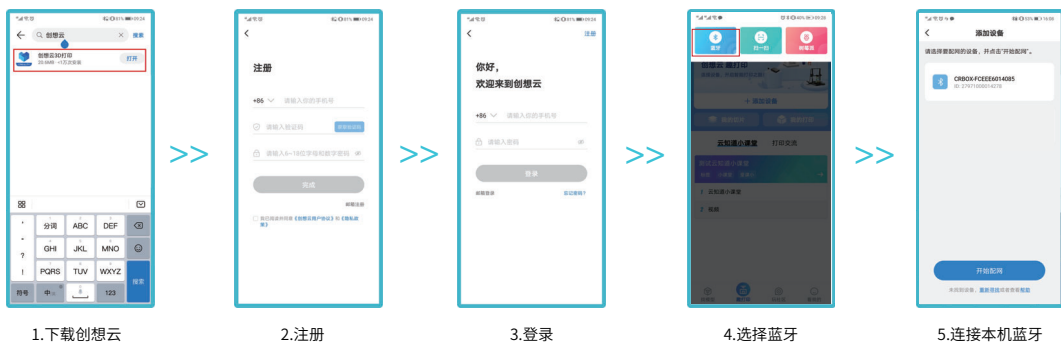
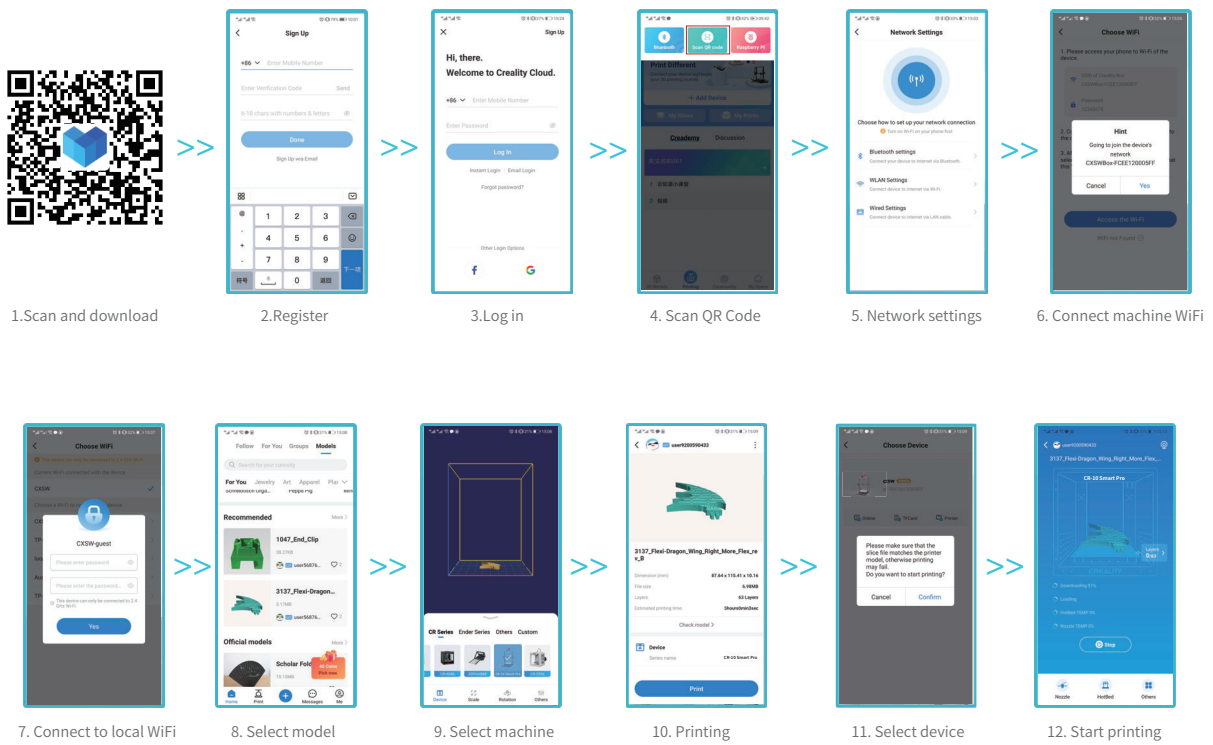

14. Creality Cloud print 创想云打印



15. Off-line print 脱机打印

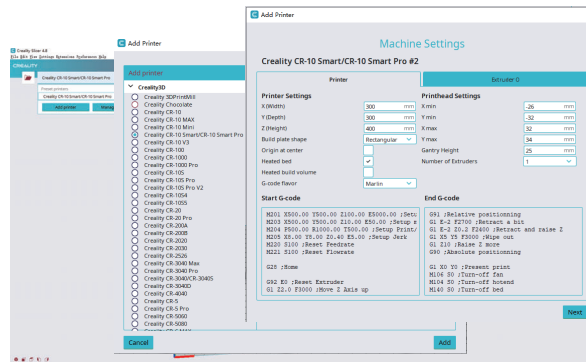

3. Select language → Next → Select your machine → Next → Finish.



1. Download the software from official website (www.cxsw3d.com) or find the software in storage card for installation.
登录官网下载(www.cxsw3d.com)或者在存储卡里找到软件并安装
2. Double click to open the software. | 打开软件



3. 依次选择语言 → 下一步 → 选择对应机型 → 下一步 → 结束, 完成设置.

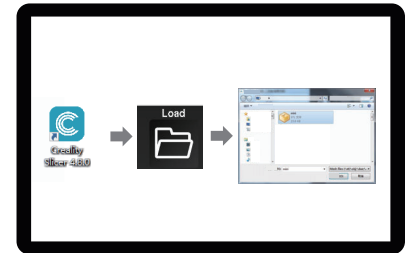

4. Open Creality 3D slicer → Load (Read file) → Select file.
打开创想三维切片软件 → Load (读取文件) → 选择文件。

15. Off-line print 脱机打印

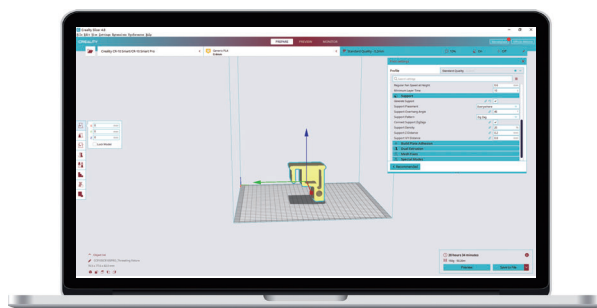

>>

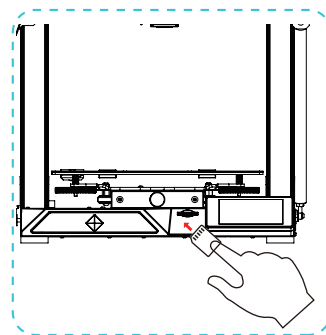

5. Generate G-code, and save the gcode file to storage card.

生成 G 代码文件→保存到存储卡

6. Insert the storage card

插入存储卡



File names must be Latin letters or numbers, not Chinese characters or other special symbols
文件名需为拉丁字母或数字，不能为汉字或其他特殊符号



Notes: 1、For details on the software instructions, please refer to the slicing software manual in the storage card.
2、Saved files can only be copied to the root directory of the SD card, not to subfolders.
温馨提示：1、软件使用说明详情，请见存储卡内切片软件使用手册。
2、保存的文件只能拷贝到SD卡根目录下，不能放在子文件夹里。



Warning: Please don't insert or remove the storage card during printing.
警告：在打印过程中，禁止插拔存储卡。

16. Start Printing 开始打印

Inspect the machine before printing:

Turned off: 1. The nozzle is tight and moves left and right smoothly; 2. X-axis is tightly horizontal and runs smoothly up and down;

3. Y-axis is tight. The platform board does not shake around, and moves back and forth smoothly; 4. The filament rack is tight, the roller works smoothly with uninterrupted materials, and the material comes out smoothly.

Powered on: 1. The display works smoothly and the touch functions normally; the X-axis, Y-axis, and Z-axis move smoothly and sensitively; 2. The heating of the nozzle and heated bed functions normally;

3. Normal material-in and material-out; 4. Normal leveling.

打印之前，还需要做一次机器的基本检查：

关机情况下：1.喷头不松动，左右运动顺滑不卡；2.X轴水平，不会上下晃动，上下运行顺滑；3.Y轴不松动，平台板前后左右不会晃动，前后运动顺畅不卡；

4.耗材料架不晃动，滚轴顺滑不断料，检测出料顺畅。

通电情况下：1.显示屏显示正常，触摸功能正常；移动X，Y，Z轴顺畅灵敏；2.喷头、热床加热正常；

3.进料退料正常；4.调平正常。

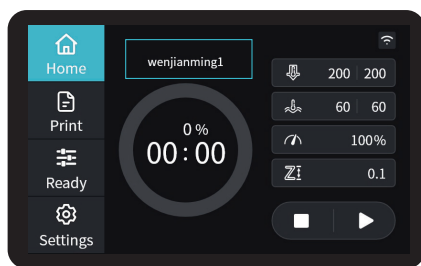

Click print control

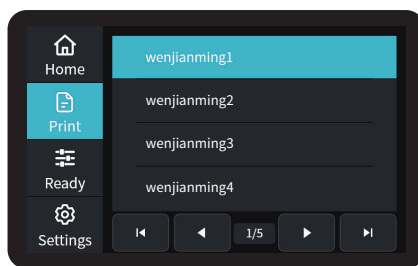

Select the file to be printed

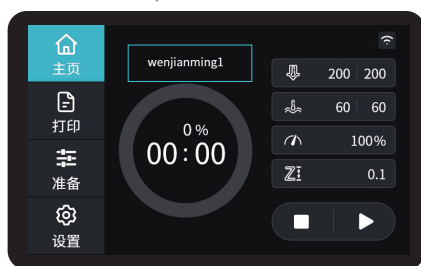
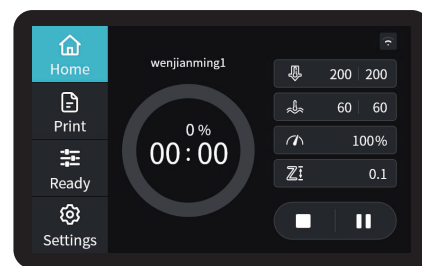

点击打印控件

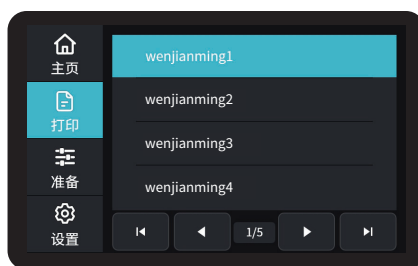

选择要打印的文件

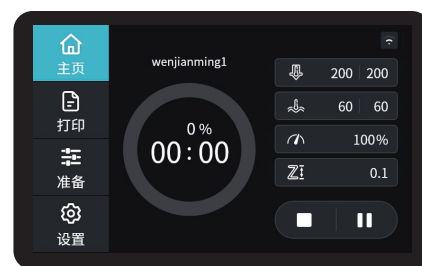

17. Network reset 网络复位



Note: 注意:

1. In the first use or if you need to clear the owner information, you can click "Restore network" button on the screen, wait for 1-2 minutes and then try to scan the code again or connect the network via Bluetooth.
1. 在首次使用或需要清除机主信息时，可点击屏幕“恢复网络设置”后，等待1-2min尝试重新扫码或蓝牙连接配网。

18. Printer maintenance 打印机维护



1. Manually adjust the tightness as needed by turning the knob left and right (clockwise to tighten and counterclockwise to loosen.) Avoid over tightening, which may break the belt and cause damage to the machine. (As shown in A)

1.手动将旋钮左右拧到适合松紧度（顺时针调紧，逆时针调松。）不要调的过紧，以免拉断皮带，导致机器损坏。（如图所示A处）

2. Please use clean water to clean the dirt on the flat pallet.

2.当平台脏污需要清洗时，要用清水来清洗。

3. The machine will restart after power interruption and pop out the "resume printing" button. Please clear the redundant filament between the nozzle and model before resumption to avoid printing failure.

3.当发生断电后，机器重启开机启动，会弹出断电续打提示框。需要断电续打前，建议将喷头与模型之间多余溢料清除干净再继续打印，以免出现打印失败。

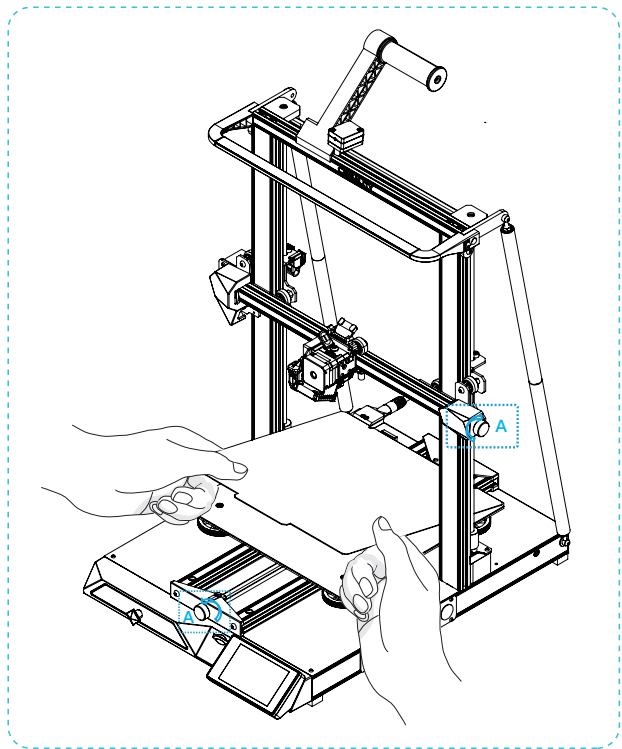

19. Circuit Wiring 电路接线



20. Trouble-shooting

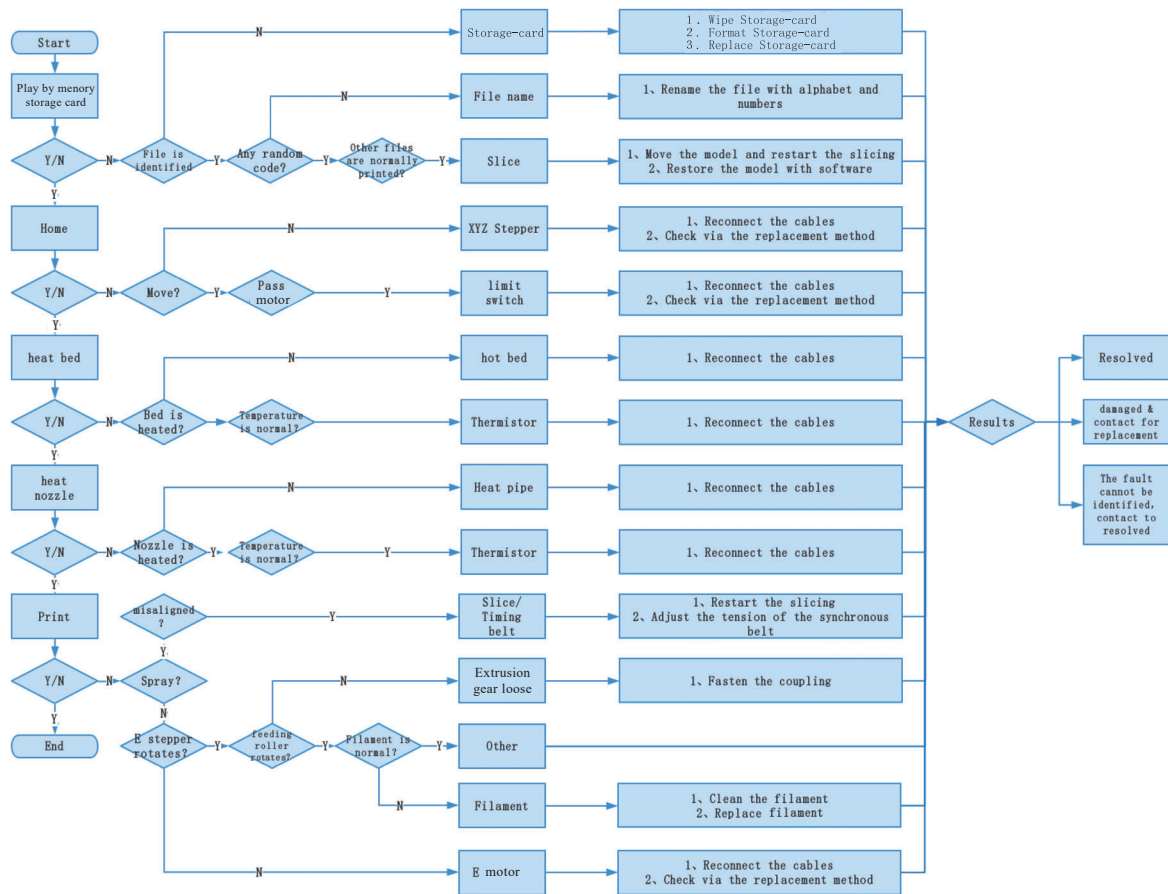

21. 故障检修

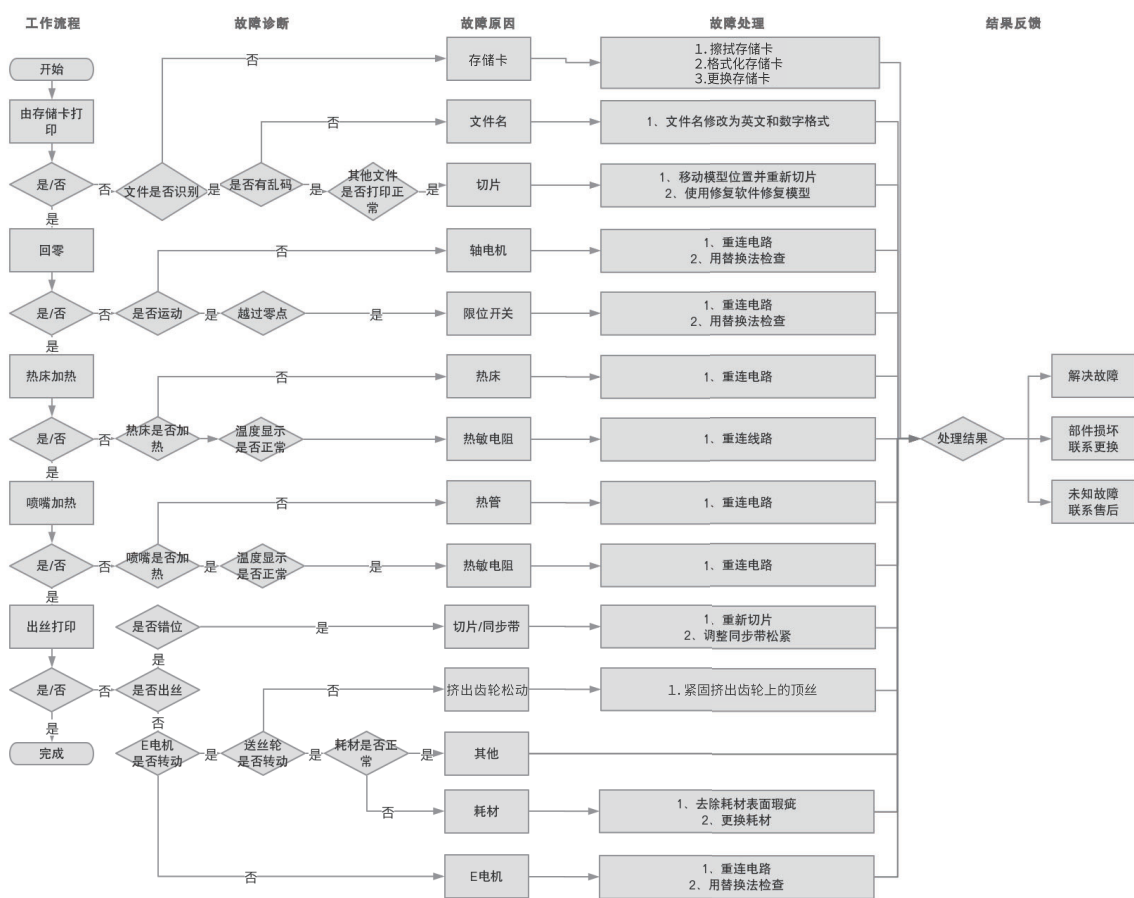

22. After-Sales Service Card

Warranty Policy ←

- 1-year Limited Warranty since the date of product purchase.
- 3-months Limited Part Warranty for Vulnerable parts (Nozzle module, Flat belt, Glass platform, etc.)
- No Warranty for the Product Gift (Storage card, Card reader, Wrench, Pliers, Scraper knife, etc.)

What Is Covered? ←

Any defects in material, workmanship of product will be covered until you provide any relating documents and information, including but not limited to:

- User of the product are in the country of purchase
- Defective product is a CREALITY product
- Proof of Purchase

What Is Not Covered? ←

CREALITY does not guarantee the service as a result of:

1. The proof of purchase being altered or made illegible.
2. The product label or serial number on the product being altered or made illegible.
3. Normal wear of accessories or consumables for use as release film.
4. Malfunction or damage caused by personal retrofitting, or improper installation and usage.
5. Malfunction or damage caused by use in non-recommended working environments.
6. Malfunction or damage caused by overuse (overload) or wrong maintenance (damp, mildew, etc.)
7. Malfunction or damage caused by Force Majeure (fire hazard, earthquake, lightning and floods, etc.)
8. Malfunction or damage caused by the use of other brand parts or consumable.

Technical Support ←

Please enjoy our technical support of the whole lifetime (Except technical problem beyond product itself) after purchase the product while product documents as user manual attached in storage card for instruction.

Please provide product Serial Number when apply for technical support.

Kindly Notification ←

Please read the user manual and warranty card carefully before the use. For any service, Please priority contact local seller or contact us via Email: cs@creality.com for support.

See www.creality.com/after-service-policy/ for specific warranty information about your product and procedures to act on a warranty claim.

售后服务卡

退/换货政策 <

一、满足退/换货时间

- ① 电商平台购买支持7天无理由退货，即产品签收时间起算，满168小时为7天。
- ② 因机器品质问题，非人为损坏的情况，签收后15天内可申请退换货。
- ③ 如另通过合同购买且有签订退换货时间的以合同为准，运费标准以售后服务卡为准。

二、产品外观要求无损伤、划痕、污迹、裂纹、变形等；随机配件、工具、赠品、包装等要求齐全完好。经我司售后检测判定，如退/换货收到的产品外观损坏，配件不全或因未按照原包装打包邮寄导致的问题，客户需承担相应的费用，具体损耗及费用需寄回后经专业售后人员进行检测核算。

三、非质量问题退/换货，如使用了耗材，客户需承担耗材的费用；由于包装纸盒或打包木架返厂后是无法二次使用的，因此客户需承担包装费；具体损耗及费用需寄回后经专业售后人员进行检测核算。

四、因不喜欢、不想要、拍错、使用不当、不满意产品等原因造成的退换货，退回运费需客户自行承担。

五、换货时，客户需先将机器寄回，公司收到机器后会及时安排发货。

退/换货运费标准 <

类型	分类	寄回运费	出库运费
换货	非品质问题	客户承担	公司承担
	品质问题	公司承担	公司承担
退货	非品质问题	客户承担	/
	品质问题	公司承担	/

保修政策 <

一、质保期

- ① 产品保修一年，易损件和赠品除外。
- ② 易损件（喷头套件、平皮带、玻璃等）保修三个月。
- ③ 赠品（存储卡、读卡器、扳手、剪钳、螺丝刀等）无保质期。收到产品后，请核对说明书部件清单，如赠品有缺少或品质问题，7天内可联系售后申请补发或更换。

二、质保期内保修：经我司售后检测判定为品质问题，公司提供免费维修服务；如果是人为导致的非品质问题，客户需承担相应更换的配件费用，无需承担维修费。

三、质保期外维修：由客户承担维修过程中产生的人工费、配件费、包装费、来回运费等所有费用。

返厂维修运费标准 <

类型	返厂时间	返厂运费	出库运费
非品质问题	三个月以内	客户承担	公司承担
	三个月以上	客户承担	客户承担
品质问题	一个月以内	公司承担	公司承担
	一至三个月	客户承担	公司承担
	三个月以上	客户承担	客户承担

售后服务卡

下列情况不列入质保范围 <

- ① 无法提供有效的机器制造编码、购买凭证和保修卡，或信息被涂改、字迹模糊、无法辨认等。
- ② 正常的使用磨损而造成的部件损坏。
- ③ 未按说明书指导，不正确安装、使用及操作，或私自对机器进行改装而造成机器故障或损坏。
- ④ 在非机器规定的工作环境下使用而造成机器故障或损坏。
- ⑤ 由于滥用（超出工作负荷等）或维护不当（受潮、进液、浸泡、发霉等）造成机器故障或损坏。
- ⑥ 由于不可抗因素（如：火灾、地震、雷击、水灾等）造成机器故障或损坏。
- ⑦ 由于使用其他品牌部件或低质量耗材造成的设备故障或损坏。
- ⑧ 未经官方授权的服务点维修过的机器。

技术支持 <

凡购买创想三维3D打印机，均可享受（除产品本身之外）终生技术支持，如超越产品本身的技术问题恕不提供。本产品存储卡中有相关使用资料，如在使用过程中遇到技术问题，请联系售后客服帮您解决。

温馨提示 <

- ① 使用机器前请仔细阅读说明书和售后服务卡。
 - ② 质保期内维修过的机器后仍享有剩余质保服务。
 - ③ 退/换货及返厂维修需按原包装寄回机器，以免快递过程中产生其他问题，建议妥善保存好产品原包装。
 - ④ 申请质保服务时，需提供产品制造编码、购买凭证、订单号、保修卡、发票等信息。如未提供，公司有权拒绝提供质保服务。
 - ⑤ 服务时间：周一至周五，8:30-20:30；周六至周日，8:30-18:00（法定节假日除外）。
- 热线：400-613-3882，微信公众号：深圳市创想三维科技股份有限公司

WARRANTY

Before returning the product and filling in a warranty, please contact after-sale person for going through after-sale formality. And attach this warranty card along with the returned machine.

Repair

Change

Return

Name: _____ Telephone: _____

Address: _____

Serial Number: _____ Order Number: _____

Channel: Platform Offline

Date of purchase Day _____ Mon. _____ Year _____

Malfunction And Damage Depiction Or Return And Change Reasons\ Suggestions:

Repair Records:

↓
Note: Client need filling in basic infor. and return reasons. Repair records shall retain for technicians.

产品保修卡

产品寄回前请先联系售后专员，为正常进行售后处理，请务必填写此卡，并随机器寄回。

返修

换货

退货

客户名称：_____ 联系电话：_____

收件地址：_____

机器制造编码：_____ 订单编号：_____

购买渠道：电商平台 线下

购买日期：_____年_____月_____日

故障描述或退、换货原因和建议：

维修情况记录：

↓
温馨提示：基本信息及返厂原因为客户必填项，维修情况记录部分为维修人员填写项。



FCC Statement



FCC Caution:

Any Changes or modifications not expressly approved by the party responsible for compliance could void the user's authority to operate the equipment.

This device complies with part 15 of the FCC Rules. Operation is subject to the following two conditions: (1) This device may not cause harmful interference, and (2) this device must accept any interference received, including interference that may cause undesired operation.

IMPORTANT NOTE:

Note: This equipment has been tested and found to comply with the limits for a Class B digital device, pursuant to part 15 of the FCC Rules. These limits are designed to provide reasonable protection against harmful interference in a residential installation. This equipment generates, uses and can radiate radio frequency energy and, if not installed and used in accordance with the instructions, may cause harmful interference to radio communications. However, there is no guarantee that interference will not occur in a particular installation. If this equipment does cause harmful interference to radio or television reception, which can be determined by turning the equipment off and on, the user is encouraged to try to correct the interference by one or more of the following measures:

- Reorient or relocate the receiving antenna.
- Increase the separation between the equipment and receiver.
- Connect the equipment into an outlet on a circuit different from that to which the receiver is connected.
- Consult the dealer or an experienced radio/TV technician for help.

FCC Radiation Exposure Statement:

This equipment complies with FCC radiation exposure limits set forth for an uncontrolled environment.

This equipment should be installed and operated with minimum distance 20cm between the radiator & your body.

Statement

For pluggable equipment, the socket-outlet shall be easily accessible.
Pour l'équipement pluggable, la prise de prise doit être facilement accessible.

Do not use this apparatus near water.
Ne pas utiliser cet appareil à proximité des sources d'eau.

Clean only with dry cloth.
Nettoyer seulement avec un chiffon doux sec.

Only use attachment/accessories specified by the manufacturer.
N'utiliser que des accessoires recommandés par le fabricant.

Unplug this apparatus during lightning storms or when unused for long periods of time.
Débrancher l'appareil durant les orages ou lorsque non utilisé pendant de longues périodes.

Refer all servicing to qualified service personnel. Servicing is required when the apparatus has been damaged in any way, such as power-supply cord or plug is damaged, liquid has been spilled or objects have fallen into the apparatus, the apparatus has been exposed to rain or moisture, does not operate normally, or has been dropped.
Confier la réparation à du personnel technique qualifié. Faire réparer lorsque l'appareil est endommagé; lorsque le câble ou la fiche d'alimentation est endommagé, lorsqu'on a renversé du liquide ou si des objets sont tombés dans l'appareil, lorsque l'appareil a été exposé à de la pluie ou à de l'humidité, si l'appareil ne fonctionne pas normalement, ou lorsqu'il est tombé.

Internal/External Voltage Selectors : Internal or external voltage selector switches, if any, should only be reset and re-equipped with a proper plug for alternative voltage by a qualified service technician. Do not attempt to alter this yourself.
Sélecteurs de tension interne/externe : Les sélecteurs de tension interne ou externe, s'il y en a, doivent être réinitialisés et équipés avec une fiche adéquate par un technicien qualifié. Ne jamais tenter de modifier ceci vous-même.

Protective earthing terminal : The apparatus should be connected to a mains socket outlet with a protective earthing connection.
Borne de terre de protection : Par mesure de sécurité, l'appareil doit être branché à une prise decourant comprenant une borne de mise à la terre.

When moving or not using the appliance, secure the power cord (e.g., wrap it with a cable tie). Be careful not to damage the power cord. Before using it again, make sure the power cord has not been damaged. If the power cord has been damaged at all, bring the unit and cord to a qualified service technician for repair or replacement as specified by the manufacturer.

Veillez à toujours fixer le câble d'alimentation lors du déplacement de l'appareil ou lorsqu'il n'est pas utilisé. Veillez à ne pas endommager le câble d'alimentation. Vérifiez toujours le câble d'alimentation avant d'utiliser l'appareil. Si le câble d'alimentation est endommagé de quelque façon, faites vérifier l'appareil et le câble d'alimentation par un technicien qualifié recommandé par le fabricant afin de les faire réparer ou replacer.

Disconnect power cord before servicing.
Déconnectez l'appareil avant le service.

Replace critical components only with factory parts or recommended equivalents.
Remplacez les composants seulement avec des composants de la fabrique ou avec des équivalents recommandés.

CAUTION: TO REDUCE THE RISK OF ELECTRIC SHOCK, DO NOT REMOVE ANY COVER. NO USER-SERVICEABLE PARTS INSIDE. REFER SERVICING TO QUALIFIED SERVICE PERSONNEL ONLY.

CAUTION: POUR REDUIRE LE RISQUE DE CHOQUE ELECTRIQUE N'ÉLOIGNEZ PAS LA COUVERTURE. PAS DE COMPONENTS UTILISABLES AU SERVICE À L'INTERIEUR. DEMANDEZ SERVICE SEULEMENT AU PERSONNEL QUALIFIE.

Due to the differences between different machine models, the physical objects and the final images can differ. The final explanation rights shall be reserved by Shenzhen Crealty 3D Technology Co., Ltd.

因每款机型不同,实物与图可能有所差异, 请以实物为准, 最终解释归深圳市创想三维科技股份有限公司所有。



SHENZHEN CREALTY 3D TECHNOLOGY CO., LTD.

Add: 18F, JinXiuHongDu Building, Meilong Blvd., Longhua Dist., Shenzhen, China 518131

Official Website: www.crealty.com

Tel: +86 755-8523 4565

E-mail: info@creality.com cs@creality.com

深圳市创想三维科技股份有限公司

深圳市龙华区民治街道新牛社区梅龙大道锦绣鸿都大厦18F

公司网站: www.cxsw3d.com

服务热线: 400 6133 882 0755-8523 4565

Scan To Learn More
扫码了解更多

