

## 2. Unboxing

### 2.2 Install the Product

⑤ Select a language and click "Next", Remove three screws a, b and c according to position indicated by the yellow arrow. click "OK" on the screen.

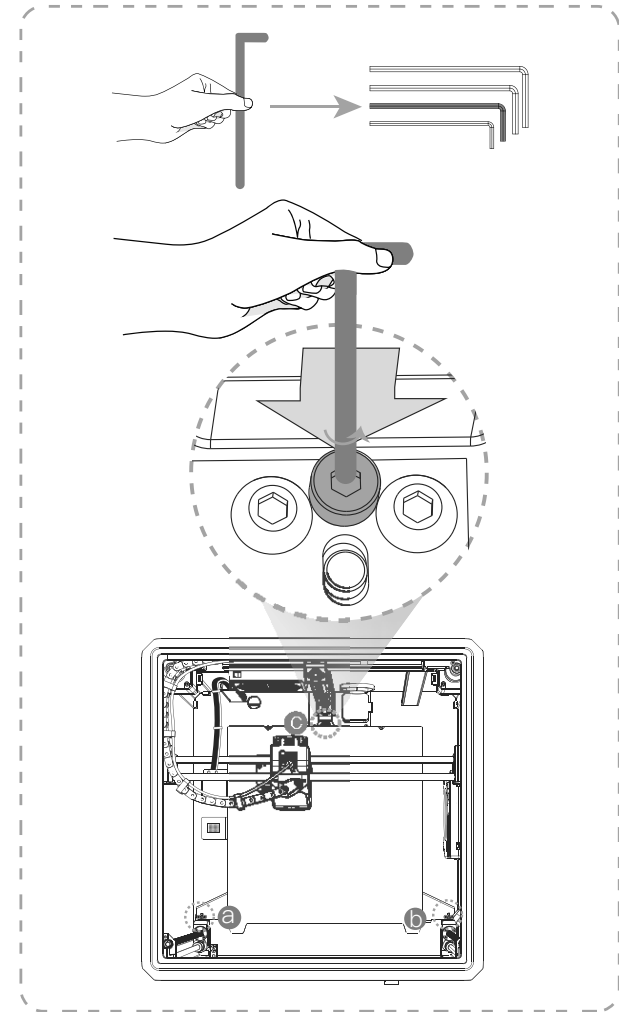
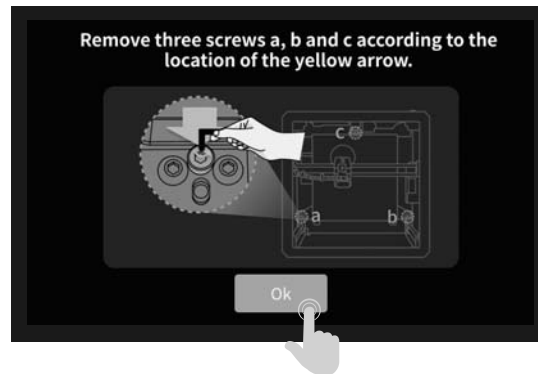

⑥ Keep the blue cube in the figure clean of debris and then click "OK".

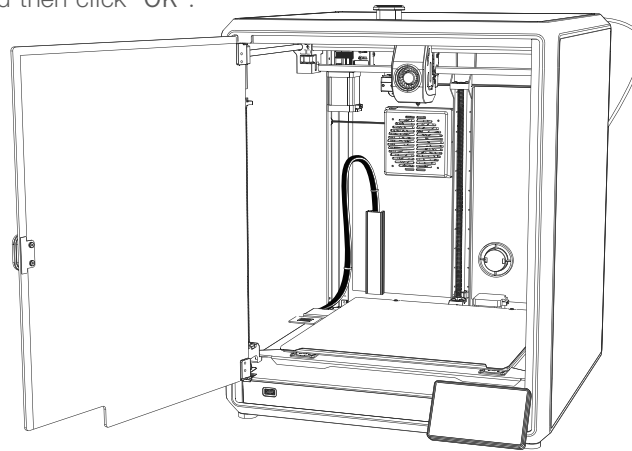
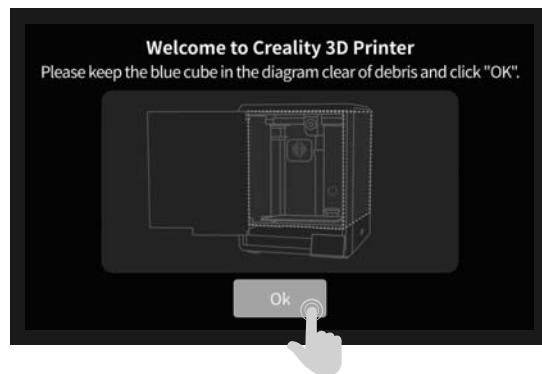

## 2. Unboxing

### 2.3 Power-on guide

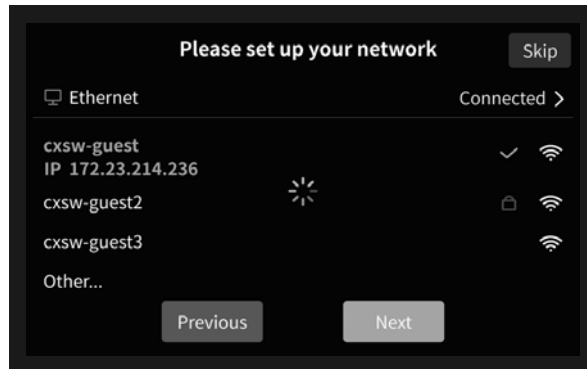

① Network Settings

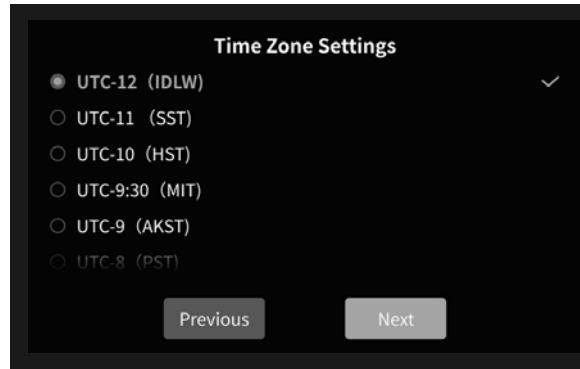

② Time Zone Settings

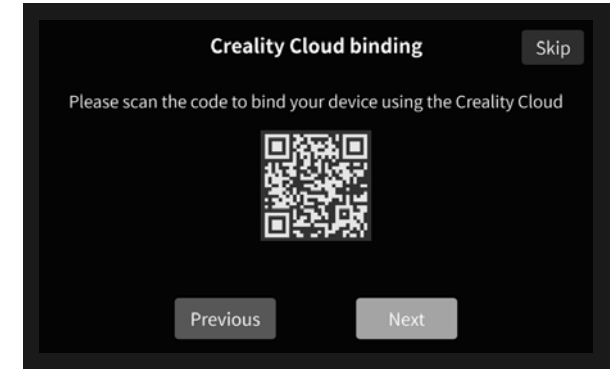

③ Creality Cloud binding

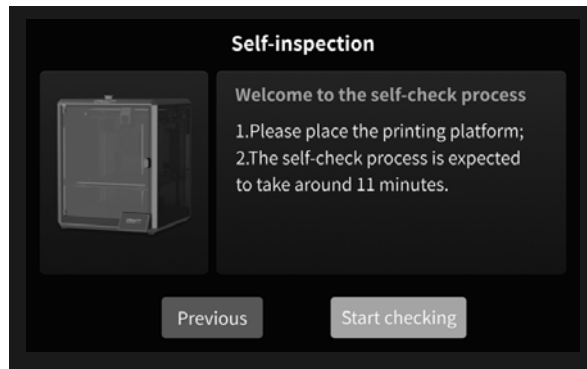

④ Self-inspection

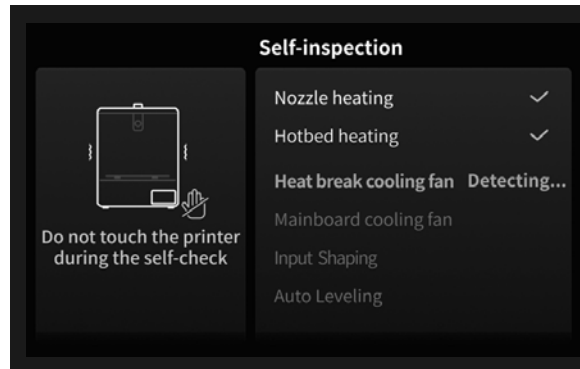

⑤ Self-testing

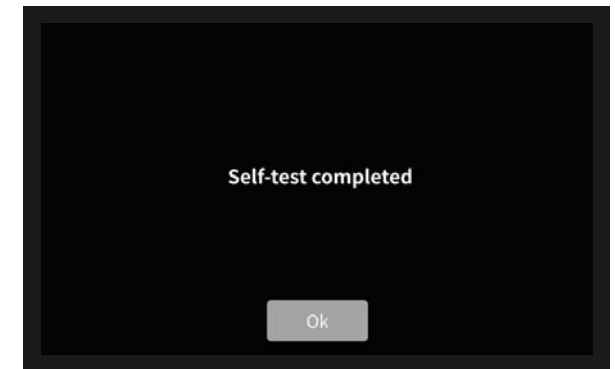

⑥ Self-test completed



Note: The current interface is for reference only. Due to the continuous upgrading of functions, it shall be subject to the latest firmware UI published on the official website.

# 3. About the User Interface

## 3.1 Tune、Prepare

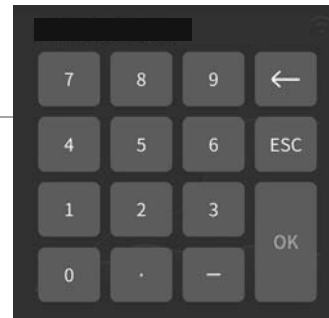
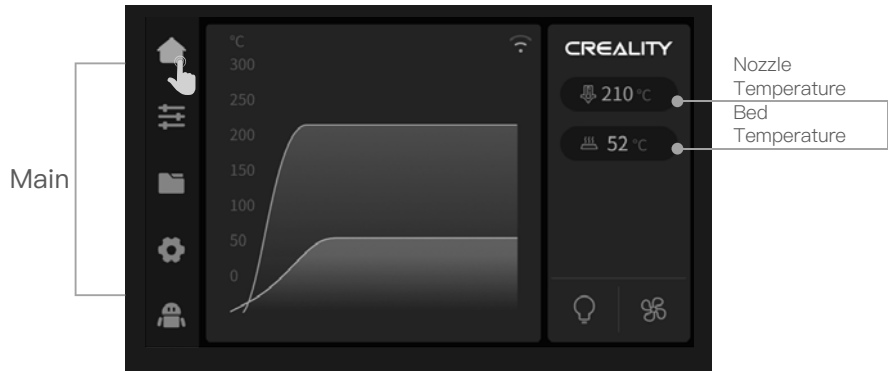

Parameters can be manually set

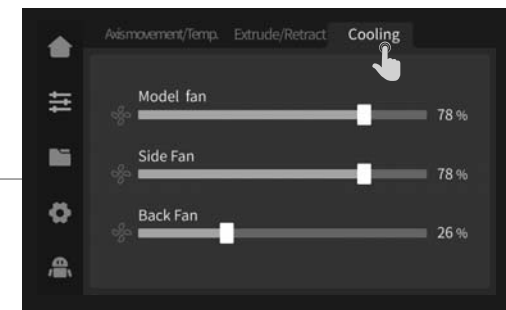
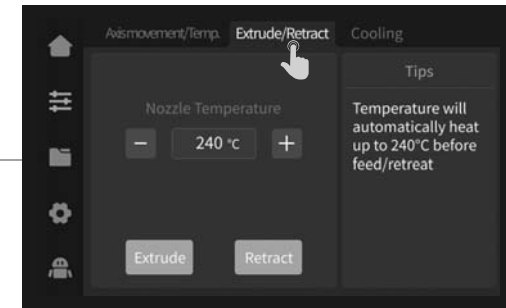

Note: The current interface is for reference only. Due to the continuous upgrading of functions, it shall be subject to the latest firmware UI published on the official website.

### 3. About the User Interface

#### 3.2 Files



① Local model



② Printing



③ Press and hold on the model to multi-select and copy it to a USB flash drive



④ USB flash drive model

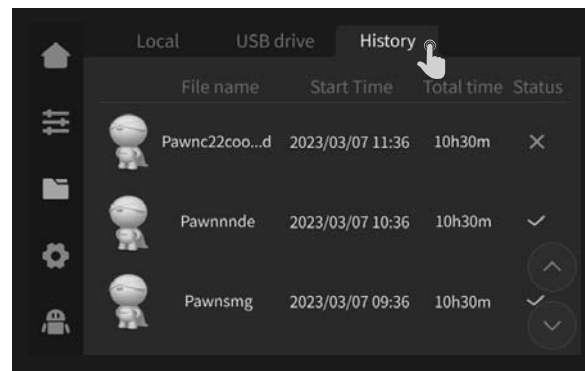

⑤ History

Note: The current interface is for reference only. Due to the continuous upgrading of functions, it shall be subject to the latest firmware UI published on the official website.

## 3. About the User Interface

### 3.3 Tune、Support

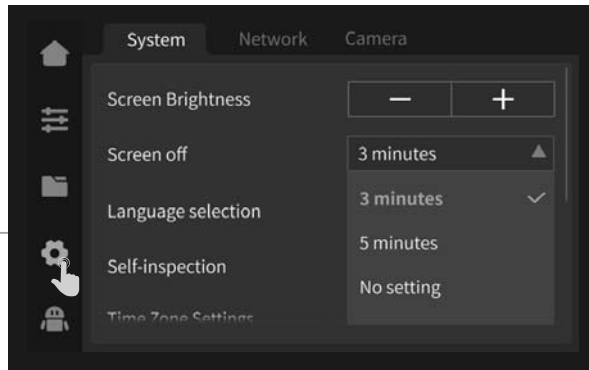

System

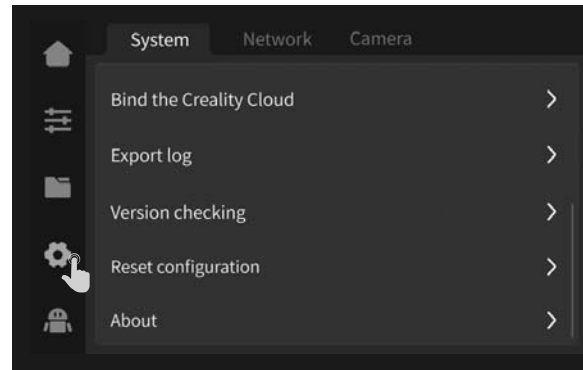

System

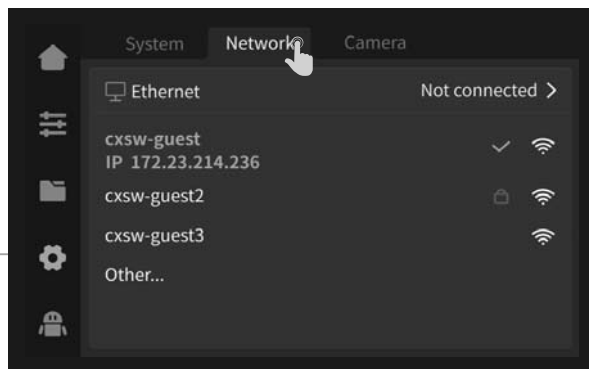

Network



Note: The current interface is for reference only. Due to the continuous upgrading of functions, it shall be subject to the latest firmware UI published on the official website.

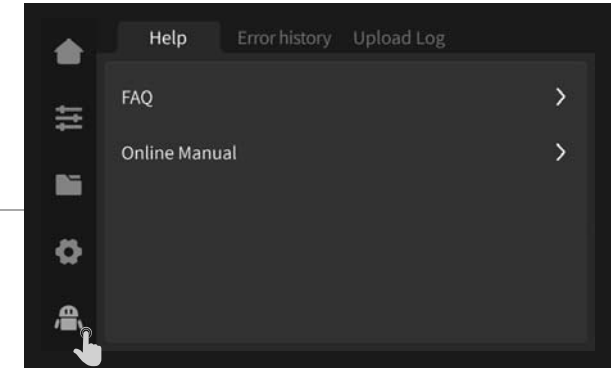

Help

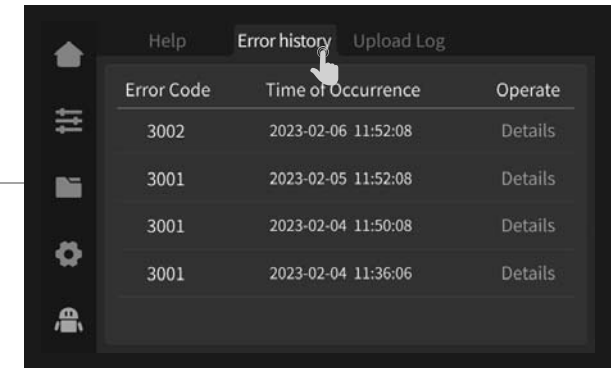

Error history

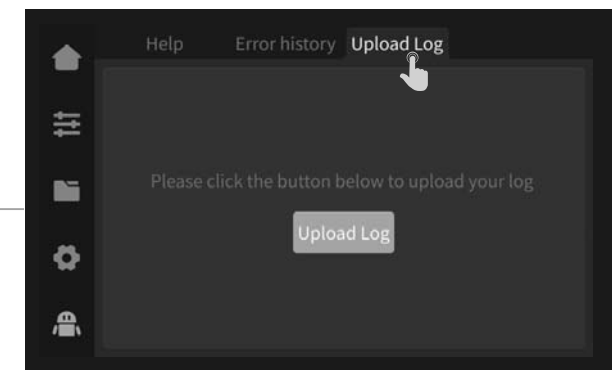

Upload Log

Tune

Support

## 4. First Printing

### 4.1 Local Printing



① Local model

② Select to print

③ Printing



Note: The current interface is for reference only. Due to the continuous upgrading of functions, it shall be subject to the latest firmware UI published on the official website.



Note: Keep the Extrusion switch off before printing.

## 4. First Printing

### 4.2 LAN Printing

#### Creativity Print



① Download at ([www.creativitycloud.com](http://www.creativitycloud.com)) or find the software on a USB flash drive and install it.



Tips: the computer must be in the same local area network as the printer

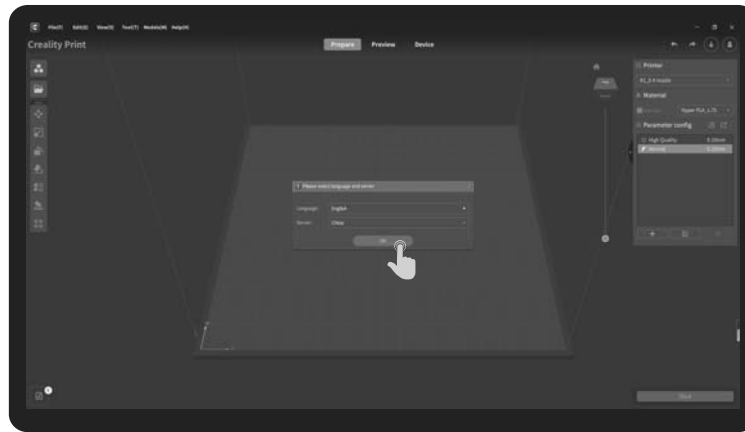

② Choose a language and region

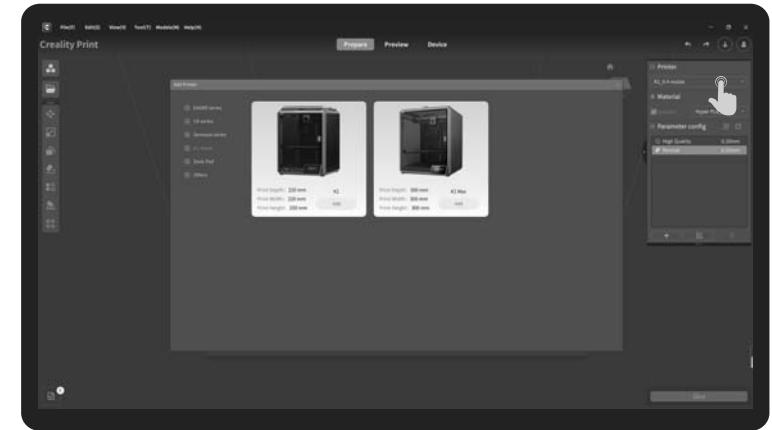

③ Choose a Printer

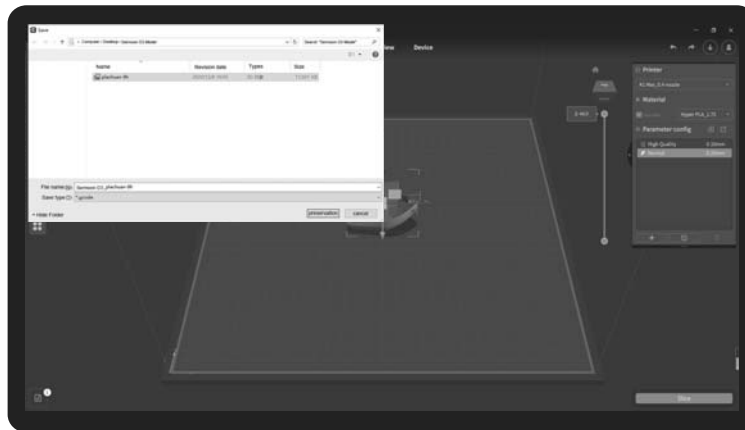

④ Click on "Import Model" and select the model file

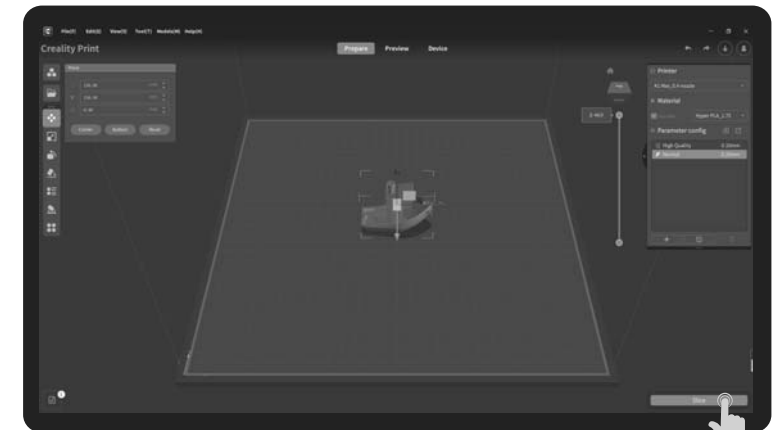

⑤ Open the model and click on "Start Slicing"



Note: The current interface is for reference only. Due to the continuous upgrading of functions, it shall be subject to the latest firmware UI published on the official website.

## 4. First Printing

### 4.2 LAN Printing

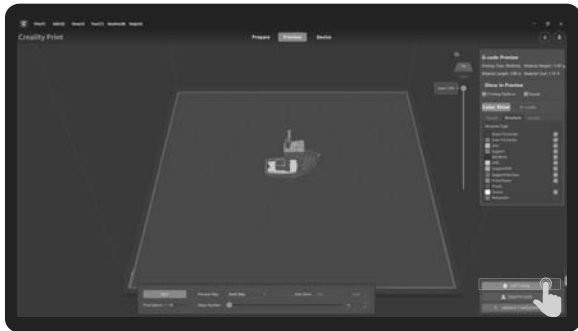

⑥ Selection of LAN printing

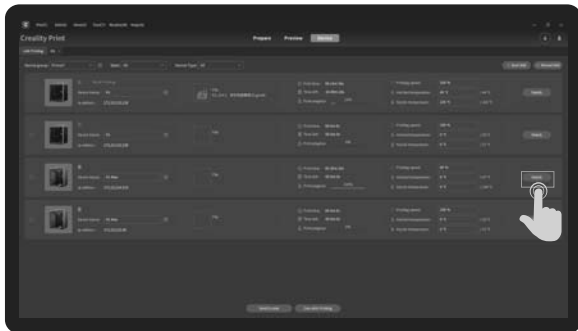

⑧ Device List

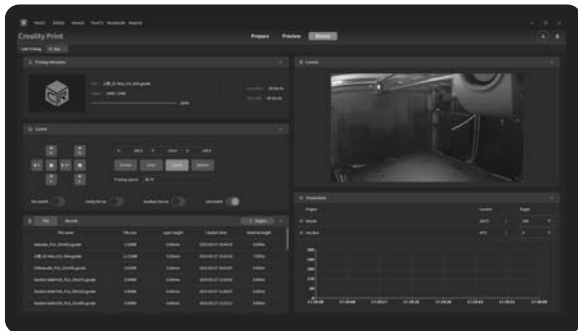

⑨ Device Details

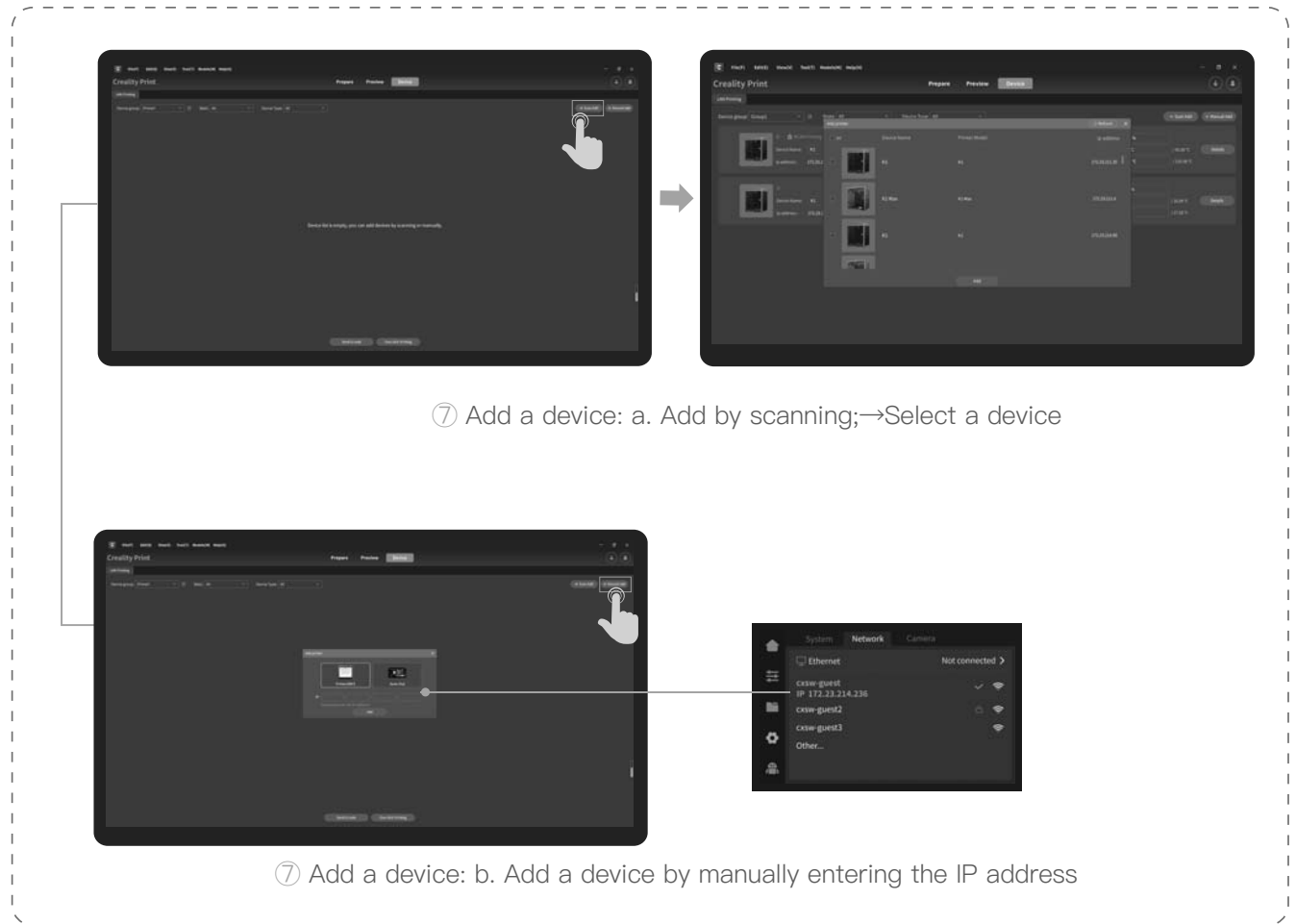

⑦ Add a device: a. Add by scanning; → Select a device

⑦ Add a device: b. Add a device by manually entering the IP address



## 4. First Printing

### 4.3 CrealityCloud printing



1. Scan the QR code and download the app

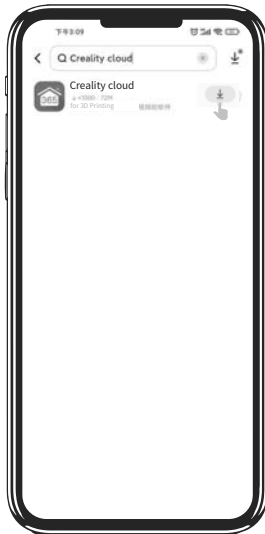

2. Download

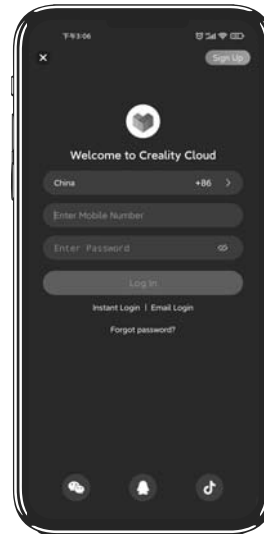

3. Sign up for an account

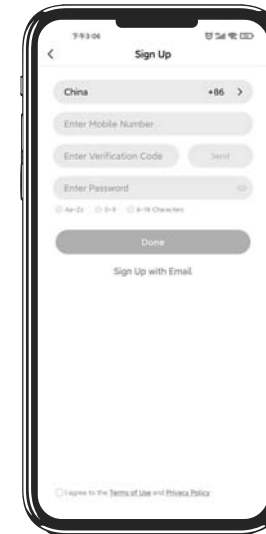

4. Log in

## 4. First Printing

### 4.3 CrealityCloud printing



5. Add a new device



6. Add a device

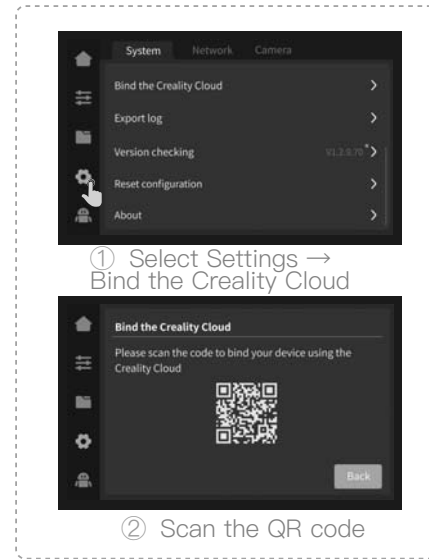

7. Select model on the homepage

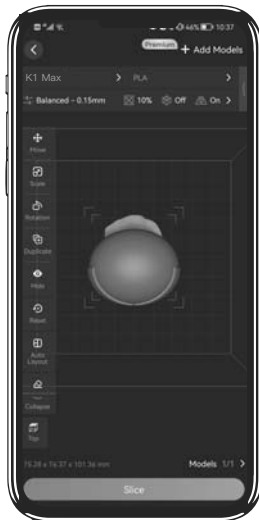

8. Slicing



9. Print



10. Select a device

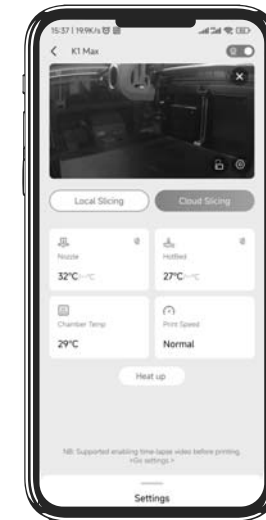

11. Printing

## 5. Functional Specification

### 5.1 Extrude、Filament Retreat

Extrude

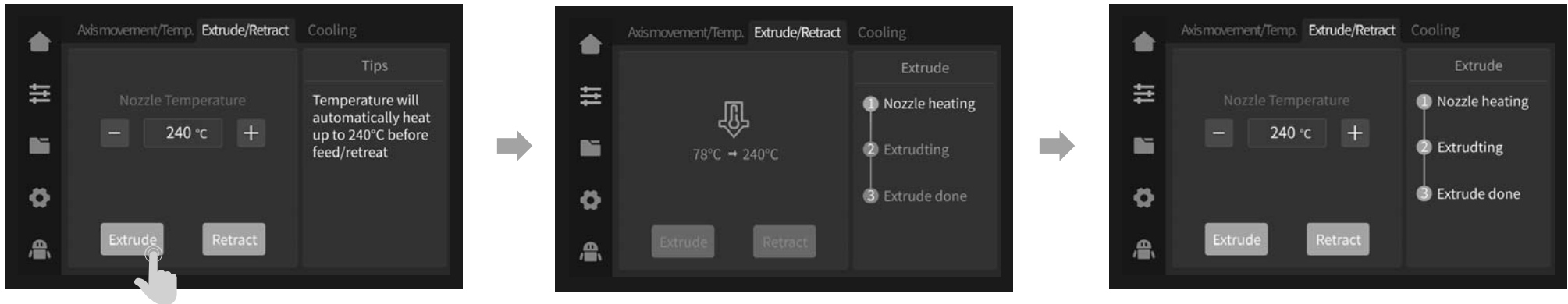

Filament Retreat

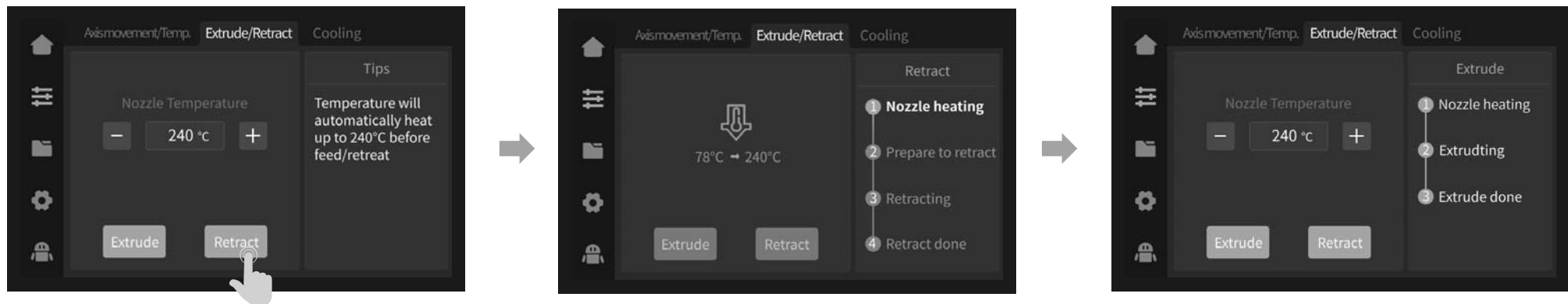

Note: The current interface is for reference only. Due to the continuous upgrading of functions, it shall be subject to the latest firmware UI published on the official website.

## 5. Functional Specification

### 5.2 Calibration

Select calibration, the machine will be leveled before printing the model and use AI LiDAR for first-layer detection.



First-layer detection of printing:

Use AI Lidar and first-layer detection algorithm to check the first layer of the model to be printed, and report any first-layer quality problem found to the system, so as to prevent printing failure due to first-layer printing problems and to avoid wasting a lot of time and materials.

AI LiDAR :

- ① It's composed of laser and sensor. The laser is used to detect the surface of the measured object;
- ② The sensor is used to record the changes and generate point cloud data for the control system to call and process;
- ③ It's available to be applied to first-layer detection of printing.

## 5. Functional Specification

### 5.3 AI function

- ① When AI detection is turned on, the chamber camera will monitor the process of printing. If any defect is found during the printing, a window will pop up to remind you.
- ② When you check the Push Pause Printing, the printing will pause if there is any printing defect.

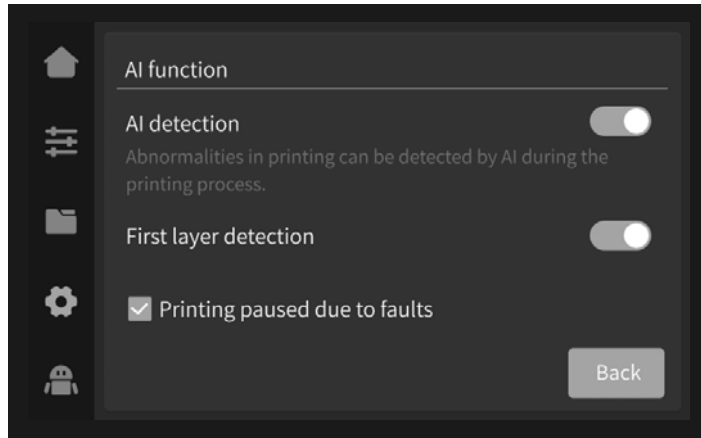

After printing starts, if there are foreign objects on the platform or the previous printed model is not removed, the printer will pause printing and give a reminder. (To avoiding damaging the extruder)  
After turning off the first-layer detection, the first-layer detection will not be performed during the calibration.

**Note:** Push pause printing if Any Fault is effective for both the AI detection and first-layer detection.

### 5.4 Self-inspection

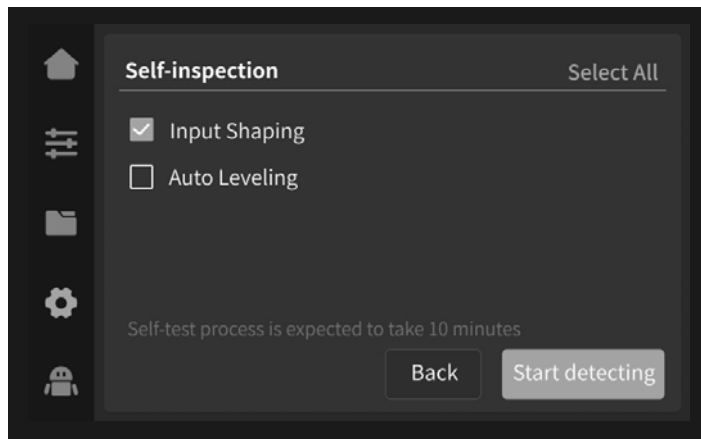

#### Input Shaping:

Ringing refer to the corrugated unevenness on the surface of the model that may be caused by the resonance of the machine or the action of external forces during the printing process.

To solve this problem, the input shaping sensor is used to actively obtain the resonance frequency of the 3D printer, and algorithm is applied to correct this state to achieve the purpose of eliminating the model chatter marks. Using the input shaping can effectively suppress the machine vibration and improve the printing quality of the model to obtain a smooth model surface.

## 5. Functional Specification

### 5.5 Network Settings

#### 5.5.1 Wired connection

When the printer is connected to the network cable, you can click Settings → Local Network on the screen to check whether it is connected.

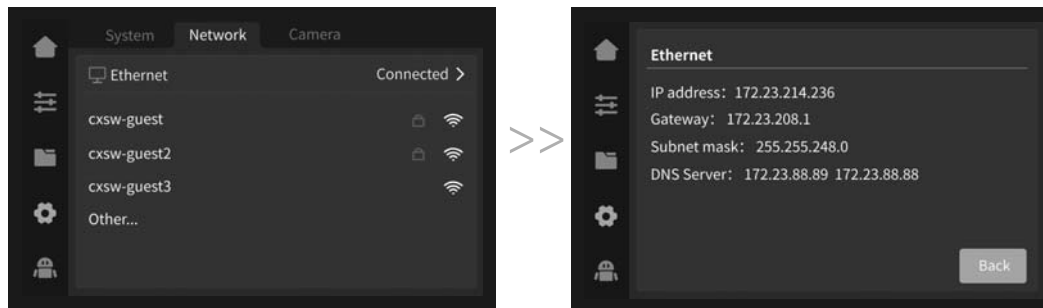

#### 5.5.2 WIFI connection

Click Settings → Network → WIFI Connection on the screen, select the corresponding WIFI and enter the password to finish the WIFI connection. (only support 2.4 GHz).

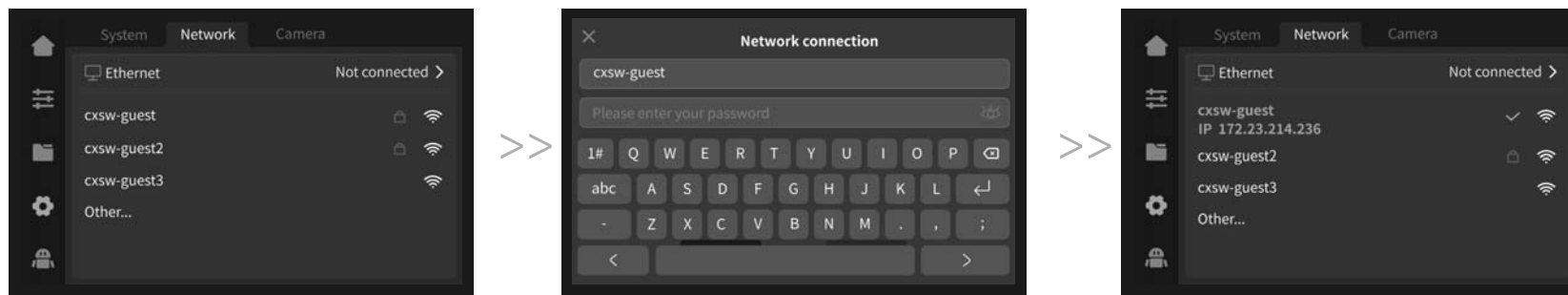

## 6. Tips and Routine Maintenance

### 6.1 Precautions for printing

#### 6.1.1 Lubrication and maintenance

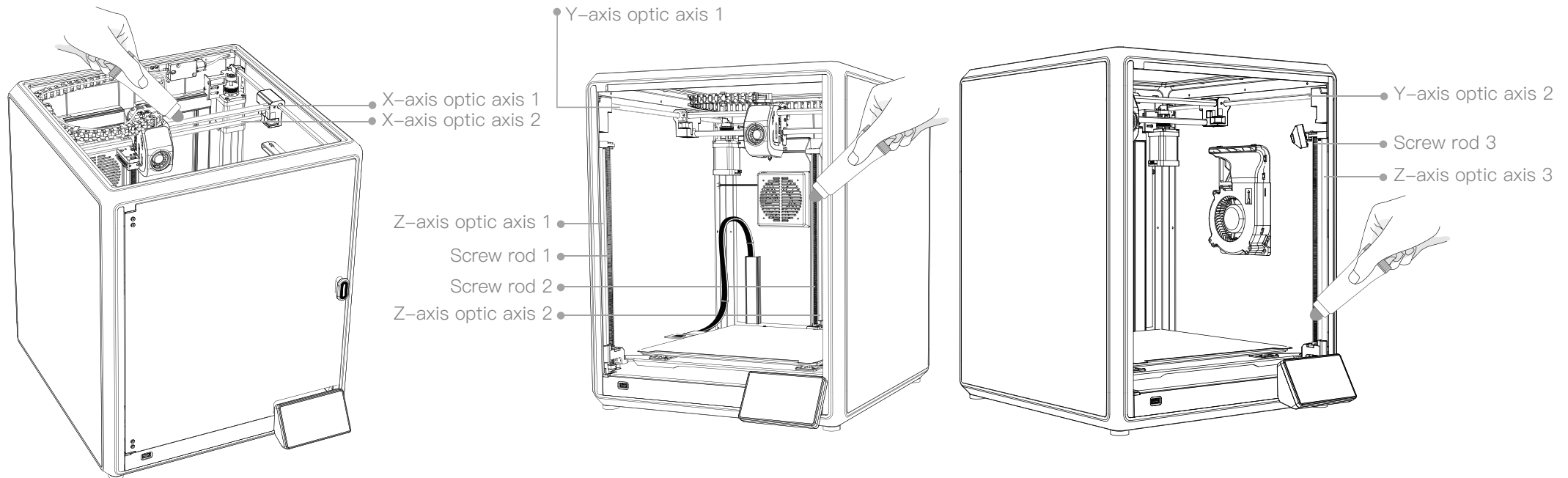

Regular maintenance for 300 hours: Please maintain the blue areas in Figure by greasing and lubricating them at regular intervals. Grease should only be applied to the middle part by dispensing and then applied automatically and evenly by movement. (Users may buy the grease themselves for machine maintenance.)