

# TEST REPORT

Report No.: BCTC2304887872E

---

Applicant: Shenzhen Creality 3D Technology Co., Ltd.

---

Product Name: 3D Printer

---

Model/Type  
reference: K1 Max

---

Tested Date: 2023-04-19 to 2023-04-23

---

Issued Date: 2023-05-29

---

**Shenzhen BCTC Testing Co., Ltd.**



# FCC ID: 2AXH6-K1MAX

Product Name: 3D Printer  
Trademark: **CREALITY**  
Model/Type reference: K1 Max  
Prepared For: Shenzhen Creality 3D Technology Co.,Ltd.  
Address: 18F, JinXiuHongDu Building, Meilong Blvd., Longhua Dist., Shenzhen, China 518131  
Manufacturer: Shenzhen Creality 3D Technology Co.,Ltd.  
Address: 18F, JinXiuHongDu Building, Meilong Blvd., Longhua Dist., Shenzhen, China 518131  
Prepared By: Shenzhen BCTC Testing Co., Ltd.  
Address: 1-2/F., Building B, Pengzhou Industrial Park, No.158, Fuyuan 1st Road, Zhancheng, Fuhai Subdistrict, Bao'an District, Shenzhen, Guangdong, China  
Sample Received Date: 2023-04-19  
Sample tested Date: 2023-04-19 to 2023-04-23  
Report No.: BCTC2304887872E  
Test Standards: FCC Part15.247  
ANSI C63.10-2013  
Test Results: PASS  
Remark: This is WIFI-2.4GHz band radio test report.

Tested by:

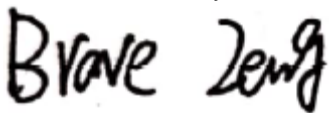

Brave Zeng/ Project Handler

Approved by:



Zero Zhou/Reviewer

The test report is effective only with both signature and specialized stamp. This result(s) shown in this report refer only to the sample(s) tested. Without written approval of Shenzhen BCTC Testing Co., Ltd, this report can't be reproduced except in full. The tested sample(s) and the sample information are provided by the client.

## Table of Content

Test Report Declaration	Page
1. Version .....	5
2. Test Summary .....	6
3. Measurement Uncertainty .....	7
4. Product Information and Test Setup.....	8
4.2 Test Setup Configuration .....	9
4.3 Support Equipment .....	9
4.4 Channel List .....	10
4.5 Test Mode .....	10
4.6 Table Of Parameters Of Text Software Setting.....	11
5. Test Facility And Test Instrument Used.....	12
5.1 Test Facility.....	12
5.2 Test Instrument Used.....	12
6. Conducted Emissions.....	14
6.1 Block Diagram Of Test Setup.....	14
6.2 Limit .....	14
6.3 Test procedure.....	14
6.4 EUT operating Conditions .....	14
6.5 Test Result.....	15
7. Radiated Emissions.....	17
7.1 Block Diagram Of Test Setup.....	17
7.2 Limit .....	18
7.3 Test procedure.....	19
7.4 EUT Operating Conditions .....	20
7.5 Test Result.....	20
8. Radiated Band Emission Measurement and Restricted Bands Of Operation.....	26
8.1 Block Diagram Of Test Setup.....	26
8.2 Limit .....	26
8.3 Test procedure.....	27
8.4 EUT Operating Conditions .....	27
8.5 Test Result.....	28
9. Power Spectral Density Test .....	30
9.1 Block Diagram Of Test Setup.....	30
9.2 Limit .....	30
9.3 Test procedure.....	30
9.4 EUT Operating Conditions .....	30
9.5 Test Result.....	31
10. Bandwidth Test.....	37
10.1 Block Diagram Of Test Setup.....	37
10.2 Limit .....	37
10.3 Test procedure.....	37
10.4 EUT Operating Conditions .....	37
10.5 Test Result.....	38
11. Peak Output Power Test .....	44
11.1 Block Diagram Of Test Setup.....	44

11.2	Limit .....	44
11.3	Test Procedure .....	44
11.4	EUT Operating Conditions .....	44
11.5	Test Result.....	45
12.	100 kHz Bandwidth Of Frequency Band Edge .....	46
12.1	Block Diagram Of Test Setup.....	46
12.2	Limit .....	46
12.3	Test Procedure .....	46
12.4	EUT Operating Conditions .....	46
12.5	Test Result.....	47
13.	Duty Cycle Of Test Signal .....	62
13.1	Standard Requirement.....	62
13.2	Formula.....	62
13.3	Test Procedure .....	62
13.4	Test Result.....	62
14.	Antenna Requirement .....	63
14.1	Limit .....	63
14.1	Test Result.....	63
15.	EUT Test Setup Photographs.....	64

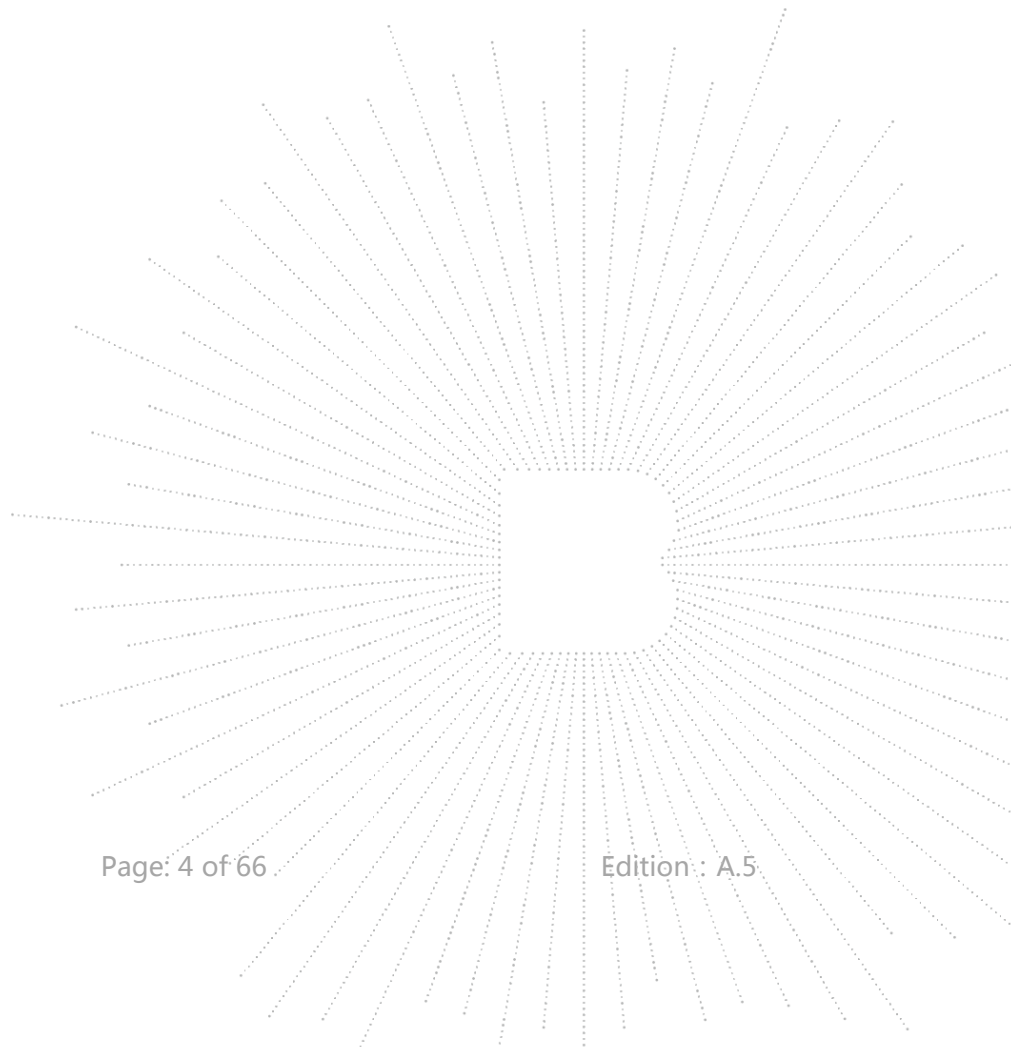

**1. Version**

Report No.	Issue Date	Description	Approved
BCTC2304887872E	2023-05-29	Original	Valid

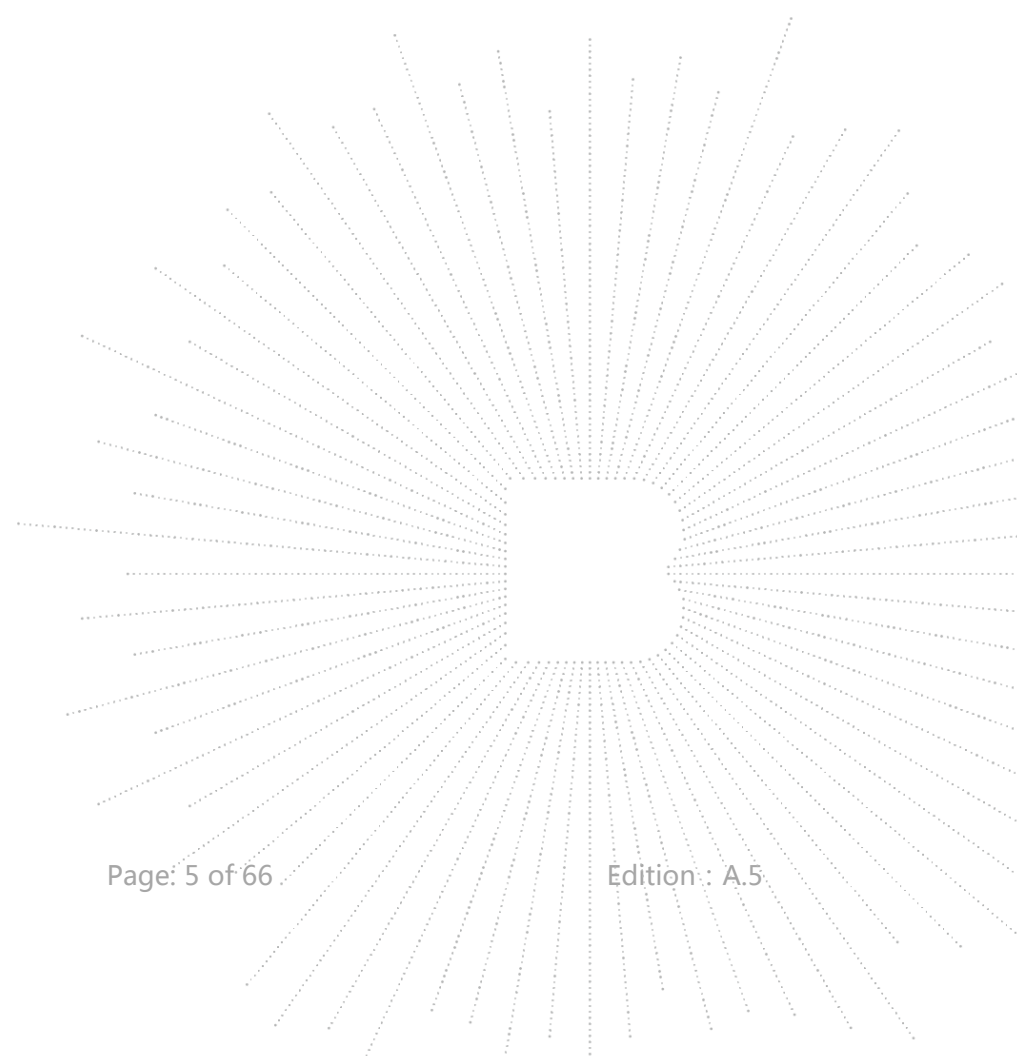

## 2. Test Summary

The Product has been tested according to the following specifications:

No.	Test Parameter	Clause No.	Results
1	Conducted Emission	15.207	PASS
2	6dB Bandwidth	15.247 (a)(2)	PASS
3	Peak Output Power	15.247 (b)	PASS
4	Radiated Spurious Emission	15.247 (d)	PASS
5	Power Spectral Density	15.247 (e)	PASS
6	Restricted Band of Operation	15.205	PASS
7	Band Edge (Out of Band Emissions)	15.247 (d)	PASS
8	Antenna Requirement	15.203	PASS

### 3. Measurement Uncertainty

Where relevant, the following measurement uncertainty levels have been estimated for tests performed on the Product as specified in CISPR 16-4-2. This uncertainty represents an expanded uncertainty expressed at approximately the 95% confidence level using a coverage factor of k=2.

No.	Item	Uncertainty
1	3m chamber Radiated spurious emission(30MHz-1GHz)	U=4.3dB
2	3m chamber Radiated spurious emission(9KHz-30MHz)	U=3.7dB
3	3m chamber Radiated spurious emission(1GHz-18GHz)	U=4.5dB
4	3m chamber Radiated spurious emission(18GHz-40GHz)	U=3.34dB
5	Conducted Emission (150kHz-30MHz)	U=3.20dB
6	Conducted Adjacent channel power	U=1.38dB
7	Conducted output power uncertainty Above 1G	U=1.576dB
8	Conducted output power uncertainty below 1G	U=1.28dB
9	humidity uncertainty	U=5.3%
10	Temperature uncertainty	U=0.59°C

## 4. Product Information and Test Setup

### 4.1 Product Information

Model/Type Ref.	K1 Max
Model differences:	N/A
Hardware Version:	N/A
Software Version:	N/A
IEEE 802.11 WLAN Mode Supported	802.11b 802.11g 802.11n(20MHz channel bandwidth)
Operation Frequency:	802.11b/g/n 20MHz:2412~2462MHz
Type of Modulation:	DSSS with DBPSK/DQPSK/CCK for 802.11b; OFDM with BPSK/QPSK/16QAM/64QAM for 802.11g/n;
Number Of Channel:	11 channels for 802.11b/g n(HT20);
Transmit Power Max	19.97dBm
Antenna installation:	Internal antenna
Antenna Gain:	2.24 dBi
Power supply:	AC 120V/60Hz
Ratings:	Input: AC 100-240V · 50/60Hz



## 4.2 Test Setup Configuration

See test photographs attached in *EUT TEST SETUP PHOTOGRAPHS* for the actual connections between Product and support equipment.

Conducted Emission:

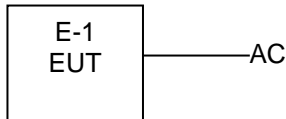

Radiated Spurious Emission

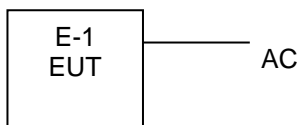

## 4.3 Support Equipment

No.	Device Type	Brand	Model	Series No.	Note
E-1	3D Printer	N/A	K1 Max	N/A	EUT

Item	Shielded Type	Ferrite Core	Length	Note
N/A	N/A	N/A	N/A	N/A

Notes:

1. All the equipment/cables were placed in the worst-case configuration to maximize the emission during the test.
2. Grounding was established in accordance with the manufacturer's requirements and conditions for the intended use.

#### 4.4 Channel List

Channel List for 802.11b/g/n(20)					
Channel	Frequency (MHz)	Channel	Frequency (MHz)	Channel	Frequency (MHz)
01	2412	02	2417	03	2422
04	2427	05	2432	06	2437
07	2442	08	2447	09	2452
10	2457	11	2462		

#### 4.5 Test Mode

To investigate the maximum EMI emission characteristics generates from EUT, the test system was pre-scanning tested base on the consideration of following EUT operation mode or test configuration mode which possible have effect on EMI emission level. Each of these EUT operation mode(s) or test configuration mode(s) mentioned above was evaluated respectively.

For All Mode	Description	Modulation Type
Mode 1	CH 01	802.11b
Mode 2	CH 06	
Mode 3	CH 11	
Mode 4	CH 01	802.11g
Mode 5	CH 06	
Mode 6	CH 11	
Mode 7	CH 01	802.11n
Mode 8	CH 06	
Mode 9	CH 11	
Mode 10	Link mode (Conducted emission and Radiated emission)	

##### Notes:

1. The measurements are performed at the highest, middle, lowest available channels.
2. The measurements are performed at all Bit Rate of Transmitter, the worst data was reported
3. According to ANSI C63.10 standards, the test results are both the "worst case" and "worst setup" 11Mbps for 802.11b,6Mbps for 802.11g,13Mbps for 802.11/n 20,

#### 4.6 Table Of Parameters Of Text Software Setting

During testing channel & power controlling software provided by the customer was used to control the operating channel as well as the output power level. The RF output power selection is for the setting of RF output power expected by the customer and is going to be fixed on the firmware of the final end product power parameters

<b>Test software Version</b>	<b>CMD</b>		
Frequency	2412 MHz	2437 MHz	2462 MHz
Parameters	DEF	DEF	DEF

## 5. Test Facility And Test Instrument Used

### 5.1 Test Facility

All measurement facilities used to collect the measurement data are located at Shenzhen BCTC Testing Co., Ltd. Address: 1-2/F., Building B, Pengzhou Industrial Park, No.158, Fuyuan 1st Road, Zhancheng, Fuhai Subdistrict, Bao'an District, Shenzhen, Guangdong, China The site and apparatus are constructed in conformance with the requirements of ANSI C63.4 and CISPR 16-1-1 other equivalent standards.

FCC Test Firm Registration Number: 712850

IC Registered No.: 23583

### 5.2 Test Instrument Used

Conducted Emissions Test					
Equipment	Manufacturer	Model#	Serial#	Last Cal.	Next Cal.
Receiver	R&S	ESR3	102075	May 24, 2022	May 23, 2023
LISN	R&S	ENV216	101375	May 24, 2022	May 23, 2023
Software	Frad	EZ-EMC	EMC-CON 3A1	\	\
Attenuator	\	10dB DC-6GHz	1650	May 24, 2022	May 23, 2023

RF Conducted Test					
Equipment	Manufacturer	Model#	Serial#	Last Cal.	Next Cal.
Power Metter	Keysight	E4419	\	May 24, 2022	May 23, 2023
Power Sensor (AV)	Keysight	E9300A	\	May 24, 2022	May 23, 2023
Signal Analyzer20kHz z-26.5GHz	Keysight	N9020A	MY49100060	May 24, 2022	May 23, 2023
Spectrum Analyzer9kHz- 40GHz	R&S	FSP40	\	May 24, 2022	May 23, 2023

Radiated Emissions Test (966 Chamber)					
Equipment	Manufacturer	Model#	Serial#	Last Cal.	Next Cal.
966 chamber	ChengYu	966 Room	966	Jun. 06. 2020	Jun. 05, 2023
Receiver	R&S	ESR3	102075	May 24, 2022	May 23, 2023
Receiver	R&S	ESRP	101154	May 24, 2022	May 23, 2023
Amplifier	SKET	LAPA_01G18 G-45dB	\	May 24, 2022	May 23, 2023
Amplifier	Schwarzbeck	BBV9744	9744-0037	May 24, 2022	May 23, 2023
TRILOG Broadband Antenna	Schwarzbeck	VULB9163	942	May 26, 2022	May 25, 2023
Horn Antenna	Schwarzbeck	BBHA9120D	1541	May 24, 2022	May 23, 2023
Horn Antenn(18GH z-40GHz)	Schwarzbeck	BBHA9170	00822	May 24, 2022	May 23, 2023
Amplifier(18G Hz-40GHz)	MITEQ	TTA1840-35- HG	2034381	May 24, 2022	May 23, 2023
Loop Antenna(9KHz -30MHz)	Schwarzbeck	FMZB1519B	00014	May 26, 2022	May 25, 2023
RF cables1(9kHz- 30MHz)	Huber+Suhnar	9kHz-30MHz	B1702988-000 8	May 26, 2022	May 25, 2023
RF cables2(30MH z-1GHz)	Huber+Suhnar	30MHz-1GHz	1486150	May 26, 2022	May 25, 2023
RF cables3(1GHz -40GHz)	Huber+Suhnar	1GHz-40GHz	1607106	May 24, 2022	May 23, 2023
Power Metter	Keysight	E4419	\	May 26, 2022	May 25, 2023
Power Sensor (AV)	Keysight	E9300A	\	May 26, 2022	May 25, 2023
Signal Analyzer20kH z-26.5GHz	Keysight	N9020A	MY49100060	May 26, 2022	May 25, 2023
Spectrum Analyzer9kHz- 40GHz	R&S	FSP40	\	May 26, 2022	May 25, 2023
Software	Frad	EZ-EMC	FA-03A2 RE	\	\

## 6. Conducted Emissions

### 6.1 Block Diagram Of Test Setup

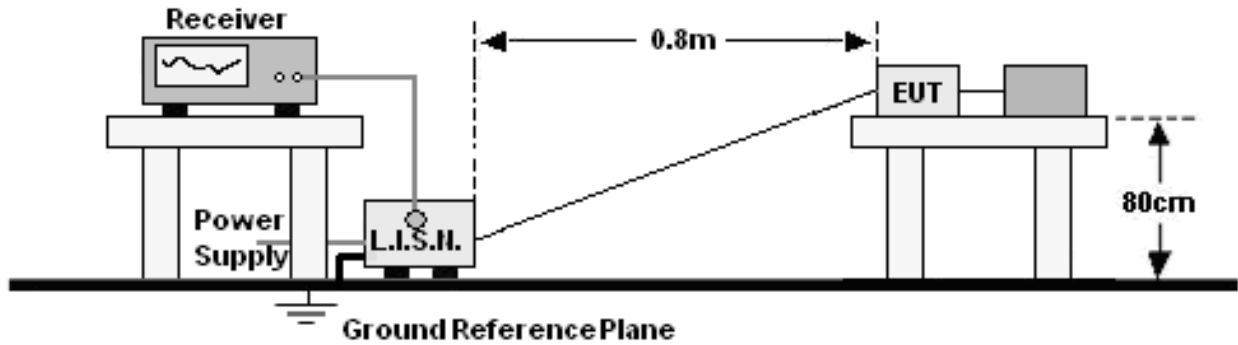

### 6.2 Limit

Frequency (MHz)	Limit (dBuV)	
	Quas-peak	Average
0.15 -0.5	66 - 56 *	56 - 46 *
0.50 -5.0	56.00	46.00
5.0 -30.0	60.00	50.00

Notes:

- \*Decreasing linearly with logarithm of frequency.
- The lower limit shall apply at the transition frequencies.

### 6.3 Test procedure

Receiver Parameters	Setting
Attenuation	10 dB
Start Frequency	0.15 MHz
Stop Frequency	30 MHz
IF Bandwidth	9 kHz

- The Product was placed on a nonconductive table 0.8 m above the horizontal ground reference plane, and 0.4 m from the vertical ground reference plane, and connected to the main through Line Impedance Stability Network (L.I.S.N).
- The RBW of the receiver was set at 9 kHz in 150 kHz ~ 30MHz with Peak and AVG detector in Max Hold mode. Run the receiver's pre-scan to record the maximum disturbance generated from Product in all power lines in the full band.
- For each frequency whose maximum record was higher or close to limit, measure its QP and AVG values and record.

### 6.4 EUT operating Conditions

The EUT was configured for testing in a typical fashion (as a customer would normally use it). The EUT has been programmed to continuously transmit during test. This operating condition was tested and used to collect the included data.

### 6.5 Test Result

Temperature:	26 °C	Relative Humidity:	54%
Pressure:	101KPa	Test Voltage :	AC120V/60Hz
Test Mode:	Mode 10	Polarization :	L

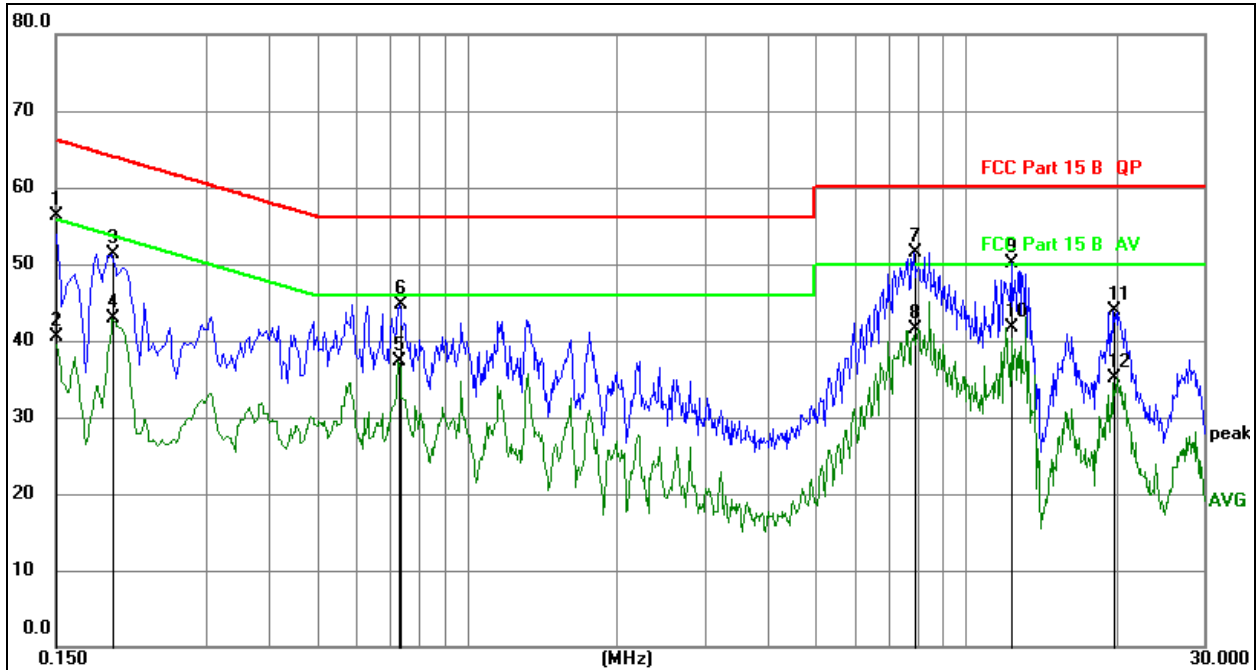

**Remark:**

1. All readings are Quasi-Peak and Average values.
2. Factor = Insertion Loss + Cable Loss.
3. Measurement = Reading Level + Correct Factor
4. Over = Measurement - Limit

No. Mk.	Freq. MHz	Reading Level	Correct Factor	Measurement	Limit	Over	Detector	Comment
			dB	dBuV	dBuV	dB		
1	0.1500	45.98	10.23	56.21	66.00	-9.79	QP	
2	0.1500	30.28	10.23	40.51	56.00	-15.49	AVG	
3	0.1949	41.02	10.24	51.26	63.83	-12.57	QP	
4	0.1949	32.63	10.24	42.87	53.83	-10.96	AVG	
5	0.7304	27.18	10.14	37.32	46.00	-8.68	AVG	
6	0.7350	34.58	10.14	44.72	56.00	-11.28	QP	
7	7.8675	41.12	10.38	51.50	60.00	-8.50	QP	
8	7.8675	31.19	10.38	41.57	50.00	-8.43	AVG	
9	12.3720	39.75	10.40	50.15	60.00	-9.85	QP	
10 *	12.3720	31.26	10.40	41.66	50.00	-8.34	AVG	
11	19.8375	33.33	10.54	43.87	60.00	-16.13	QP	
12	19.8375	24.51	10.54	35.05	50.00	-14.95	AVG	

Temperature:	26 °C	Relative Humidity:	54%
Pressure:	101KPa	Test Voltage :	AC120V/60Hz
Test Mode:	Mode 10	Polarization :	N

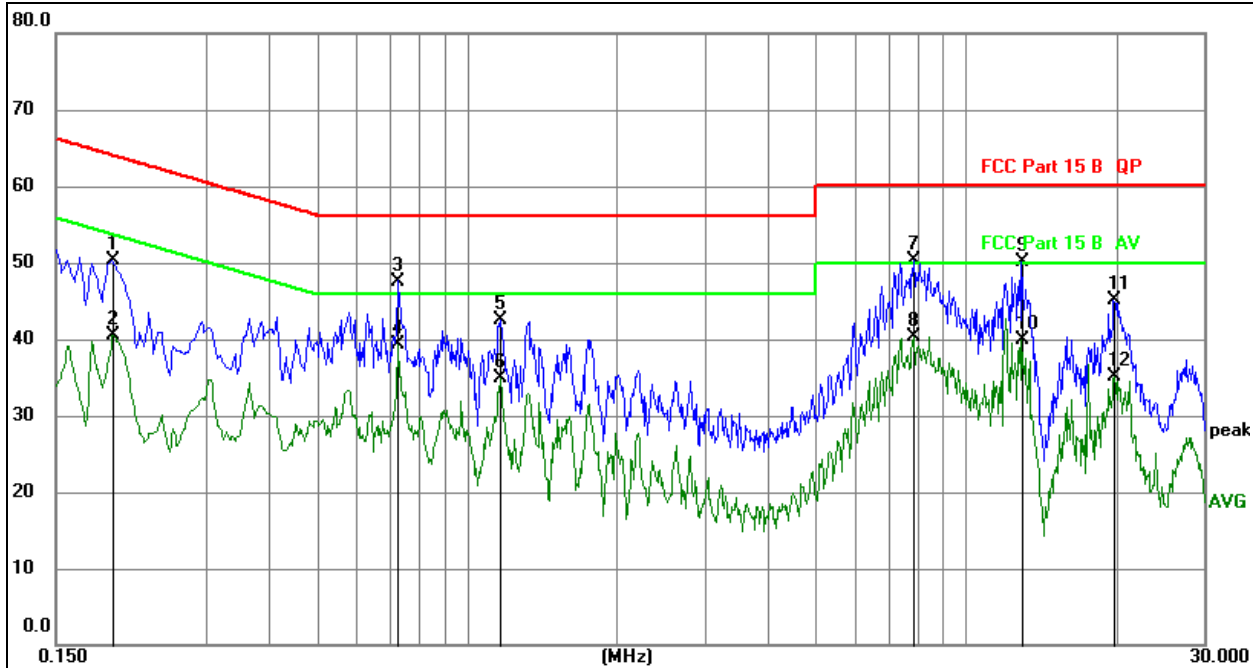
**Remark:**

1. All readings are Quasi-Peak and Average values.
2. Factor = Insertion Loss + Cable Loss.
3. Measurement = Reading Level + Correct Factor
4. Over = Measurement - Limit

No.	Mk.	Freq.	Reading Level	Correct Factor	Measurement	Limit	Over	Detector	Comment
		MHz		dB	dBuV	dBuV	dB		
1		0.1945	40.12	10.24	50.36	63.84	-13.48	QP	
2		0.1945	30.25	10.24	40.49	53.84	-13.35	AVG	
3		0.7273	37.46	10.14	47.60	56.00	-8.40	QP	
4	*	0.7273	29.10	10.14	39.24	46.00	-6.76	AVG	
5		1.1657	32.36	10.16	42.52	56.00	-13.48	QP	
6		1.1657	24.68	10.16	34.84	46.00	-11.16	AVG	
7		7.8516	39.91	10.38	50.29	60.00	-9.71	QP	
8		7.8516	29.90	10.38	40.28	50.00	-9.72	AVG	
9		12.9199	39.63	10.41	50.04	60.00	-9.96	QP	
10		12.9199	29.41	10.41	39.82	50.00	-10.18	AVG	
11		19.7397	34.60	10.53	45.13	60.00	-14.87	QP	
12		19.7397	24.60	10.53	35.13	50.00	-14.87	AVG	



## 7. Radiated Emissions

### 7.1 Block Diagram Of Test Setup

(A) Radiated Emission Test-Up Frequency Below 30MHz

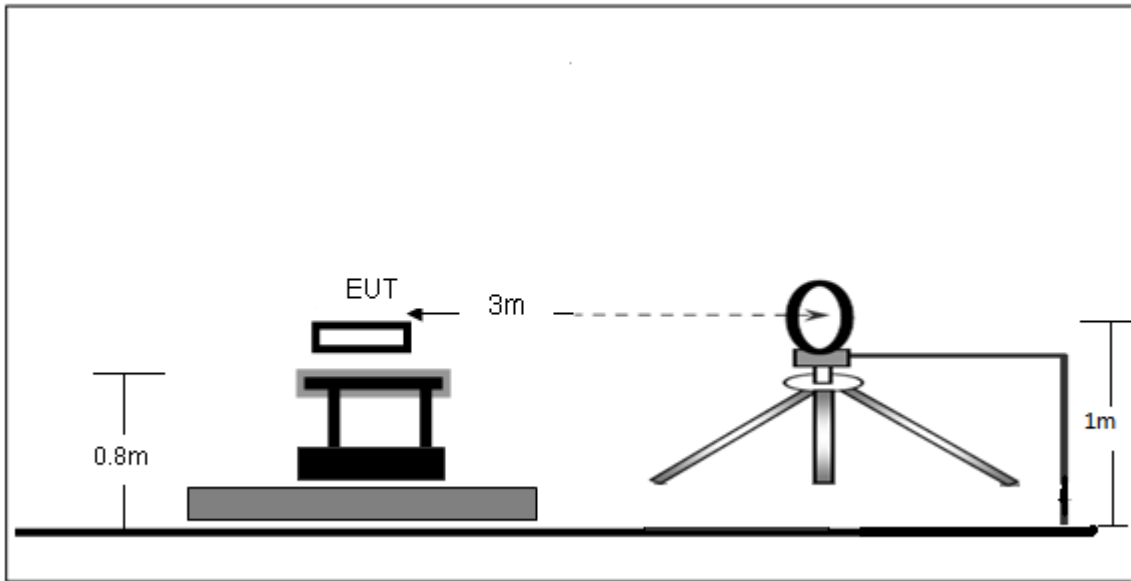

(B) Radiated Emission Test-Up Frequency 30MHz~1GHz

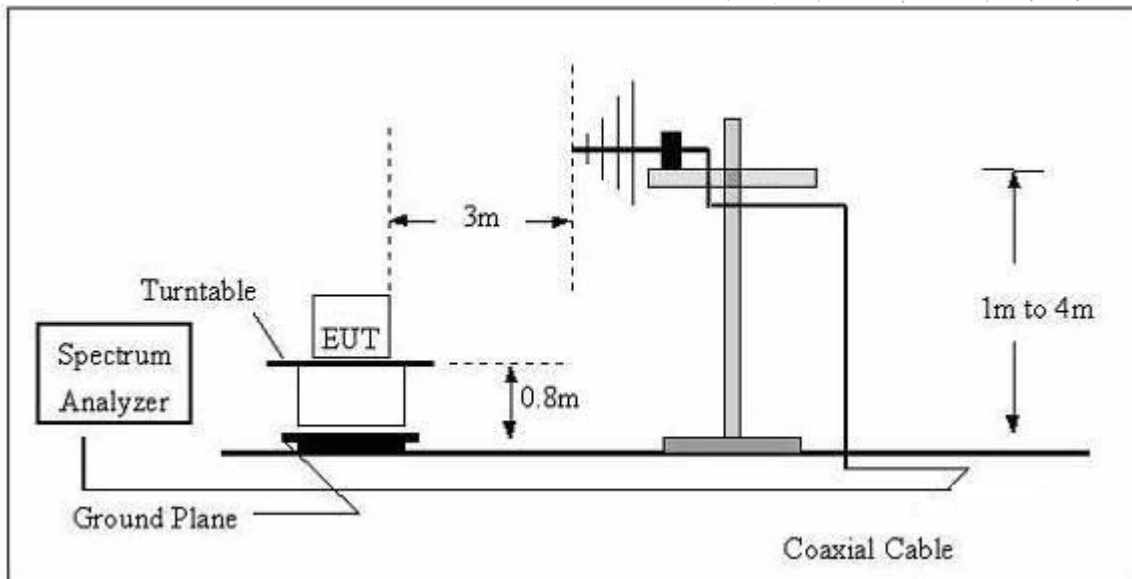

## (C) Radiated Emission Test-Up Frequency Above 1GHz

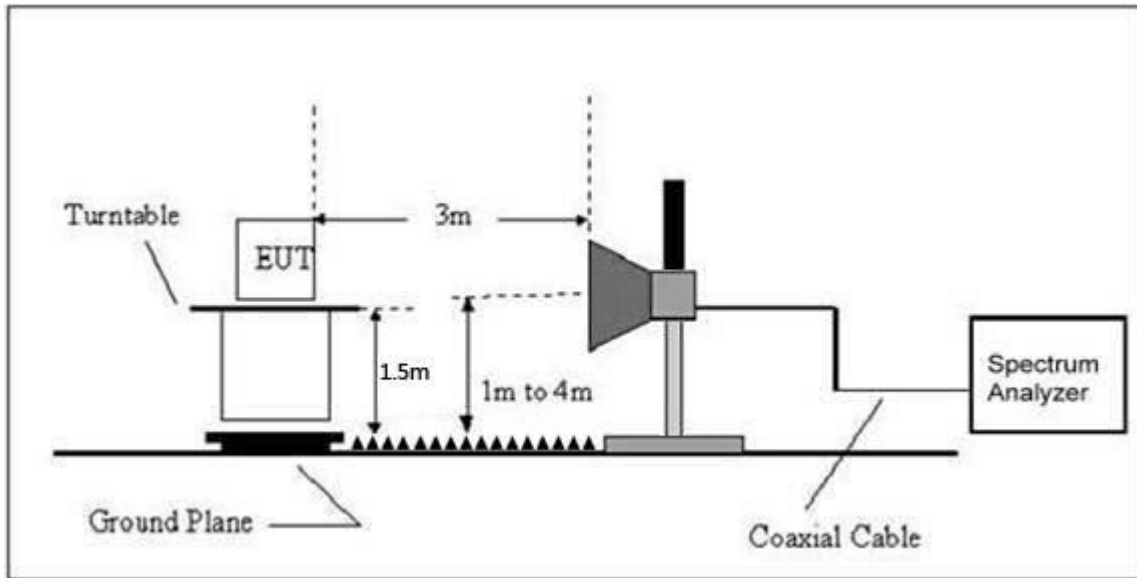

## 7.2 Limit

20dBc in any 100 kHz bandwidth outside the operating frequency band. In case the emission fall within the restricted band specified on 15.205(a), then the 15.209(a) limit in the table below has to be followed.

Frequency (MHz)	Field Strength uV/m	Distance (m)	Field Strength Limit at 3m Distance	
			uV/m	dBuV/m
0.009 ~ 0.490	2400/F(kHz)	300	10000 * 2400/F(kHz)	$20\log^{(2400/F(kHz))} + 80$
0.490 ~ 1.705	24000/F(kHz)	30	100 * 24000/F(kHz)	$20\log^{(24000/F(kHz))} + 40$
1.705 ~ 30	30	30	100 * 30	$20\log^{(30)} + 40$
30 ~ 88	100	3	100	$20\log^{(100)}$
88 ~ 216	150	3	150	$20\log^{(150)}$
216 ~ 960	200	3	200	$20\log^{(200)}$
Above 960	500	3	500	$20\log^{(500)}$

Limits Of Radiated Emission Measurement (Above 1000MHz)

Frequency (MHz)	Limit (dBuV/m) (at 3M)	
	Peak	Average
Above 1000	74	54

Notes:

- (1) The limit for radiated test was performed according to FCC PART 15C.
- (2) The tighter limit applies at the band edges.
- (3) Emission level (dBuV/m) =  $20\log$  Emission level (uV/m).

### Frequency Range Of Radiated Measurement

(a) For an intentional radiator the spectrum shall be investigated from the lowest radio frequency signal generated in the device, without going below 9 kHz, up to at least the frequency shown in this paragraph:

- (1) If the intentional radiator operates below 10 GHz: to the tenth harmonic of the highest fundamental frequency or to 40 GHz, whichever is lower.
- (2) If the intentional radiator operates at or above 10 GHz and below 30 GHz: to the fifth harmonic of the highest fundamental frequency or to 100 GHz, whichever is lower.
- (3) If the intentional radiator operates at or above 30 GHz: to the fifth harmonic of the highest fundamental frequency or to 200 GHz, whichever is lower, unless specified otherwise elsewhere in the rules.
- (4) If the intentional radiator operates at or above 95 GHz: To the third harmonic of the highest fundamental frequency or to 750 GHz, whichever is lower, unless specified otherwise elsewhere in the rules.
- (5) If the intentional radiator contains a digital device, regardless of whether this digital device controls the functions of the intentional radiator or the digital device is used for additional control or function purposes other than to enable the operation of the intentional radiator, the frequency range shall be investigated up to the range specified in paragraphs (a) (1)through (4) of this section or the range applicable to the digital device, as shown in paragraph (b)(1) of this section, whichever is the higher frequency range of investigation.

### 7.3 Test procedure

Receiver Parameter	Setting
Attenuation	Auto
9kHz~150kHz	RBW 200Hz for QP
150kHz~30MHz	RBW 9kHz for QP
30MHz~1000MHz	RBW 120kHz for QP

Spectrum Parameter	Setting
1-25GHz	RBW 1 MHz /VBW 1 MHz for Peak, RBW 1 MHz / VBW 10Hz for Average

Below 1GHz test procedure as below:

- a. The EUT was placed on the top of a rotating table 0.8 meters above the ground at a 3 meter semi-anechoic chamber. The table was rotated 360 degrees to determine the position of the highest radiation.
- b. The EUT was set 3 meters away from the interference-receiving antenna, which was mounted on the top of a variable-height antenna tower.
- c. The antenna height is varied from one meter to four meters above the ground to determine the maximum value of the field strength. Both horizontal and vertical polarizations of the antenna are set to make the measurement.
- d. For each suspected emission, the EUT was arranged to its worst case and then the antenna was tuned to heights from 1 meter to 4 meters (for the test frequency of below 30MHz, the antenna was tuned to heights 1 meter) and the rotatable table was turned from 0 degrees to 360 degrees to find the maximum reading.
- e. The test-receiver system was set to Peak Detect Function and Specified Bandwidth with Maximum Hold Mode.
- f. If the emission level of the EUT in peak mode was 10dB lower than the limit specified, then testing could be stopped and the peak values of the EUT would be reported. Otherwise the emissions that did not have 10dB margin would be re-tested one by one using peak, quasi-peak or average method as specified and then reported in a data sheet.

Above 1GHz test procedure as below:

- a. The EUT was placed on the top of a rotating table 1.5 meters above the ground at a 3 meter camber. The table was rotated 360 degrees to determine the position of the highest radiation.
- b. The EUT was set 3 meters away from the interference-receiving antenna, which was mounted on the top of a variable-height antenna tower.
- c. The antenna height is varied from one meter to four meters above the ground to determine the maximum value of the field strength. Both horizontal and vertical polarizations of the antenna are set to make the measurement.
- d. For each suspected emission, the EUT was arranged to its worst case and then the antenna was tuned to heights from 1 meter to 4 meters and the rota table was turned from 0 degrees to 360 degrees to find the maximum reading.
- e. The test-receiver system was set to Peak Detect Function and Specified Bandwidth with Maximum Hold Mode.
- f. If the emission level of the EUT in peak mode was 10dB lower than the limit specified, then testing could be stopped and the peak values of the EUT would be reported. Otherwise the emissions that did not have 10dB margin would be re-tested one by one using peak, quasi-peak or average method as specified and then reported in a data sheet.
- g. Test the EUT in the lowest channel, the middlest channel, the Highest channel.

Note:

Both horizontal and vertical antenna polarities were tested and performed pretest to three orthogonal axis. The worst case emissions were reported.

## 7.4 EUT Operating Conditions

The EUT was configured for testing in a typical fashion (as a customer would normally use it). The EUT has been programmed to continuously transmit during test. This operating condition was tested and used to collect the included data.

## 7.5 Test Result

Below 30MHz

Temperature:	26 °C	Relative Humidity:	54%
Pressure:	101KPa	Test Voltage :	AC120V/60Hz
Test Mode:	Mode 10	Polarization:	---

Freq.	Reading	Limit	Margin	State
(MHz)	(dBuV/m)	(dBuV/m)	(dB)	P/F
--	--	--	--	PASS
--	--	--	--	PASS

Note:

The amplitude of spurious emissions which are attenuated by more than 20dB below the permissible value has no need to be reported.

Distance extrapolation factor =  $40 \log(\text{specific distance}/\text{test distance})$ (dB);

Limit line = specific limits(dBuv) + distance extrapolation factor.

Between 30MHz – 1GHz

Temperature:	26 °C	Relative Humidity:	54%
Pressure:	101KPa	Test Voltage :	AC120V/60Hz
Test Mode:	Mode 10	Polarization :	Horizontal

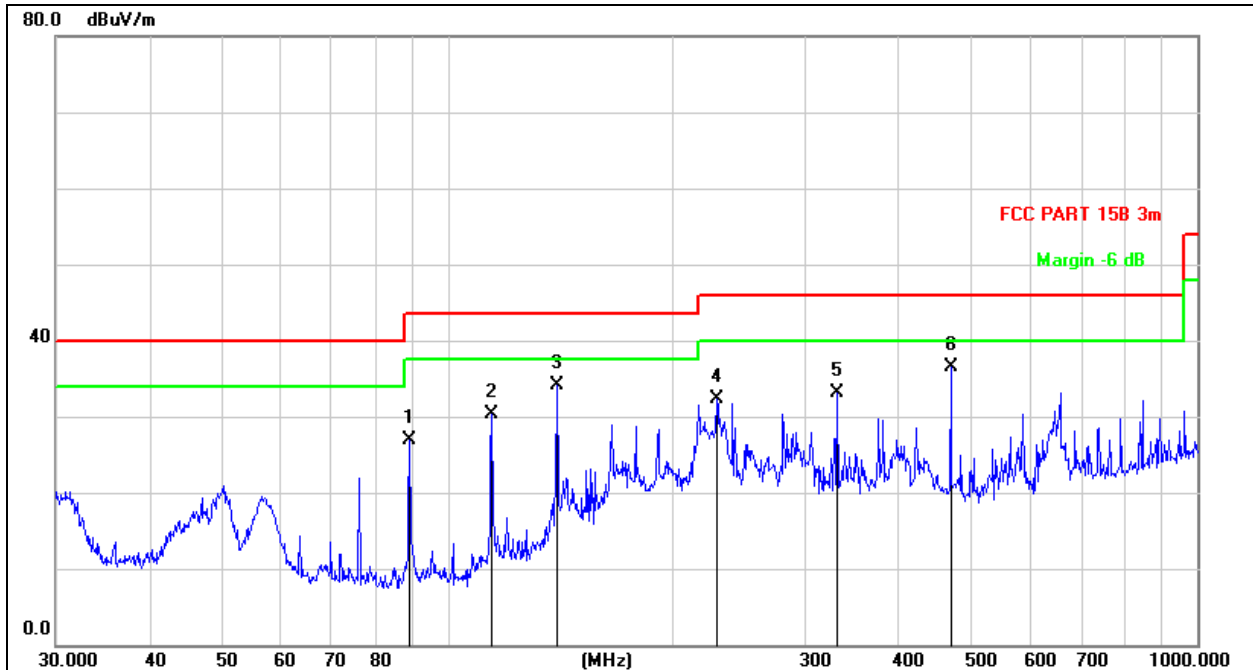

Remark:

1. Factor = Antenna Factor + Cable Loss – Pre-amplifier.
2. Measurement = Reading Level + Correct Factor
3. Over = Measurement - Limit

No.	Mk.	Freq. MHz	Reading Level dBuV	Correct Factor dB	Measure- ment dBuV/m	Limit dB/m	Over dB	Detector
1		88.9639	38.32	-11.48	26.84	43.50	-16.66	QP
2		114.5146	38.95	-8.68	30.27	43.50	-13.23	QP
3	*	139.8508	40.60	-6.46	34.14	43.50	-9.36	QP
4		228.4904	40.52	-8.22	32.30	46.00	-13.70	QP
5		330.1949	38.03	-4.90	33.13	46.00	-12.87	QP
6		468.8762	37.60	-1.09	36.51	46.00	-9.49	QP

Temperature:	26 °C	Relative Humidity:	54%
Pressure:	101KPa	Test Voltage :	AC120V/60Hz
Test Mode:	Mode 10	Polarization :	Vertical

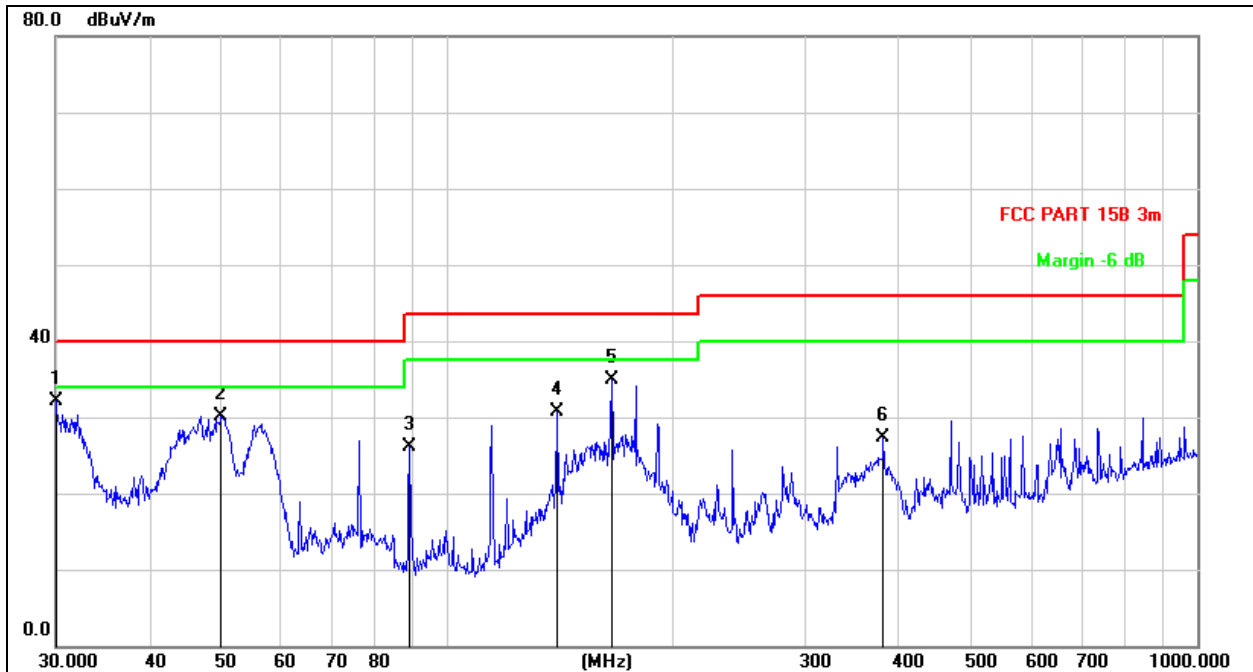
**Remark:**

1. Factor = Antenna Factor + Cable Loss – Pre-amplifier.
2. Measurement = Reading Level + Correct Factor
3. Over = Measurement - Limit

No.	Mk.	Freq. MHz	Reading Level dBuV	Correct Factor dB	Measure- ment dBuV/m	Limit dB/m	Over dB	Detector
1	*	30.0000	40.21	-8.18	32.03	40.00	-7.97	QP
2		49.8814	39.08	-9.04	30.04	40.00	-9.96	QP
3		88.9639	37.64	-11.48	26.16	43.50	-17.34	QP
4		139.8508	37.24	-6.46	30.78	43.50	-12.72	QP
5		165.4866	41.68	-6.74	34.94	43.50	-8.56	QP
6		381.2487	30.79	-3.52	27.27	46.00	-18.73	QP

**Between 1GHz – 25GHz**
**802.11b**

Polar (H/V)	Frequency	Reading Level	Correct Factor	Measure- ment	Limits	Over	Detector Type
	(MHz)	(dBuV/m)	(dB)	(dBuV/m)	(dBuV/ m)	(dB)	
<b>Low channel:2412MHz</b>							
V	4824.00	59.97	-3.87	56.1	74	-17.9	PK
V	4824.00	41.32	-3.87	37.45	54	-16.55	AV
V	7236.00	55.08	1.14	56.22	74	-17.78	PK
V	7236.00	38.11	1.19	39.3	54	-14.7	AV
H	4824.00	58.16	-3.86	54.3	74	-19.7	PK
H	4824.00	43.83	-3.86	39.97	54	-14.03	AV
H	7236.00	53.78	1.1	54.88	74	-19.12	PK
H	7236.00	39.09	1.1	40.19	54	-13.81	AV
<b>Middle channel:2437MHz</b>							
V	4874.00	59.41	-3.74	55.67	74	-18.33	PK
V	4874.00	42.96	-3.74	39.22	54	-14.78	AV
V	7311.00	53.03	1.47	54.5	74	-19.5	PK
V	7311.00	40.61	1.47	42.08	54	-11.92	AV
H	4874.00	60.57	-3.74	56.83	74	-17.17	PK
H	4874.00	42.02	-3.74	38.28	54	-15.72	AV
H	7311.00	54.11	1.47	55.58	74	-18.42	PK
H	7311.00	39.2	1.47	40.67	54	-13.33	AV
<b>High channel:2462MHz</b>							
V	4924.00	58.44	-3.59	54.85	74	-19.15	PK
V	4924.00	43.55	-3.59	39.96	54	-14.04	AV
V	7386.00	55.41	1.79	57.2	74	-16.8	PK
V	7386.00	40.16	1.79	41.95	54	-12.05	AV
H	4924.00	59.57	-3.59	55.98	74	-18.02	PK
H	4924.00	41.33	-3.59	37.74	54	-16.26	AV
H	7386.00	55.2	1.79	56.99	74	-17.01	PK
H	7386.00	41	1.79	42.79	54	-11.21	AV

**Remark:**

1. Emission Level = Meter Reading + Factor, Factor = Antenna Factor + Cable Loss – Pre-amplifier. Over = Emission Level - Limit
2. In restricted bands of operation, The spurious emissions below the permissible value more than 20dB
3. The amplitude of spurious emissions which are attenuated by more than 20dB below the permissible value has no need to be reported.

**802.11g**

Polar (H/V)	Frequency	Reading Level	Correct Factor	Measurement	Limits	Over	Detector Type
	(MHz)	(dBuV/m)	(dB)	(dBuV/m)	(dBuV/m)	(dB)	
<b>Low channel:2412MHz</b>							
V	4824.00	61.56	-3.87	57.69	74	-16.31	PK
V	4824.00	42.4	-3.87	38.53	54	-15.47	AV
V	7236.00	52.46	1.14	53.6	74	-20.4	PK
V	7236.00	38.13	1.19	39.32	54	-14.68	AV
H	4824.00	58.07	-3.86	54.21	74	-19.79	PK
H	4824.00	42.19	-3.86	38.33	54	-15.67	AV
H	7236.00	55.07	1.1	56.17	74	-17.83	PK
H	7236.00	39.68	1.1	40.78	54	-13.22	AV
<b>Middle channel:2437MHz</b>							
V	4874.00	59.78	-3.74	56.04	74	-17.96	PK
V	4874.00	42.06	-3.74	38.32	54	-15.68	AV
V	7311.00	52.83	1.47	54.3	74	-19.7	PK
V	7311.00	39.35	1.47	40.82	54	-13.18	AV
H	4874.00	59.36	-3.74	55.62	74	-18.38	PK
H	4874.00	41.81	-3.74	38.07	54	-15.93	AV
H	7311.00	53.75	1.47	55.22	74	-18.78	PK
H	7311.00	39.45	1.47	40.92	54	-13.08	AV
<b>High channel:2462MHz</b>							
V	4924.00	60.37	-3.59	56.78	74	-17.22	PK
V	4924.00	43.09	-3.59	39.5	54	-14.5	AV
V	7386.00	53.6	1.79	55.39	74	-18.61	PK
V	7386.00	40.74	1.79	42.53	54	-11.47	AV
H	4924.00	61.87	-3.59	58.28	74	-15.72	PK
H	4924.00	41.52	-3.59	37.93	54	-16.07	AV
H	7386.00	53.64	1.79	55.43	74	-18.57	PK
H	7386.00	40.88	1.79	42.67	54	-11.33	AV

**Remark:**

1. Emission Level = Meter Reading + Factor,

Factor = Antenna Factor + Cable Loss – Pre-amplifier.

Over= Emission Level - Limit

2. In restricted bands of operation, The spurious emissions below the permissible value more than 20dB

3. The amplitude of spurious emissions which are attenuated by more than 20dB below the permissible value has no need to be reported.



**802.11n20**

Polar (H/V)	Frequency	Reading Level	Correct Factor	Measurement	Limits	Over	Detector Type
	(MHz)	(dBuV/m)	(dB)	(dBuV/m)	(dBuV/m)	(dB)	
<b>Low channel:2412MHz</b>							
V	4824.00	60.15	-3.87	56.28	74	-17.72	PK
V	4824.00	42.52	-3.87	38.65	54	-15.35	AV
V	7236.00	52.78	1.14	53.92	74	-20.08	PK
V	7236.00	38.79	1.19	39.98	54	-14.02	AV
H	4824.00	59.73	-3.86	55.87	74	-18.13	PK
H	4824.00	41.61	-3.86	37.75	54	-16.25	AV
H	7236.00	53.15	1.1	54.25	74	-19.75	PK
H	7236.00	38.09	1.1	39.19	54	-14.81	AV
<b>Middle channel:2437MHz</b>							
V	4874.00	59.97	-3.74	56.23	74	-17.77	PK
V	4874.00	43.68	-3.74	39.94	54	-14.06	AV
V	7311.00	55.23	1.47	56.7	74	-17.3	PK
V	7311.00	39.2	1.47	40.67	54	-13.33	AV
H	4874.00	58.22	-3.74	54.48	74	-19.52	PK
H	4874.00	41.81	-3.74	38.07	54	-15.93	AV
H	7311.00	55.13	1.47	56.6	74	-17.4	PK
H	7311.00	39.61	1.47	41.08	54	-12.92	AV
<b>High channel:2462MHz</b>							
V	4924.00	60.82	-3.59	57.23	74	-16.77	PK
V	4924.00	41.6	-3.59	38.01	54	-15.99	AV
V	7386.00	53.24	1.79	55.03	74	-18.97	PK
V	7386.00	40.36	1.79	42.15	54	-11.85	AV
H	4924.00	60.17	-3.59	56.58	74	-17.42	PK
H	4924.00	43.95	-3.59	40.36	54	-13.64	AV
H	7386.00	53.66	1.79	55.45	74	-18.55	PK
H	7386.00	39.38	1.79	41.17	54	-12.83	AV

**Remark:**

1. Emission Level = Meter Reading + Factor,

Factor = Antenna Factor + Cable Loss – Pre-amplifier.

Over= Emission Level - Limit

2. In restricted bands of operation, The spurious emissions below the permissible value more than 20dB

3. The amplitude of spurious emissions which are attenuated by more than 20dB below the permissible value has no need to be reported.

## 8. Radiated Band Emission Measurement and Restricted Bands Of Operation

### 8.1 Block Diagram Of Test Setup

Radiated Emission Test-Up Frequency Above 1GHz

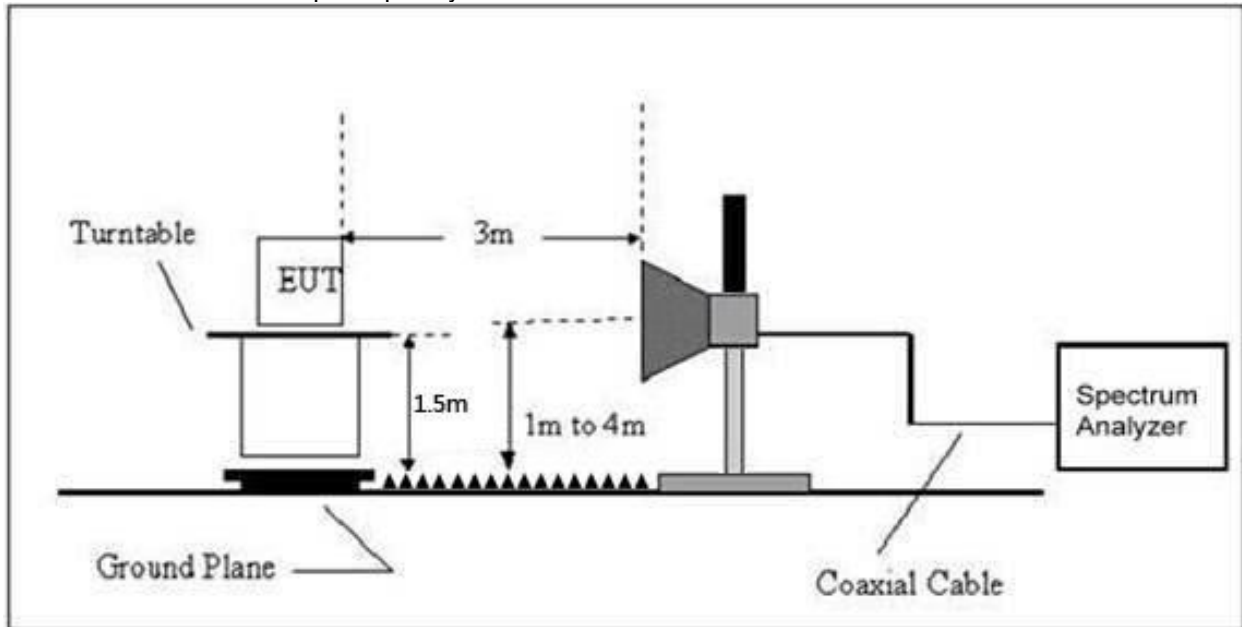

### 8.2 Limit

FCC Part15 C Section 15.209 and 15.205

(a) Except as shown in paragraph (d) of this section, only spurious emissions are permitted in any of the frequency bands listed below:

MHz	MHz	MHz	GHz
0.090-0.110	16.42-16.423	399.9-410	4.5-5.15
0.495-0.505	16.69475-16.69525	608-614	5.35-5.46
2.1735-2.1905	16.80425-16.80475	960-1240	7.25-7.75
4.125-4.128	25.5-25.67	1300-1427	8.025-8.5
4.17725-4.17775	37.5-38.25	1435-1626.5	9.0-9.2
4.20725-4.20775	73-74.6	1645.5-1646.5	9.3-9.5
6.215-6.218	74.8-75.2	1660-1710	10.6-12.7
6.26775-6.26825	108-121.94	1718.8-1722.2	13.25-13.4
6.31175-6.31225	123-138	2200-2300	14.47-14.5
8.291-8.294	149.9-150.05	2310-2390	15.35-16.2
8.362-8.366	156.52475-156.52525	2483.5-2500	17.7-21.4
8.37625-8.38675	156.7-156.9	2690-2900	22.01-23.12
8.41425-8.41475	162.0125-167.17	3260-3267	23.6-24.0
12.29-12.293	167.72-173.2	3332-3339	31.2-31.8
12.51975-12.52025	240-285	3345.8-3358	36.43-36.5
12.57675-12.57725	322-335.4	3600-4400	(2)
13.36-13.41			

## Limits Of Radiated Emission Measurement (Above 1000MHz)

Frequency (MHz)	Limit (dBuV/m) (at 3M)	
	Peak	Average
Above 1000	74	54

## Notes:

- (1)The limit for radiated test was performed according to FCC PART 15C.
- (2)The tighter limit applies at the band edges.
- (3)Emission level (dBuV/m)=20log Emission level (uV/m).

### 8.3 Test procedure

Receiver Parameter	Setting
Attenuation	Auto
Start Frequency	2300MHz
Stop Frequency	2520
RB / VB (emission in restricted band)	1 MHz / 1 MHz for Peak, 1 MHz / 10Hz for Average

Above 1GHz test procedure as below:

- a.The EUT was placed on the top of a rotating table 1.5 meters above the ground at a 3 meter camber. The table was rotated 360 degrees to determine the position of the highest radiation.
- b.The EUT was set 3 meters away from the interference-receiving antenna, which was mounted on the top of a variable-height antenna tower.
- c.The antenna height is varied from one meter to four meters above the ground to determine the maximum value of the field strength. Both horizontal and vertical polarizations of the antenna are set to make the measurement.
- d.For each suspected emission, the EUT was arranged to its worst case and then the antenna was tuned to heights from 1 meter to 4 meters and the rota table was turned from 0 degrees to 360 degrees to find the maximum reading.
- e.The test-receiver system was set to Peak Detect Function and Specified Bandwidth with Maximum Hold Mode.
- f. If the emission level of the EUT in peak mode was 10dB lower than the limit specified, then testing could be stopped and the peak values of the EUT would be reported. Otherwise the emissions that did not have 10dB margin would be re-tested one by one using peak, quasi-peak or average method as specified and then reported in a data sheet.
- g. Test the EUT in the lowest channel, the middlest channel, the Highest channel.

## Note:

Both horizontal and vertical antenna polarities were tested and performed pretest to three orthogonal axis. The worst case emissions were reported.

### 8.4 EUT Operating Conditions

The EUT was configured for testing in a typical fashion (as a customer would normally use it). The EUT has been programmed to continuously transmit during test. This operating condition was tested and used to collect the included data.

## 8.5 Test Result

Test mode	Polar (H/V)	Frequency (MHz)	Reading Level (dBuV/m)	Correct Factor (dB)	Measurement (dBuV/m)	Limits (dBuV/m)		Result	
					PK	PK	AV		
802.11b	<b>Low Channel 2412MHz</b>								
	H	2390.00	54.86	-6.70	48.16	74.00	54.00	PASS	
	H	2400.00	60.37	-6.71	53.66	74.00	54.00	PASS	
	V	2390.00	53.69	-6.70	46.99	74.00	54.00	PASS	
	V	2400.00	58.43	-6.71	51.72	74.00	54.00	PASS	
	<b>High Channel 2462MHz</b>								
	H	2483.50	53.49	-6.79	46.70	74.00	54.00	PASS	
	H	2500.00	48.84	-6.81	42.03	74.00	54.00	PASS	
	V	2483.50	52.29	-6.79	45.50	74.00	54.00	PASS	
	V	2500.00	48.95	-6.81	42.14	74.00	54.00	PASS	
	802.11g	<b>Low Channel 2412MHz</b>							
		H	2390.00	53.04	-6.70	46.34	74.00	54.00	PASS
H		2400.00	58.15	-6.71	51.44	74.00	54.00	PASS	
V		2390.00	57.54	-6.70	50.84	74.00	54.00	PASS	
V		2400.00	57.39	-6.71	50.68	74.00	54.00	PASS	
<b>High Channel 2462MHz</b>									
H		2483.50	58.28	-6.79	51.49	74.00	54.00	PASS	
H		2500.00	54.73	-6.81	47.92	74.00	54.00	PASS	
V		2483.50	58.11	-6.79	51.32	74.00	54.00	PASS	
V		2500.00	52.79	-6.81	45.98	74.00	54.00	PASS	

**Remark:**

1. Emission Level = Meter Reading + Factor, Factor = Antenna Factor + Cable Loss – Pre-amplifier.  
Over= Emission Level – Limit
2. If the PK measured levels comply with average limit, then the average level were deemed to comply with average limit.
- 3 In restricted bands of operation, The spurious emissions below the permissible value more than 20dB
4. The amplitude of spurious emissions which are attenuated by more than 20dB below the permissible value has no need to be reported.

Test mode	Polar (H/V)	Frequency (MHz)	Reading Level (dBuV/m)	Correct Factor (dB)	Measurement (dBuV/m)	Limits (dBuV/m)		Result
					PK	PK	AV	
802.11n20	<b>Low Channel 2412MHz</b>							
	H	2390.00	56.28	-6.70	49.58	74.00	54.00	PASS
	H	2400.00	55.04	-6.71	48.33	74.00	54.00	PASS
	V	2390.00	50.06	-6.70	43.36	74.00	54.00	PASS
	V	2400.00	55.82	-6.71	49.11	74.00	54.00	PASS
	<b>High Channel 2462MHz</b>							
	H	2483.50	55.36	-6.79	48.57	74.00	54.00	PASS
	H	2500.00	56.93	-6.81	50.12	74.00	54.00	PASS
	V	2483.50	56.77	-6.79	49.98	74.00	54.00	PASS
	V	2500.00	50.24	-6.81	43.43	74.00	54.00	PASS

**Remark:**

1. Emission Level = Meter Reading + Factor, Factor = Antenna Factor + Cable Loss – Pre-amplifier.  
Over= Emission Level – Limit
2. If the PK measured levels comply with average limit, then the average level were deemed to comply with average limit.
- 3 In restricted bands of operation, The spurious emissions below the permissible value more than 20dB
4. The amplitude of spurious emissions which are attenuated by more than 20dB below the permissible value has no need to be reported.

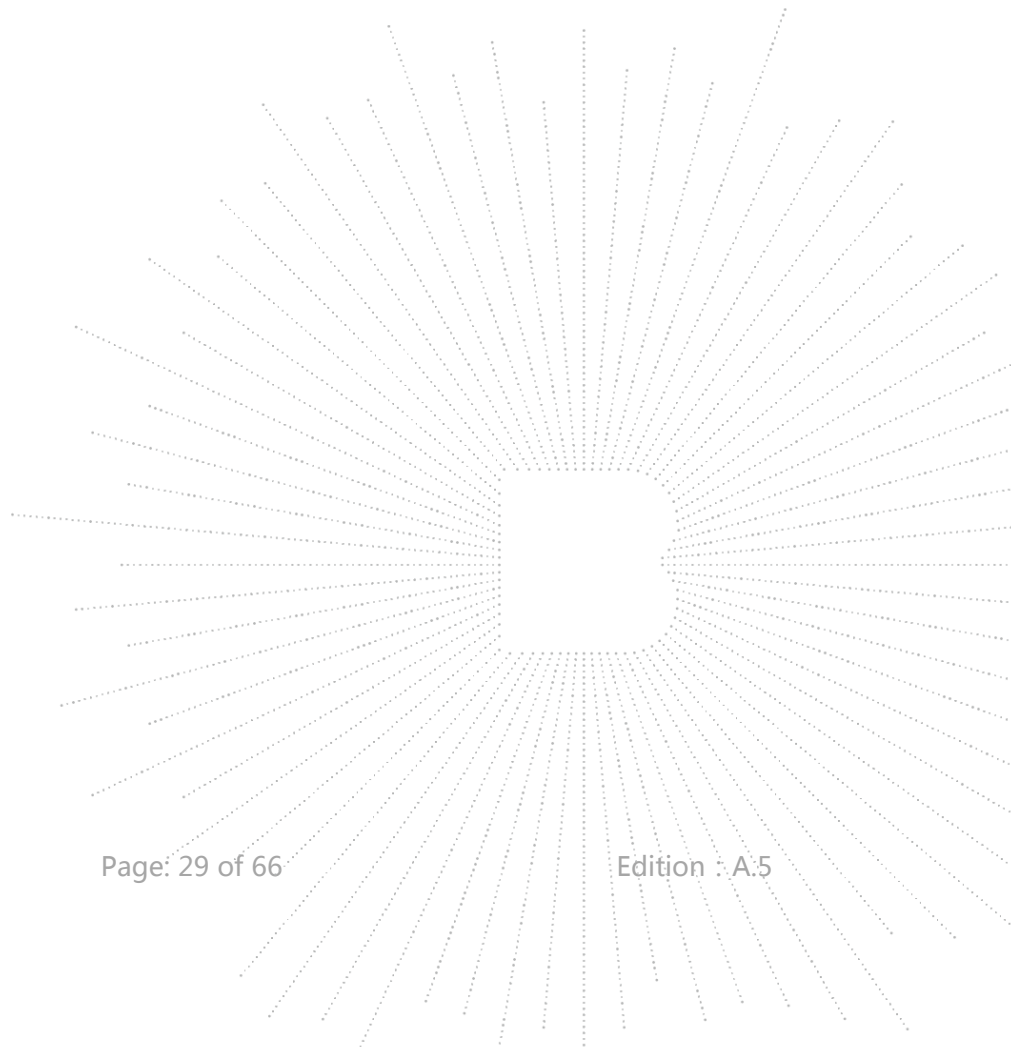

## 9. Power Spectral Density Test

### 9.1 Block Diagram Of Test Setup



### 9.2 Limit

FCC Part15 (15.247) , Subpart C				
Section	Test Item	Limit	Frequency Range (MHz)	Result
15.247	Power Spectral Density	8 dBm (in any 3KHz)	2400-2483.5	PASS

Limits Of Radiated Emission Measurement (Above 1000MHz)

### 9.3 Test procedure

1. Set analyzer center frequency to DTS channel center frequency.
2. Set the span to 1.5 times the DTS bandwidth.
3. Set the RBW to: 3 kHz
4. Set the VBW  $\geq 3 \times$  RBW.
5. Detector = peak.
6. Sweep time = auto couple.
7. Trace mode = max hold.
8. Allow trace to fully stabilize.
9. Use the peak marker function to determine the maximum amplitude level within the RBW.
10. If measured value exceeds limit, reduce RBW (no less than 3 kHz) and repeat.

### 9.4 EUT Operating Conditions

The EUT tested system was configured as the statements of 4.6 Unless otherwise a special operating condition is specified in the follows during the testing.

Note: Power Spectral Density(dBm)=Reading+Cable Loss

## 9.5 Test Result

Temperature:	26 °C	Relative Humidity:	54%
Pressure:	101KPa	Test Voltage:	AC120V/60Hz

Test Mode	Frequency	Power Spectral Density (dBm/3kHz)	Limit (dBm/3kHz)	Result
TX b Mode	2412 MHz	-6.02	8	PASS
	2437 MHz	-4.78	8	PASS
	2462 MHz	-6.06	8	PASS
TX g Mode	2412 MHz	-10.34	8	PASS
	2437 MHz	-8.23	8	PASS
	2462 MHz	-9.93	8	PASS
TX n Mode(20M)	2412 MHz	-11.24	8	PASS
	2437 MHz	-10.22	8	PASS
	2462 MHz	-11.05	8	PASS

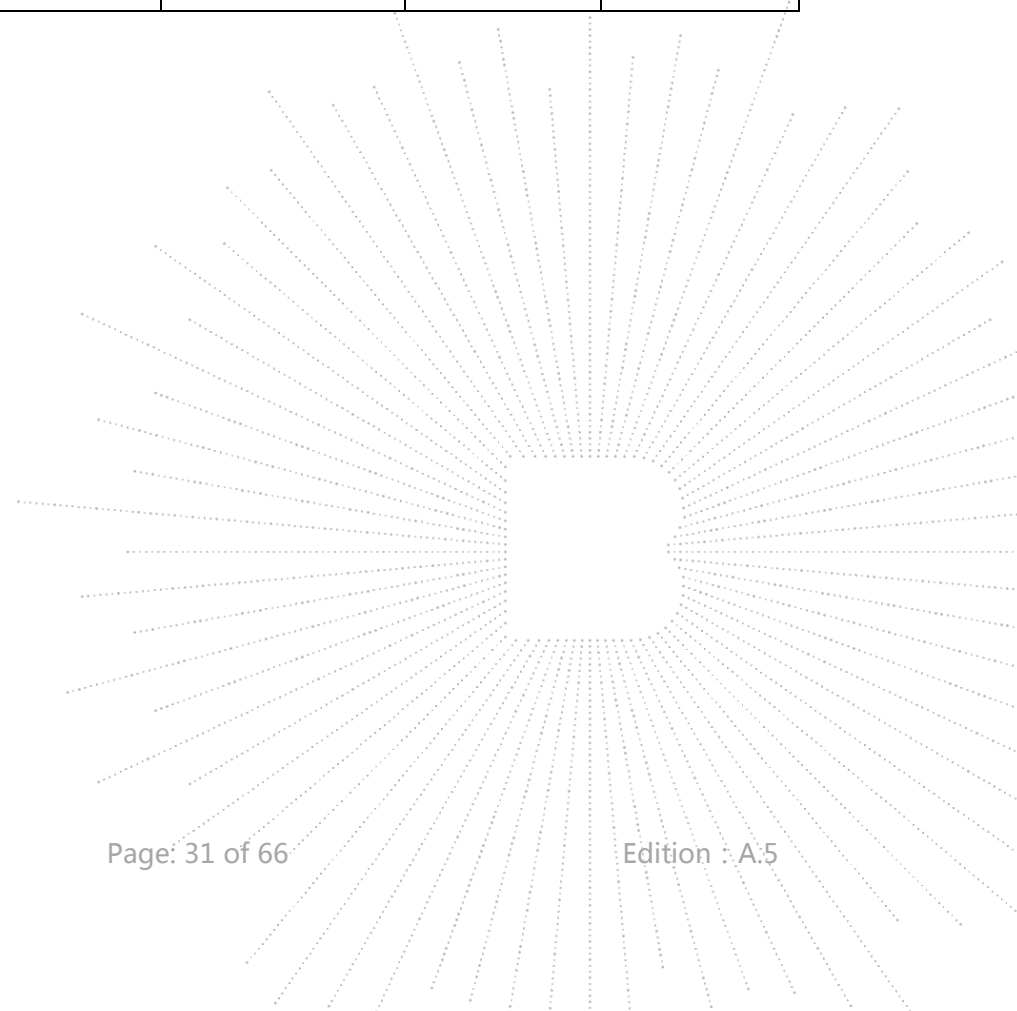

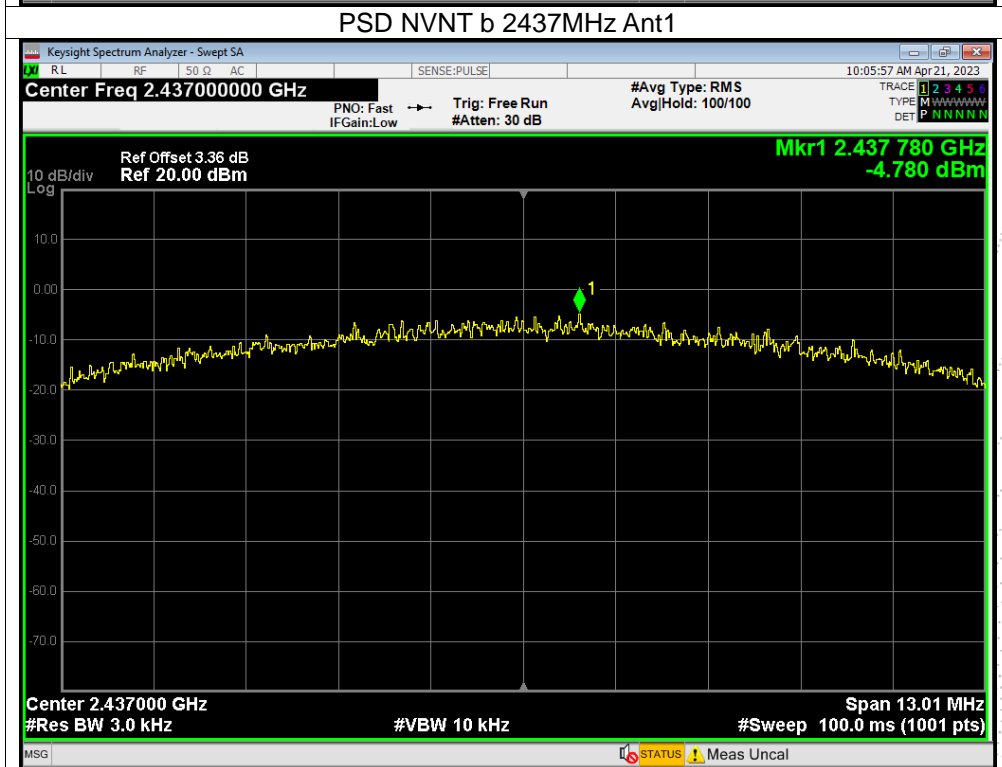
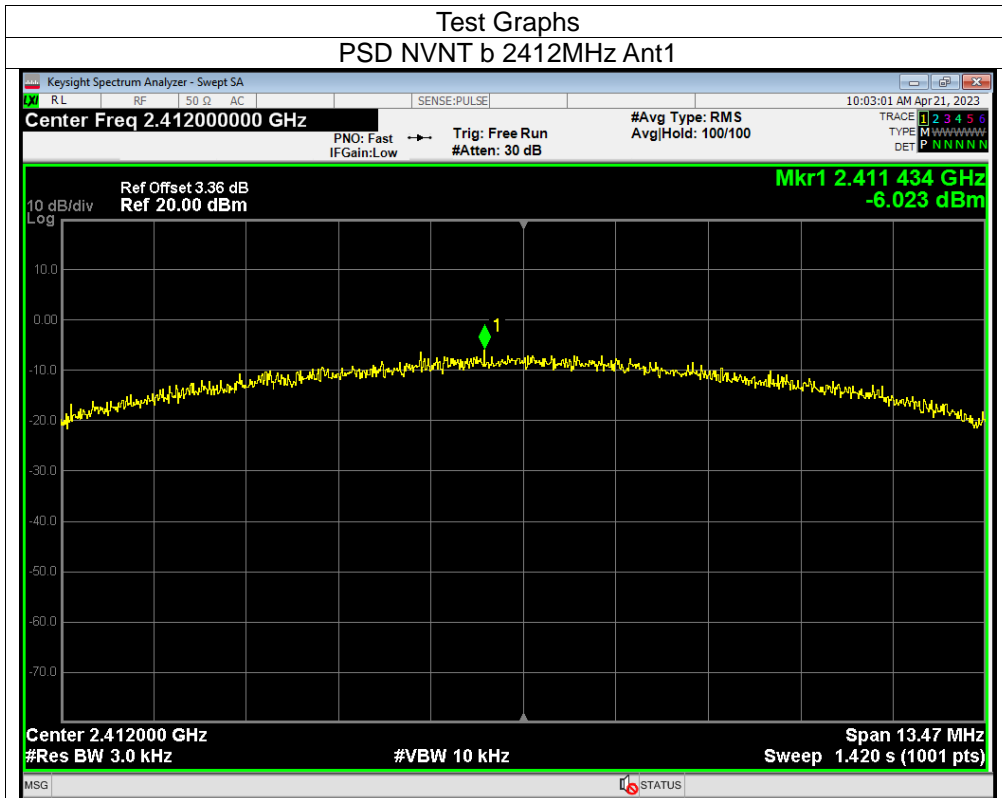



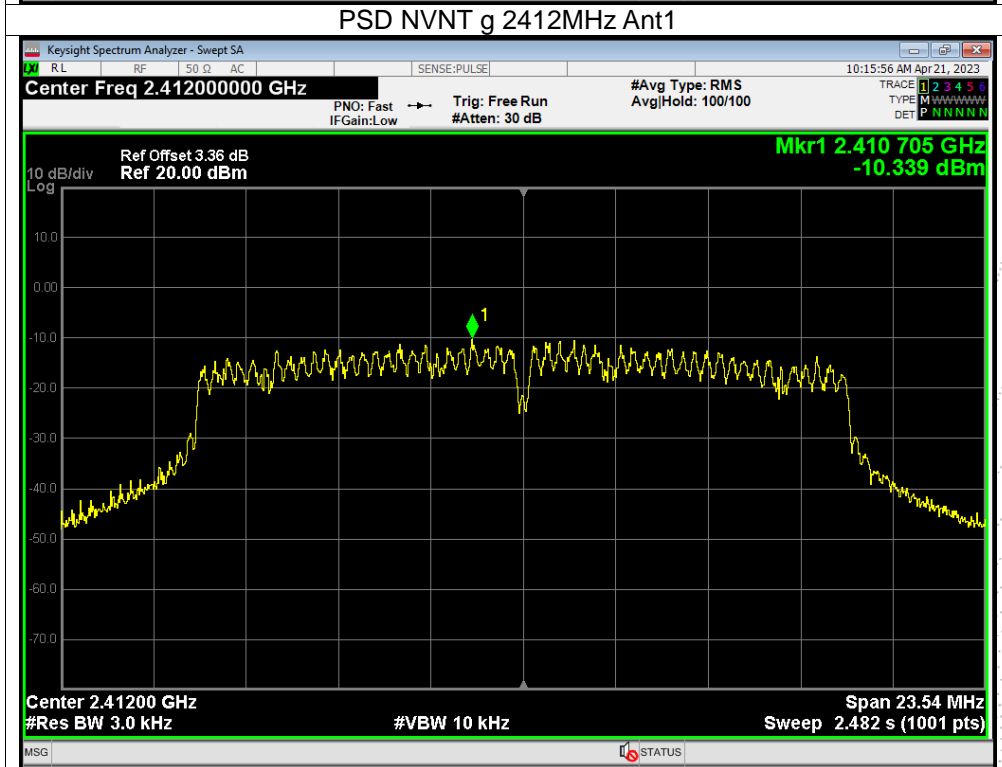
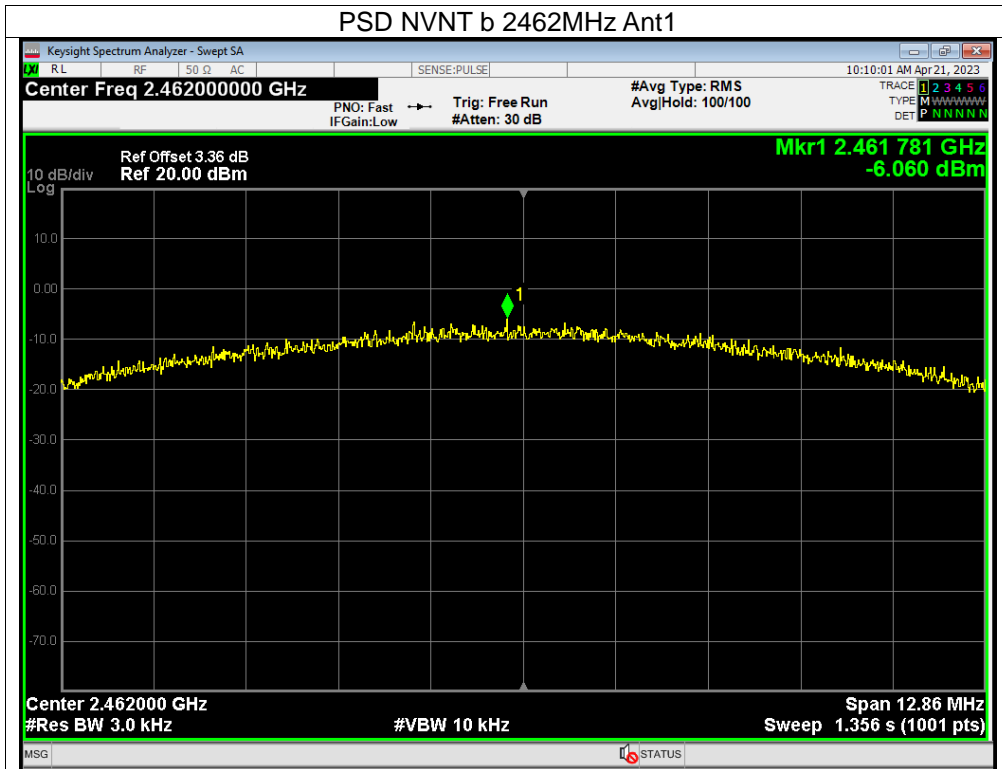

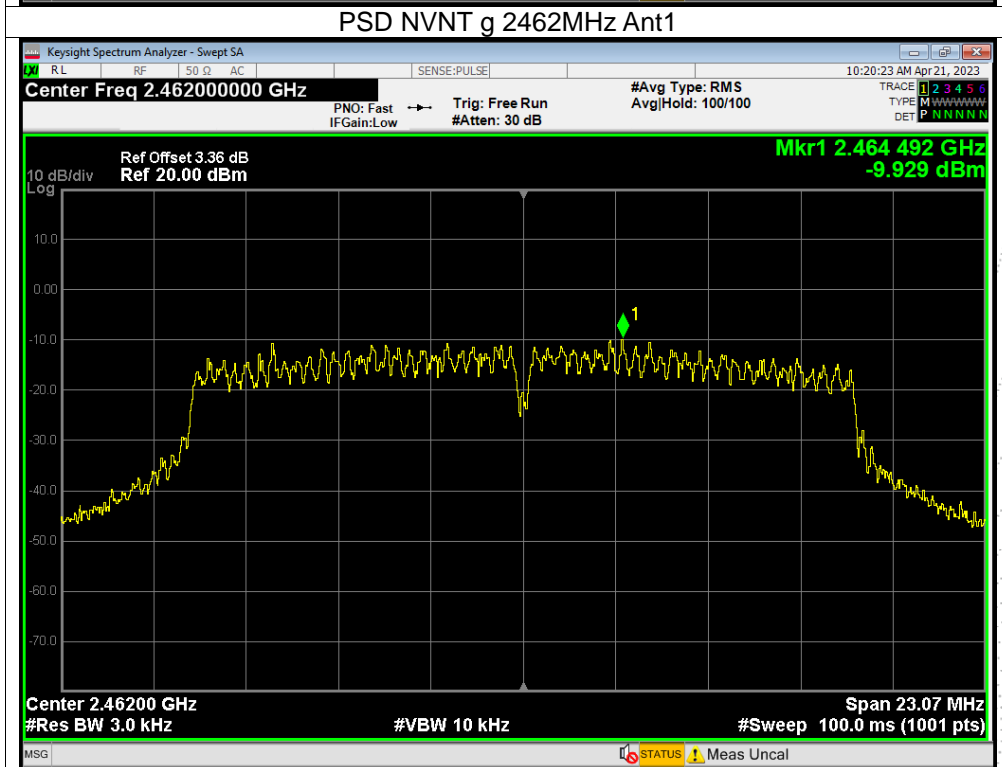
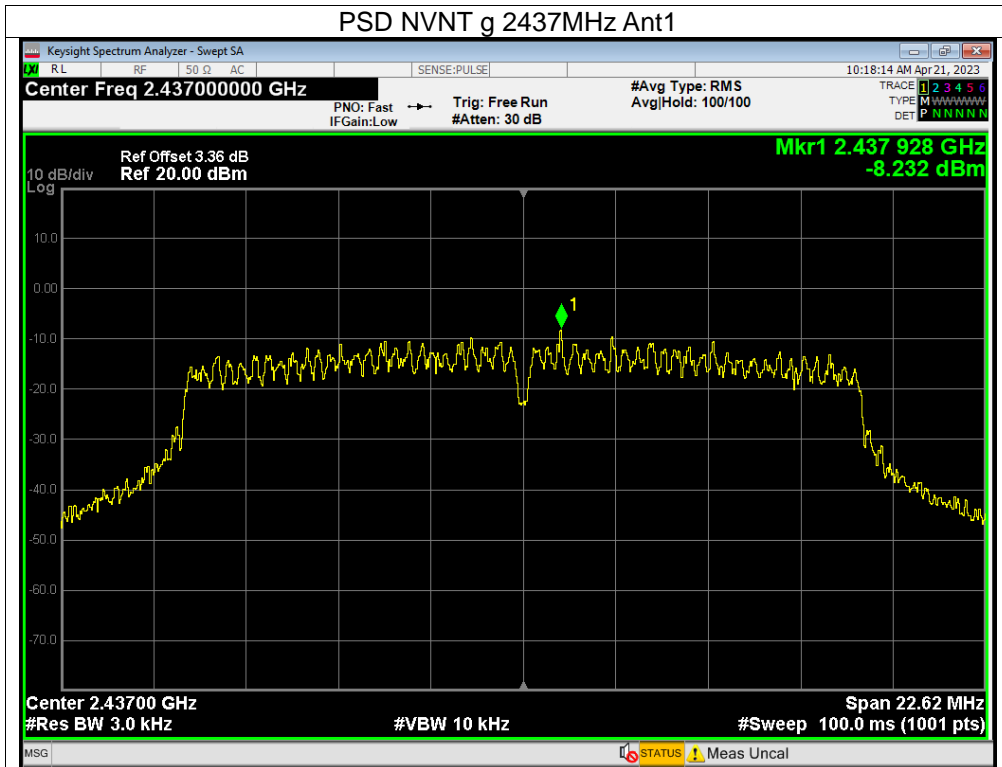

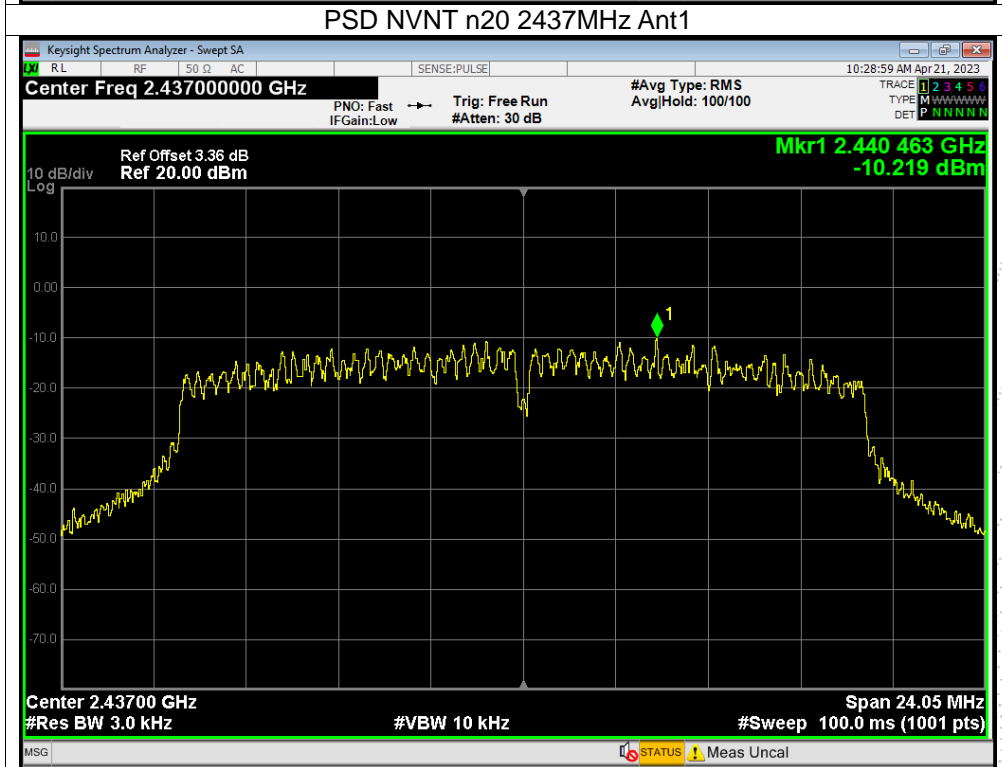
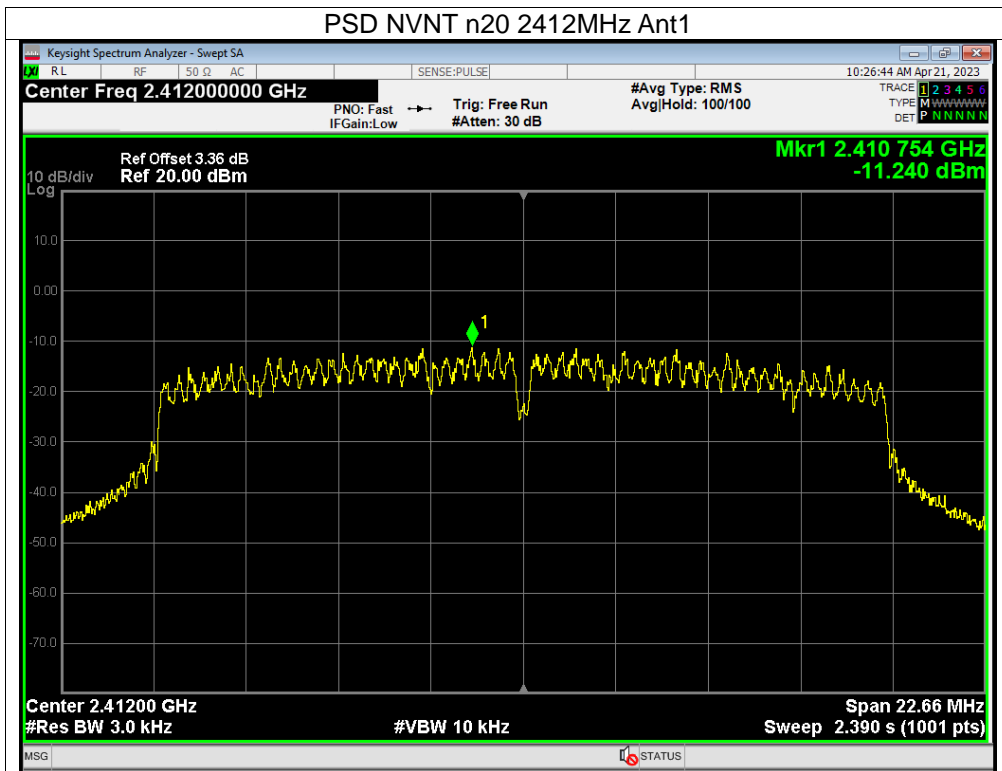

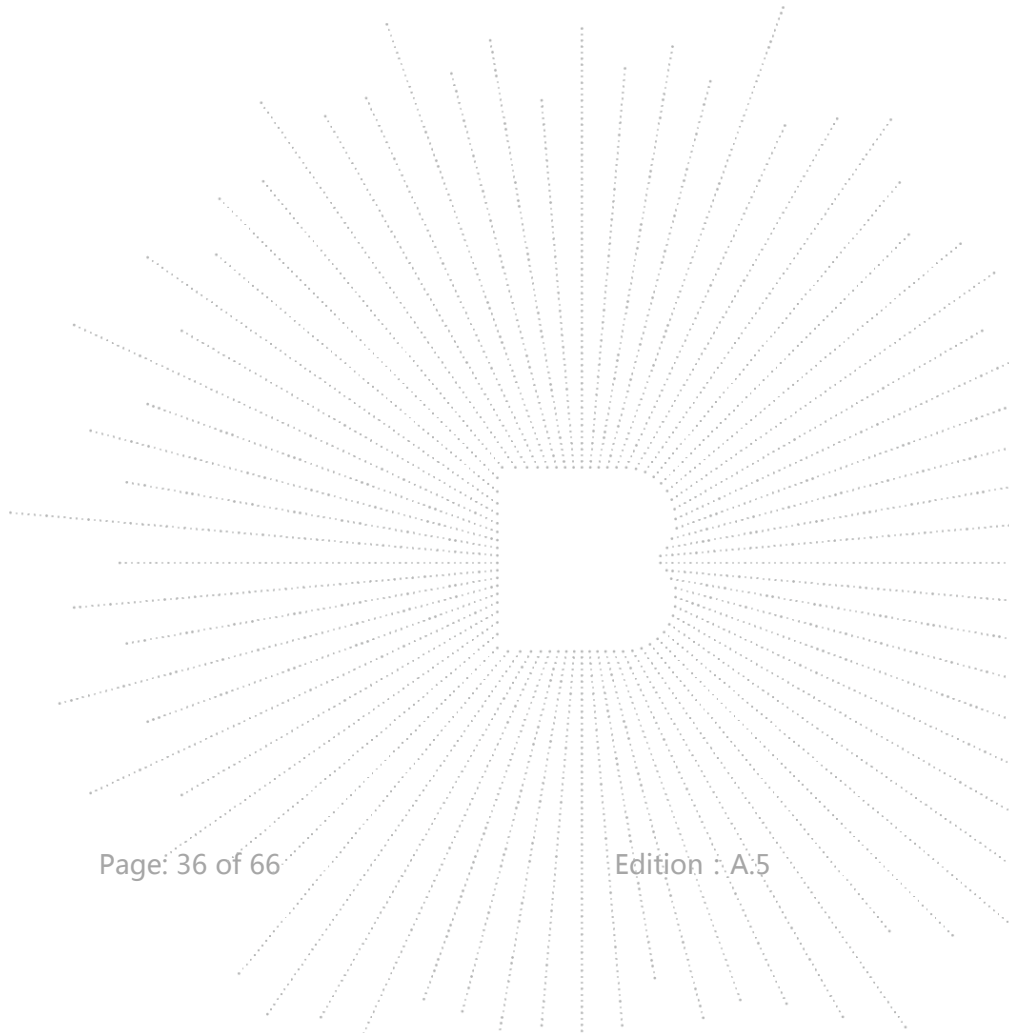
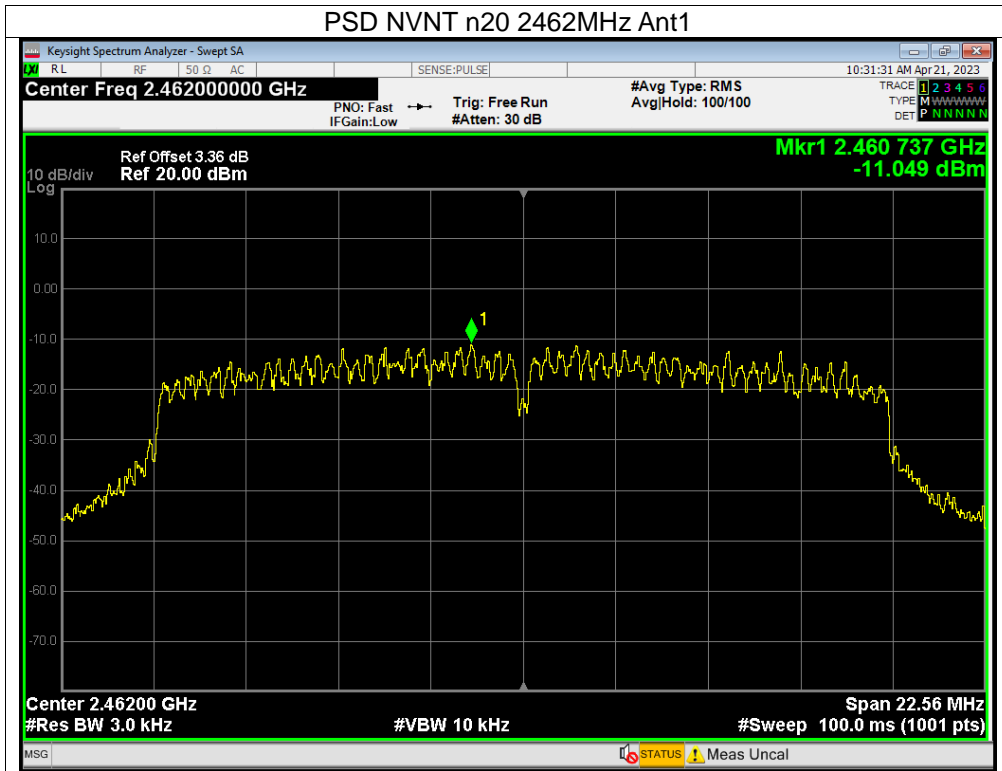

## 10. Bandwidth Test

### 10.1 Block Diagram Of Test Setup

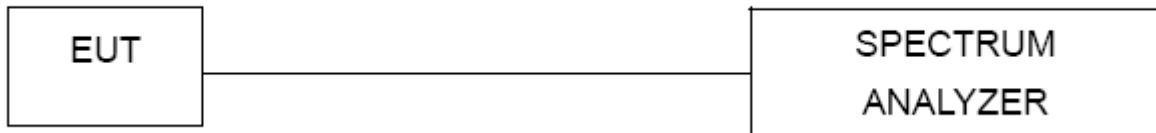

### 10.2 Limit

FCC Part15 (15.247) , Subpart C				
Section	Test Item	Limit	Frequency Range (MHz)	Result
15.247(a)(2)	Bandwidth	$\geq 500\text{KHz}$ (-6dB bandwidth)	2400-2483.5	PASS

### 10.3 Test procedure

1. Set RBW = 100 kHz.
2. Set the video bandwidth (VBW)  $\geq 3 \times$  RBW.
3. Detector = Peak.
4. Trace mode = max hold.
5. Sweep = auto couple.
6. Allow the trace to stabilize.
7. Measure the maximum width of the emission that is constrained by the frequencies associated with the two outermost amplitude points (upper and lower frequencies) that are attenuated by 6 dB relative to the maximum level measured in the fundamental emission.

### 10.4 EUT Operating Conditions

The EUT tested system was configured as the statements of 4.6 Unless otherwise a special operating condition is specified in the follows during the testing.

Note: Power Spectral Density(dBm)=Reading+Cable Loss

## 10.5 Test Result

Temperature:	26 °C	Relative Humidity:	54%
Pressure:	101KPa	Test Voltage:	AC120V/60Hz

Test Mode	Frequency (MHz)	-6dB bandwidth (MHz)	Limit (kHz)	Result
TX b Mode	2412	8.981	500	Pass
	2437	8.67	500	Pass
	2462	8.573	500	Pass
TX g Mode	2412	15.691	500	Pass
	2437	15.083	500	Pass
	2462	15.381	500	Pass
TX n Mode(20M)	2412	15.108	500	Pass
	2437	16.031	500	Pass
	2462	15.039	500	Pass

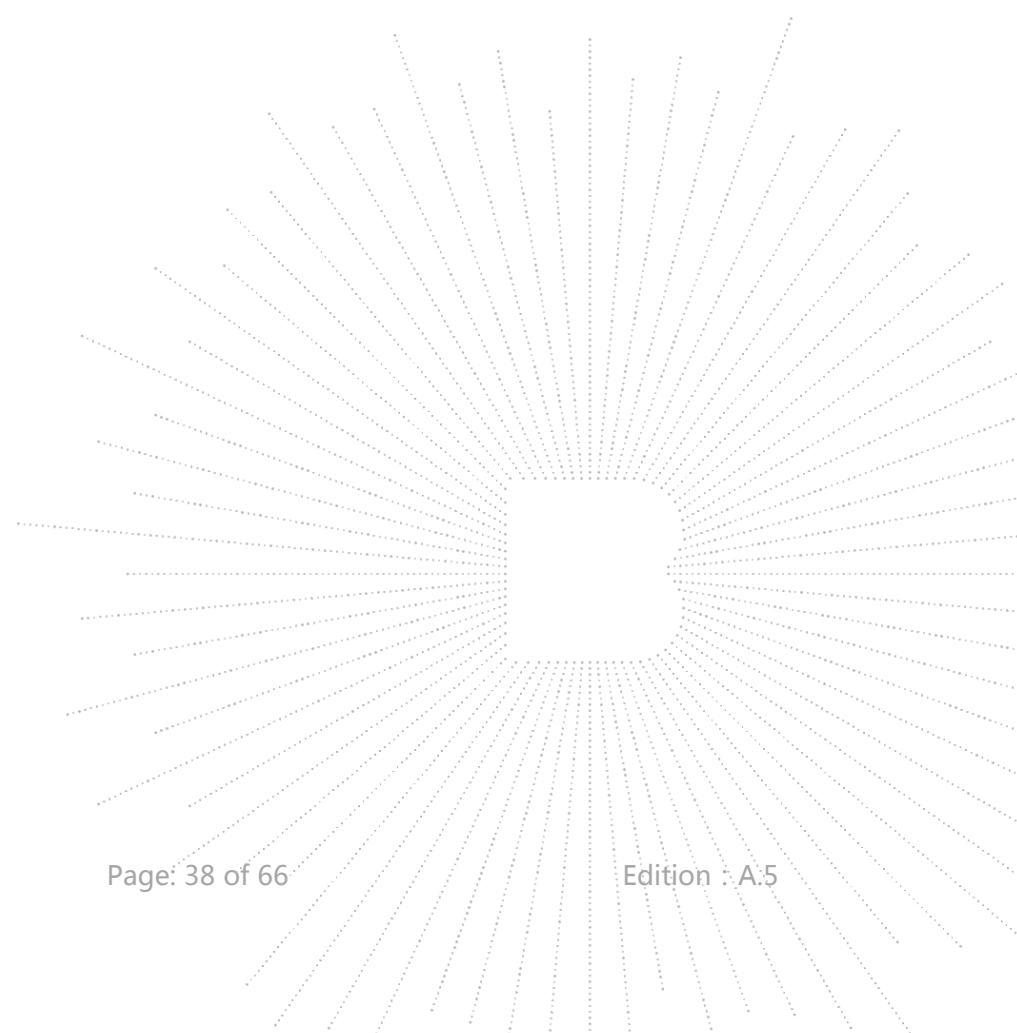

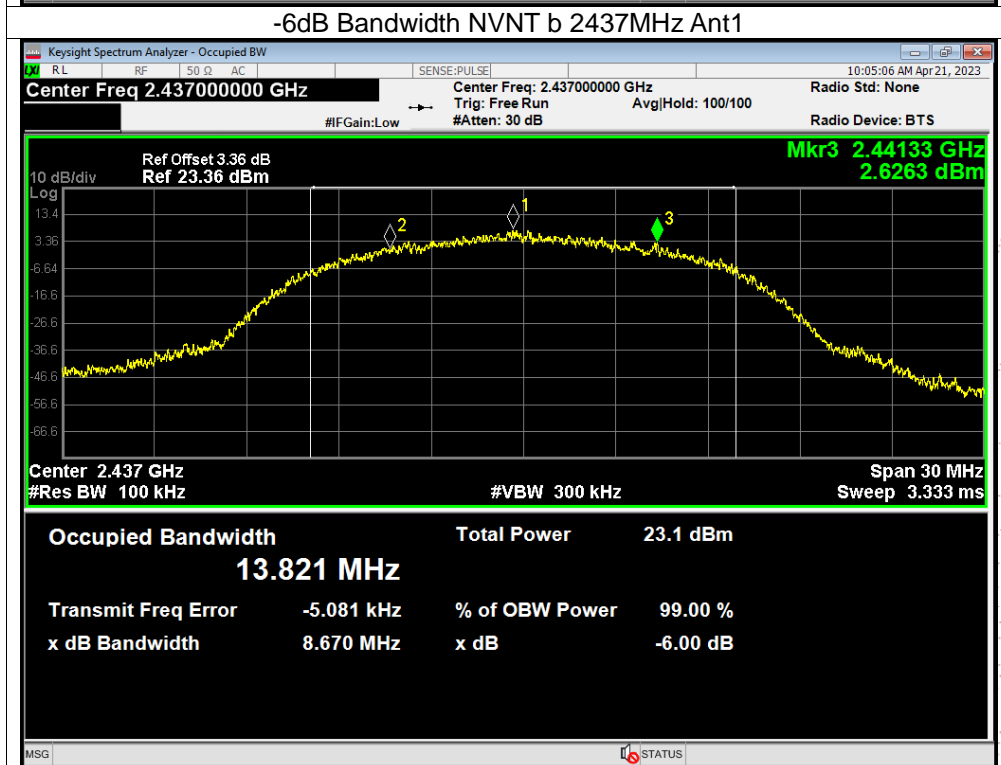
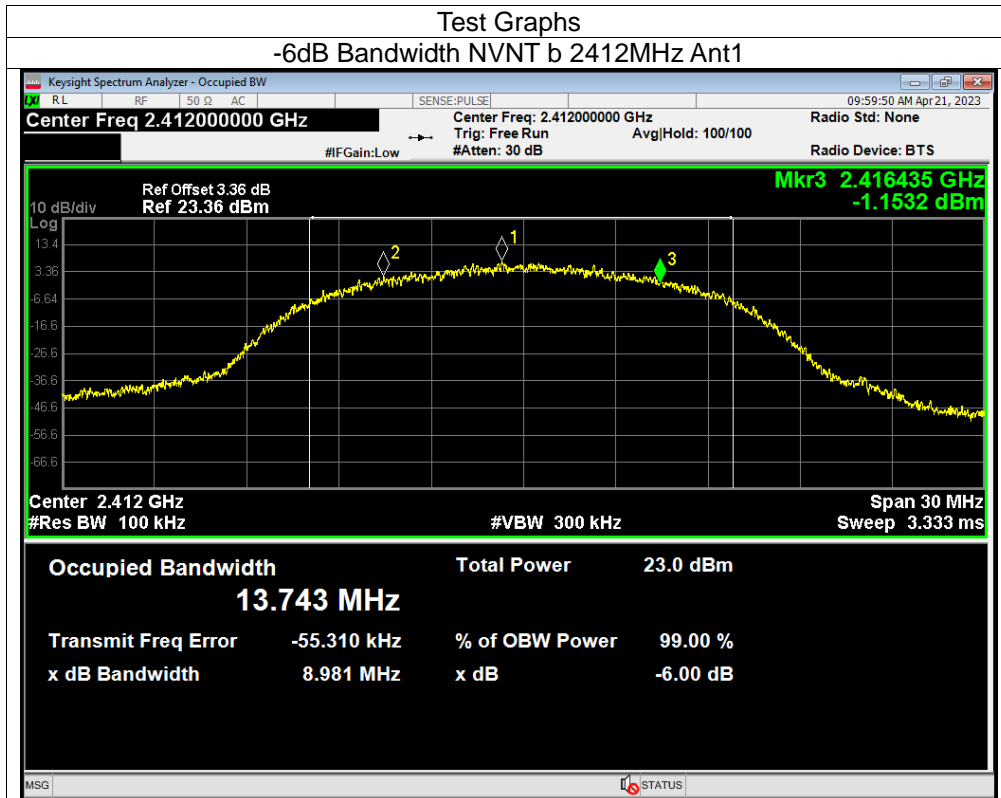

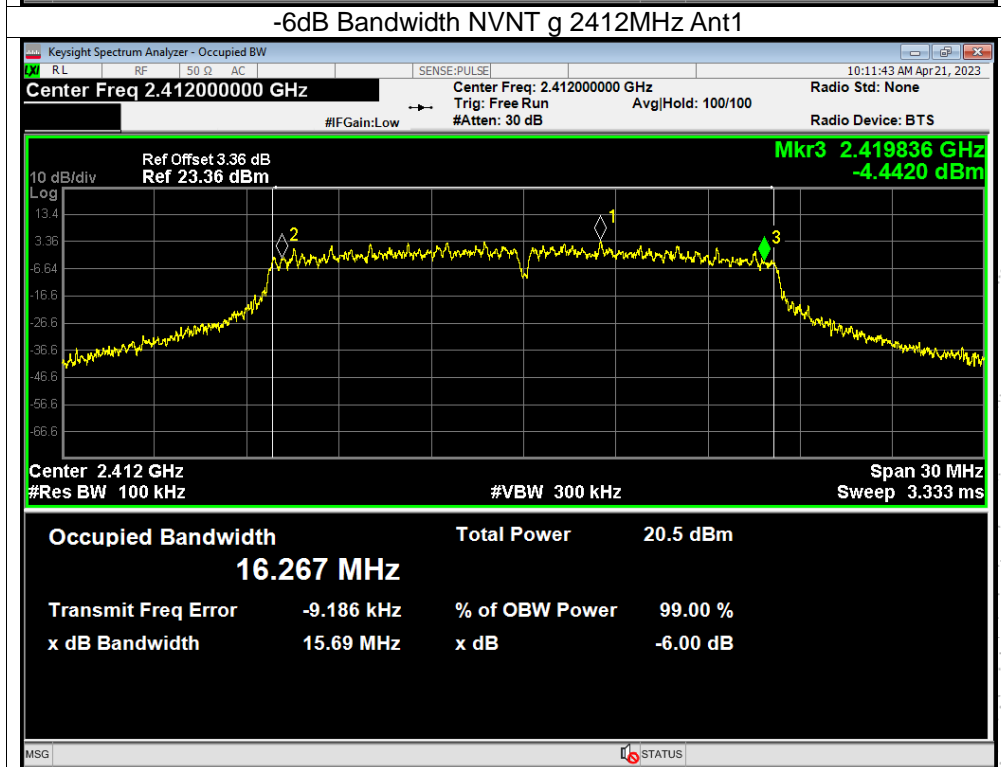
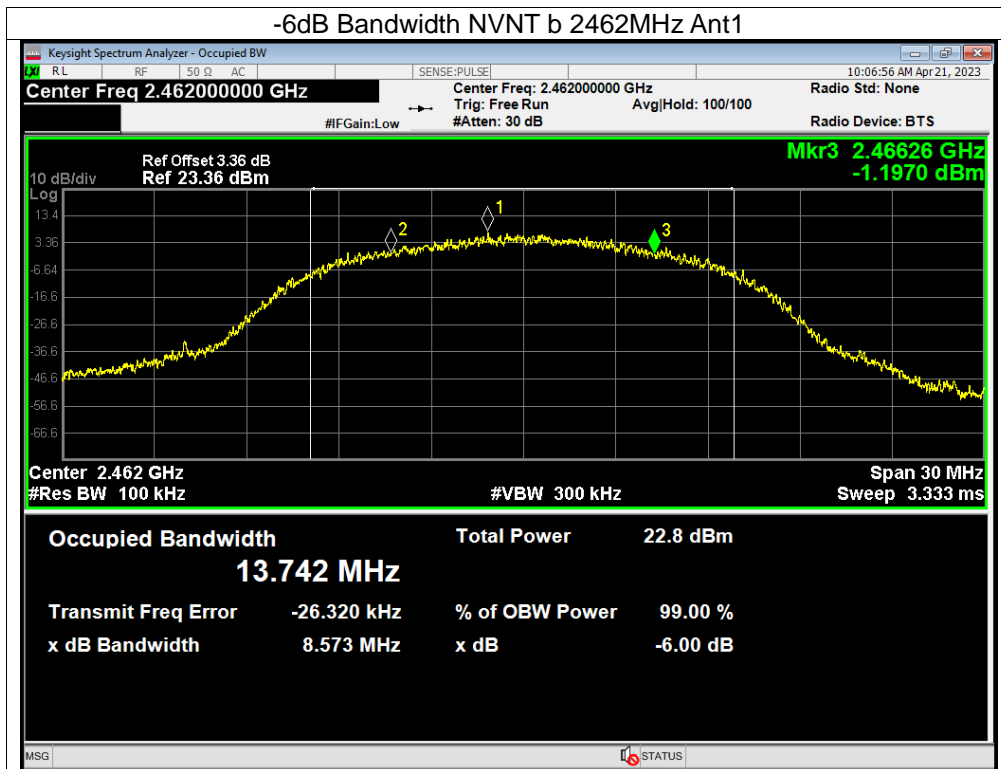



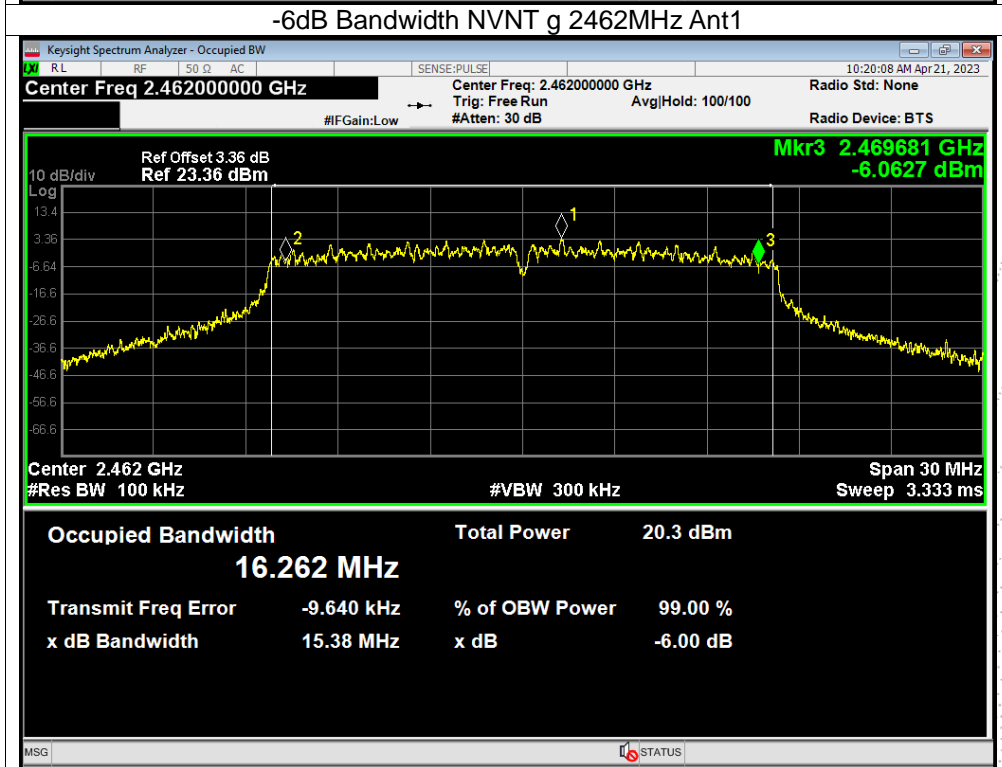
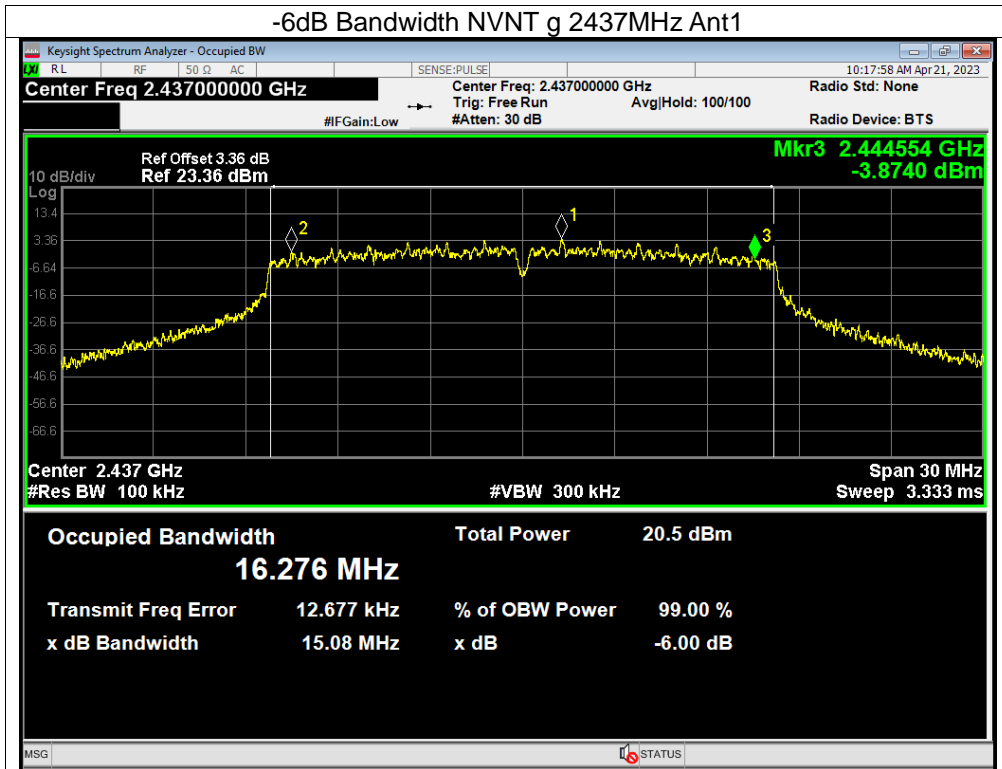

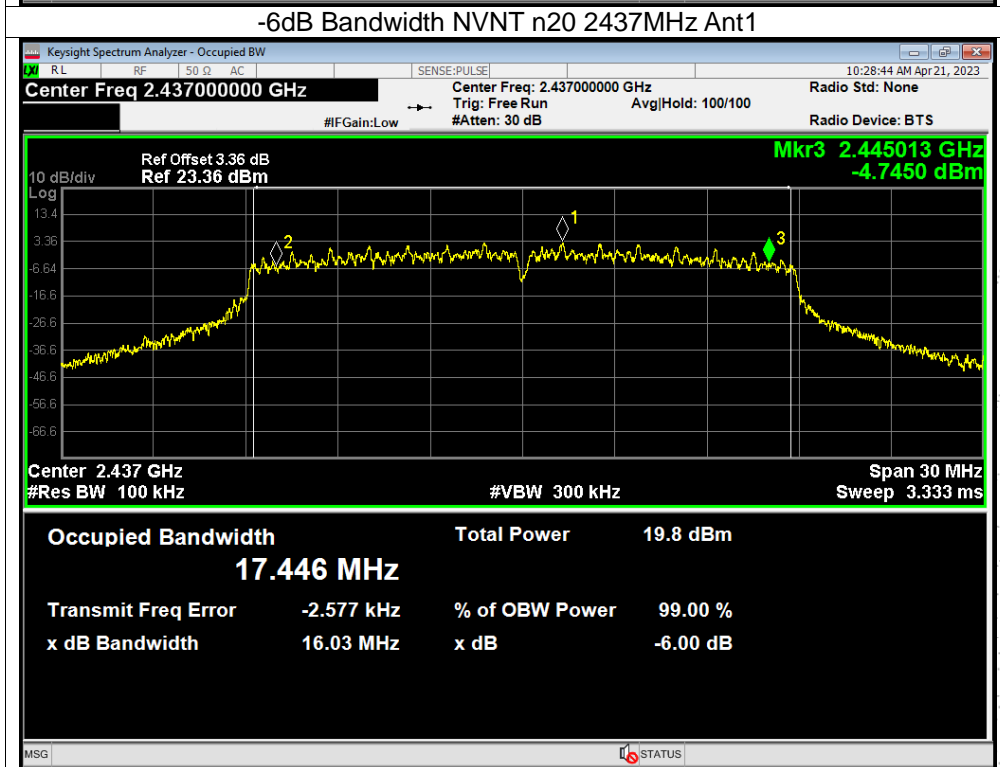
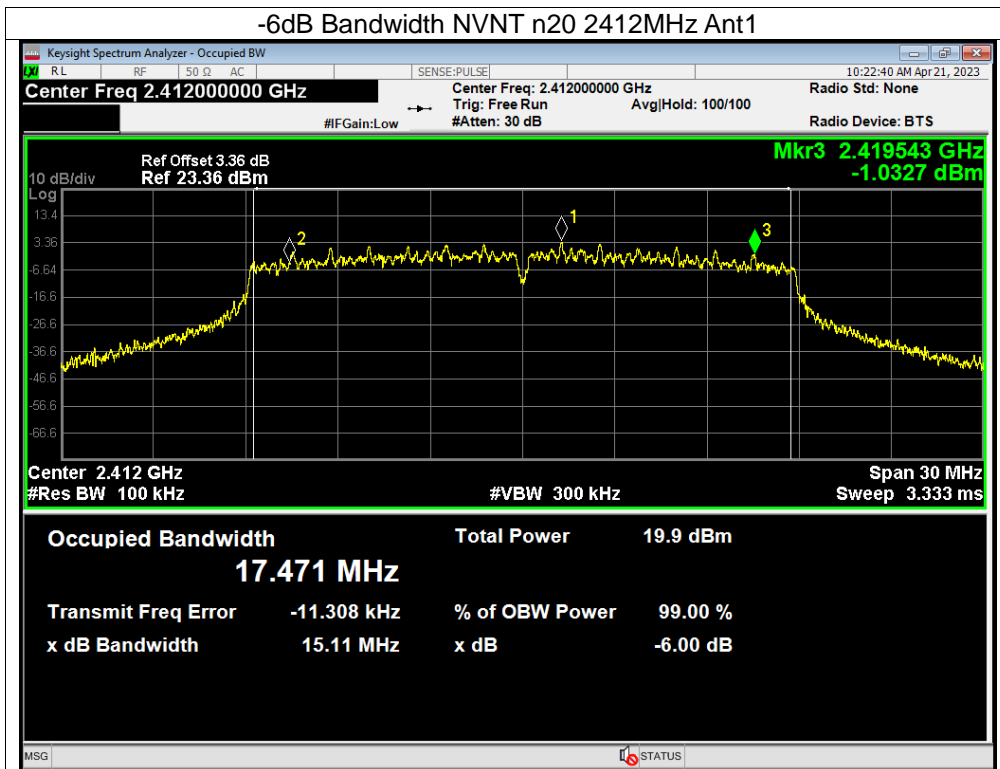

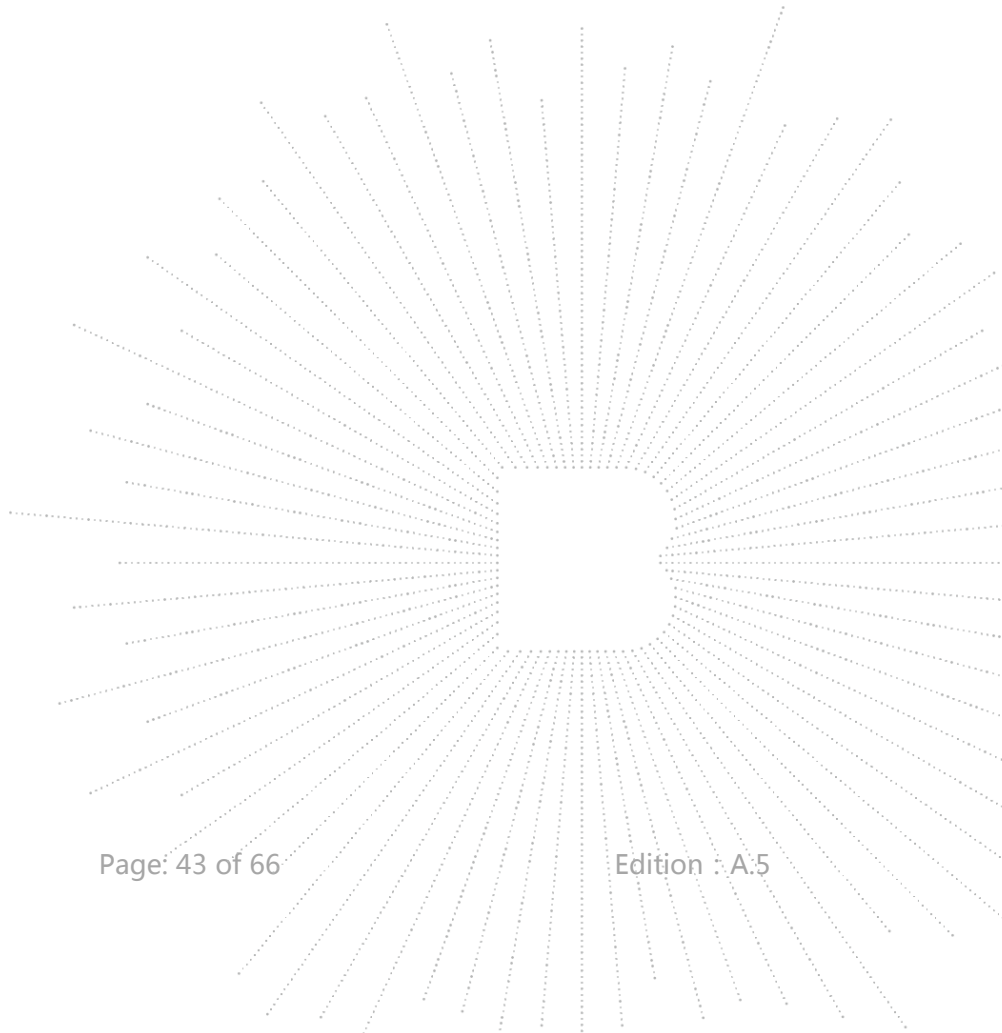
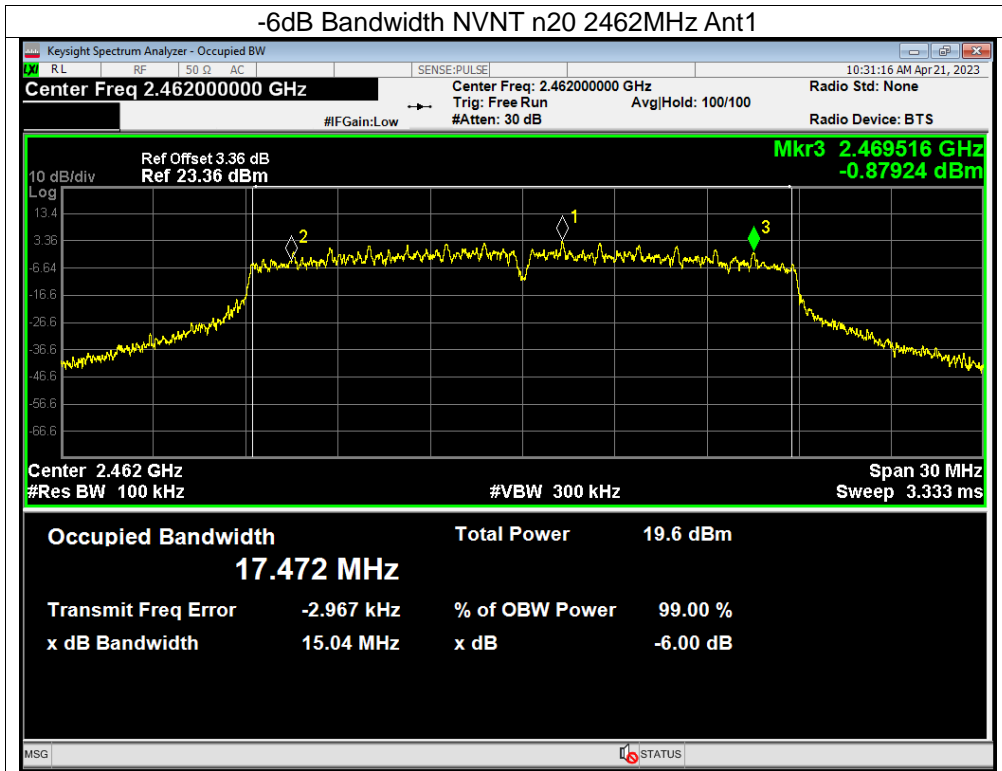

## 11. Peak Output Power Test

### 11.1 Block Diagram Of Test Setup



### 11.2 Limit

FCC Part15 (15.247) , Subpart C				
Section	Test Item	Limit	Frequency Range (MHz)	Result
15.247(b)(3)	Peak Output Power	1 watt or 30dBm	2400-2483.5	PASS

### 11.3 Test Procedure

- a. The EUT was directly connected to the Power meter

### 11.4 EUT Operating Conditions

The EUT tested system was configured as the statements of 4.6 Unless otherwise a special operating condition is specified in the follows during the testing.

Note: Power Spectral Density(dBm)=Reading+Cable Loss

## 11.5 Test Result

Temperature:	26 °C	Relative Humidity:	54%
Pressure:	101KPa	Test Voltage:	AC120V/60Hz

Test Mode	Frequency(MHz)	Maximum Conducted Output Power(PK) (dBm)	Limit (dBm)
802.11b	2412	19.97	30
	2437	19.90	30
	2462	19.70	30
802.11g	2412	18.98	30
	2437	18.96	30
	2462	18.67	30
802.11n20	2412	18.30	30
	2437	18.21	30
	2462	17.83	30

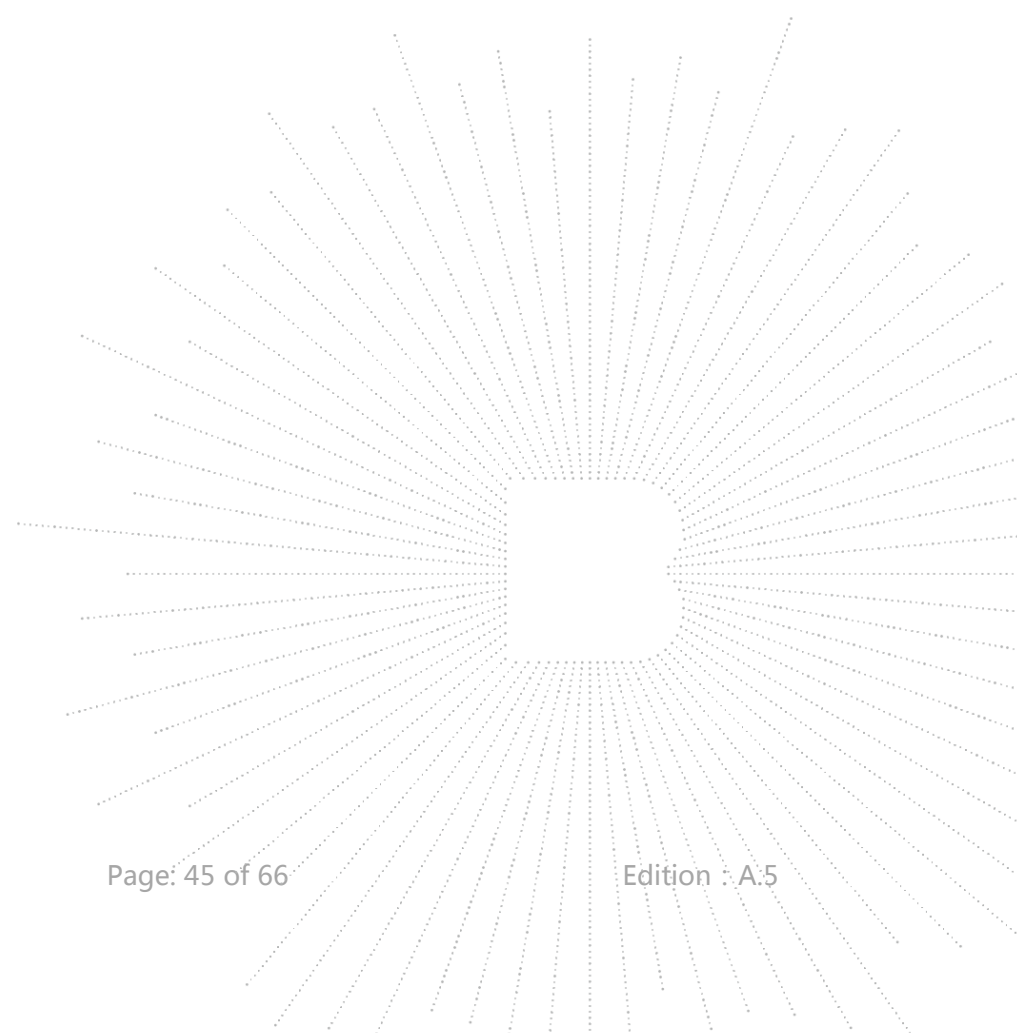

## 12. 100 kHz Bandwidth Of Frequency Band Edge

### 12.1 Block Diagram Of Test Setup

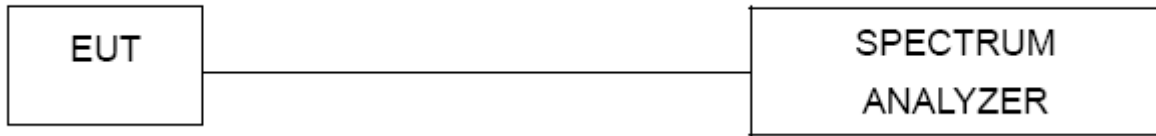

### 12.2 Limit

In any 100 kHz bandwidth outside the frequency band in which the spread spectrum intentional radiator is operating, the radio frequency power that is produced by the intentional radiator shall be at least 20 dB below that in the 100 kHz bandwidth within the band that contains the highest level of the desired power, based on either an RF conducted or a radiated measurement.

### 12.3 Test Procedure

Using the following spectrum analyzer setting:

- Set the RBW = 100KHz.
- Set the VBW = 300KHz.
- Sweep time = auto couple.
- Detector function = peak.
- Trace mode = max hold.
- Allow trace to fully stabilize..

### 12.4 EUT Operating Conditions

The EUT tested system was configured as the statements of 4.6 Unless otherwise a special operating condition is specified in the follows during the testing.

Note: Power Spectral Density(dBm)=Reading+Cable Loss

## 12.5 Test Result

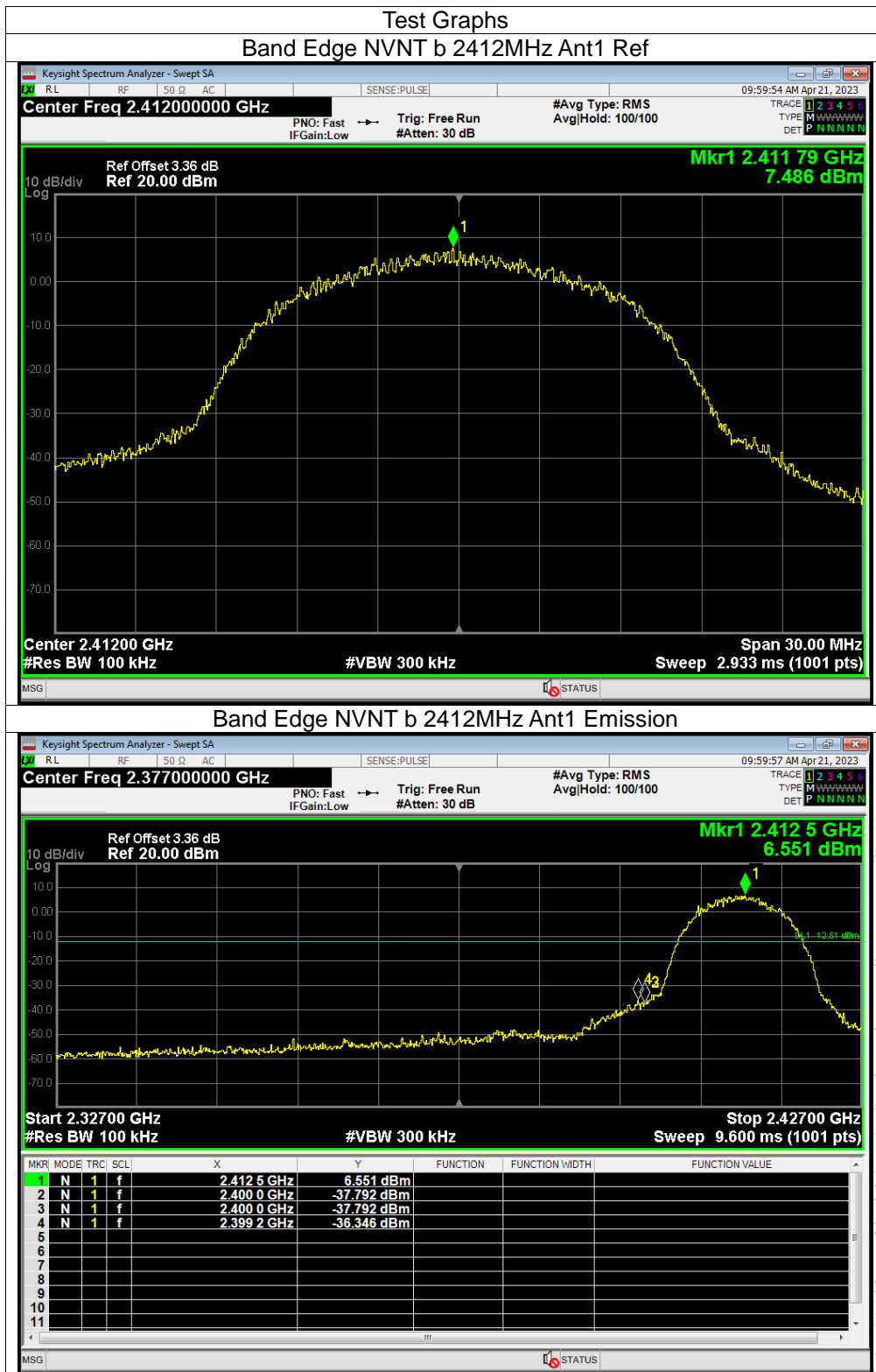

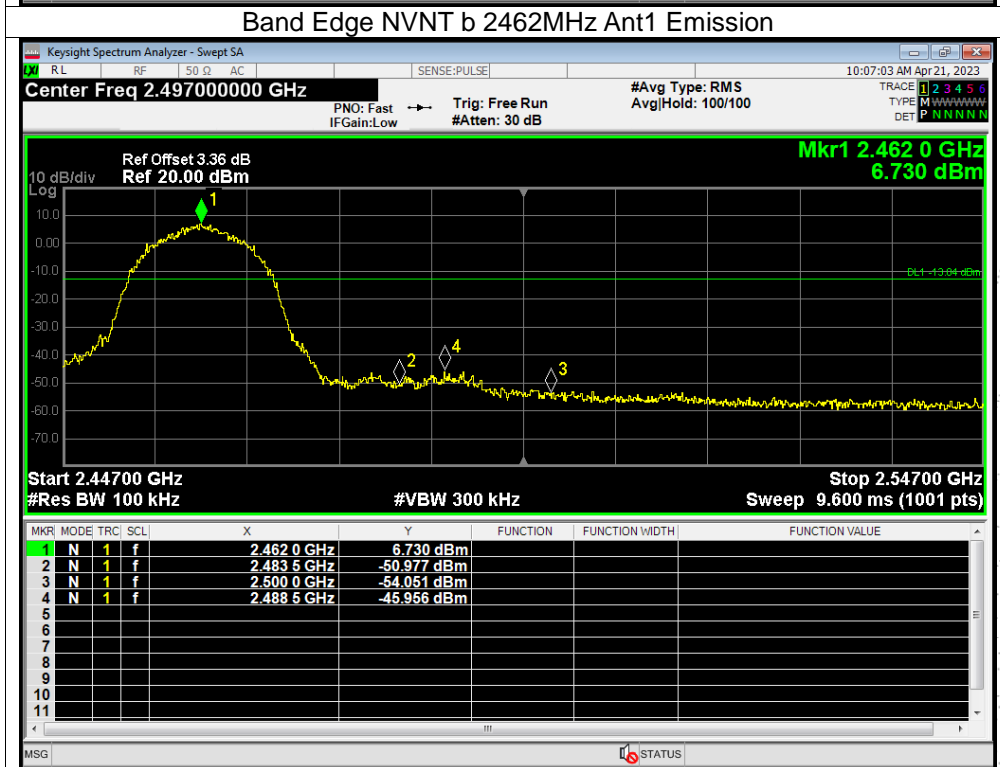
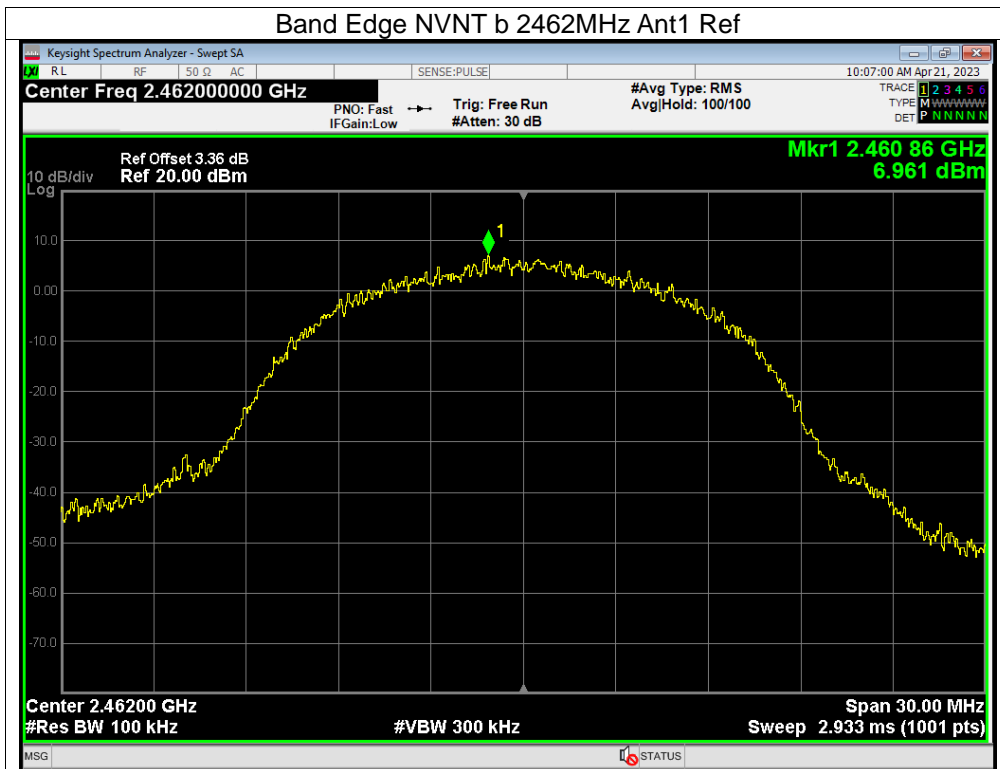



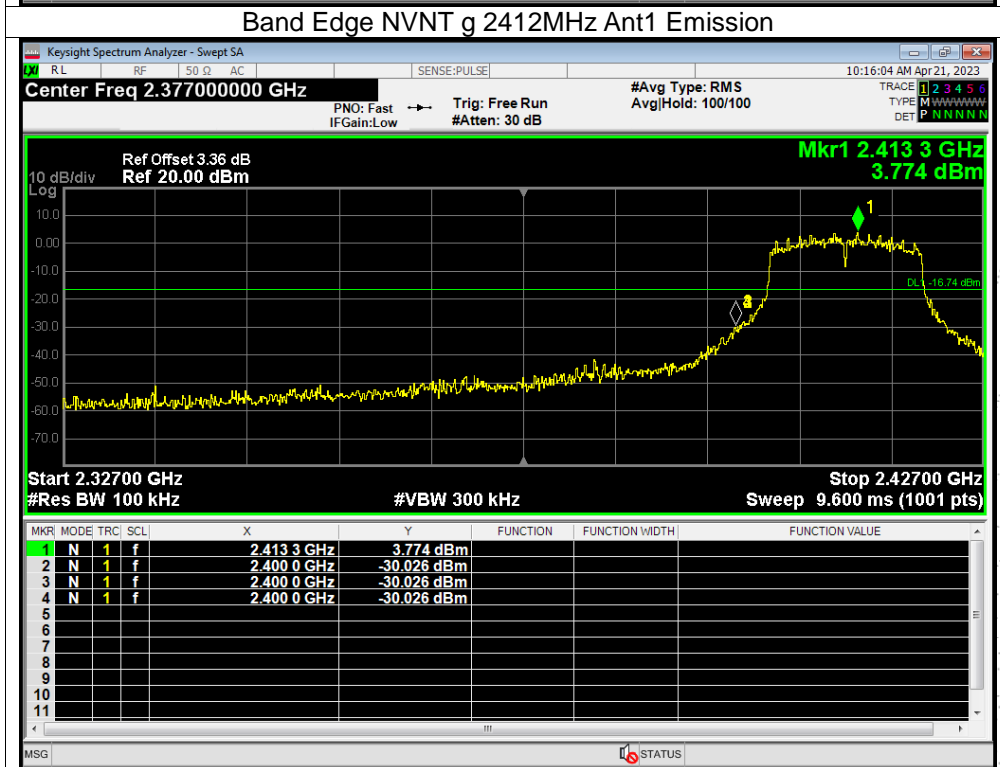
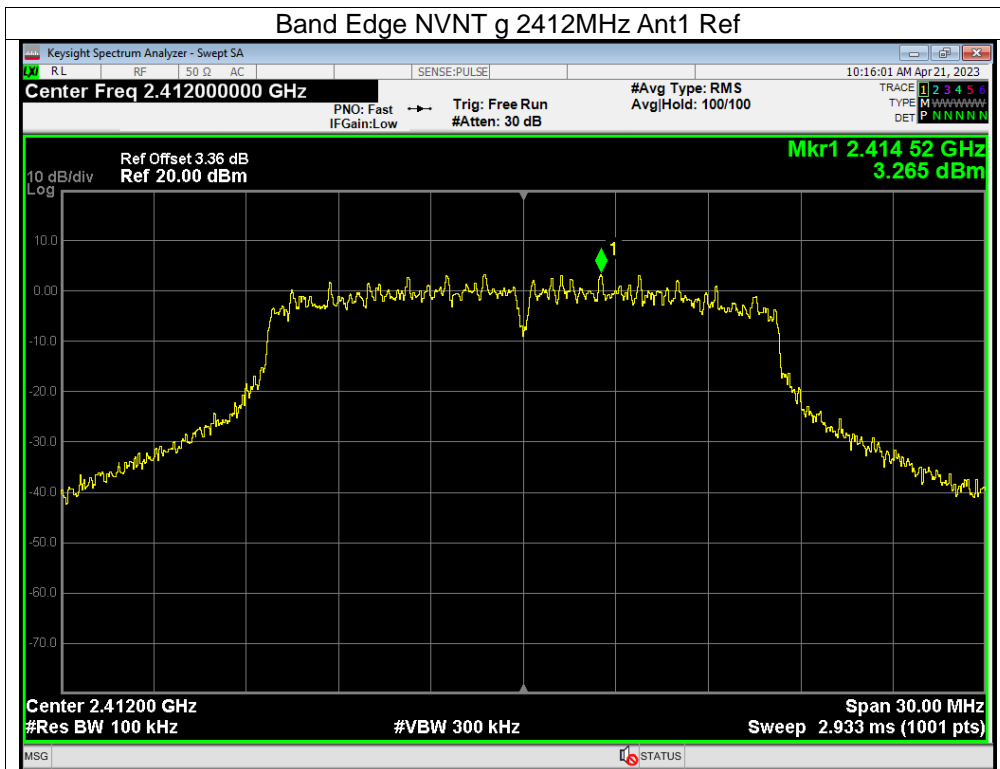

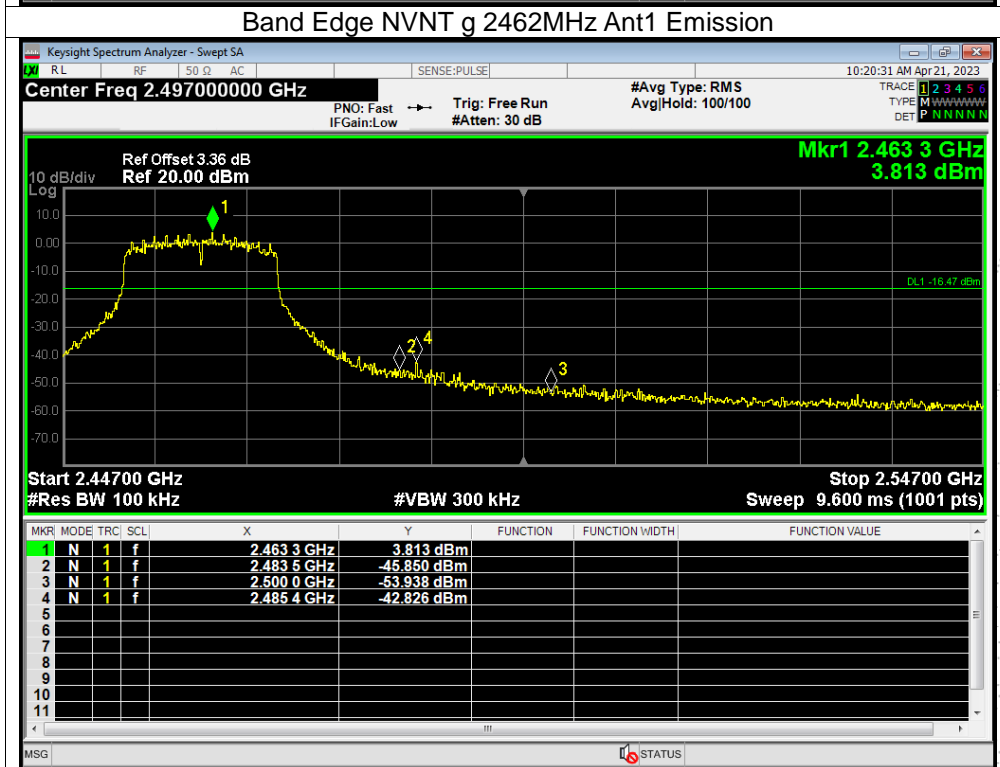
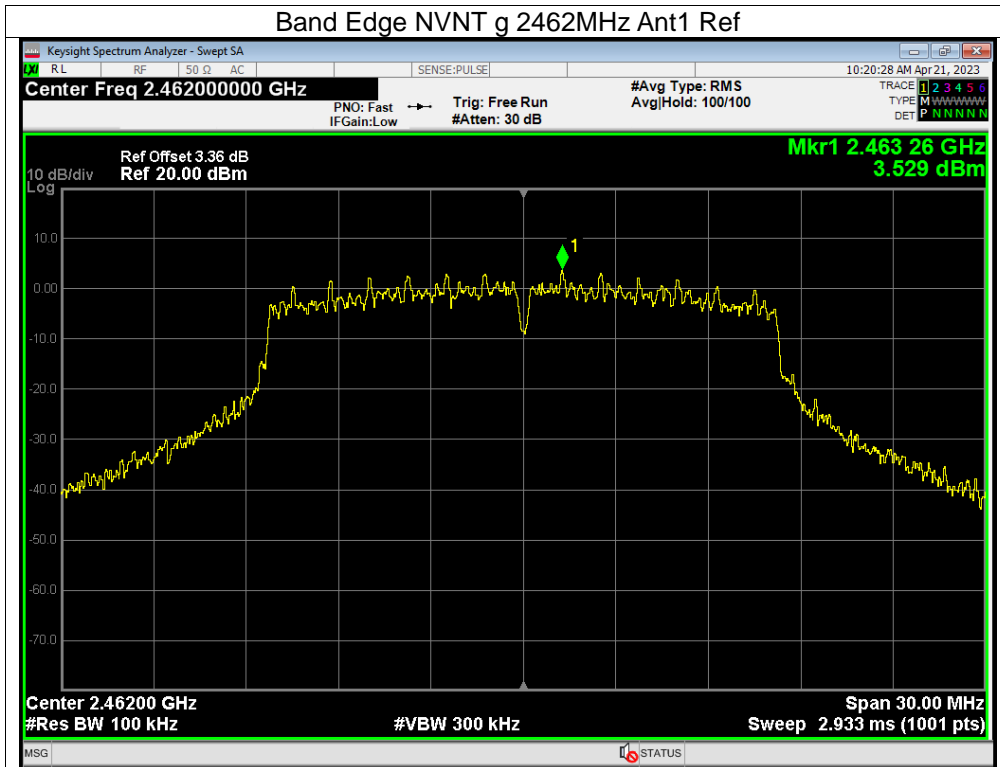

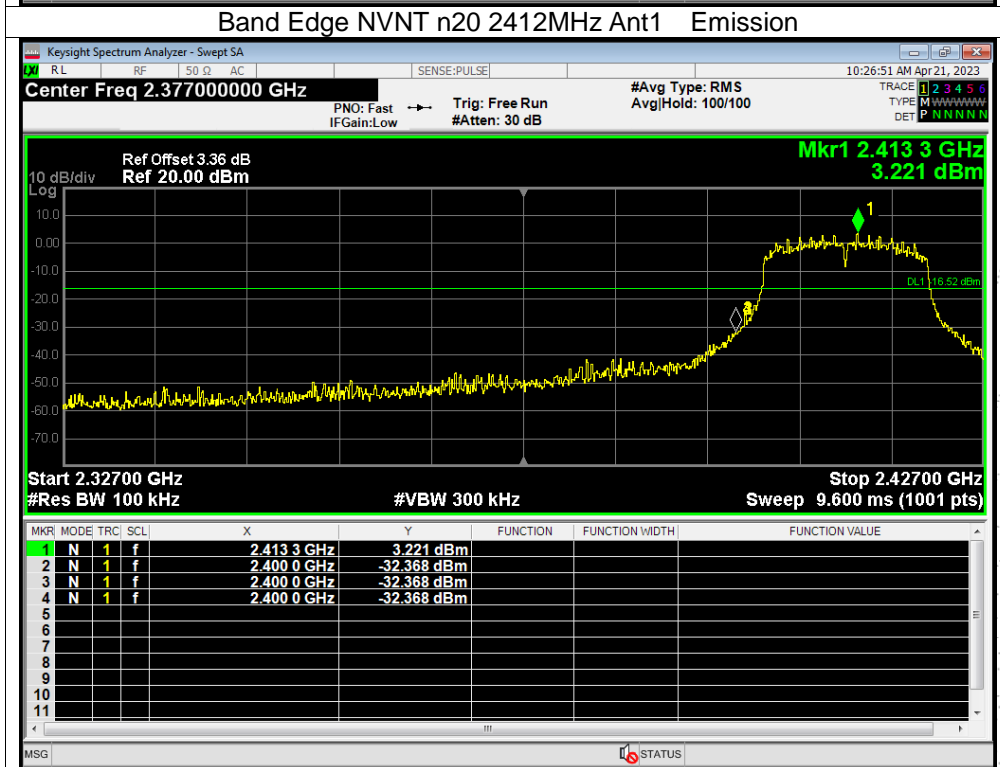
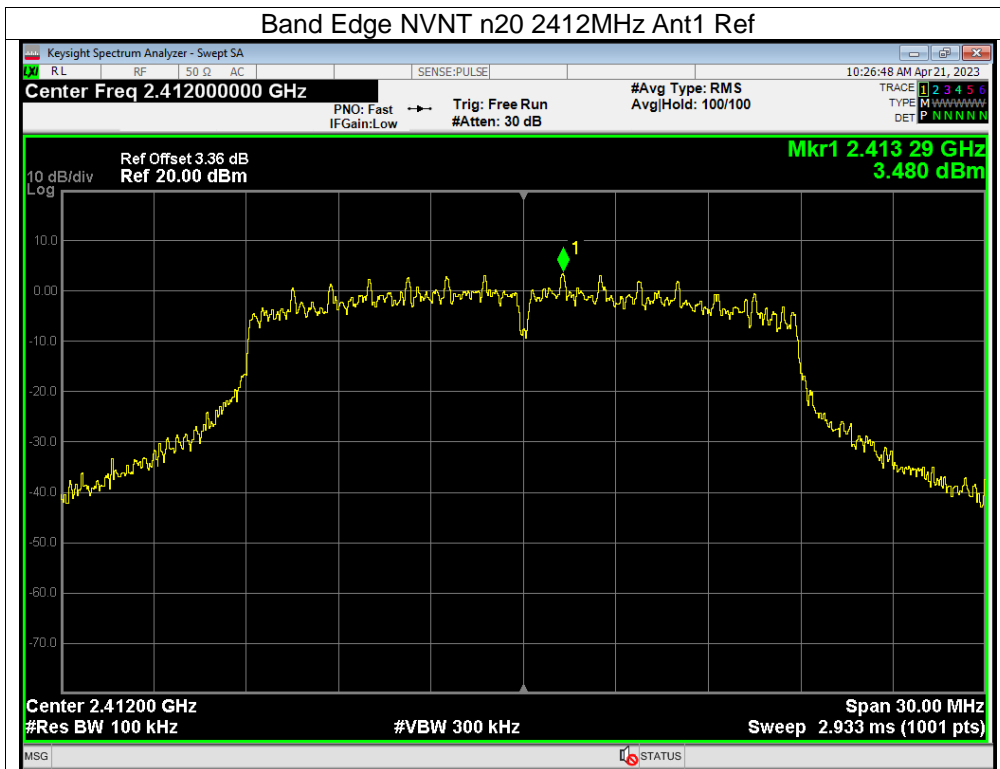

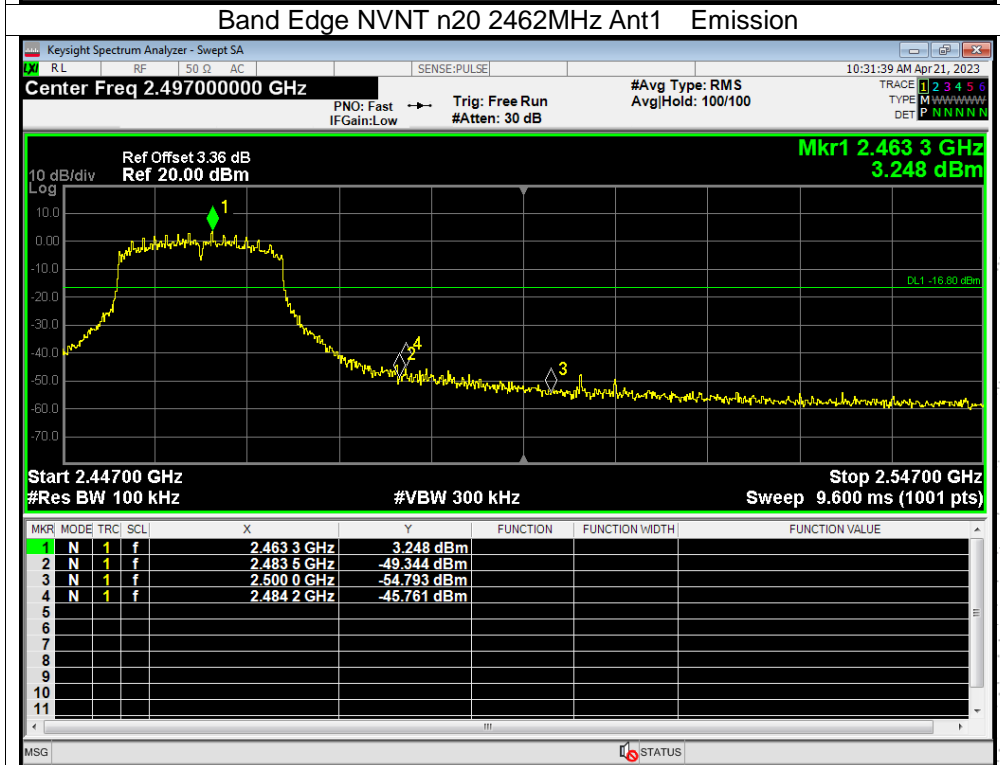
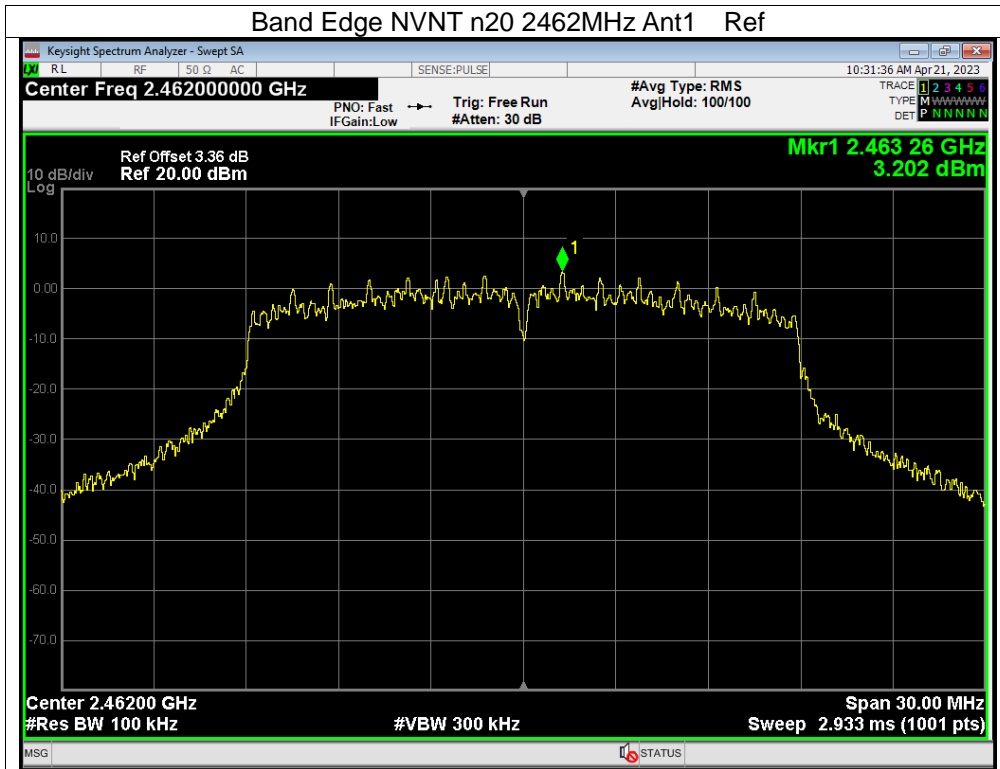

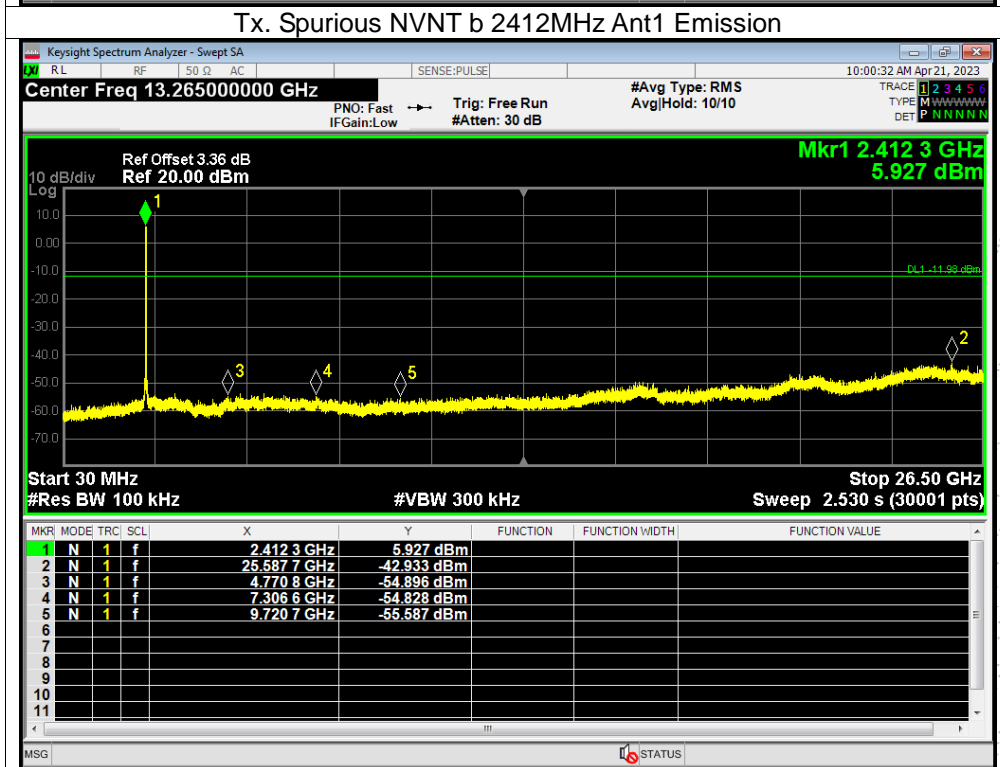
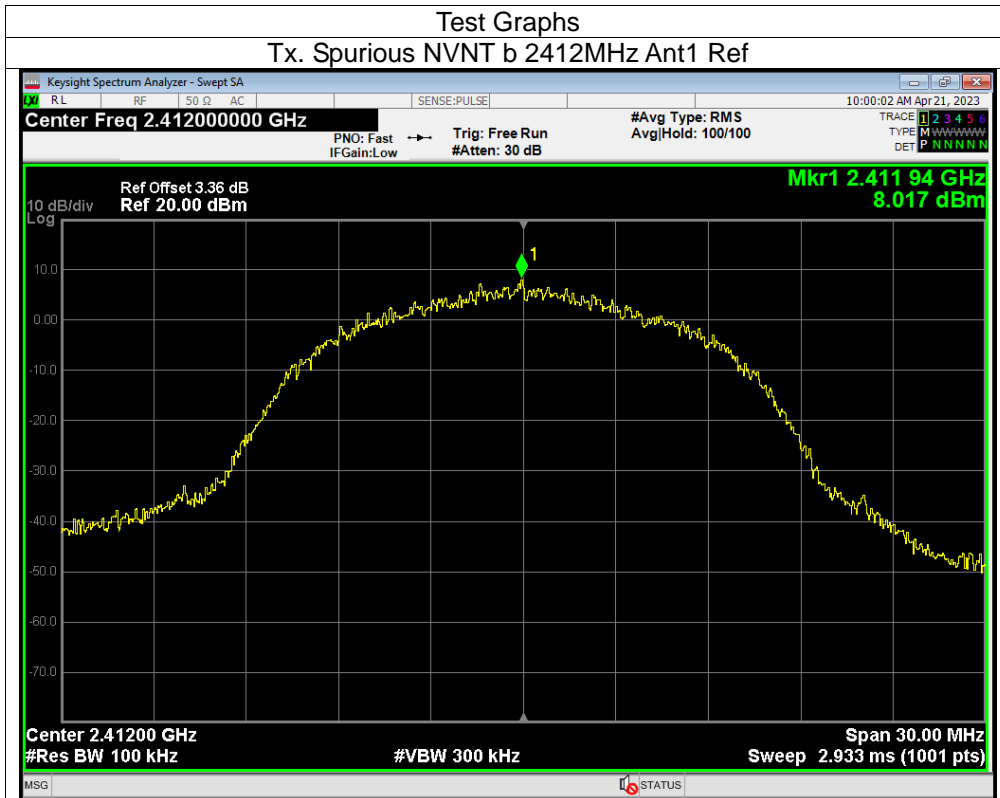

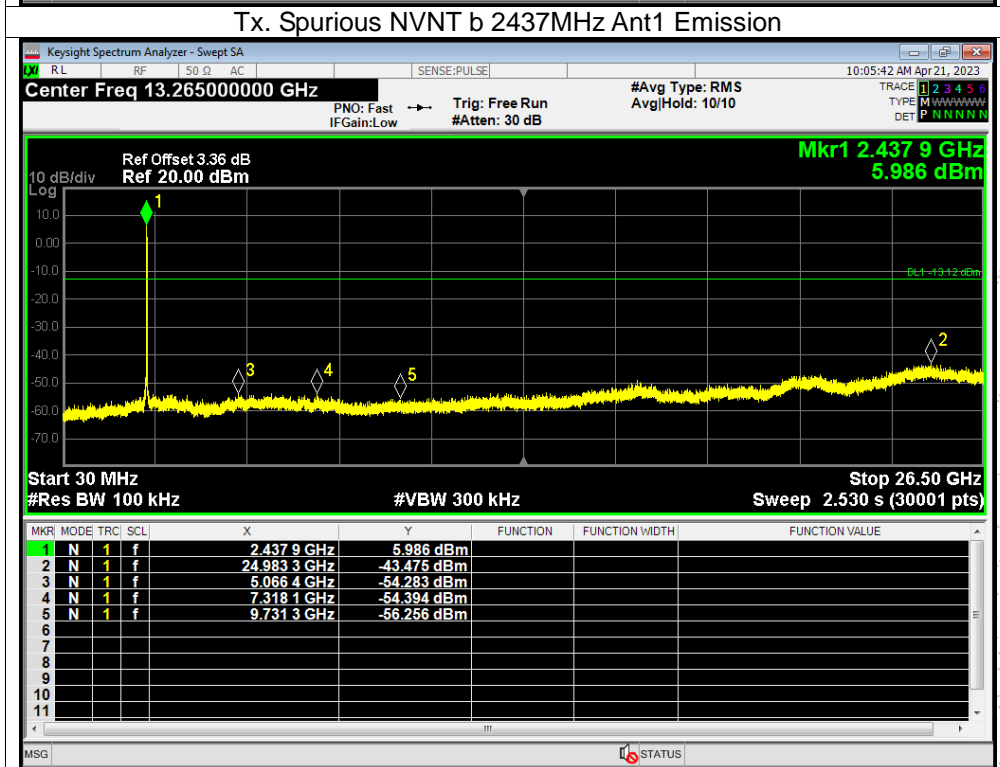
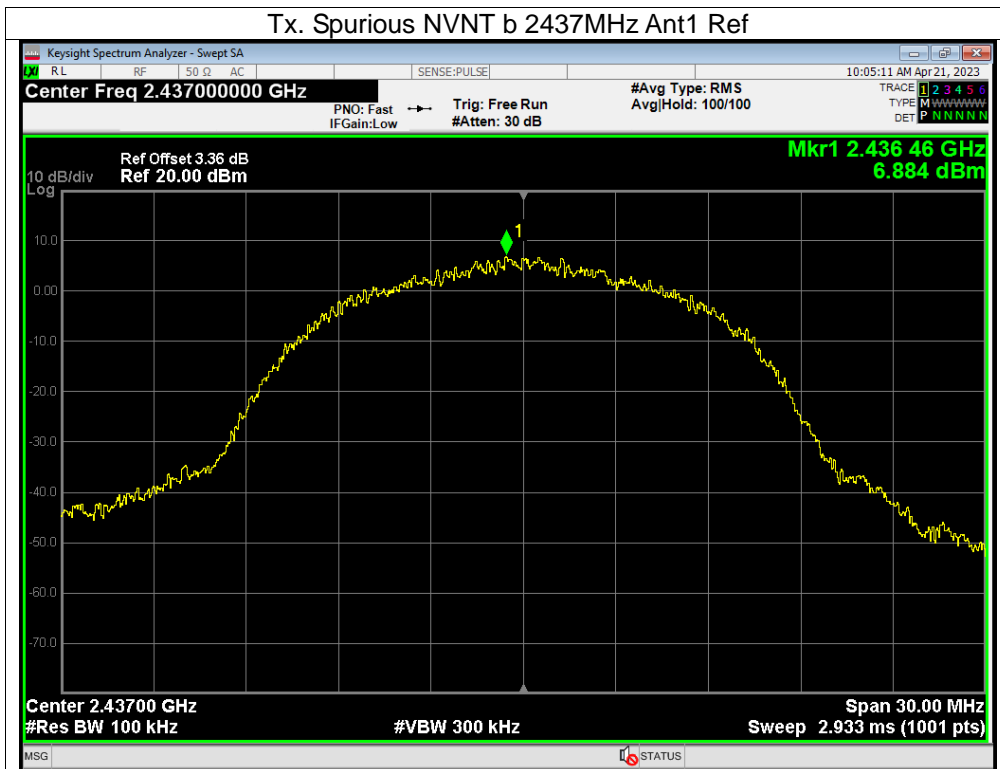

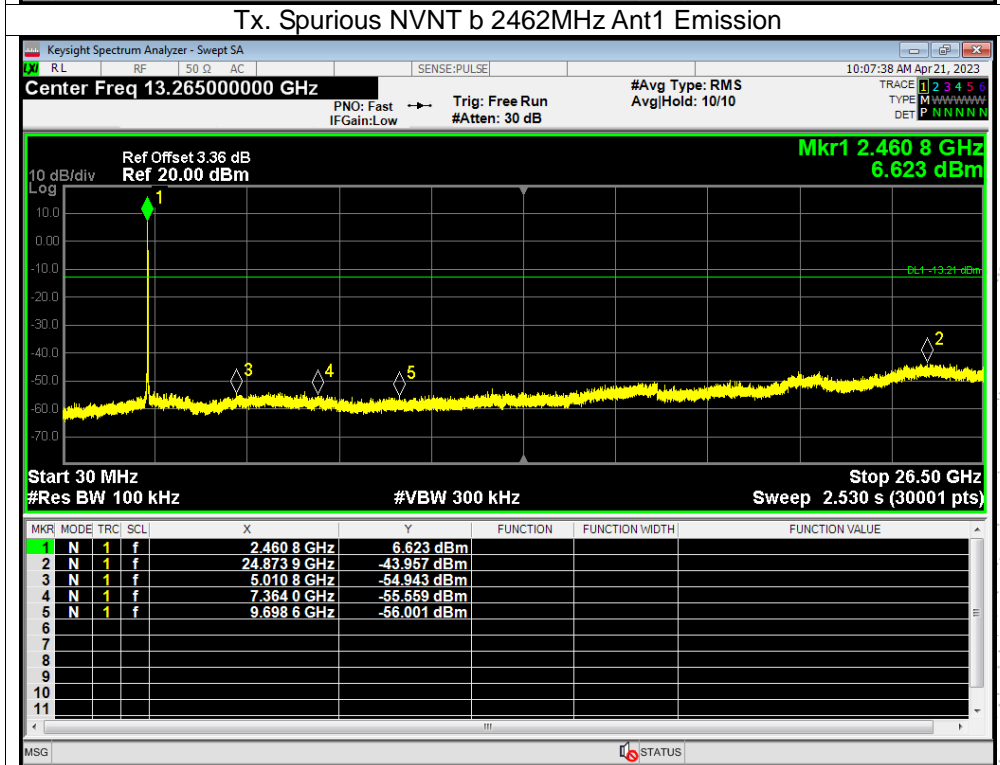
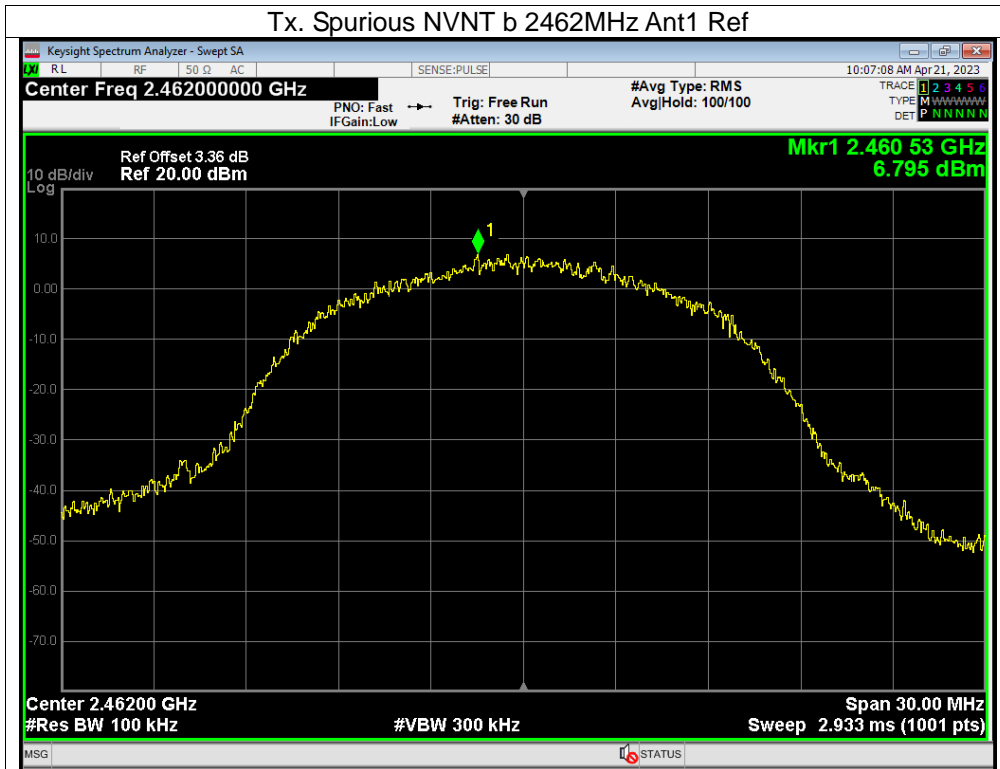

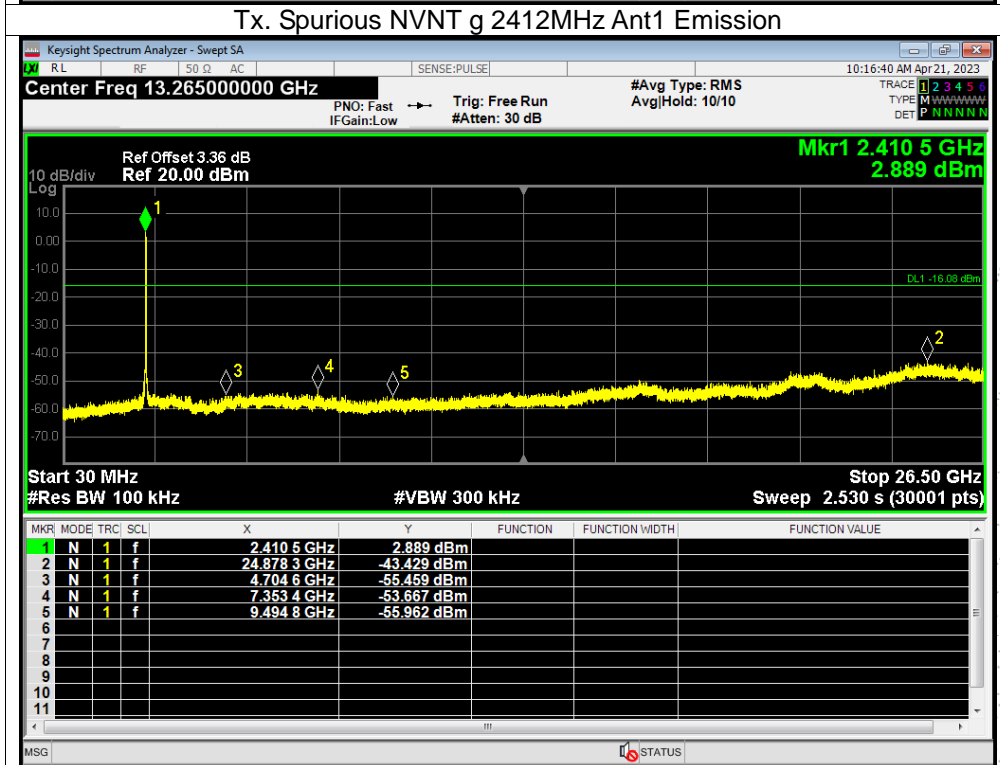
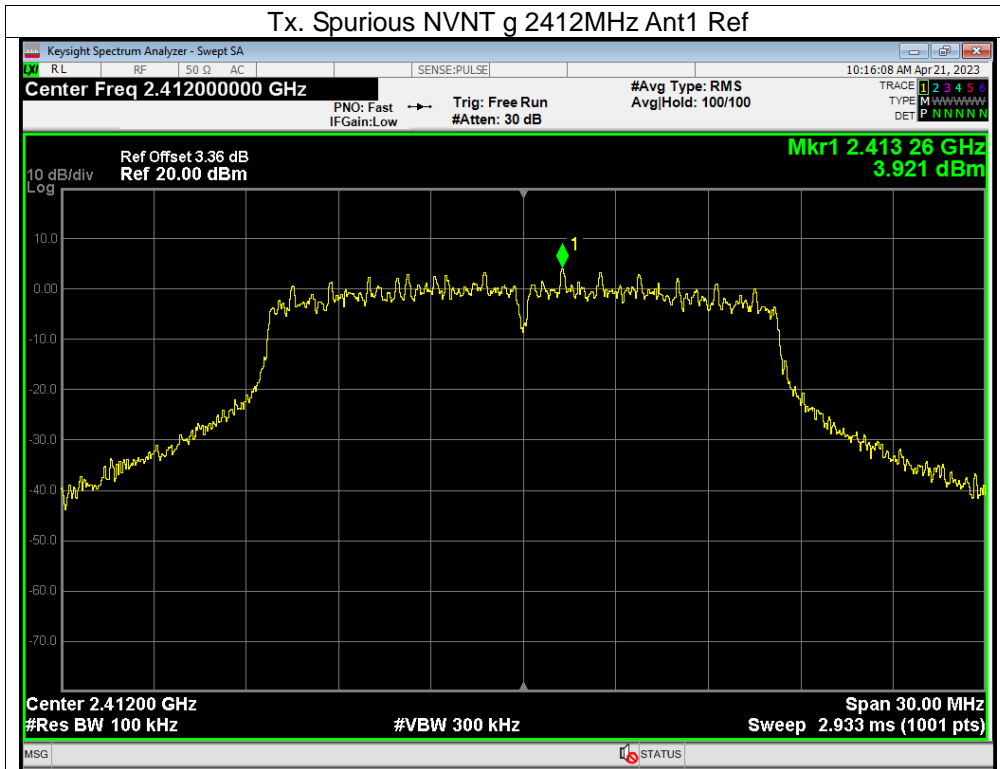



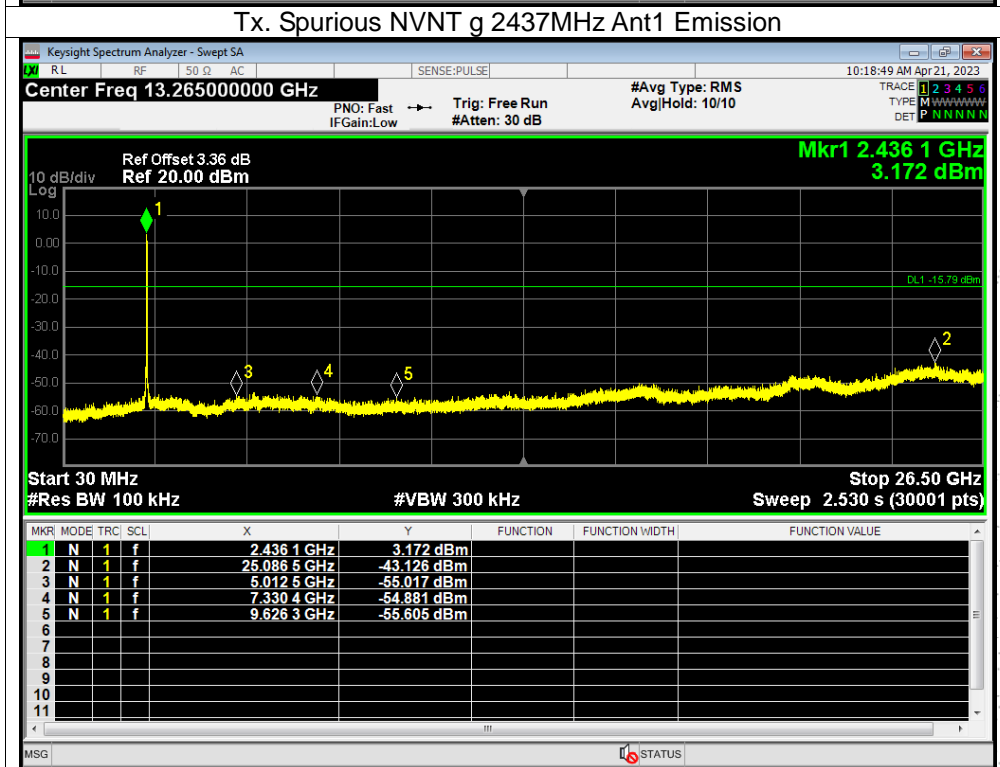
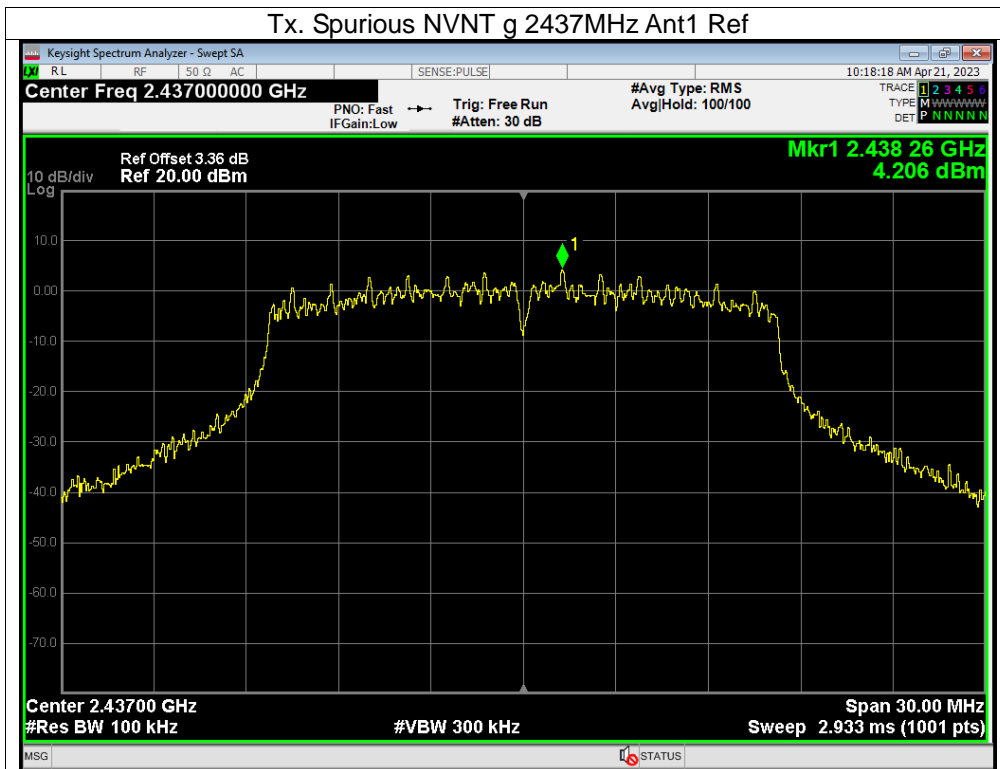

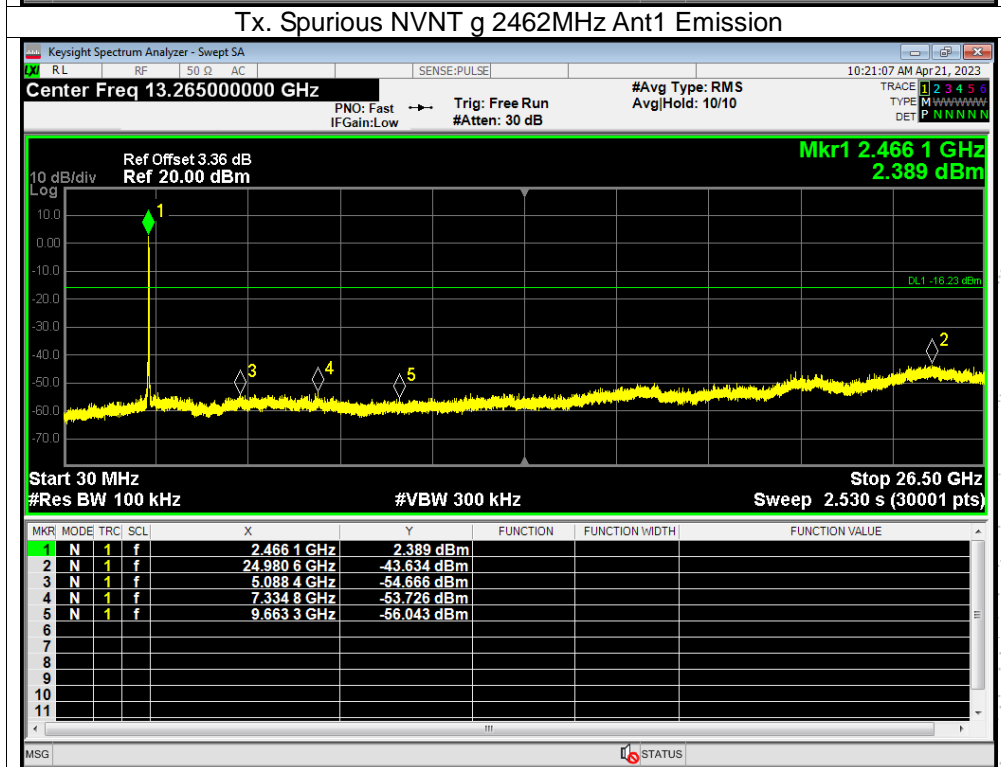
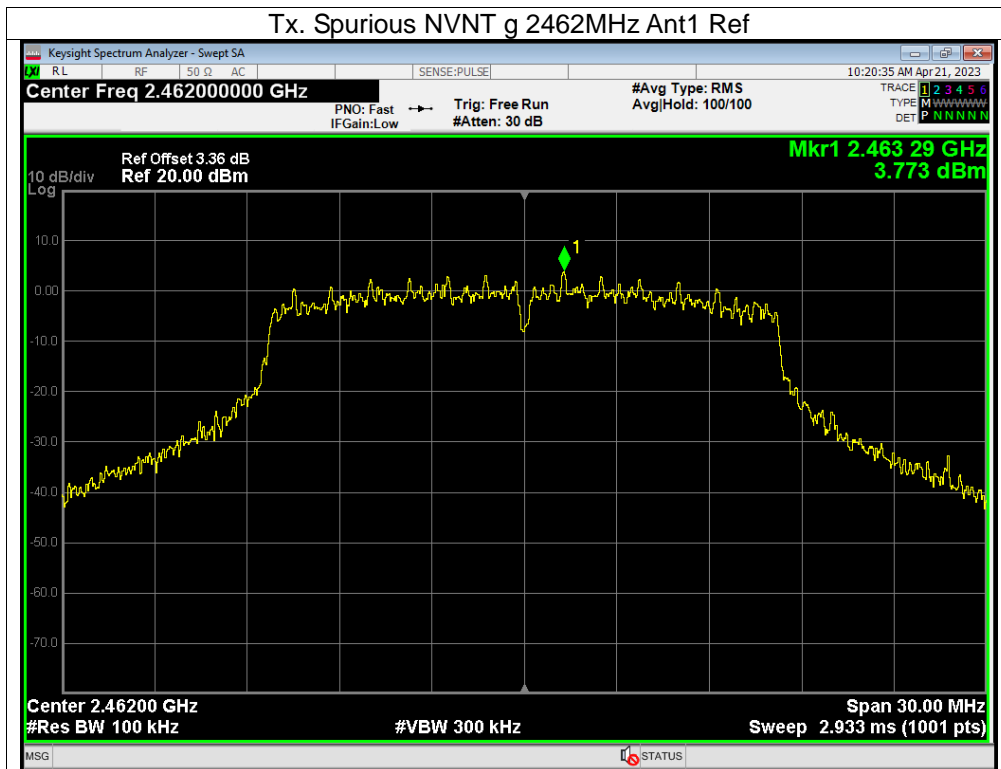

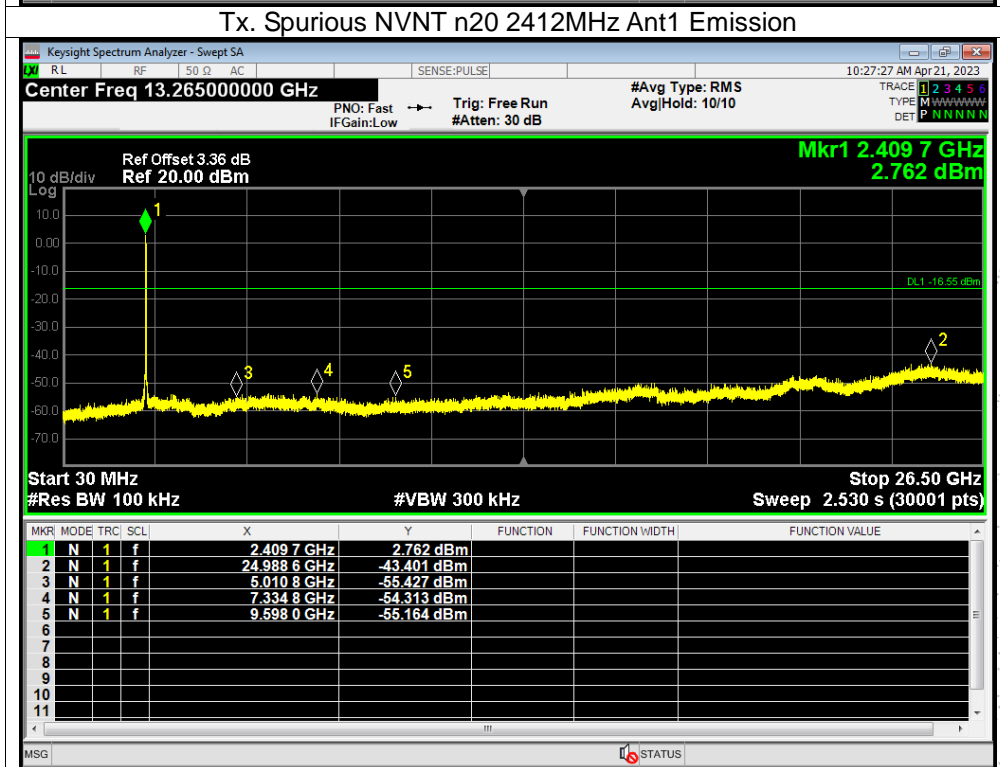
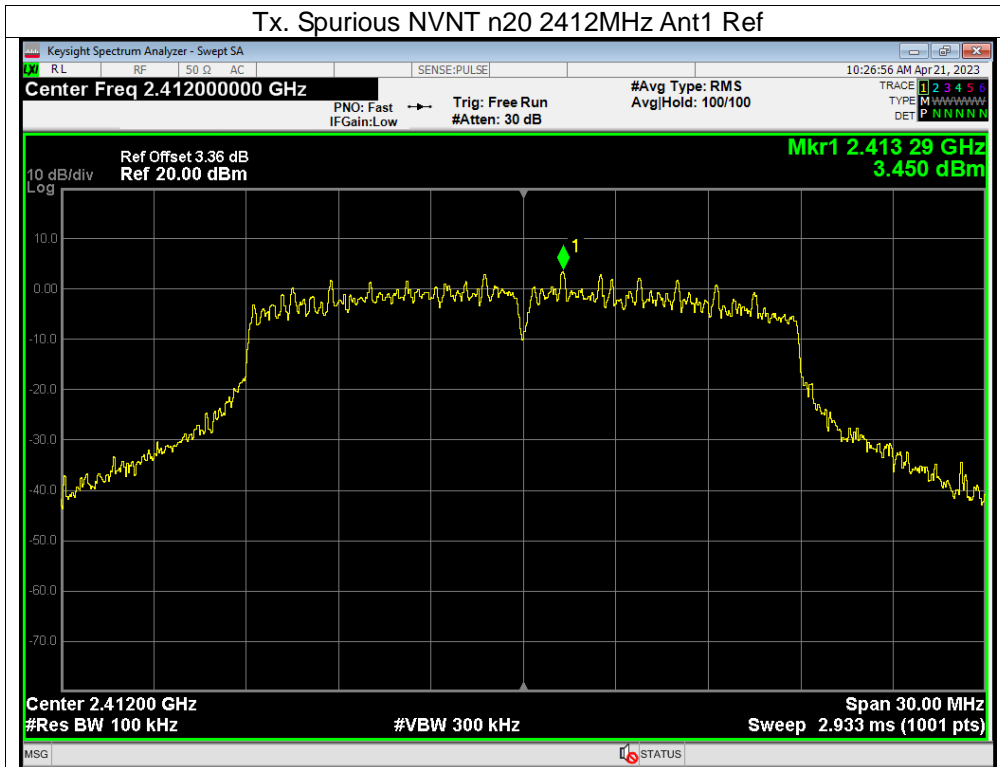

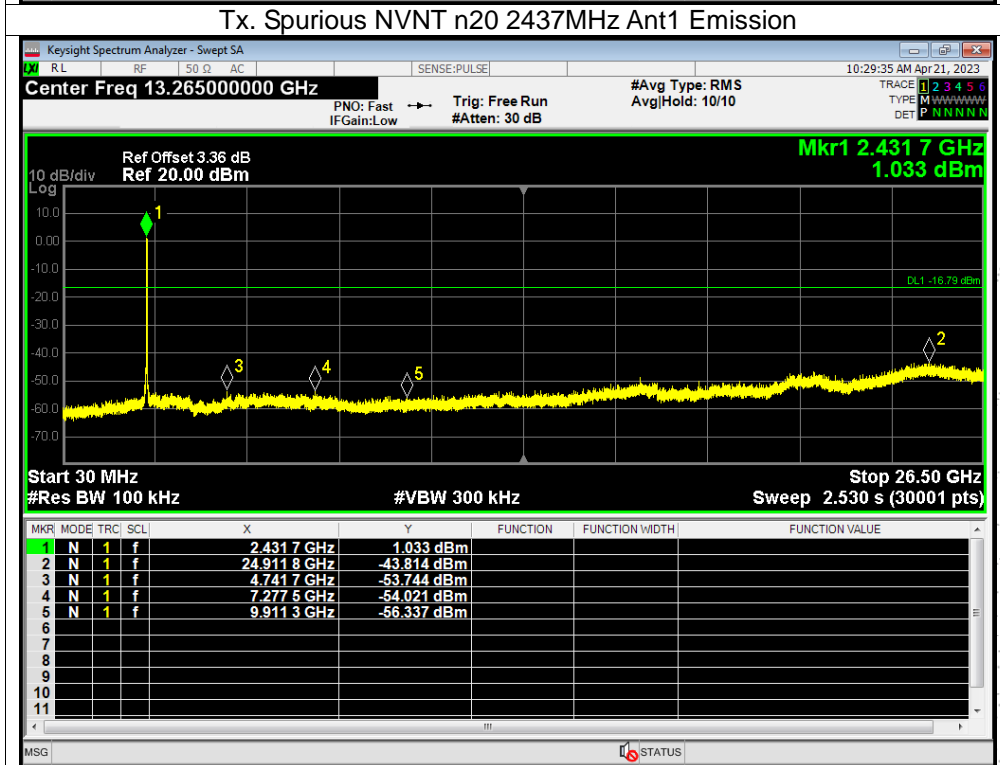
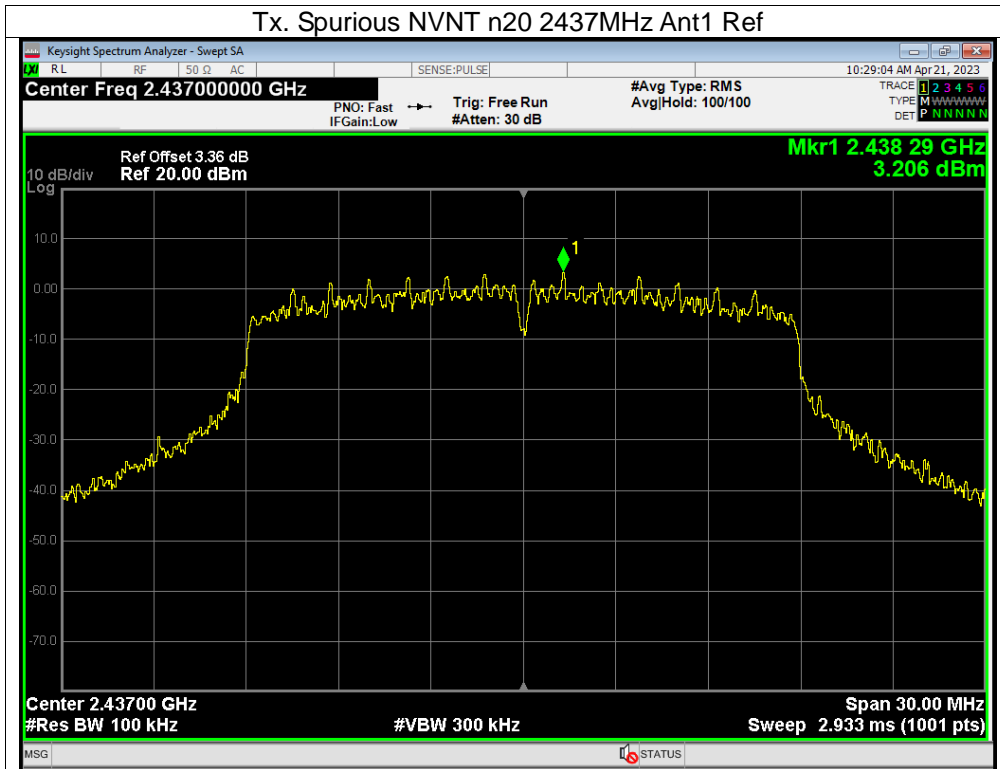

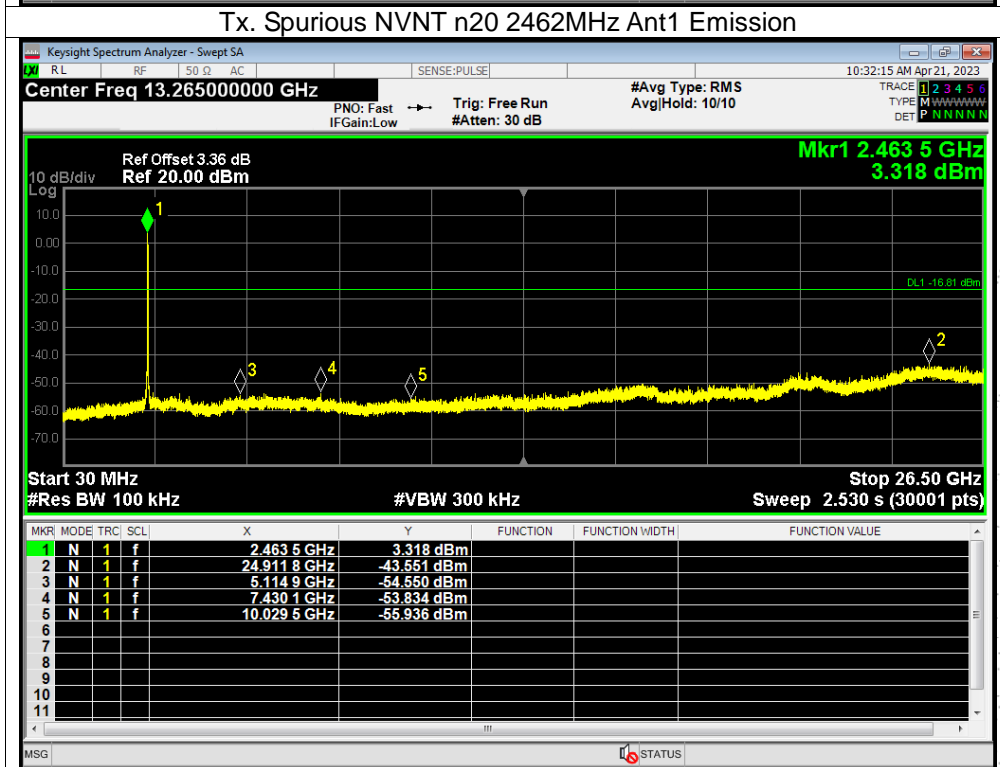
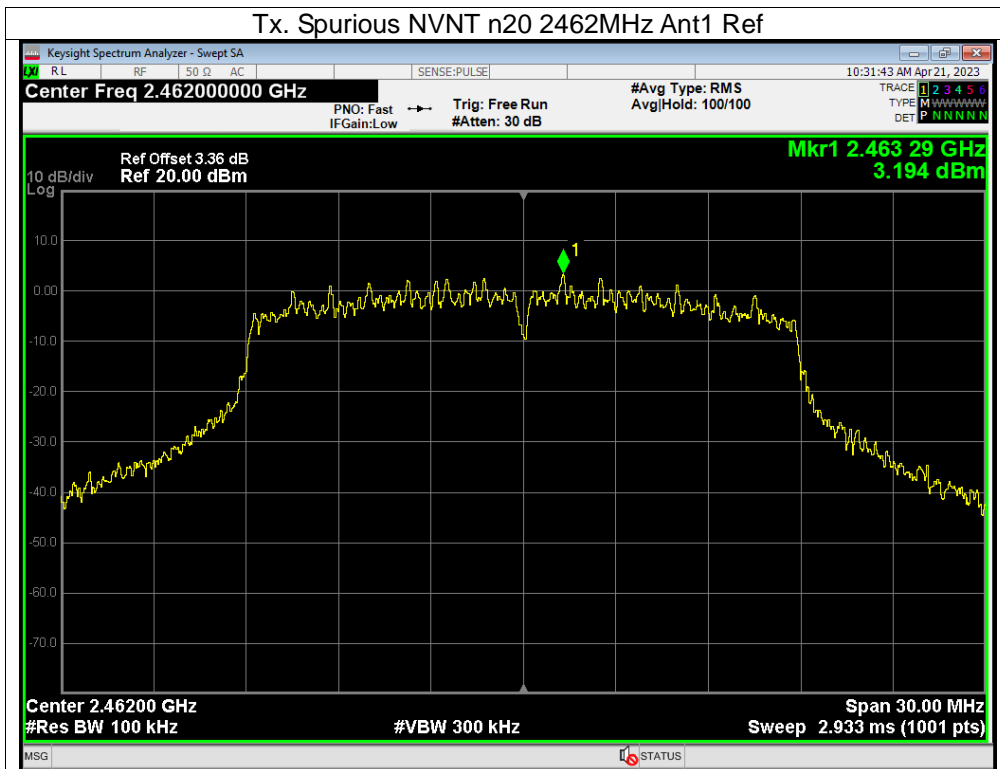

### 13. Duty Cycle Of Test Signal

#### 13.1 Standard Requirement

Pre-analysis Check: While conducting average power measurement, duty cycle of each mode shall be checked to ensure its duty cycle in order to compensate for the loss due to insufficient ratio of duty cycle.

All duty cycle is pre-scanned, and result as obtained below shows only the most representative ones where duty cycle is conducted as the given transmission with given virtual operation that expresses the percentage.

#### 13.2 Formula

$$\text{Duty Cycle} = T_{\text{on}} / (T_{\text{on}} + T_{\text{off}})$$

#### 13.3 Test Procedure

1. Set span = Zero
2. RBW = 8MHz
3. VBW = 8MHz,
4. Detector = Peak

#### 13.4 Test Result

Condition	Mode	Frequency (MHz)	Antenna	Duty Cycle (%)	Correction Factor (dB)	1/T (kHz)
NVNT	b	2412	Ant1	100	0	0
NVNT	b	2462	Ant1	100	0	0
NVNT	g	2412	Ant1	100	0	0
NVNT	g	2462	Ant1	100	0	0
NVNT	n20	2412	Ant1	100	0	0
NVNT	n20	2462	Ant1	100	0	0

## 14. Antenna Requirement

### 14.1 Limit

15.203 requirement: For intentional device, according to 15.203: an intentional radiator shall be designed to ensure that no antenna other than that furnished by the responsible party shall be used with the device.

### 14.1 Test Result

The EUT antenna is Internal antenna, non-removable; fulfill the requirement of this section.

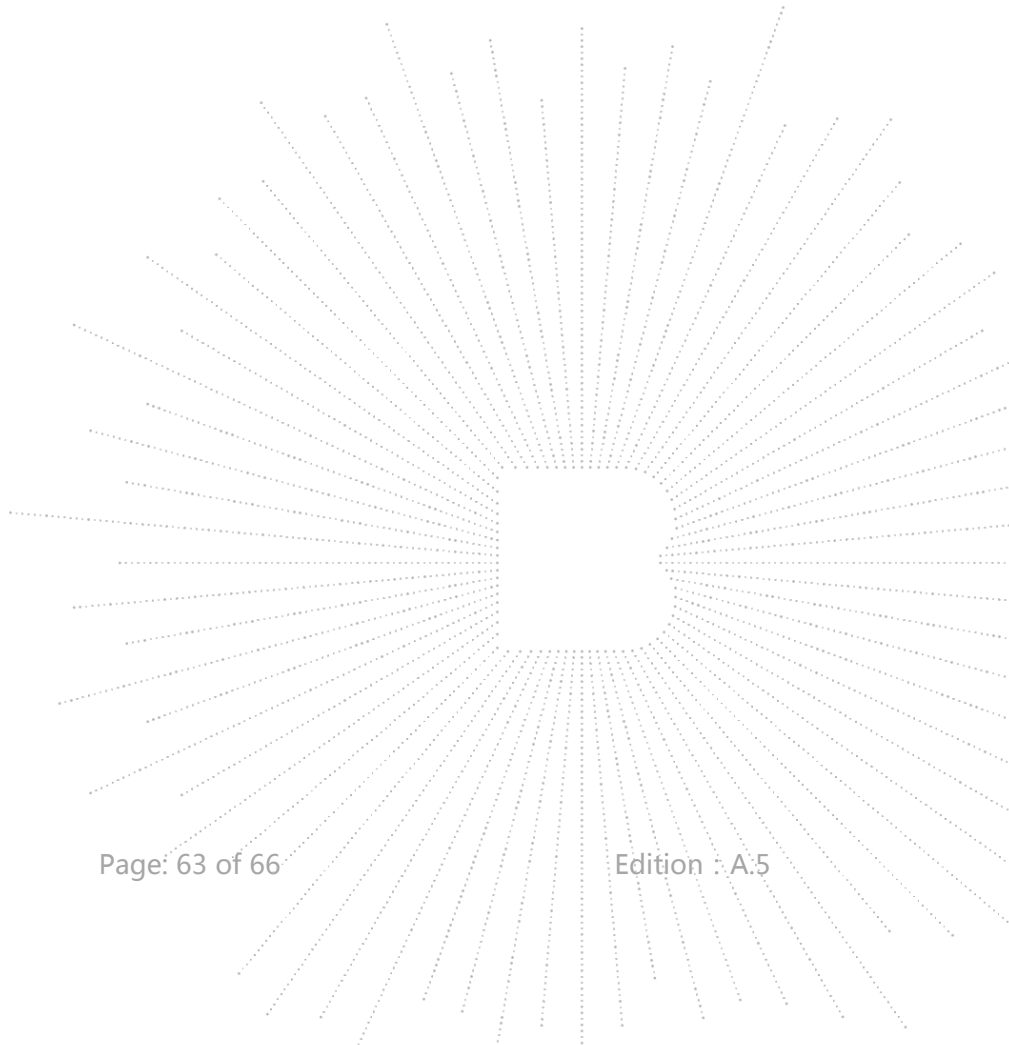

### 15. EUT Test Setup Photographs

Conducted emissions Photo

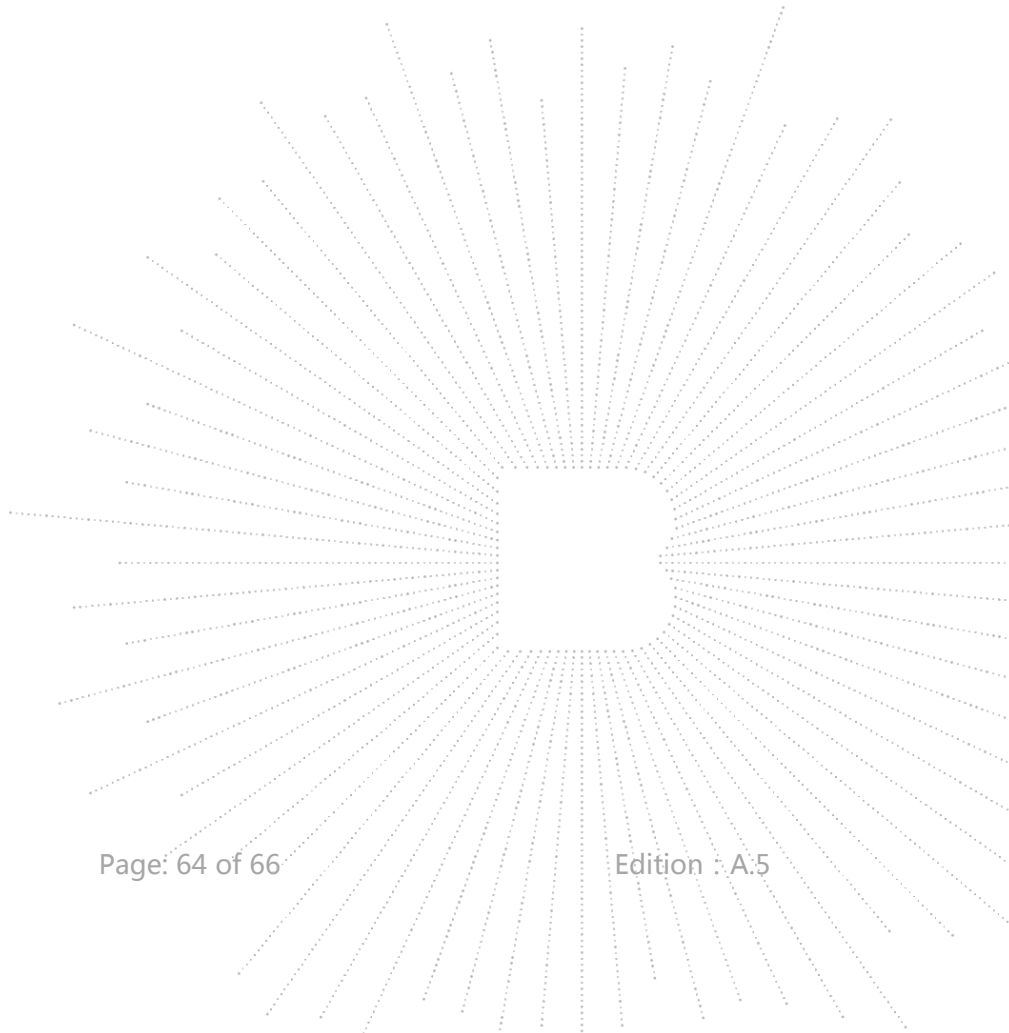



Radiated Measurement Photos

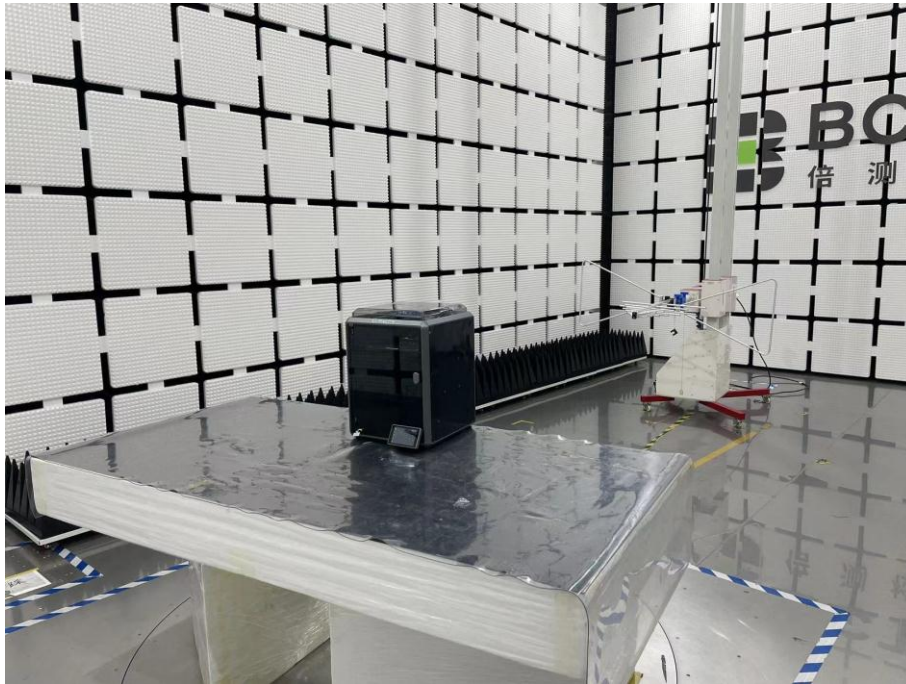

## STATEMENT

- 1.The equipment lists are traceable to the national reference standards.
- 2.The test report can not be partially copied unless prior written approval is issued from our lab.
- 3.The test report is invalid without stamp of laboratory.
- 4.The test report is invalid without signature of person(s) testing and authorizing.
- 5.The test process and test result is only related to the Unit Under Test.
- 6.The quality system of our laboratory is in accordance with ISO/IEC17025.
- 7.If there is any objection to report, the client should inform issuing laboratory within 15 days from the date of receiving test report.

Address:

1-2/F., Building B, Pengzhou Industrial Park, No.158, Fuyuan 1st Road, Zhancheng, Fuhai Subdistrict, Bao'an District, Shenzhen, Guangdong, China

TEL : 400-788-9558

P.C.: 518103

FAX : 0755-33229357

Website : <http://www.chnbctc.com>

E-Mail : [bctc@bctc-lab.com.cn](mailto:bctc@bctc-lab.com.cn)

\*\*\*\*\* END \*\*\*\*\*