

4.About the Power-on Guide and User Interface



Set

Customer Service

Error Code	Time of Occurrence	Operate
3002	2023/02/06 17:06:45	Details
3001	2023/02/05 09:52:33	Details
3007	2023/02/04 23:50:08	Details
3006	2023/02/03 16:36:06	Details

The current interface is for reference only. Due to the continuous upgrading of functions, it shall be subject to the latest software/firmware UI published on the official website.

* You can configure functions such as system and network settings through the settings interface.

* You can view FAQs, manuals, error history and upload Log through the customer service interface.

5. First Printing

5.1 Filament Loading

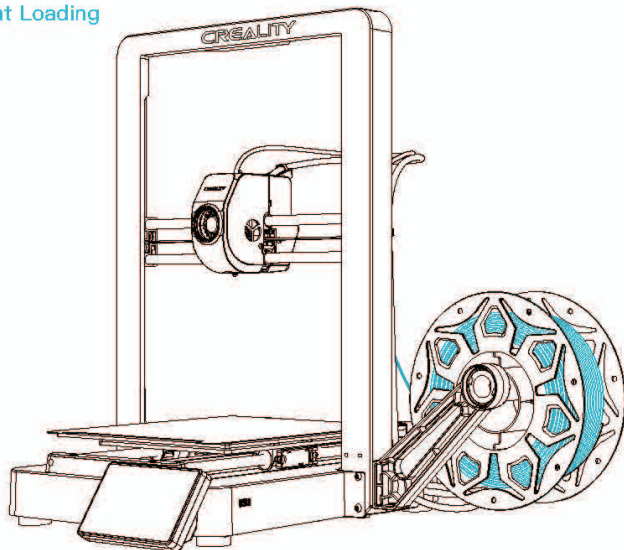

① Input the nozzle temperature on the screen and wait for it to heat up to the target temperature;

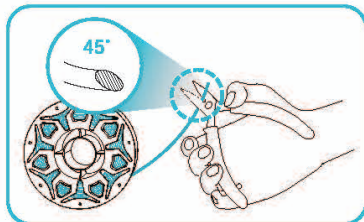

② Cut the front of the filament at 45° and break it off straight;

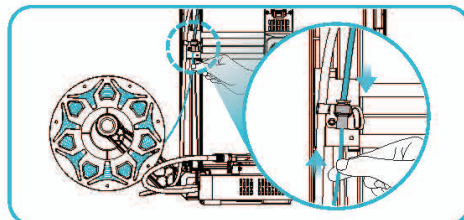

③ Arrange the filaments according to the illustration, then connect the Teflon tube, insert the filaments into the Teflon tube until they protrude from the other end;

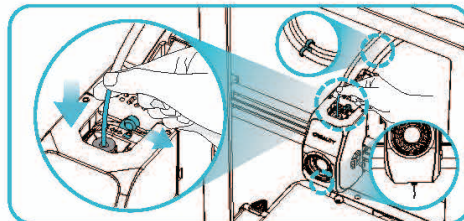

④ Secure the Teflon tube and nozzle cable using the cable clamp, unlock the dip switch and thread the filaments into the nozzle kit until the filaments are extruded from the nozzle;

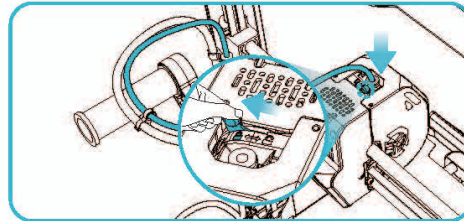

⑤ Lock the dip switch, and then insert the Teflon tube into the connector above the nozzle kit.

5.First Printing

5.2 LAN printing

- ✧ Install Creality Print slicing software by opening the random data on the USB flash disk.
- ✧ Log in to the official website to download for installation: <https://www.crealitycloud.com/software-firmware/software?type=7>

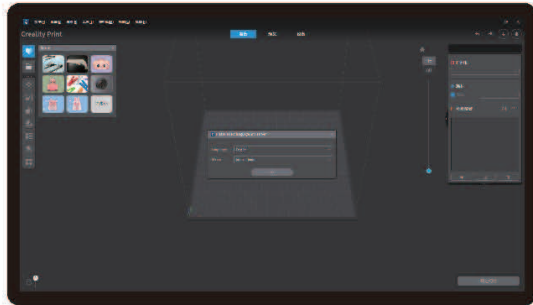

① Select "Language" and "Server"

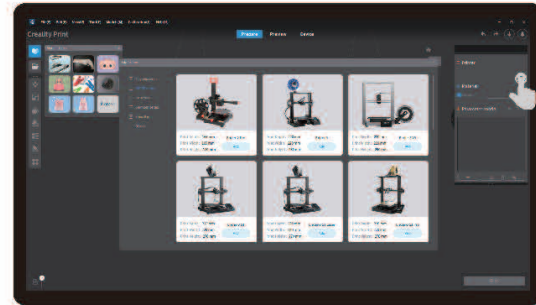

② Add the printer

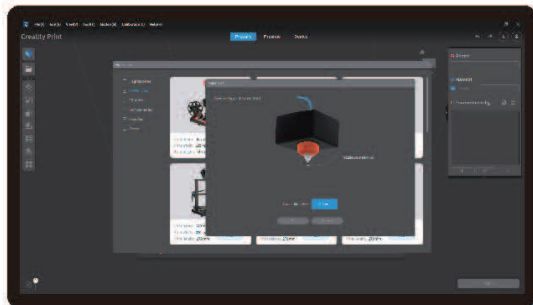

③ Confirm the nozzle diameter

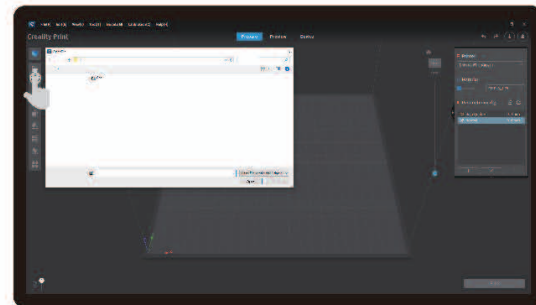

④ Import model files



The current interface is for reference only. Due to the continuous upgrading of functions, it shall be subject to the latest software/–firmware UI published on the official website.

5.First Printing

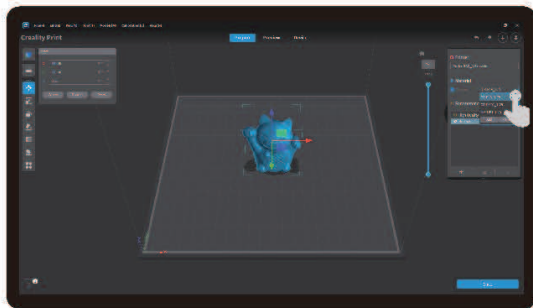

⑤ Set up material type

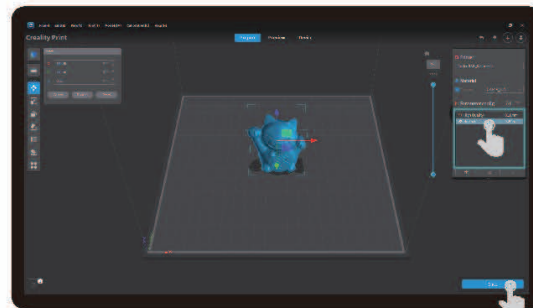

⑥ Set the print layer height and click on "Slice"

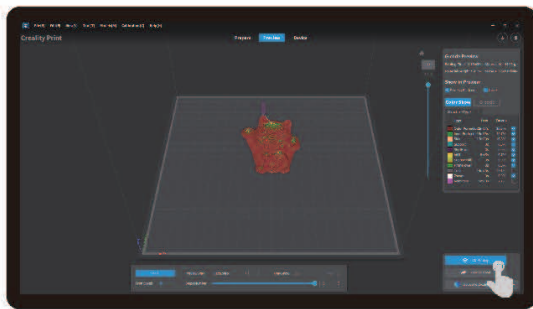

⑦ After slicing is done, click on "LAN printing"

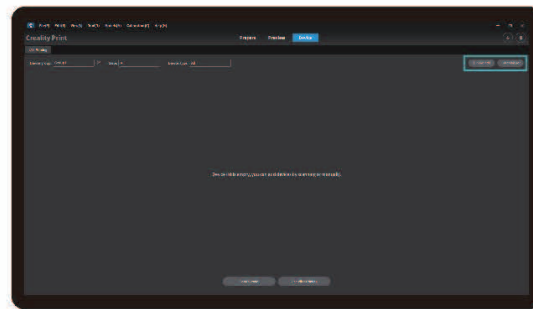

⑧ Add equipment: can be added either by "Scan Add" or "Manual Add".



The current interface is for reference only. Due to the continuous upgrading of functions, it shall be subject to the latest software/-firmware UI published on the official website.

5.First Printing

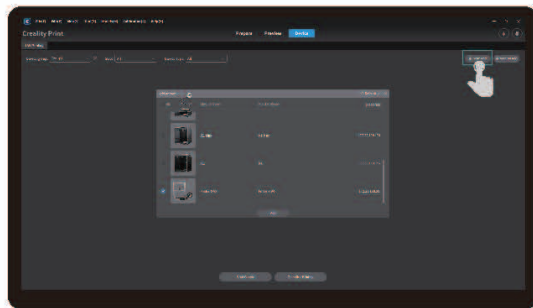

⑧ Add a device: a. Add by scanning → Select a device

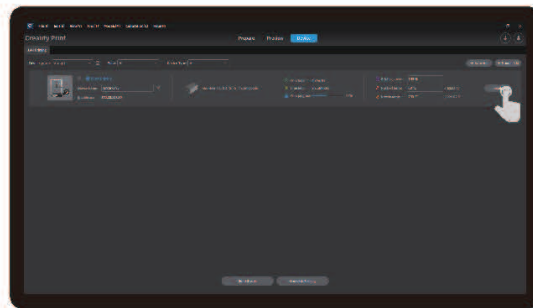

⑨ Device List

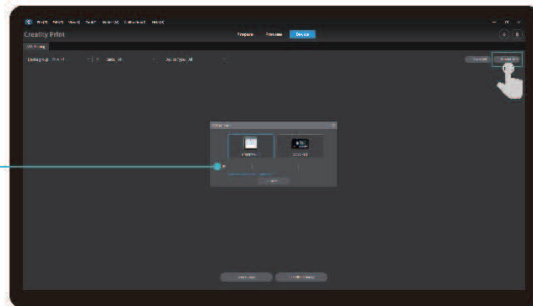

⑧ Add a device: b. Add a device by manually entering the IP address

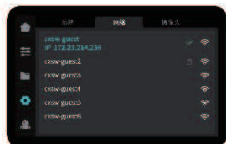

Click "Settings" →
"Network" to view
the IP address.

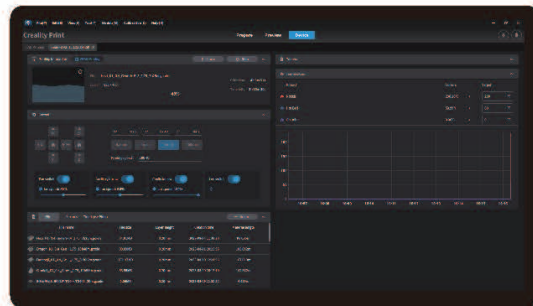

⑩ Equipment printing information details



The current interface is for reference only. Due to the continuous upgrading of functions, it shall be subject to the latest software/–firmware UI published on the official website.

5.First Printing

5.3 USB flash disk Printing

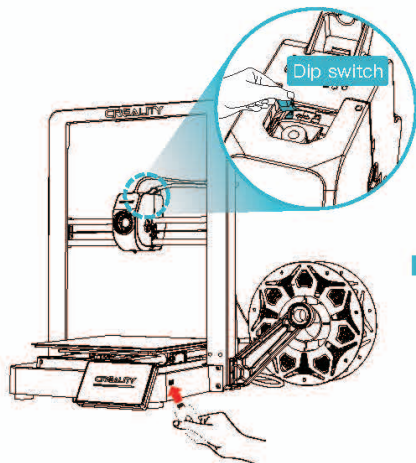

① Insert the USB flash disk into USB port

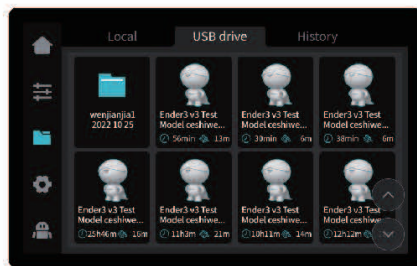

② Select the model from the USB flash disk

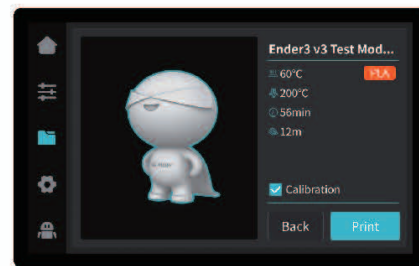

③ Click on "Print"



Tips:

- ① Keep the dip switch locked before printing.
- ② For details on using the software, please refer to the slicing software user manual on the USB flash disk.
- ③ Saved files must be placed in the root directory (not a subdirectory) of the USB flash disk.
- ④ It is recommended to use Latin alphabet, numbers, and common characters for the file names.
- ⑤ Do not insert or remove the USB flash disk during the printing process.



The current interface is for reference only. Due to the continuous upgrading of functions, it shall be subject to the latest software/firmware UI published on the official website.

6.Functional Specification

6.1 Filament Retreat

Method 1: Manual retract

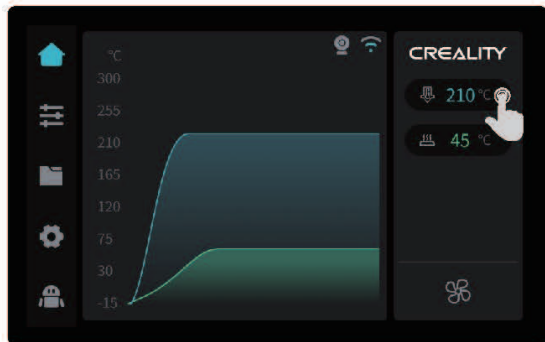

① Input the nozzle temperature on the screen and wait for it to heat up to the target temperature;

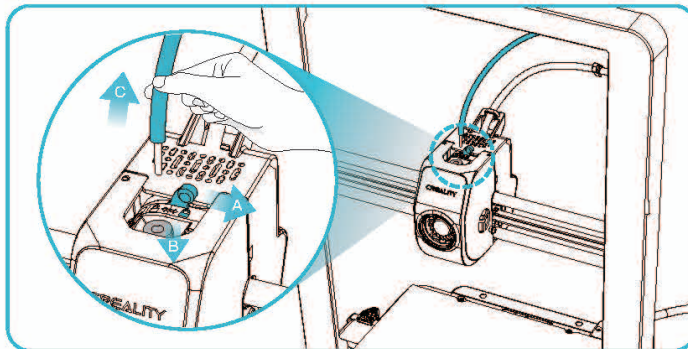

② A. Unlock the dip switch; B. Hold the Teflon tube connector above the extruder; C. Pull out the Teflon tube;

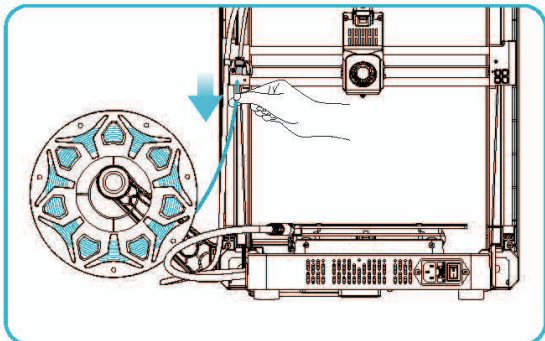

③ Remove the old filaments by pulling them out from the back of the machine to replace with new ones.



The current interface is for reference only. Due to the continuous upgrading of functions, it shall be subject to the latest software/firmware UI published on the official website.

6.Functional Specification

Method 2: Auto retract

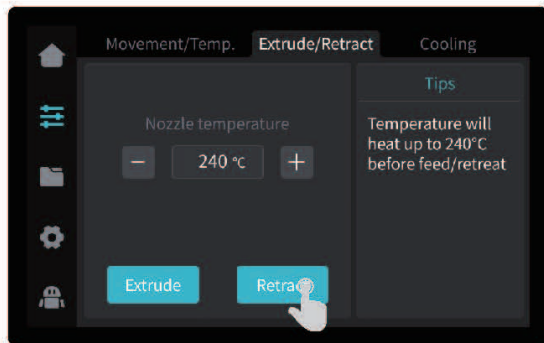

① Click on "Retract";

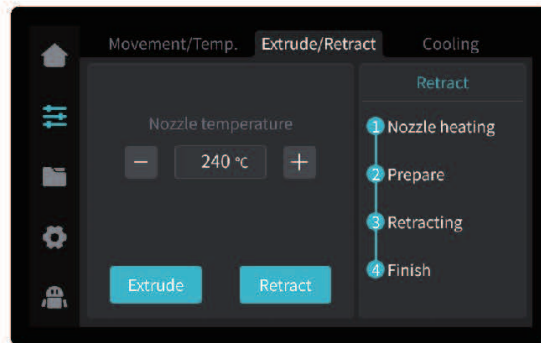

② Waiting for the retraction process to complete;

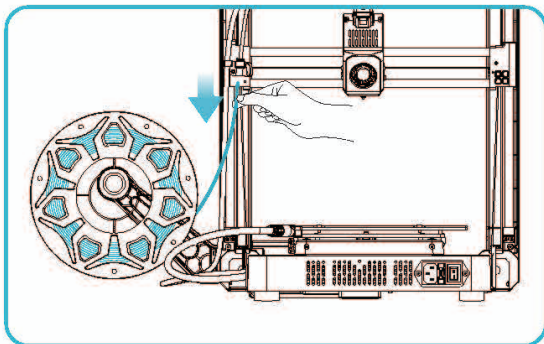

③ Remove the old filaments by pulling them out from the back of the machine to replace with new ones.



The current interface is for reference only. Due to the continuous upgrading of functions, it shall be subject to the latest software/firmware UI published on the official website.

6.Functional Specification

6.2 Auto extrude

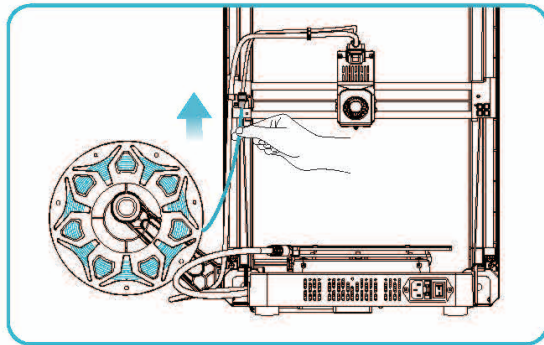

① Insert the filament into the deepest part of the Teflon tube until it cannot be moved;

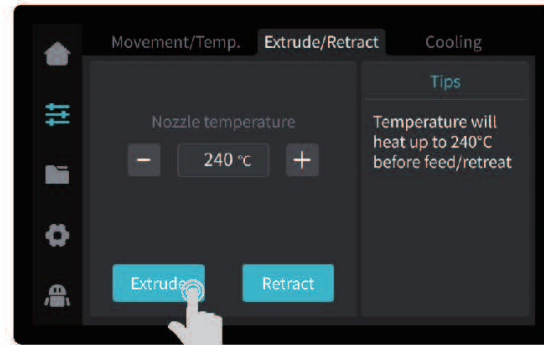

② Click on "Extrude";

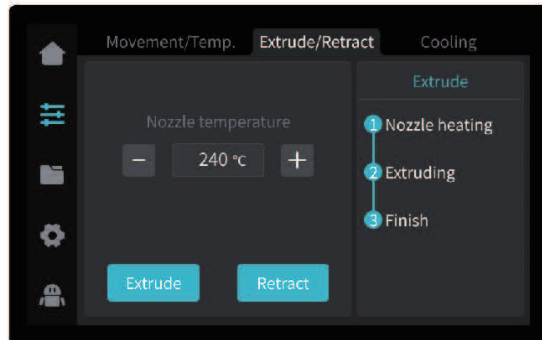

③ Waiting for the extruding process to complete.



The current interface is for reference only. Due to the continuous upgrading of functions, it shall be subject to the latest software/firmware UI published on the official website.

7. Equipment Maintenance

7.1 Platform plate removal and maintenance

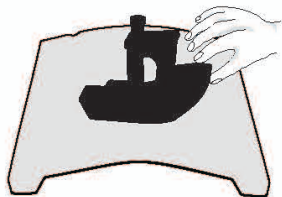

- 1 a. When printing is finished, wait for the platform plate to cool before removing the printing platform with the model attached;
b. Slightly bend the platform with both hands to separate the model from the platform.



- 2 If there are residual filaments on the platform plate, scrape them off lightly with a blade and print again.

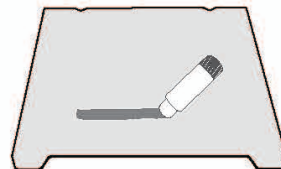

- 3 If the first layer of the model is not properly glued, it is recommended to apply solid adhesive evenly on the surface of the platform plate before preheating for printing.



- Tips: 1. Don't bend too much for daily use to prevent deformation and unusability;
2. The printing platform is a perishable part, and it is recommended to replace it regularly to ensure that the first layer of the model sticks properly.

7.2 Maintenance of screw rod and guide rail

Regularly lubricate and maintain the screw rod and guide rail areas with purchased lubricating grease.

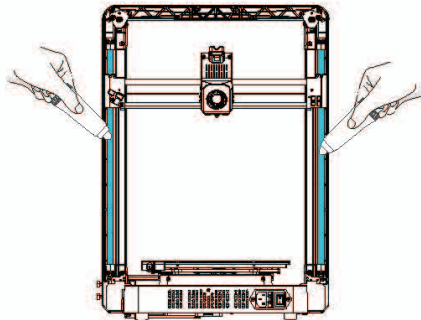

Z-axis screw rod area

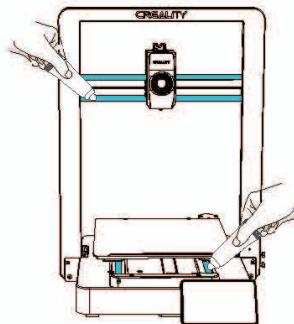

X-axis and Y-axis guide rail areas

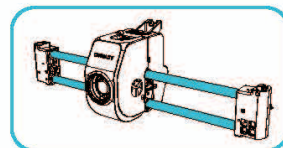

X-axis guide rail area

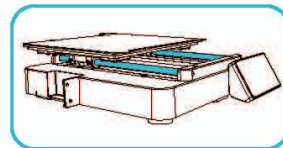

Y-axis guide rail area

Equipment Parameters	
Model	Ender-3 V3
Modelling Technolog	FDM
Modelling Dimensions	220*220*250mm
Leveling Method	Auto-leveling
Number of Nozzles	1pcs
Extruder Diameter	0.4mm
Slice Thickness	0.1-0.35mm
Precision	±0.2mm
Nozzle Temperature	≤300℃
Hotbed Temperature	≤110℃
Filaments	PLA/TPU/PETG/ABS
Rated Power	350W
Input voltage	100-120V~, 200-240V~, 50/60Hz
Filament Detection	YES
Power Loss Recovery	YES
Printing Method	USB flash disk Printing / LAN printing / Cloud printing
Print file format	Gcode
Slicing Software	Creality Print/Cura 5 or later/PrusaSlicer 2.6
Operating Systems	Windows/MAC OS
Language	中文/ English/ Español/ Deutsche/ Français/ Русский/ Português/ Italiano/ Türk/ 日本語

9. Circuit Wiring

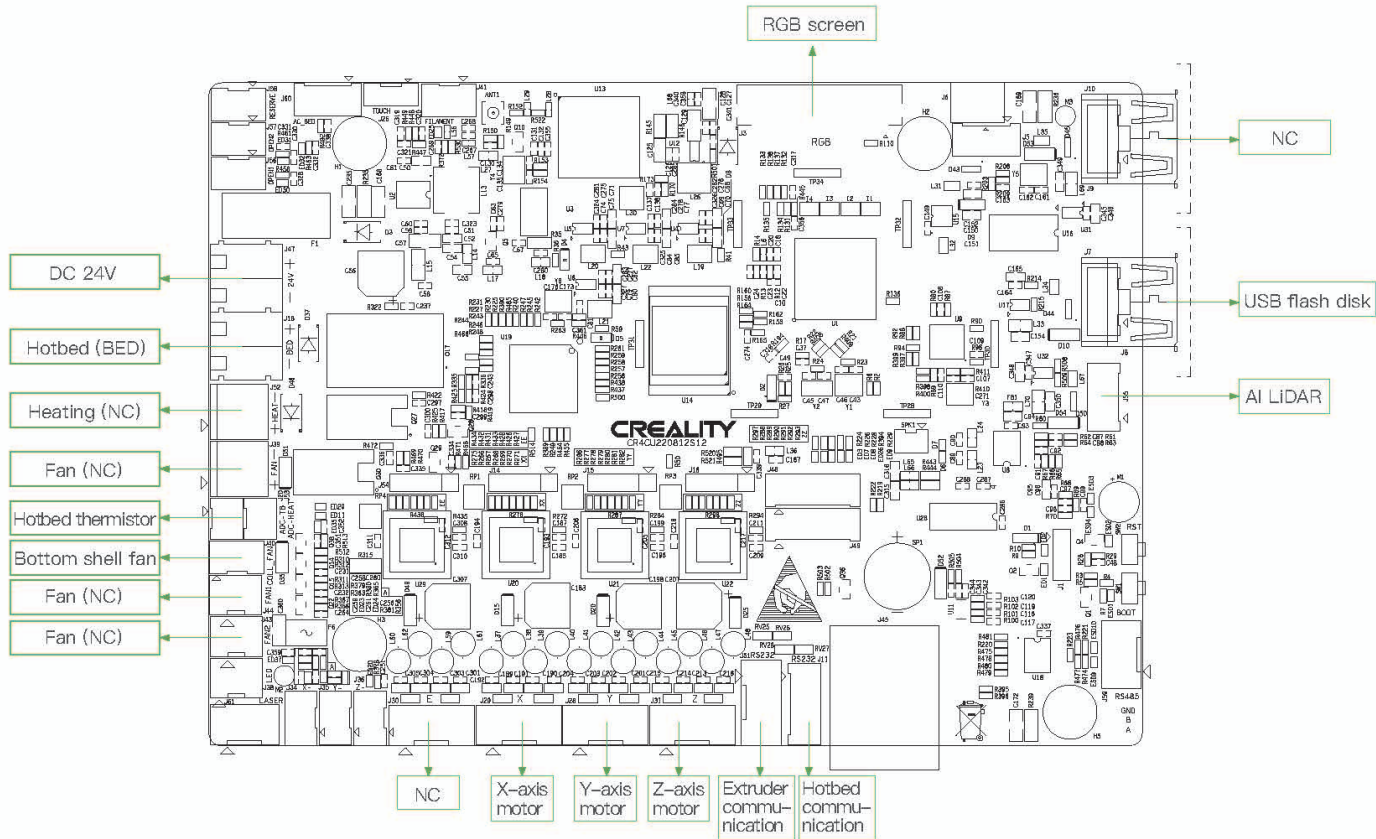

Due to the differences between different machine models, the actual objects and the images can differ. Please refer to the actual machine. The final explanation rights shall be reserved by Shenzhen Creality 3D Technology Co., Ltd.



SHENZHEN CREALITY 3D TECHNO LOGY CO.,LTD.

18th Floor, JinXiuHongDu Building, Meilong Road, Xinniu Community,

Minzhi Street, Longhua District, Shenzhen City, China.

Official Website: www.creality.com

Tel: +86 755-8523 4565

E-mail: cs@creality.com



RGB screen

FCC Caution:

Any Changes or modifications not expressly approved by the party responsible for compliance could void the user's authority to operate the equipment.

This device complies with part 15 of the FCC Rules. Operation is subject to the following two conditions: (1) This device may not cause harmful interference, and (2) this device must accept any interference received, including interference that may cause undesired operation.

IMPORTANT NOTE:

Note: This equipment has been tested and found to comply with the limits for a Class B digital device, pursuant to part 15 of the FCC Rules. These limits are designed to provide reasonable protection against harmful interference in a residential installation. This equipment generates, uses and can radiate radio frequency energy and, if not installed and used in accordance with the instructions, may cause harmful interference to radio communications. However, there is no guarantee that interference will not occur in a particular installation. If this equipment does cause harmful interference to radio or television reception, which can be determined by turning the equipment off and on, the user is encouraged to try to correct the interference by one or more of the following measures:

- Reorient or relocate the receiving antenna.
- Increase the separation between the equipment and receiver.
- Connect the equipment into an outlet on a circuit different from that to which the receiver is connected.
- Consult the dealer or an experienced radio/TV technician for help.

FCC Radiation Exposure Statement:

This equipment complies with FCC radiation exposure limits set forth for an uncontrolled environment.

This equipment should be installed and operated with minimum distance 20cm between the radiator & your body.