

# 10. Print Method

## 10.2 Creality Cloud networking mode 2: Printing by Wi-Fi matching



① Add a device;



② Reset the device;

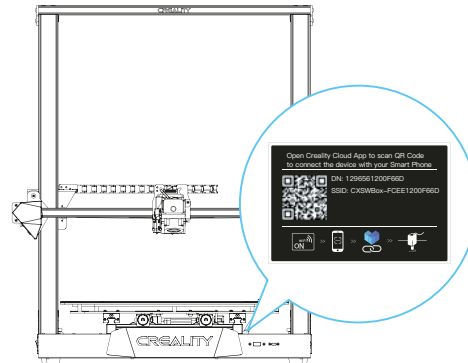

③ Scan the QR code on the device;



④ Choose a networking method; ⑤ Connect the device to Wi-Fi;



⑥ Enter Wi-Fi password;

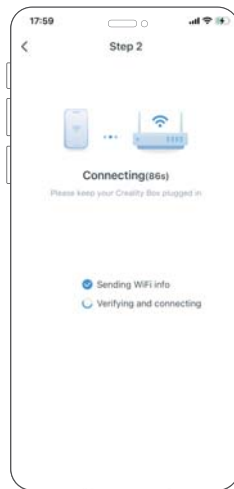

⑦ Device connecting;



⑧ Added successfully;

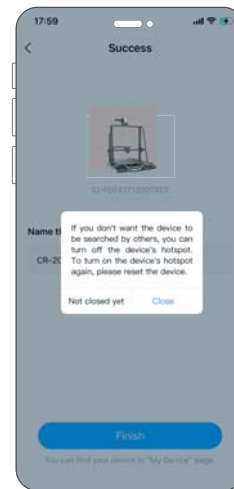

⑨ Turn off device hotspot alerts.

The above interface is for reference only.

## 11. Routine Maintenance

### 11.1 Lubrication and maintenance



Tip: Please lubricate the guideways, sliders and screw rods in the blue area regularly (as shown in the figure). It is recommended to do it once every 500 hours of printing.

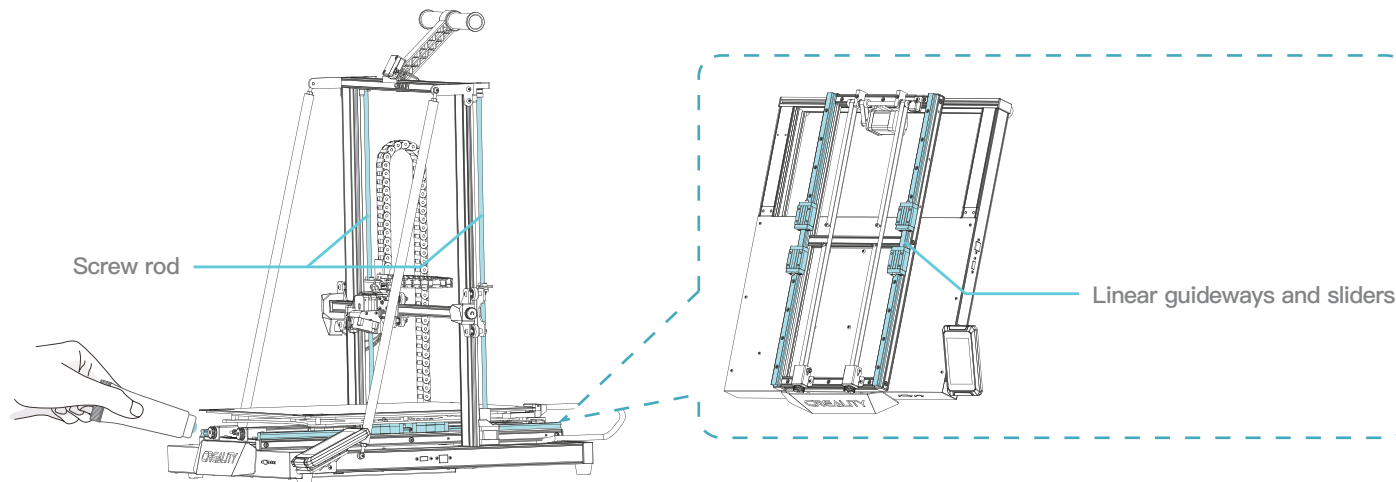

### 11.2 Use and maintenance of the magnetic adhesive sticker



Tips: This hotbed can be heated up to 100°C. It is strictly forbidden to remove the printing platform when the temperature of the hotbed is higher than 70°C. Since the printing platform is a wearing part, it is recommended to clean it regularly to ensure that the first layer of the model is adhered. Please replace it in time if it is damaged.

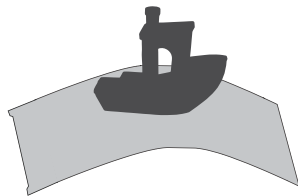

1. Remove the printed model from the machine together with the platform and partially bend the platform slightly to separate the model from the platform.



2. Filaments can be scraped off with a blade included in the tool box. Be cautious of safety when using the blade.

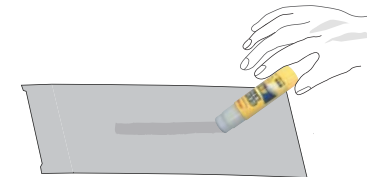

3. When printing large models, it is recommended to apply solid glue evenly on the surface of the platform; if the platform is over-glued, it can be cleaned with tap water and wipe the surface dry afterwards.

## 11. Routine Maintenance

### 11.3 Extruder kit maintenance



#### Tips:

Extruders are vulnerable parts. It is recommended to do the periodic inspection of extruder if it is used for more than three months to check whether the fan has foreign objects on it or whether it is damaged, which will affect the heat dissipation and cooling. If the extrusion is uneven, intermittent and the printed model has no extrusion or has false layer, it is recommended to do the heat break cleaning or replace the nozzle kit with a new one as a priority. Refer to the [13](#) nozzle kit.

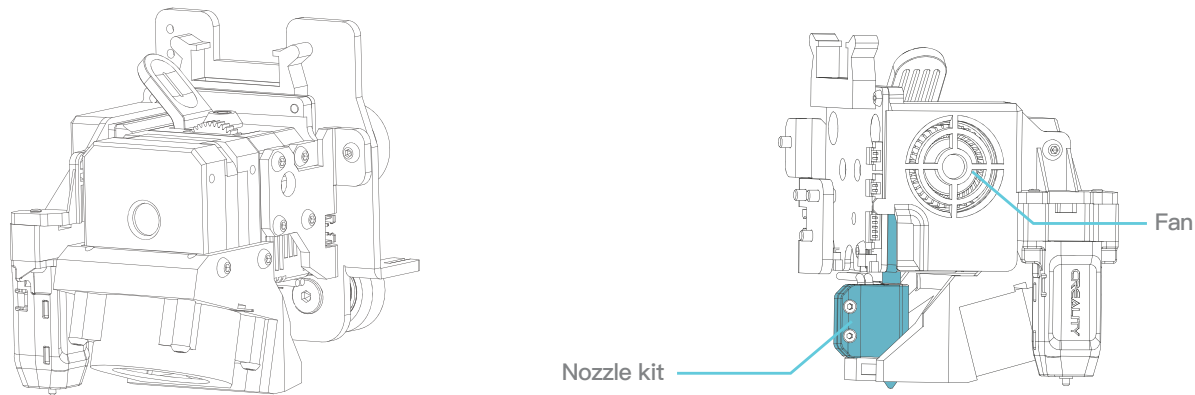

# 12. Circuit Connecting

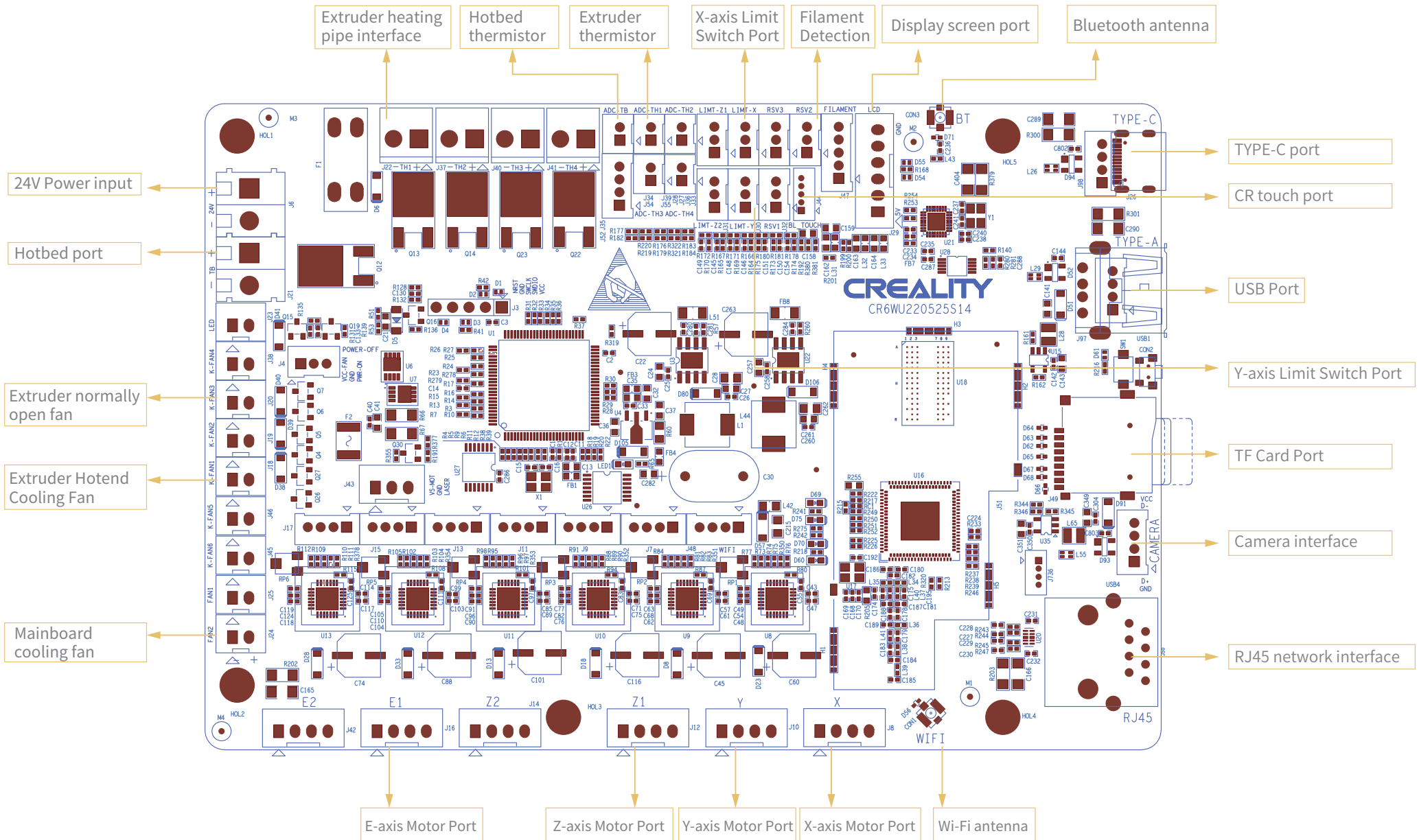

## FCC WARNING

This device complies with part 15 of the FCC Rules.

Operation is subject to the following two conditions:

(1) this device may not cause harmful interference, and (2) this device must accept any interference received, including interference that may cause undesired operation. Any changes or modifications not expressly approved by the party responsible for compliance could void the user's authority to operate the equipment.

NOTE: This equipment has been tested and found to comply with the limits for a Class B digital device, pursuant to Part 15 of the FCC Rules. These limits are designed to provide reasonable protection against harmful interference in a residential installation. This equipment generates, uses and can radiate radio frequency energy and, if not installed and used in accordance with the instructions, may cause harmful interference to radio communications. However, there is no guarantee that interference will not occur in a particular installation.

If this equipment does cause harmful interference to radio or television reception, which can be determined by turning the equipment off and on, the user is encouraged to try to correct the interference by one or more of the following measures:

- Reorient or relocate the receiving antenna.
- Increase the separation between the equipment and receiver.
- Connect the equipment into an outlet on a circuit different from that to which the receiver is connected.
- Consult the dealer or an experienced radio/TV technician for help.

To maintain compliance with FCC's RF Exposure guidelines, This equipment should be installed and operated with minimum distance between 20cm the radiator your body: Use only the supplied antenna.

Since each model is different, the actual product may be different from the picture. Please refer to the actual product.  
The final interpretation right belongs to Shenzhen Creality 3D Technology Co., Ltd.



**SHENZHEN CREALITY 3D TECHNOLOGY CO.,LTD.**

Company Address: 18th Floor, JinXiuHongDu Building, Meilong Road, Xinniu Community  
Minzhi Street, Longhua District, Shenzhen City, China.

Official Website: [www.creality.com](http://www.creality.com)

Business Tel: +86 755-8523 4565

