

Smart Wi-Fi Music Star Light
User Manual

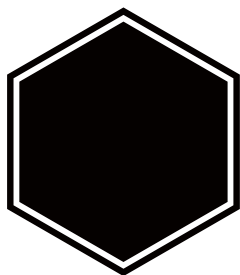

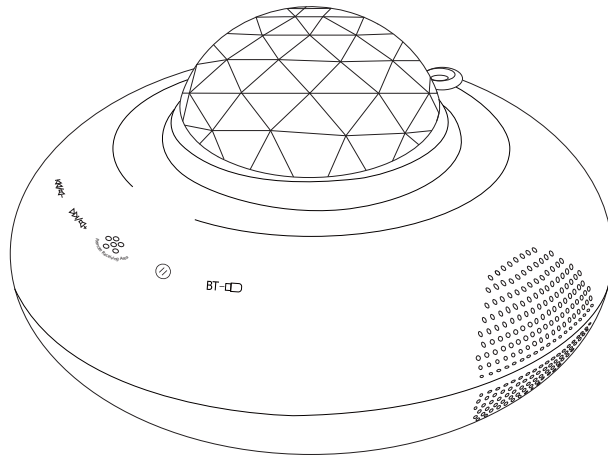

Unboxing Check

Thank you for purchasing our products, please read the instruction manual carefully before use. Instruction manual contains necessary safety advice and user instructions, follow the instruction manual to operate in order to avoid damaging the product for misuse. Check whether the product is damaged or not when you receive the product.

Package list:

Music Star Light x 1
Remote Controller x 1
USB Cable x 1
User Manual x1

Warnings:

The power requirement of this product is USB DC 5V/2A. This product has been comprehensive and rigorous tested at the factory, the user should strictly follow the warning and instructions. Improper use resulting in product damage is not covered by the Company's warranty.

Notice:

1. Strictly in accordance with the instructions of this operation, do not disassemble the host and accessories.
2. This product is suitable for indoor use, please do not use laser shone directly in eyes and keep away from children.
3. The product is projected by LED and laser combinations.
4. This product only supports 2.4GHz Wi-Fi, not 5GHz Wi-Fi.

How to use:

1. Indoor use, projecting in the sky direction.
2. How to use the light projector, as shown below.
3. Connect Bluetooth "**SKE-TKY05**" of the smart phone to play music.
4. Use correct method of the remote control to make sure the remote control is pointing at the infrared sensor that is the "Remote Receiving Area" on the host.

Product Features:

1. Two control modes (Slide to switch the mode: ON-OFF-Wi-Fi):

- Manual mode: "ON" switch, control the functions switch through the host button or remote control. The product will default automatically switch off in 4 hours in manual mode.
- Wi-Fi mode: "Wi-Fi" switch, control the light colors and functions switch via smart phone APP or smart speaker.

2. APP Functions

- Color Interface: Change the ocean wave color, brightness and color saturation;
- Scenario Interface: You can customize multiple scenarios, select your favorite ocean wave effect, adjust brightness, color saturation, keep the lights static, mix-colored lights flashing or breathing mode switch.
- Timer & Schedule Interface: Customize the auto shutdown time.

3. Smart Speaker Control: Use smart speakers such as Amazon Echo, Google Assistant to voice control the product switch, colors changed and brightness.

4. Voice Control Mode: In manual mode, press the remote "Micro" button to activate the voice control, and lights will flash according to the external sound or the change of music rhythm.

1. Manual Mode

Host button function descriptions

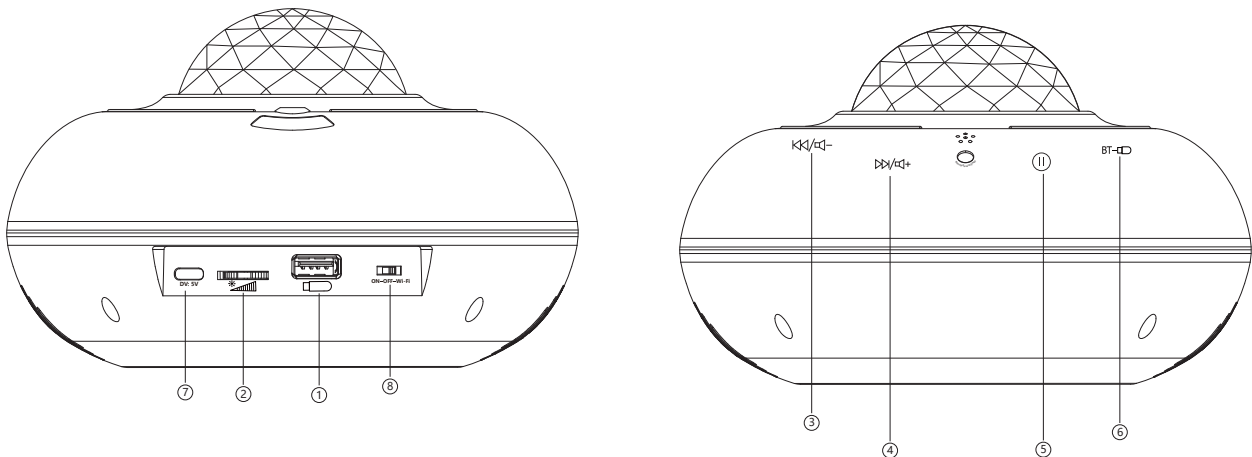

- ① Automatic recognition USB data. Note that this projector can auto recognize and play music while inserting USB memory. USB should contain some songs
- ② Ocean wave brightness adjustment

- ③ Short press play previous song; Long press reduce volume
- ④ Short press play next song; Long press increase volume
- ⑤ Short press control the music play/pause
- ⑥ Short press achieve Bluetooth/USB mode switch when connect Bluetooth and USB at same time
- ⑦ DC Input: 5V/2A
- ⑧ Power ON/OFF/Wi-Fi mode switching

Remote control function description

Instruction:

When music star light connects power, LED blue light keeps on and in moving status, laser light in breathing mode, it can default automatically switch off in 4 hours (Timing without daily circle).

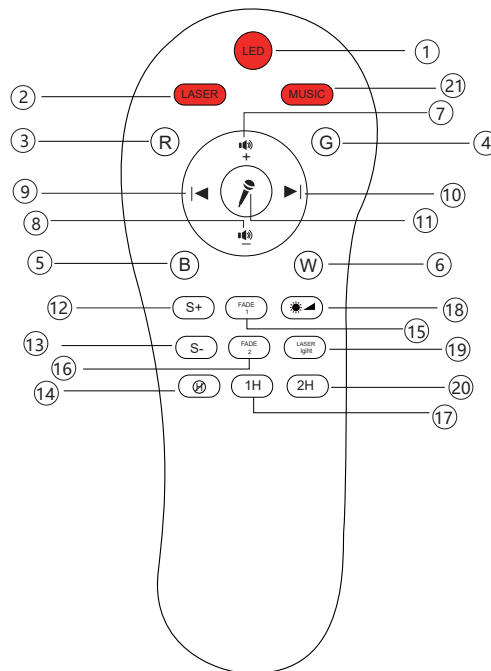

- ① Control LED ocean wave light ON/OFF
- ② Control Laser light ON/OFF
- ③ Press "R" , red light ON; Press again, red light OFF (at basic of light on at first time)
- ④ Press "G" , green light ON; Press again, green light OFF (at basic of light on at first time)
- ⑤ Press "B" , blue light ON; Press again, blue light OFF (at basic of light on at first time)
- ⑥ Press "W" , white light ON; Press again, white light OFF (at basic of light on at first time)

(Note: Four color RGBW buttons can be combined by two to form a double-color projection)

- ⑦ Control device volume up
- ⑧ Control device volume down
- ⑨ Select playing previous song
- ⑩ Select playing next song
- ⑪ Voice control: Lights will fast flash following the external sound or music rhythm (LED ocean wave and laser lights default keep on in voice-activated mode; Note: Press any other remote buttons except the music control buttons to auto exit the voice control mode)
- ⑫ Control ocean wave moving speed up (Pause--Slow--Medium--Fast)
- ⑬ Control ocean wave moving speed down (Fast--Medium--Slow--Pause)
- ⑭ Timer Off: LED light and laser light flash 3 times as prompting for set timer off successfully.
- ⑮ Press "FADE 1" , ocean wave move circularly in R-G-B-W single color mode and laser light changed to gradation mode
- ⑯ Press "FADE 2" , ocean wave move circularly in RB-RG-RW-BG-BW-GW double-color mode and laser light changed to gradation mode
- ⑰ 1H Timer: Shut off automatically after device work for 1 hour. LED light and laser light flash once time as prompting for set 1H timer successfully.
- ⑱ Control LED ocean wave light brightness (In order of 100%--70%--40%--10%--40%--70%--100%)
- ⑲ Press "LASER light" achieve either Laser light stay on or enter into gradation mode
- ⑳ 2H Timer: Shut off automatically after device work for 2 hours. LED light and laser light flash 2 times as prompting for set 2H timer successfully
- ㉑ Control Music Switch On/Off

Notice: This product comes with 4 hours automatic shutdown function that is work for 4 hours and shut down automatically.

2.Wi-Fi Mode

A.Wi-Fi Setting: (1) Check your phone Wi-Fi "On" , or the product won' t be connected; (2) Enable the location information on your phone, or it cannot show the connected Wi-Fi name; (3) Connect your phone to a 2.4GHz network and other frequencies is not supported; (4) In Wi-Fi mode, you can only adjust the light effects (except the Bluetooth mode) through phone APP or smart speaker, not by host button and remote controller.

1. Download the APP by scanning the following QR Codes (Notes: The same operations on the following two APPs. Let us take "Smart Life" APP for an example):



Smart Life



Tuya Smart

2. Search "Smart Life" APP through Google Play (For Android) or APP Store (For Apple-iOS) and download it

3. Register and log in to the APP

1). Open the "Smart Life" APP

2). Log in your account and password. Please register a new account on first use

4. Configuration

1). Connect the power supply of this star projector and the host status is "OFF" switch

2). Connect to the Wi-Fi: Slides repeatedly for 3 times with the following steps: OFF-Wi-Fi-OFF-Wi-Fi-OFF-Wi-Fi, keep the host switch in "Wi-Fi" till the indicator light shows white and fast-flashing. Note: the interval of the power switch sliding should not exceed 10 seconds

B. Turn on "Smart Life" APP, click "Add Device" , select "Lighting---Lighting(Wi-Fi)" , choose your home Wi-Fi and enter password (If applicable), and click "Next" (Note: Connect your phone to a 2.4GHz network router, and 5GHz network not supported).

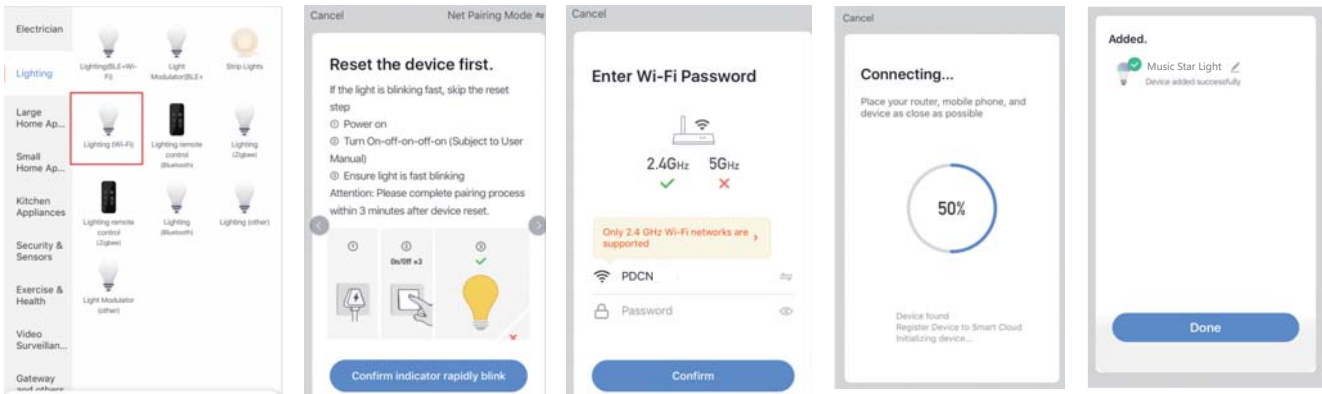

C. Then entering the configuration process. Once connected, it will show “Device added successfully” that is the Music Star Light has been connected successfully.

APP Functions

1. Click on the “Music Star Light” icon to enter the main interface, touch the Power Switch to turn on/off the music star projector. You can customize the product name through clicking the icon at the top right-hand corner.

2. Color Interface: Adjust the colors, brightness, color saturation, and customize the colors in static, jumping or breathing mode.

(1) White Light Interface (2) Colour Light Interface

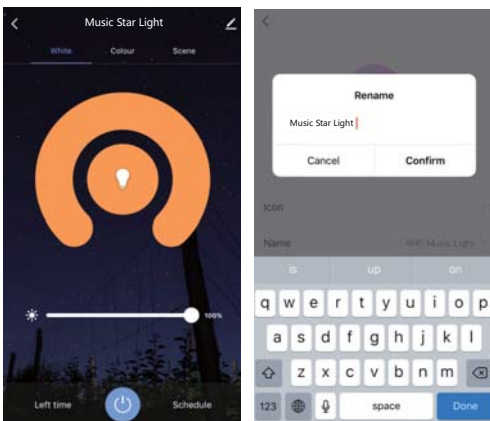

Adjust white light brightness

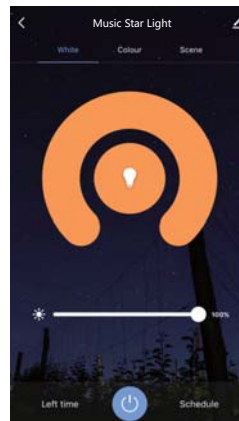

Adjust the light colors, brightness and color saturation



3. Scenario Interface:

(1) Customize & Rename: You can customize and rename the scenario, choose your favorite color effects



(2) Modes Optional: Click the scene you want, select your favorite ocean wave colors, brightness, color saturation. Freely choose 3 kinds of color modes: a. Static mode; b. Jumping mode; c. Breathing mode. Customize the color changed speed in jumping and breathing modes (If in wrong setting, please click "Reset" at the right-hand corner to restore default setting)

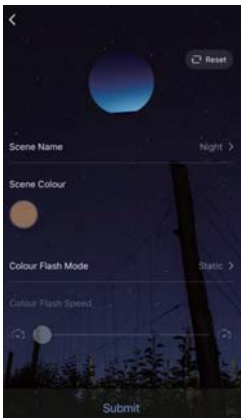

Click "Reset" at the right-hand corner to restore default setting

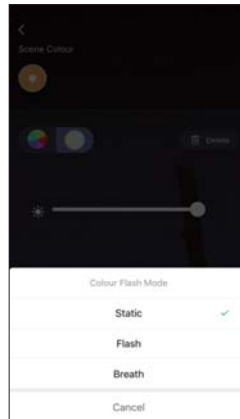

White Light: Adjust brightness, default in static mode. If you choose jumping and breathing modes, white light should be default combined together with colour lights to achieve the jumping and breathing modes switch

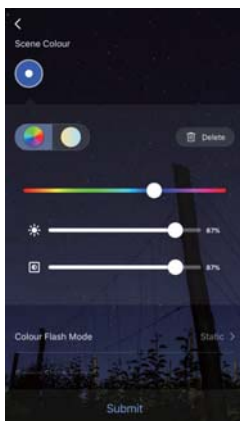

Colour Light Interface: Adjust color, brightness, color saturation, 3 kinds of color modes: a. Static; b. Jumping; c. Breathing

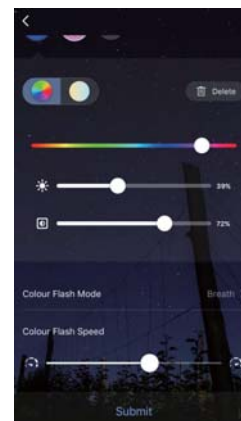
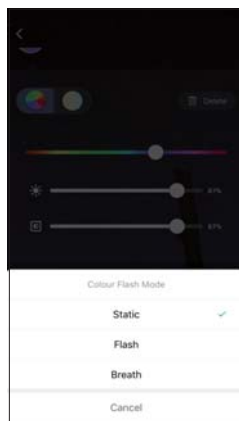

Customize the light color changed speed in jumping and breathing modes

4. Auto-Off Timer: Customize the time you want, once set successfully, the system will default enter the countdown status

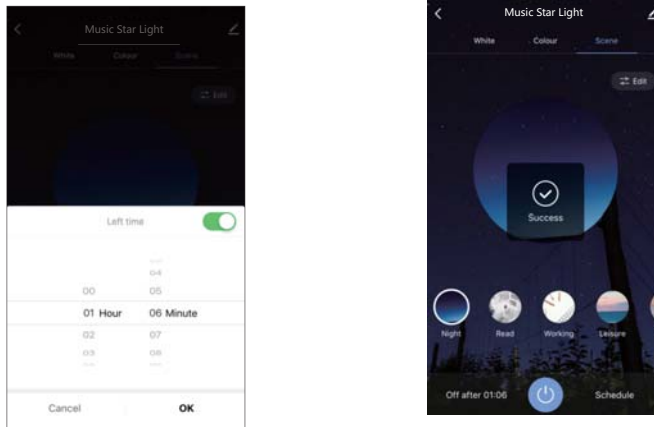

5. Schedule: Customize the power On/Off

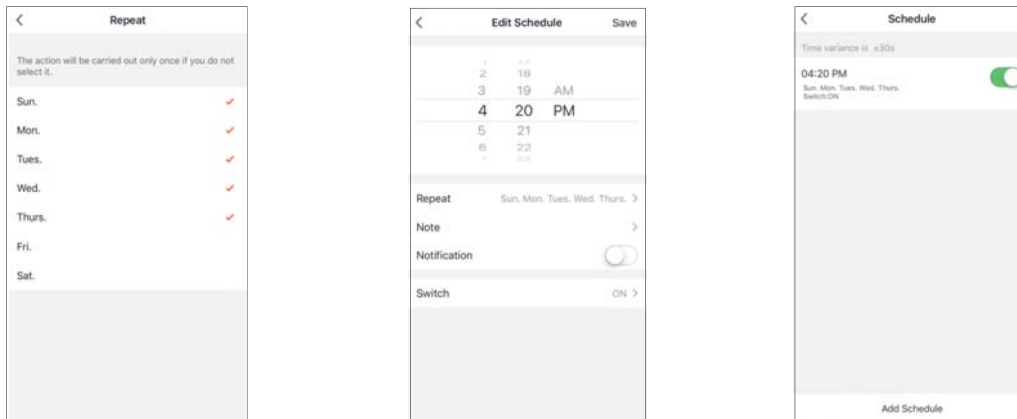

How to Connect with Amazon Alexa:

- (1) Search "Smart Life" APP through Google Play (For Android) or APP Store (For Apple-iOS) and download it;
- (2) Open the APP and register a new account or log in (If you have registered)
- (3) Turn on "Smart Life" APP and connect to the network;
- (4) Necessary Note: You can use the "Smart Life" APP to rename the product. For example, if you want to rename the Music Star Light to "Livingroom Light" , please find this device in step 9 so that Echo will receive the updated name;
- (5) Download "Amazon Alexa" APP through Amazon Market, Google Play or iOS APP Store, and connect the Echo with "Amazon Alexa"
- (6) Search "Smart Life" in the Amazon Alexa Skills;
- (7) Click to start the Smart Life in the Alexa Skills, enter your account name, password on this web page;

(8) Authorize and allow Amazon Alexa to log in your Smart Life registered account, talk to Echo: "Alexa, search the device, please" , once completion, Echo say: "Search completed" ;

(9) All settings are finished and now you can talk to Amazon Alexa to control this device.

Here are the Voice Commands on the Smart Life:

Alexa, turn on Music Star Light

Alexa, turn off Music Star Light

Alexa, set Music Star Light to 20 percent

Alexa, brighten/increase Music Star Light

Alexa, dim/decrease Music Star Light

Alexa, set Music Star Light to green

Troubleshootings for Network Configuration

1. Verify the Wi-Fi password in the following ways

Open the Wi-Fi list on your phone, click the Wi-Fi name and ignore it, then reconnect and enter the password again to ensure connecting successfully. If not, please use the right Wi-Fi password.

2. If your phone cannot show your home Wi-Fi, please check if the location information on your phone is enabled.

3. Please check if your phone is connected with 2.4GHz network (other frequencies is not supported).

4. Please check the Wi-Fi name cannot contain Chinese, blank and special characters.

5. Please check the Wi-Fi password cannot be empty, it can up to a maximum of 58 characters and try to avoid using special characters.

6. When in connection, Please keep the product close to the network router at a distance of 5 meters.

Specifications:

Host Material	ABS
Input Rated Voltage	5VDC
Maximum Power	10W
Maximum Working Current	2.0A
Projection Light Source	LED light bead/laser light source

Projector Light Source Wavelength	Red light beads (620-625nm), green light beads (520-525nm), blue light beads (460-465nm), white light beads (color temperature 1500-15000k), green light wavelength (532nm)
Projection Distance	2-10M/6.56-32.80ft
Projection Area	The projection area is 120m ² at a distance of 3M, and 200m ² at a distance of 5M
Motor	Starting Voltage: 3V, with 2-3 r/min
Input Power	100-240V AC 50/60Hz 2.0A (Work together with power adapter)
Operating Temperature	-20~50°C/-4~122°F
Storage Temperature	-20~60°C/-4~140°F
Product Model	SKE-TKY05
Laser Level	Class 2 (Class II)
Laser Power	< 1mW
Use and Maintenance	Indoor use, maintenance-free
Product Dimension	φ160 * 110mm/6.29 * 4.33inch

FOR SAFETY' S SAKE:

- **Not suitable for use in play by children**

- May not be suitable for people who have photo sensitive epilepsy
AVOID DIRECT EYE EXPOSURE
- [Class 2] LASER RADIATION - DO NOT STARE INTO BEAM - CLASS 2 LASER
- PRODUCT
- Do not damage the insulation of cable.
- Do not secure the wiring of the product with staples or nails
- Do not close doors or windows on the product as this may damage the wiring insulation.
- Do not lay the cable under carpet or where it can be damaged.
- Ensure that cables are fully unwound and sited where they will not become damaged or present a tripping hazard.
- Do not connect this product to the mains supply while it is in the packaging.
- Do not allow any plastic part to come into contact with heat or flame.
- Ensure table top transformers are positioned on flat, stable, heat resistant surfaces.
- Unplug the product when leaving the house, when retiring for the night or if left unattended
- Do not overload wall sockets. Use different sockets around the house to plug in multiple lights to balance the load.
- Please retain this information for future reference.

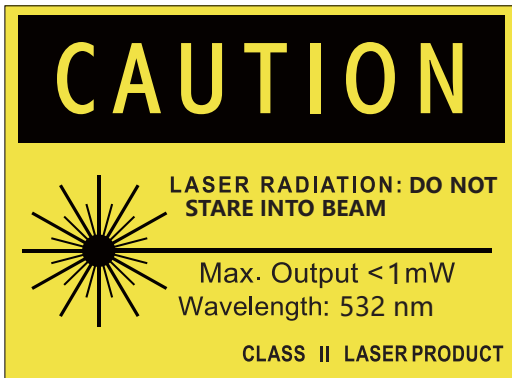

The light colour of this product is outside the limits as defined in ErP Regulations and therefore only suitable for decorative purposes.

Complies with safety requirements of IEC 60825-1: 2014

FCC Warning:

Any Changes or modifications not expressly approved by the party responsible for compliance could void the user's authority to operate the equipment.

Note: This equipment has been tested and found to comply with the limits for a Class B digital device, pursuant to part 15 of the FCC Rules. These limits are designed to provide reasonable protection against harmful interference in a residential installation. This equipment generates uses and can radiate radio frequency energy and, if not installed and used in accordance with the instructions, may cause harmful interference to radio communications. However, there is no guarantee that interference will not occur in a particular installation. If this equipment does cause harmful interference to radio or television reception, which can be determined by turning the equipment off and on, the user is encouraged to try to correct the interference by one or more of the following measures:

- Reorient or relocate the receiving antenna.
- Increase the separation between the equipment and receiver.
- Connect the equipment into an outlet on a circuit different from that to which the receiver is connected.
- Consult the dealer or an experienced radio/TV technician for help.

This device complies with part 15 of the FCC Rules. Operation is subject to the following two conditions: (1) This device may not cause harmful interference, and (2) this device must accept any interference received, including interference that may cause undesired operation.

“This equipment complies with RF radiation exposure limits set forth for an uncontrolled environment.

This equipment should be installed and operated with a minimum distance of 20 centimeters between the radiator and your body.”