

Smart Battery Camera

Operation Instruction

Contents

1.Packing list-----	01
2.Product appearance-----	02
3.Quick start-----	04
4.Set up the camera-----	06
5.Install the camera-----	11
6.Share the camera-----	14
7.Charge the camera-----	17
8.Indicator light status-----	18
9.Product specification-----	18
10.Firmware upgrade-----	19
11.FCC warning-----	19
12.FAQ-----	21

Packing list

1. Camera*1
2. Bracket*1
3. Mounting kit*1
4. USB charging cable *1
5. Operation instruction*1
6. Screw for bracket*1

Product appearance

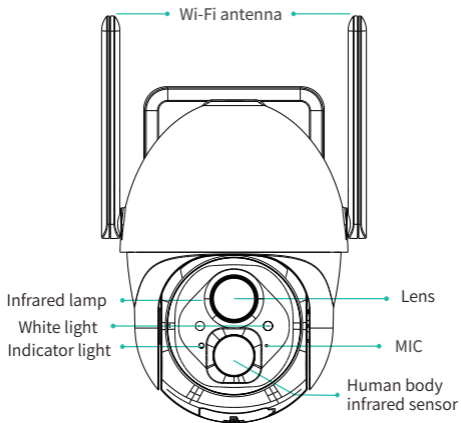

Quick start

The smart battery camera supports battery-powered supply and AC-powered supply.

1. Download and install the App

The wireless smart battery camera supports Android and iOS App. For your best experience, please scan the QR code below with your mobile phone, install the app, and follow the instruction to complete the user registration.



Download App

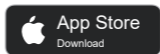
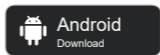

Scan QR code or go to the link to download and install the App: <https://www.vicohome.io/download/>

2. Add the device

Sign in to the App connect to Wi-Fi and add the device according to the prompts (please bring the device close to the router when configuring).

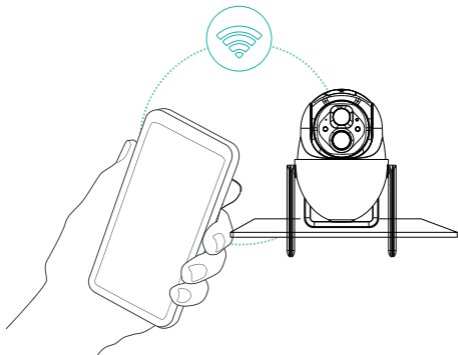

Set up the camera

1) Click the "Add Camera Now" in the App and enter the Wi-Fi network name and password that you want the camera to connect.

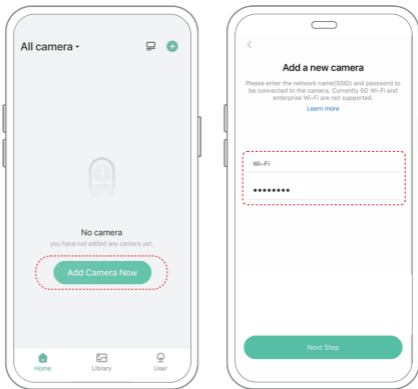

2) To ensure a longer distance connection, the camera only supports the 2.4Ghz Wi-Fi with stronger wall penetration capability and does not support Wi-Fi for enterprise level authentication currently. Please ensure that the entered Wi-Fi meets the requirements. After completion, click "Continue" to generate the QR code for pairing the camera.



3) After pressing the camera switch for 3 seconds, the camera will turn on. The camera will emit the scanning sound "Ding Dong Ding Dong" after it is turned on (if you do not hear it, please double click the power button).

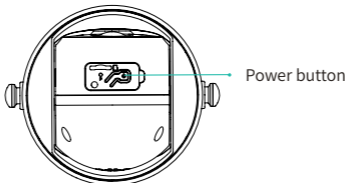

4) Take the lens of the camera facing the QR code generated on VicoHome about 20 cm (7 inches) until you hear a "Ding" sound.

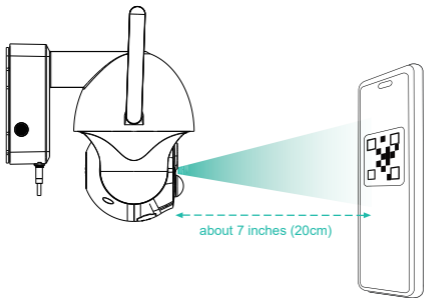

5) After a while, the camera will give out a prompt sound of a successful connection. At this moment, please set the name for the device on the App and select the location you want to place the device. Click "Continue" to complete the pairing.

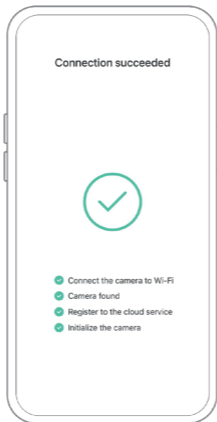

! Possible problems with binding:

- When you hear the "**Wi-Fi Password Error**", please check whether the Wi-Fi password you entered in the App is correct;
- When you hear the "**Authentication error**", please ensure that your Wi-Fi network is not an enterprise-level network, and the device supports only the network with the security level below WPA-2;
- When you hear the "**Wi-Fi not found**", please check whether you select or enter the correct Wi-Fi name, and place the device near the Wi-Fi router and ensure that the router is powered on. Please note that 5Ghz Wi-Fi cannot be searched by the device;
- When you hear the "**Retrieving IP timeout**", it indicates that the number of devices connected to the router in your home is too many to connect more devices. Please remove some of the connected devices that are not commonly used or restart the router to clear the unconnected devices. You may need to contact the router administrator;
- When you hear the "**Cloud service connection fail**", please check whether your router is connected properly to the external network. When you hear this error prompt, it is common on the condition of network disconnection or that the selected router in your home is a local area network server. Please ensure that the network connection is normal, and try to temporarily turn off the firewall to

Install the camera

You can place the camera on a shelf or other surfaces to use, or you can install it on a wall to use.

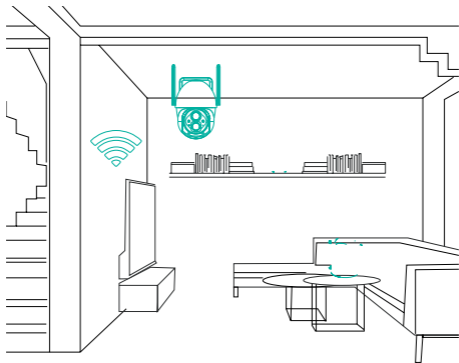

(1) Select a good spot for your camera

Select a good spot for your camera, please install the camera in a position where its view is not blocked and ensure that it is within the coverage of the Wi-Fi network. The PIR infrared sensor is more sensitive to movements across the camera's field of view than movements toward or away from the camera.



- ❗ For outdoor use, please install the camera upside down to maximize the waterproof performance and the human body infrared sensor's effectivity.

(2) Install the bracket

1) Screw fixing:

Fix the camera to the desired location. You can directly place the camera on a flat surface or fix the bracket to the wall or camera. ceiling by screws.



2) Fix the camera

Put the camera up side down and then fix the camera to the bracket by a screw .

Share the camera

When you want to let other family members or friends view the camera, you can use this feature. Only the admin user who is the first to add the camera is able to share the camera and manage the settings for the camera. The shared users have limited access rights.

(1) Steps for Admin User

1) Find the camera you want to share on the App Homepage, then tap the "Share" button. You can also tap the camera "Camera Setting" icon, then tap the "Share" button;

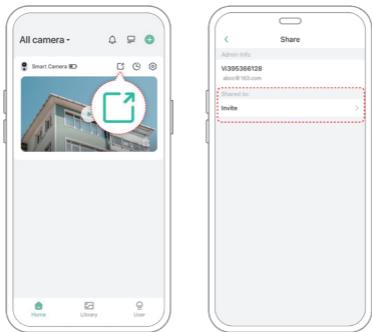

2) Tap "Camera sharing", a QR code for sharing will be generated.



(2) Steps for Shared User

For the family members or friends you want to share, find "Add friend's camera" on the Homepage to enter the scan code page, then scan QR code generated on the admin's phone, then send the access request to the admin user.



(3) Steps for Admin User

You will receive a confirmation notice, and you can complete sharing after agreeing.

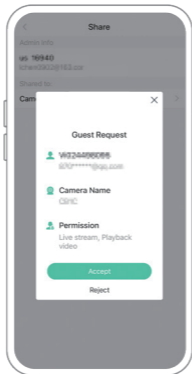

Charge the camera

The App will remind you to charge your camera when the battery is low. Please use the Micro USB cable to plug into the 5V/1.5A charging adapter to charge the camera. During charging, the camera's indicator light is solid yellow, and when the camera is fully charged, the indicator light will turn into solid green. It will take 15 hours to fully charge the camera.

Indicator light status

Mode	Status
Working mode	Blue
Sleep mode	Off
Charging mode	Yellow
Fully charged mode	Green

Product specification

Item	Specification
Camera lens	Field of view: 110°
Image resolution	Max. 1920 X 1080
Video bit rate	Adaptive
Storage media	Micro SD card (Up to 128GB)
Rotation Angle	355° pan, 90° tilt
Battery capacity	9000mAh
Adapter requirement	5V/1.5A
Size(without bracket)	120.2×101.1×158.3 (mm)

Firmware upgrade

When you connect your camera through the App, it will prompt you if the latest firmware is available. You can also manually check the firmware version in the settings of the App.

- ❗ Please make sure that your camera is fully charged or connected to the power adapter before upgrading the firmware, please do not cut off the power supply during the upgrading.

FCC warning

This device complies with part 15 of the FCC Rules. Operation is subject to the following two conditions:

- (1) this device may not cause harmful interference.
- (2) this device must accept any interference received, including interference that may cause undesired operation. Any changes or modifications not expressly approved by the party responsible for compliance could void the user's authority to operate the equipment.

NOTE: This equipment has been tested and found to comply with the limits for a Class B digital device, pursuant to Part 15 of the FCC Rules. These limits are designed to provide reasonable protection against harmful interference in a residential installation. This equipment generates, uses and can radiate radio frequency energy and, if not installed and used in accordance with the instructions, may cause harmful interference to radio communications. However, there is no guarantee that interference will not occur in a particular installation.

If this equipment does cause harmful interference to radio or television reception, which can be determined by turning the equipment off and on, the user is encouraged to try to correct the interference by one or more of the following measures:

Reorient or relocate the receiving antenna.

Increase the separation between the equipment and receiver.

Connect the equipment into an outlet on a circuit different from that to which the receiver is connected.

Consult the dealer or an experienced radio/TV technician for help.

To maintain compliance with FCC's RF Exposure guidelines, this equipment should be installed and operated with minimum distance between 20cm the radiator your body:

Use only the supplied antenna.

FAQ

1.Q:Camera permission management: How to invite family and friends to use my camera together?

A: Open the App and select your camera on the home page. Click the share button on the home page or the "Share" in the camera settings to enter the sharing page, and then click "Invite " to generate a QR code. Your friends can now get some of the access rights by scanning the QR code in your phone.

2.Q:Why doesn't the Wi-Fi name appear when I connect to Wi-Fi?

A: On Apple devices with iOS13 and above, you need to turn on the "location permission" for the app in the system settings and change it to "allow when using."

3.Q:Will the camera show red lights when night vision is activated?

A: The built-in infrared lamp beads make the camera only show some dim red lights when night vision is activated, but the image quality is still clear under no light environment.

4.Q:What are the requirements for Wi-Fi?

A: Please use a 2.4GHz wireless network. The device does not support the 5GHz wireless network. Meanwhile, please set the Wi-Fi authentication method to WPA2-PSK or other lower level of security method. A password is required.

5.Q:How far should the camera be placed from the router?

A: After testing, the Wi-Fi connection distance can normally reach up to 150 meters in the open area. However, the actual situation depends on the strength of Wi-Fi and its surrounding environment (thick walls, electromagnetic devices, large metal objects will all cause interference to the Wi-Fi signals). If the camera connection signal is weak or unstable, please place the camera as close to the router as possible.

6.Q:What is the maximum length of recording time?

A: If you set the duration as "Auto", when someone occurs in the view of the camera, it will start recording a video for up to 3 minutes.

7.Q:How to quickly view videos by category?

A: Click the icon in the upper left corner of the "Library" page to start filtering videos by category. Select the category you want to see and then click "Save" to view the video playbacks.

8.Q:What should I do when the device is in malfunction?

A: Long press the power button for 3 seconds to restart it. If there is no response, you can remove the rubber plug at the button of the camera. Press the reboot hole with a pointed object to restart the camera.

