

FCC TEST REPORT

FCC ID:2AXE4-GK75S

Report Number..... : ZKT-221227L9719-1

Date of Test..... Dec. 12, 2022 to Dec. 30, 2022

Date of issue..... : Jan. 04, 2023

Total number of pages..... 42

Test Result : PASS

Testing Laboratory..... : Shenzhen ZKT Technology Co., Ltd.

Address : 1/F, No. 101, Building B, No. 6, Tangwei Community Industrial Avenue, Fuhai Street, Bao'an District, Shenzhen, China

Applicant's name : Dongguan Jizhi Electronic Technology Co., Ltd.

Address : Building H, Fasite Industry Park, No. 89, Liyatang Industry Zone, Lincun, Tangxia Town, Dongguan, Guangdong, China

Manufacturer's name : Dongguan Jizhi Electronic Technology Co., Ltd.

Address : Building H, Fasite Industry Park, No. 89, Liyatang Industry Zone, Lincun, Tangxia Town, Dongguan, Guangdong, China

Test specification:

Standard..... : FCC CFR Title 47 Part 15 Subpart C Section 15.247
ANSI C63.10:2013

Test procedure..... : /

Non-standard test method : N/A

Test Report Form No..... : TRF-EL-111_V0**Test Report Form(s) Originator.....** : ZKT Testing**Master TRF** : Dated: 2021-08-26

This device described above has been tested by ZKT, and the test results show that the equipment under test (EUT) is in compliance with the FCC requirements. And it is applicable only to the tested sample identified in the report.

This report shall not be reproduced except in full, without the written approval of ZKT, this document may be altered or revised by ZKT, personal only, and shall be noted in the revision of the document.

Product name..... : USB+Bluetooth+2.4G 3 mode Keyboard

Trademark : Skyloong

Model/Type reference..... : GK75S, GK75XS, AK75S, SK75S, JK-223

Ratings..... : DC 3.7V by battery (4000mAh); Charging input: DC 5V

Testing procedure and testing location:

Testing Laboratory.....: **Shenzhen ZKT Technology Co., Ltd.**

Address.....: 1/F, No. 101, Building B, No. 6, Tangwei Community Industrial Avenue, Fuhai Street, Bao'an District, Shenzhen, China

Tested by (name + signature).....: Alen He

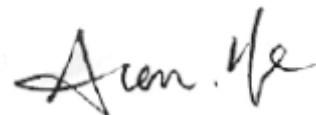

Reviewer (name + signature).....: Joe Liu



Approved (name + signature).....: Lake Xie



Table of Contents

Page

1.VERSION	5
2.SUMMARY OF TEST RESULTS	6
2.1 TEST FACILITY	7
2.2 MEASUREMENT UNCERTAINTY	7
3. GENERAL INFORMATION	8
3.1 GENERAL DESCRIPTION OF EUT	8
3.2 DESCRIPTION OF TEST MODES	9
3.3 BLOCK DIGRAM SHOWING THE CONFIGURATION OF SYSTEM TESTED	9
3.4 DESCRIPTION OF SUPPORT UNITS(CONDUCTED MODE)	9
3.5 EQUIPMENTS LIST FOR ALL TEST ITEMS	10
4. EMC EMISSION TEST	11
4.1 CONDUCTED EMISSION MEASUREMENT	11
4.1.1 POWER LINE CONDUCTED EMISSION LIMITS	11
4.1.2 TEST PROCEDURE	11
4.1.3 DEVIATION FROM TEST STANDARD	11
4.1.4 TEST SETUP	12
4.1.5 EUT OPERATING CONDITIONS	12
4.1.6 TEST RESULTS	13
4.2 RADIATED EMISSION MEASUREMENT	15
4.2.1 RADIATED EMISSION LIMITS	15
4.2.2 TEST PROCEDURE	16
4.2.3 DEVIATION FROM TEST STANDARD	16
4.2.4 TEST SETUP	16
4.2.5 EUT OPERATING CONDITIONS	17
5.RADIATED BAND EMISSION MEASUREMENT	22
5.1 TEST REQUIREMENT:	22
5.2 TEST PROCEDURE	22
5.3 DEVIATION FROM TEST STANDARD	22
5.4 TEST SETUP	23
5.5 EUT OPERATING CONDITIONS	23
5.6 TEST RESULT	24
6.POWER SPECTRAL DENSITY TEST	25
6.1 APPLIED PROCEDURES / LIMIT	25
6.2 TEST PROCEDURE	25
6.3 DEVIATION FROM STANDARD	25
6.4 TEST SETUP	25

Table of Contents	Page
6.5 EUT OPERATION CONDITIONS	25
6.6 TEST RESULTS	26
7. CHANNEL BANDWIDTH	28
7.1 APPLIED PROCEDURES / LIMIT	28
7.2 TEST PROCEDURE	28
7.3 DEVIATION FROM STANDARD	28
7.4 TEST SETUP	28
7.5 EUT OPERATION CONDITIONS	28
7.6 TEST RESULTS	29
8. PEAK OUTPUT POWER TEST	31
8.1 APPLIED PROCEDURES / LIMIT	31
8.2 TEST PROCEDURE	31
8.3 DEVIATION FROM STANDARD	31
8.4 TEST SETUP	31
8.5 EUT OPERATION CONDITIONS	31
8.6 TEST RESULTS	32
9. CONDUCTED BAND EDGE AND SPURIOUS EMISSION	34
9.1 APPLICABLE STANDARD	34
9.2 TEST PROCEDURE	34
9.3 DEVIATION FROM STANDARD	34
9.4 TEST SETUP	34
9.5 EUT OPERATION CONDITIONS	34
10. ANTENNA REQUIREMENT	41
11. TEST SETUP PHOTO	42
12. EUT CONSTRUCTIONAL DETAILS	42

1.VERSION

Report No.	Version	Description	Approved
ZKT-221227L9719-1	Rev.01	Initial issue of report	Jan. 04, 2023

2.SUMMARY OF TEST RESULTS

Test procedures according to the technical standards:

FCC Part15 (15.247) , Subpart C			
Standard Section	Test Item	Judgment	Remark
FCC part 15.203/15.247 (c)	Antenna requirement	PASS	
FCC part 15.207	AC Power Line Conducted Emission	PASS	
FCC part 15.247 (b)(3)	Conducted Peak Output Power	PASS	
FCC part 15.247 (a)(2)	6dB Bandwidth& 99% OCB	PASS	
FCC part 15.247 (e)	Power Spectral Density	PASS	
FCC part 15.247(d)	Conducted Unwanted emissions and Bandedge	PASS	
FCC part 15.205/15.209	Radiated Emission and Restricted Bands	PASS	

NOTE:

(1)" N/A" denotes test is not applicable in this Test Report

2.1 TEST FACILITY

Shenzhen ZKT Technology Co., Ltd.

Add. : 1/F, No. 101, Building B, No. 6, Tangwei Community Industrial Avenue, Fuhai Street, Bao'an District, Shenzhen, China

FCC Test Firm Registration Number: 692225

Designation Number: CN1299

IC Registered No.: 27033

2.2 MEASUREMENT UNCERTAINTY

The reported uncertainty of measurement $y \pm U$ · where expanded uncertainty U is based on a standard uncertainty multiplied by a coverage factor of $k=2$ · providing a level of confidence of approximately 95 % ·

No.	Item	Uncertainty
1	Conducted Emission Test	$\pm 1.38\text{dB}$
2	RF power conducted	$\pm 0.16\text{dB}$
3	Spurious emissions conducted	$\pm 0.21\text{dB}$
4	All emissions radiated(<1G)	$\pm 4.68\text{dB}$
5	All emissions radiated(>1G)	$\pm 4.89\text{dB}$
6	Temperature	$\pm 0.5^\circ\text{C}$
7	Humidity	$\pm 2\%$

3. GENERAL INFORMATION

3.1 GENERAL DESCRIPTION OF EUT

Product Name:	USB+Bluetooth+2.4G 3 mode Keyboard
Test Model No.:	GK75S
Sample ID:	ZKT221227L9719-1#
Serial No.:	GK75XS, AK75S, SK75S, JK-223
Model Different.:	All models identical to PCB Layout, schematics and construction, The differences only are the model names.
Hardware Version:	V1.0
Software Version:	V1.0
Sample(s) Status:	Engineer sample
Operation Frequency:	2402MHz~2480MHz
Channel Numbers:	40
Channel Separation:	2MHz
Modulation Type:	GFSK
Antenna Type:	PCB Antenna
Antenna gain:	-3.32dBi
Power supply:	DC 3.7V by battery (4000mAh); Charging input: DC 5V
Battery information:	Model: XHP5044130 Nominal Voltage: 3.7V Nominal Capacity: 4000mAh/14.8Wh Charging Limit Voltage: 4.2V

Operation Frequency each of channel							
Channel	Frequency	Channel	Frequency	Channel	Frequency	Channel	Frequency
1	2402 MHz	11	2422 MHz	21	2442 MHz	31	2462 MHz
2	2404 MHz	12	2424 MHz	22	2444 MHz	32	2464 MHz
3	2406 MHz	13	2426 MHz	23	2446 MHz	33	2466 MHz
4	2408 MHz	14	2428 MHz	24	2448 MHz	34	2468 MHz
5	2410 MHz	15	2430 MHz	25	2450 MHz	35	2470 MHz
6	2412 MHz	16	2432 MHz	26	2452 MHz	36	2472 MHz
7	2414 MHz	17	2434 MHz	27	2454 MHz	37	2474 MHz
8	2416 MHz	18	2436 MHz	28	2456 MHz	38	2476 MHz
9	2418 MHz	19	2438 MHz	29	2458 MHz	39	2478 MHz
10	2420 MHz	20	2440 MHz	30	2460 MHz	40	2480 MHz

Note:

In section 15.31(m), regards to the operating frequency range over 10 MHz, the Lowest frequency, the middle frequency, and the highest frequency of channel were selected to perform the test, and the selected channel see below:

Channel	Frequency
The lowest channel	2402MHz
The middle channel	2440MHz
The Highest channel	2480MHz

3.2 DESCRIPTION OF TEST MODES

Transmitting mode	Keep the EUT in continuously transmitting mode
Remark: During the test, the test voltage was tuned from 85% to 115% of the nominal rated supply voltage, and found that the worst case was under the nominal rated supply condition. So the report just shows that condition's data.	

Test Software	nRF_DTM.exe
Power level setup	0dBm

3.3 BLOCK DIGRAM SHOWING THE CONFIGURATION OF SYSTEM TESTED

Conducted Emission



Radiated Emission



Conducted Spurious



3.4 DESCRIPTION OF SUPPORT UNITS(CONDUCTED MODE)

The EUT has been tested as an independent unit together with other necessary accessories or support units. The following support units or accessories were used to form a representative test configuration during the tests.

Item	Equipment	Mfr/Brand	Model/Type No.	Series No.	Note
E-1	USB+Bluetooth h+2.4G 3 mode Keyboard	Skyloong	GK75S	N/A	EUT
AE-1	Notebook	lenovo	B40-80	MP07F6JD	AE
AE-2	Adapter	N/A	SC-41	N/A	Input: 100-240V~ 50/60Hz 0.3A Output: DC 5V 2.0A
Item	Shielded Type	Ferrite Core	Length	Note	

Note:

- (1) The support equipment was authorized by Declaration of Confirmation.
- (2) For detachable type I/O cable should be specified the length in cm in 『Length』 column.

3.5 EQUIPMENTS LIST FOR ALL TEST ITEMS
Radiation & RF Conducted Test equipment

Item	Equipment	Manufacturer	Type No.	Serial No.	Last calibration	Calibrated until
1	Spectrum Analyzer (9kHz-26.5GHz)	KEYSIGHT	9020A	MY45109572	Oct. 17, 2022	Oct. 17, 2023
2	Spectrum Analyzer (1GHz-40GHz)	Agilent	E4446A	100363	Oct. 17, 2022	Oct. 17, 2023
3	Test Receiver (9kHz-7GHz)	R&S	ESC17	101169	Oct. 17, 2022	Oct. 17, 2023
4	Bilog Antenna (30MHz-1400MHz)	Schwarzbeck	VULB9168	00877	Oct. 17, 2022	Oct. 17, 2023
5	Horn Antenna (1GHz-18GHz)	SCHWARZBEC K	BBHA9120D	1541	Oct. 17, 2022	Oct. 17, 2023
6	Horn Antenna (18GHz-40GHz)	A.H. System	SAS-574	588	Oct. 17, 2022	Oct. 17, 2023
7	Amplifier (30-1000MHz)	EM Electronics	EM330 Amplifier	N/A	Oct. 17, 2022	Oct. 17, 2023
8	Amplifier (1GHz-40GHz)	QuanJuDa	DLE-161	097	Oct. 17, 2022	Oct. 17, 2023
9	Loop Antenna (9KHz-30MHz)	SCHWARZBEC K	FMZB1519B	014	Oct. 17, 2022	Oct. 17, 2023
10	RF cables1 (9kHz-30MHz)	N/A	9kHz-30MHz	N/A	Oct. 17, 2022	Oct. 17, 2023
11	RF cables2 (30MHz-1GHz)	N/A	30MHz-1GHz	N/A	Oct. 17, 2022	Oct. 17, 2023
12	RF cables3 (1GHz-40GHz)	N/A	1GHz-40GHz	N/A	Oct. 17, 2022	Oct. 17, 2023
13	CMW500 Test	R&S	CMW500	106504	Oct. 17, 2022	Oct. 17, 2023
14	ESG Signal Generator	Agilent	E4421B	GB40051203	Oct. 17, 2022	Oct. 17, 2023
15	Signal Generator	Agilent	N5182A	MY47420215	Oct. 17, 2022	Oct. 17, 2023
16	D.C. Power Supply	LongWei	TPR-6405D	\	\	\
17	Software	Audix	E3	6.101223a	\	\

Conduction Test equipment

Item	Kind of Equipment	Manufacturer	Type No.	Serial No.	Last calibration	Calibrated until
1	LISN	R&S	ENV216	101471	Oct. 17, 2022	Oct. 17, 2023
2	LISN	CYBERTEK	EM5040A	E185040014 9	Oct. 17, 2022	Oct. 17, 2023
3	Test Cable	N/A	C01	N/A	Oct. 17, 2022	Oct. 17, 2023
4	Test Cable	N/A	C02	N/A	Oct. 17, 2022	Oct. 17, 2023
5	EMI Test Receiver	R&S	ESRP3	101946	Oct. 17, 2022	Oct. 17, 2023
6	Absorbing Clamp	DZ	ZN23201	N/A	Oct. 17, 2022	Oct. 17, 2023
7	Software	Audix	E3	6.101223a	\	\

4. EMC EMISSION TEST

4.1 CONDUCTED EMISSION MEASUREMENT

Test Requirement:	FCC Part15 C Section 15.207
Test Method:	ANSI C63.10:2013
Test Frequency Range:	150KHz to 30MHz
Receiver setup:	RBW=9KHz, VBW=30KHz, Sweep time=auto

4.1.1 POWER LINE CONDUCTED EMISSION Limits

FREQUENCY (MHz)	Limit (dBuV)		Standard
	Quas-peak	Average	
0.15 -0.5	66 - 56 *	56 - 46 *	FCC
0.50 -5.0	56.00	46.00	FCC
5.0 -30.0	60.00	50.00	FCC

Note:

(1) *Decreases with the logarithm of the frequency.

4.1.2 TEST PROCEDURE

- The EUT was placed 0.8 meters from the horizontal ground plane with EUT being connected to the power mains through a line impedance stabilization network (LISN). All other support equipments powered from additional LISN(s). The LISN provide 50 Ohm/ 50uH of coupling impedance for the measuring instrument.
- Interconnecting cables that hang closer than 40 cm to the ground plane shall be folded back and forth in the center forming a bundle 30 to 40 cm long.
- I/O cables that are not connected to a peripheral shall be bundled in the center. The end of the cable may be terminated, if required, using the correct terminating impedance. The overall length shall not exceed 1 m.
- LISN at least 80 cm from nearest part of EUT chassis.
- For the actual test configuration, please refer to the related Item –EUT Test Photos.

4.1.3 DEVIATION FROM TEST STANDARD

No deviation

4.1.4 TEST SETUP

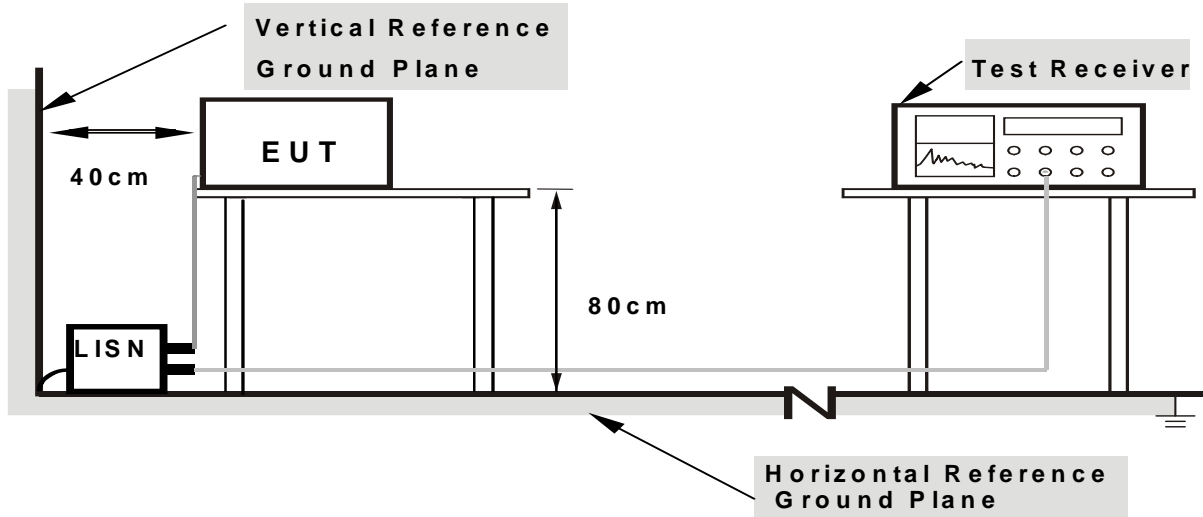

- Note:**
1. Support units were connected to second LISN.
 2. Both of LISNs (AMN) are 80 cm from EUT and at least 80 cm from other units and other metal planes

4.1.5 EUT OPERATING CONDITIONS

The EUT was configured for testing in a typical fashion (as a customer would normally use it). The EUT has been programmed to continuously transmit during test. This operating condition was tested and used to collect the included data.

We pretest AC 120V and AC 230V, the worst voltage was AC 120V and the data recording in the report.

4.1.6 TEST RESULTS

Temperature :	26°C	Relative Humidity:	54%
Pressure :	101kPa	Phase :	L
Test Voltage :	AC 120V/60Hz	Test Mode:	Transmitting mode of GFSK 2402MHz

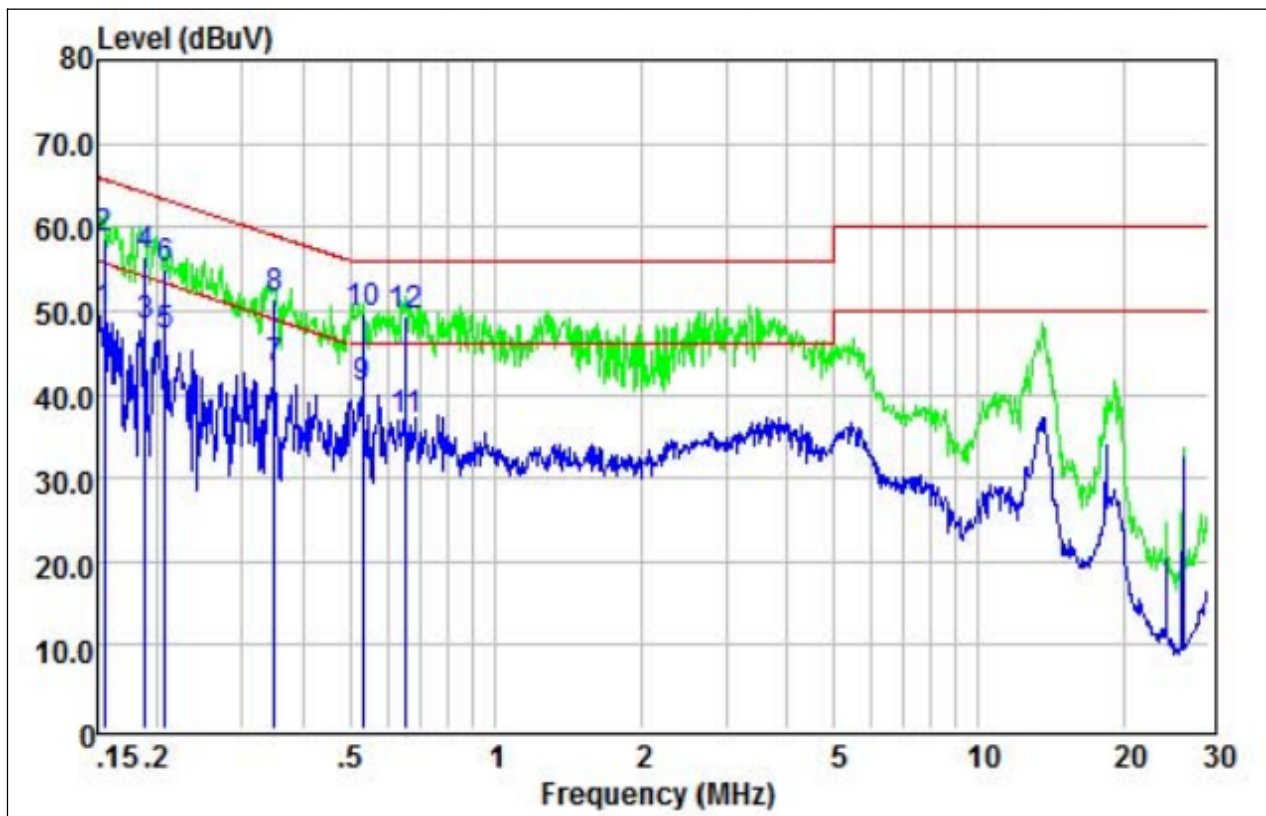

	Read Freq	Read Level	LISN Factor	Cable Loss	Level	Limit Line	Over Limit	Remark
	MHz	dBuV	dB	dB	dBuV	dBuV	dB	
1	0.15	39.96	9.63	0.05	49.64	55.74	-6.10	Average
2	0.15	48.95	9.63	0.05	58.63	65.74	-7.11	QP
3	0.19	38.62	9.64	0.05	48.31	54.11	-5.80	Average
4	0.19	46.84	9.64	0.05	56.53	64.11	-7.58	QP
5	0.21	37.40	9.64	0.05	47.09	53.32	-6.23	Average
6	0.21	45.27	9.64	0.05	54.96	63.32	-8.36	QP
7	0.35	33.41	9.65	0.05	43.11	49.00	-5.89	Average
8	0.35	41.65	9.65	0.05	51.35	59.00	-7.65	QP
9	0.53	30.96	9.68	0.05	40.69	46.00	-5.31	Average
10	0.53	39.90	9.68	0.05	49.63	56.00	-6.37	QP
11	0.65	27.13	9.65	0.05	36.83	46.00	-9.17	Average
12	0.65	39.62	9.65	0.05	49.32	56.00	-6.68	QP

Notes:

1. An initial pre-scan was performed on the line and neutral lines with peak detector.
2. Quasi-Peak and Average measurement were performed at the frequencies with maximized peak emission.
3. Measurement Level = Reading level + Correct Factor

Temperature :	26°C	Relative Humidity:	54%
Pressure :	101kPa	Phase :	N
Test Voltage :	AC 120V/60Hz	Test Mode:	Transmitting mode of GFSK 2402MHz

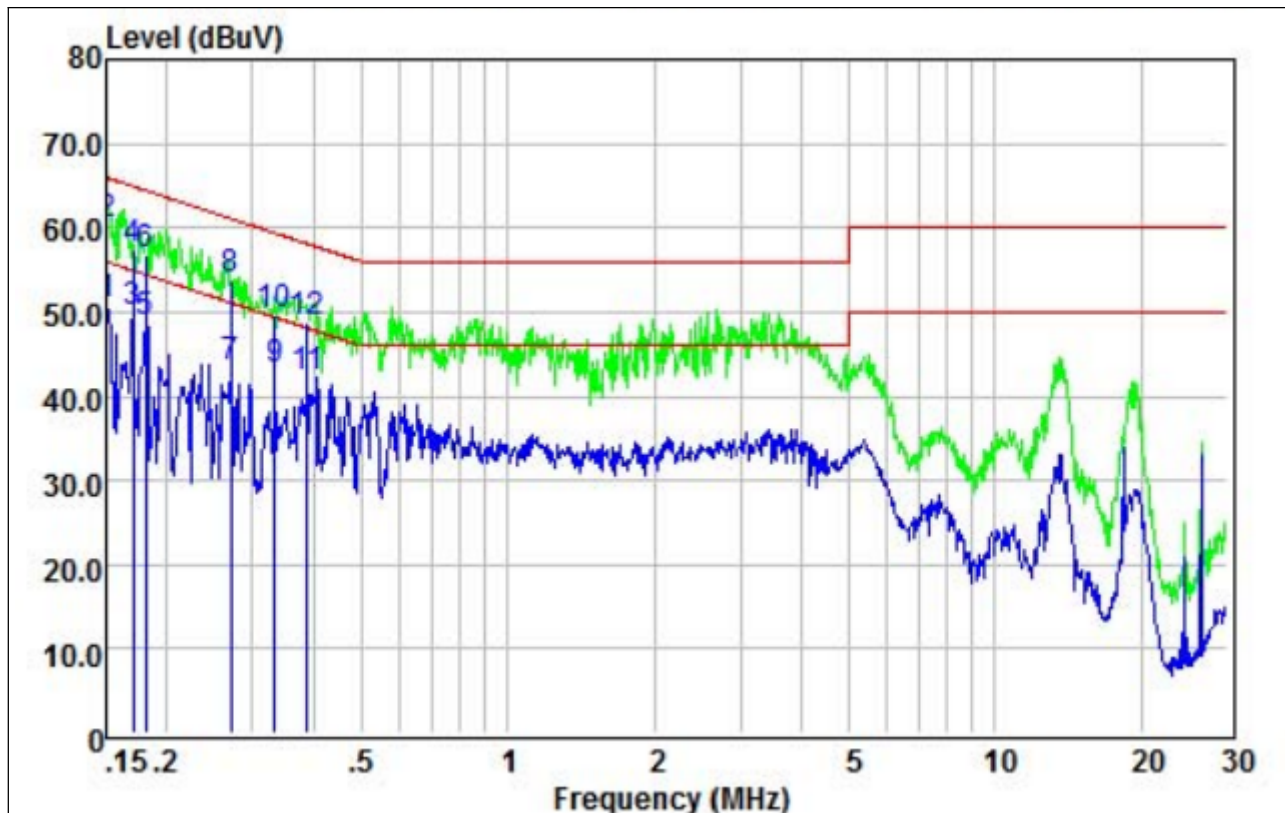

	Read Freq	Read Level	LISN Factor	Cable Loss	Level	Limit Line	Over Limit	Remark
	MHz	dBuV	dB	dB	dBuV	dBuV	dB	
1	0.15	41.27	9.61	0.05	50.93	55.96	-5.03	Average
2	0.15	50.85	9.61	0.05	60.51	65.96	-5.45	QP
3	0.17	40.33	9.57	0.05	49.95	54.94	-4.99	Average
4	0.17	47.74	9.57	0.05	57.36	64.94	-7.58	QP
5	0.18	39.26	9.55	0.05	48.86	54.46	-5.60	Average
6	0.18	47.27	9.55	0.05	56.87	64.46	-7.59	QP
7	0.27	33.78	9.54	0.05	43.37	51.12	-7.75	Average
8	0.27	44.25	9.54	0.05	53.84	61.12	-7.28	QP
9	0.33	33.48	9.58	0.05	43.11	49.35	-6.24	Average
10	0.33	39.99	9.58	0.05	49.62	59.35	-9.73	QP
11	0.39	32.69	9.61	0.05	42.35	48.08	-5.73	Average
12	0.39	38.97	9.61	0.05	48.63	58.08	-9.45	QP

Notes:

1. An initial pre-scan was performed on the line and neutral lines with peak detector.
2. Quasi-Peak and Average measurement were performed at the frequencies with maximized peak emission.
3. Measurement Level = Reading level + Correct Factor

4.2 RADIATED EMISSION MEASUREMENT

Test Requirement:	FCC Part15 C Section 15.209				
Test Method:	ANSI C63.10:2013				
Test Frequency Range:	9kHz to 25GHz				
Test site:	Measurement Distance: 3m				
Receiver setup:	Frequency	Detector	RBW	VBW	Value
	9KHz-150KHz	Quasi-peak	200Hz	600Hz	Quasi-peak
	150KHz-30MHz	Quasi-peak	9KHz	30KHz	Quasi-peak
	30MHz-1GHz	Quasi-peak	120KHz	300KHz	Quasi-peak
	Above 1GHz	Peak	1MHz	3MHz	Peak
Peak		1MHz	1/T	Average	

4.2.1 RADIATED EMISSION LIMITS

Frequencies (MHz)	Field Strength (micorvolts/meter)	Measurement Distance (meters)
0.009~0.490	2400/F(KHz)	300
0.490~1.705	24000/F(KHz)	30
1.705~30.0	30	30
30~88	100	3
88~216	150	3
216~960	200	3
Above 960	500	3

LIMITS OF RADIATED EMISSION MEASUREMENT

FREQUENCY (MHz)	Limit (dBuV/m) (at 3M)	
	PEAK	AVERAGE
Above 1000	74	54

Notes:

- (1) The limit for radiated test was performed according to FCC PART 15C.
- (2) The tighter limit applies at the band edges.
- (3) Emission level (dBuV/m)=20log Emission level (uV/m).

4.2.2 TEST PROCEDURE

- a. The measuring distance of at 3 m shall be used for measurements at frequency up to 25GHz. For frequencies above 1GHz, any suitable measuring distance may be used.
- b. The EUT was placed on the top of a rotating table 0.8 meters above the ground at a 3 meter semi-chamber test. The table was rotated 360 degrees to determine the position of the highest radiation.
- c. The height of the equipment or of the substitution antenna shall be 0.8m; above 1GHz, the height was 1.5m, the height of the test antenna shall vary between 1 m to 4 m. Both horizontal and vertical polarizations of the antenna are set to make the measurement.
- d. The initial step in collecting conducted emission data is a spectrum analyzer peak detector mode pre-scanning the measurement frequency range. Significant peaks are then marked and then Quasi Peak detector mode re-measured.
- e. If the Peak Mode measured value compliance with and lower than Quasi Peak Mode Limit, the EUT shall be deemed to meet QP Limits and then no additional QP Mode measurement performed.
- f. For the actual test configuration, please refer to the related Item –EUT Test Photos.

g. For the radiated emission test above 1GHz:

Place the measurement antenna away from each area of the EUT determined to be a source of emissions at the specified measurement distance, while keeping the measurement antenna aimed at the source of emissions at each frequency of significant emissions, with polarization oriented for maximum response.

The measurement antenna may have to be higher or lower than the EUT, depending on the radiation pattern of the emission and staying aimed at the emission source for receiving the maximum signal. The final measurement antenna elevation shall be that which maximizes the emissions. The measurement antenna elevation for maximum emissions shall be restricted to a range of heights of from 1 m to 4 m above the ground or reference ground plane.

Note:

Both horizontal and vertical antenna polarities were tested and performed pretest to three orthogonal axis. The worst case emissions were reported

4.2.3 DEVIATION FROM TEST STANDARD

No deviation

4.2.4 TEST SETUP

(A) Radiated Emission Test-Up Frequency Below 30MHz

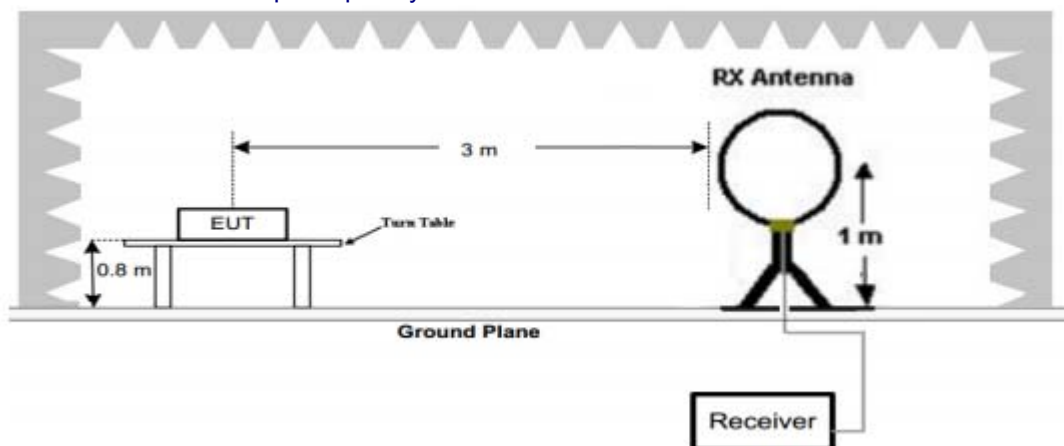

(B) Radiated Emission Test-Up Frequency 30MHz~1GHz

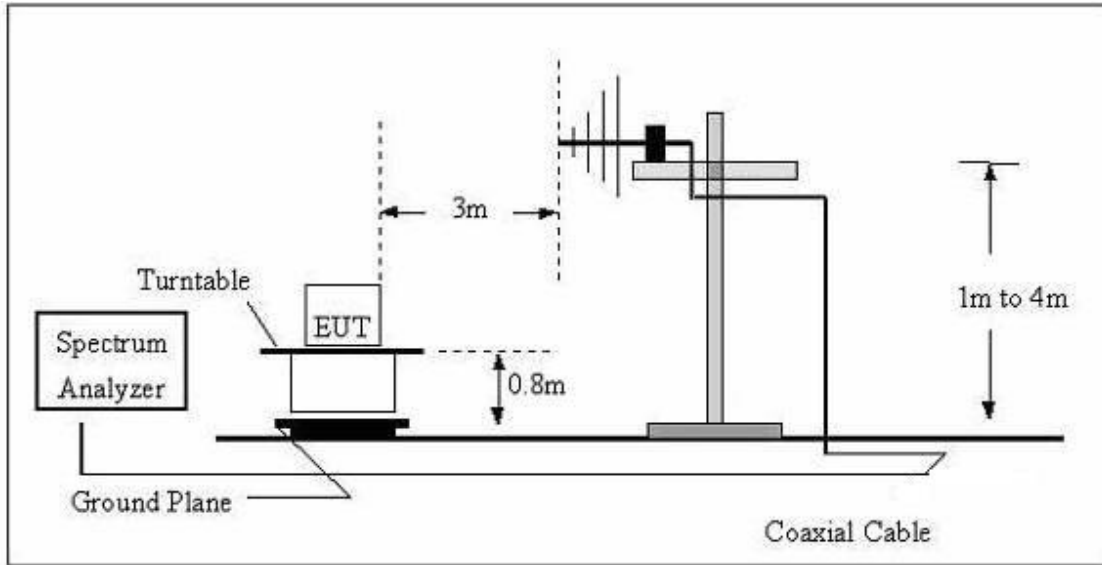

(C) Radiated Emission Test-Up Frequency Above 1GHz

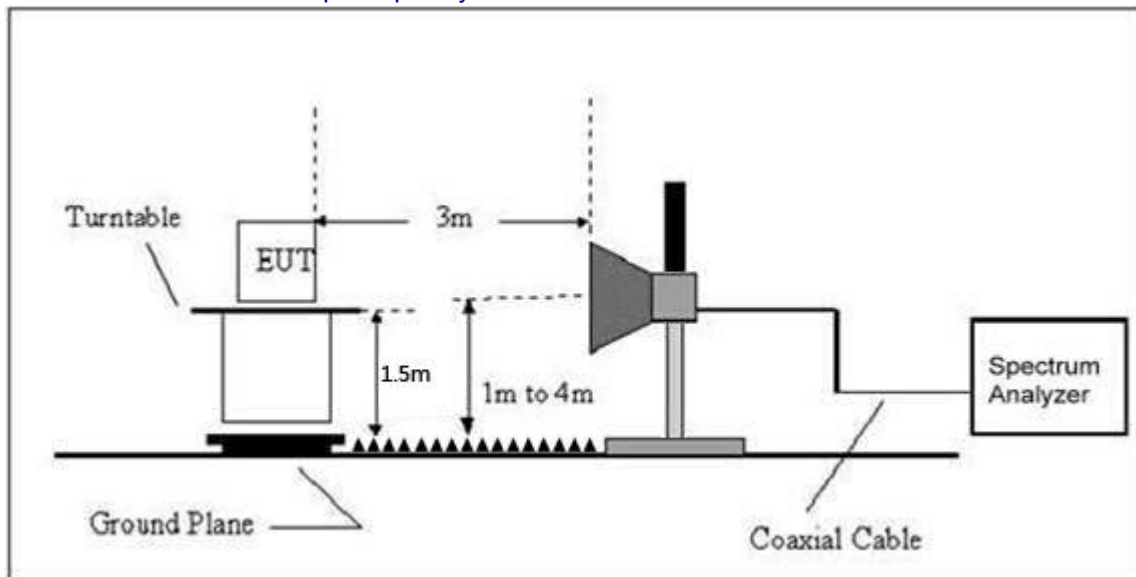

4.2.5 EUT OPERATING CONDITIONS

The EUT tested system was configured as the statements of 2.4 Unless otherwise a special operating condition is specified in the follows during the testing.

4.2.6 TEST RESULTS (Between 9KHz – 30 MHz)

The emission from 9 kHz to 30MHz was pre-tested and found the result was 20dB lower than the limit, and according to 15.31(o) & RSS-Gen 6.13, the test result no need to reported.

Between 30MHz – 1GHz

Temperature:	26°C	Relative Humidity:	54%
Pressure:	101 kPa	Polarization:	Horizontal
Test Voltage:	DC 3.7V from battery		
Test Mode:	Transmitting mode of GFSK 2402MHz		

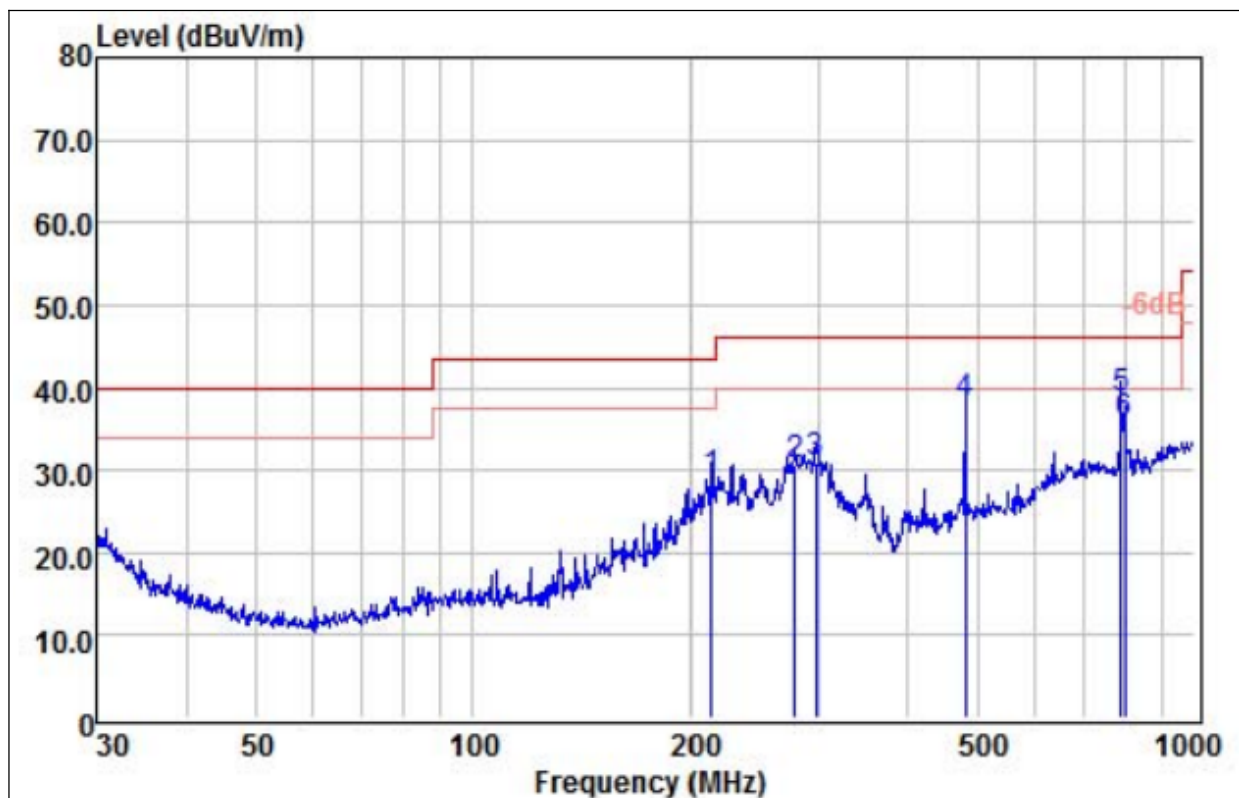

	Read Freq	Antenna Level	Cable Factor	Cable Loss	Limit Level	Over Limit	Remark
	MHz	dBuV	dB/m	dB	dBuV/m	dB	
1	213.76	16.38	11.60	0.88	28.86	43.50	-14.64 QP
2	279.04	16.67	13.00	0.86	30.53	46.00	-15.47 QP
3	298.27	16.30	13.80	0.85	30.95	46.00	-15.05 QP
4	480.53	17.94	18.40	1.59	37.93	46.00	-8.07 QP
5	790.62	13.57	22.92	2.17	38.66	46.00	-7.34 QP
6	801.79	10.51	23.02	2.19	35.72	46.00	-10.28 QP

Temperature:	26°C	Relative Humidity:	54%
Pressure:	101kPa	Polarization:	Vertical
Test Voltage:	DC 3.7V from battery		
Test Mode:	Transmitting mode of GFSK 2402MHz		

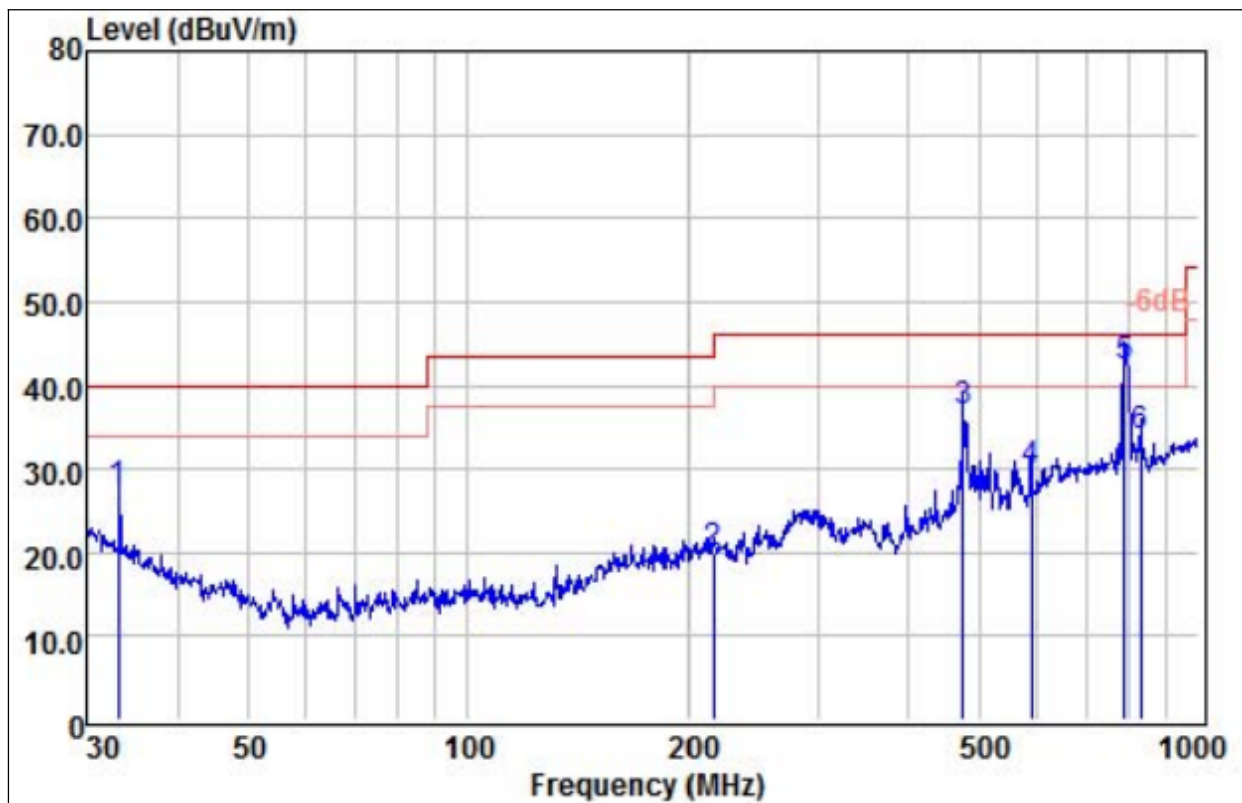

	Read	Antenna	Cable	Limit	Over			
Freq	Level	Factor	Loss	Line	Limit	Remark		
MHz	dBuV	dB/m	dB	dBuV/m	dBuV/m	dB		
1	33.21	9.91	16.91	0.47	27.29	40.00	-12.71	QP
2	216.02	7.17	11.77	0.87	19.81	46.00	-26.19	QP
3	475.50	17.05	18.31	1.57	36.93	46.00	-9.07	QP
4	588.91	8.06	20.24	1.50	29.80	46.00	-16.20	QP
5 !	790.62	17.20	22.89	2.17	42.26	46.00	-3.74	QP
6	833.32	8.71	23.10	2.17	33.98	46.00	-12.02	QP

Remarks:

- 1.Final Level =Receiver Read level + Antenna Factor + Cable Loss
- 2.The emission levels of other frequencies are very lower than the limit and not show in test report.

1GHz~25GHz

Polar (H/V)	Frequency	Meter Reading	Pre-amplifier	Cable Loss	Antenna Factor	Emission Level	Limits	Margin	Detector Type
	(MHz)	(dBuV)	(dB)	(dB)	(dB)	(dBuV/m)	(dBuV/m)	(dB)	
Low Channel:2402MHz									
V	4804	56.27	30.55	5.77	24.66	56.15	74	-17.85	Pk
V	4804	46.57	30.55	5.77	24.66	46.45	54	-7.55	AV
V	7206	55.73	30.33	6.32	24.55	56.27	74	-17.73	Pk
V	7206	45.27	30.33	6.32	24.55	45.81	54	-8.19	AV
V	9608	53.01	30.85	7.45	24.69	54.3	74	-19.7	Pk
V	9608	44.93	30.85	7.45	24.69	46.22	54	-7.78	AV
V	12010	51.83	31.02	8.99	25.57	55.37	74	-18.63	Pk
V	12010	42.63	31.02	8.99	25.57	46.17	54	-7.83	AV
H	4804	56.39	30.55	5.77	24.66	56.27	74	-17.73	Pk
H	4804	46.83	30.55	5.77	24.66	46.71	54	-7.29	AV
H	7206	54.37	30.33	6.32	24.55	54.91	74	-19.09	Pk
H	7206	44.61	30.33	6.32	24.55	45.15	54	-8.85	AV
H	9608	52.64	30.85	7.45	24.69	53.93	74	-20.07	Pk
H	9608	43.62	30.85	7.45	24.69	44.91	54	-9.09	AV
H	12010	51.49	31.02	8.99	25.57	55.03	74	-18.97	Pk
H	12010	42.69	31.02	8.99	25.57	46.23	54	-7.77	AV

Polar (H/V)	Frequency	Meter Reading	Pre-amplifier	Cable Loss	Antenna Factor	Emission Level	Limits	Margin	Detector Type
	(MHz)	(dBuV)	(dB)	(dB)	(dB)	(dBuV/m)	(dBuV/m)	(dB)	
Middle Channel:2440MHz									
V	4880	55.36	30.55	5.77	24.66	55.24	74	-18.76	Pk
V	4880	45.95	30.55	5.77	24.66	45.83	54	-8.17	AV
V	7320	54.16	30.33	6.32	24.55	54.7	74	-19.3	Pk
V	7320	44.83	30.33	6.32	24.55	45.37	54	-8.63	AV
V	9766	53.06	30.85	7.45	24.69	54.35	74	-19.65	Pk
V	9766	44.32	30.85	7.45	24.69	45.61	54	-8.39	AV
V	12200	52.01	31.02	8.99	25.57	55.55	74	-18.45	Pk
V	12200	42.96	31.02	8.99	25.57	46.5	54	-7.5	AV
H	4880	55.87	30.55	5.77	24.66	55.75	74	-18.25	Pk
H	4880	45.93	30.55	5.77	24.66	45.81	54	-8.19	AV
H	7320	54.82	30.33	6.32	24.55	55.36	74	-18.64	Pk
H	7320	44.93	30.33	6.32	24.55	45.47	54	-8.53	AV
H	9766	53.16	30.85	7.45	24.69	54.45	74	-19.55	Pk
H	9766	44.06	30.85	7.45	24.69	45.35	54	-8.65	AV
H	12200	52.27	31.02	8.99	25.57	55.81	74	-18.19	Pk
H	12200	43.07	31.02	8.99	25.57	46.61	54	-7.39	AV

Polar (H/V)	Frequency	Meter Reading	Pre-amplifier	Cable Loss	Antenna Factor	Emission Level	Limits	Margin	Detector Type
	(MHz)	(dBuV)	(dB)	(dB)	(dB)	(dBuV/m)	(dBuV/m)	(dB)	
High Channel:2480MHz									
V	4960	55.43	30.55	5.77	24.66	55.31	74	-18.69	Pk
V	4960	45.86	30.55	5.77	24.66	45.74	54	-8.26	AV
V	7440	54.67	30.33	6.32	24.55	55.21	74	-18.79	Pk
V	7440	44.91	30.33	6.32	24.55	45.45	54	-8.55	AV
V	9920	52.36	30.85	7.45	24.69	53.65	74	-20.35	Pk
V	9920	42.95	30.85	7.45	24.69	44.24	54	-9.76	AV
V	12400	51.89	31.02	8.99	25.57	55.43	74	-18.57	Pk
V	12400	42.37	31.02	8.99	25.57	45.91	54	-8.09	AV
H	4960	55.96	30.55	5.77	24.66	55.84	74	-18.16	Pk
H	4960	45.88	30.55	5.77	24.66	45.76	54	-8.24	AV
H	7440	54.73	30.33	6.32	24.55	55.27	74	-18.73	Pk
H	7440	44.61	30.33	6.32	24.55	45.15	54	-8.85	AV
H	9920	52.84	30.85	7.45	24.69	54.13	74	-19.87	Pk
H	9920	43.11	30.85	7.45	24.69	44.4	54	-9.6	AV
H	12400	51.47	31.02	8.99	25.57	55.01	74	-18.99	Pk
H	12400	42.63	31.02	8.99	25.57	46.17	54	-7.83	AV

Remark:

1. Emission Level = Meter Reading + Antenna Factor + Cable Loss – Pre-amplifier,
Margin= Emission Level - Limit
2. If peak below the average limit, the average emission was no test.
3. The amplitude of spurious emissions which are attenuated by more than 20dB below the permissible value has no need to be reported.

5. RADIATED BAND EMISSION MEASUREMENT

5.1 TEST REQUIREMENT:

Test Requirement:	FCC Part15 C Section 15.209 and 15.205				
Test Method:	ANSI C63.10: 2013				
Test Frequency Range:	All of the restrict bands were tested, only the worst band's (2310MHz to 2500MHz) data was showed.				
Test site:	Measurement Distance: 3m				
Receiver setup:	Frequency	Detector	RBW	VBW	Value
	Above 1GHz	Peak	1MHz	3MHz	Peak
		Average	1MHz	1/T	Average

LIMITS OF RADIATED EMISSION MEASUREMENT (Above 1000MHz)

FREQUENCY (MHz)	Limit (dBuV/m) (at 3M)	
	PEAK	AVERAGE
Above 1000	74	54

Notes:

- (1) The limit for radiated test was performed according to FCC PART 15C.
- (2) The tighter limit applies at the band edges.
- (3) Emission level (dBuV/m)=20log Emission level (uV/m).

5.2 TEST PROCEDURE

Above 1GHz test procedure as below:

- a. 1. The EUT was placed on the top of a rotating table 1.5 meters above the ground at a 3 meter camber. The table was rotated 360 degrees to determine the position of the highest radiation.
- b. The EUT was set 3 meters away from the interference-receiving antenna, which was mounted on the top of a variable-height antenna tower.
- c. The antenna height is varied from one meter to four meters above the ground to determine the maximum value of the field strength. Both horizontal and vertical polarizations of the antenna are set to make the measurement.
- d. For each suspected emission, the EUT was arranged to its worst case and then the antenna was tuned to heights from 1 meter to 4 meters and the rota table was turned from 0 degrees to 360 degrees to find the maximum reading.
- e. The test-receiver system was set to Peak Detect Function and Specified Bandwidth with Maximum Hold Mode.
- f. If the emission level of the EUT in peak mode was 10dB lower than the limit specified, then testing could be stopped and the peak values of the EUT would be reported. Otherwise the emissions that did not have 10dB margin would be re-tested one by one using peak, quasi-peak or average method as specified and then reported in a data sheet.
- g. Test the EUT in the lowest channel, the Highest channel

Note:

Both horizontal and vertical antenna polarities were tested and performed pretest to three orthogonal axis. The worst case emissions were reported

5.3 DEVIATION FROM TEST STANDARD

No deviation

5.4 TEST SETUP

Radiated Emission Test-Up Frequency Above 1GHz

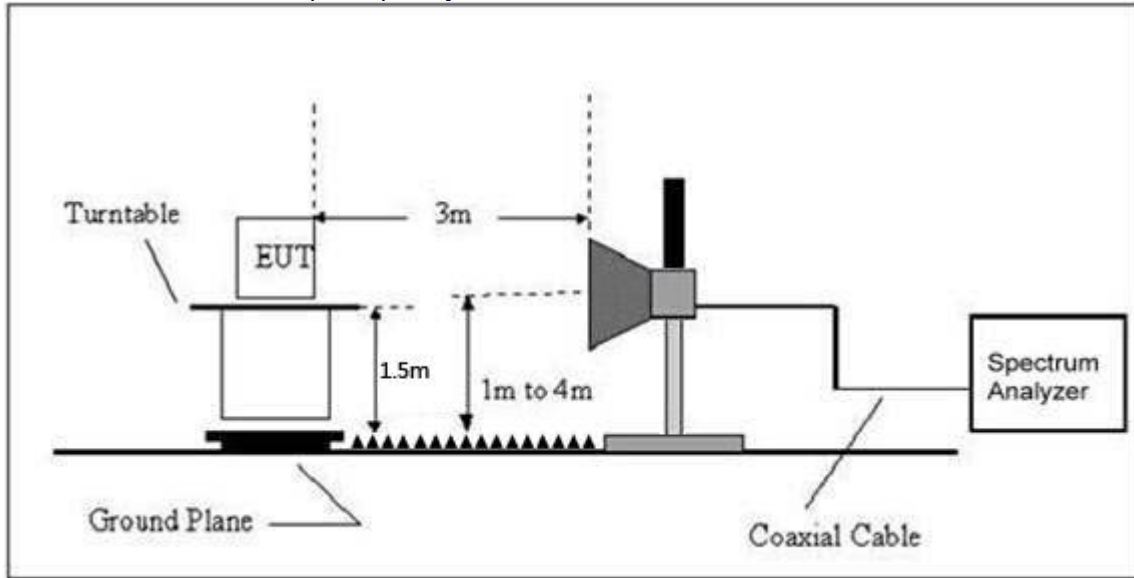

5.5 EUT OPERATING CONDITIONS

The EUT tested system was configured as the statements of 2.3 Unless otherwise a special operating condition is specified in the follows during the testing.

5.6 TEST RESULT

	Polar (H/V)	Frequency (MHz)	Meter Reading (dBuV)	Pre-amplifier (dB)	Cable Loss (dB)	Antenna Factor (dB/m)	Emission level (dBuV/m)	Limit (dBuV/m)	Detector Type	Result	
GFSK	Low Channel: 2402MHz										
	H	2310	55.63	30.21	4.83	23.97	54.22	74	PK	PASS	
	H	2310	45.24	30.21	4.83	23.97	43.83	54	AV	PASS	
	H	2390	54.16	30.22	4.85	23.98	52.77	74	PK	PASS	
	H	2390	44.96	30.22	4.85	23.98	43.57	54	AV	PASS	
	H	2400	54.51	30.23	4.86	23.99	53.13	74	PK	PASS	
	H	2400	44.16	30.23	4.86	23.99	42.78	54	AV	PASS	
	V	2310	56.32	30.21	4.83	23.97	54.91	74	PK	PASS	
	V	2310	46.37	30.21	4.83	23.97	44.96	54	AV	PASS	
	V	2390	54.28	30.22	4.85	23.98	52.89	74	PK	PASS	
	V	2390	45.83	30.22	4.85	23.98	44.44	54	AV	PASS	
	V	2400	54.21	30.23	4.86	23.99	52.83	74	PK	PASS	
	V	2400	44.89	30.23	4.86	23.99	43.51	54	AV	PASS	
	High Channel: 2480MHz										
	H	2483.5	55.39	30.36	4.92	24.11	54.06	74	PK	PASS	
	H	2483.5	45.27	30.36	4.92	24.11	43.94	54	AV	PASS	
	H	2500	54.16	30.38	4.94	24.14	52.86	74	PK	PASS	
	H	2500	44.63	30.38	4.94	24.14	43.33	54	AV	PASS	
	V	2483.5	55.86	30.36	4.92	24.11	54.53	74	PK	PASS	
	V	2483.5	45.92	30.36	4.92	24.11	44.59	54	AV	PASS	
V	2500	54.71	30.38	4.94	24.14	53.41	74	PK	PASS		
V	2500	44.93	30.38	4.94	24.14	43.63	54	AV	PASS		
Remark:											
1. Emission Level = Meter Reading + Antenna Factor + Cable Loss – Pre-amplifier, Margin= Emission Level - Limit											

6. POWER SPECTRAL DENSITY TEST

Test Requirement:	FCC Part15 C Section 15.247 (e)
Test Method:	KDB558074 D0115.247 Meas Guidance v05r02

6.1 APPLIED PROCEDURES / LIMIT

FCC Part15 (15.247) , Subpart C				
Section	Test Item	Limit	Frequency Range (MHz)	Result
15.247	Power Spectral Density	8dBm/3kHz	2400-2483.5	PASS

6.2 TEST PROCEDURE

1. Set analyzer center frequency to DTS channel center frequency.
2. Set the span to 1.5 times the DTS bandwidth.
3. Set the RBW to: $3 \text{ kHz} \leq \text{RBW} \leq 100 \text{ kHz}$.
4. Set the VBW $\geq 3 \times \text{RBW}$.
5. Detector = peak.
6. Sweep time = auto couple.
7. Trace mode = max hold.
8. Allow trace to fully stabilize.
9. Use the peak marker function to determine the maximum amplitude level within the RBW.
10. If measured value exceeds limit, reduce RBW (no less than 3 kHz) and repeat.

6.3 DEVIATION FROM STANDARD

No deviation.

6.4 TEST SETUP

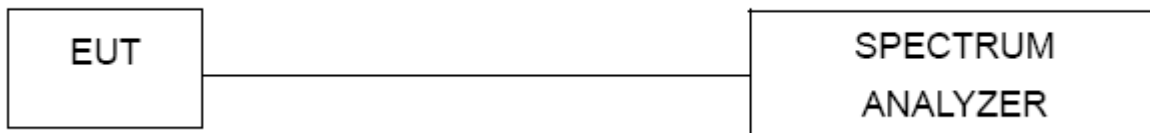

6.5 EUT OPERATION CONDITIONS

The EUT tested system was configured as the statements of 2.1 Unless otherwise a special operating condition is specified in the follows during the testing.

6.6 TEST RESULTS

Temperature :	26°C	Relative Humidity :	54%
Test Mode :	GFSK	Test Voltage :	DC 3.7V from battery

Frequency	Power Spectral Density(dBm)	Limit (dBm)	Result
2402 MHz	-16.176	8	PASS
2440 MHz	-16.333	8	PASS
2480 MHz	-16.399	8	PASS

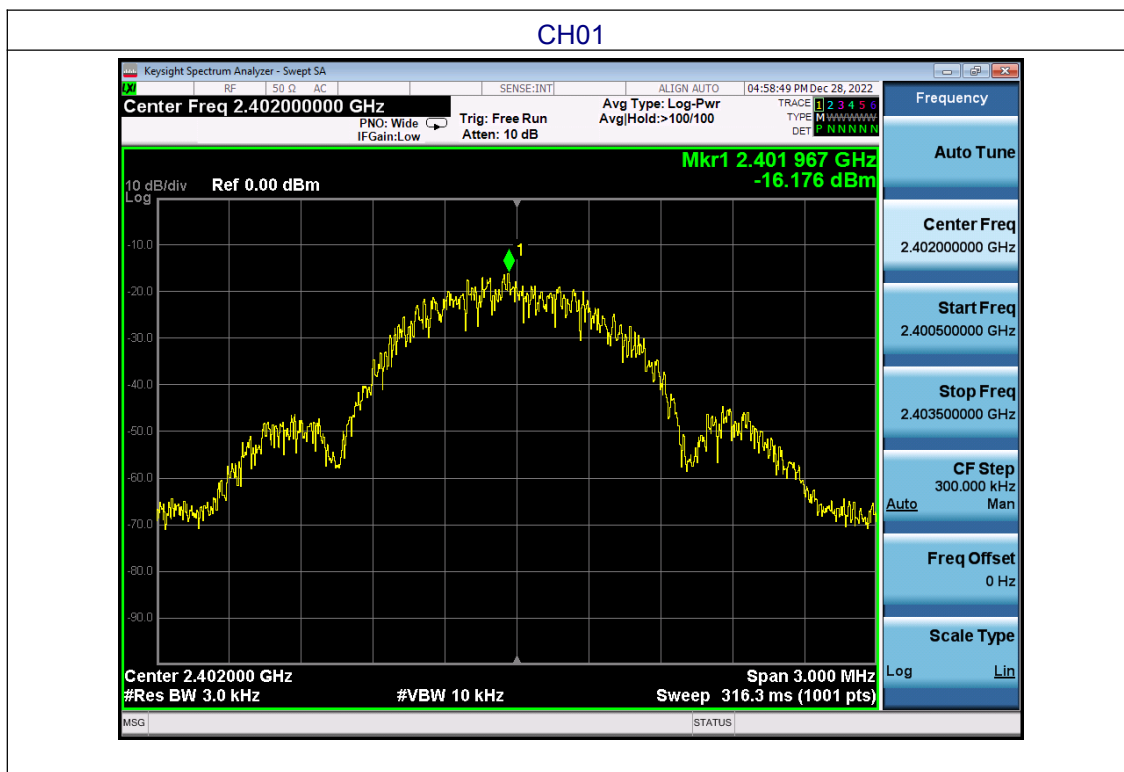

CH20

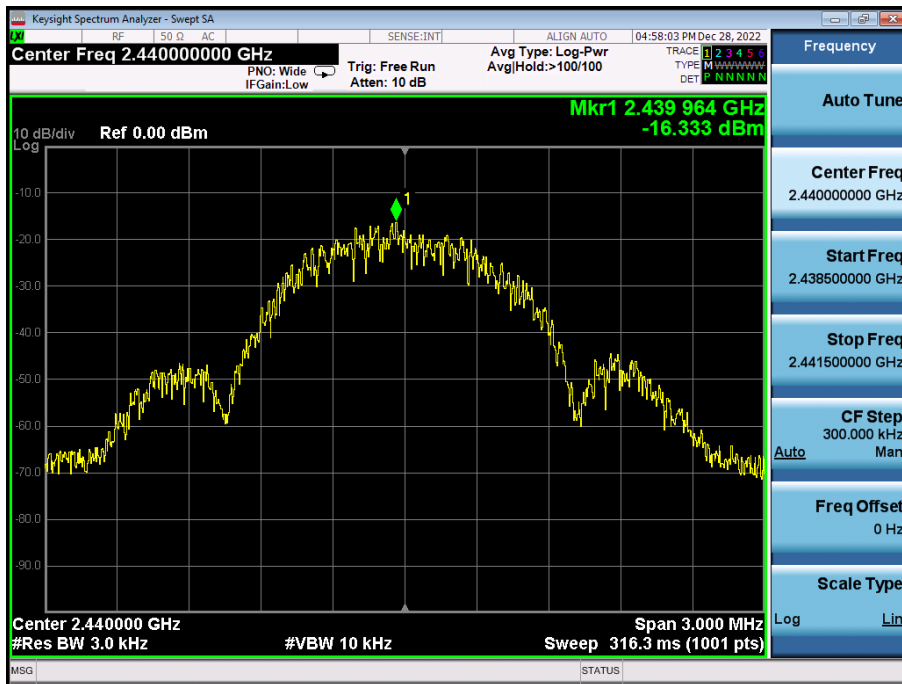

CH40



7. CHANNEL BANDWIDTH

Test Requirement:	FCC Part15 C Section 15.247 (a)(2)
Test Method:	KDB558074 D0115.247 Meas Guidance v05r02

7.1 APPLIED PROCEDURES / LIMIT

FCC Part15 (15.247) , Subpart C				
Section	Test Item	Limit	Frequency Range (MHz)	Result
15.247(a)(2)	Bandwidth	$\geq 500\text{KHz}$ (6dB bandwidth)	2400-2483.5	PASS

7.2 TEST PROCEDURE

1. Set RBW = 100 kHz.
2. Set the video bandwidth (VBW) $\geq 3 \times$ RBW.
3. Detector = Peak.
4. Trace mode = max hold.
5. Sweep = auto couple.
6. Allow the trace to stabilize.
7. Measure the maximum width of the emission that is constrained by the frequencies associated with the two outermost amplitude points (upper and lower frequencies) that are attenuated by 6 dB relative to the maximum level measured in the fundamental emission.

7.3 DEVIATION FROM STANDARD

No deviation.

7.4 TEST SETUP

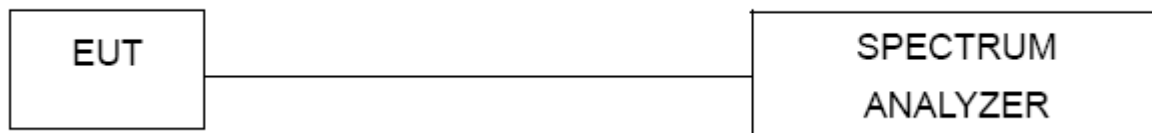

7.5 EUT OPERATION CONDITIONS

The EUT tested system was configured as the statements of 2.4 Unless otherwise a special operating condition is specified in the follows during the testing.

7.6 TEST RESULTS

Temperature :	26°C	Relative Humidity :	54%
Test Mode :	GFSK	Test Voltage :	DC 3.7V from battery

Test channel	6dB Bandwidth (MHz)	Limit(KHz)	Result
Lowest	0.693	>500	Pass
Middle	0.703		
Highest	0.693		

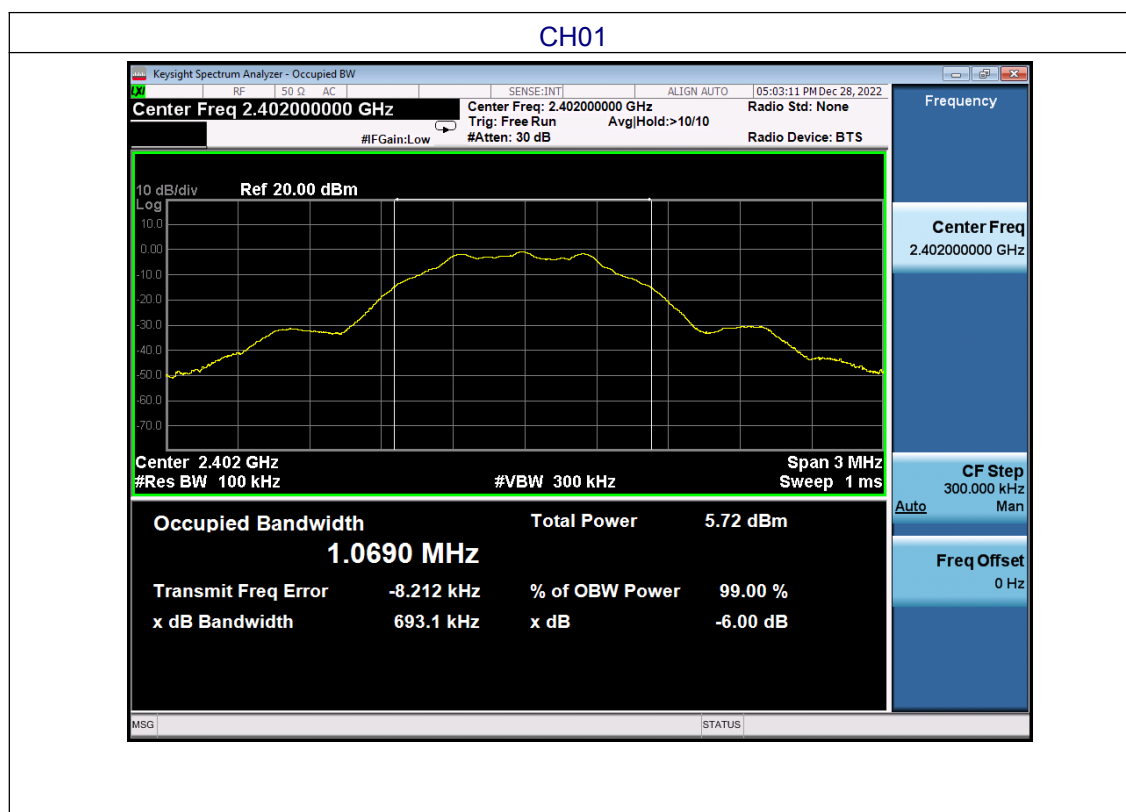

CH20



CH40

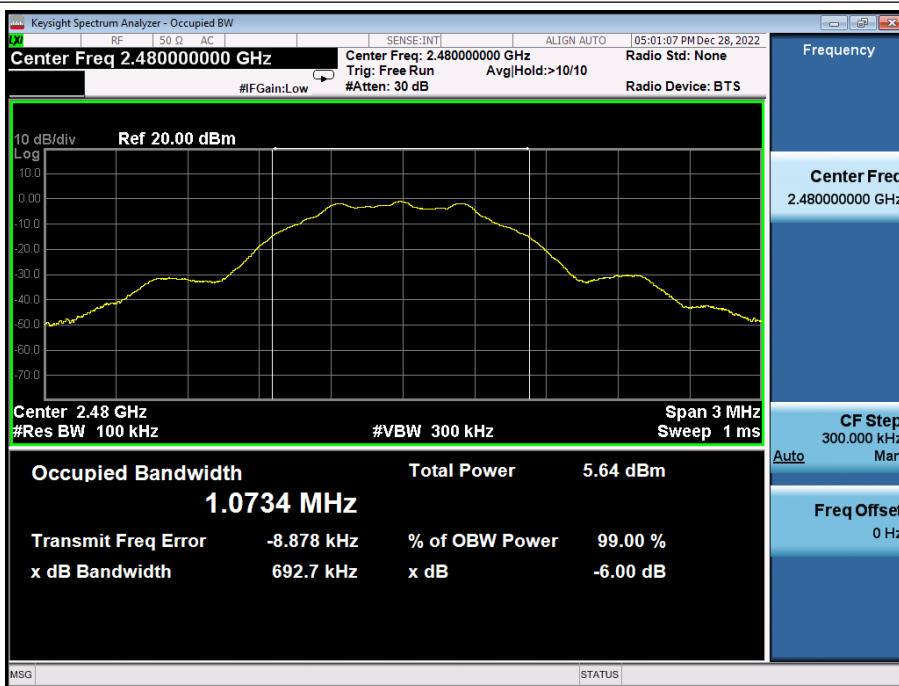

8. PEAK OUTPUT POWER TEST

Test Requirement:	FCC Part15 C Section 15.247 (b)(3)
Test Method:	KDB558074 D0115.247 Meas Guidance v05r02

8.1 APPLIED PROCEDURES / LIMIT

FCC Part15 (15.247) , Subpart C				
Section	Test Item	Limit	Frequency Range (MHz)	Result
15.247(b)(3)	Peak Output Power	1 watt or 30dBm	2400-2483.5	PASS

8.2 TEST PROCEDURE

- a. The EUT was directly connected to the Spectrum analyzer

8.3 DEVIATION FROM STANDARD

No deviation.

8.4 TEST SETUP

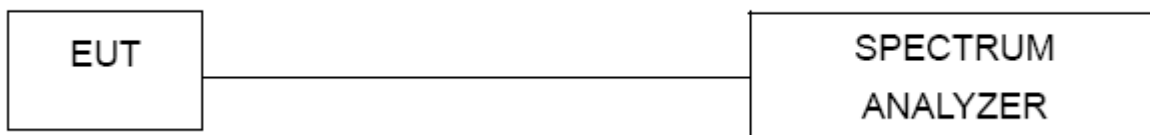

8.5 EUT OPERATION CONDITIONS

The EUT tested system was configured as the statements of 2.4 Unless otherwise a special operating condition is specified in the follows during the testing.

8.6 TEST RESULTS

Temperature :	26°C	Relative Humidity :	54%
Test Mode :	GFSK	Test Voltage :	DC 3.7V from battery

Test channel	Peak Output Power (dBm)	Limit(dBm)	Result
Lowest	-0.884	30.00	Pass
Middle	-1.020		
Highest	-0.994		

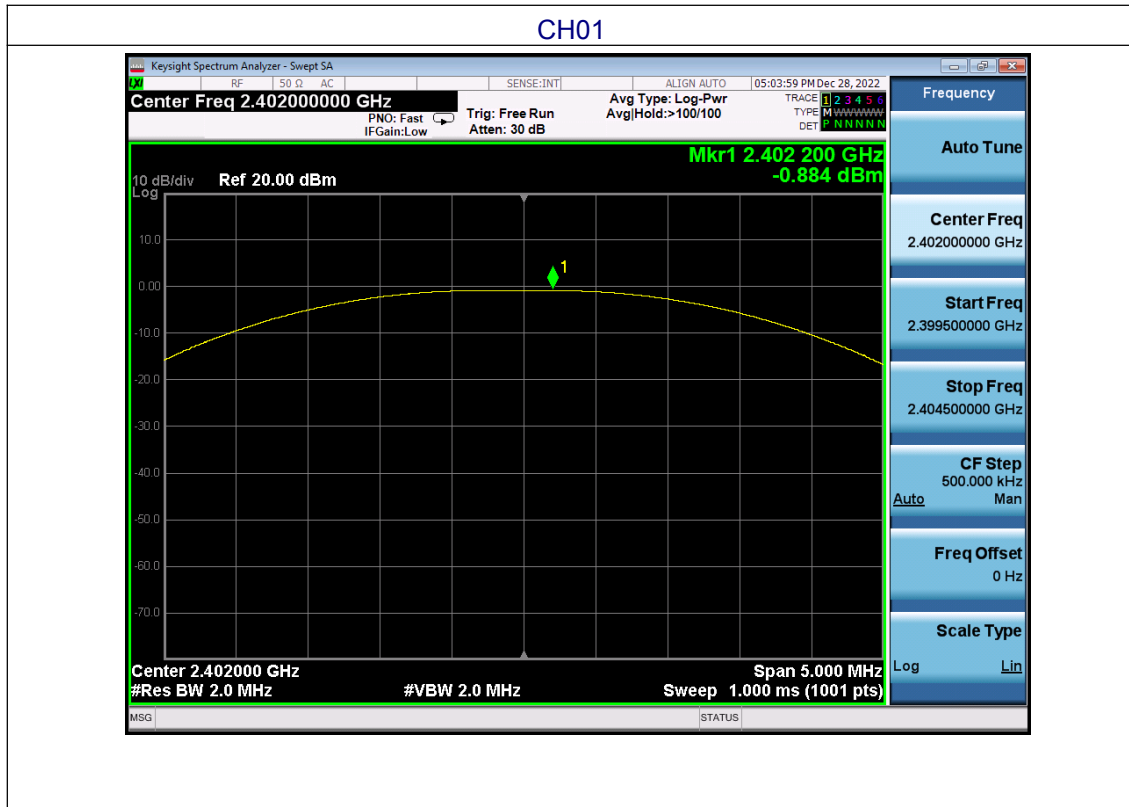

CH20

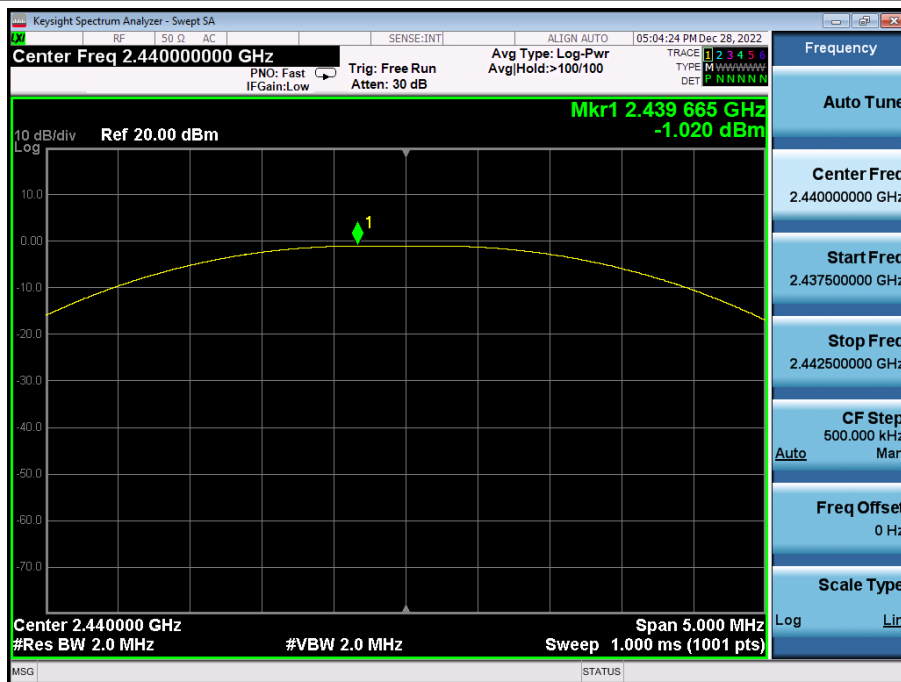

CH40

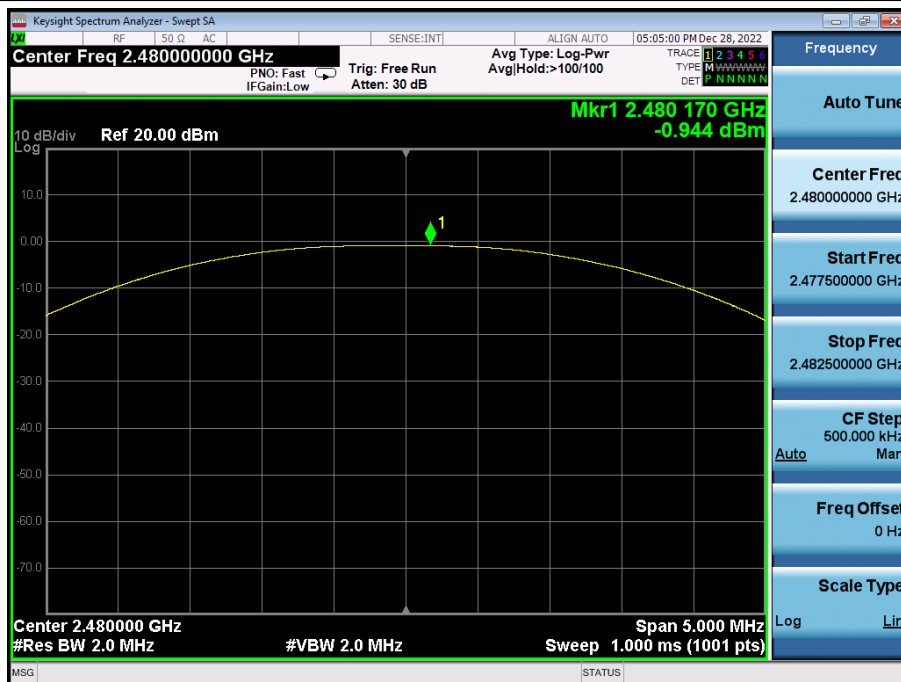

9. CONDUCTED BAND EDGE AND SPURIOUS EMISSION

Test Requirement:	FCC Part15 C Section 15.247 (d)
Test Method:	KDB558074 D0115.247 Meas Guidance v05r02

9.1 APPLICABLE STANDARD

In any 100 kHz bandwidth outside the frequency band in which the spread spectrum intentional radiator is operating, the radio frequency power that is produced by the intentional radiator shall be at least 20 dB below that in the 100 kHz bandwidth within the band that contains the highest level of the desired power, based on either an RF conducted or a radiated measurement.

9.2 TEST PROCEDURE

Using the following spectrum analyzer setting:

- A) Set the RBW = 100KHz.
- B) Set the VBW = 300KHz.
- C) Sweep time = auto couple.
- D) Detector function = peak.
- E) Trace mode = max hold.
- F) Allow trace to fully stabilize.

9.3 DEVIATION FROM STANDARD

No deviation.

9.4 TEST SETUP



9.5 EUT OPERATION CONDITIONS

The EUT tested system was configured as the statements of 2.4 Unless otherwise a special operating condition is specified in the follows during the testing.

9.6 TEST RESULTS

Frequency Band	Delta Peak to band emission(dBc)	>Limit (dBc)	Result
Left-band	50.383	20	Pass
Right-band	53.389	20	Pass

GFSK: Band Edge, Left Side

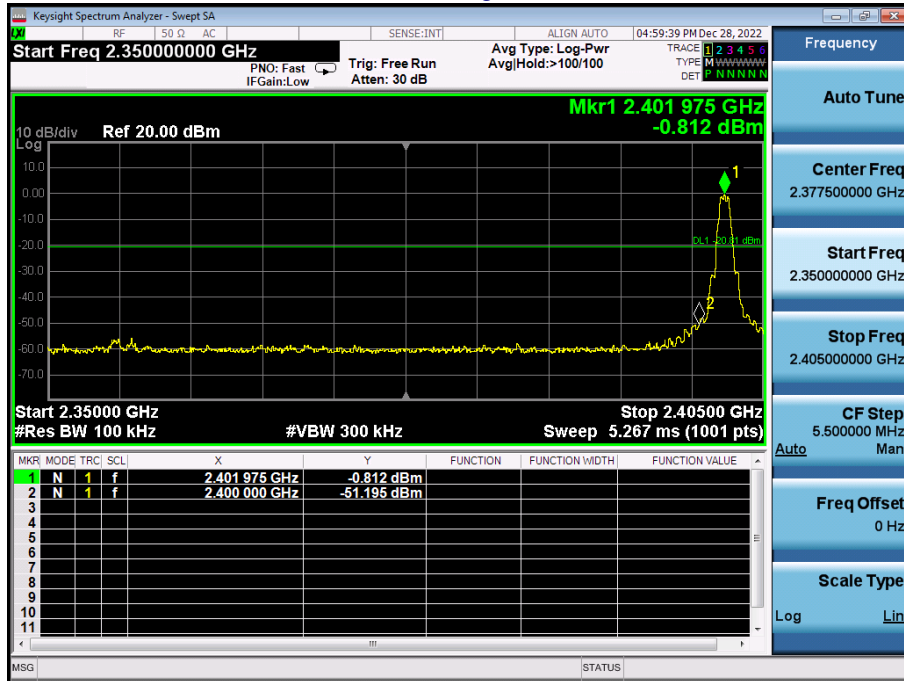

GFSK: Band Edge, Right Side

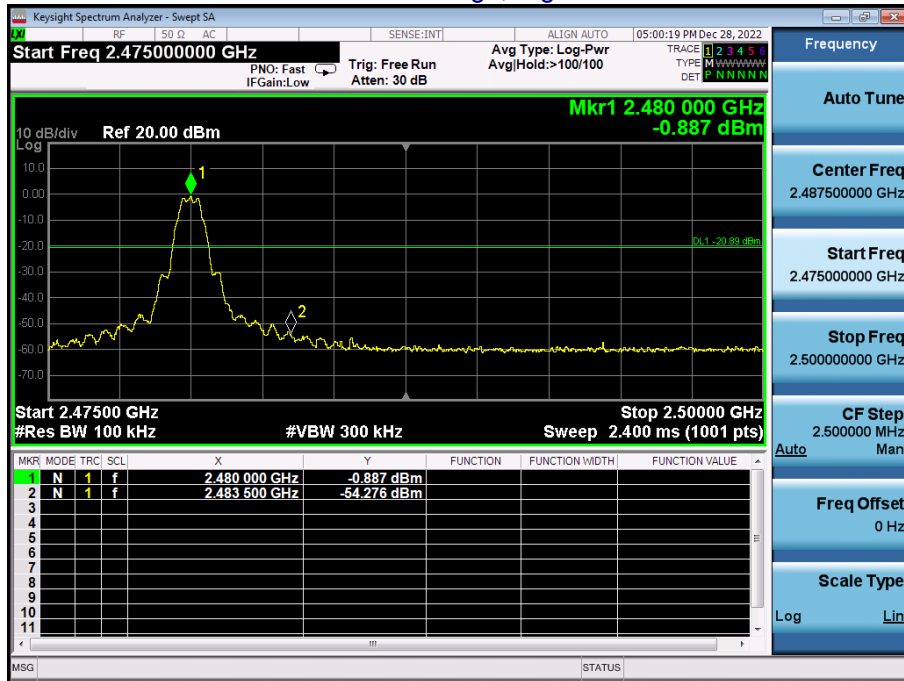

SPURIOUS RF CONDUCTED EMISSION TEST RESULT

CH: 2402MHz

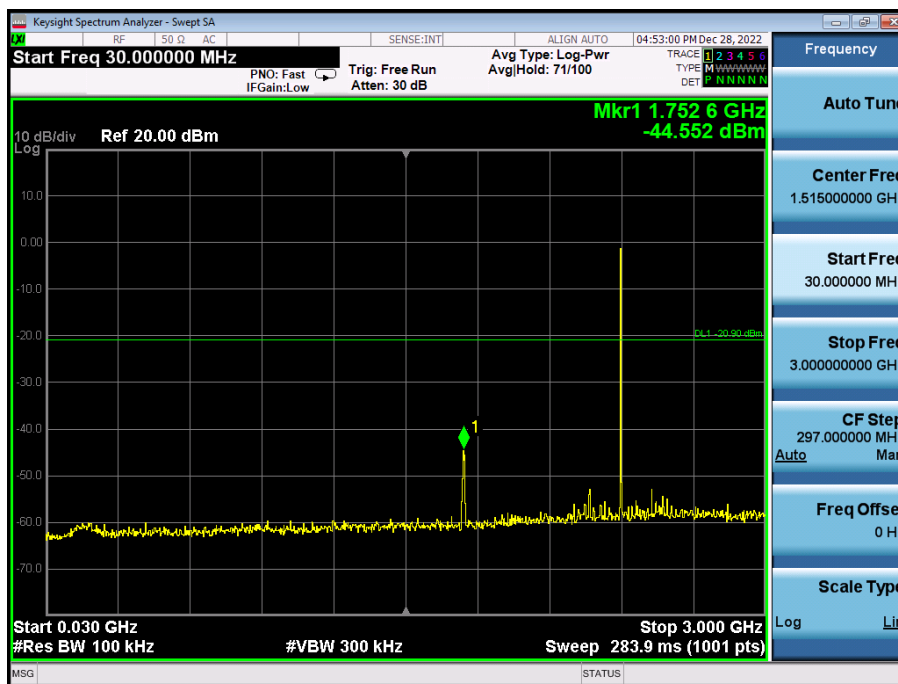

30MHz~3GHz



3GHz~25GHz

CH: 2440MHz

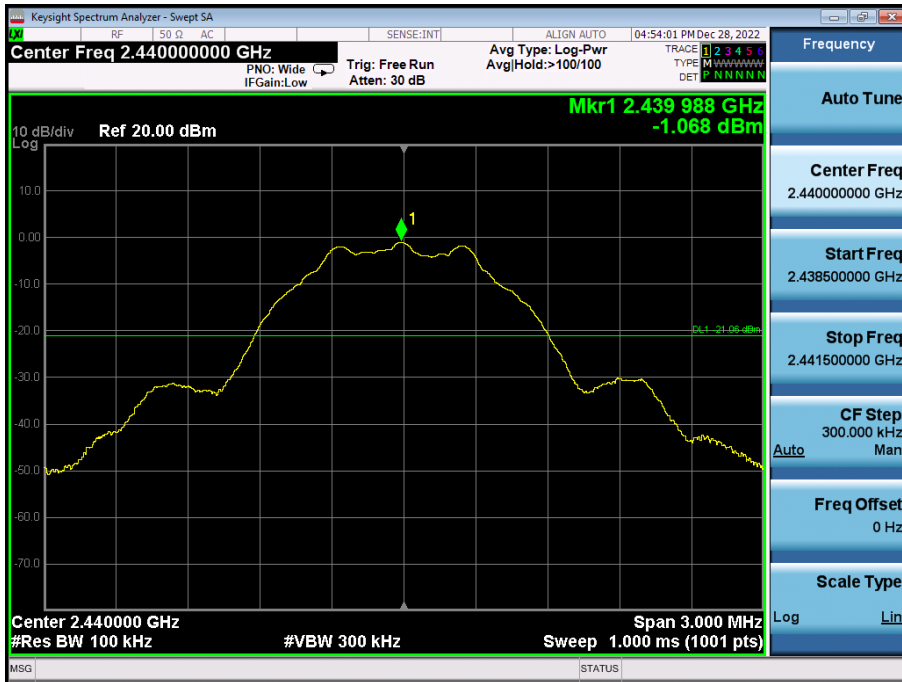

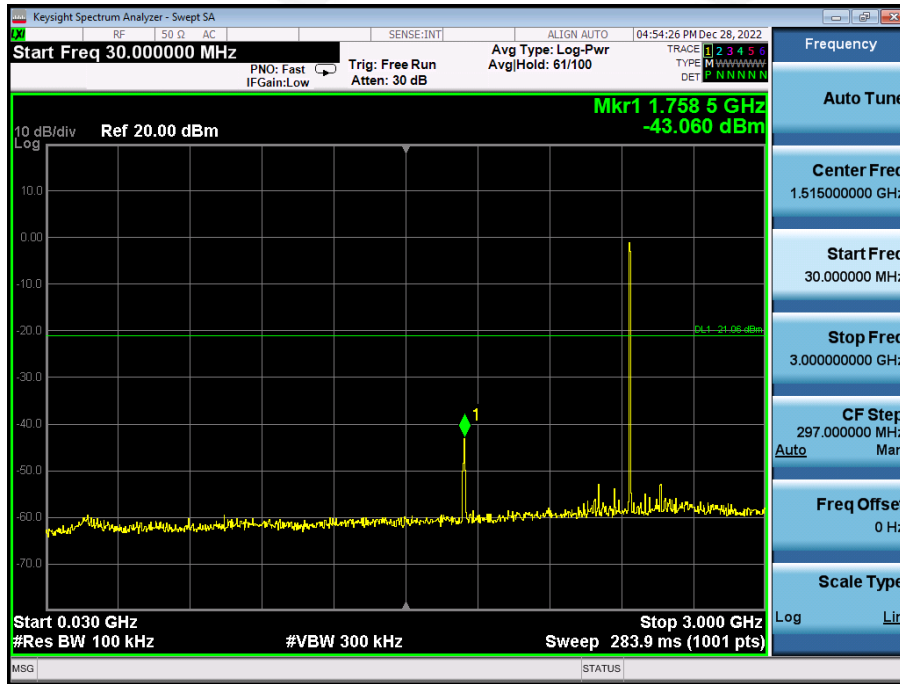

30MHz~3GHz



3GHz~25GHz

CH: 2480MHz

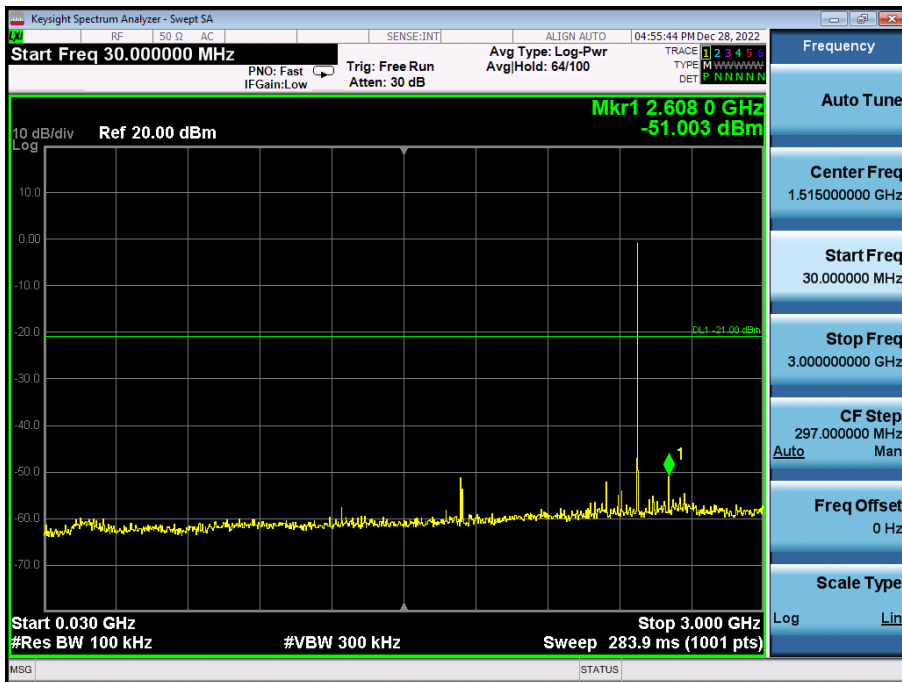
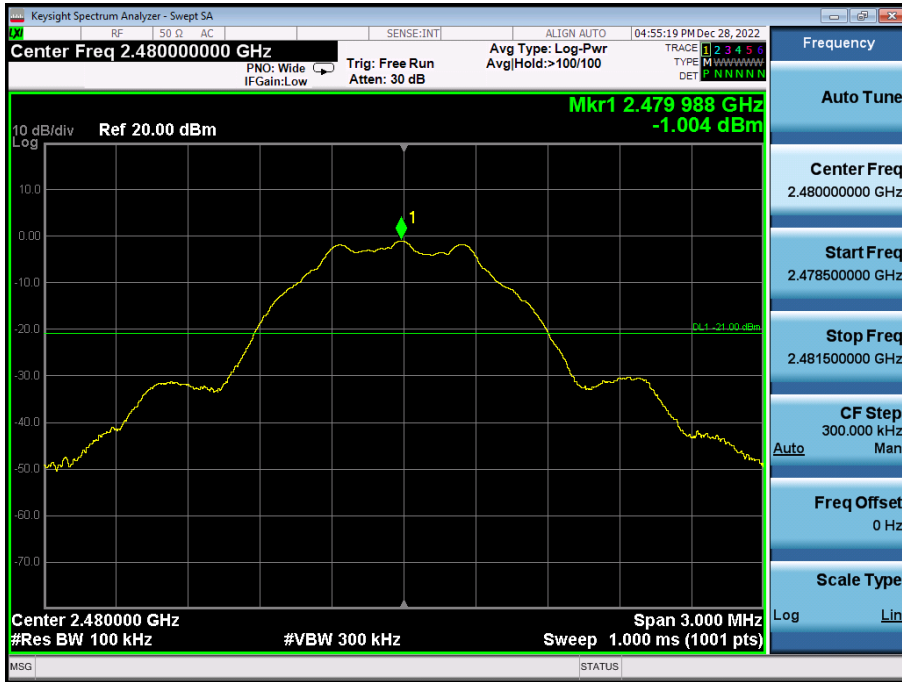

30MHz~3GHz



10.ANTENNA REQUIREMENT

Standard requirement:	FCC Part15 C Section 15.203 /247(c)
<p>15.203 requirement: An intentional radiator shall be designed to ensure that no antenna other than that furnished by the responsible party shall be used with the device. The use of a permanently attached antenna or of an antenna that uses a unique coupling to the intentional radiator, the manufacturer may design the unit so that a broken antenna can be replaced by the user, but the use of a standard antenna jack or electrical connector is prohibited.</p> <p>15.247(c) (1)(i) requirement: (i) Systems operating in the 2400-2483.5 MHz band that is used exclusively for fixed. Point-to-point operations may employ transmitting antennas with directional gain greater than 6dBi provided the maximum conducted output power of the intentional radiator is reduced by 1 dB for every 3 dB that the directional gain of the antenna exceeds 2.71.</p>	

EUT Antenna:

The antennas are PCB Antenna, the best case gain of the antennas are -3.32dBi.

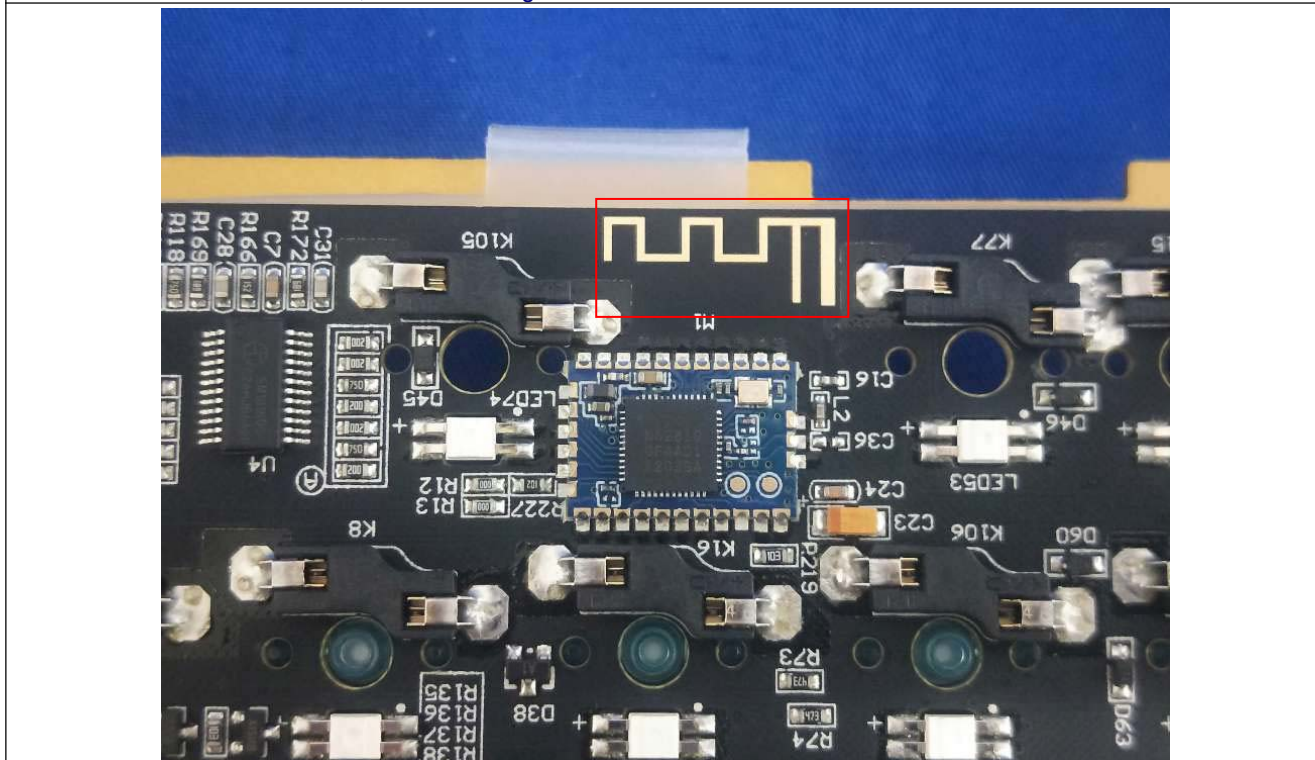

11. TEST SETUP PHOTO

Reference to the appendix I for details.

12. EUT CONSTRUCTIONAL DETAILS

Reference to the appendix II for details.

***** END OF REPORT *****