

HolaBot

User manual V1.0

HL100

Declaration:

FCC Notice

This device complies with part 15 of the FCC Rules. Operation is subject to the condition that this device does not cause harmful interference (1) this device may not cause harmful interference, and (2) this device must accept any interference received, including interference that may cause undesired operation.

Any changes or modifications not expressly approved by the party responsible for compliance could void the user's authority to operate the equipment.

NOTE: This equipment has been tested and found to comply with the limits for a Class B digital device, pursuant to Part 15 of the FCC Rules. These limits are designed to provide reasonable protection against harmful interference in a residential installation. This equipment generates, uses and can radiate radio frequency energy and, if not installed and used in accordance with the instructions, may cause harmful interference to radio communications. However, there is no guarantee that interference will not occur in a particular installation.

If this equipment does cause harmful interference to radio or television reception, which can be determined by turning the equipment off and on, the user is encouraged to try to correct the interference by one or more of the following measures:

- Reorient or relocate the receiving antenna.
- Increase the separation between the equipment and receiver.
- Connect the equipment into an outlet on a circuit different from that to which the receiver is connected.
- Consult the dealer or an experienced radio/TV technician for help.

To maintain compliance with FCC's RF Exposure guidelines, This equipment should be installed and operated with minimum distance between 20cm the radiator your body: Use only the supplied antenna.

FCC ID: 2AXDW-HL100

CATALOG

Safety Instructions

Instructions for use	4
Environmental notes	5
Power and power requirements	7
Safety instructions	9

Product Composition

Component descriptionPerformance	11
Performance parameters	12
Tray size and height	13

Product Use

Charging instructions	14
Charging interface	14
Power ON, Power OFF, Pause, Start	15
Mode selection	17
Passive call mode	18
Cruise mode	20
Manual collection mode	21
Alarm display	23
Emergency handling	24
Key switch	24

Service functions

Basic settings	25
Wireless LAN	25
Voice settings	25
Speed settings	26
Version upgrade	26
Advanced settings	26
Parking instructions	27
Voice interaction introduction	27
Untouching interaction introduction	28

Product Maintenance

Trays, drive wheel and auxiliary wheel	29
Sensors maintenance	29
Robot body maintenance	29
Handling of robot	29
Sign maintenance	29

Troubleshooting

After-sales service policy	31-35
----------------------------	-------

Safety Instruction

Instructions for use

1. DO NOT place any item with weight over the load of the tray: 15kg/tray(standard)
2. Tap “Return” button, the robot will return to the dishwashing room. The user needs to judge whether the robot can go to the next tableware collection point according to the loading situation of the robot. Tap any button and the robot will go there, so please finish placing the item before tapping the screen button.
3. DO NOT pick or place items while the robot is running, if necessary, tap the screen, or press the physical button on top to pause before picking or placing, the pause time in cruise mode is 10s, and 20s in other modes, the robot will automatically resume moving after the pause.
4. DO NOT press hard on the screen or tap the screen.
5. DO NOT pull the robot during operation.
6. DO NOT push the robot backwards while the robot is powered on.
7. The item or box shall NOT exceed the size of the tray, otherwise the sensor may be blocked and the robot may not move properly.

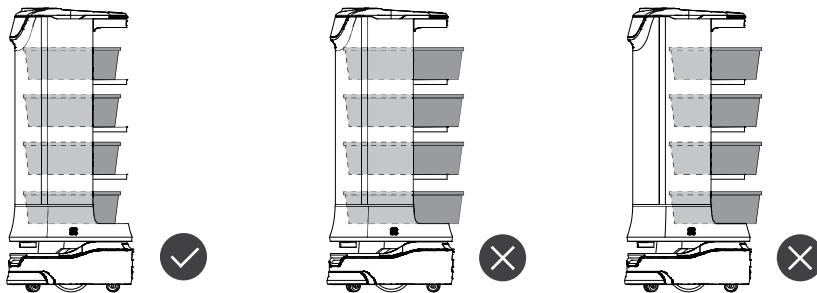

8. In the event of a collision, please cancel the current task or pause, re-enter the task, DO NOT artificially block the robot.
9. In the absence of special custom-made trays, it is not recommended in principle to deliver soup with PuduBot. When using, be sure to prevent the soup from being splashed and being scalded by the hot water.
10. Pay attention to the change of state of the robot during its travel, please avoid the robot when it is carrying hot tableware or soup pot to prevent collision with the robot and high temperature burns.
11. The top camera is used for precise positioning of the robot, DO NOT block it with a cover during starting and running.
12. DO NOT tap or make other actions to the robot, otherwise it may easily cause equipment damage.

Environmental notes

1. The robot is suitable for use in flat environments such as floors, tiles, and thin carpets, it is not suitable for use in environments where there are steps, the slope is too large, or the environment is too tight.
2. It is not recommended to use the robot on wet or obviously watery ground.
3. Any kind of debris such as the power cord that has been scattered on the ground may catch or wrap the robot, be sure to remove it before use.
4. The use of this product in the case of obvious protrusions such as sills may cause the items to sprinkle, please make sure that the height of the protrusions is within 1cm.
5. The minimum travel width of the robot should be greater than 80cm, the width of the long pass should be greater than 1m; if the width is greater than 2m, two robots can be set to travel side by side in opposite direction (the specific width is evaluated by the technical staff based on the actual scenario), otherwise it will move by making the way; the standard entrance of the kitchen should be greater than 1.2m, and less than 1.2m may cause certain human-machine congestion.

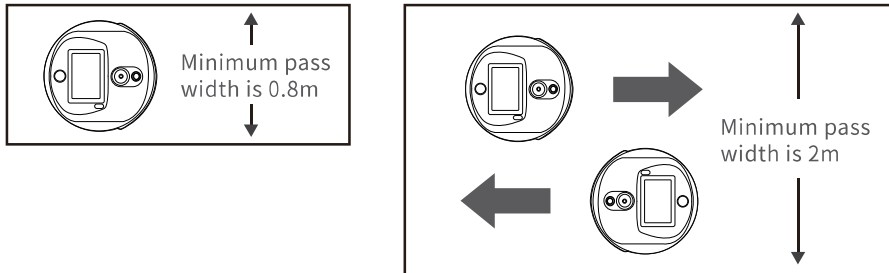

6. The pure black (such as skirting), mirror surface (such as wall), or full transparency (such as floor-to-ceiling glass) items within 16~22cm from the ground, it may interfere with the robot radar reflection, causing the robot to move abnormally, and it may be necessary to make some modifications to the site so that the radar can reflect (such as applying stickers).

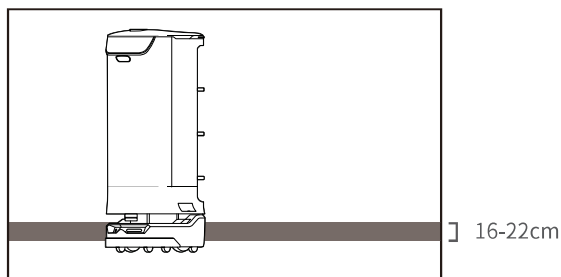

7. The ceiling height is within the range of 2-8 meters (higher or lower may require technical evaluation); taking the height of 3 meters as an example, it is necessary to apply a graphic mark every 2 meters or so, there is no lighting fixture or other strong light source in the 30cm area around the graphic mark. (Data for specific interval needs to be provided by Technology Dept.)

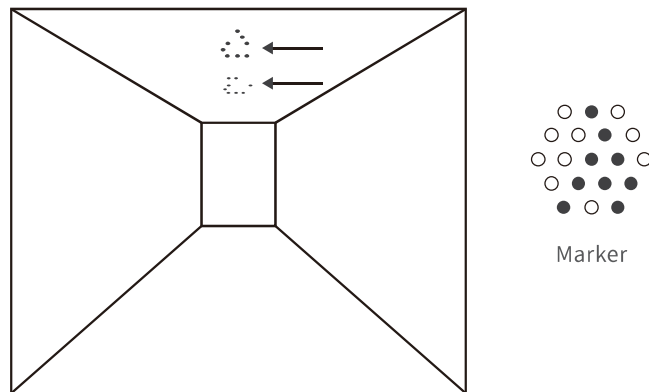

8. The designed maximum climbing angle of the robot is 7.5° , but in order to prevent the dishes from toppling, it is recommended that the slope of the dishes is within 5° ; to prevent possible risks caused by the robot slipping back and forth, avoid pausing the robot while it is going uphill; to prevent the robot from falling accidentally on the slope, the width of the slope should not be less than the minimum passing width of 0.80cm, and the rollover angle should not exceed 5°

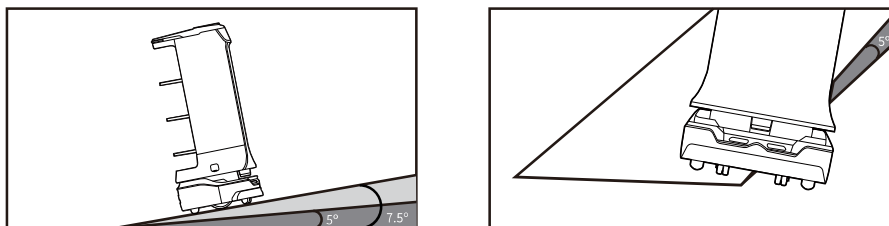

The gradient recommended for carrying dishes should be within 5° and not exceed 7.5° at most



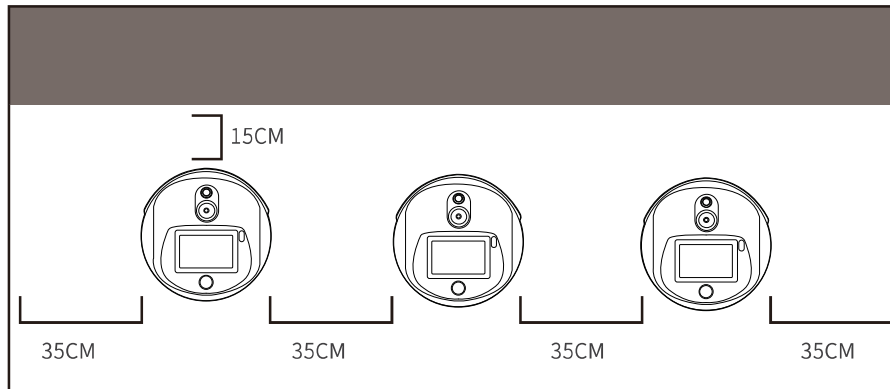



9. There is a 35cm space between the two robots placed side by side at the standby point, and a clearance of 15cm from the rear wall and 35cm from the side wall.



10. It is necessary to add fences or other blocking protection at the locations, such as the edge of the stairs and entrance of the downhill, where there is a risk of the robot falling.

Power and power requirements

1. When the remaining power of the robot is less than 20%, please charge it in time, long-term operation with low power may shorten the service life of the battery.
2. Before charging, please make sure that the battery of the robot is installed in the robot, and it is forbidden to charge the robot without battery.
3. It is strictly forbidden to remove the quick detachable battery during charging.
4. It is strictly forbidden to remove the quick detachable battery when the power is on.
5. When charging is finished, please disconnect the power supply in time. Do not charge the machine for a long time when the machine power is full.
6. If the robot is not used for a long time, please lock the robot through the key switch and cut off the power supply to protect the battery.
7. It is necessary to use the battery and charging equipment specially provided by the original factory. It is strictly prohibited to use non original charger to charge the robot.
8. Charge the main engine with power voltage marked on the charger nameplate.
9. The quick detachable battery can be charged only by the original charger. The battery charging progress can be notified by the lights, the details is below:

Current battery remaining capacity	Light Mode
0%~10%	 Red
10%~25%	 Blue
25%~50%	 Blue
50%~75%	 Blue
75%~90%	 Blue
90%~100%	 Green

10. Please make sure that the robot is power off before changing the battery and it is strictly prohibited to change the battery when robot is NOT power off.
11. Please make sure the input voltage is fit for the requirement voltage, which may damage the charger if not.
12. Please protect the charging line carefully and do NOT pull or twist the line.
13. Please designate a person in charge to charge the machine. Do not charge the robot or the battery alone without being on duty.
14. DO NOT place the machine near flammable and explosive objects to charge.
15. The storage and charging position of the robot should be kept dry and at normal temperature. It is strictly prohibited to place the machine and charger in the high-temperature area (> 40°C), and water is strictly prohibited to enter the machine or charger.
16. It is strictly prohibited for the charger to collide with external objects and cause damage to the charger.
17. If the charger is found damaged and the charging current is abnormal, please replace the charger in time.
18. If you receive the robot alarm, please disconnect the charging device immediately.

Safety instructions

1. DO NOT place any open flame on the tray, and DO NOT place any flammable solids, gases or liquids.
2. It is forbidden to do cleaning and maintenance work when the machine is powered on.
3. To ensure safety, it is recommended to adjust the robot speed to medium or below, and it is forbidden to play in front of the robot to avoid unnecessary injury.
4. Temporary tray loading adjustment is prohibited during the robot's travel, all operations should be performed after clicking the screen to make the robot pause.
5. When the robot delivers food to the designated table number area, DO NOT perform the operation such as picking up the food before the machine body is stopped, so as to avoid the loss of food or personal injury caused by accidental collision.
6. If the robot is going away and the screen operation is invalid, or other emergency situations occur, please use the toe to kick the emergency switch at the charging port.
7. This product is a wheeled robot, which is limited to indoor flat environment (smooth ground, slope less than 5 degrees, protrusions not higher than 1cm), DO NOT use it in outdoor environments (such as open balconies) or on rugged floors (such as stairs).
8. DO NOT use it in an environment where the ambient temperature is above 50°C or below 0°C, or if there is any liquid or viscous material on the floor.
9. Please put away all kinds of wires on the ground in the environment before use to avoid dragging when the main unit is running. Remove sharp objects on the ground (such as decoration waste, glass, nails, etc.) before use to avoid damage to the machine chassis.

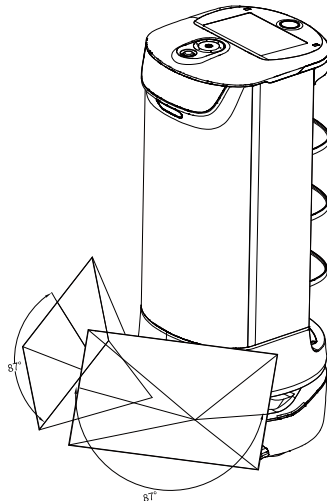

* Our company does not assume any responsibility for all accidents caused by improper operation.

10. To push or move the robot while it is moving, first tap the screen to pause it.
11. DO NOT spill any liquid into the product.
12. DO NOT place any non-transportable objects (including children, pets) on a stationary or moving robot.
13. The robot has automatic obstacle avoidance function, but it is strictly forbidden to block the robot suddenly during the high-speed operation, otherwise it may cause a safety accident.
14. The blind-spot recognition area of the robot is shown below.

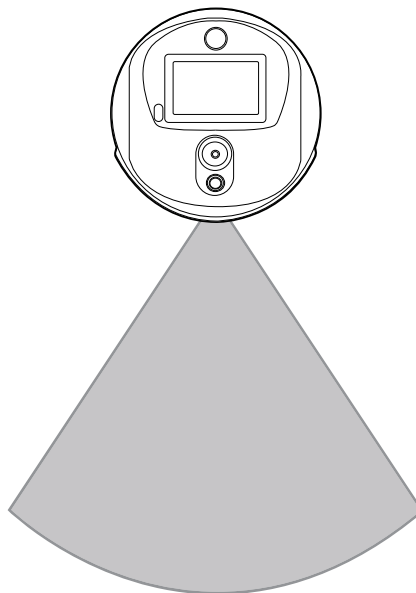

* Our company does not assume any responsibility for all accidents caused by improper operation.

Product Composition

Component description

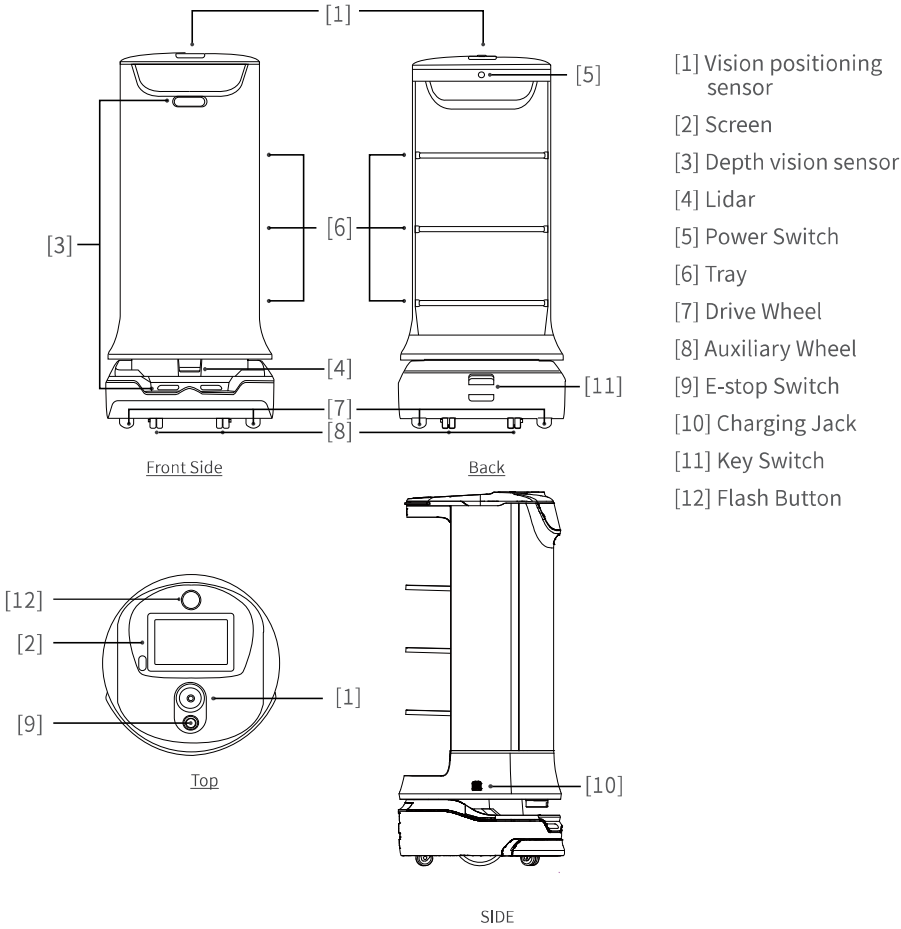

- [1] Vision positioning sensor
- [2] Screen
- [3] Depth vision sensor
- [4] Lidar
- [5] Power Switch
- [6] Tray
- [7] Drive Wheel
- [8] Auxiliary Wheel
- [9] E-stop Switch
- [10] Charging Jack
- [11] Key Switch
- [12] Flash Button

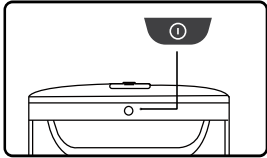

Power Switch

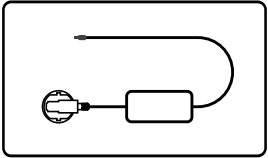

Charging Cable

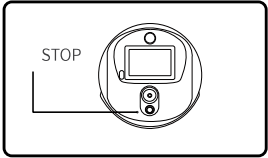

E-stop Switch

Performance parameters

Mode	HL100、HL110、HL101、
Operating	DC 23-29.4V
Power	AC 100-240V, 50/60Hz
Power	29.4V-4
Charging	4.5h
Battery	13~24h
Cruise	0.5~1.2m/s adjustable
Number of	3 layers
Tray	HL100/HL101/HL110/BL111: 1 5kg/layer
Climbing	7.5° at maximum and 5° for safe delivery of dishes (depending on whether the dishes delivered are easy to be
Machine	ABS/aviation-grade aluminum alloy
Battery	25600mAh
Machine	50Kg
Machine	534*542*1213
Screen specifica	10.1-inch HD color touch screen
Audio	20W*2 Stereo
Design	5 years
Working tempera	0~40°C
Storage tempera	-40~65°
Charging	Manual plugging and charging
Operating	85%RH
Environmental	Grade 3
Operating	below 2000m
Working environ	Indoor environment, flat and smooth ground
Enclo	IP20

Tray size and height

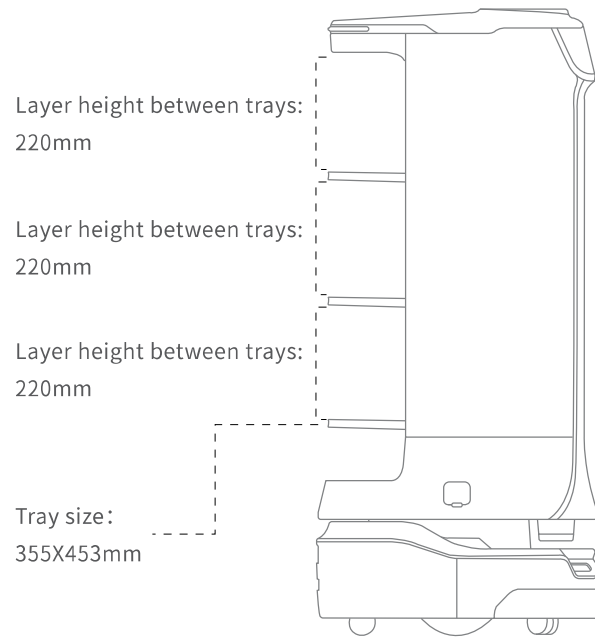

Product Use

Charging instructions

Charging mode: Connect the charging interface of the robot to the charging cable to ensure that the charging port of the robot is connected to the charging cable, if the connection is successful, the robot will prompt it is charging.

Power requirements:

1. In order to ensure the efficiency of the robot and battery life, please keep the robot power at 10% or more at any time;
2. When the power is lower than 10%, the robot is in a low battery state and needs to be charged as soon as possible;
3. When the power is lower than 2%, the battery is protected, the robot will not be able to perform the task, and it needs to be charged before use.

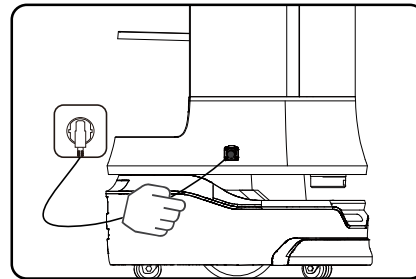
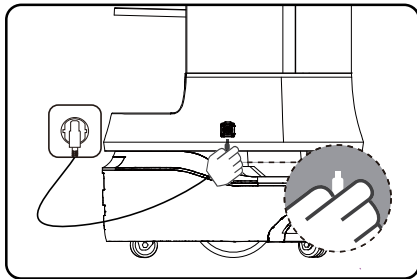

Charging interface

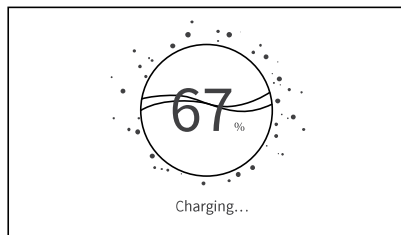

The screen displays an indication that charging is in progress, indicating that the machine is charging.

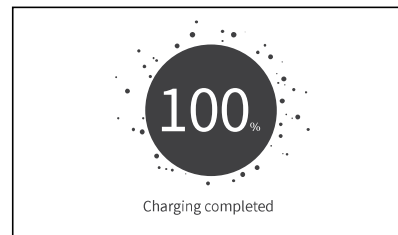

After charging is complete, the screen displays a reminder that the charging container is saturated.

Power ON, Power OFF, Pause, Start

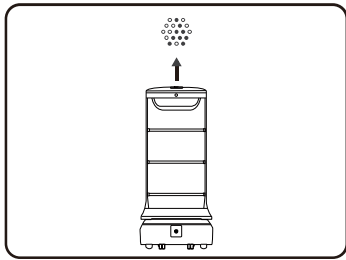

Before each power-on

Move the robot directly below the visual mark before each power-on.

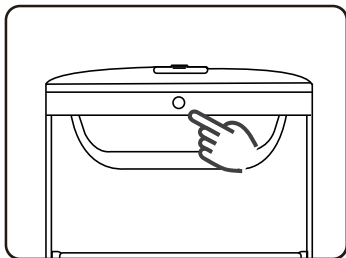

Power-on

Press and hold the power button for 0.5 seconds, and the bottom light strip will display blue.

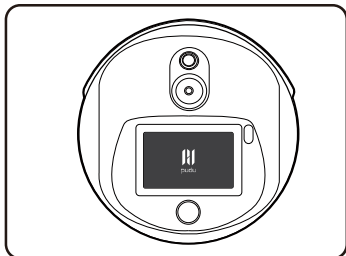

starting up

The screen enters the working mode, indicating that the boot is successful.

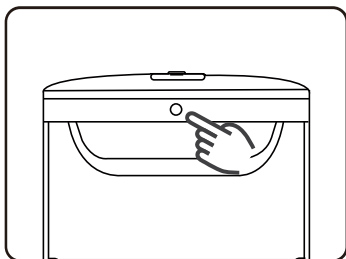

Power-off

Press and hold the power off button for 3 seconds, the bottom light strip is off, and the screen is black, indicating that the shutdown is successful. Press and hold the OFF button for 10 seconds to achieve a forced power-off of the robot (if the robot is not in an abnormal state, this feature is not recommended).

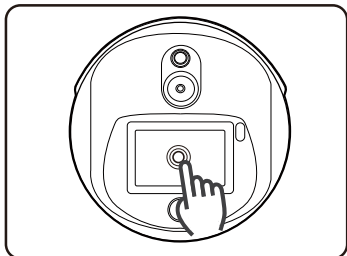

Pause

While the robot is running, touch the screen to make the robot pause.

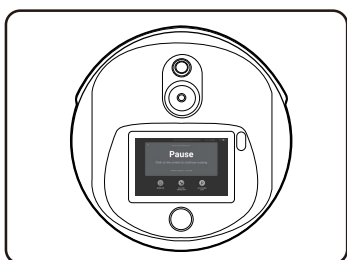

Pausing

The screen enters the pause interface.

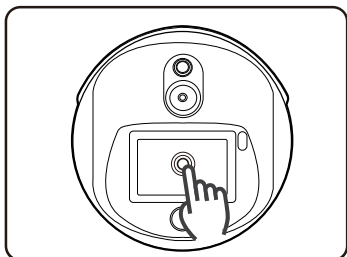

Running

If it is necessary to continue running, you need to click the screen again. In cruise mode, if there is no other action in the pause interface, the robot will automatically resume walking after 20s, and after 10s in other modes

Mode selection

In order to be applicable in different business scenarios, the modes can be selected as required. The robot provides two local manual modes and one mode with pager for selection. The manual modes are manual collection and cruise collection. After the robot is turned on, the mode can be selected through the menu bar.

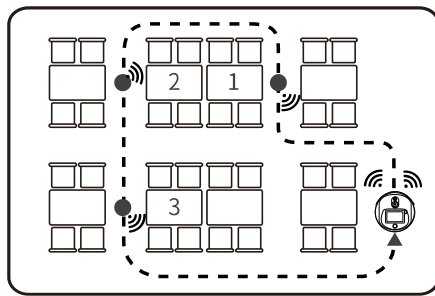
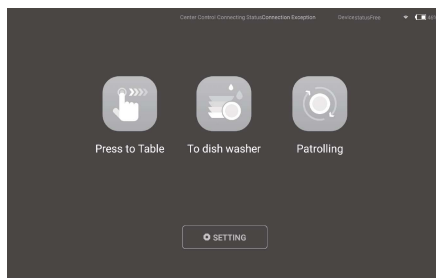

Passive call mode

Passive call mode: in this mode, the robot will go to the call point according to the call task issued by the central control, but the robot will only perform one call task at the same time. After the robot arrives at the call point, the user can judge whether the robot needs to go to the next call point according to the current load of the robot, and then perform the next task. After the robot finishes loading, it will automatically return to the dishwashing room.

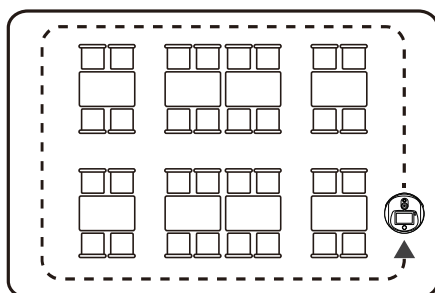

Cruise mode

In this mode, the robot can continue to cruise according to the current route selected, the user can choose the duration of the cruise, and the robot will automatically return to the dishwashing room when it arrives at a predetermined time during cruise.

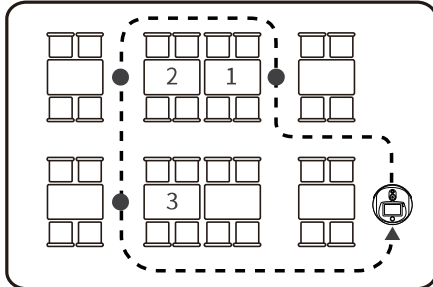

Manual collection mode

The user can enter table number for collection in the main interface of the robot, and the robot will go to the corresponding destination in order according to the established order to perform the collection task. When the robot completes all loading tasks, it will automatically return to the dishwashing room.

Return to the dishwashing room

After the robot returns to the dishwashing room, the user will complete the unloading of items and tap return button, and the robot will automatically return to the parking location to stop. At this time, if a call point initiates a request for collection, the robot will not return to the parking location, but will go directly to the call point.

Passive call mode

Passive mode is the basic collection mode of holabot, which needs to be used with a watch/pager (see below for the function description of the watch/pager), a request is initiated through the pager, and the robot will go the designated call point to perform the collection task. After the user completes the loading, the robot will return to the dishwashing room, and then the washing personnel will complete the unloading of the items to make the robot return to the parking location. The specific steps are as follows:

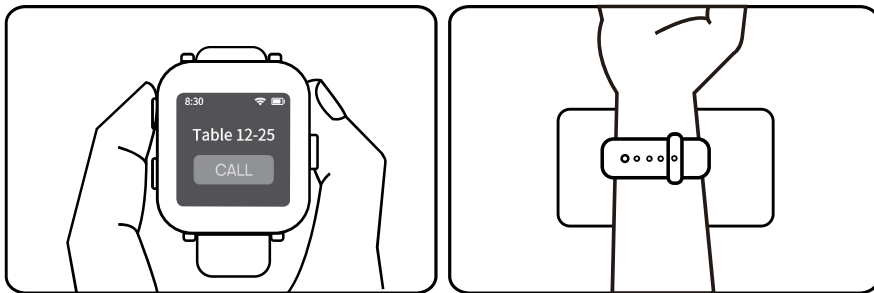

1. The caller presses the pager button or touches the desktop call card through the watch to initiate a request. (Tap the watch button to initiate a call/touch the picture of call card with the watch to initiate a call).

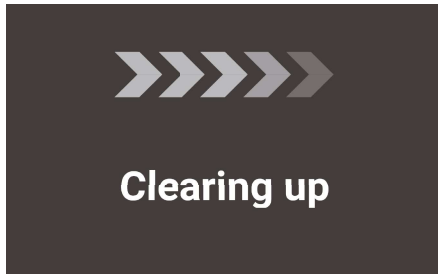

2. The robot receives the call request and travels from the parking location to the call point.

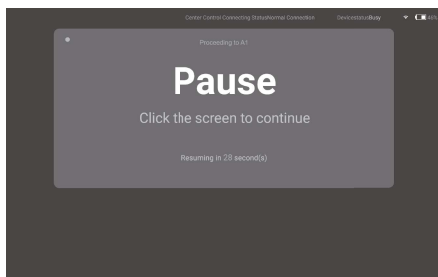

3. Tap the screen or touch the top button while returning to the collection cabinet, the robot will pause, but the task cannot be canceled on the pause interface.

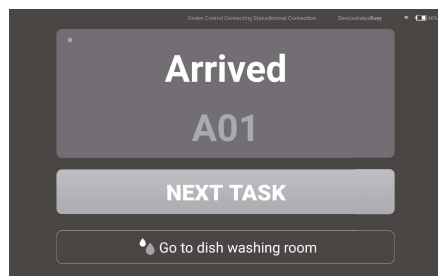

4. After the robot arrives at the call point, the interface appears as "Next task" and "Return".

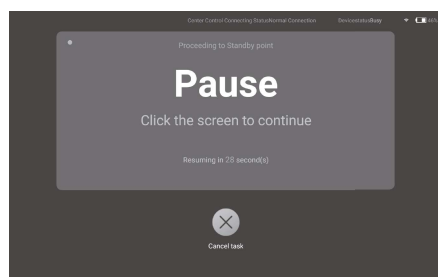

5. Tap "Next task", the robot will get another call request and go to the corresponding call point; tap "Return", the robot will return to the dishwashing room, and will not respond to any call request during the period.

6. Tap the screen or touch the top button while returning to the dish washer, the robot will pause, the pause interface only has "End the task and return", which can make the robot return to the parking location in advance.

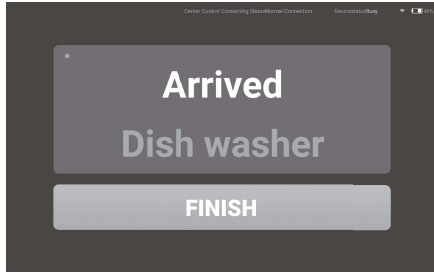

7. After the robot returns to the dishwashing room, the interface presents the state of “Task completed” .

8. Tap “Finish”, and the robot will return to the parking location, during this period, if there is a new call request, the robot will go directly to the call point.

Cruise mode

Cruise mode is a collection mode for specific scenario, under such mode, the robot cruises and walks along the selected route, collects the items in the area, automatically returns to the dishwashing room after reaching the predetermined task time, and automatically returns to the parking location after the unloading at the dishwashing room. The specific steps are as follows:

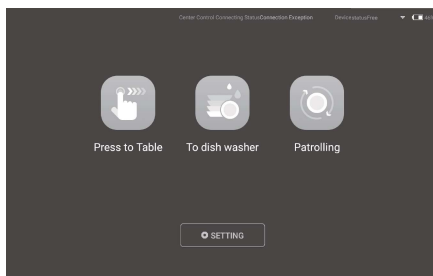

1. The cruise collection mode is on the initial interface,

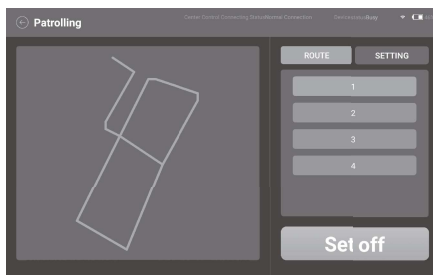

2. Select the automatic cruise route and set the cruise duration (default duration is 5 minutes).

3. Select Start and the robot will start the cruise task.

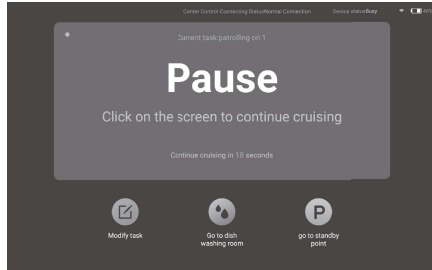

4. During the cruise process, you can touch the robot screen to stop the command, and the robot will stop for waiting immediately, if a touch command is not received after 10 seconds, the robot will continue to perform the task.



5. In the pause interface, the user can modify the cruise task, or can choose to go to the dishwashing room or to the parking location.

6. While the robot is paused, the user can place items on the robot. After finishing the placement, tap the screen again and the robot will resume with the cruise.

Manual collection mode

Manual collection mode is used for the user to manually enter the table number to initiate the collection task, the specific steps are as follows:

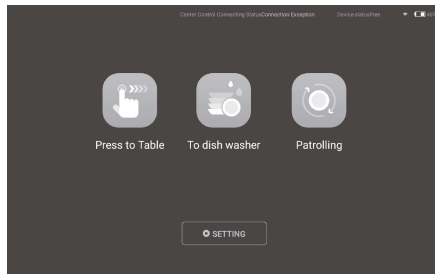

1. Select “Manual collection” on the main interface

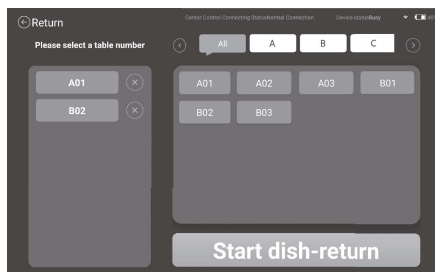

2. Select the destination for manual collection

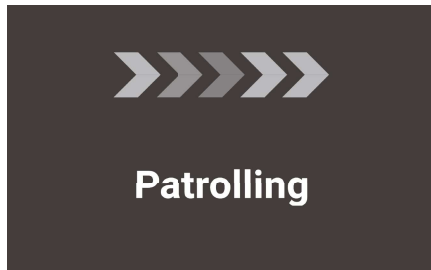

3. Tap “Start collection”, and the robot will go for the collection in turn according to the preset destination

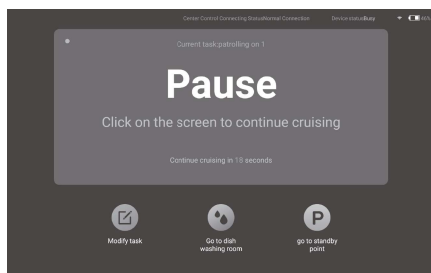

4. While the robot is going, tap the screen to pop up the “Pause” interface

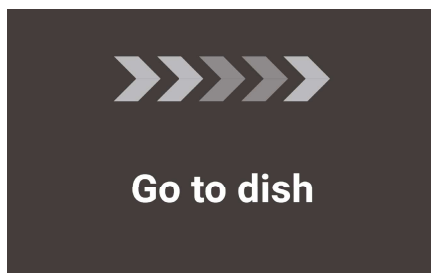

5. The “Pause” interface can have the following operations:

Modify tasks: modify the remaining tasks of the current robot, but the completed tasks cannot be modified

End all tasks: the robot will cancel all tasks and stay in place

To dish washer: the robot goes directly to the dish washer room

To parking location: the robot will cancel all tasks and go to the parking location

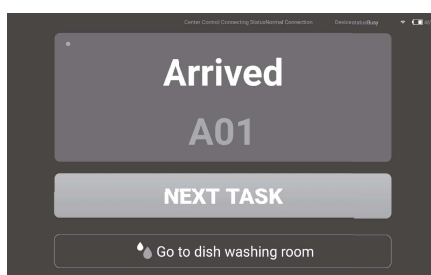
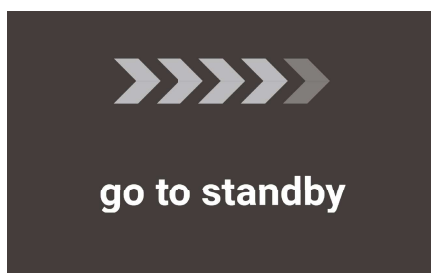

6. The “Arrived at task point” interface is the same as the “Call arrival” interface, the user needs to judge whether the next task can be performed or return directly based on the remaining space of the robot currently loaded



7.If the user tap “Go to dish washing room” on this interface, the robot will go directly to the dishwashing room and cancel the remaining tasks in the task list

Alarm display

In the following cases, the robot will stop working and give an alarm tone, the tablet interface will prompt the corresponding instructions, and the machine will need your assistance.

Timeout alarm	Solutions
Battery is too low	Please push the robot back to the charging stand in time (Figure 1)
Loss of positioning	Push the robot directly below the visual mark (Figure 2)

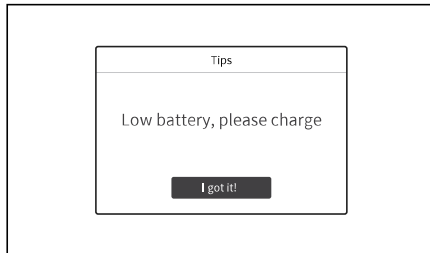

Figure 1



Figure 2

Emergency handling

An abnormal state of the robot or an unexpected situation may cause damages to the surrounding environment, the user can press the emergency stop switch on the back of the robot to stop the robot.

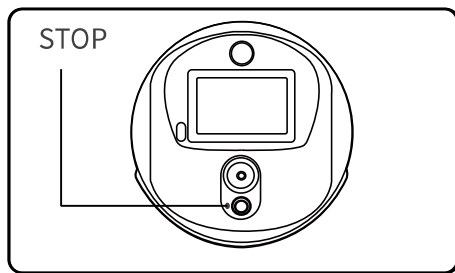

Key switch

The key switch can turn on/off the power of the robot, and realize the lock function of the robot, its location is shown below.

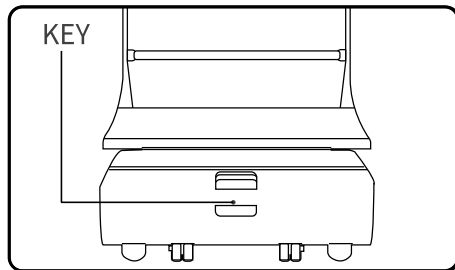

Service functions

Basic settings

The “Basic settings” function provides display brightness adjustment and multi-language setting functions.

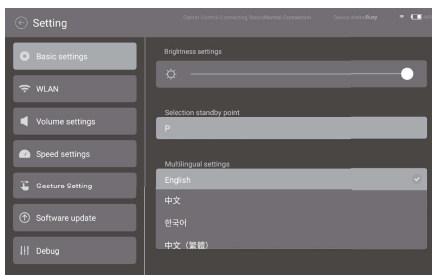

1. The brightness of the display can be adjusted through the brightness adjustment slide;

2. Select the language drop-down list to switch the language, after the switch, the text on the robot display and the voice played will be switched to the corresponding language.

Wireless LAN

In Wireless LAN settings, you can view the network connection status, and click WIFI settings for network switching and connection operations.

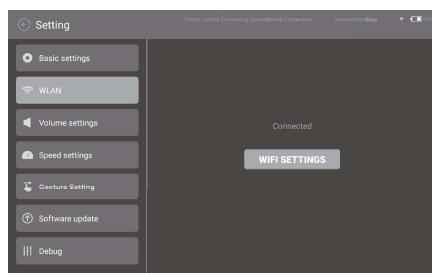

Voice settings

The “Voice settings” function provides voice packet replacement and custom settings of cruise voice.

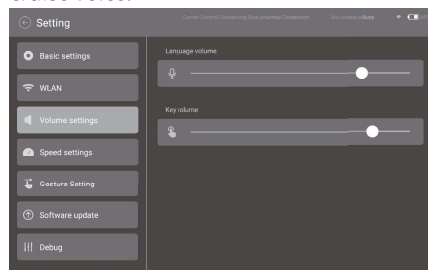

1. Check the available voice packets for update support and choose to download the voice packets.

2. After downloading, select the corresponding voice packet for replacement.

3. Select “Default” to restore the default voice packet

4. Press and hold the voice packet to delete it.

Speed settings

With the “Speed settings” function, you can set the food delivery speed and cruise speed respectively, supporting the speed settings of 0.5m/s, 0.6m/s, 0.7m/s, 0.8m/s and 0.9m/s.

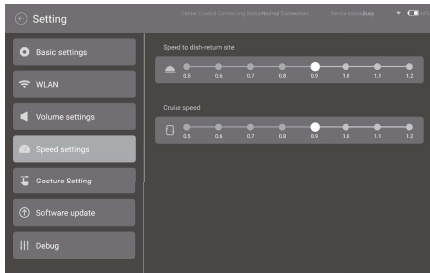

Version upgrade

With the “Version upgrade” function, you can check the current version and whether it is up-to-date. If it is not up-to-date, you can choose to check for updates, download and update the latest version.

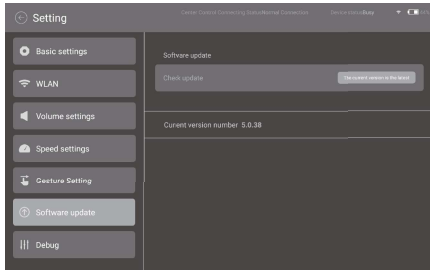

Advanced settings

Select “Advanced settings” to choose the mode of used plate collection. You can also set the speed for food delivery mode and cruise mode, which supports 1.0m/s, 1.1m/s and 1.2m/s.

Note: The commissioning setting is advanced robot operation, which requires consulting technical support personnel before proceeding with the operation, the Company does not assume any responsibility for all accidents caused by unauthorized operation.

Parking instructions

Depending on the size of the restaurant, there are three robot parking options available.

1. One-to-one parking: fixed parking locations can be set for each robot.
2. Free mode: multiple parking locations can be set the robots, and the robots can be parked according to priority.
3. Parking replenishment mode: In addition to the settings of parking locations in 1) and 2), you can also set temporary parking locations in other areas, and when there is location available, the robot can automatically go to the parking location for replenishment. When a robot is parking at non-parking location with no task designated, you can choose the "Return" command to let the robot return to the parking location automatically, or push the robot to the parking location.

Note: The robot at the temporary location will display "Temporary parking" in the normal state, when there is location available at food pick-up position, the robot will automatically to the pick-up position for parking.



Voice interaction introduction

When the robot is at the stopping point, at the calling point or at the dishwashing room, it can wake up by voice and turn around according to the sound. The details are as follows:

- 1) When the robot is at the stop point, call point or arrives at the dish washing room, it will initiate voice wake-up
- 2) Wake up words "Hi! Hola!"
- 3) The robot aims the loading port at the caller according to the voice orientation
- 4) This function is convenient for waiters who hold tableware and do not operate the robot to turn the robot quickly so that it can be loaded easily

Untouching interaction introduction

When the robot arrives at the dishwashing room, in order to avoid oil stains caused by users' hands touching the robot operation, we design a non-contact interaction function. The process is as follows



1) When the robot arrives at the dishwashing room, the interface is in the state of reaching the dishwashing room

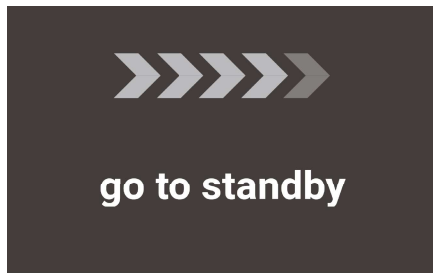

2) One hand traverses the left side from the right side of the robot, or from the left side traverses the right side of the robot, and the robot obtains corresponding input, realizes the function of touch screen clicking the completion button, and the robot goes to the docking point

Product Maintenance

Trays, drive wheel and auxiliary wheel

Keep the tray clean and clean with a clean cotton cloth, Please check for cleaning at least once a week. When the bottom wheel is entangled or stuck by debris, the robot needs to be lifted for cleaning.

Sensor maintenance

Inspect and clean the positioning sensor on the top and the 3D obstacle avoidance sensor at least once a week. In case of unexpected contamination, be sure to clean it immediately so as not to block the sensors and cause abnormal operation of the product. Use soft tissue or other lens cleaner for cleaning.

Robot body maintenance

Keep the robot body clean with clean cotton cloth. Do not lift, climb, bump, push, or break the robot or stack things on its body. If it operates abnormally, do not uninstall any screw or open any cover without permission or instruction of our technical support engineers.

Handling of robot

During the transportation of the robot, it is necessary to meet GB/T 4857.23-2012 requirements for road transport of steel spring vibration-damped trucks, please use forklifts and other handling tools for transportation.

The robot is a valuable equipment, when you need to manually move the robot, please strictly follow the instructions below. As shown in the figure, the left and right profiles of the robot (indicated by the arrows) are the parts that can be stressed, and you can lift the robot through this part. Please ask two colleagues to lift the profile from both sides, pay attention to balance, and keep the robot's upright posture during the handling. It is strictly forbidden to carry out the handling by lifting the tray.

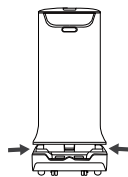

Sign maintenance

No other objects (such as balloons, barbed wire, slogans, etc.) can be hung directly under the sign, and no billboards or safety exit signs can be hung near the sign; pay attention not to damage the sign during routine ceiling cleaning and maintenance, and the sign cannot be moved or rotated.

Troubleshooting

POST fails

If the robot has sufficient battery power, restart the robot under the positioning mark, if the self-test still fails, please contact the after-sales service personnel in time.

Robot stops during operation

1. Click the interface to show the pause page, the robot pauses, click again to run normally.
2. Voice prompt "Excuse me": Click the screen to pause the robot, then the robot will be on the right track, then click Continue.

"Signal Loss" prompt

The robot interface prompts "I am lost, please push me directly below the positioning mark". At this time, the robot will issue a voice prompt for help, please push the robot directly below the positioning mark.

Robot can't boot normally

1. Check if the emergency switch is pressed or damaged, if it is damaged, please contact customer service.
2. The battery is insufficient, please connect the robot through the adapter for charging.
3. For other reasons, please contact customer service staff for processing.

After-sales service policy(end customers)

Free Warranty Services

Shenzhen Pudu Technology Co.Ltd. promises to meet the following conditions. From the date of product receipt, within the effective warranty period of the product (the warranty period of different parts of the product may be different, See "warranty period of major parts" for details.), we will provide free products warranty service. Customers do not need to pay after-sales service fees. Circumstances beyond the warranty period or not covered by the free product warranty service. We will charge a normal price. Please contact the official website after-sales service hotline for product maintenance.

1. Free warranty service must meet the following conditions

1. Self-purchased products are used normally within the specified product warranty period, and non-artificial quality problems occur;
2. No unauthorized disassembly, no modification or installation under the guidance of non-official instructions, other non-man-made failures;
3. Product serial number, factory label and other signs have no signs of tearing or alteration;
4. Provide valid proof of purchase, documents;
5. Damaged spare parts replaced during the free warranty period are owned by Pudu Technology and should be returned as requested by Pudu Technology, otherwise Pudu Technology reserves the right not to grant free warranty service.

2. The following conditions are not included in the free product warranty service

1. Collision, burnout caused by non-product quality problems, and quality problems caused by foreign body intrusion (water, oil, sand, etc.);
2. Damage caused by unauthorized modification, disassembly, opening of the shell, etc., as instructed by unofficial instructions;
3. Damage caused by improper installation, use and operation without following the instructions;
4. Damage caused by customer repairs without official instructions;
5. Damage caused by improper use of circuit modification, battery pack, and charger under the guidance of unofficial instructions;
6. Damage caused by use in excess of the safe load weight;
7. Damage caused by insufficient discharge when the battery is low or the use of a battery with quality problems;
- h. Services such as secondary on-site deployment or installation and commissioning due to customer's own reasons;
8. Malfunction and damage caused by force majeure (such as earthquake, fire, etc.);

3. warranty period

The product receipt date recorded by Pudu's after-sales service system is used as the warranty start date.

Return and exchange policy

If you meet one of the following conditions, you can ask for a refund

Within 7 natural days of receiving the goods, the customer found obvious manufacturing defects without using the goods. Round-trip freight is borne by Pudu;

We have the right to reject the customer's return request in the following cases

1. The goods were damaged, but the delivery staff was not requested to return them on the spot when receiving the goods;
2. If the return request is made after the return period of the product exceeds 7 natural days (calculated from the date of receipt);
3. Incomplete returned goods, incomplete packaging, accessories, gifts, manuals, or damage caused by appearance;
4. Failure to provide legal proof of purchase or documents when returning goods, or forging or altering documents;
5. Quality problems caused by collisions, burns caused by non-product quality problems, artificial modifications, foreign objects (water, oil, sand, etc.), improper installation, or failure to use and operate according to the instructions;
6. Torn, altered labels, machine serial numbers, waterproof marks, anti-counterfeit marks, etc.;
7. Products damaged due to force majeure such as fire, flood, lightning, traffic accident, etc.;
8. After contacting Pudu Technology Co., Ltd. to confirm the return service, Pudu Technology has the right not to accept the corresponding items within 7 days from the date of contacting Pudu Technology.

If you meet one of the following conditions, you can request a replacement

1. Within 15 natural days of receiving the goods, the customer found obvious manufacturing defects without using the goods. Pudu Technology bears the return freight;
2. Within 15 natural days after the customer receives the goods, after the product is unpacked, it cannot be started normally according to the instructions or under the guidance of a technician, or a non-artificial product quality defect is found. Round-trip freight is borne by Pudu;
3. When customers receive the goods, they need to unpack and inspect them in front of the deliveryman, and find that the product has been damaged due to transportation. Pudu Technology bears the return freight;
4. There was a clear discrepancy between the actual received goods and the description of the goods. Round-trip freight is borne by Pudu.

We have the right to reject the customer's replacement request in the following situations

1. Cannot provide legal purchase vouchers or documents when exchanging goods, or forge or alter the documents;
2. The goods were damaged, but the delivery staff was not required to return or exchange them on the spot when receiving the goods;
3. Requests for replacement after the replacement period of 15 natural day products (calculated from the date of receipt);
4. Incomplete replacement, incomplete packaging, accessories, gifts, manuals, or damage caused by appearance;
5. The goods have been tested by the technical support department of Pudu Technology Co.Ltd. and there is no quality problem;
6. Product quality problems caused by collisions or burns caused by non-self quality problems, artificial modification, foreign objects (water, oil, sand, etc.), improper installation, or failure to use and operate according to the instructions;
7. Torn, altered labels, machine serial numbers, waterproof marks, anti-counterfeit marks, etc.;
8. Products damaged due to force majeure such as fire, flood, lightning, traffic accident, etc.;
9. After contacting Pudu Technology Co. Ltd. to confirm the return service, the corresponding items were not sent within 7 days from the date of contacting Pudu Technology. Pudu Technology has the right not to accept it.

After-sales service process

1. Please contact Pudu technical support staff in time, call: 400-0826-660;
2. Technical support staff fill in relevant forms according to your product situation;
3. Technical support staff will review and confirm and follow up within 7 working days as soon as possible.

Remote technical guidance service free on-site maintenance

Pudu Technology officially provides online and remote technical support channels, and customers need to cooperate with technical engineers for problem diagnosis and troubleshooting.

On-site service

If the Pudu technology engineer diagnoses that the problem must be solved at home, Pudu Technology assigns professional and technical personnel to provide on site service.

Return processing time

After your return application is reviewed and approved, Pudu Technology Co.Ltd. will process the returned goods for you within 7 days from the date of receipt of the problem product you sent back.

Exchange processing time

After your replacement request is approved, Pudu Technology Co.Ltd. will process the replacement for you within 15 days you receive the problem product you sent back.

Return to factory for processing time

After your repair application is approved, Pudu Technology Co. Ltd. will process the repair for you within 30 days from the date you receive the problem product you sent back. If the service is postponed due to national statutory holidays or after-sales service centers of some brand manufacturers, the repair time will be extended accordingly.

Refund time

After approved by Pudu technology, the refund will be transferred to the bank account of the other party within 10 working days after receiving the returned product.

Out-of-warranty service

For after-sales services that are not covered by the free warranty (beyond the warranty period or do not meet the free warranty terms during the warranty period), Pudu Technology will charge for after-sales services.

Remote Technical Guidance Service

Pudu Technology officially provides online and remote technical support channels, and customers need to cooperate with technical engineers for problem diagnosis and troubleshooting.

On-site service

If the Pudu technology engineer diagnoses that the problem must be solved on the site, Pudu Technology assigns professional and technical personnel to provide on site service.

After-sales service cost standard

For after-sales services not covered by the free warranty, you need to fill in the Pudu Technology After-Sales Record Form in accordance with the requirements. Pudu's after-sales service costs include after-sales maintenance costs and spare parts costs;

Pudu technology technicians provide remote technical guidance services. Customers assist in handling after-sales issues. Pudu technology only charges the cost of spare parts;

After-sales service of Pudu technology technicians providing on-site services. Service costs include spare parts costs and after-sales maintenance costs;
After-sale maintenance fees are charged as follows: 500USD / day / person and round trip travel expenses;
The cost standard of spare parts is listed in "quotation of spare parts delivered by Pudu technology".

After-sales Service Contact

If you have any question, please call our service hotline: 400-0826-660
PuduTech' s after-sales service hours are: Monday to Saturday, 9:00 am to 12:00 am,
14:00 to 18:00 pm.

Main Parts Warranty

Main components	Warranty period
Upper computer master control board	12 months
Upper computer expansion board	12 months
Upper computer cooling fan	12 months
Lower computer master control board	12 months
Audio amplifier board	12 months
Lidar	12 months
Upper view RGBD vision sensors	12 months
Lower view RGBD vision sensors	12 months
Audio device	12 months
Camera module	12 months
Trays	No
LORA Module	12 months
Light strip behind the head	12 months
Array Microphones	12 months
LED Dot-matrix screen	12 months
Non-contact sensor and touch button	12 months
Flash button	24 months
Chassis shell	6 months
Display assembly	12 months
Waterproof light strip	12 months
Universal wheel	No
DC hub motor	12 months
Battery	12 months
Battery cover	12 months
E-stop switch	12 months
Key switch	12 months
In-line charger	12 months

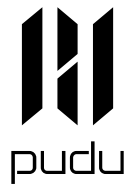

www.pudutech.com



PuduTech