

FCC RADIO TEST REPORT

FCC ID: 2AXDW-HL100

Product: HolaBot

Trade Mark: Pudu

Model No.: HL100

Family Model: HL101, HL110

Report No.: S20082600608004

Issue Date: 12 Nov. 2020

Prepared for

SHENZHEN PUDU TECHNOLOGY CO., LTD.
Room 301, Wearnes Science and Technology Mansion, No.10,
Kefa Road, Yuehai Street, Nanshan District , Shenzhen,
Guangdong, China 518057

Prepared by

Shenzhen NTEK Testing Technology Co., Ltd.
1/F, Building E, Fenda Science Park Sanwei, Xixiang, Bao'an
District Shenzhen, Guangdong, China
Tel.: +86-755-6115 6588
Fax.: +86-755-6115 6599
Website:<http://www.ntek.org.cn>

TEST RESULT CERTIFICATION

Applicant's name : SHENZHEN PUDU TECHNOLOGY CO., LTD.
Address : Room 301, Wearnes Science and Technology Mansion, No.10, Kefa Road, Yuehai Street, Nanshan District , Shenzhen, Guangdong, China 518057

Manufacturer's Name : SHENZHEN PUDU TECHNOLOGY CO., LTD.
Address : Room 301, Wearnes Science and Technology Mansion, No.10, Kefa Road, Yuehai Street, Nanshan District , Shenzhen, Guangdong, China 518057

Product description

Product name : HolaBot

Model and/or type reference : HL100

Family Model : HL101, HL110

Standards : FCC Part15.407

Test procedure : ANSI C63.10-2013 and KDB 789033 D02 General UNII Test Procedures New Rules v02r01
FCC KDB 662911 D01 Multiple Transmitter Output v02r01
KDB 905462 D03 Client Without DFS New Rules v01r02

This device described above has been tested by NTEK, and the test results show that the equipment under test (EUT) is in compliance with the FCC requirements. And it is applicable only to the tested sample identified in the report.

This report shall not be reproduced except in full, without the written approval of NTEK, this document may be altered or revised by NTEK, personnel only, and shall be noted in the revision of the document.

Date of Test

Date (s) of performance of tests : 10 Aug. 2020 ~ 10 Nov. 2020

Date of Issue : 12 Nov. 2020

Test Result : Pass

Testing Engineer : [Signature: Allen Liu]
(Allen Liu)

Technical Manager : [Signature: Jason Chen]
(Jason Chen)

Authorized Signatory : [Signature: Alex Li]
(Alex Li)

Table of Contents

	Page
1. SUMMARY OF TEST RESULTS	7
1.1 FACILITIES AND ACCREDITATIONS	8
1.2 MEASUREMENT UNCERTAINTY	8
1 . GENERAL INFORMATION	9
1.1 GENERAL DESCRIPTION OF EUT	9
1.2 DESCRIPTION OF TEST MODES	12
1.3 BLOCK DIGRAM SHOWING THE CONFIGURATION OF SYSTEM TESTED	13
1.4 DESCRIPTION OF SUPPORT UNITS(CONDUCTED MODE)	14
1.5 EQUIPMENTS LIST FOR ALL TEST ITEMS	15
2 . EMC EMISSION TEST	17
2.1 CONDUCTED EMISSION MEASUREMENT	17
2.1.1 APPLICABLE STANDARD	17
2.1.2 CONFORMANCE LIMIT	17
2.1.3 TEST CONFIGURATION	17
2.1.4 TEST PROCEDURE	17
2.2 RADIATED EMISSION MEASUREMENT	26
2.2.1 APPLICABLE STANDARD	26
2.2.2 CONFORMANCE LIMIT	26
2.2.3 MEASURING INSTRUMENTS	26
2.2.4 TEST CONFIGURATION	27
2.2.5 TEST PROCEDURE	28
2.2.6 TEST RESULTS (9KHZ – 30 MHZ)	29
2.2.7 TEST RESULTS (30MHZ – 1GHZ)	30
2.2.8 TEST RESULTS (1GHZ-18GHZ)	38
2.2.10 TEST RESULTS (18GHZ-40GHZ)	46
3 . POWER SPECTRAL DENSITY TEST	57
3.1 APPLIED PROCEDURES / LIMIT	57
3.2 TEST PROCEDURE	58
3.3 DEVIATION FROM STANDARD	58
3.4 TEST SETUP	58
3.5 EUT OPERATION CONDITIONS	58
3.6 TEST RESULTS	59
4 . 26DB & 99% EMISSION BANDWIDTH	60
4.1 APPLIED PROCEDURES / LIMIT	60
4.2 TEST PROCEDURE	60
4.3 EUT OPERATION CONDITIONS	61
4.4 TEST RESULTS	61
5 . MINIMUM 6 DB BANDWIDTH	62

Table of Contents

	Page
5.1 APPLIED PROCEDURES / LIMIT	62
5.2 TEST PROCEDURE	62
5.3 DEVIATION FROM STANDARD	62
5.4 TEST SETUP	62
5.5 EUT OPERATION CONDITIONS	62
5.6 TEST RESULTS	63
6 . MAXIMUM CONDUCTED OUTPUT POWER	64
6.1 PPLIED PROCEDURES / LIMIT	64
6.2 TEST RESULTS	66
7 . OUT OF BAND EMISSIONS	67
7.1 APPLICABLE STANDARD	67
7.2 TEST PROCEDURE	67
7.3 DEVIATION FROM STANDARD	67
7.4 TEST SETUP	67
7.5 EUT OPERATION CONDITIONS	68
7.6 TEST RESULTS	69
8. FREQUENCY STABILITY MEASUREMENT	70
8.1 LIMIT	70
8.2 TEST PROCEDURES	70
8.3 TEST SETUP LAYOUT	70
8.4 EUT OPERATION DURING TEST	70
8.5 TEST RESULTS	71
9. DYNAMIC FREQUENCY SELECTION(DFS)	83
9.1 APPLICABILITY OF DFS REQUIREMENTS	83
9.2 INTERFERENCE THRESHOLD VALUES, MASTER OR CLIENT INCORPORATING IN-SERVICE MONITORING	83
9.3 DFS RESPONSE REQUIREMENT VALUES	84
9.4 SHORT PULSE RADAR TEST WAVEFORMS	84
9.5 CALIBRATION SETUP AND DFS TEST RESULTS	85
9.6 CONDUCTED CALIBRATION SETUP	85
9.7 RADAR WAVEFORM CALIBRATION RESULT	86
9.8 IN-SERVICE MONITORING: CHANNEL MOVE TIME, CHANNEL CLOSING TRANSMISSION TIME AND NON-OCCUPANCY PERIOD	87
9.9 RESULT OF CHANNEL MOVE TIME, CHANNEL CLOSING TRANSMISSION TIME AND NON-OCCUPANCY PERIOD FOR CLIENT BEACON TEST	88
10. ANTENNA REQUIREMENT	89

Table of Contents

	Page
10.1 STANDARD REQUIREMENT	89
10.2 EUT ANTENNA	89

Revision History

Report No.	Version	Description	Issued Date
S20082600608004	Rev.01	Initial issue of report	12 Nov. 2020

1. SUMMARY OF TEST RESULTS

Test procedures according to the technical standards:

FCC Part15 (15.407) , Subpart E			
Standard Section	Test Item	Judgment	Remark
15.207	AC Power Line Conducted Emissions	PASS	
15.209(a), 15.407 (b)(1) 15.407 (b)(2) 15.407 (b)(3) 15.407 (b)(4) 15.407 (b)(6)	Spurious Radiated Emissions	PASS	
15.407 (a)	26 dB and 99% Emission Bandwidth	PASS	
15.407(e)	Minimum 6 dB bandwidth	PASS	
15.407 (a)	Maximum Conducted Output Power	PASS	
15.407 (b)(1) 15.407 (b)(2) 15.407 (b)(3) 15.407 (b)(4)	Band Edge	PASS	
15.407 (a)	Power Spectral Density	PASS	
15.407(b)	Spurious Emissions at Antenna Terminals	PASS	
15.407(g)	Frequency Stability Measurement	PASS	
15.407(h)	Dynamic Frequency Selection(DFS)	PASS	
15.203	Antenna Requirement	PASS	

NOTE:

- (1) "N/A" denotes test is not applicable in this Test Report
- (2) This device operates with a duty cycle greater than 99%

1.1 FACILITIES AND ACCREDITATIONS

FACILITIES

All measurement facilities used to collect the measurement data are located at
1/F, Building E, Fenda Science Park Sanwei, Xixiang, Bao'an District
Shenzhen, Guangdong, China

The sites are constructed in conformance with the requirements of ANSI C63.7, ANSI C63.10 and CISPR Publication 22.

LABORATORY ACCREDITATIONS AND LISTINGS

Site Description

CNAS-Lab. : The Laboratory has been assessed and proved to be in compliance with
CNAS-CL01:2006 (identical to ISO/IEC 17025:2005)
The Certificate Registration Number is L5516.

IC-Registration : The Certificate Registration Number is 9270A.
CAB identifier:CN0074

FCC- Accredited : Test Firm Registration Number: 463705.
Designation Number: CN1184

A2LA-Lab. : The Certificate Registration Number is 4298.01
This laboratory is accredited in accordance with the recognized
International Standard ISO/IEC 17025:2005 General requirements for the
competence of testing and calibration laboratories.
This accreditation demonstrates technical competence for a defined
scope and the operation of a laboratory quality management system
(refer to joint ISO-ILAC-IAF Communiqué dated 8 January 2009).

Name of Firm : Shenzhen NTEK Testing Technology Co., Ltd.

Site Location : 1/F, Building E, Fenda Science Park Sanwei, Xixiang, Bao'an District
Shenzhen, Guangdong, China

1.2 MEASUREMENT UNCERTAINTY

The reported uncertainty of measurement $y \pm U$, where expanded uncertainty U is based on a standard uncertainty multiplied by a coverage factor of $k=2$, providing a level of confidence of approximately 95 %.

No.	Item	Uncertainty
1	Conducted Emission Test	$\pm 2.80\text{dB}$
2	RF power, conducted	$\pm 0.16\text{dB}$
3	Spurious emissions, conducted	$\pm 0.21\text{dB}$
4	All emissions, radiated(30MHz~1GHz)	$\pm 2.64\text{dB}$
5	All emissions, radiated(1GHz~6GHz)	$\pm 2.40\text{dB}$
6	All emissions, radiated(> 6GHz)	$\pm 2.52\text{dB}$
7	Temperature	$\pm 0.5^\circ\text{C}$
8	Humidity	$\pm 2\%$

1. GENERAL INFORMATION
1.1 GENERAL DESCRIPTION OF EUT

Equipment	HolaBot																				
Trade Mark	Pudu																				
Model Name	HL100																				
Family Model	HL101, HL110																				
Model Difference	All the model are the same circuit and RF module, except the main model carrying food part is a tray, and the series model is a closed box.																				
FCC ID	2AXDW-HL100																				
Product Description	<table border="1"> <tr> <td>Mode Supported</td> <td> <input checked="" type="checkbox"/>802.11a <input checked="" type="checkbox"/>802.11n(HT20) <input checked="" type="checkbox"/>802.11n(HT40) <input checked="" type="checkbox"/>802.11ac(HT20) <input checked="" type="checkbox"/>802.11ac(HT40) <input checked="" type="checkbox"/>802.11ac(HT80) </td> </tr> <tr> <td>Data Rate</td> <td>802.11a: 6,9,12,18,24,36,48,54Mbps; 802.11n(HT20/HT40):MCS0-MCS15; 802.11ac(VHT20): NSS1, MCS0-MCS8 802.11ac(VHT40/VHT80):NSS1, MCS0-MCS9</td> </tr> <tr> <td>Modulation</td> <td>OFDM with BPSK/QPSK/16QAM/64QAM</td> </tr> <tr> <td>Operating Frequency Range</td> <td> <input checked="" type="checkbox"/> U-NII-1: 5150 MHz ~5250MHz <input checked="" type="checkbox"/> U-NII-2A: 5250MHz~5350MHz <input checked="" type="checkbox"/> U-NII-2C: 5470MHz~5725MHz <input checked="" type="checkbox"/> U-NII-3: 5725 MHz ~5850 MHz </td> </tr> <tr> <td>Function:</td> <td> <input type="checkbox"/>Outdoor AP <input type="checkbox"/>Indoor AP <input type="checkbox"/>Fixed P2P <input checked="" type="checkbox"/>Client </td> </tr> <tr> <td>DFS type:</td> <td> <input type="checkbox"/>master devices <input type="checkbox"/>Slave devices with radar detection <input checked="" type="checkbox"/>Slave devices without radar detection </td> </tr> <tr> <td>Support TPC</td> <td> <input type="checkbox"/>YES <input checked="" type="checkbox"/>NO </td> </tr> <tr> <td>Antenna Type</td> <td>Main Antenna 2: FPCB antenna AUX Antenna 1: FPCB antenna</td> </tr> <tr> <td>Antenna Gain</td> <td>Antenna 1: 4dBi Antenna 2: 4dBi</td> </tr> <tr> <td>Smart system</td> <td> <input checked="" type="checkbox"/>SISO for 802.11a/n/ac <input checked="" type="checkbox"/>MIMO for 802.11n/ac </td> </tr> </table>	Mode Supported	<input checked="" type="checkbox"/> 802.11a <input checked="" type="checkbox"/> 802.11n(HT20) <input checked="" type="checkbox"/> 802.11n(HT40) <input checked="" type="checkbox"/> 802.11ac(HT20) <input checked="" type="checkbox"/> 802.11ac(HT40) <input checked="" type="checkbox"/> 802.11ac(HT80)	Data Rate	802.11a: 6,9,12,18,24,36,48,54Mbps; 802.11n(HT20/HT40):MCS0-MCS15; 802.11ac(VHT20): NSS1, MCS0-MCS8 802.11ac(VHT40/VHT80):NSS1, MCS0-MCS9	Modulation	OFDM with BPSK/QPSK/16QAM/64QAM	Operating Frequency Range	<input checked="" type="checkbox"/> U-NII-1: 5150 MHz ~5250MHz <input checked="" type="checkbox"/> U-NII-2A: 5250MHz~5350MHz <input checked="" type="checkbox"/> U-NII-2C: 5470MHz~5725MHz <input checked="" type="checkbox"/> U-NII-3: 5725 MHz ~5850 MHz	Function:	<input type="checkbox"/> Outdoor AP <input type="checkbox"/> Indoor AP <input type="checkbox"/> Fixed P2P <input checked="" type="checkbox"/> Client	DFS type:	<input type="checkbox"/> master devices <input type="checkbox"/> Slave devices with radar detection <input checked="" type="checkbox"/> Slave devices without radar detection	Support TPC	<input type="checkbox"/> YES <input checked="" type="checkbox"/> NO	Antenna Type	Main Antenna 2: FPCB antenna AUX Antenna 1: FPCB antenna	Antenna Gain	Antenna 1: 4dBi Antenna 2: 4dBi	Smart system	<input checked="" type="checkbox"/> SISO for 802.11a/n/ac <input checked="" type="checkbox"/> MIMO for 802.11n/ac
	Mode Supported	<input checked="" type="checkbox"/> 802.11a <input checked="" type="checkbox"/> 802.11n(HT20) <input checked="" type="checkbox"/> 802.11n(HT40) <input checked="" type="checkbox"/> 802.11ac(HT20) <input checked="" type="checkbox"/> 802.11ac(HT40) <input checked="" type="checkbox"/> 802.11ac(HT80)																			
	Data Rate	802.11a: 6,9,12,18,24,36,48,54Mbps; 802.11n(HT20/HT40):MCS0-MCS15; 802.11ac(VHT20): NSS1, MCS0-MCS8 802.11ac(VHT40/VHT80):NSS1, MCS0-MCS9																			
	Modulation	OFDM with BPSK/QPSK/16QAM/64QAM																			
	Operating Frequency Range	<input checked="" type="checkbox"/> U-NII-1: 5150 MHz ~5250MHz <input checked="" type="checkbox"/> U-NII-2A: 5250MHz~5350MHz <input checked="" type="checkbox"/> U-NII-2C: 5470MHz~5725MHz <input checked="" type="checkbox"/> U-NII-3: 5725 MHz ~5850 MHz																			
	Function:	<input type="checkbox"/> Outdoor AP <input type="checkbox"/> Indoor AP <input type="checkbox"/> Fixed P2P <input checked="" type="checkbox"/> Client																			
	DFS type:	<input type="checkbox"/> master devices <input type="checkbox"/> Slave devices with radar detection <input checked="" type="checkbox"/> Slave devices without radar detection																			
	Support TPC	<input type="checkbox"/> YES <input checked="" type="checkbox"/> NO																			
	Antenna Type	Main Antenna 2: FPCB antenna AUX Antenna 1: FPCB antenna																			
	Antenna Gain	Antenna 1: 4dBi Antenna 2: 4dBi																			
Smart system	<input checked="" type="checkbox"/> SISO for 802.11a/n/ac <input checked="" type="checkbox"/> MIMO for 802.11n/ac																				
Based on the application, features, or specification exhibited in User's Manual, More details of EUT technical specification, please refer to the User's Manual.																					
Ratings	DC 25.55V from battery																				
Adapter	<input checked="" type="checkbox"/> Adapter 1 supply: Model: FY29008000 Input: 100-240V~50/60Hz 3A 300VA Output: 29.0V---8.0A 232.0W																				
Battery	Model:7S8P DC 25.55V, 25600mAh																				
Connecting I/O Port(s)	Please refer to the User's Manual																				
HW Version	V3.0																				
SW Version	5.0.0.xx																				

Note:

1. For a more detailed features description, please refer to the manufacturer's specifications or the User's Manual.
2. Frequency and Channel list:

Band	20MHz		40MHz		80MHz	
	Channel	Frequency	Channel	Frequency	Channel	Frequency
U-NII-1	36	5180 MHz	38	5190 MHz	42	5210 MHz
	40	5200 MHz	46	5230 MHz	-	-
	44	5220 MHz				
	48	5240 MHz				
U-NII-2A	52	5260 MHz	54	5270 MHz	58	5290 MHz
	56	5280 MHz	62	5310 MHz		
	60	5300 MHz				
	64	5320 MHz				
U-NII-2C	100	5500 MHz	102	5510 MHz	106	5530 MHz
	104	5520 MHz	110	5550 MHz	122	5610 MHz
	108	5540 MHz	118	5590 MHz		
	112	5560 MHz	126	5630 MHz		
	116	5580 MHz	134	5670 MHz		
	120	5600 MHz				
	124	5620 MHz				
	128	5640 MHz				
	132	5660 MHz				
	136	5680 MHz				
U-NII-3	149	5745 MHz	151	5755 MHz	155	5775 MHz
	153	5765 MHz	159	5795 MHz		
	157	5785 MHz				
	161	5805 MHz				
	165	5825 MHz				

Table for Filed Antenna

Antenna	Brand	Model Name	Antenna Type	Connector	Gain (dBi)	NOTE
1	N/A	N/A	FPCB antenna	IPEX	4	Wifi Antenna
2	N/A	N/A	FPCB antenna	IPEX	4	Wifi Antenna

This module 2 supports Bluetooth, WIFI2.4G / 5G, module 2 has two antennas, 1 antenna supports Bluetooth, WIFI2.4G / 5G, 2 antenna supports WIFI2.4G / 5G.

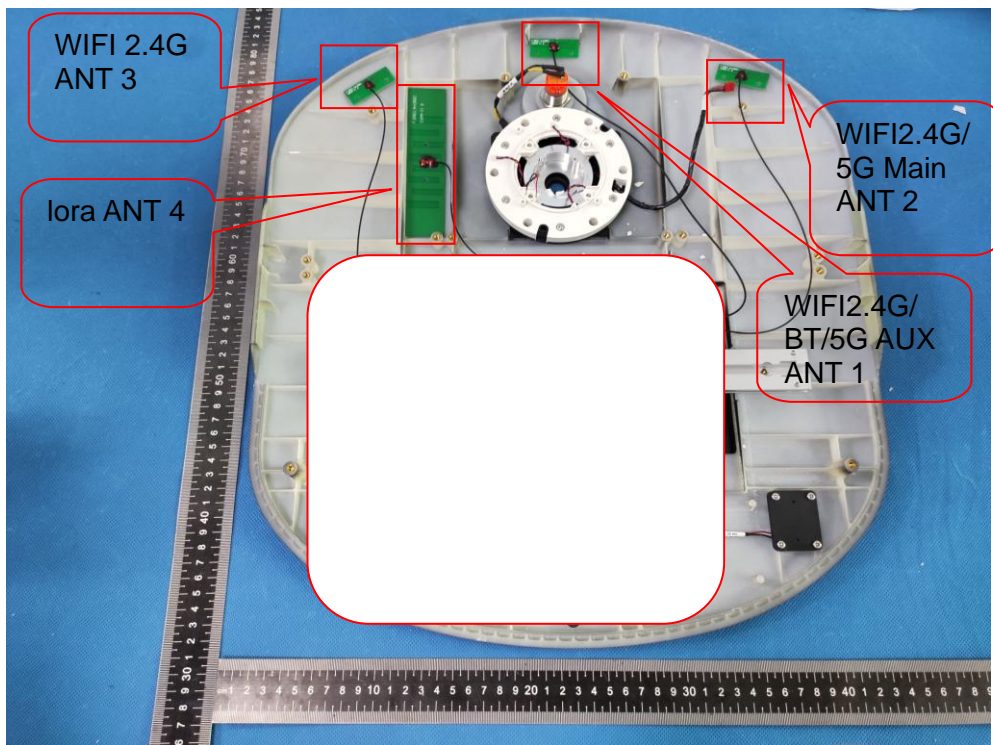

The module 2 for 5G WIFI has two antennas, and different modes support different transmit mode what describe as Following form:

Mode	Tx/Rx
802.11a	1TX, 1RX
802.11n/ac	1TX/2TX, 1RX/2RX

For 5GHz mode, Antenna 1,2 are transmitting, each with the same directional gain.
 For MIMO mode, Directional gain= $G_{ANT} + 10 \log(N_{ANT})$ dBi =7.01dBi in 5GHz
 the 802.11n(20/40) ac(20/40/80) 5GHz has MIMO mode.

Note: G1 means antenna gain for ANT 1 in dBi.
 G2 means antenna gain for ANT 2 in dBi.
 N_{ANT} means the number of Antennas.

1.2 DESCRIPTION OF TEST MODES

To investigate the maximum EMI emission characteristics generates from EUT, the test system was pre-scanning tested base on the consideration of following EUT operation mode or test configuration mode which possible have effect on EMI emission level. Each of these EUT operation mode(s) or test configuration mode(s) mentioned above was evaluated respectively.

Pretest Mode	Description
Mode 1	Normal Link Mode
Mode 2	802.11a / n/ ac 20 CH36/ CH40/ CH48/CH52/CH56/CH64/CH100/CH120/CH140/CH149/ CH157/CH165
Mode 3	802.11n40/ac40 CH38/CH46/CH54/CH62/CH102/CH118/CH134/CH151/ CH159
Mode 4	802.11ac80 CH42/CH58/CH106/CH122/CH155

For Radiated Emission	
Final Test Mode	Description
Mode 1	Normal Link Mode
Mode 2	802.11a / n/ ac 20 CH36/ CH40/ CH48/CH52/CH56/CH64/CH100/CH120/CH140/CH149/ CH157/CH165
Mode 3	802.11n40/ac40 CH38/CH46/CH54/CH62/CH102/CH118/CH134/CH151/ CH159
Mode 4	802.11ac80 CH42/CH58/CH106/CH122/CH155

Note:

- (1) The measurements are performed at the highest, middle, lowest available channels.
- (2) The measurements are performed at all Bit Rate of Transmitter, the worst data was reported

1.3 BLOCK DIGRAM SHOWING THE CONFIGURATION OF SYSTEM TESTED

For AC Conducted Emission Mode

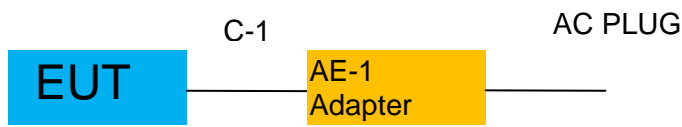

For Radiated Test Cases



For Conducted Test Cases

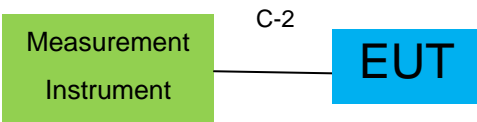

Note: 1. The temporary antenna connector is soldered on the PCB board in order to perform conducted tests and this temporary antenna connector is listed in the equipment list.

1.4 DESCRIPTION OF SUPPORT UNITS(CONDUCTED MODE)

The EUT has been tested as an independent unit together with other necessary accessories or support units. The following support units or accessories were used to form a representative test configuration during the tests.

Item	Equipment	Brand	Model/Type No.	Series No.	Note
AE-1	Adapter	N/A	FY29008000	N/A	Peripherals

Item	Cable Type	Shielded Type	Ferrite Core	Length	Note
C-1	Power Cable	NO	NO	1.2m	
C-2	RF Cable	YES	NO	0.1m	

Note:

- (1) The support equipment was authorized by Declaration of Confirmation.
- (2) For detachable type I/O cable should be specified the length in cm in 『Length』 column.
- (3) During the battery power test, the battery is fully charged.

1.5 EQUIPMENTS LIST FOR ALL TEST ITEMS

Radiation& Conducted Test equipment

Item	Kind of Equipment	Manufacturer	Type No.	Serial No.	Last calibration	Calibrated until	Calibration period
1	Spectrum Analyzer	Agilent	E4407B	MY45108040	2020.05.11	2021.05.10	1 year
2	Spectrum Analyzer	Agilent	N9020A	MY49100060	2020.07.13	2021.07.12	1 year
3	Spectrum Analyzer	R&S	FSV40	101417	2020.08.07	2021.08.06	1 year
4	Test Receiver	R&S	ESPI7	101318	2020.05.11	2021.05.10	1 year
5	Bilog Antenna	TESEQ	CBL6111D	31216	2020.04.11	2021.04.10	1 year
6	50Ω Coaxial Switch	Anritsu	MP59B	6200983705	2020.05.11	2023.05.10	3 year
7	Horn Antenna	EM	EM-AH-10180	2011071402	2020.04.11	2021.04.10	1 year
8	Amplifier	EMC	EMC051835SE	980246	2020.07.13	2021.07.12	1 year
9	Active Loop Antenna	SCHWARZBECK	FMZB 1519B	055	2019.12.11	2020.12.10	1 year
10	Power Meter	DARE	RPR3006W	15100041SN084	2020.07.13	2021.07.12	1 year
11	USB RF Power Sensor	DARE	RPR3006W	15100041SN084	2020.07.13	2021.07.12	1 year
12	Test Cable (9KHz-30MHz)	N/A	R-01	N/A	2019.08.06	2022.08.05	3 year
13	Test Cable (30MHz-1GHz)	N/A	R-02	N/A	2020.07.13	2021.07.12	3 year
14	High Test Cable(1G-40GHz)	N/A	R-03	N/A	2019.06.28	2022.06.27	3 year
15	High Test Cable(1G-40GHz)	N/A	R-04	N/A	2020.04.11	2021.04.10	3 year
16	Filter	TRILTHIC	2400MHz	29	2020.05.11	2021.05.10	3 year
17	temporary antenna connector (Note)	NTS	R001	N/A	N/A	N/A	N/A
18	Low Noise Amplifier	B&Z	BZ-P540-550850-452727	16476-11729	2020.04.15	2021.04.14	1 year
19	Broadband Horn Antenna	SCHWARZBECK	BBHA 9170	803	2019.12.10	2020.12.09	1 year
20	Thermal Chamber	Ten Billion	TTC-B3C	TBN-960502	2020.05.11	2021.05.10	1 year

Note:

We will use the temporary antenna connector (soldered on the PCB board) When conducted test
And this temporary antenna connector is listed within the instrument list

AC Conduction Test equipment

Item	Kind of Equipment	Manufacturer	Type No.	Serial No.	Last calibration	Calibrated until	Calibration period
1	Test Receiver	R&S	ESCI	101160	2020.05.11	2021.05.10	1 year
2	LISN	R&S	ENV216	101313	2020.04.11	2021.04.10	1 year
3	LISN	SCHWARZBECK	NNLK 8129	8129245	2020.05.11	2021.05.10	1 year
4	50Ω Coaxial Switch	ANRITSU CORP	MP59B	6200983704	2020.05.11	2023.05.10	3 year
5	Test Cable (9KHz-30MHz)	N/A	C01	N/A	2020.05.11	2023.05.10	3 year
6	Test Cable (9KHz-30MHz)	N/A	C02	N/A	2020.05.11	2023.05.10	3 year
7	Test Cable (9KHz-30MHz)	N/A	C03	N/A	2020.05.11	2021.05.10	3 year

Note: Each piece of equipment is scheduled for calibration once a year except the Test Cable& Aux Equipment which is scheduled for calibration every 3 years.

2. EMC EMISSION TEST

2.1 CONDUCTED EMISSION MEASUREMENT

2.1.1 APPLICABLE STANDARD

According to FCC Part 15.207(a)

2.1.2 CONFORMANCE LIMIT

Frequency(MHz)	Conducted Emission Limit	
	Quasi-peak	Average
0.15-0.5	66-56*	56-46*
0.5-5.0	56	46
5.0-30.0	60	50

Note: 1. *Decreases with the logarithm of the frequency
 2. The lower limit shall apply at the transition frequencies
 3. The limit decreases in line with the logarithm of the frequency in the range of 0.15 to 0.50MHz.

2.1.3 TEST CONFIGURATION

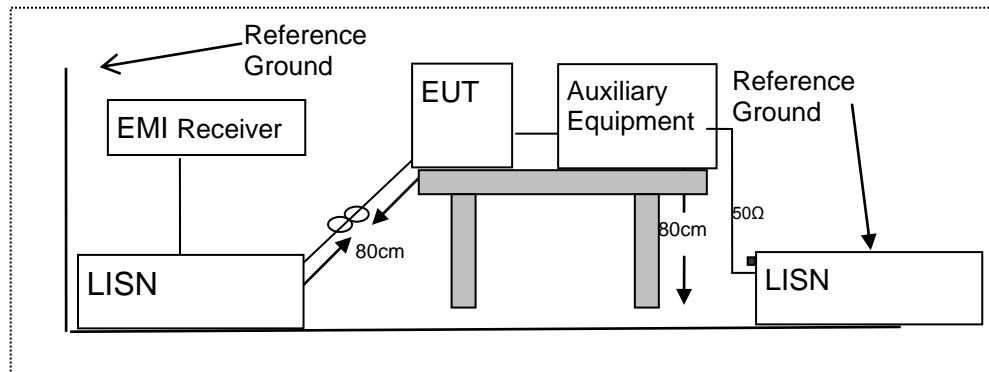

2.1.4 TEST PROCEDURE

According to the requirements in Section 13.1.4.1 of ANSI C63.10-2013 Conducted emissions the EUT measured in the frequency range between 0.15 MHz and 30 MHz using CISPR Quasi-Peak and average detector mode.

1. The EUT was placed 0.4 meter from the conducting wall of the shielding room.
2. The EUT was placed on a table which is 0.8m above ground plane.
3. Connect EUT to the power mains through a line impedance stabilization network (LISN). All other support equipments powered from additional LISN(s). The LISN provide 50 Ohm/ 50uH of coupling impedance for the measuring instrument.
4. Interconnecting cables that hang closer than 40 cm to the ground plane shall be folded back and forth in the center forming a bundle 30 to 40cm long.
5. I/O cables that are not connected to a peripheral shall be bundled in the center. The end of the cable may be terminated, if required, using the correct terminating impedance. The overall length shall not exceed 1 m.
6. LISN at least 80 cm from nearest part of EUT chassis.
7. The frequency range from 150KHz to 30MHz was searched.
8. Set the test-receiver system to Peak Detect Function and specified bandwidth(IF bandwidth=9KHz) with Maximum Hold Mode
9. For the actual test configuration, please refer to the related Item –EUT Test Photos.

EUT :	HolaBot	Model Name. :	HL100
Temperature :	26 °C	Relative Humidity :	56%
Pressure :	1010hPa	Phase :	L
Test Voltage :	DC 29V from Adapter AC 120V/60Hz	Test Mode :	Mode 1(5.2G)

Frequency (MHz)	Reading Level (dBμV)	Correct Factor (dB)	Measure-ment (dBμV)	Limits (dBμV)	Margin (dB)	Remark
0.3019	37.66	9.54	47.20	60.19	-12.99	QP
0.3019	27.87	9.54	37.41	50.19	-12.78	AVG
0.5060	36.83	9.55	46.38	56.00	-9.62	QP
0.5060	26.81	9.55	36.36	46.00	-9.64	AVG
0.7137	38.05	9.55	47.60	56.00	-8.40	QP
0.7137	27.70	9.55	37.25	46.00	-8.75	AVG
0.9100	37.71	9.56	47.27	56.00	-8.73	QP
0.9100	28.00	9.56	37.56	46.00	-8.44	AVG
1.3020	36.30	9.56	45.86	56.00	-10.14	QP
1.3020	25.77	9.56	35.33	46.00	-10.67	AVG
1.8895	37.46	9.58	47.04	56.00	-8.96	QP
1.8895	28.87	9.58	38.45	46.00	-7.55	AVG

Remark:

1. All readings are Quasi-Peak and Average values.
2. Factor = Insertion Loss + Cable Loss.

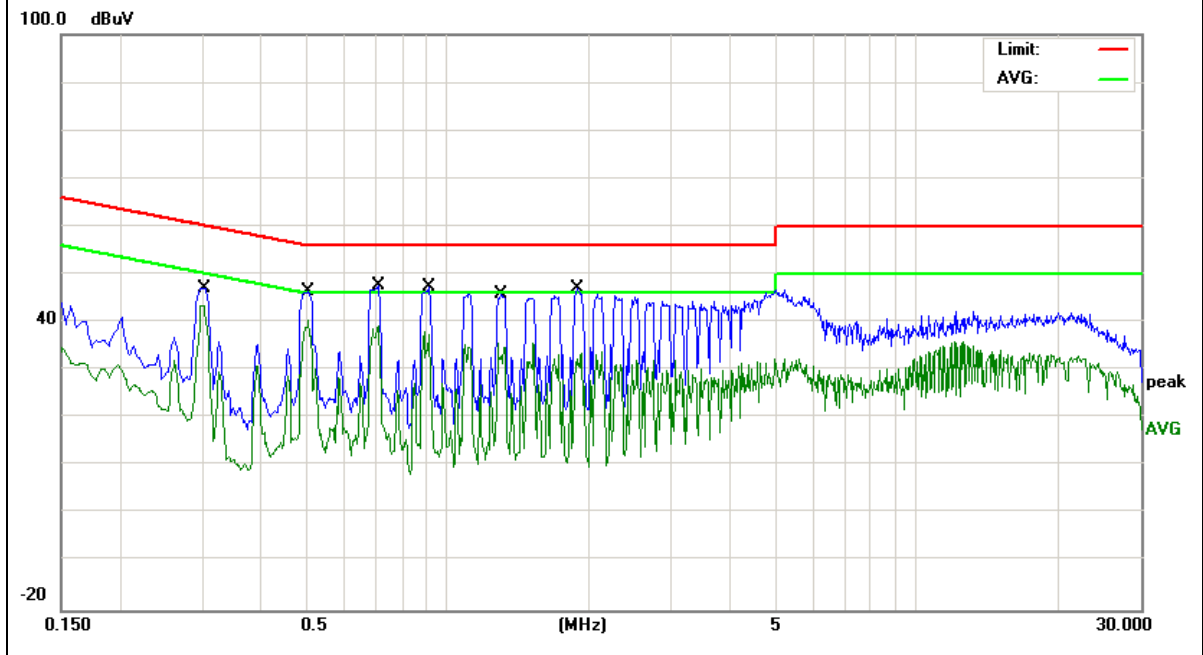

EUT :	HolaBot	Model Name. :	HL100
Temperature :	26 °C	Relative Humidity :	56%
Pressure :	1010hPa	Phase :	N
Test Voltage :	DC 29V from Adapter AC 120V/60Hz	Test Mode :	Mode 1(5.2G)

Frequency (MHz)	Reading Level (dBμV)	Correct Factor (dB)	Measurement (dBμV)	Limits (dBμV)	Margin (dB)	Remark
0.3019	37.82	9.53	47.35	60.19	-12.84	QP
0.3019	28.02	9.53	37.55	50.19	-12.64	AVG
0.5020	38.29	9.54	47.83	56.00	-8.17	QP
0.5020	26.79	9.54	36.33	46.00	-9.67	AVG
0.6860	37.98	9.54	47.52	56.00	-8.48	QP
0.6860	28.51	9.54	38.05	46.00	-7.95	AVG
1.1100	37.75	9.55	47.30	56.00	-8.70	QP
1.1100	28.10	9.55	37.65	46.00	-8.35	AVG
1.8935	36.79	9.57	46.36	56.00	-9.64	QP
1.8935	27.07	9.57	36.64	46.00	-9.36	AVG
4.9458	38.22	9.61	47.83	56.00	-8.17	QP
4.9458	27.54	9.61	37.15	46.00	-8.85	AVG

Remark:

1. All readings are Quasi-Peak and Average values.
2. Factor = Insertion Loss + Cable Loss.

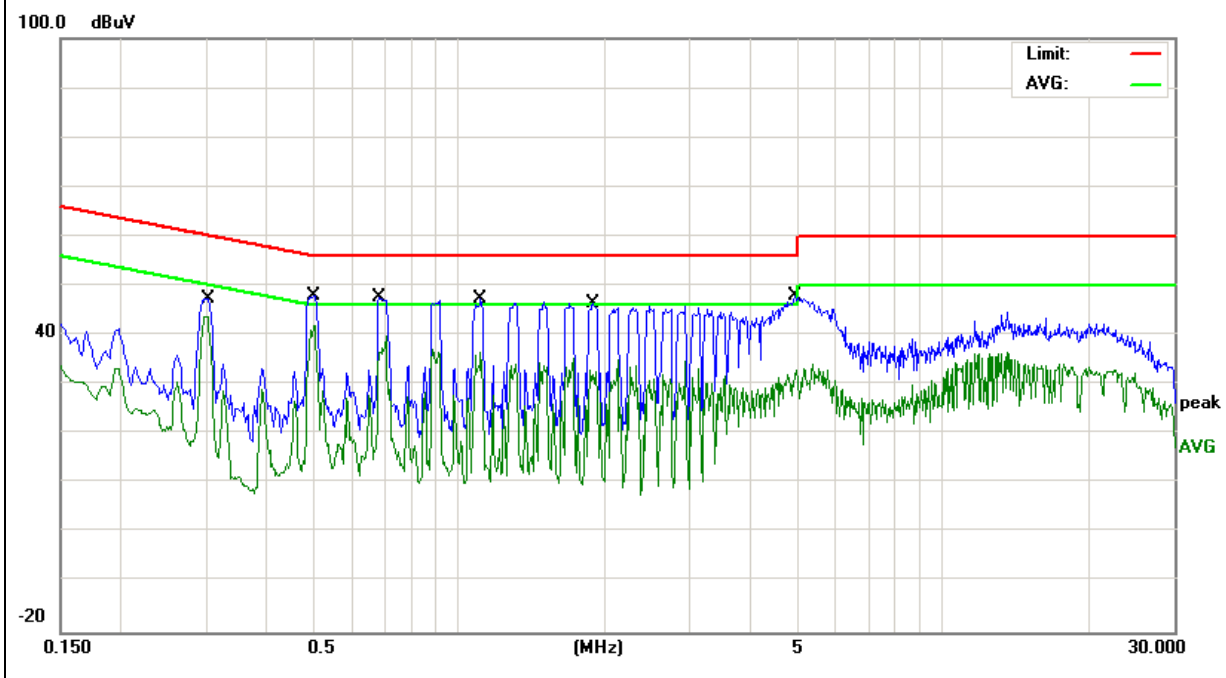

EUT :	HolaBot	Model Name. :	HL100
Temperature :	26 °C	Relative Humidity :	56%
Pressure :	1010hPa	Phase :	L
Test Voltage :	DC 29V from Adapter AC 120V/60Hz	Test Mode :	Mode 1(5.3G)

Frequency (MHz)	Reading Level (dBμV)	Correct Factor (dB)	Measurement (dBμV)	Limits (dBμV)	Margin (dB)	Remark
0.2977	38.30	9.54	47.84	60.30	-12.46	QP
0.2977	28.61	9.54	38.15	50.30	-12.15	AVG
0.4863	37.76	9.55	47.31	56.23	-8.92	QP
0.4863	27.78	9.55	37.33	46.23	-8.90	AVG
0.7137	38.16	9.55	47.71	56.00	-8.29	QP
0.7137	27.70	9.55	37.25	46.00	-8.75	AVG
0.9140	38.98	9.56	48.54	56.00	-7.46	QP
0.9140	28.46	9.56	38.02	46.00	-7.98	AVG
1.4979	39.10	9.56	48.66	56.00	-7.34	QP
1.4979	28.88	9.56	38.44	46.00	-7.56	AVG
2.6699	37.61	9.59	47.20	56.00	-8.80	QP
2.6699	28.10	9.59	37.69	46.00	-8.31	AVG

Remark:

1. All readings are Quasi-Peak and Average values.
2. Factor = Insertion Loss + Cable Loss.

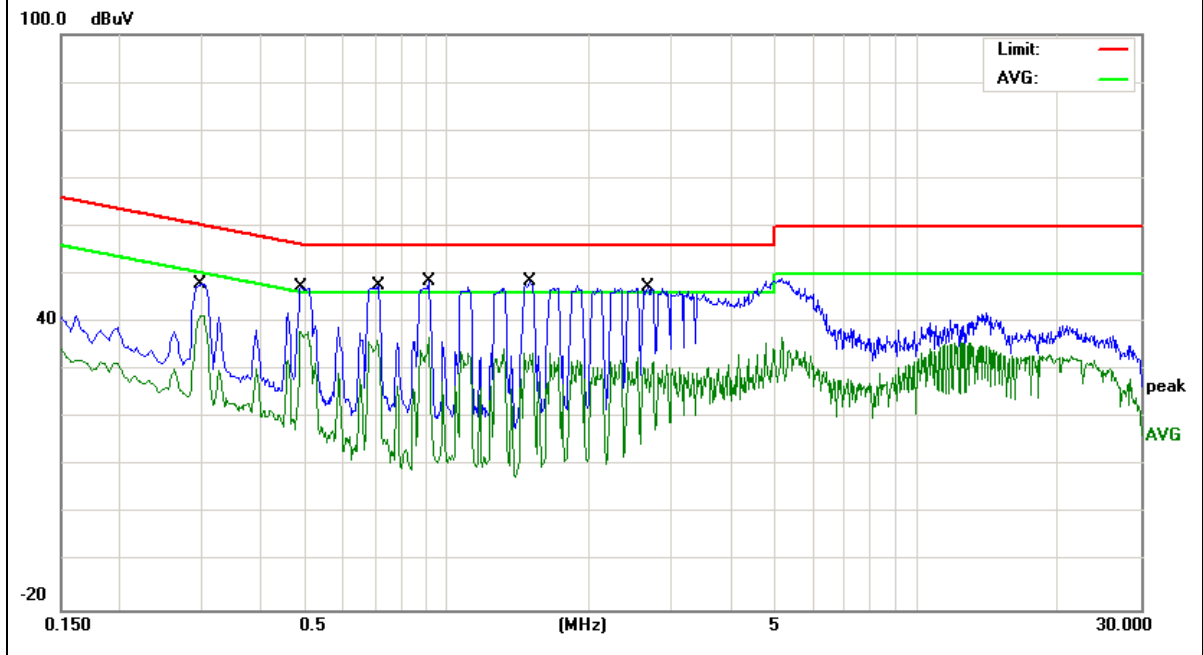

EUT :	HolaBot	Model Name. :	HL100
Temperature :	26 °C	Relative Humidity :	56%
Pressure :	1010hPa	Phase :	N
Test Voltage :	DC 29V from Adapter AC 120V/60Hz	Test Mode :	Mode 1(5.3G)

Frequency (MHz)	Reading Level (dBμV)	Correct Factor (dB)	Measurement (dBμV)	Limits (dBμV)	Margin (dB)	Remark
0.3019	38.68	9.53	48.21	60.19	-11.98	QP
0.3019	29.13	9.53	38.66	50.19	-11.53	AVG
0.5060	38.73	9.54	48.27	56.00	-7.73	QP
0.5060	28.71	9.54	38.25	46.00	-7.75	AVG
0.7016	38.88	9.54	48.42	56.00	-7.58	QP
0.7016	29.79	9.54	39.33	46.00	-6.67	AVG
0.9100	39.30	9.55	48.85	56.00	-7.15	QP
0.9100	28.60	9.55	38.15	46.00	-7.85	AVG
1.3060	38.41	9.55	47.96	56.00	-8.04	QP
1.3060	27.70	9.55	37.25	46.00	-8.75	AVG
4.8859	38.65	9.61	48.26	56.00	-7.74	QP
4.8859	28.41	9.61	38.02	46.00	-7.98	AVG

Remark:

1. All readings are Quasi-Peak and Average values.
2. Factor = Insertion Loss + Cable Loss.

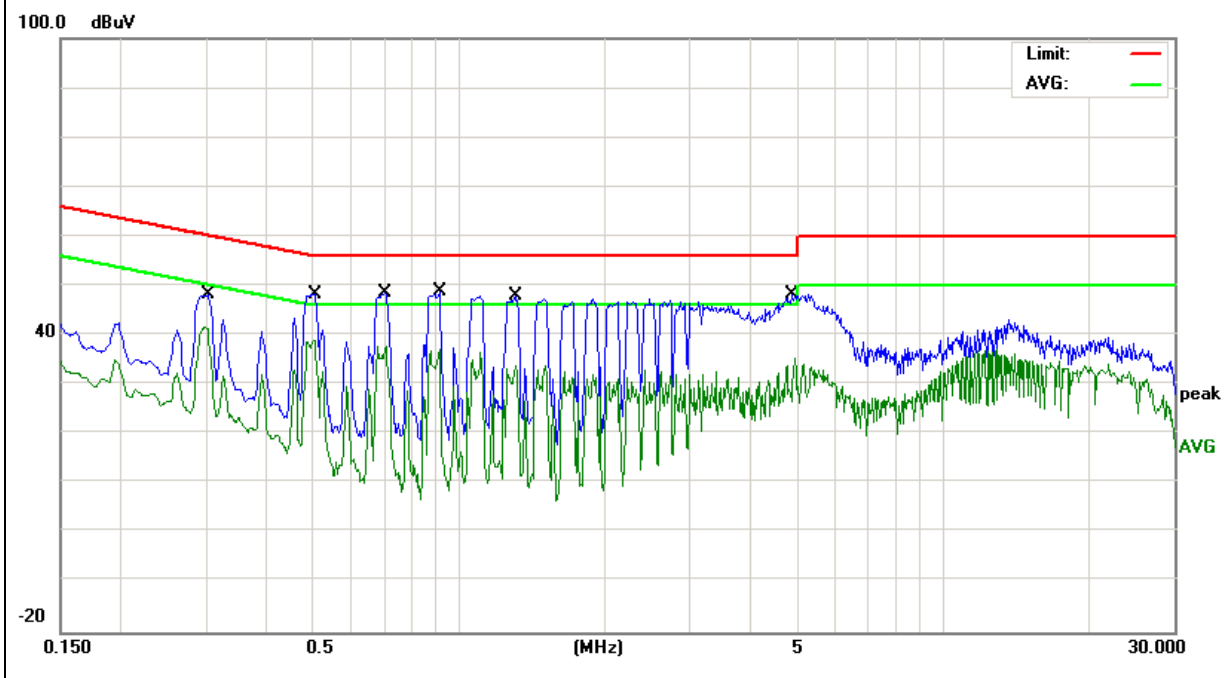

EUT :	HolaBot	Model Name. :	HL100
Temperature :	26 °C	Relative Humidity :	56%
Pressure :	1010hPa	Phase :	L
Test Voltage :	DC 29V from Adapter AC 120V/60Hz	Test Mode :	Mode 1(5.6G)

Frequency (MHz)	Reading Level (dBμV)	Correct Factor (dB)	Measure-ment (dBμV)	Limits (dBμV)	Margin (dB)	Remark
0.3019	38.16	9.54	47.70	60.19	-12.49	QP
0.3019	28.01	9.54	37.55	50.19	-12.64	AVG
0.5060	37.83	9.55	47.38	56.00	-8.62	QP
0.5060	27.97	9.55	37.52	46.00	-8.48	AVG
0.7137	36.55	9.55	46.10	56.00	-9.90	QP
0.7137	26.86	9.55	36.41	46.00	-9.59	AVG
0.9140	36.47	9.56	46.03	56.00	-9.97	QP
0.9140	26.77	9.56	36.33	46.00	-9.67	AVG
1.3099	34.54	9.56	44.10	56.00	-11.90	QP
1.3099	24.69	9.56	34.25	46.00	-11.75	AVG
5.0259	37.23	9.62	46.85	60.00	-13.15	QP
5.0259	26.56	9.62	36.18	50.00	-13.82	AVG

Remark:

1. All readings are Quasi-Peak and Average values.
2. Factor = Insertion Loss + Cable Loss.

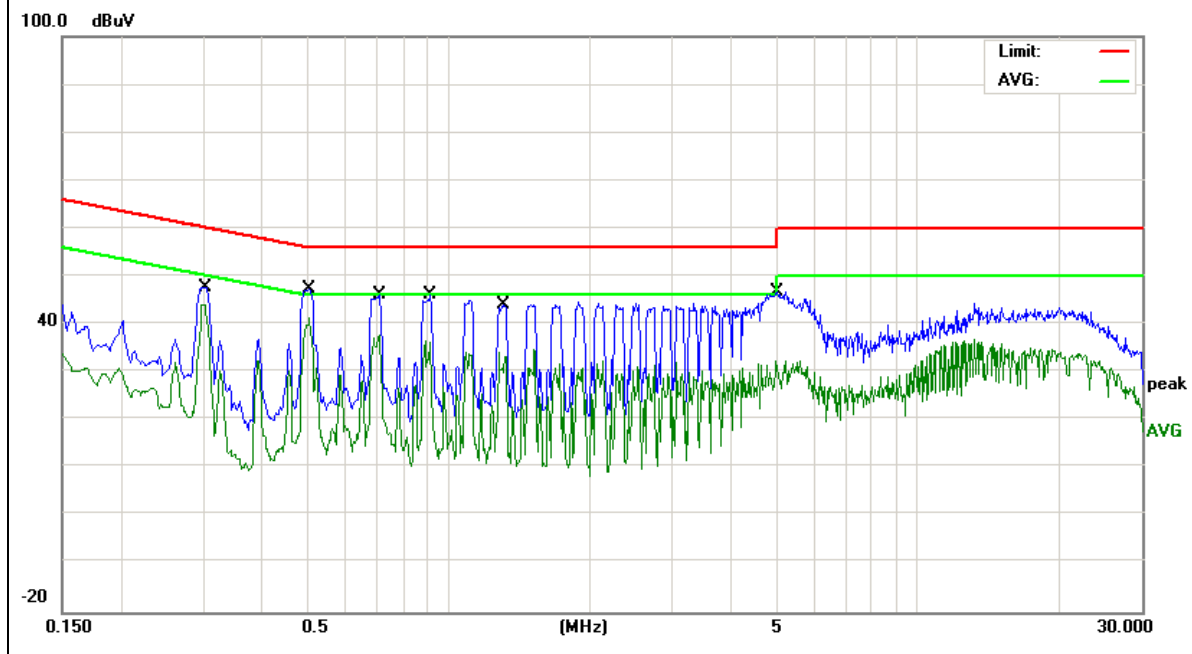

EUT :	HolaBot	Model Name. :	HL100
Temperature :	26 °C	Relative Humidity :	56%
Pressure :	1010hPa	Phase :	N
Test Voltage :	DC 29V from Adapter AC 120V/60Hz	Test Mode :	Mode 1(5.6G)

Frequency (MHz)	Reading Level (dBμV)	Correct Factor (dB)	Measurement (dBμV)	Limits (dBμV)	Margin (dB)	Remark
0.3019	36.82	9.53	46.35	60.19	-13.84	QP
0.3019	27.16	9.53	36.69	50.19	-13.50	AVG
0.5020	36.29	9.54	45.83	56.00	-10.17	QP
0.5020	25.71	9.54	35.25	46.00	-10.75	AVG
0.7056	36.04	9.54	45.58	56.00	-10.42	QP
0.7056	25.92	9.54	35.46	46.00	-10.54	AVG
0.9100	36.65	9.55	46.20	56.00	-9.80	QP
0.9100	27.14	9.55	36.69	46.00	-9.31	AVG
1.3020	36.49	9.55	46.04	56.00	-9.96	QP
1.3020	27.19	9.55	36.74	46.00	-9.26	AVG
1.8934	36.29	9.57	45.86	56.00	-10.14	QP
1.8934	25.55	9.57	35.12	46.00	-10.88	AVG

Remark:

1. All readings are Quasi-Peak and Average values.
2. Factor = Insertion Loss + Cable Loss.

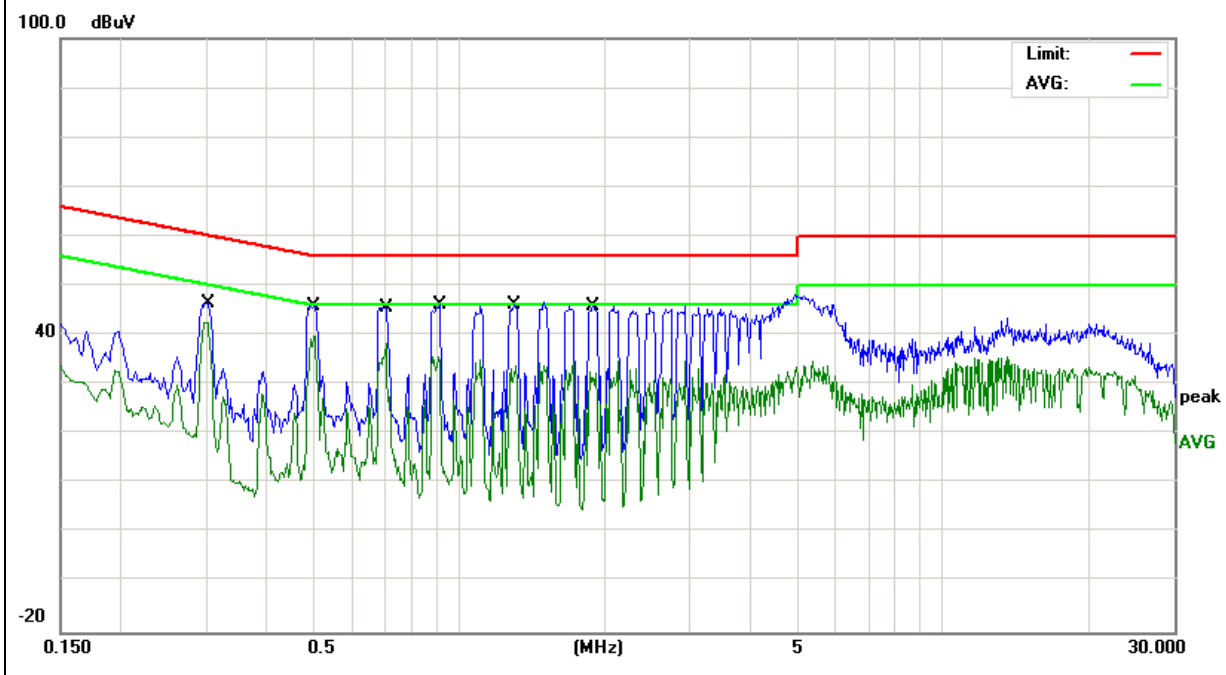

EUT :	HolaBot	Model Name. :	HL100
Temperature :	26 °C	Relative Humidity :	56%
Pressure :	1010hPa	Phase :	L
Test Voltage :	DC 29V from Adapter AC 120V/60Hz	Test Mode :	Mode 1(5.8G)

Frequency (MHz)	Reading Level (dBμV)	Correct Factor (dB)	Measurement (dBμV)	Limits (dBμV)	Margin (dB)	Remark
0.2977	38.30	9.54	47.84	60.30	-12.46	QP
0.2977	27.61	9.54	37.15	50.30	-13.15	AVG
0.5060	39.99	9.55	49.54	56.00	-6.46	QP
0.5060	30.14	9.55	39.69	46.00	-6.31	AVG
0.7137	39.16	9.55	48.71	56.00	-7.29	QP
0.7137	28.60	9.55	38.15	46.00	-7.85	AVG
0.9140	39.48	9.56	49.04	56.00	-6.96	QP
0.9140	29.89	9.56	39.45	46.00	-6.55	AVG
1.4979	38.10	9.56	47.66	56.00	-8.34	QP
1.4979	27.69	9.56	37.25	46.00	-8.75	AVG
1.8894	37.15	9.58	46.73	56.00	-9.27	QP
1.8894	26.64	9.58	36.22	46.00	-9.78	AVG

Remark:

1. All readings are Quasi-Peak and Average values.
2. Factor = Insertion Loss + Cable Loss.

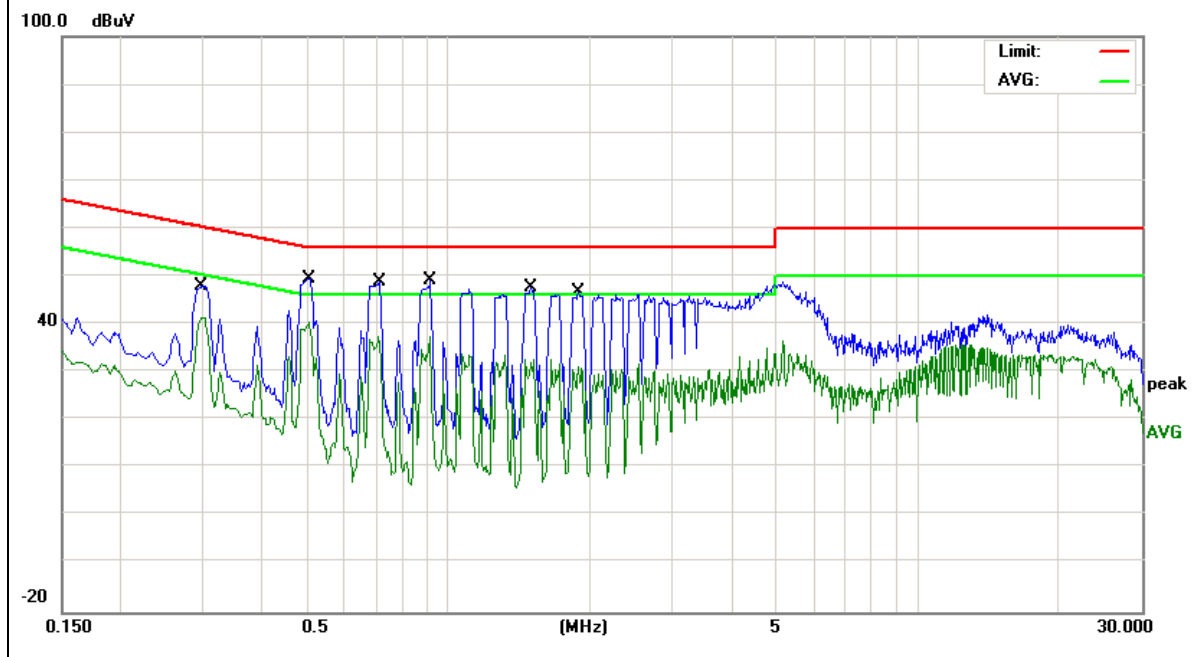

EUT :	HolaBot	Model Name. :	HL100
Temperature :	26 °C	Relative Humidity :	56%
Pressure :	1010hPa	Phase :	N
Test Voltage :	DC 29V from Adapter AC 120V/60Hz	Test Mode :	Mode 1(5.8G)

Frequency (MHz)	Reading Level (dBμV)	Correct Factor (dB)	Measure-ment (dBμV)	Limits (dBμV)	Margin (dB)	Remark
0.2923	38.29	9.53	47.82	60.46	-12.64	QP
0.2923	27.70	9.53	37.23	50.46	-13.23	AVG
0.5060	39.23	9.54	48.77	56.00	-7.23	QP
0.5060	28.48	9.54	38.02	46.00	-7.98	AVG
0.7016	38.88	9.54	48.42	56.00	-7.58	QP
0.7016	28.91	9.54	38.45	46.00	-7.55	AVG
0.9100	39.30	9.55	48.85	56.00	-7.15	QP
0.9100	28.78	9.55	38.33	46.00	-7.67	AVG
1.1100	38.48	9.55	48.03	56.00	-7.97	QP
1.1100	29.14	9.55	38.69	46.00	-7.31	AVG
1.4979	37.81	9.55	47.36	56.00	-8.64	QP
1.4979	27.60	9.55	37.15	46.00	-8.85	AVG

Remark:

1. All readings are Quasi-Peak and Average values.
2. Factor = Insertion Loss + Cable Loss.

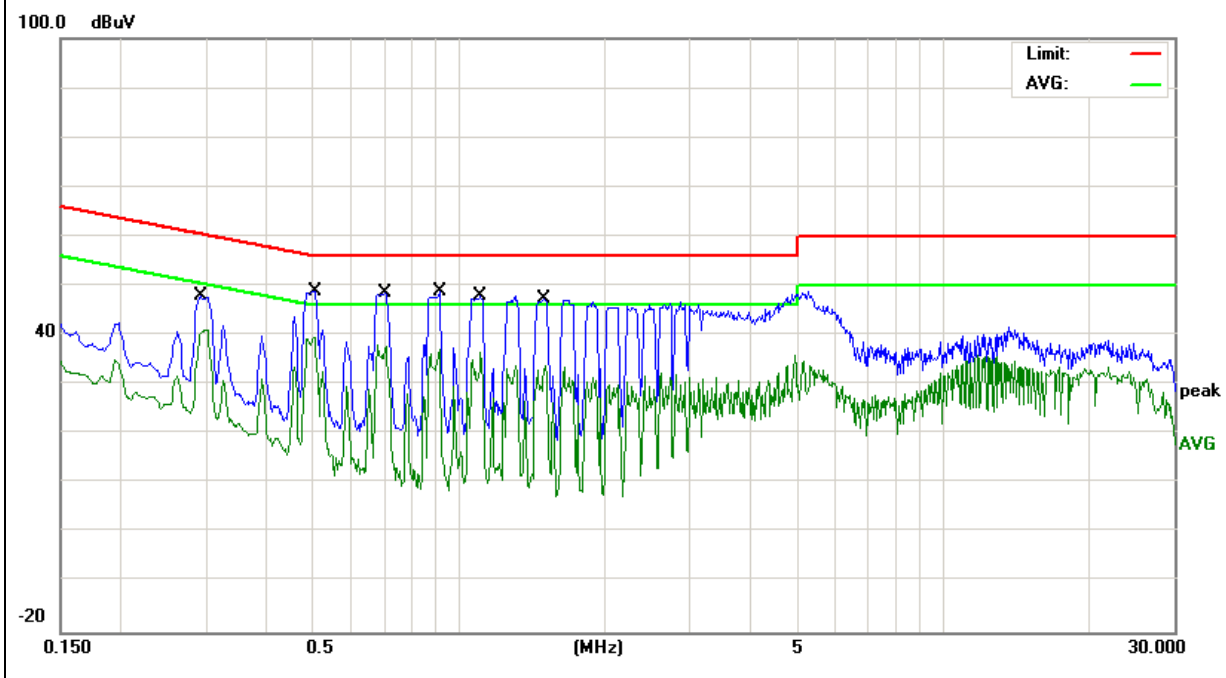

2.2 RADIATED EMISSION MEASUREMENT

2.2.1 APPLICABLE STANDARD

According to FCC Part 15.407(d) and 15.209

2.2.2 CONFORMANCE LIMIT

According to FCC Part 15.407(b)(7): radiated emissions which fall in the restricted bands, as defined in §15.205(a), must also comply with the radiated emission limits specified in §15.209(a) (see §15.205(c)).
According to FCC Part 15.205, Restricted bands

MHz	MHz	MHz	GHz
0.090-0.110	16.42-16.423	399.9-410	4.5-5.15
0.495-0.505	16.69475-16.69525	608-614	5.35-5.46
2.1735-2.1905	16.80425-16.80475	960-1240	7.25-7.75
4.125-4.128	25.5-25.67	1300-1427	8.025-8.5
4.17725-4.17775	37.5-38.25	1435-1626.5	9.0-9.2
4.20725-4.20775	73-74.6	1645.5-1646.5	9.3-9.5
6.215-6.218	74.8-75.2	1660-1710	10.6-12.7
6.26775-6.26825	123-138	2200-2300	14.47-14.5
8.291-8.294	149.9-150.05	2310-2390	15.35-16.2
8.362-8.366	156.52475-156.52525	2483.5-2500	17.7-21.4
8.37625-8.38675	156.7-156.9	2690-2900	22.01-23.12
8.41425-8.41475	162.0125-167.17	3260-3267	23.6-24.0
12.29-12.293	167.72-173.2	3332-3339	31.2-31.8
12.51975-12.52025	240-285	3345.8-3358	36.43-36.5
12.57675-12.57725	322-335.4	3600-4400	(2)
13.36-13.41			

20dBc in any 100 kHz bandwidth outside the operating frequency band. In case the emission fall within the restricted band specified on 15.205(a), then the 15.209(a) limit in the table below has to be followed.

Restricted Frequency(MHz)	Field Strength (µV/m)	Field Strength (dBµV/m)	Measurement Distance
0.009~0.490	2400/F(KHz)	20 log (uV/m)	300
0.490~1.705	24000/F(KHz)	20 log (uV/m)	30
1.705~30.0	30	29.5	30
30-88	100	40	3
88-216	150	43.5	3
216-960	200	46	3
Above 960	500	54	3

Limits of Radiated Emission Measurement(Above 1000MHz)

Frequency(MHz)	Class B (dBuV/m) (at 3M)	
	PEAK	AVERAGE
Above 1000	74	54

Remark :1. Emission level in dBuV/m=20 log (uV/m)
 2. Measurement was performed at an antenna to the closed point of EUT distance of meters.
 3. For Frequency 9kHz~30MHz:
 Distance extrapolation factor =40log(Specific distance/ test distance)(dB);
 Limit line=Specific limits(dBuV) + distance extrapolation factor.
 For Frequency above 30MHz:
 Distance extrapolation factor =20log(Specific distance/ test distance)(dB);
 Limit line=Specific limits(dBuV) + distance extrapolation factor.

2.2.3 MEASURING INSTRUMENTS

The Measuring equipment is listed in the section 6.3 of this test report.

2.2.4 TEST CONFIGURATION

(a) For radiated emissions below 30MHz

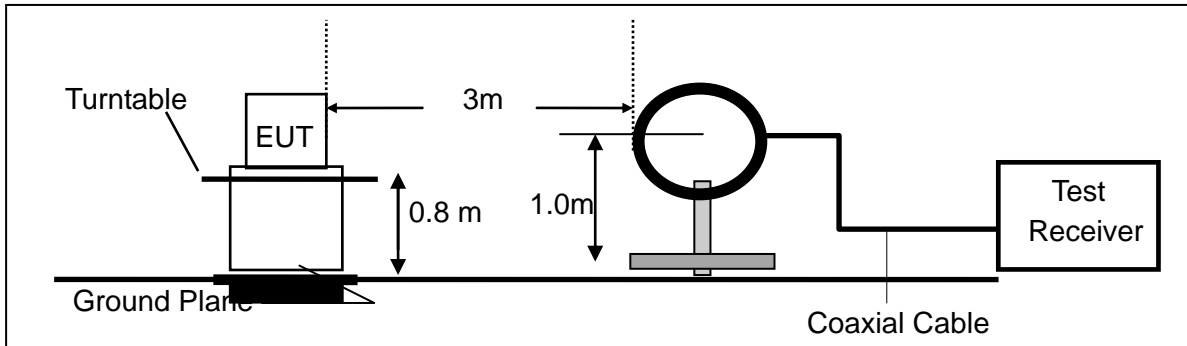

(b) For radiated emissions from 30MHz to 1000MHz

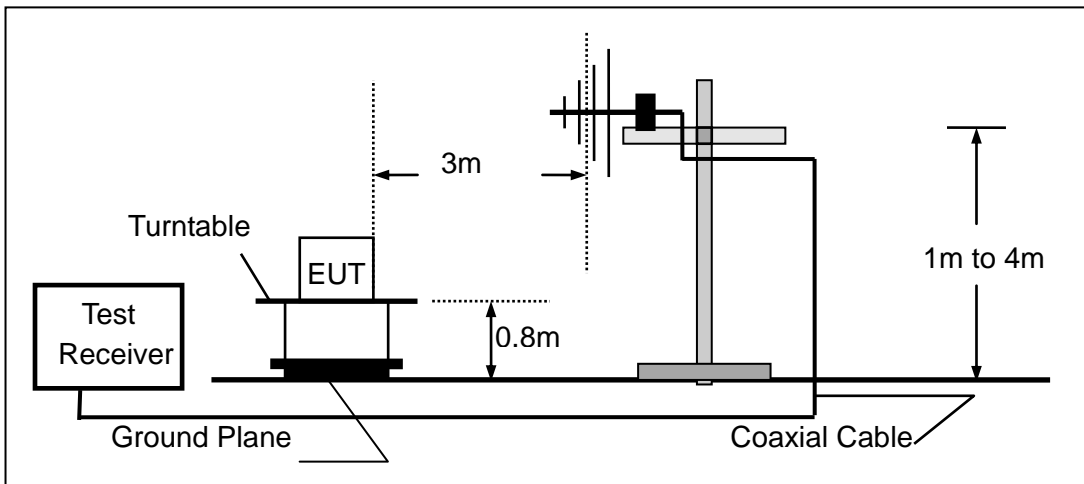

(c) For radiated emissions above 1000MHz

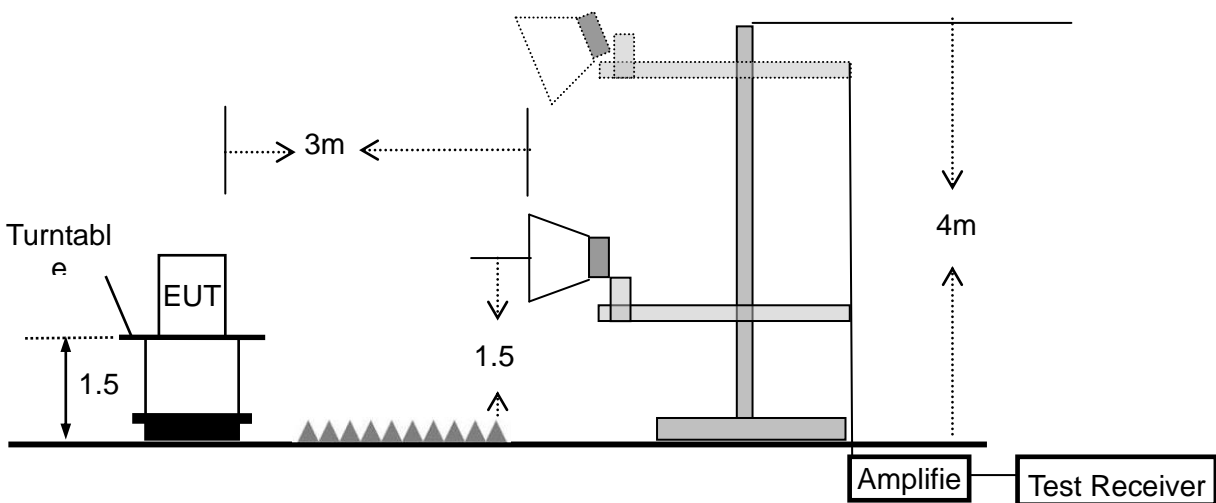

2.2.5 TEST PROCEDURE

The test site semi-anechoic chamber has met the requirement of NSA tolerance 4 dB according to the standards: ANSI C63.10-2013. The test distance is 3m. The setup is according to the requirements in Section 13.1.4.1 of ANSI C63.10-2013 and CAN/CSA-CEI/IEC CISPR 22.

This test is required for any spurious emission that falls in a Restricted Band, as defined in Section 15.205. It must be performed with the highest gain of each type of antenna proposed for use with the EUT.

Use the following spectrum analyzer settings:

Spectrum Parameter	Setting
Attenuation	Auto
Start Frequency	1000 MHz
Stop Frequency	10th carrier harmonic
RB / VB (emission in restricted band)	1 MHz / 1 MHz for Peak, 1 MHz / 10Hz for Average

Receiver Parameter	Setting
Attenuation	Auto
Start ~ Stop Frequency	9kHz~150kHz / RB 200Hz for QP
Start ~ Stop Frequency	150kHz~30MHz / RB 9kHz for QP
Start ~ Stop Frequency	30MHz~1000MHz / RB 120kHz for QP

- The measuring distance of at 3 m shall be used for measurements at frequency up to 1GHz. For frequencies above 1GHz, any suitable measuring distance may be used.
- The EUT was placed on the top of a rotating table 0.8 m for below 1GHz and 1.5m for above 1GHz the ground at a 3 meter. The table was rotated 360 degrees to determine the position of the highest radiation.
- The height of the equipment or of the substitution antenna shall be 0.8 m for below 1GHz and 1.5m for above 1GHz; the height of the test antenna shall vary between 1 m to 4 m. Both horizontal and vertical polarizations of the antenna are set to make the measurement.
- The initial step in collecting conducted emission data is a spectrum analyzer peak detector mode pre-scanning the measurement frequency range. Significant peaks are then marked and then Quasi Peak detector mode re-measured.
- If the Peak Mode measured value compliance with and lower than Quasi Peak Mode Limit, the EUT shall be deemed to meet QP Limits and then no additional QP Mode measurement performed.
- For the actual test configuration, please refer to the related Item –EUT Test Photos.

Note:

Both horizontal and vertical antenna polarities were tested and performed pretest to three orthogonal axis. The worst case emissions were reported

During the radiated emission test, the Spectrum Analyzer was set with the following configurations:

Frequency Band (MHz)	Function	Resolution bandwidth	Video Bandwidth
30 to 1000	QP	120 kHz	300 kHz
Above 1000	Peak	1 MHz	1 MHz
	Average	1 MHz	10 Hz

Note: for the frequency ranges below 30 MHz, a narrower RBW is used for these ranges but the measured value should add a RBW correction factor (RBWCF) where $RBWCF [dB] = 10 \cdot \lg(100 [kHz]/\text{narrower RBW [kHz]})$. , the narrower RBW is 1 kHz and RBWCF is 20 dB for the frequency 9 kHz to 150 kHz, and the narrower RBW is 10 kHz and RBWCF is 10 dB for the frequency 150 kHz to 30 MHz.

2.2.6 TEST RESULTS (9KHZ – 30 MHZ)

EUT :	HolaBot	Model Name :	HL100
Temperature :	26 °C	Relative Humidity :	54%
Pressure:	1010 hPa	Test Voltage :	DC 25.55V
Test Mode :	TX	Polarization :	--

Freq. (MHz)	Reading (dBuV/m)	Limit (dBuV/m)	Margin (dB)	State P/F
--	--	--	--	N/A
--	--	--	--	N/A

NOTE:

The amplitude of spurious emissions which are attenuated by more than 20dB below the permissible value has no need to be reported.

2.2.7 TEST RESULTS (30MHZ – 1GHZ)

EUT :	HolaBot	Model Name :	HL100
Temperature :	26 °C	Relative Humidity :	54%
Pressure :	1010 hPa	Test Voltage :	DC 25.55V
Test Mode :	TX(5.2G)- 802.11ac40 (Low CH)		

Polar (H/V)	Frequency	Meter Reading	Factor	Emission Level	Limits	Margin	Remark
	(MHz)	(dBuV)	(dB)	(dBuV/m)	(dBuV/m)	(dB)	
V	42.3021	22.66	12.59	35.25	40.00	-4.75	QP
V	47.9938	21.43	10.86	32.29	40.00	-7.71	QP
V	85.5977	21.18	9.18	30.36	40.00	-9.64	QP
V	188.4122	19.27	9.35	28.62	43.50	-14.88	QP
V	213.7632	21.22	9.86	31.08	43.50	-12.42	QP
V	588.9048	11.34	21.46	32.80	46.00	-13.20	QP

Remark:

Absolute Level= ReadingLevel+ Factor, Margin= Absolute Level - Limit

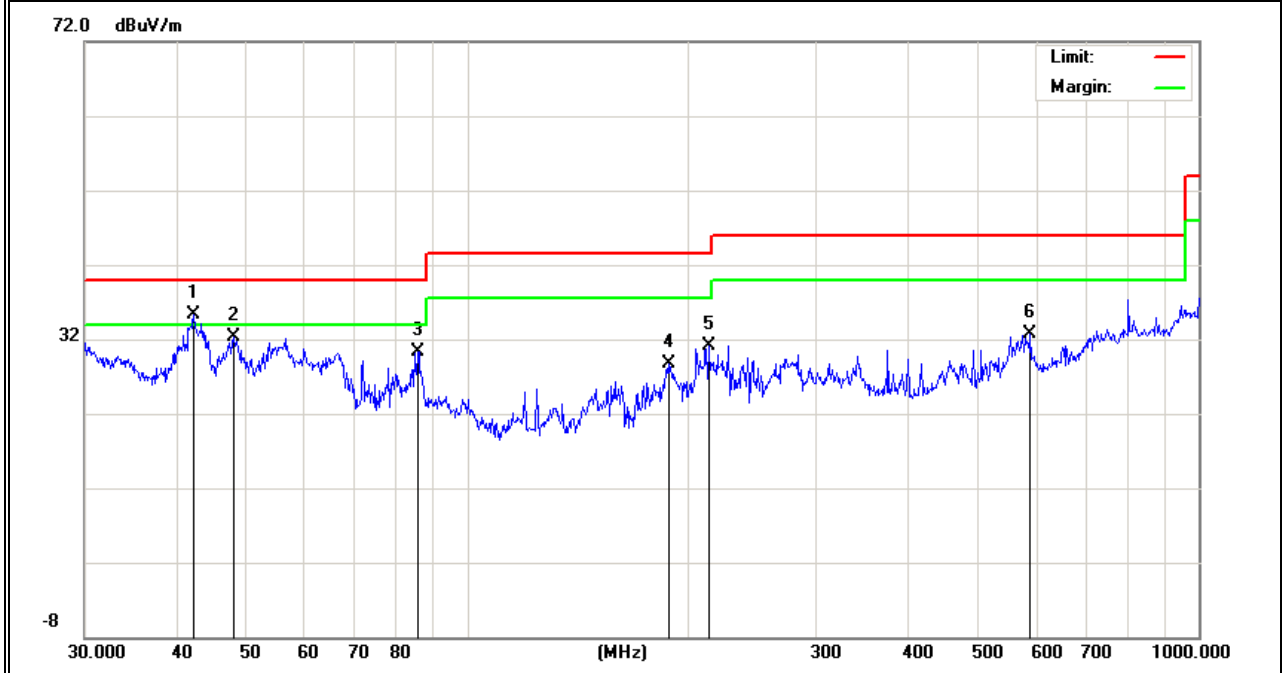

Polar (H/V)	Frequency	Meter Reading	Factor	Emission Level	Limits	Margin	Remark
	(MHz)	(dBUV)	(dB)	(dBUV/m)	(dBUV/m)	(dB)	
H	66.0340	15.77	6.10	21.87	40.00	-18.13	QP
H	86.2001	12.61	9.31	21.92	40.00	-18.08	QP
H	119.4360	10.12	12.43	22.55	43.50	-20.95	QP
H	158.1123	19.09	11.13	30.22	43.50	-13.28	QP
H	179.3863	21.23	10.06	31.29	43.50	-12.21	QP
H	247.6819	20.86	13.17	34.03	46.00	-11.97	QP

Remark:

Absolute Level= ReadingLevel+ Factor, Margin= Absolute Level - Limit

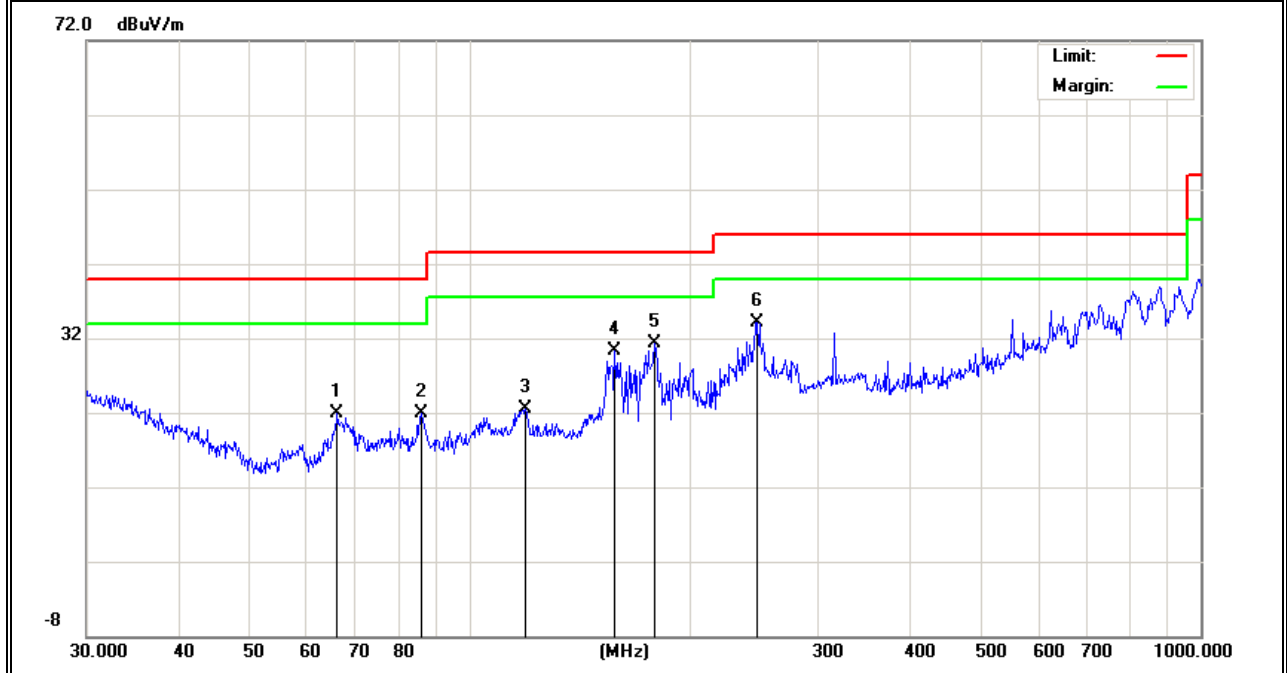

EUT :	HolaBot	Model Name :	HL100
Temperature :	26 °C	Relative Humidity :	54%
Pressure :	1010 hPa	Test Voltage :	DC 25.55V
Test Mode :	TX(5.3G)- 802.11n40 (Middle CH)		

Polar (H/V)	Frequency	Meter Reading	Factor	Emission Level	Limits	Margin	Remark
	(MHz)	(dBuV)	(dB)	(dBuV/m)	(dBuV/m)	(dB)	
V	43.9658	20.88	11.96	32.84	40.00	-7.16	QP
V	59.2325	23.91	6.09	30.00	40.00	-10.00	QP
V	119.8555	15.13	12.43	27.56	43.50	-15.94	QP
V	250.3009	19.15	13.48	32.63	46.00	-13.37	QP
V	375.9384	19.62	16.97	36.59	46.00	-9.41	QP
V	552.8831	13.80	22.54	36.34	46.00	-9.66	QP

Remark:

Absolute Level= ReadingLevel+ Factor, Margin= Absolute Level - Limit

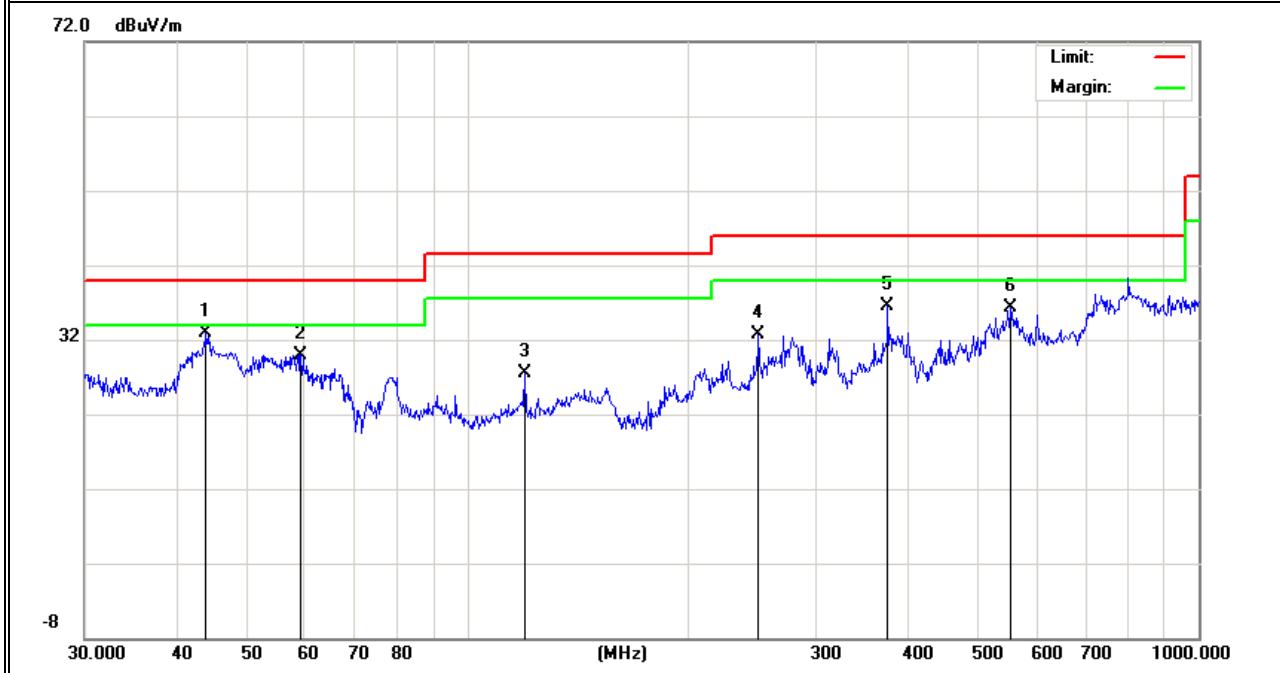

Polar (H/V)	Frequency	Meter Reading	Factor	Emission Level	Limits	Margin	Remark
	(MHz)	(dBuV)	(dB)	(dBuV/m)	(dBuV/m)	(dB)	
H	33.9174	7.26	17.34	24.60	40.00	-15.40	QP
H	67.9128	18.27	5.92	24.19	40.00	-15.81	QP
H	119.8555	12.49	12.43	24.92	43.50	-18.58	QP
H	249.4250	18.31	13.39	31.70	46.00	-14.30	QP
H	375.9384	14.33	16.97	31.30	46.00	-14.70	QP
H	590.9737	17.31	21.43	38.74	46.00	-7.26	QP

Remark:

Absolute Level= ReadingLevel+ Factor, Margin= Absolute Level - Limit

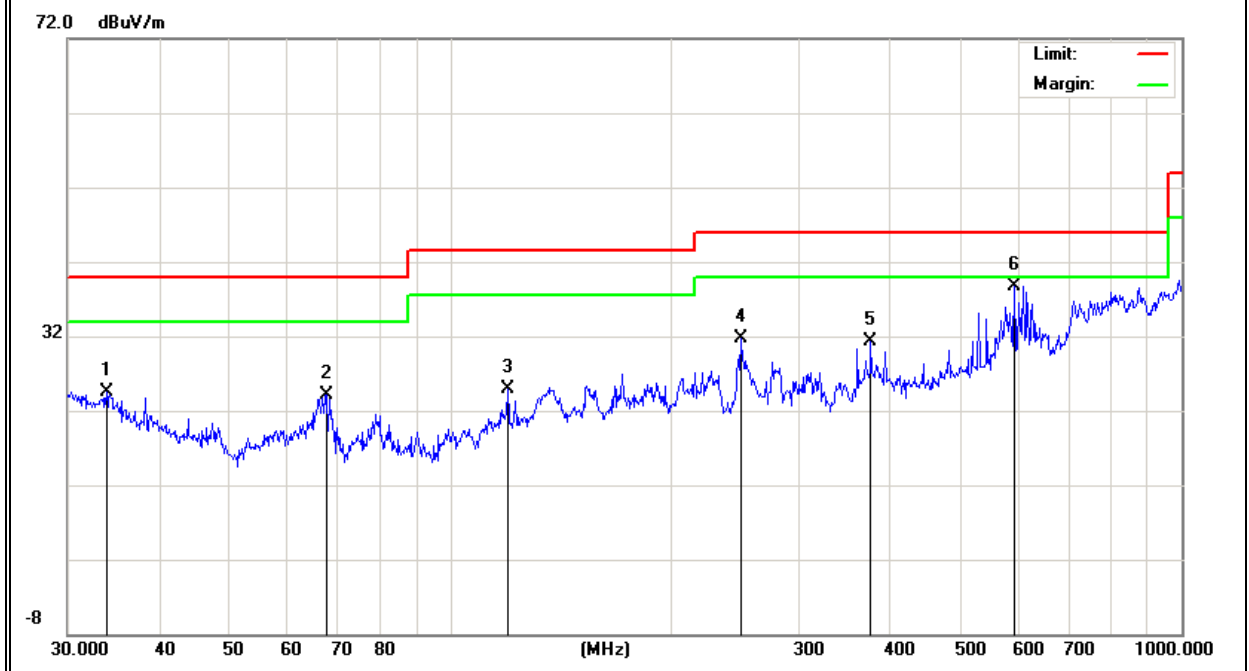

EUT :	HolaBot	Model Name :	HL100
Temperature :	26 °C	Relative Humidity :	54%
Pressure :	1010 hPa	Test Voltage :	DC 25.55V
Test Mode :	TX(5.6G)- 802.11n20 (Low CH)		

Polar (H/V)	Frequency	Meter Reading	Factor	Emission Level	Limits	Margin	Remark
	(MHz)	(dBuV)	(dB)	(dBuV/m)	(dBuV/m)	(dB)	
V	42.1542	22.32	12.64	34.96	40.00	-5.04	QP
V	57.5938	28.64	6.31	34.95	40.00	-5.05	QP
V	85.8983	21.79	9.28	31.07	40.00	-8.93	QP
V	180.0165	20.00	10.05	30.05	43.50	-13.45	QP
V	270.3747	18.99	14.30	33.29	46.00	-12.71	QP
V	315.4806	18.59	15.24	33.83	46.00	-12.17	QP

Remark:

Absolute Level= ReadingLevel+ Factor, Margin= Absolute Level - Limit

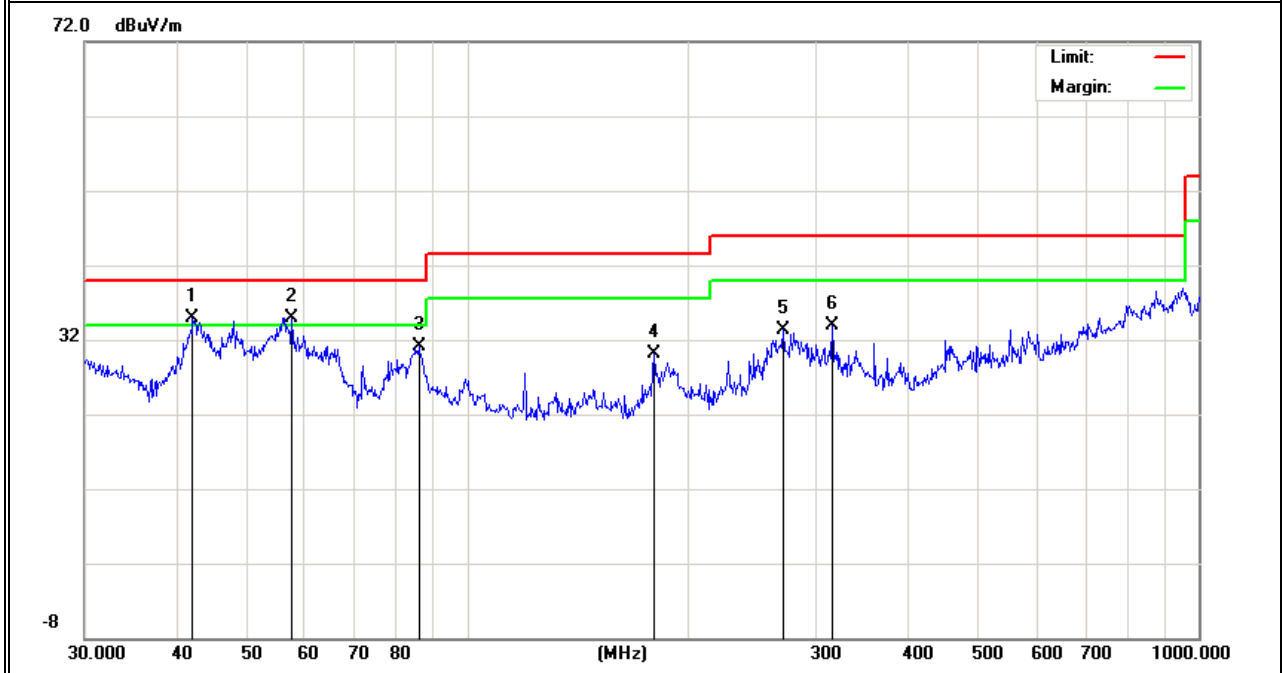

Polar (H/V)	Frequency	Meter Reading	Factor	Emission Level	Limits	Margin	Remark
	(MHz)	(dBuV)	(dB)	(dBuV/m)	(dBuV/m)	(dB)	
H	66.4989	18.96	6.05	25.01	40.00	-14.99	QP
H	86.5027	14.77	9.29	24.06	40.00	-15.94	QP
H	135.0319	14.24	12.50	26.74	43.50	-16.76	QP
H	154.8204	17.82	11.69	29.51	43.50	-13.99	QP
H	187.7529	23.30	9.41	32.71	43.50	-10.79	QP
H	246.8146	18.47	13.07	31.54	46.00	-14.46	QP

Remark:

Absolute Level= ReadingLevel+ Factor, Margin= Absolute Level - Limit

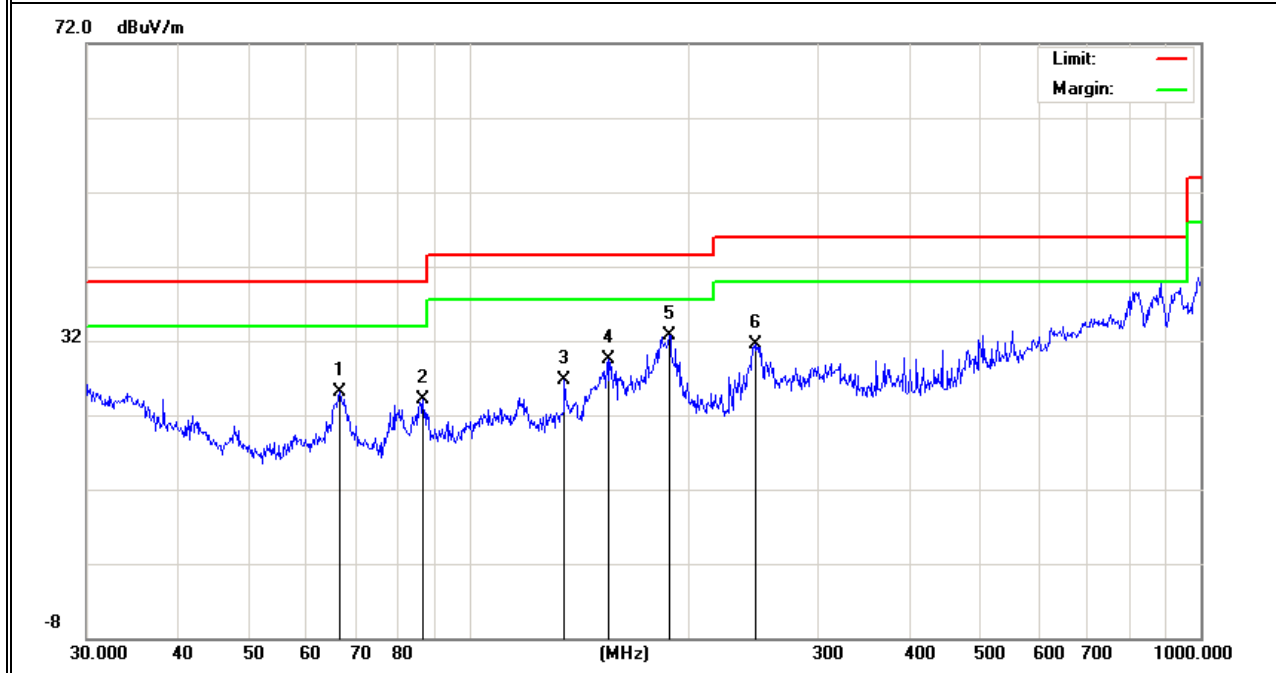

EUT :	HolaBot	Model Name :	HL100
Temperature :	26 °C	Relative Humidity :	54%
Pressure :	1010 hPa	Test Voltage :	DC 25.55V
Test Mode :	TX(5.8G) - 802.11ac40 (Low CH)		

Polar (H/V)	Frequency	Meter Reading	Factor	Emission Level	Limits	Margin	Remark
	(MHz)	(dBuV)	(dB)	(dBuV/m)	(dBuV/m)	(dB)	
V	44.2751	20.94	11.77	32.71	40.00	-7.29	QP
V	59.8588	23.76	6.00	29.76	40.00	-10.24	QP
V	80.0806	21.37	8.08	29.45	40.00	-10.55	QP
V	112.1303	24.03	11.72	35.75	43.50	-7.75	QP
V	188.4122	19.73	9.35	29.08	43.50	-14.42	QP
V	499.4245	11.46	20.59	32.05	46.00	-13.95	QP

Remark:

Absolute Level= ReadingLevel+ Factor, Margin= Absolute Level - Limit

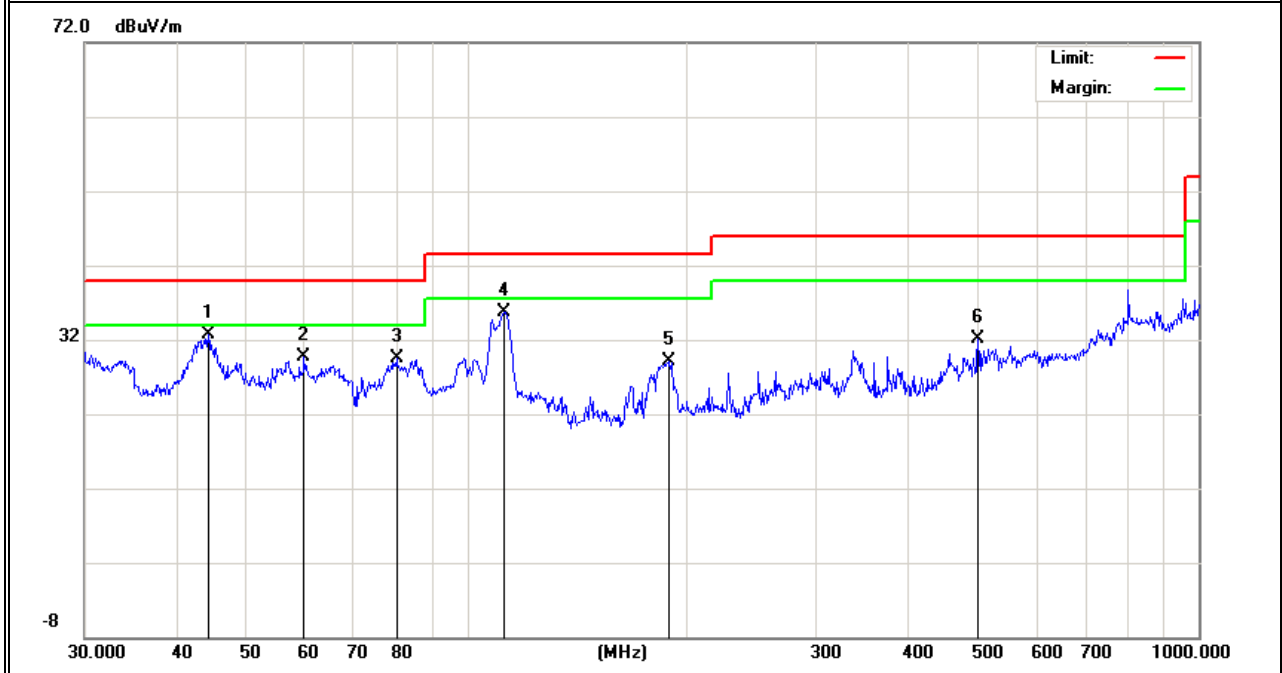

Polar (H/V)	Frequency	Meter Reading	Factor	Emission Level	Limits	Margin	Remark
	(MHz)	(dBuV)	(dB)	(dBuV/m)	(dBuV/m)	(dB)	
H	66.2660	17.50	6.07	23.57	40.00	-16.43	QP
H	80.6440	17.32	8.12	25.44	40.00	-14.56	QP
H	108.2667	18.61	11.17	29.78	43.50	-13.72	QP
H	249.4250	19.09	13.39	32.48	46.00	-13.52	QP
H	270.3747	18.79	14.30	33.09	46.00	-12.91	QP
H	552.8831	12.34	22.54	34.88	46.00	-11.12	QP

Remark:

Absolute Level= ReadingLevel+ Factor, Margin= Absolute Level - Limit

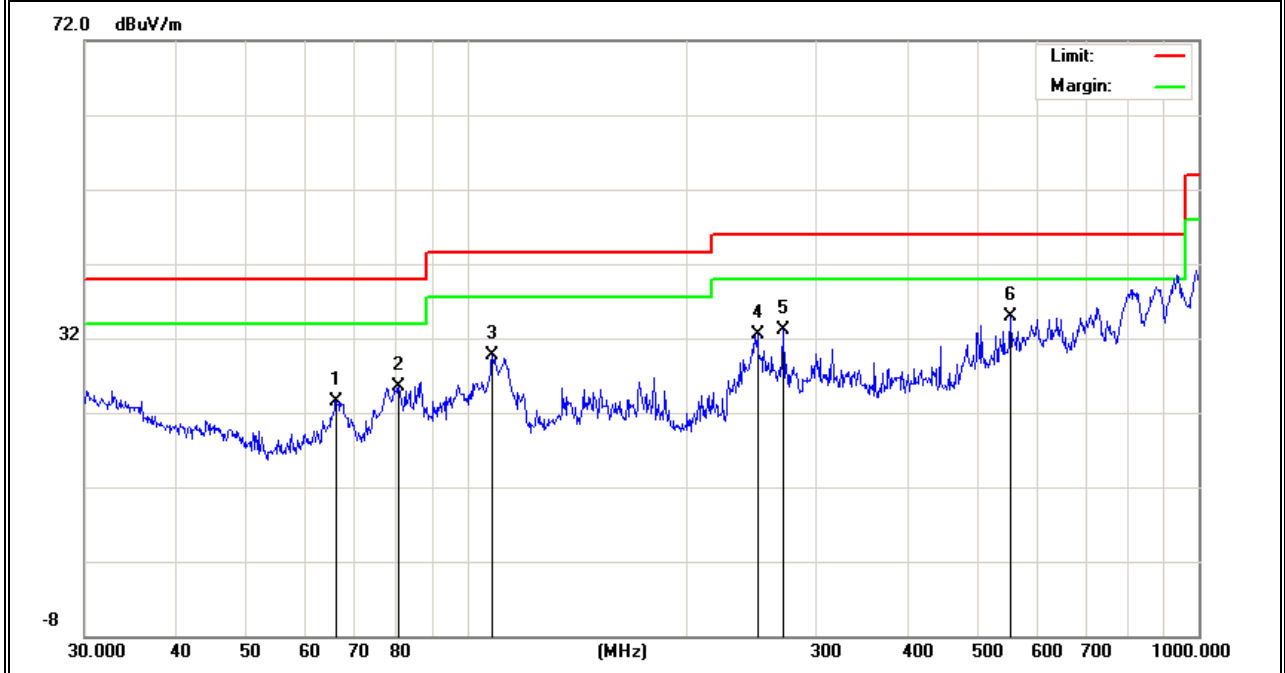

Note: All modes have been tested, just the the worst mode has been recorded in the report.

2.2.8 TEST RESULTS (1GHz-18GHz)

EUT :	HolaBot	Model Name. :	HL100
Temperature :	20 °C	Relative Humidity :	48%
Pressure :	1010 hPa	Test Voltage :	DC 25.55V
Test Mode :	TX(5.2G) - 802.11ac40 _5190~5230MHz		

Polar	Frequency	Meter Reading	Cable loss	Antenna Factor	Preamp Factor	Emission Level	Limits	Margin	Detector Type
(H/V)	(MHz)	(dBuV)	(dB)	dB/m	(dB)	(dBuV/m)	(dBuV/m)	(dB)	
Low Channel (5180 MHz)-Above 1G									
Vertical	3694.10	60.98	5.94	35.40	44.00	58.32	74.00	-15.68	Pk
Vertical	3694.10	41.80	5.94	35.40	44.00	39.14	54.00	-14.86	AV
Vertical	10360.15	57.95	8.46	39.75	44.50	61.66	68.20	-6.54	Pk
Vertical	15540.22	60.48	10.12	38.80	44.10	65.30	74.00	-8.70	Pk
Vertical	15540.22	39.16	10.12	38.80	42.70	45.38	54.00	-8.62	AV
Horizontal	3713.00	62.86	5.94	35.18	44.00	59.98	74.00	-14.02	Pk
Horizontal	3713.00	43.26	5.94	35.18	44.00	40.38	54.00	-13.62	AV
Horizontal	10360.47	58.35	8.46	38.71	44.50	61.02	68.20	-7.18	Pk
Horizontal	15540.38	56.93	10.12	38.38	44.10	61.33	74.00	-12.67	Pk
Horizontal	15540.38	40.39	10.12	38.38	44.10	44.79	54.00	-9.21	AV
middle Channel (5200 MHz)-Above 1G									
Vertical	3624.13	58.10	6.48	36.35	44.05	56.88	74.00	-17.12	Pk
Vertical	3624.13	42.52	6.48	36.35	44.05	41.30	54.00	-12.70	AV
Vertical	10400.09	59.42	8.47	37.88	44.51	61.26	68.20	-6.94	Pk
Vertical	15600.15	59.64	10.12	38.80	44.10	64.46	74.00	-9.54	Pk
Vertical	15600.15	39.09	10.12	38.80	42.70	45.31	54.00	-8.69	AV
Horizontal	4202.14	57.78	6.48	36.37	44.05	56.58	74.00	-17.42	Pk
Horizontal	4202.14	44.45	6.48	36.37	44.05	43.25	54.00	-10.75	AV
Horizontal	10400.14	60.92	8.47	38.64	44.50	63.53	68.20	-4.67	Pk
Horizontal	15600.51	59.50	10.12	38.38	44.10	63.90	74.00	-10.10	Pk
Horizontal	15600.51	40.71	10.12	38.38	44.10	45.11	54.00	-8.89	AV

High Channel (5240 MHz)-Above 1G									
Vertical	4597.70	63.44	7.10	37.24	43.50	64.28	74.00	-9.72	Pk
Vertical	4597.70	42.84	7.10	37.24	43.50	43.68	54.00	-10.32	AV
Vertical	10480.23	59.65	8.46	37.68	44.50	61.29	68.20	-6.91	Pk
Vertical	15720.15	61.03	10.12	38.80	44.10	65.85	74.00	-8.15	Pk
Vertical	15720.15	39.81	10.12	38.80	42.70	46.03	54.00	-7.97	AV
Horizontal	4589.26	60.72	7.10	37.24	43.50	61.56	74.00	-12.44	Pk
Horizontal	4589.26	40.99	7.10	37.24	43.50	41.83	54.00	-12.17	AV
Horizontal	10480.59	61.68	8.46	38.57	44.50	64.21	68.20	-3.99	Pk
Horizontal	15720.18	59.25	10.12	38.38	44.10	63.65	74.00	-10.35	Pk
Horizontal	15720.18	42.57	10.12	38.38	44.10	46.97	54.00	-7.03	AV

Note: "802.11ac40(5G)" mode is the worst mode. PK value is lower than the Average value limit, So average didn't record.

The amplitude of spurious emissions that are attenuated by more than 20dB below the permissible value has no need to be reported.

Emission level (dBuV/m) = 20 log Emission level (uV/m).

Corrected Reading: Antenna Factor + Cable Loss + Read Level - Preamp Factor = Level.

EUT :	HolaBot	Model Name. :	HL100
Temperature :	20 °C	Relative Humidity :	48%
Pressure :	1010 hPa	Test Voltage :	DC 25.55V
Test Mode :	TX(5.3G) - 802.11n40_5260~5320MHz		

Polar	Frequency	Meter Reading	Cable loss	Antenna Factor	Preamp Factor	Emission Level	Limits	Margin	Detector Type
(H/V)	(MHz)	(dBuV)	(dB)	dB/m	(dB)	(dBuV/m)	(dBuV/m)	(dB)	
Low Channel (5260 MHz)-Above 1G									
Vertical	4633.25	63.32	5.44	35.40	44.00	60.17	74.00	-13.83	Pk
Vertical	4633.25	44.80	5.74	35.40	44.00	41.94	54.00	-12.06	AV
Vertical	10520.12	60.75	8.26	39.75	44.50	64.26	68.20	-3.94	Pk
Vertical	15780.34	62.08	10.12	38.80	44.10	66.90	74.00	-7.10	Pk
Vertical	15780.34	40.95	9.62	38.80	42.70	46.67	54.00	-7.33	AV
Horizontal	4366.15	65.47	5.57	35.18	44.00	62.21	74.00	-11.79	Pk
Horizontal	4366.15	44.73	5.74	35.18	44.00	41.65	54.00	-12.35	AV
Horizontal	10520.26	60.54	8.38	38.71	44.50	63.13	68.20	-5.07	Pk
Horizontal	15780.34	58.69	9.88	38.38	44.10	62.85	74.00	-11.15	Pk
Horizontal	15780.34	41.69	9.94	38.38	44.10	45.91	54.00	-8.09	AV
middle Channel (5280 MHz)-Above 1G									
Vertical	4122.34	60.13	6.08	36.35	44.05	58.51	74.00	-15.49	Pk
Vertical	4122.34	43.76	6.39	36.35	44.05	42.45	54.00	-11.55	AV
Vertical	10560.19	60.87	8.28	37.88	44.51	62.52	68.20	-5.68	Pk
Vertical	15840.36	62.60	9.79	38.8	44.10	67.08	74.00	-6.92	Pk
Vertical	15840.36	40.75	9.70	38.8	42.70	46.55	54.00	-7.45	AV
Horizontal	3869.48	59.87	6.11	36.37	44.05	58.30	74.00	-15.70	Pk
Horizontal	3869.48	47.18	6.27	36.37	44.05	45.77	54.00	-8.23	AV
Horizontal	10560.74	63.35	8.33	38.64	44.50	65.82	68.20	-2.38	Pk
Horizontal	15840.37	61.37	9.99	38.38	44.10	65.64	74.00	-8.36	Pk
Horizontal	15840.37	41.99	9.81	38.38	44.10	46.08	54.00	-7.92	AV

High Channel (5320 MHz)-Above 1G									
Vertical	5366.52	63.55	6.96	37.24	43.50	64.25	74.00	-9.75	Pk
Vertical	5366.52	44.55	7.07	37.24	43.50	45.35	54.00	-8.65	AV
Vertical	10640.58	62.94	8.14	37.68	44.50	64.26	74.00	-9.74	Pk
Vertical	10640.58	42.66	8.35	37.68	44.50	44.19	54.00	-9.81	AV
Vertical	15960.41	61.74	10.11	38.8	44.10	66.54	74.00	-7.46	Pk
Vertical	15960.41	40.02	9.64	38.8	42.70	45.77	54.00	-8.23	AV
Horizontal	5436.59	62.52	7.05	37.24	43.50	63.31	74.00	-10.69	Pk
Horizontal	5436.59	42.79	7.05	37.24	43.50	43.58	54.00	-10.42	AV
Horizontal	10640.24	61.72	8.20	38.57	44.50	63.99	74.00	-10.01	Pk
Horizontal	10640.24	44.47	8.03	38.57	44.50	46.57	54.00	-7.43	AV
Horizontal	15960.88	61.44	9.81	38.38	44.10	65.54	74.00	-8.46	Pk
Horizontal	15960.88	44.47	9.96	38.38	44.10	48.71	54.00	-5.29	AV

Note: ANT 1 802.11n40(5G) mode is the worst mode. PK value is lower than the Average value limit, So average didn't record.

The amplitude of spurious emissions that are attenuated by more than 20dB below the permissible value has no need to be reported.

Emission level (dBuV/m) = 20 log Emission level (uV/m).

Corrected Reading: Antenna Factor + Cable Loss + Read Level - Preamp Factor = Level.

EUT :	HolaBot	Model Name. :	HL100
Temperature :	20 °C	Relative Humidity :	48%
Pressure :	1010 hPa	Test Voltage :	DC 25.55V
Test Mode :	TX(5.6G) - 802.11n20_5500~5700MHz		

Polar	Frequency	Meter Reading	Cable loss	Antenna Factor	Preamp Factor	Emission Level	Limits	Margin	Detector Type
(H/V)	(MHz)	(dBuV)	(dB)	dB/m	(dB)	(dBuV/m)	(dBuV/m)	(dB)	
Low Channel (5500 MHz)-Above 1G									
Vertical	5433.02	64.29	5.61	35.40	44.00	61.30	74.00	-12.70	Pk
Vertical	5433.02	45.12	5.76	35.40	44.00	42.28	54.00	-11.72	AV
Vertical	11000.25	60.06	8.24	39.75	44.50	63.55	74.00	-10.45	Pk
Vertical	11000.25	41.92	8.35	39.75	44.50	45.52	54.00	-8.48	AV
Vertical	16500.41	51.05	10.05	38.80	44.10	55.80	68.20	-12.40	Pk
Horizontal	5126.47	60.58	5.78	35.18	44.00	57.54	74.00	-16.46	Pk
Horizontal	5126.47	42.53	5.66	35.18	44.00	39.38	54.00	-14.62	AV
Horizontal	11000.32	58.26	8.22	38.71	44.50	60.69	74.00	-13.31	Pk
Horizontal	11000.32	41.62	8.14	38.71	44.50	43.97	54.00	-10.03	AV
Horizontal	16500.47	61.89	10.04	38.38	44.10	66.21	68.20	-1.99	Pk
Middle Channel (5600 MHz)-Above 1G									
Vertical	4933.25	62.72	6.29	36.35	44.05	61.30	74.00	-12.70	Pk
Vertical	4933.25	44.28	6.24	36.35	44.05	42.82	54.00	-11.18	AV
Vertical	11200.58	59.93	8.24	37.88	44.51	61.55	74.00	-12.45	Pk
Vertical	11200.58	44.56	8.13	37.88	44.51	46.05	54.00	-7.95	AV
Vertical	16800.45	59.96	9.71	38.80	44.10	64.37	68.20	-3.83	Pk
Horizontal	4766.32	60.51	6.44	36.37	44.05	59.27	74.00	-14.73	Pk
Horizontal	4766.32	43.45	6.13	36.37	44.05	41.91	54.00	-12.09	AV
Horizontal	11200.45	60.90	8.31	38.64	44.50	63.35	74.00	-10.65	Pk
Horizontal	11200.45	43.14	8.04	38.64	44.50	45.32	54.00	-8.68	AV
Horizontal	16800.33	62.22	10.09	38.38	44.10	66.59	68.20	-1.61	Pk

High Channel (5700 MHz)-Above 1G									
Vertical	5647.33	62.05	6.79	37.24	43.50	62.58	68.20	-5.62	Pk
Vertical	11400.29	61.30	8.10	37.68	44.50	62.58	74.00	-11.42	Pk
Vertical	11400.29	42.65	8.23	37.68	44.50	44.06	54.00	-9.94	AV
Vertical	17100.54	62.11	9.70	38.80	44.10	66.52	68.20	-1.68	Pk
Horizontal	5433.26	60.91	6.74	37.24	43.50	61.39	74.00	-12.61	Pk
Horizontal	5433.26	42.78	6.74	37.24	43.50	43.26	54.00	-10.74	AV
Horizontal	11400.43	60.40	8.25	38.57	44.50	62.72	74.00	-11.28	Pk
Horizontal	11400.43	42.31	8.35	38.57	44.50	44.73	54.00	-9.27	AV
Horizontal	17100.58	59.50	9.70	38.38	44.10	63.48	68.20	-4.72	Pk

Note: "802.11n20(5G)" mode is the worst mode. PK value is lower than the Average value limit, So average didn't record.

The amplitude of spurious emissions that are attenuated by more than 20dB below the permissible value has no need to be reported.

Emission level (dBuV/m) = 20 log Emission level (uV/m).

Corrected Reading: Antenna Factor + Cable Loss + Read Level - Preamp Factor = Level.

EUT :	HolaBot	Model Name. :	HL100
Temperature :	20 °C	Relative Humidity :	48%
Pressure :	1010 hPa	Test Voltage :	DC 25.55V
Test Mode :	TX (5.8G) -- 802.11ac40_5745~5825MHz		

Polar	Frequency	Meter Reading	Cable loss	Antenna Factor	Preamp Factor	Emission Level	Limits	Margin	Detector Type
(H/V)	(MHz)	(dBuV)	(dB)	dB/m	(dB)	(dBuV/m)	(dBuV/m)	(dB)	
Low Channel (5745 MHz)-Above 1G									
Vertical	5122.51	64.07	5.94	35.40	44.00	61.41	74.00	-12.59	Pk
Vertical	5122.51	45.78	5.94	35.40	44.00	43.12	54.00	-10.88	AV
Vertical	11490.60	60.40	8.46	39.75	44.50	64.11	74.00	-9.89	Pk
Vertical	11490.60	43.65	8.46	39.75	44.50	47.36	54.00	-6.64	AV
Vertical	17235.65	52.38	10.12	38.80	44.10	57.20	68.20	-11.00	Pk
Horizontal	5166.60	59.88	5.94	35.18	44.00	57.00	68.20	-11.20	Pk
Horizontal	11490.47	59.33	8.46	38.71	44.50	62.00	74.00	-12.00	Pk
Horizontal	11490.47	42.73	8.46	38.71	44.50	45.40	54.00	-8.60	AV
Horizontal	17235.47	61.86	10.12	38.38	44.10	66.26	68.20	-1.94	Pk
middle Channel (5785 MHz)-Above 1G									
Vertical	5433.40	62.99	6.48	36.35	44.05	61.77	74.00	-12.23	Pk
Vertical	5433.40	43.34	6.48	36.35	44.05	42.12	54.00	-11.88	AV
Vertical	11570.41	60.85	8.47	37.88	44.51	62.69	74.00	-11.31	Pk
Vertical	11570.41	43.41	8.47	37.88	44.51	45.25	54.00	-8.75	AV
Vertical	17355.84	61.74	10.12	38.80	44.10	66.56	68.20	-1.64	Pk
Horizontal	4866.60	60.30	6.48	36.37	44.05	59.10	74.00	-14.90	Pk
Horizontal	4866.60	43.15	6.48	36.37	44.05	41.95	54.00	-12.05	AV
Horizontal	11570.28	63.04	8.47	38.64	44.50	65.65	74.00	-8.35	Pk
Horizontal	11570.28	44.28	8.47	38.64	44.50	46.89	54.00	-7.11	AV
Horizontal	17355.49	62.85	10.12	38.38	44.10	67.25	68.20	-0.95	Pk

High Channel (5825 MHz)-Above 1G									
Vertical	5244.48	63.25	7.10	37.24	43.50	64.09	68.20	-4.11	Pk
Vertical	11652.42	62.96	8.46	37.68	44.50	64.60	74.00	-9.40	Pk
Vertical	11652.42	44.35	8.46	37.68	44.50	45.99	54.00	-8.01	AV
Vertical	17473.74	61.82	10.12	38.80	44.10	66.64	68.20	-1.56	Pk
Horizontal	5285.29	61.48	7.10	37.24	43.50	62.32	68.20	-5.88	Pk
Horizontal	11652.67	61.53	8.46	38.57	44.50	64.06	74.00	-9.94	Pk
Horizontal	11652.67	43.08	8.46	38.57	44.50	45.61	54.00	-8.39	AV
Horizontal	17474.68	59.44	10.12	38.38	44.10	63.84	68.20	-4.36	Pk

Note:"802.11ac40(5G)" mode is the worst mode. PK value is lower than the Average value limit, So average didn't record.

The amplitude of spurious emissions that are attenuated by more than 20dB below the permissible value has no need to be reported.

Emission level (dBuV/m) = 20 log Emission level (uV/m).

Corrected Reading: Antenna Factor + Cable Loss + Read Level - Preamp Factor = Level.

2.2.10 TEST RESULTS (18GHz-40GHz)

EUT :	HolaBot	Model Name. :	HL100
Temperature :	20 °C	Relative Humidity :	48%
Pressure :	1010 hPa	Test Voltage :	DC 25.55V
Test Mode :	TX (5.2G)-802.11ac40 5190MHz~5230MHz; TX (5.3G)-802.11n40 5260MHz~5320MHz; TX (5.6G)-802.11n20 5500MHz~5700MHz; TX (5.8G)-802.11ac40 5745MHz~5825MHz		

All the modulation modes have been tested, and the worst result was report as below:
Low Channel (5190 MHz)-Above 1G

Horizontal

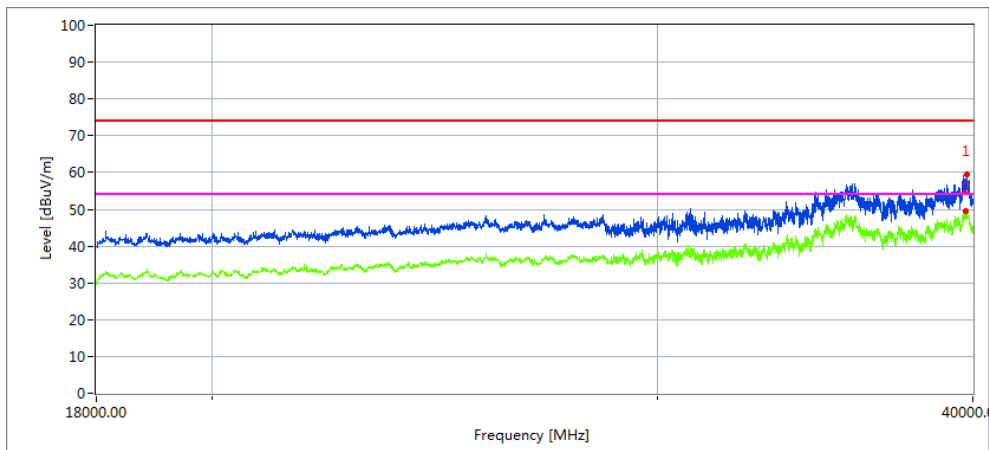

Frequency	Meter Reading	Cable loss	Antenna Factor	Preamp Factor	Emission Level	Limits	Margin	Remark
39769.27	38.77	20.09	44.07	43.48	59.45	68.2	8.75	Peak
39767.19	27.07	20.09	44.04	43.48	47.72	54	6.28	AVG

Vertical

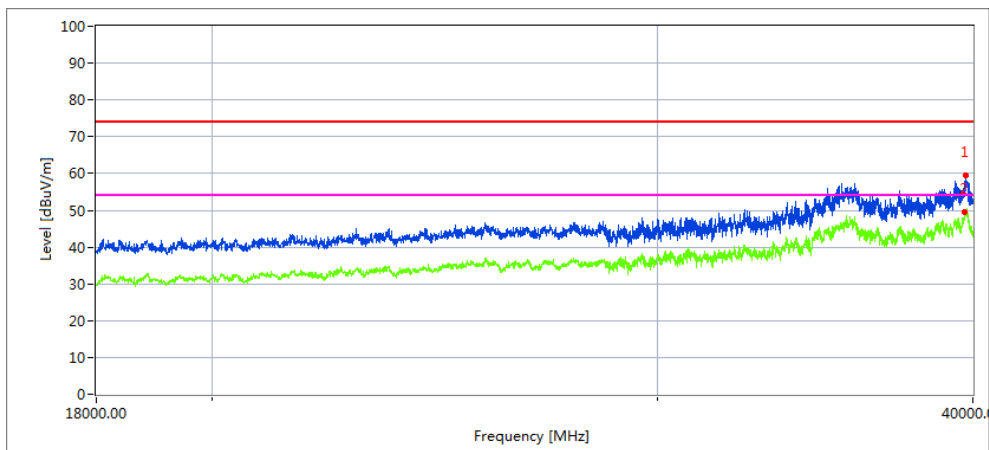

Frequency	Meter Reading	Cable loss	Antenna Factor	Preamp Factor	Emission Level	Limits	Margin	Remark
39769.666	35.77	20.09	44.07	43.48	56.45	68.2	11.75	Peak
39769.485	27.07	20.09	44.04	43.48	47.72	54	6.28	AVG

High Channel (5230 MHz)-Above 1G

Horizontal

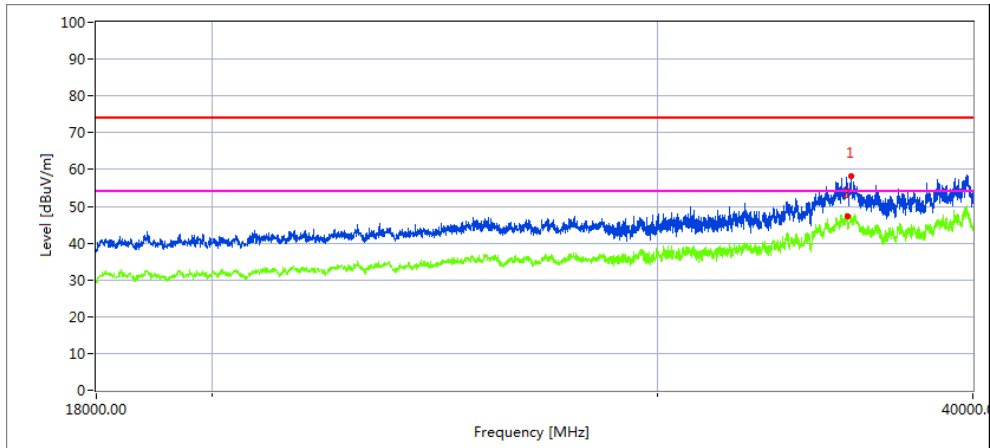

Frequency	Meter Reading	Cable loss	Antenna Factor	Preamp Factor	Emission Level	Limits	Margin	Remark
35628.25	40.54	19.11	42.73	44.61	57.77	68.2	10.43	Peak
35596.866	31.11	19.11	42.73	44.61	48.34	54	5.66	AVG

Vertical

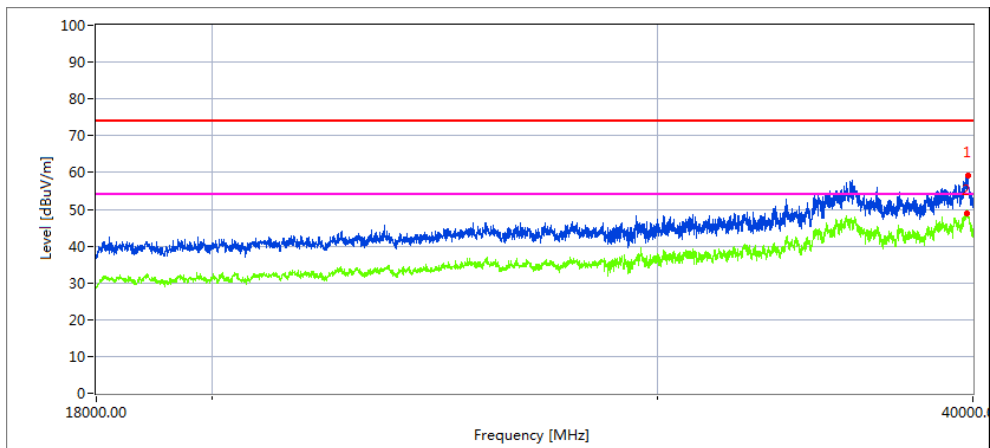

Frequency	Meter Reading	Cable loss	Antenna Factor	Preamp Factor	Emission Level	Limits	Margin	Remark
39769.596	36.87	20.09	44.07	43.48	57.55	68.2	10.65	Peak
39769.596	25.1	20.09	44.04	43.48	45.75	54	8.25	AVG

Note:802.11ac40 MIMO mode is the worst mode.

Low Channel (5260 MHz)-Above 1G

Horizontal

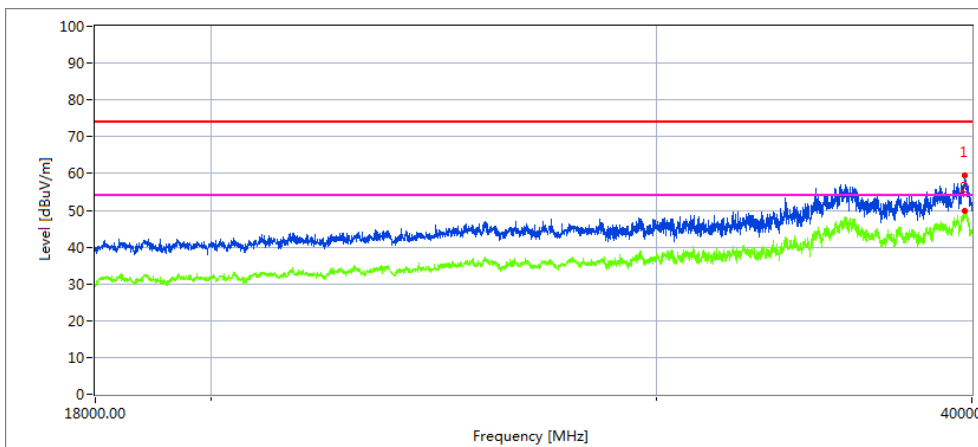

Frequency	Meter Reading	Cable loss	Antenna Factor	Preamp Factor	Emission Level	Limits	Margin	Remark
39176.35	38.4	19.98	43.84	44.62	57.6	68.2	10.6	Peak
39176.35	29.6	19.98	43.84	44.62	48.8	54	5.2	AVG

Vertical

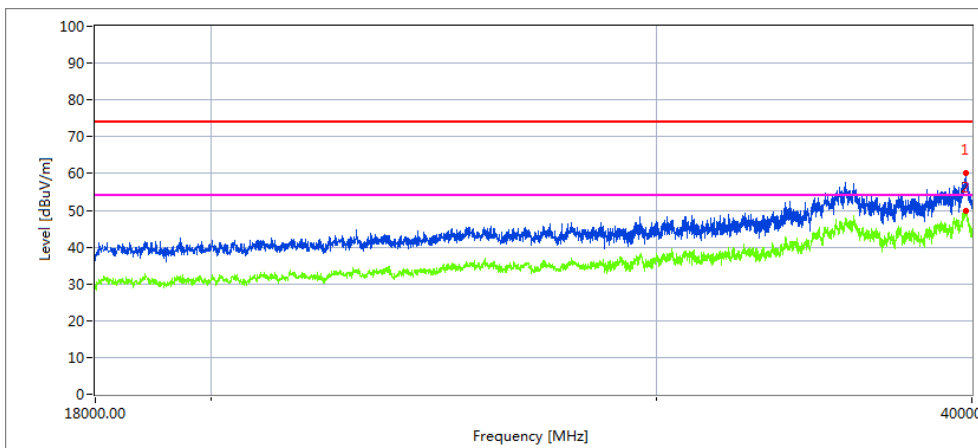

Frequency	Meter Reading	Cable loss	Antenna Factor	Preamp Factor	Emission Level	Limits	Margin	Remark
39385.96	38.68	20.01	44.06	42.69	60.06	68.2	8.14	Peak
39385.96	28.44	20.01	44.06	42.69	49.82	54	4.18	AVG

High Channel (5320 MHz)-Above 1G

Horizontal

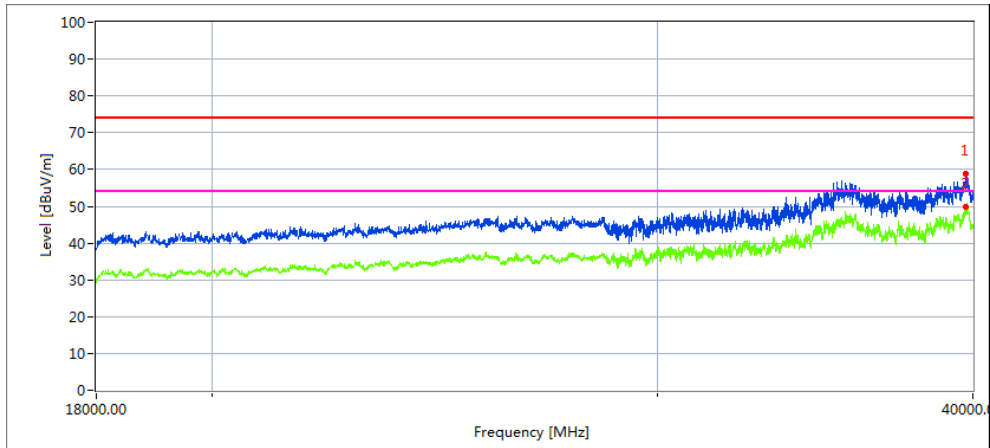

Frequency	Meter Reading	Cable loss	Antenna Factor	Preamp Factor	Emission Level	Limits	Margin	Remark
39177.06	38.6	19.98	43.84	44.62	57.8	68.2	10.4	Peak
39177.06	30.32	19.98	43.84	44.62	49.52	54	4.48	AVG

Vertical

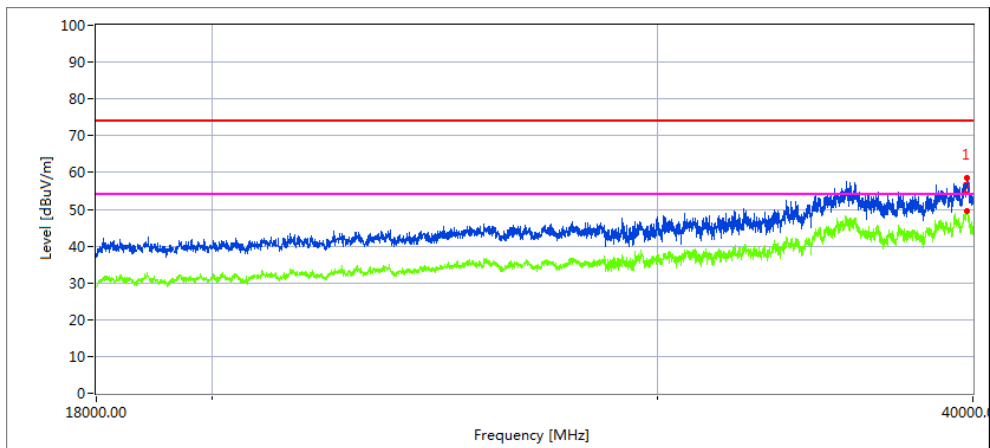

Frequency	Meter Reading	Cable loss	Antenna Factor	Preamp Factor	Emission Level	Limits	Margin	Remark
39369.294	35.48	20.01	44.06	42.69	56.86	68.2	11.34	Peak
39369.294	27.14	20.01	44.06	42.69	48.52	54	5.48	AVG

Note:802.11n20 MIMO mode is the worst mode.

Low Channel (5500 MHz)-Above 1G

Horizontal

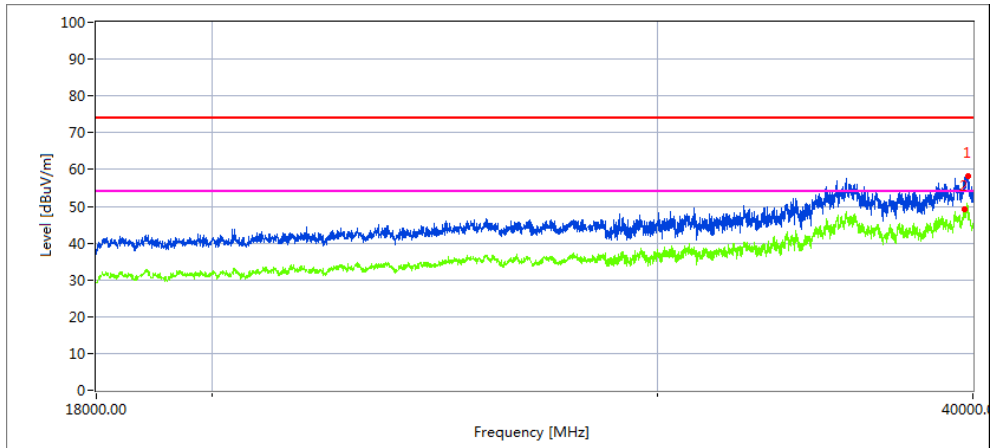

Frequency	Meter Reading	Cable loss	Antenna Factor	Preamp Factor	Emission Level	Limits	Margin	Remark
39696.557	36.87	20.09	44.07	43.48	57.55	68.2	10.65	Peak
39653.301	28.87	20.07	44.06	43.48	49.52	54	4.48	AVG

Vertical

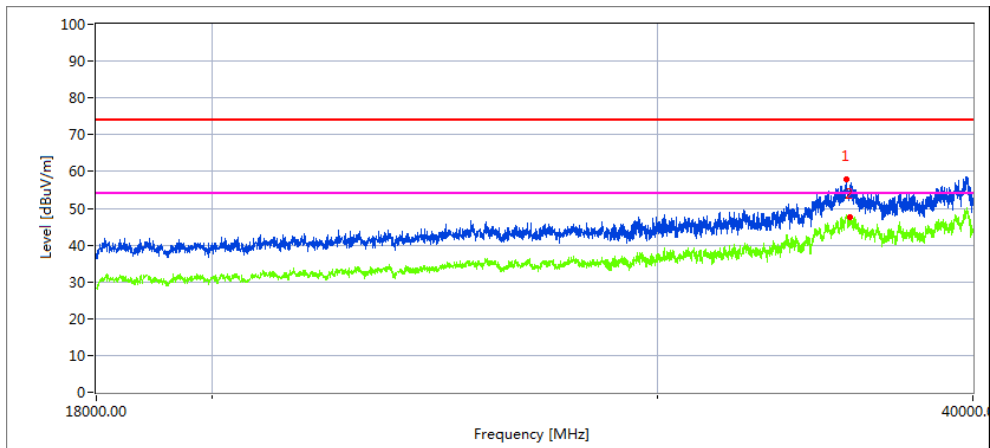

Frequency	Meter Reading	Cable loss	Antenna Factor	Preamp Factor	Emission Level	Limits	Margin	Remark
36575.761	36.95	19.16	42.61	41.56	57.16	68.2	11.04	Peak
36575.761	27.05	19.16	42.61	41.56	47.26	54	6.74	AVG

High Channel (5700 MHz)-Above 1G

Horizontal

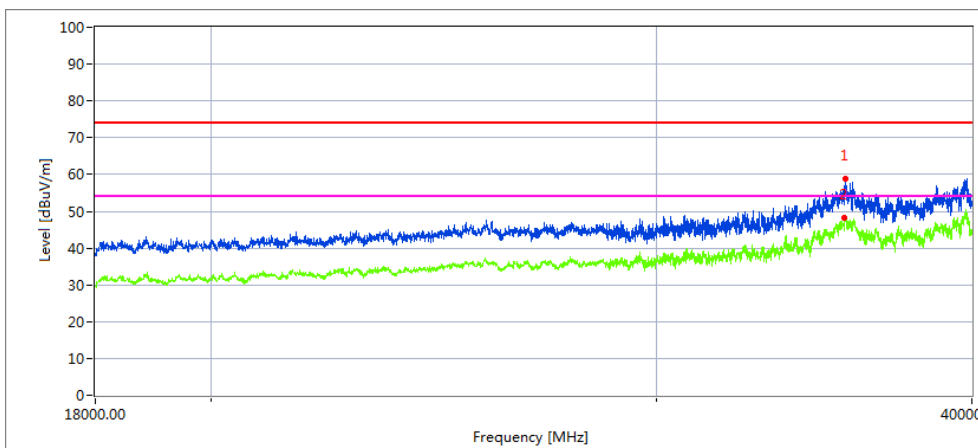

Frequency	Meter Reading	Cable loss	Antenna Factor	Preamp Factor	Emission Level	Limits	Margin	Remark
35794.62	37.28	19.17	42.63	42.74	56.34	68.2	11.86	Peak
35763.538	28.65	19.14	42.61	42.71	47.69	54	6.31	AVG

Vertical

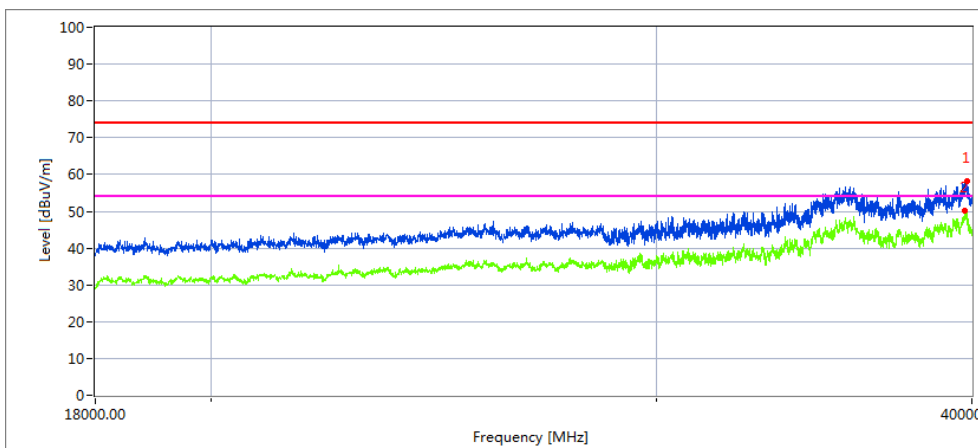

Frequency	Meter Reading	Cable loss	Antenna Factor	Preamp Factor	Emission Level	Limits	Margin	Remark
39816.853	38.29	20.09	42.63	43.48	57.53	68.2	10.67	Peak
39804.138	30.36	20.09	42.61	43.48	49.58	54	4.42	AVG

Note:802.11n20 MIMO mode is the worst mode.

Low Channel (5745 MHz)-Above 1G

Horizontal

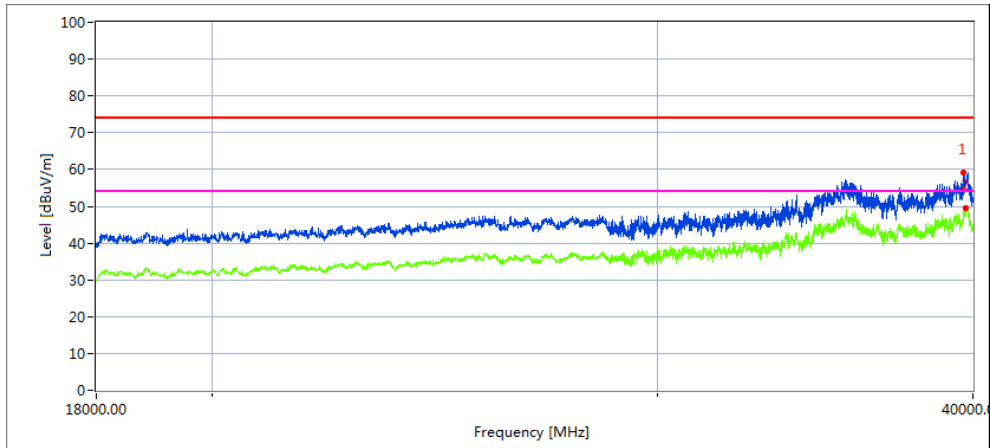

Frequency	Meter Reading	Cable loss	Antenna Factor	Preamp Factor	Emission Level	Limits	Margin	Remark
39670.104	38.08	20.09	44.16	43.48	58.85	68.2	9.35	Peak
39670.104	29.11	20.09	44.16	43.48	49.88	54	4.12	AVG

Vertical

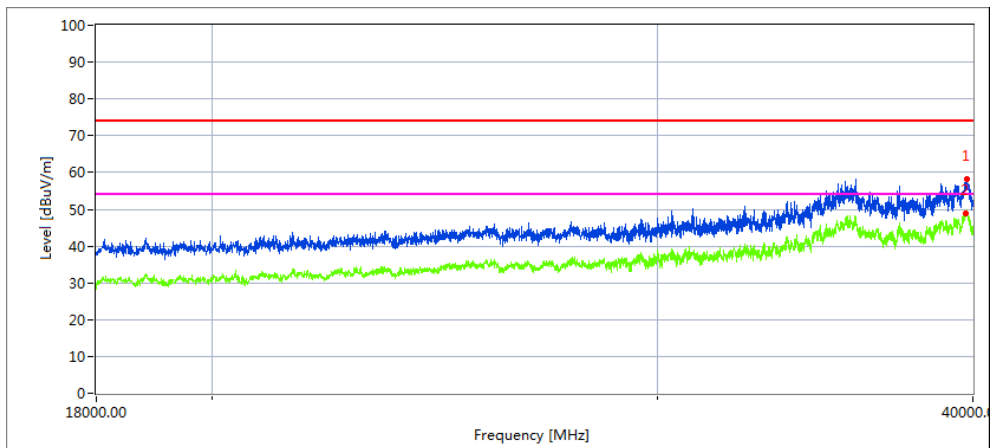

Frequency	Meter Reading	Cable loss	Antenna Factor	Preamp Factor	Emission Level	Limits	Margin	Remark
39731.462	37.17	20.06	44.07	43.21	58.09	68.2	10.11	Peak
39731.462	28.14	20.06	44.07	43.21	49.06	54	4.94	AVG

High Channel (5825 MHz)-Above 1G

Horizontal

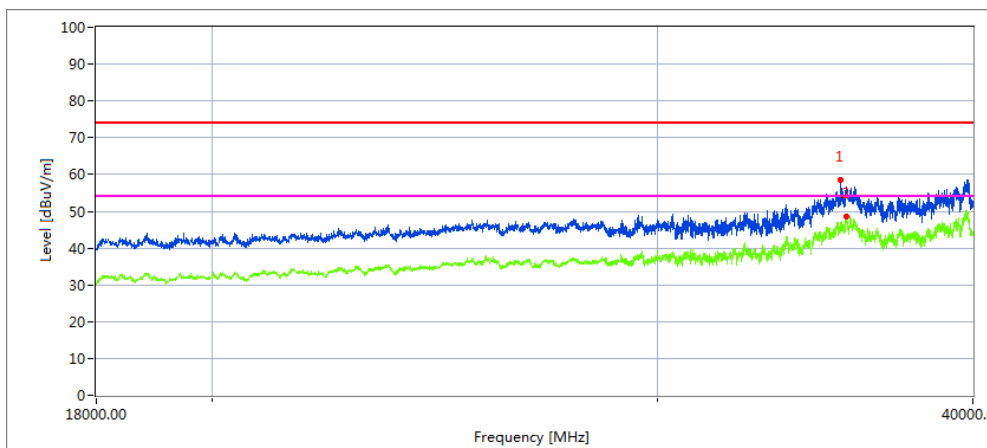

Frequency	Meter Reading	Cable loss	Antenna Factor	Preamp Factor	Emission Level	Limits	Margin	Remark
35628.414	39.13	19.11	42.63	43.48	57.39	68.2	10.81	Peak
35636.038	29.68	19.12	42.63	43.48	47.95	54	6.05	AVG

Vertical

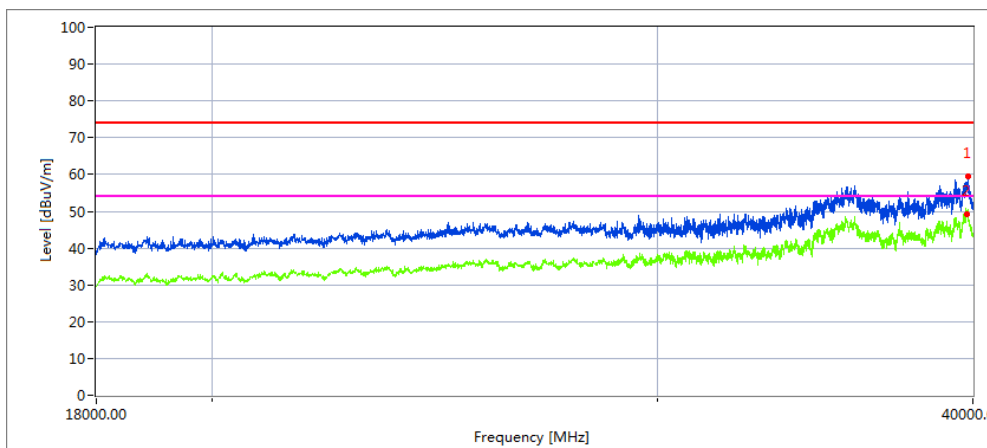

Frequency	Meter Reading	Cable loss	Antenna Factor	Preamp Factor	Emission Level	Limits	Margin	Remark
39821.883	38.02	20.1	44.1	43.22	59	68.2	9.2	Peak
39821.883	28.9	20.1	44.1	43.22	49.88	54	4.12	AVG

Note: 802.11n20 MIMO mode is the worst mode.

2.2.10 Spurious Emission in Restricted Band 4.5GHz~5.150 GHz& 5.350GHz~5460GHz

EUT :	HolaBot	Model Name. :	HolaBot
Temperature :	20 °C	Relative Humidity :	48%
Pressure :	1010 hPa	Test Voltage :	DC 25.55V
Test Mode :	TX (5.2G)-802.11ac40 5150MHz~5250MHz,		

All the modulation modes have been tested, The report just record the worst data mode.

Frequency (MHz)	Meter Reading (dBμV)	Cable Loss (dB)	Antenna Factor dB/m	Preamp Factor (dB)	Emission Level (dBμV/m)	Limits (dBμV/m)	Margin (dB)	Detector Type	Comment
5.2G WIFI-802.11a Mode									
4500	52.9	5.2	35.6	44.2	49.5	74	-24.5	Pk	Horizontal
4500	43.9	5.2	35.6	44.2	40.5	54	-13.5	AV	Horizontal
4500	55.85	5.2	35.6	44.2	52.45	74	-21.55	Pk	Horizontal
4500	42.87	5.2	35.6	44.2	39.47	54	-14.53	AV	Horizontal
5150	66.86	5.36	35.66	44.22	63.66	74	-10.34	Pk	Horizontal
5150	45.69	5.36	35.66	44.22	42.49	54	-11.51	AV	Horizontal
5150	53.53	5.36	35.66	44.22	50.33	74	-23.67	Pk	Vertical
5150	39.25	5.36	35.66	44.22	36.05	54	-17.95	AV	Vertical
5350	62.19	5.68	35.68	44.22	59.33	74	-14.67	Pk	Vertical
5350	43.82	5.68	35.68	44.22	40.96	54	-13.04	AV	Vertical
5350	57.57	5.68	35.68	44.22	54.71	74	-19.29	Pk	Horizontal
5350	42.28	5.68	35.68	44.22	39.42	54	-14.58	AV	Horizontal

Note: (1) Emission Level= Antenna Factor + Cable Loss + Read Level - Preamp Factor
 (2) "802.11ac40" mode is the worst mode. When PK value is lower than the Average value limit, average don't record.

EUT :	HolaBot	Model Name. :	HolaBot
Temperature :	20 °C	Relative Humidity :	48%
Pressure :	1010 hPa	Test Voltage :	DC 25.55V
Test Mode :	TX (5.3G)-802.11n40 5250MHz~5350MHz,		

All the modulation modes have been tested, The report just record the worst data mode.

Polar	Frequency	Meter Reading	Cable loss	Antenna Factor	Preamp Factor	Emission Level	Limits	Margin	Detector Type
(H/V)	(MHz)	(dBuV)	(dB)	dB/m	(dB)	(dBuV/m)	(dBuV/m)	(dB)	
High Channel (5320 MHz)-Above 1G									
Vertical	5350.00	65.41	6.96	37.24	43.50	66.11	74.00	-7.89	Pk
Vertical	5350.00	43.40	7.07	37.24	43.50	44.21	54.00	-9.79	AV
Horizontal	5350.00	66.10	7.05	37.24	43.50	66.89	74.00	-7.11	Pk
Horizontal	5350.00	45.71	7.05	37.24	43.50	46.50	54.00	-7.50	AV

Note: (1) Emission Level= Antenna Factor + Cable Loss + Read Level - Preamp Factor

(2) "802.11n40 " mode is the worst mode. When PK value is lower than the Average value limit, average don't record.

EUT :	HolaBot	Model Name. :	HolaBot
Temperature :	20 °C	Relative Humidity :	48%
Pressure :	1010 hPa	Test Voltage :	DC 25.55V
Test Mode :	TX (5.6G)-802.11n20 5470MHz~5725MHz,		

All the modulation modes have been tested, The report just record the worst data mode.

Polar	Frequency	Meter Reading	Cable loss	Antenna Factor	Preamp Factor	Emission Level	Limits	Margin	Detector Type
(H/V)	(MHz)	(dBuV)	(dB)	dB/m	(dB)	(dBuV/m)	(dBuV/m)	(dB)	
Low Channel (5500 MHz)-Above 1G									
Vertical	5460.00	62.41	5.61	35.40	44.00	59.42	74.00	-14.58	Pk
Vertical	5460.00	45.38	5.76	35.40	44.00	42.54	54.00	-11.46	AV
Horizontal	5460.00	57.30	5.78	35.18	44.00	54.26	74.00	-19.74	Pk
Horizontal	5460.00	42.41	5.66	35.18	44.00	39.25	54.00	-14.75	AV

Note: (1) Emission Level= Antenna Factor + Cable Loss + Read Level - Preamp Factor

(2) "802.11n20 " mode is the worst mode. When PK value is lower than the Average value limit, average don't record.

3. POWER SPECTRAL DENSITY TEST

3.1 APPLIED PROCEDURES / LIMIT

According to FCC §15.407(a)

For the band 5.15-5.25 GHz,

(i) For an outdoor access point operating in the band 5.15-5.25 GHz, the maximum power spectral density shall not exceed 17 dBm in any 1 megahertz band. If transmitting antennas of directional gain greater than 6 dBi are used, both the maximum conducted output power and the maximum power spectral density shall be reduced by the amount in dB that the directional gain of the antenna exceeds 6 dBi. The maximum e.i.r.p. at any elevation angle above 30 degrees as measured from the horizon must not exceed 125 mW (21 dBm).

(ii) For an indoor access point operating in the band 5.15-5.25 GHz, the maximum power spectral density shall not exceed 17 dBm in any 1 megahertz band. If transmitting antennas of directional gain greater than 6 dBi are used, both the maximum conducted output power and the maximum power spectral density shall be reduced by the amount in dB that the directional gain of the antenna exceeds 6 dBi.

(iii) For fixed point-to-point access points operating in the band 5.15-5.25 GHz, the maximum power spectral density shall not exceed 17 dBm in any 1 megahertz band. Fixed point-to-point U-NII devices may employ antennas with directional gain up to 23 dBi without any corresponding reduction in the maximum conducted output power or maximum power spectral density. For fixed point-to-point transmitters that employ a directional antenna gain greater than 23 dBi, a 1 dB reduction in maximum conducted output power and maximum power spectral density is required for each 1 dB of antenna gain in excess of 23 dBi. Fixed, point-to-point operations exclude the use of point-to-multipoint systems, omnidirectional applications, and multiple collocated transmitters transmitting the same information. The operator of the U-NII device, or if the equipment is professionally installed, the installer, is responsible for ensuring that systems employing high gain directional antennas are used exclusively for fixed, point-to-point operations.

(iv) For client devices in the 5.15-5.25 GHz band, the maximum power spectral density shall not exceed 11 dBm in any 1 megahertz band. If transmitting antennas of directional gain greater than 6 dBi are used, both the maximum conducted output power and the maximum power spectral density shall be reduced by the amount in dB that the directional gain of the antenna exceeds 6 dBi.

For the 5.25-5.35 GHz and 5.47-5.725 GHz bands, the maximum conducted output power over the frequency bands of operation shall not exceed the lesser of 250 mW or $11 \text{ dBm} + 10 \log B$, where B is the 26 dB emission bandwidth in megahertz. In addition, the maximum power spectral density shall not exceed 11 dBm in any 1 megahertz band. If transmitting antennas of directional gain greater than 6 dBi are used, both the maximum conducted output power and the maximum power spectral density shall be reduced by the amount in dB that the directional gain of the antenna exceeds 6 dBi.

For the band 5.725-5.85 GHz

(3) For the band 5.725-5.85 GHz, the maximum power spectral density shall not exceed 30 dBm in any 500-kHz band. If transmitting antennas of directional gain greater than 6 dBi are used, both the maximum conducted output power and the maximum power spectral density shall be reduced by the amount in dB that the directional gain of the antenna exceeds 6 dBi.

3.2 TEST PROCEDURE

For devices operating in the bands 5.15-5.25 GHz, 5.25-5.35 GHz, and 5.47-5.725 GHz, the above procedures make use of 1 MHz RBW to satisfy directly the 1 MHz reference bandwidth specified in § 15.407(a)(5). For devices operating in the band 5.725-5.85 GHz, the rules specify a measurement bandwidth of 500 kHz. Many spectrum analyzers do not have 500 kHz RBW, thus a narrower RBW may need to be used. The rules permit the use of a RBWs less than 1 MHz, or 500 kHz, “provided that the measured power is integrated over the full reference bandwidth” to show the total power over the specified measurement bandwidth (i.e., 1 MHz, or 500 kHz). If measurements are performed using a reduced resolution bandwidth (< 1 MHz, or < 500 kHz) and integrated over 1 MHz, or 500 KHz bandwidth, the following adjustments to the procedures apply:

- a) Set $RBW \geq 1/T$, where T is defined in section II.B.I.a).
- b) Set $VBW \geq 3 RBW$.
- c) If measurement bandwidth of Maximum PSD is specified in 500 kHz, add $10\log(500\text{kHz}/RBW)$ to the measured result, whereas $RBW (< 500 \text{ KHz})$ is the reduced resolution bandwidth of the spectrum analyzer set during measurement.
- d) If measurement bandwidth of Maximum PSD is specified in 1 MHz, add $10\log(1\text{MHz}/RBW)$ to the measured result, whereas $RBW (< 1 \text{ MHz})$ is the reduced resolution bandwidth of spectrum analyzer set during measurement.
- e) Care must be taken to ensure that the measurements are performed during a period of continuous transmission or are corrected upward for duty cycle.

Note: As a practical matter, it is recommended to use reduced RBW of 100 KHz for the sections 5.c) and 5.d) above, since $RBW=100 \text{ KHz}$ is available on nearly all spectrum analyzers.

3.3 DEVIATION FROM STANDARD

No deviation.

3.4 TEST SETUP

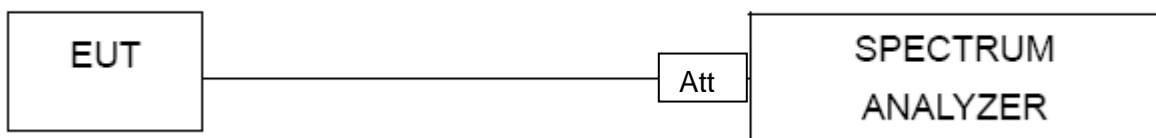

3.5 EUT OPERATION CONDITIONS

The EUT tested system was configured as the statements of 2.1 Unless otherwise a special operating condition is specified in the follows during the testing.

3.6 TEST RESULTS

EUT :	HolaBot	Model Name :	HL100
Temperature :	26 °C	Relative Humidity :	54%
Pressure :	1015 hPa	Test Voltage :	DC 25.55V
Test Mode :	TX Frequency Band 1 (5150-5250MHz), Band 2A (5250-5350MHz), Band 2C (5470-5725MHz), Band 3 (5745-5825MHz)		

Note: Band1&Band2A&Band2C For 802.11n/ac 5GHz has MIMO mode.Direction gain=7.01dbi
 7.01dbi > 6.0dbi so power limit is limit= 11-(7.01-6)=9.99 in dBm
 Band3 For 802.11n/ac 5GHz has MIMO mode.Direction gain=7.01dbi
 7.01dbi > 6.0dbi so power limit is limit=30-(7.01-6)=28.99 in dBm

Test data reference attachment.

4. 26DB & 99% EMISSION BANDWIDTH

4.1 APPLIED PROCEDURES / LIMIT

The maximum power spectral density is measured as a conducted emission by direct connection of a calibrated test instrument to the equipment under test. If the device cannot be connected directly, alternative techniques acceptable to the Commission may be used. Measurements in the 5.725-5.85 GHz band are made over a reference bandwidth of 500 kHz or the 26 dB emission bandwidth of the device, whichever is less. Measurements in the 5.15-5.25 GHz, 5.25-5.35 GHz, and the 5.47-5.725 GHz bands are made over a bandwidth of 1 MHz or the 26 dB emission bandwidth of the device, whichever is less. A narrower resolution bandwidth can be used, provided that the measured power is integrated over the full reference bandwidth.

4.2 TEST PROCEDURE

- a) Set RBW = approximately 1% of the emission bandwidth.
- b) Set the VBW > RBW.
- c) Detector = Peak.
- d) Trace mode = max hold.
- e) Measure the maximum width of the emission that is 26 dB down from the maximum of the emission. Compare this with the RBW setting of the analyzer. Readjust RBW and repeat measurement as needed until the RBW/EBW ratio is approximately 1%.

The following procedure shall be used for measuring (99 %) power bandwidth:

- 1. Set center frequency to the nominal EUT channel center frequency.
- 2. Set span = 1.5 times to 5.0 times the OBW.
- 3. Set RBW = 1 % to 5 % of the OBW
- 4. Set VBW ≥ 3 · RBW
- 5. Video averaging is not permitted. Where practical, a sample detection and single sweep mode shall be used. Otherwise, peak detection and max hold mode (until the trace stabilizes) shall be used.
- 6. Use the 99 % power bandwidth function of the instrument (if available).
- 7. If the instrument does not have a 99 % power bandwidth function, the trace data points are recovered and directly summed in power units. The recovered amplitude data points, beginning at the lowest frequency, are placed in a running sum until 0.5 % of the total is reached; that frequency is recorded as the lower frequency. The process is repeated until 99.5 % of the total is reached; that frequency is recorded as the upper frequency. The 99% occupied bandwidth is the difference between these two frequencies.

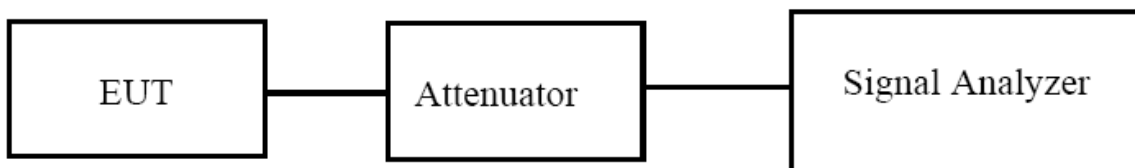

4.3 EUT OPERATION CONDITIONS

The EUT tested system was configured as the statements of 2.4 Unless otherwise a special operating condition is specified in the follows during the testing.

4.4 TEST RESULTS

EUT :	HolaBot	Model Name :	HL100
Temperature :	26 °C	Relative Humidity :	54%
Pressure :	1012 hPa	Test Voltage :	DC 25.55V
Test Mode :	TX Frequency Band 1 (5150-5250MHz), Band 2A (5250-5350MHz), Band 2C(5470-5725MHz), Band 3(5725-5850MHz)		

Test data reference attachment.

5. MINIMUM 6 DB BANDWIDTH

5.1 APPLIED PROCEDURES / LIMIT

According to FCC §15.407(e)

(e) Within the 5.725-5.85 GHz band, the minimum 6 dB bandwidth of U-NII devices shall be at least 500 kHz.

5.2 TEST PROCEDURE

Section 15.407(e) specifies the minimum 6 dB emission bandwidth of at least 500 KHz for the band 5.715-5.85 GHz. The following procedure shall be used for measuring this bandwidth:

- a) Set RBW = 100 kHz.
- b) Set the video bandwidth (VBW) $\geq 3 \times$ RBW.
- c) Detector = Peak.
- d) Trace mode = max hold.
- e) Sweep = auto couple.
- f) Allow the trace to stabilize.
- g) Measure the maximum width of the emission that is constrained by the frequencies associated with the two outermost amplitude points (upper and lower frequencies) that are attenuated by 6 dB relative to the maximum level measured in the fundamental emission.

5.3 DEVIATION FROM STANDARD

No deviation.

5.4 TEST SETUP

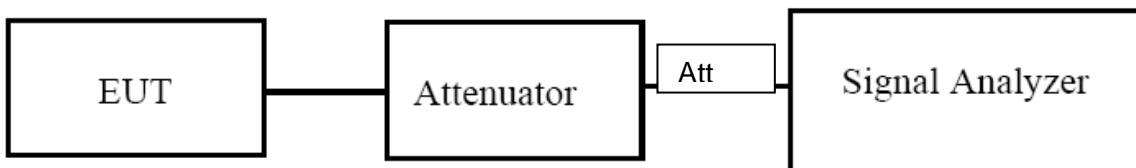

5.5 EUT OPERATION CONDITIONS

The EUT tested system was configured as the statements of 2.4 Unless otherwise a special operating condition is specified in the follows during the testing.

5.6 TEST RESULTS

EUT :	HolaBot	Model Name :	HL100
Temperature :	26 °C	Relative Humidity :	54%
Pressure :	1012 hPa	Test Voltage :	DC 25.55V
Test Mode :	TX (5G) Mode Frequency Band 3 (5725-5850MHz)		

Test data reference attachment.

6. MAXIMUM CONDUCTED OUTPUT POWER

6.1 PPLIED PROCEDURES / LIMIT

According to FCC §15.407

The maximum conduced output power should not exceed:

Frequency Band(MHz)	Limit
5150~5250	250mW
5250~5350	250 mW or 11 dBm + 10 log B Note: The limit is the smaller of the two, "B" represents -26dB bandwidth.
5470~5725	250 mW or 11 dBm + 10 log B Note: The limit is the smaller of the two, "B" represents -26dB bandwidth.
5725~5850	1W

6.2 TEST PROCEDURE

- Method PM is Measurement using an RF average power meter. The procedure for this method is as follows:
 - a) Measurements may be performed using a wideband RF power meter with a thermocouple detector or equivalent if all of the following conditions are satisfied:
 - 1) The EUT is configured to transmit continuously, or to transmit with a constant duty cycle.
 - 2) At all times when the EUT is transmitting, it shall be transmitting at its maximum power control level.
 - 3) The integration period of the power meter exceeds the repetition period of the transmitted signal by at least a factor of five.
 - b) If the transmitter does not transmit continuously, measure the duty cycle D of the transmitter output signal as described in 12.2.
 - c) Measure the average power of the transmitter. This measurement is an average over both the ON and OFF periods of the transmitter.
 - d) Adjust the measurement in dBm by adding $[10 \log (1 / D)]$, where D is the duty cycle {e.g., $[10 \log (1 / 0.25)]$, if the duty cycle is 25%}.

6.3 DEVIATION FROM STANDARD

No deviation.

6.4 TEST SETUP

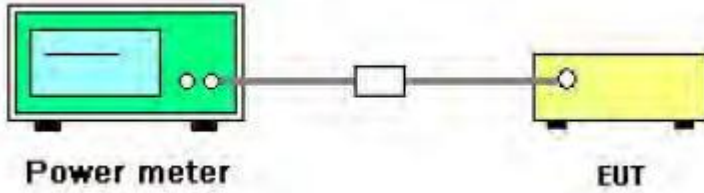

6.5 EUT OPERATION CONDITIONS

The EUT tested system was configured as the statements of 2.4 Unless otherwise a special operating condition is specified in the follows during the testing.

6.2 TEST RESULTS

EUT :	HolaBot	Model Name :	HL100
Temperature :	26 °C	Relative Humidity :	54%
Pressure :	1012 hPa	Test Voltage :	DC 25.55V
Test Mode :	TX (5G) Mode Frequency Band 1 (5150-5250MHz), Band 2A (5250-5350MHz) Band 2C, (5470-5725MHz), Band 3 (5725-5850MHz)		

Note: Band1&Band2A&Band2C For 802.11n/ac 5GHz has MIMO mode. Directional gain=7.01dbi
 7.01 dBi > 6.0 dBi so power limit=24-(7.01-6)=22.99 in dBm
 Band3 For 802.11n/ac 5GHz has MIMO mode. Directional gain=7.01dbi
 7.01 dBi > 6.0 dBi so power limit= 30.00-(7.01-6)=28.99 in dBm

Test data reference attachment.

7. OUT OF BAND EMISSIONS

7.1 APPLICABLE STANDARD

According to FCC §15.407(b)

Undesirable emission limits. Except as shown in paragraph (b)(7) of this section, the maximum emissions outside of the frequency bands of operation shall be attenuated in accordance with the following limits:

- (1) For transmitters operating in the 5.15-5.25 GHz band: All emissions outside of the 5.15-5.35 GHz band shall not exceed an e.i.r.p. of -27 dBm/MHz.
- (2) For transmitters operating in the 5.25-5.35 GHz band: All emissions outside of the 5.15-5.35 GHz band shall not exceed an e.i.r.p. of -27 dBm/MHz.
- (3) For transmitters operating in the 5.47-5.725 GHz band: All emissions outside of the 5.47-5.725 GHz band shall not exceed an e.i.r.p. of -27 dBm/MHz.
- (4) For transmitters operating in the 5.725-5.85 GHz band: All emissions within the frequency range from the band edge to 10 MHz above or below the band edge shall not exceed an e.i.r.p. of -17 dBm/MHz; for frequencies 10 MHz or greater above or below the band edge, emissions shall not exceed an e.i.r.p. of -27 dBm/MHz.

7.2 TEST PROCEDURE

1. Check the calibration of the measuring instrument using either an internal calibrator or a known signal from an external generator.
2. Position the EUT without connection to measurement instrument. Turn on the EUT and connect its antenna terminal to measurement instrument via a low loss cable. Then set it to any one measured frequency within its operating range, and make sure the instrument is operated in its linear range.
3. Set RBW of spectrum analyzer to 1 MHz with a convenient frequency span.
4. Measure the highest amplitude appearing on spectral display and set it as a reference level. Plot the graph with marking the highest point and edge frequency.
5. Repeat above procedures until all measured frequencies were complete.

7.3 DEVIATION FROM STANDARD

No deviation.

7.4 TEST SETUP

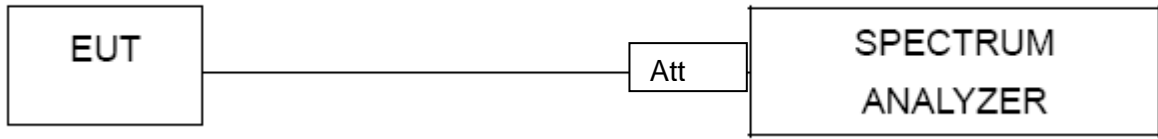

7.5 EUT OPERATION CONDITIONS

The EUT tested system was configured as the statements of 2.4 Unless otherwise a special operating condition is specified in the follows during the testing.

7.6 TEST RESULTS

EUT :	HolaBot	Model Name :	HL100
Temperature :	26 °C	Relative Humidity :	54%
Pressure :	1012 hPa	Test Voltage :	DC 25.55V

Test data reference attachment.

8. Frequency Stability Measurement

8.1 LIMIT

Manufactures of U-NII devices are responsible for ensuring frequency stability such that an emission is maintained within the band of operation under all conditions of normal operation as specified in the user's manual.

8.2 TEST PROCEDURES

1. The transmitter output (antenna port) was connected to the spectrum analyzer.
2. EUT have transmitted absence of modulation signal and fixed channelize.
3. Set the spectrum analyzer span to view the entire absence of modulation emissions bandwidth.
4. Set RBW = 10 kHz, VBW = 10 kHz with peak detector and maxhold settings.
5. f_c is declaring of channel frequency. Then the frequency error formula is $(f_c - f) / f_c \times 10^6$ ppm and the limit is less than ± 20 ppm (IEEE 802.11 specification).
6. The test extreme voltage is to change the primary supply voltage from 85 to 115 percent of the nominal value
7. Extreme temperature is $-20^{\circ}\text{C} \sim 70^{\circ}\text{C}$.

8.3 TEST SETUP LAYOUT

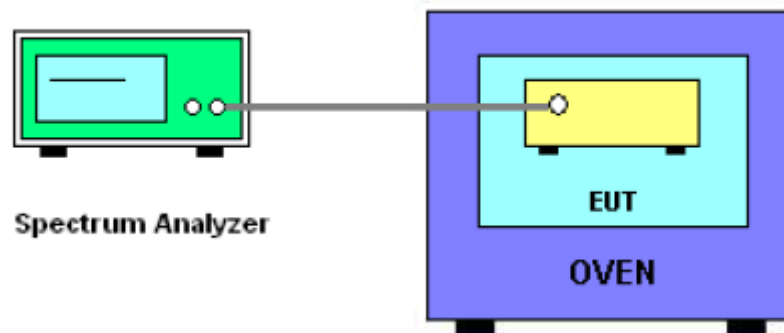

8.4 EUT OPERATION DURING TEST

1. The EUT was programmed to be in continuously un-modulation transmitting mode.
2. The module has two antennas, and the worst data is Antenna 1, only shown Antenna 1 Plot.

8.5 TEST RESULTS

EUT :	HolaBot	Model Name. :	HL100
Temperature :	25 °C	Relative Humidity :	56%
Pressure :	1012 hPa	Test Voltage :	DC 25.55V
Test Mode :	TX Frequency Band I (5150-5250MHz)		

Voltage vs. Frequency Stability

TEST CONDITIONS				Reference Frequency: 5180MHz			
				f	fc	Max. Deviation (MHz)	Max. Deviation (ppm)
T nom (°C)	20	V nom (V)	25.55	5180.0242	5180	0.0242	-4.6718
		V max (V)	28.98	5180.0160	5180	0.0160	-3.0888
		V min (V)	21.42	5180.0131	5180	0.0131	-2.5290
Limits				Within 5150-5250MHz			
Result				Complies			

Temperature vs. Frequency Stability

TEST CONDITIONS				Reference Frequency: 5180MHz			
				f	fc	Max. Deviation (MHz)	Max. Deviation (ppm)
V nom (V)	25.55	T (°C)	-20	5180.0108	5180	0.0108	-2.0849
		T (°C)	-10	5180.0112	5180	0.0112	-2.1622
		T (°C)	0	5180.0250	5180	0.0250	-4.8263
		T (°C)	10	5180.0133	5180	0.0133	-2.5676
		T (°C)	20	5180.0117	5180	0.0117	-2.2587
		T (°C)	30	5180.0131	5180	0.0131	-2.5290
		T (°C)	40	5180.0114	5180	0.0114	-2.2008
		T (°C)	50	5180.0140	5180	0.0140	-2.7027
		T (°C)	60	5180.0158	5180	0.0158	-3.0502
		T (°C)	70	5180.0114	5180	0.0114	-2.2008
Limits				Within 5150-5250MHz			
Result				Complies			

Voltage vs. Frequency Stability

TEST CONDITIONS				Reference Frequency: 5200MHz			
				f	fc	Max. Deviation (MHz)	Max. Deviation (ppm)
T nom (°C)	20	V nom (V)	25.55	5200.0154	5200	0.0154	-2.9615
		V max (V)	28.98	5200.0112	5200	0.0112	-2.1538
		V min (V)	21.42	5200.0130	5200	0.0130	-2.5000
Limits				Within 5150-5250MHz			
Result				Complies			

Temperature vs. Frequency Stability

TEST CONDITIONS				Reference Frequency: 5200MHz			
				f	fc	Max. Deviation (MHz)	Max. Deviation (ppm)
V nom (V)	25.55	T (°C)	-20	5200.0331	5200	0.0331	-6.3654
		T (°C)	-10	5200.0143	5200	0.0143	-2.7500
		T (°C)	0	5200.0331	5200	0.0331	-6.3654
		T (°C)	10	5200.0226	5200	0.0226	-4.3462
		T (°C)	20	5200.0154	5200	0.0154	-2.9615
		T (°C)	30	5200.0141	5200	0.0141	-2.7115
		T (°C)	40	5200.0200	5200	0.0200	-3.8462
		T (°C)	50	5200.0192	5200	0.0192	-3.6923
		T (°C)	60	5200.0149	5200	0.0149	-2.8654
		T (°C)	70	5200.0142	5200	0.0142	-2.7308
Limits				Within 5150-5250MHz			
Result				Complies			

Voltage vs. Frequency Stability

TEST CONDITIONS				Reference Frequency: 5240MHz			
				f	fc	Max. Deviation (MHz)	Max. Deviation (ppm)
T nom (°C)	20	V nom (V)	25.55	5240.0136	5240	0.0136	-2.5954
		V max (V)	28.98	5240.0193	5240	0.0193	-3.6832
		V min (V)	21.42	5240.0176	5240	0.0176	-3.3588
Limits				Within 5150-5250MHz			
Result				Complies			

Temperature vs. Frequency Stability

TEST CONDITIONS				Reference Frequency: 5240MHz			
				f	fc	Max. Deviation (MHz)	Max. Deviation (ppm)
V nom (V)	25.55	T (°C)	-20	5240.0133	5240	0.0133	-2.5382
		T (°C)	-10	5240.0175	5240	0.0175	-3.3397
		T (°C)	0	5240.0173	5240	0.0173	-3.3015
		T (°C)	10	5240.0248	5240	0.0248	-4.7328
		T (°C)	20	5240.0144	5240	0.0144	-2.7481
		T (°C)	30	5240.0166	5240	0.0166	-3.1679
		T (°C)	40	5240.0196	5240	0.0196	-3.7405
		T (°C)	50	5240.0184	5240	0.0184	-3.5115
		T (°C)	60	5240.0146	5240	0.0146	-2.7863
		T (°C)	70	5240.0130	5240	0.0130	-2.4809
Limits				Within 5150-5250MHz			
Result				Complies			

EUT :	HolaBot	Model Name. :	HL100
Temperature :	25 °C	Relative Humidity :	56%
Pressure :	1012 hPa	Test Voltage :	DC 25.55V
Test Mode :	TX Frequency Band 2A (5250-5350MHz)		

Voltage vs. Frequency Stability

TEST CONDITIONS				Reference Frequency: 5260MHz			
				f	fc	Max. Deviation (MHz)	Max. Deviation (ppm)
T nom (°C)	20	V nom (V)	25.55	5260.01711	5260	0.01711	-3.2529
		V max (V)	28.98	5260.01531	5260	0.01531	-2.9106
		V min (V)	21.42	5260.02071	5260	0.02071	-3.9373
Limits				Within 5250-5350MHz			
Result				Complies			

Temperature vs. Frequency Stability

TEST CONDITIONS				Reference Frequency: 5260MHz			
				f	fc	Max. Deviation (MHz)	Max. Deviation (ppm)
V nom (V)	25.55	T (°C)	-20	5260.00641	5260	0.00641	-1.2186
		T (°C)	-10	5260.02401	5260	0.02401	-4.5646
		T (°C)	0	5260.00771	5260	0.00771	-1.4658
		T (°C)	10	5260.01581	5260	0.01581	-3.0057
		T (°C)	20	5260.00711	5260	0.00711	-1.3517
		T (°C)	30	5260.00911	5260	0.00911	-1.7319
		T (°C)	40	5260.01561	5260	0.01561	-2.9677
		T (°C)	50	5260.00741	5260	0.00741	-1.4087
		T (°C)	60	5260.02371	5260	0.02371	-4.5076
		T (°C)	70	5260.02211	5260	0.02211	-4.2034
Limits				Within 5250-5350MHz			
Result				Complies			

Voltage vs. Frequency Stability

TEST CONDITIONS				Reference Frequency: 5280MHz			
				f	fc	Max. Deviation (MHz)	Max. Deviation (ppm)
T nom (°C)	20	V nom (V)	25.55	5280.01111	5280	0.01111	-2.1042
		V max (V)	28.98	5280.01091	5280	0.01091	-2.0663
		V min (V)	21.42	5280.01211	5280	0.01211	-2.2936
Limits				Within 5250-5350MHz			
Result				Complies			

Temperature vs. Frequency Stability

TEST CONDITIONS				Reference Frequency: 5280MHz			
				f	fc	Max. Deviation (MHz)	Max. Deviation (ppm)
V nom (V)	25.55	T (°C)	-20	5280.01771	5280	0.01771	-3.3542
		T (°C)	-10	5280.01641	5280	0.01641	-3.1080
		T (°C)	0	5280.01021	5280	0.01021	-1.9337
		T (°C)	10	5280.01111	5280	0.01111	-2.1042
		T (°C)	20	5280.01121	5280	0.01121	-2.1231
		T (°C)	30	5280.00921	5280	0.00921	-1.7443
		T (°C)	40	5280.01771	5280	0.01771	-3.3542
		T (°C)	50	5280.01181	5280	0.01181	-2.2367
		T (°C)	60	5280.01361	5280	0.01361	-2.5777
		T (°C)	70	5280.00821	5280	0.00821	-1.5549
Limits				Within 5250-5350MHz			
Result				Complies			

Voltage vs. Frequency Stability

TEST CONDITIONS				Reference Frequency: 5320MHz			
				f	fc	Max. Deviation (MHz)	Max. Deviation (ppm)
T nom (°C)	20	V nom (V)	25.55	5320.02471	5320	0.02471	-4.6447
		V max (V)	28.98	5320.01991	5320	0.01991	-3.7425
		V min (V)	21.42	5320.01761	5320	0.01761	-3.3102
Limits				Within 5250-5350MHz			
Result				Complies			

Temperature vs. Frequency Stability

TEST CONDITIONS				Reference Frequency: 5320MHz			
				f	fc	Max. Deviation (MHz)	Max. Deviation (ppm)
V nom (V)	25.55	T (°C)	-20	5320.01291	5320	0.01291	-2.4267
		T (°C)	-10	5320.01151	5320	0.01151	-2.1635
		T (°C)	0	5320.01391	5320	0.01391	-2.6147
		T (°C)	10	5320.00711	5320	0.00711	-1.3365
		T (°C)	20	5320.00671	5320	0.00671	-1.2613
		T (°C)	30	5320.01261	5320	0.01261	-2.3703
		T (°C)	40	5320.02461	5320	0.02461	-4.6259
		T (°C)	50	5320.01601	5320	0.01601	-3.0094
		T (°C)	60	5320.00901	5320	0.00901	-1.6936
		T (°C)	70	5320.02271	5320	0.02271	-4.2688
Limits				Within 5250-5350MHz			
Result				Complies			

EUT :	HolaBot	Model Name. :	HL100
Temperature :	25 °C	Relative Humidity :	56%
Pressure :	1012 hPa	Test Voltage :	DC 25.55V
Test Mode :	TX Frequency Band 2C (5470-5725MHz)		

Voltage vs. Frequency Stability

TEST CONDITIONS				Reference Frequency: 5500MHz			
				f	fc	Max. Deviation (MHz)	Max. Deviation (ppm)
T nom (°C)	20	V nom (V)	25.55	5500.00549	5500	0.00549	-0.9982
		V max (V)	28.98	5500.00386	5500	0.00386	-0.7018
		V min (V)	21.42	5500.00155	5500	0.00155	-0.2818
Limits				Within 5470-5725MHz			
Result				Complies			

Temperature vs. Frequency Stability

TEST CONDITIONS				Reference Frequency: 5500MHz			
				f	fc	Max. Deviation (MHz)	Max. Deviation (ppm)
V nom (V)	25.55	T (°C)	-20	5500.00358	5500	0.00358	-0.6509
		T (°C)	-10	5500.01049	5500	0.01049	-1.9073
		T (°C)	0	5500.00409	5500	0.00409	-0.7436
		T (°C)	10	5500.00422	5500	0.00422	-0.7673
		T (°C)	20	5500.00647	5500	0.00647	-1.1764
		T (°C)	30	5500.00349	5500	0.00349	-0.6345
		T (°C)	40	5500.00286	5500	0.00286	-0.5200
		T (°C)	50	5500.00077	5500	0.00077	-0.1400
		T (°C)	60	5500.00346	5500	0.00346	-0.6291
		T (°C)	70	5500.00617	5500	0.00617	-1.1218
Limits				Within 5470-5725MHz			
Result				Complies			

Voltage vs. Frequency Stability

TEST CONDITIONS				Reference Frequency: 5600MHz			
				f	fc	Max. Deviation (MHz)	Max. Deviation (ppm)
T nom (°C)	20	V nom (V)	25.55	5600.00696	5600	0.00696	-1.2429
		V max (V)	28.98	5600.00875	5600	0.00875	-1.5625
		V min (V)	21.42	5600.00812	5600	0.00812	-1.4500
Limits				Within 5470-5725MHz			
Result				Complies			

Temperature vs. Frequency Stability

TEST CONDITIONS				Reference Frequency: 5600MHz			
				f	fc	Max. Deviation (MHz)	Max. Deviation (ppm)
V nom (V)	25.55	T (°C)	-20	5600.00977	5600	0.00977	-1.7446
		T (°C)	-10	5600.00354	5600	0.00354	-0.6321
		T (°C)	0	5600.00335	5600	0.00335	-0.5982
		T (°C)	10	5600.00804	5600	0.00804	-1.4357
		T (°C)	20	5600.01056	5600	0.01056	-1.8857
		T (°C)	30	5600.00423	5600	0.00423	-0.7554
		T (°C)	40	5600.00736	5600	0.00736	-1.3143
		T (°C)	50	5600.00753	5600	0.00753	-1.3446
		T (°C)	60	5600.01117	5600	0.01117	-1.9946
		T (°C)	70	5600.00552	5600	0.00552	-0.9857
Limits				Within 5470-5725MHz			
Result				Complies			

Voltage vs. Frequency Stability

TEST CONDITIONS				Reference Frequency: 5700MHz			
				f	fc	Max. Deviation (MHz)	Max. Deviation (ppm)
T nom (°C)	20	V nom (V)	25.55	5700.00699	5700	0.00699	-1.2263
		V max (V)	28.98	5700.00866	5700	0.00866	-1.5193
		V min (V)	21.42	5700.01048	5700	0.01048	-1.8386
Limits				Within 5470-5725MHz			
Result				Complies			

Temperature vs. Frequency Stability

TEST CONDITIONS				Reference Frequency: 5700MHz			
				f	fc	Max. Deviation (MHz)	Max. Deviation (ppm)
V nom (V)	25.55	T (°C)	-20	5700.00968	5700	0.00968	-1.6982
		T (°C)	-10	5700.00464	5700	0.00464	-0.8140
		T (°C)	0	5700.00349	5700	0.00349	-0.6123
		T (°C)	10	5700.00233	5700	0.00233	-0.4088
		T (°C)	20	5700.00830	5700	0.00830	-1.4561
		T (°C)	30	5700.00993	5700	0.00993	-1.7421
		T (°C)	40	5700.00617	5700	0.00617	-1.0825
		T (°C)	50	5700.00199	5700	0.00199	-0.3491
		T (°C)	60	5700.00424	5700	0.00424	-0.7439
		T (°C)	70	5700.00419	5700	0.00419	-0.7351
Limits				Within 5470-5725MHz			
Result				Complies			

EUT :	HolaBot	Model Name. :	HL100
Temperature :	25 °C	Relative Humidity :	56%
Pressure :	1012 hPa	Test Voltage :	DC 25.55V
Test Mode :	TX Frequency(5745-5850MHz)		

TEST CONDITIONS				Reference Frequency: 5745MHz			
				f	fc	Max. Deviation (MHz)	Max. Deviation (ppm)
T nom (°C)	20	V nom (V)	25.55	5745.01716	5745	0.01716	-2.9861
		V max (V)	28.98	5745.01154	5745	0.01154	-2.0095
		V min (V)	21.42	5745.01853	5745	0.01853	-3.2249
Limits				Within 5745-5850MHz			
Result				Complies			

Voltage vs. Frequency Stability

Temperature vs. Frequency Stability

TEST CONDITIONS				Reference Frequency: 5745MHz			
				f	fc	Max. Deviation (MHz)	Max. Deviation (ppm)
V nom (V)	25.55	T (°C)	-20	5745.01955	5745	0.01955	-3.4024
		T (°C)	-10	5745.01790	5745	0.01790	-3.1165
		T (°C)	0	5745.01145	5745	0.01145	-1.9926
		T (°C)	10	5745.01312	5745	0.01312	-2.2835
		T (°C)	20	5745.01069	5745	0.01069	-1.8601
		T (°C)	30	5745.01194	5745	0.01194	-2.0780
		T (°C)	40	5745.01621	5745	0.01621	-2.8215
		T (°C)	50	5745.01585	5745	0.01585	-2.7586
		T (°C)	60	5745.01444	5745	0.01444	-2.5138
		T (°C)	70	5745.01230	5745	0.01230	-2.1408
Limits				Within 5745-5850MHz			
Result				Complies			

Voltage vs. Frequency Stability

TEST CONDITIONS				Reference Frequency: 5785MHz			
				f	fc	Max. Deviation (MHz)	Max. Deviation (ppm)
T nom (°C)	20	V nom (V)	25.55	5785.00998	5785	0.00998	-1.7259
		V max (V)	28.98	5785.01462	5785	0.01462	-2.5279
		V min (V)	21.42	5785.01254	5785	0.01254	-2.1681
Limits				Within 5745-5850MHz			
Result				Complies			

Temperature vs. Frequency Stability

TEST CONDITIONS				Reference Frequency: 5785MHz			
				f	fc	Max. Deviation (MHz)	Max. Deviation (ppm)
V nom (V)	25.55	T (°C)	-20	5785.01061	5785	0.01061	-1.8347
		T (°C)	-10	5785.01278	5785	0.01278	-2.2096
		T (°C)	0	5785.01587	5785	0.01587	-2.7431
		T (°C)	10	5785.00896	5785	0.00896	-1.5490
		T (°C)	20	5785.01369	5785	0.01369	-2.3673
		T (°C)	30	5785.01035	5785	0.01035	-1.7898
		T (°C)	40	5785.00792	5785	0.00792	-1.3686
		T (°C)	50	5785.01212	5785	0.01212	-2.0951
		T (°C)	60	5785.01544	5785	0.01544	-2.6687
		T (°C)	70	5785.01522	5785	0.01522	-2.6316
Limits				Within 5745-5850MHz			
Result				Complies			

Voltage vs. Frequency Stability

TEST CONDITIONS				Reference Frequency: 5825MHz			
				f	fc	Max. Deviation (MHz)	Max. Deviation (ppm)
T nom (°C)	20	V nom (V)	25.55	5825.01068	5825	0.01068	-1.8342
		V max (V)	28.98	5825.01379	5825	0.01379	-2.3671
		V min (V)	21.42	5825.01935	5825	0.01935	-3.3221
Limits				Within 5745-5850MHz			
Result				Complies			

Temperature vs. Frequency Stability

TEST CONDITIONS				Reference Frequency: 5825MHz			
				f	fc	Max. Deviation (MHz)	Max. Deviation (ppm)
V nom (V)	25.55	T (°C)	-20	5825.00904	5825	0.00904	-1.5527
		T (°C)	-10	5825.01457	5825	0.01457	-2.5015
		T (°C)	0	5825.01088	5825	0.01088	-1.8686
		T (°C)	10	5825.00802	5825	0.00802	-1.3764
		T (°C)	20	5825.00891	5825	0.00891	-1.5304
		T (°C)	30	5825.01670	5825	0.01670	-2.8670
		T (°C)	40	5825.01491	5825	0.01491	-2.5600
		T (°C)	50	5825.00898	5825	0.00898	-1.5420
		T (°C)	60	5825.01633	5825	0.01633	-2.8034
		T (°C)	70	5825.01342	5825	0.01342	-2.3033
Limits				Within 5745-5850MHz			
Result				Complies			

Note: antenna 1 is the worst case.

9. DYNAMIC FREQUENCY SELECTION(DFS)

9.1 APPLICABILITY OF DFS REQUIREMENTS

EUT is client and operates as client without radar detection function.

Table 1: Applicability of DFS Requirements Prior to Use of a Channel

Requirement	Operational Mode		
	Master	Client Without Radar Detection	Client With Radar Detection
Non-Occupancy Period	Yes	Not required	Yes
DFS Detection Threshold	Yes	Not required	Yes
Channel Availability Check Time	Yes	Not required	Not required
U-NII Detection Bandwidth	Yes	Not required	Yes

Table 2: Applicability of DFS requirements during normal operation

Requirement	Operational Mode		
	Master	Client Without Radar Detection	Client With Radar Detection
DFS Detection Threshold	Yes	Not required	Yes
Channel Closing Transmission Time	Yes	Yes	Yes
Channel Move Time	Yes	Yes	Yes
U-NII Detection Bandwidth	Yes	Not required	Yes
Client Beacon Test	N/A	Yes	Yes

Additional requirements for devices with multiple bandwidth modes	Operational Mode	
	Master or Client With Radar Detection	Client Without Radar Detection
U-NII Detection Bandwidth and Statistical Performance Check	All BW modes must be tested	Not required
Channel Move Time and Channel Closing Transmission Time	Test using widest BW mode available	Test using the widest BW mode available for the link
All other tests	Any single BW mode	Not required
<p>Note Frequencies selected for statistical performance check (Section 7.8.4) should include several frequencies within the radar detection bandwidth and frequencies near the edge of the radar detection bandwidth. For 802.11 devices it is suggested to select frequencies in each of the bonded 20 MHz channels and the channel center frequency.</p>		

9.2 INTERFERENCE THRESHOLD VALUES, MASTER OR CLIENT INCORPORATING IN-SERVICE MONITORING

Maximum Transmit Power	Value (see notes 1, 2, and 3)
EIRP \geq 200 milliwatt	-64 dBm
EIRP < 200 milliwatt and power spectral density < 10 dBm/MHz	-62 dBm
EIRP < 200 milliwatt that do not meet the power spectral density requirement	-64 dBm
<p>Note 1: This is the level at the input of the receiver assuming a 0 dBi receive antenna.</p> <p>Note 2: Throughout these test procedures an additional 1 dB has been added to the amplitude of the test transmission waveforms to account for variations in measurement equipment. This will ensure that the test signal is at or above the detection threshold level to trigger a DFS response.</p> <p>Note 3: EIRP is based on the highest antenna gain.</p>	

9.3 DFS RESPONSE REQUIREMENT VALUES

Parameter	Value
Non-occupancy period	Minimum 30 minutes
Channel Availability Check Time	60 seconds
Channel Move Time	10 seconds See Note 1.
Channel Closing Transmission Time	200 milliseconds + an aggregate of 60 milliseconds over remaining 10 second period. See Notes 1 and 2.
U-NII Detection Bandwidth	Minimum 100% of the 99% power bandwidth See Note 3.

Note 1: The instant that the Channel Move Time and the Channel Closing Transmission Time begins is as follows:

- For the Short pulse radar Test Signals this instant is the end of the Burst.
- For the Frequency Hopping radar Test Signal, this instant is the end of the last radar Burst generated.
- For the Long Pulse radar Test Signal this instant is the end of the 12 second period defining the radar transmission.

Note 2: The Channel Closing Transmission Time is comprised of 200 milliseconds starting at the beginning of the Channel Move Time plus any additional intermittent control signals required to facilitate Channel changes (an aggregate of 60 milliseconds) during the remainder of the 10 second period. The aggregate duration of control signals will not count quiet periods in between transmissions.

Note 3: During the U-NII Detection Bandwidth detection test, radar type 0 is used and for each frequency step the minimum percentage of detection is 90%. Measurements are performed with no data traffic.

9.4 SHORT PULSE RADAR TEST WAVEFORMS

As the EUT is a Client Device with no Radar Detection, only one type radar pulse is required for the testing. Radar Pulse type 0 was used in the evaluation of the Client device for the purpose of measuring the Channel Move Time and the Channel Closing Transmission Time.

Radar Type	Pulse Width (µsec)	PRI (µsec)	Number of Pulses	Minimum Percentage of Successful Detection	Minimum Trials
0	1	1428	18	60%	30
1	1	Test A Test B	$\text{Roundup} \left(\frac{1}{360} \cdot \frac{19 \cdot 10^6}{\text{PRI}_{\text{min}}} \right)$	60%	30
2	1-5	150-230	23-29	60%	30
3	6-10	200-500	16-18	60%	30
4	11-20	200-500	12-16	60%	30
Aggregate (Radar Types 1-4)				80%	120

Test A: 15 unique PRI values randomly selected from the list of 23 PRI values in Table 5a
 Test B: 15 unique PRI values randomly selected within the range of 518-3066 µsec, with a minimum increment of 1 µsec, excluding PRI values selected in Test A

A minimum of 30 unique waveforms are required for each of the short pulse radar types 2 through 4. For short pulse radar type 1, the same waveform is used a minimum of 30 times. If more than 30 waveforms are used for short pulse radar types 2 through 4, then each additional waveform must also be unique and not repeated from the previous waveforms.

If more than 30 waveforms are used for Short Pulse Radar Type 1, then each additional waveform is generated with Test B and must also be unique and not repeated from the previous waveforms in Tests A or B. The aggregate is the average of the percentage of successful detections of short pulse radar types 1-4.

9.5 CALIBRATION SETUP AND DFS TEST RESULTS

Radar Waveform Calibration Procedure

- 1) A 50 ohm load is connected in place of the spectrum analyzer, and the spectrum analyzer is connected to place of the master
- 2) The interference Radar Detection Threshold Level is $-62\text{dBm} - 5.1\text{dBi} + 1\text{dB} = -66.1\text{dBm}$ that had been taken into account the output power range and antenna gain.
- 3) The following equipment setup was used to calibrate the conducted radar waveform. A vector signal generator was utilized to establish the test signal level for radar type 0. During this process there were no transmissions by either the master or client device. The spectrum analyzer was switched to the zero spans (time domain) at the frequency of the radar waveform generator. Peak detection was used. The spectrum analyzer resolution bandwidth (RBW) and video bandwidth (VBW) were set to 3 MHz. The spectrum analyzer had offset -1.0dB to compensate RF cable loss 1.0dB .
- 4) The vector signal generator amplitude was set so that the power level measured at the spectrum analyzer was $-62\text{dBm} - 5.1\text{dBi} + 1\text{dB} = -66.1\text{dBm}$. Capture the spectrum analyzer plots on short pulse radar waveform.

9.6 CONDUCTED CALIBRATION SETUP

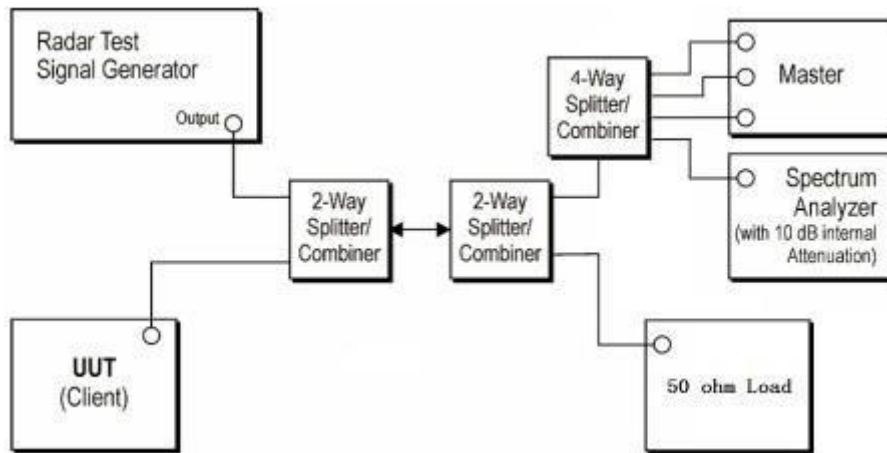

Wireless AP	Manufacturer	LINKSYS LLC
	Model NO.	WRT32X
	FCC ID	Q87-WRT3200ACM

9.7 RADAR WAVEFORM CALIBRATION RESULT

Test data reference attachment.

9.8 IN-SERVICE MONITORING: CHANNEL MOVE TIME, CHANNEL CLOSING TRANSMISSION TIME AND NON-OCCUPANCY PERIOD

TEST CONFIGURATION:

Setup for Client with injection at the Master

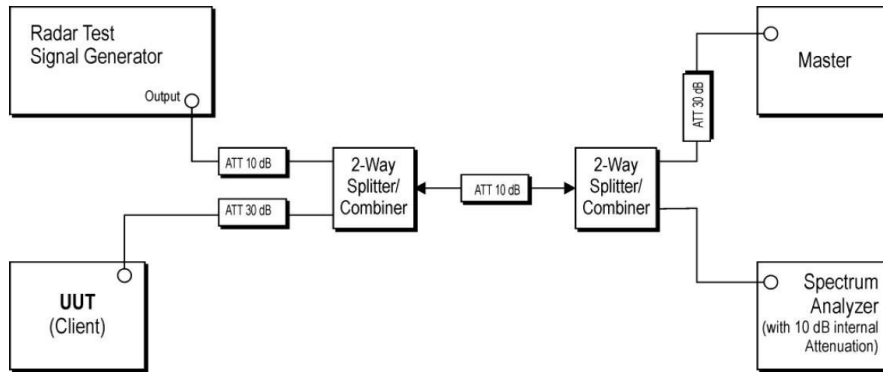

TEST PROCEDURE:

1. The radar pulse generator is setup to provide a pulse at frequency that the master and client are operating. A type 0 radar pulse with a 1us pulse width and a 1428us PRI is used for the testing.
2. The vector signal generator is adjusted to provide the radar burst (18 pulses) at the level of approximately -61dBm at the antenna port of the master device
3. A trigger is provided from the pulse generator to the DFS monitoring system in order to capture the traffic and the occurrence of the radar pulse.
4. EUT will associate with the master at channel. The file "iperf.exe" specified by the FCC is Streamed from the PC 2 through the master and the client device to the PC 1 and played in full motion video using Media Player Classic Ver. 6.4.8.6 in order to properly load the network for the entire period of the test.
5. When radar burst with a level equal to the DFS Detection Threshold +1dB is generated on the operating channel of the U-NII device. At time T0 the radar waveform generator sends a burst of pulse of the radar waveform at Detection Threshold +1dB.
6. Observe the transmissions of the EUT at the end of the radar Burst on the Operating Channel Measure and record the transmissions from the UUT during the observation time (Channel Move Time). One 15 seconds plot is reported for the Short Pulse Radar Type 0. The plot for the Short Pulse Radar Types start at the end of the radar burst. The Channel Move Time will be calculated based on the zoom In 600ms plot of the Short Pulse Radar Type
7. Measurement of the aggregate duration of the Channel Closed Transmission Time method. With the spectrum analyzer set to zero span tuned to the center frequency of the EUT operating channel at the radar simulated frequency, peak detection, and max hold, the dwell time per bin is given by: $Dwell (0.3ms) = S (12000ms) / B (4000)$; where Dwell is the dwell time per spectrum analyzer sampling bin, S is sweep time and B is the number of spectrum analyzer sampling bins. An upper bound of the aggregate duration of the intermittent control signals of Channel Closing Transmission Time is calculated by: $C (ms) = N \times Dwell (0.3ms)$; where C is the Closing Time, N is the number of spectrum analyzer sampling bins (intermittent control signals) showing a U-NII transmission and Dwell is the dwell time per bin.
8. Measurement the EUT for more than 30 minutes following the channel move time to verify that no transmission or beacons occur on this channel.

TEST MODE:

Please refer to the clause 2.2

9.9 RESULT OF CHANNEL MOVE TIME, CHANNEL CLOSING TRANSMISSION TIME AND NON-OCCUPANCY PERIOD FOR CLIENT BEACON TEST

Test data reference attachment.

10. ANTENNA REQUIREMENT

10.1 STANDARD REQUIREMENT

15.203 requirement: For intentional device, according to 15.203: an intentional radiator shall be designed to ensure that no antenna other than that furnished by the responsible party shall be used with the device.

10.2 EUT ANTENNA

This EUT has two modules, module 2 supports Bluetooth, WIFI2.4G / 5G, module2 has two antennas, 1 antenna supports Bluetooth, WIFI2.4G / 5G, 2 antenna supports WIFI2.4G / 5G. The module 1 only supports WIFI 2.4G. The 3 module has only one antenna,

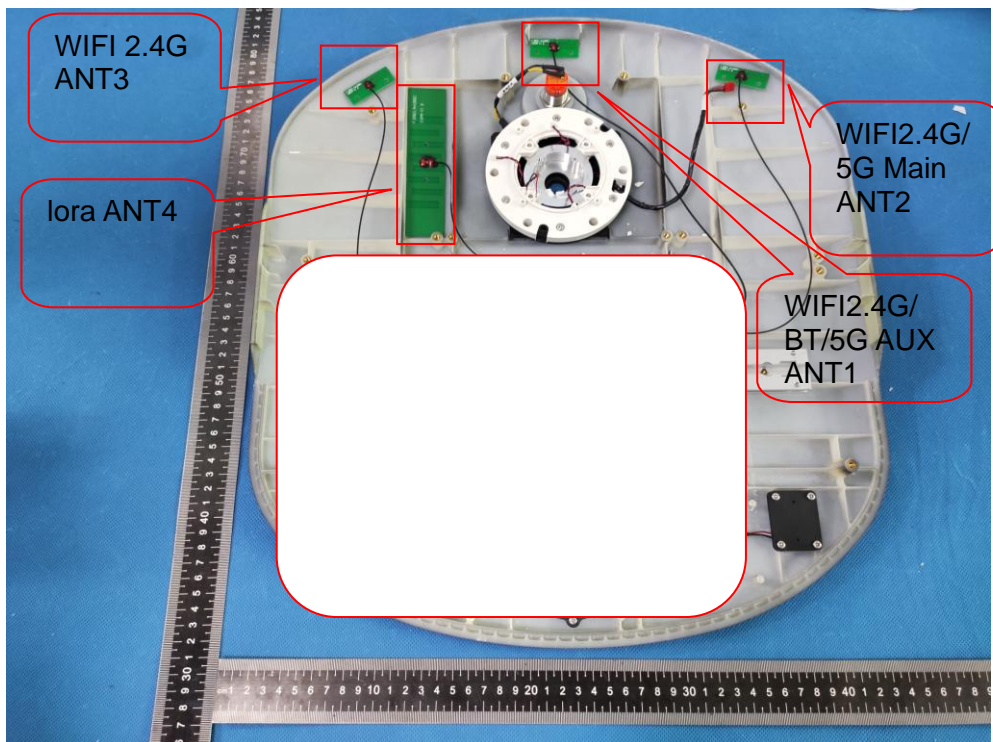

The module 2 for 5G WIFI has two antennas, and different modes support different transmit mode what describe as Following form:

Mode	Tx/Rx
802.11a	1TX, 1RX
802.11n/ac	1TX/2TX, 1RX/2RX

For 5GHz mode, Antenna 1,2 are transmitting, each with the same directional gain.
 For MIMO mode, Directional gain= $G_{ANT} + 10 \log(N_{ANT})$ dBi =7.01dBi in 5GHz
 the 802.11n(20/40) ac(20/40/80) 5GHz has MIMO mode.

Note: G1 means antenna gain for ANT 1 in dBi.
 G2 means antenna gain for ANT 2 in dBi.
 N_{ANT} means the number of Antennas.
 The antenna is permanently fixed, It complies with the standard requirement.

END OF REPORT