

TEST REPORT

BNetzA-CAB-02/21-102

Test report no.: 1-6194_23-02-06-A

Testing laboratory

cetecom advanced GmbH
Untertuerkheimer Strasse 6 – 10
66117 Saarbruecken / Germany
Phone: + 49 681 5 98 - 0
Fax: + 49 681 5 98 - 9075
Internet: <https://cetecomadvanced.com>
e-mail: mail@cetecomadvanced.com

Accredited Testing Laboratory:

The testing laboratory (area of testing) is accredited according to DIN EN ISO/IEC 17025 (2018-03) by the Deutsche Akkreditierungsstelle GmbH (DAkkS).

The accreditation is valid for the scope of testing procedures as stated in the accreditation certificate with the registration number: D-PL-12047-01-00.

ISED Testing Laboratory Recognized Listing Number: DE0001
FCC designation number: DE0002

Applicant

WSAUD A/S
Nymøllevej 6
DK-3540 Lyngby / DENMARK
Phone: +45 4435 5600
Contact: Jan Zøllner Mølgård
e-mail: jan.zoellner.moelgaard.ext@wsa.com

Manufacturer

WSAUD A/S
Nymøllevej 6
DK-3540 Lyngby / DENMARK

Test standard/s

FCC - Title 47 CFR Part 15 FCC - Title 47 of the Code of Federal Regulations; Chapter I; Part 15 - Radio frequency devices

RSS - 247 Issue 2 Digital Transmission Systems (DTSS), Frequency Hopping Systems (FHSs) and Licence - Exempt Local Area Network (LE-LAN) Devices

For further applied test standards please refer to section 3 of this test report.

Test Item

Kind of test item: **Device used to stream audio to hearing aid**

Model name: **SoundConnect**

FCC ID: **2AXDT-WSC**

ISED certification number: **26428-WSC**

Frequency: 2400 MHz to 2483.5 MHz

Technology tested: Proprietary

Antenna: Integrated antenna

Power supply: 5.0 V DC by USB

Temperature range: -10°C to +40°C

This test report is electronically signed and valid without handwritten signature. For verification of the electronic signatures, the public keys can be requested at the testing laboratory.

Test report authorized:

Marco Bertolino
Supervisor Radio Services
Radio Labs

Test performed:

Michael Dorongovski
Lab Manager
Radio Labs

1 Table of contents

1	Table of contents.....	2
2	General information.....	3
2.1	Notes and disclaimer	3
2.2	Application details	3
2.3	Test laboratories sub-contracted	3
3	Test standard/s, references and accreditations	4
4	Reporting statements of conformity – decision rule	5
5	Test environment.....	6
6	Test item	6
6.1	General description	6
6.2	Additional information	6
7	Sequence of testing.....	7
7.1	Sequence of testing radiated spurious 9 kHz to 30 MHz	7
7.2	Sequence of testing radiated spurious 30 MHz to 1 GHz.....	8
7.3	Sequence of testing radiated spurious 1 GHz to 18 GHz.....	9
7.4	Sequence of testing radiated spurious above 18 GHz.....	10
8	Description of the test setup.....	11
8.1	Shielded semi anechoic chamber	12
8.2	Shielded fully anechoic chamber.....	13
8.3	Radiated measurements > 18 GHz	14
8.4	Conducted measurements Bluetooth system	15
8.5	AC conducted.....	16
9	Measurement uncertainty.....	17
10	Summary of measurement results.....	18
11	Additional comments.....	19
12	Measurement results	20
12.1	System gain.....	20
12.2	Power spectral density	21
12.3	DTS bandwidth – 6 dB bandwidth	22
12.4	Occupied bandwidth – 99% emission bandwidth	23
12.5	Maximum output power.....	24
12.6	Band edge compliance radiated.....	25
12.7	TX spurious emissions conducted	29
12.8	Spurious emissions radiated below 30 MHz	30
12.9	Spurious emissions radiated 30 MHz to 1 GHz	34
12.10	Spurious emissions radiated above 1 GHz	37
12.11	Spurious emissions conducted below 30 MHz (AC conducted).....	43
13	Glossary	46
14	Document history	47

2 General information

2.1 Notes and disclaimer

The test results of this test report relate exclusively to the test item specified in this test report. cetecom advanced GmbH does not assume responsibility for any conclusions and generalizations drawn from the test results with regard to other specimens or samples of the type of the equipment represented by the test item.

The test report may only be reproduced or published in full. Reproduction or publication of extracts from the report requires the prior written approval of cetecom advanced GmbH.

The testing service provided by cetecom advanced GmbH has been rendered under the current "General Terms and Conditions for cetecom advanced GmbH".

cetecom advanced GmbH will not be liable for any loss or damage resulting from false, inaccurate, inappropriate or incomplete product information provided by the customer.

Under no circumstances does the cetecom advanced GmbH test report include any endorsement or warranty regarding the functionality, quality or performance of any other product or service provided.

Under no circumstances does the cetecom advanced GmbH test report include or imply any product or service warranties from cetecom advanced GmbH, including, without limitation, any implied warranties of merchantability, fitness for purpose, or non-infringement, all of which are expressly disclaimed by cetecom advanced GmbH.

All rights and remedies regarding vendor's products and services for which cetecom advanced GmbH has prepared this test report shall be provided by the party offering such products or services and not by cetecom advanced GmbH.

In no case this test report can be considered as a Letter of Approval.

This test report is electronically signed and valid without handwritten signature. For verification of the electronic signatures, the public keys can be requested at the testing laboratory.

This test report replaces the test report with the number 1-6194_23-02-06 and dated 2023-08-23.

2.2 Application details

Date of receipt of order:	2023-07-19
Date of receipt of test item:	2023-07-19
Start of test:*	2023-07-21
End of test:*	2023-09-06
Person(s) present during the test:	-/-

*Date of each measurement, if not shown in the plot, can be requested. Dates are stored in the measurement software.

2.3 Test laboratories sub-contracted

None

3 Test standard/s, references and accreditations

Test standard	Date	Description
FCC - Title 47 CFR Part 15	-/-	FCC - Title 47 of the Code of Federal Regulations; Chapter I; Part 15 - Radio frequency devices
RSS - 247 Issue 2	February 2017	Digital Transmission Systems (DTSS), Frequency Hopping Systems (FHSs) and Licence - Exempt Local Area Network (LE-LAN) Devices
RSS - Gen Issue 5 incl. Amendment 1 & 2	February 2021	Spectrum Management and Telecommunications Radio Standards Specification - General Requirements for Compliance of Radio Apparatus
Guidance	Version	Description
KDB 558074 D01	v05r02	GUIDANCE FOR COMPLIANCE MEASUREMENTS ON DIGITAL TRANSMISSION SYSTEM, FREQUENCY HOPPING SPREAD SPECTRUM SYSTEM, AND HYBRID SYSTEM DEVICES OPERATING UNDER SECTION 15.247 OF THE FCC RULES
ANSI C63.4-2014	-/-	American National Standard for Methods of Measurement of Radio-Noise Emissions from Low-Voltage Electrical and Electronic Equipment in the Range of 9 kHz to 40 GHz
ANSI C63.10-2013	-/-	American National Standard of Procedures for Compliance Testing of Unlicensed Wireless Devices

4 Reporting statements of conformity – decision rule

Only the measured values related to their corresponding limits will be used to decide whether the equipment under test meets the requirements of the test standards listed in chapter 3. The measurement uncertainty is mentioned in this test report, see chapter 9, but is not taken into account - neither to the limits nor to the measurement results. Measurement results with a smaller margin to the corresponding limits than the measurement uncertainty have a potential risk of more than 5% that the decision might be wrong."

measured value, measurement uncertainty, verdict

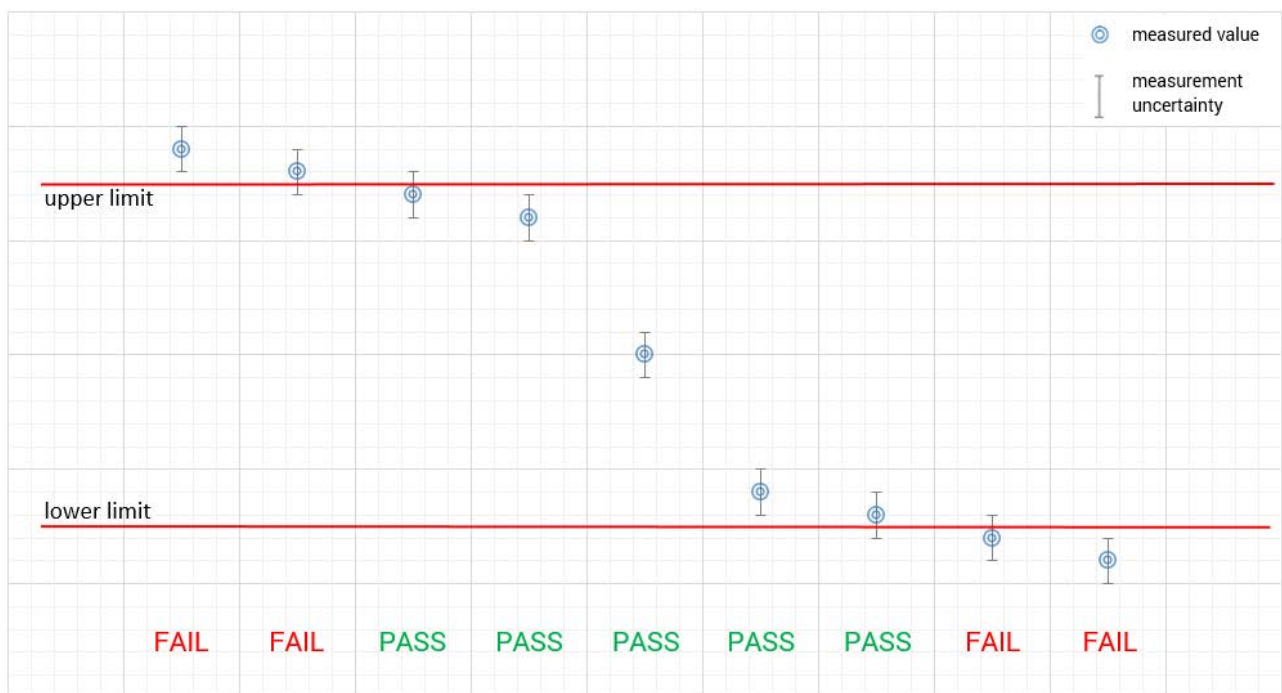

5 Test environment

Temperature	:	T_{nom} T_{max} T_{min}	+22 °C during room temperature tests No tests under extreme environmental conditions required. No tests under extreme environmental conditions required.
Relative humidity content	:		50 %
Barometric pressure	:		1012 hpa
Power supply	:	V_{nom} V_{max} V_{min}	5.0 V DC by USB No tests under extreme environmental conditions required. No tests under extreme environmental conditions required.

6 Test item

6.1 General description

Kind of test item	:	Device used to stream audio to hearing aid	
Model name	:	SoundConnect	
HMN	:	-/-	
PMN	:	SoundConnect	
HVIN	:	SoundConnect	
FVIN	:	-/-	
S/N serial number	:	Rad. 0001001	Cond. 0001007
Hardware status	:	1.0	
Software status	:	NA	
Firmware status	:	v0.2.20_DTM	
Frequency band	:	2400 MHz to 2483.5 MHz	
Type of radio transmission	:	DTS	
Use of frequency spectrum	:		
Type of modulation	:	GFSK	
Number of channels	:	40	
Antenna	:	Integrated antenna	
Power supply	:	5.0 V DC by USB	
Temperature range	:	-10°C to +40°C	

6.2 Additional information

The content of the following annexes is defined in the QA. It may be that not all of the listed annexes are necessary for this report, thus some values in between may be missing.

Test setup and EUT photos are included in test report:

- 1-6194_23-02-01_AnnexA
- 1-6194_23-02-01_AnnexB
- 1-6194_23-02-01_AnnexD

7 Sequence of testing

7.1 Sequence of testing radiated spurious 9 kHz to 30 MHz

Setup

- The equipment is set up to simulate normal operation mode as described in the user manual or defined by the manufacturer.
- If the EUT is a tabletop system, it is placed on a table with 0.8 m height.
- If the EUT is a floor standing device, it is placed directly on the turn table.
- Auxiliary equipment and cables are positioned to simulate normal operation conditions as described in ANSI C 63.4.
- The AC power port of the EUT (if available) is connected to a power outlet below the turntable.
- Measurement distance is 3 m (see ANSI C 63.4) – see test details.
- EUT is set into operation.

Premeasurement*

- The turntable rotates from 0° to 315° using 45° steps.
- The antenna height is 1 m.
- At each turntable position the analyzer sweeps with positive-peak detector to find the maximum of all emissions.

Final measurement

- Identified emissions during the pre-measurement are maximized by the software by rotating the turntable from 0° to 360°.
- Loop antenna is rotated about its vertical axis for maximum response at each azimuth about the EUT. (For certain applications, the loop antenna plane may also need to be positioned horizontally at the specified distance from the EUT)
- The final measurement is done in the position (turntable and elevation) causing the highest emissions with quasi-peak (as described in ANSI C 63.4).
- Final levels, frequency, measuring time, bandwidth, turntable position, correction factor, margin to the limit and limit will be recorded. A plot with the graph of the premeasurement and the limit is stored.

*Note: The sequence will be repeated three times with different EUT orientations.

7.2 Sequence of testing radiated spurious 30 MHz to 1 GHz

Setup

- The equipment is set up to simulate normal operation mode as described in the user manual or defined by the manufacturer.
- If the EUT is a tabletop system, a table with 0.8 m height is used, which is placed on the ground plane.
- If the EUT is a floor standing device, it is placed on the ground plane with insulation between both.
- Auxiliary equipment and cables are positioned to simulate normal operation conditions as described in ANSI C 63.4.
- The AC power port of the EUT (if available) is connected to a power outlet below the turntable.
- Measurement distance is 10 m or 3 m (see ANSI C 63.4) – see test details.
- EUT is set into operation.

Premeasurement

- The turntable rotates from 0° to 315° using 45° steps.
- The antenna is polarized vertical and horizontal.
- The antenna height changes from 1 m to 3 m.
- At each turntable position, antenna polarization and height the analyzer sweeps three times in peak to find the maximum of all emissions.

Final measurement

- The final measurement is performed for at least six highest peaks according to the requirements of the ANSI C63.4.
- Based on antenna and turntable positions at which the peak values are measured the software maximize the peaks by changing turntable position $\pm 45^\circ$ and antenna height between 1 and 4 m.
- The final measurement is done with quasi-peak detector (as described in ANSI C 63.4).
- Final levels, frequency, measuring time, bandwidth, antenna height, antenna polarization, turntable angle, correction factor, margin to the limit and limit are recorded. A plot with the graph of the premeasurement with marked maximum final results and the limit is stored.

7.3 Sequence of testing radiated spurious 1 GHz to 18 GHz

Setup

- The equipment is set up to simulate normal operation mode as described in the user manual or defined by the manufacturer.
- If the EUT is a tabletop system, a 2-axis positioner with 1.5 m height is used.
- If the EUT is a floor standing device, it is placed directly on the turn table.
- Auxiliary equipment and cables are positioned to simulate normal operation conditions as described in ANSI C 63.4.
- The AC power port of the EUT (if available) is connected to a power outlet below the turntable.
- Measurement distance is 3 m (see ANSI C 63.4) – see test details.
- EUT is set into operation.

Premeasurement

- The turntable rotates from 0° to 315° using 45° steps.
- The antenna is polarized vertical and horizontal.
- The antenna height is 1.5 m.
- At each turntable position and antenna polarization the analyzer sweeps with positive peak detector to find the maximum of all emissions.

Final measurement

- The final measurement is performed for at least six highest peaks according to the requirements of the ANSI C63.4.
- Based on antenna and turntable positions at which the peak values are measured the software maximizes the peaks by rotating the turntable from 0° to 360°. This measurement is repeated for different EUT-table positions (0° to 150° in 30°-steps) and for both antenna polarizations.
- The final measurement is done in the position (turntable, EUT-table and antenna polarization) causing the highest emissions with Peak and RMS detector (as described in ANSI C 63.4).
- Final levels, frequency, measuring time, bandwidth, turntable position, EUT-table position, antenna polarization, correction factor, margin to the limit and limit are recorded. A plot with the graph of the premeasurement with marked maximum final results and the limit is stored.

7.4 Sequence of testing radiated spurious above 18 GHz

Setup

- The equipment is set up to simulate normal operation mode as described in the user manual or defined by the manufacturer.
- Auxiliary equipment and cables are positioned to simulate normal operation conditions as described in ANSI C 63.4.
- The AC power port of the EUT (if available) is connected to a power outlet.
- The measurement distance is as appropriate (e.g. 0.5 m).
- The EUT is set into operation.

Premeasurement

- The test antenna is handheld and moved carefully over the EUT to cover the EUT's whole sphere and different polarizations of the antenna.

Final measurement

- The final measurement is performed at the position and antenna orientation causing the highest emissions with Peak and RMS detector (as described in ANSI C 63.4).
- Final levels, frequency, measuring time, bandwidth, correction factor, margin to the limit and limit are recorded. A plot with the graph of the premeasurement and the limit is stored.

8 Description of the test setup

Typically, the calibrations of the test apparatus are commissioned to and performed by an accredited calibration laboratory. The calibration intervals are determined in accordance with the DIN EN ISO/IEC 17025. In addition to the external calibrations, the laboratory executes comparison measurements with other calibrated test systems or effective verifications. Weekly chamber inspections and range calibrations are performed. Where possible, RF generating and signaling equipment as well as measuring receivers and analyzers are connected to an external high-precision 10 MHz reference (GPS-based or rubidium frequency standard).

In order to simplify the identification of the equipment used at some special tests, some items of test equipment and ancillaries can be provided with an identifier or number in the equipment list below (Lab/Item).

Each block diagram listed can contain several test setup configurations. All devices belonging to a test setup are identified with the same letter syntax. For example: Column Setup and all devices with an A.

Agenda: Kind of Calibration

k	calibration / calibrated	EK	limited calibration
ne	not required (k, ev, izw, zw not required)	zw	cyclical maintenance (external cyclical maintenance)
ev	periodic self verification	izw	internal cyclical maintenance
Ve	long-term stability recognized	g	blocked for accredited testing
vlk!	Attention: extended calibration interval		
NK!	Attention: not calibrated	*)	next calibration ordered / currently in progress

8.1 Shielded semi anechoic chamber

The radiated measurements are performed in vertical and horizontal plane in the frequency range from 30 MHz to 1 GHz in semi-anechoic chambers. The EUT is positioned on a non-conductive support with a height of 0.80 m above a conductive ground plane that covers the whole chamber. The receiving antennas are conform to specifications ANSI C63. These antennas can be moved over the height range between 1.0 m and 4.0 m in order to search for maximum field strength emitted from EUT. The measurement distances between EUT and receiving antennas are indicated in the test setups for the various frequency ranges. For each measurement, the EUT is rotated in all three axes until the maximum field strength is received. The wanted and unwanted emissions are received by spectrum analyzers where the detector modes and resolution bandwidths over various frequency ranges are set according to requirement ANSI C63.

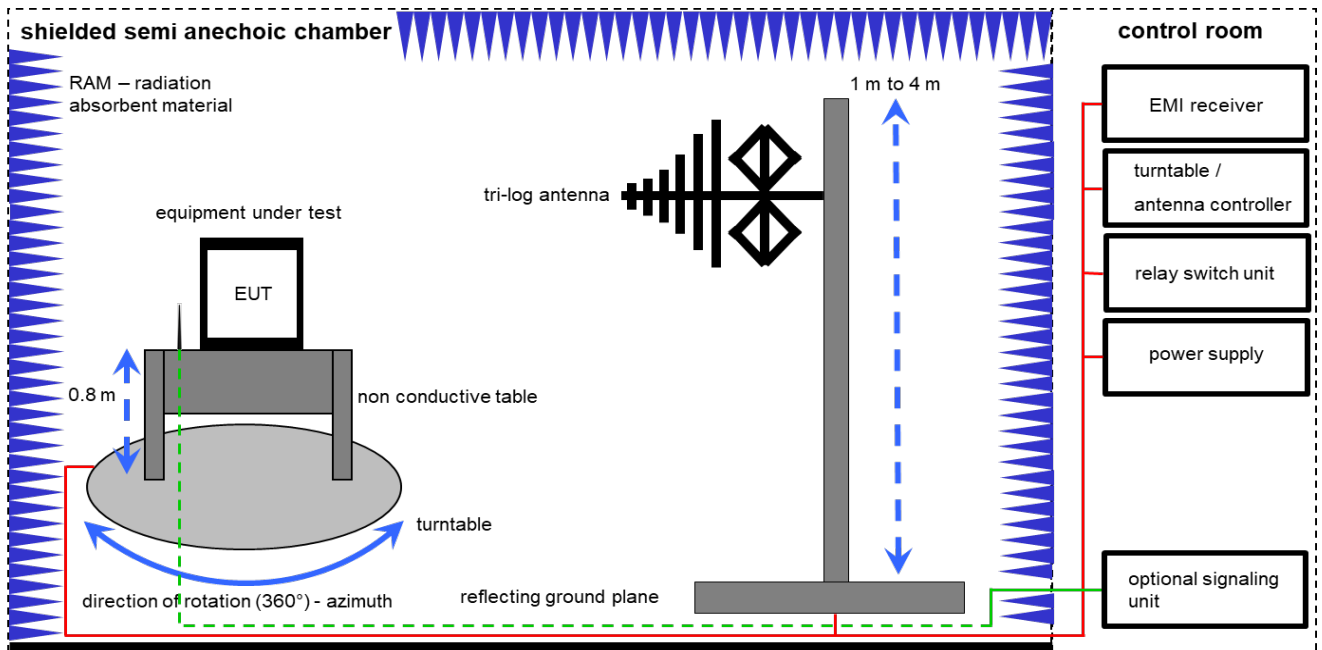

Measurement distance: tri-log antenna 10 meter; EMC32 software version: 10.59.00

FS = UR + CL + AF

(FS-field strength; UR-voltage at the receiver; CL-loss of the cable; AF-antenna factor)

Example calculation:

FS [dB μ V/m] = 12.35 [dB μ V/m] + 1.90 [dB] + 16.80 [dB/m] = 31.05 [dB μ V/m] (35.69 μ V/m)

Equipment table:

No.	Setup	Equipment	Type	Manufacturer	Serial No.	INV. No.	Kind of Calibration	Last Calibration	Next Calibration
1	A	Switch-Unit	3488A	HP	2719A14505	300000368	ev	-/-	-/-
2	A	Semi anechoic chamber	3000023	MWB AG	-/-	300000551	ne	-/-	-/-
3	A	Antenna Tower	Model 2175	ETS-Lindgren	64762	300003745	izw	-/-	-/-
4	A	Positioning Controller	Model 2090	ETS-Lindgren	64672	300003746	izw	-/-	-/-
5	A	Turntable Interface-Box	Model 105637	ETS-Lindgren	44583	300003747	izw	-/-	-/-
6	A	TRILOG Broadband Test-Antenna 30 MHz - 3 GHz	VULB9163	Schwarzbeck Mess-Elektronik	318	300003696	vKI!	30.09.2021	29.09.2023
7	A	Turntable	2089-4.0	EMCO	-/-	300004394	ne	-/-	-/-
8	A	PC	Tecline	F+W	-/-	300004388	ne	-/-	-/-
9	A	EMI Test Receiver	ESR3	Rohde & Schwarz	102587	300005771	k	09.12.2022	31.12.2023

8.2 Shielded fully anechoic chamber

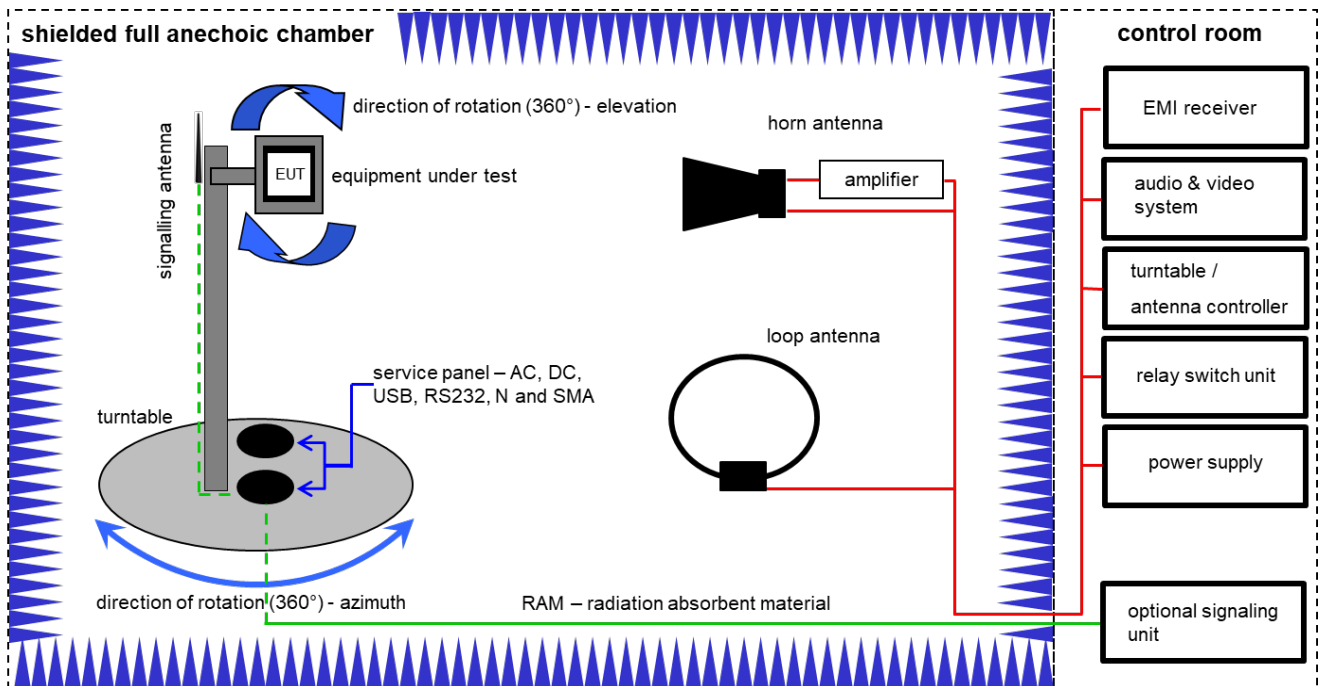

Measurement distance: horn antenna 3 meter; loop antenna 3 meter / 1 meter

$$FS = UR + CA + AF$$

(FS-field strength; UR-voltage at the receiver; CA-loss of the signal path; AF-antenna factor)

Example calculation:

$$FS [dB\mu V/m] = 40.0 [dB\mu V/m] + (-35.8) [dB] + 32.9 [dB/m] = 37.1 [dB\mu V/m] (71.61 \mu V/m)$$

Equipment table:

No.	Setup	Equipment	Type	Manufacturer	Serial No.	INV. No.	Kind of Calibration	Last Calibration	Next Calibration
1	A, B, C	Double-Ridged Waveguide Horn Antenna 1-18.0GHz	3115	EMCO	8812-3088	300001032	vKII	02.08.2021	31.08.2023
2	C	Active Loop Antenna 9 kHz to 30 MHz	6502	EMCO	2210	300001015	vKII	01.07.2021 02.08.2023	31.07.2023 31.08.2025
3	B	Highpass Filter	WHK1.1/15G-10SS	Wainwright	37	400000148	ne	-/-	-/-
4	B	Highpass Filter	WHKX7.0/18G-8SS	Wainwright	18	300003789	ne	-/-	-/-
5	B	Band Reject Filter	WRCG2400/2483-2375/2505-50/10SS	Wainwright	26	300003792	ne	-/-	-/-
6	A, B, C	Broadband Amplifier 0.5-18 GHz	CBLU5184540	CERNEX	22051	300004483	ev	-/-	-/-
7	A, B, C	4U RF Switch Platform	L4491A	Agilent Technologies	MY50000032	300004510	ne	-/-	-/-
8	A, B, C	Computer	Intel Core i3 3220/3,3 GHz, Prozessor	-/-	2V2403033A54 21	300004591	ne	-/-	-/-
9	A, B, C	NEXIO EMV-Software	BAT EMC V2022.0.22.0	Nexio	-/-	300004682	ne	-/-	-/-
10	A, B, C	Anechoic chamber	-/-	TDK	-/-	300003726	ne	-/-	-/-
11	A, B, C	EMI Test Receiver 9kHz-26,5GHz	ESR26	Rohde & Schwarz	101376	300005063	k	13.12.2022	31.12.2023
12	B	RF-Amplifier	AMF-6F06001800-30-10P-R	NARDA-MITEQ Inc	2011571	300005240	ev	-/-	-/-

NOTE: Radiated tests were performed before the 2023-08-30.

8.3 Radiated measurements > 18 GHz

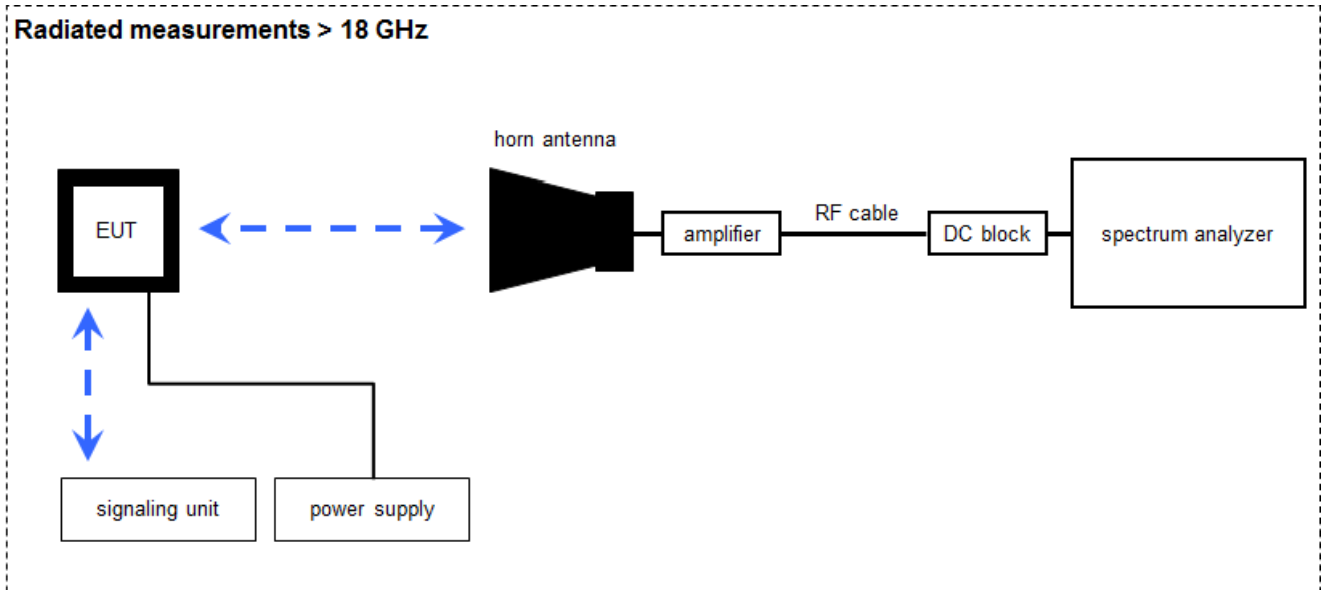

Measurement distance: horn antenna 50 cm

$$FS = UR + CA + AF$$

(FS-field strength; UR-voltage at the receiver; CA-loss signal path & distance correction; AF-antenna factor)

Example calculation:

$$FS [dB\mu V/m] = 40.0 [dB\mu V/m] + (-60.1) [dB] + 36.74 [dB/m] = 16.64 [dB\mu V/m] (6.79 \mu V/m)$$

Equipment table:

No.	Setup	Equipment	Type	Manufacturer	Serial No.	INV. No.	Kind of Calibration	Last Calibration	Next Calibration
1	A	Microwave System Amplifier, 0.5-26.5 GHz	83017A	HP	00419	300002268	ev	-/-	-/-
2	A	Std. Gain Horn Antenna 18.0-26.5 GHz	638	Narda	8205	300002442	k	17.01.2022	31.01.2024
3	A	Signal analyzer	FSV40	Rohde&Schwarz	101042	300004517	k	12.12.2022	31.12.2023
4	A	RF-Cable	ST18/SMAm/SMAm /48	Huber & Suhner	Batch no. 600918	400001182	ev	-/-	-/-
5	A	DC-Blocker 0.1-40 GHz	8141A	Inmet	-/-	400001185	ev	-/-	-/-

8.4 Conducted measurements Bluetooth system

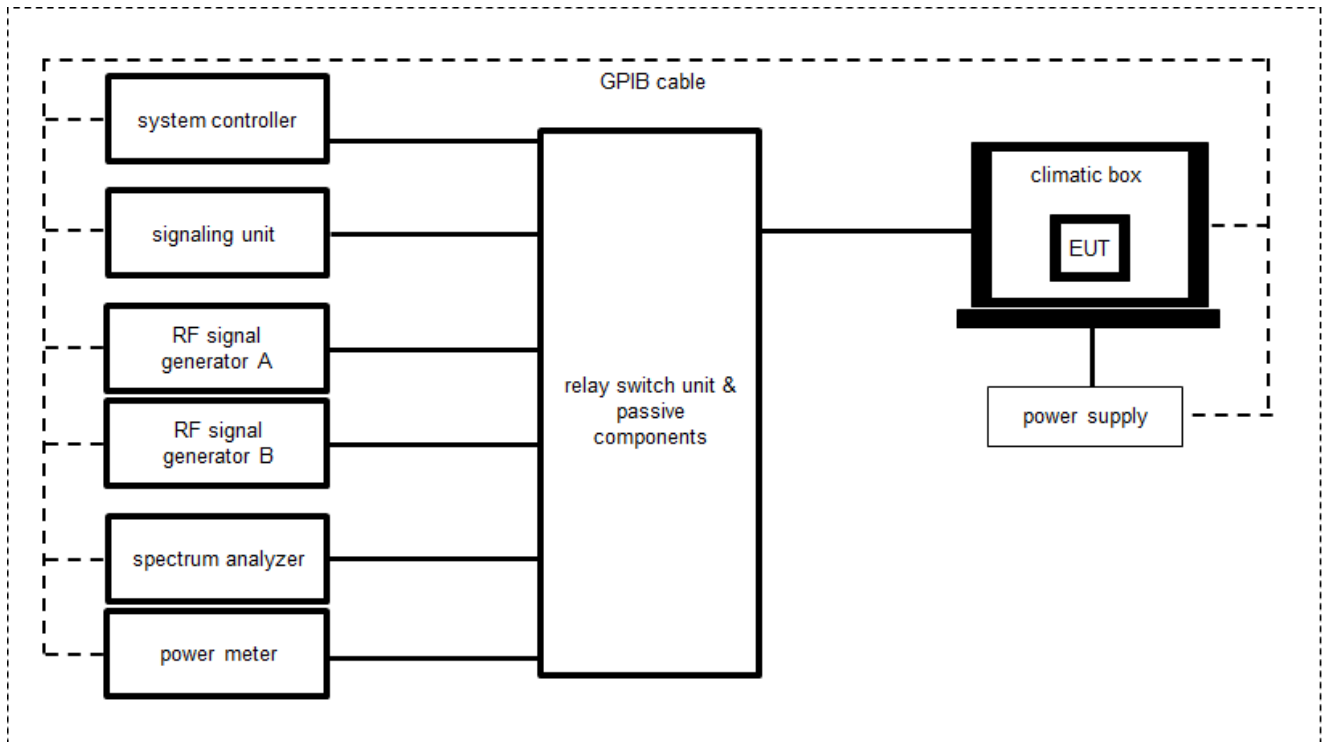

OP = AV + CA
 (OP-output power; AV-analyzer value; CA-loss signal path)

Example calculation:

OP [dBm] = 6.0 [dBm] + 11.7 [dB] = 17.7 [dBm] (58.88 mW)

Equipment table:

No.	Setup	Equipment	Type	Manufacturer	Serial No.	INV. No.	Kind of Calibration	Last Calibration	Next Calibration
1	A	Switch / Control Unit (including DC-Block, Splitter)	3488A	HP	-/-	300000929	ne	-/-	-/-
2	A	Hygro-Thermometer	-/, 5-45C, 20-100rF	Thies Clima	-/-	400000080	ev	15.09.2022	14.09.2024
3	A	Signal analyzer	FSV30	Rohde&Schwarz	1321.3008K30/103170	300004855	vKI!	09.12.2022	31.12.2024
4	A	USB-GPIB-Interface	82357B	Agilent Technologies	MY54323070	300004852	ne	-/-	-/-
5	A	Tester Software C.BER	Version 5.0	cetecom advanced GmbH	0001	400001379	ne	-/-	-/-
6	A	Switch matrix	RSM 1.1	cetecom advanced GmbH	31534892	400001456	ev	20.09.2022	19.09.2023

8.5 AC conducted

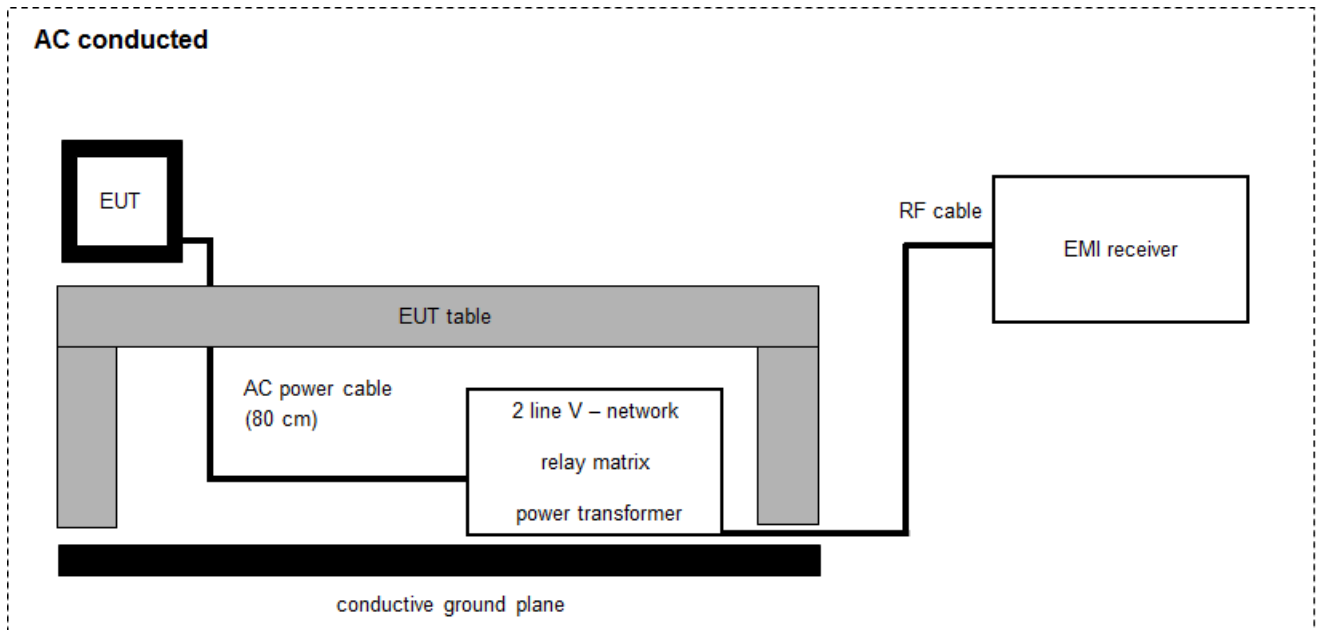

FS = UR + CF + VC

(FS-field strength; UR-voltage at the receiver; CR-loss of the cable and filter; VC-correction factor of the ISN)

Example calculation:

FS [dB μ V/m] = 37.62 [dB μ V/m] + 9.90 [dB] + 0.23 [dB] = 47.75 [dB μ V/m] (244.06 μ V/m)

Equipment table:

No.	Setup	Equipment	Type	Manufacturer	Serial No.	INV. No.	Kind of Calibration	Last Calibration	Next Calibration
1	A	Two-line V-Network (LISN) 9 kHz to 30 MHz	ESH3-Z5	Rohde & Schwarz	892475/017	300002209	vIK!	14.12.2021	31.12.2023
2	A	RF-Filter-section	85420E	HP	3427A00162	300002214	NK!	-/-	-/-
3	A	Hochpass 150 kHz	EZ-25	R&S	100010	300003798	ev	-/-	-/-
4	A	PC	TecLine	F+W	-/-	300003532	ne	-/-	-/-
5	A	EMI Test Receiver 3.6 GHz	ESR3	Rohde & Schwarz	102981	300006318	k	09.12.2022	31.12.2023

9 Measurement uncertainty

Measurement uncertainty	
Test case	Uncertainty
Antenna gain	± 3 dB
Spectrum bandwidth	± 21.5 kHz absolute; ± 15.0 kHz relative
Maximum output power	± 1 dB
Detailed conducted spurious emissions @ the band edge	± 1 dB
Band edge compliance radiated	± 3 dB
Band edge compliance conducted	± 1.5 dB
Spurious emissions conducted	± 3 dB
Spurious emissions radiated below 30 MHz	± 3 dB
Spurious emissions radiated 30 MHz to 1 GHz	± 3 dB
Spurious emissions radiated 1 GHz to 12.75 GHz	± 3.7 dB
Spurious emissions radiated above 12.75 GHz	± 4.5 dB
Spurious emissions conducted below 30 MHz (AC conducted)	± 2.6 dB

10 Summary of measurement results

<input checked="" type="checkbox"/>	No deviations from the technical specifications were ascertained
<input type="checkbox"/>	There were deviations from the technical specifications ascertained
<input type="checkbox"/>	This test report is only a partial test report. The content and verdict of the performed test cases are listed below.

TC Identifier	Description	Verdict	Date	Remark
RF-Testing	CFR Part 15 RSS - 247, Issue 2	See table!	2023-09-07	-/-

Test specification clause	Test case	Guideline	Temperature conditions	Power source voltages	Mode	C	NC	NA	NP	Remark
§15.247(b)(4) RSS - 247 / 5.4 (4)	System gain	-/-	Nominal	Nominal	1 Mbit/s	<input checked="" type="checkbox"/>	<input type="checkbox"/>	<input type="checkbox"/>	<input type="checkbox"/>	-/-
§15.247(e) RSS - 247 / 5.2 (b)	Power spectral density	KDB 558074 DTS clause: 8.4	Nominal	Nominal	1 Mbit/s 2 Mbit/s	<input checked="" type="checkbox"/>	<input type="checkbox"/>	<input type="checkbox"/>	<input type="checkbox"/>	-/-
§15.247(a)(2) RSS - 247 / 5.2 (a)	DTS bandwidth – 6 dB bandwidth	KDB 558074 DTS clause: 8.2	Nominal	Nominal	1 Mbit/s 2 Mbit/s	<input checked="" type="checkbox"/>	<input type="checkbox"/>	<input type="checkbox"/>	<input type="checkbox"/>	-/-
RSS Gen clause 4.6.1	Occupied bandwidth	-/-	Nominal	Nominal	1 Mbit/s 2 Mbit/s	<input checked="" type="checkbox"/>	<input type="checkbox"/>	<input type="checkbox"/>	<input type="checkbox"/>	-/-
§15.247(b)(3) RSS - 247 / 5.4 (4)	Maximum output power	KDB 558074 DTS clause: 8.3.1.1	Nominal	Nominal	1 Mbit/s 2 Mbit/s	<input checked="" type="checkbox"/>	<input type="checkbox"/>	<input type="checkbox"/>	<input type="checkbox"/>	-/-
§15.205 RSS - 247 / 5.5 RSS - Gen	Band edge compliance cond. & rad.	KDB 558074 DTS clause: 8.7.2 or 8.7.3	Nominal	Nominal	1 Mbit/s 2 Mbit/s	<input checked="" type="checkbox"/>	<input type="checkbox"/>	<input type="checkbox"/>	<input type="checkbox"/>	-/-
§15.247(d) RSS - 247 / 5.5	TX spurious emissions conducted	KDB 558074 DTS clause: 8.5	Nominal	Nominal	1 Mbit/s 2 Mbit/s	<input checked="" type="checkbox"/>	<input type="checkbox"/>	<input type="checkbox"/>	<input type="checkbox"/>	-/-
§15.209(a) RSS - Gen	Spurious emissions radiated below 30 MHz	-/-	Nominal	Nominal	1 Mbit/s 2 Mbit/s	<input checked="" type="checkbox"/>	<input type="checkbox"/>	<input type="checkbox"/>	<input type="checkbox"/>	-/-
§15.247(d) RSS - 247 / 5.5 §15.109 RSS - Gen	Spurious emissions radiated 30 MHz to 1 GHz	-/-	Nominal	Nominal	1 Mbit/s 2 Mbit/s	<input checked="" type="checkbox"/>	<input type="checkbox"/>	<input type="checkbox"/>	<input type="checkbox"/>	-/-
§15.247(d) RSS - 247 / 5.5 §15.109 RSS - Gen	Spurious emissions radiated above 1 GHz	-/-	Nominal	Nominal	1 Mbit/s 2 Mbit/s	<input checked="" type="checkbox"/>	<input type="checkbox"/>	<input type="checkbox"/>	<input type="checkbox"/>	-/-
§15.107(a) §15.207	Conducted emissions below 30 MHz (AC conducted)	-/-	Nominal	Nominal	1 Mbit/s	<input checked="" type="checkbox"/>	<input type="checkbox"/>	<input type="checkbox"/>	<input type="checkbox"/>	-/-

Note: C = Compliant; NC = Not compliant; NA = Not applicable; NP = Not performed

11 Additional comments

Reference documents: 1-6194_23-02-06_Annex_MR.pdf

Special test descriptions: None

Configuration descriptions: Power setting 8 was used for all tests. nRFConnect software was used for all tests.

Test mode: Special software is used.
EUT is transmitting pseudo random data by itself

Antennas and transmit operating modes:

- Operating mode 1 (single antenna)**
 - *Equipment with 1 antenna,*
 - *Equipment with 2 diversity antennas operating in switched diversity mode by which at any moment in time only 1 antenna is used,*
 - *Smart antenna system with 2 or more transmit/receive chains, but operating in a mode where only 1 transmit/receive chain is used)*
- Operating mode 2 (multiple antennas, no beamforming)**
 - *Equipment operating in this mode contains a smart antenna system using two or more transmit/receive chains simultaneously but without beamforming.*
- Operating mode 3 (multiple antennas, with beamforming)**
 - *Equipment operating in this mode contains a smart antenna system using two or more transmit/receive chains simultaneously with beamforming. In addition to the antenna assembly gain (G), the beamforming gain (Y) may have to be taken into account when performing the measurements.*

12 Measurement results

12.1 System gain

Measurement:

The antenna gain of the complete system is calculated by the difference of radiated power in EIRP and the conducted power of the EUT.

Measurement parameters (radiated)	
Detector	Peak
Sweep time	Auto
Resolution bandwidth	3 MHz
Video bandwidth	3 MHz
Span	5 MHz
Trace mode	Max hold
Test setup	See sub clause 8.2 B
Measurement uncertainty	See sub clause 9

Measurement parameters (conducted)	
External result file	1-6194_23-02-06_Annex_MR.pdf Common2G4 Peak OP 3 MHz/3 MHz
Test setup	See sub clause 8.4 A
Measurement uncertainty	See sub clause 9

Limits:

FCC	ISED
6 dBi / > 6 dBi output power and power density reduction required	

Results:

T _{nom}	V _{nom}	2402 MHz	2440 MHz	2480 MHz
Conducted power [dBm] Measured with GFSK modulation (1 Mbit/s)		5.6	6.5	5.3
Radiated power [dBm] Measured with GFSK modulation (1 Mbit/s)		5.3	8.3	7.1
Gain [dBi] Calculated		-0.3	1.8	1.8

12.2 Power spectral density

Description:

Measurement of the power spectral density of a digital modulated system.

Measurement parameters	
External result file	1-6194_23-02-06_Annex_MR.pdf FCC Part 15.247 Peak Power Spectral Density DTS
Test setup	See sub clause 8.4 A
Measurement uncertainty	See sub clause 9

Limits:

FCC	ISED
Power spectral density	
For digitally modulated systems the transmitter power spectral density conducted from the transmitter to the antenna shall not be greater than 8 dBm in any 3 kHz band during any time interval of continuous transmission or over 1.0 second if the transmission exceeds 1.0-second duration.	

Results:

	Frequency		
	2402 MHz	2440 MHz	2480 MHz
Power spectral density [dBm / 3kHz] 1 Mbit/s	-10.9	-9.7	-11.3
Power spectral density [dBm / 3kHz] 2 Mbit/s	-12.6	-11.5	-13.0

12.3 DTS bandwidth – 6 dB bandwidth

Description:

Measurement of the 6 dB bandwidth of the modulated signal.

Measurement parameters	
External result file	1-6194_23-02-06_Annex_MR.pdf FCC Part 15.247 Bandwidth 6dB DTS
Test setup	See sub clause 8.4 A
Measurement uncertainty	See sub clause 9

Limits:

FCC	ISED
DTS bandwidth – 6 dB bandwidth	
Systems using digital modulation techniques may operate in the 2400–2483.5 MHz band. The minimum 6 dB bandwidth shall be at least 500 kHz.	

Results:

	Frequency		
	2402 MHz	2440 MHz	2480 MHz
6 dB bandwidth [kHz] 1 Mbit/s	708	697	713
6 dB bandwidth [kHz] 2 Mbit/s	1144	1152	1155

12.4 Occupied bandwidth – 99% emission bandwidth

Description:

Measurement of the 99% bandwidth of the modulated signal acc. RSS-GEN.

Measurement parameters	
External result file	1-6194_23-02-06_Annex_MR.pdf FCC Part 15.247 Bandwidth 99PCT-20dB
Test setup	See sub clause 8.4 A
Measurement uncertainty	See sub clause 9

Usage:

-/-	ISED
Occupied bandwidth – 99% emission bandwidth	
OBW is necessary for emission designator	

Results:

	Frequency		
	2402 MHz	2440 MHz	2480 MHz
99% bandwidth [kHz] 1 Mbit/s	1051	1044	1052
99% bandwidth [kHz] 2 Mbit/s	2045	2042	2057

12.5 Maximum output power

Description:

Measurement of the maximum output power conducted. EUT in single channel mode.

Measurement parameters	
External result file	1-6194_23-02-06_Annex_MR.pdf FCC Part 15.247 Maximum Peak Conducted Output Power DTS
Test setup	See sub clause 8.4 A
Measurement uncertainty	See sub clause 9

Limits:

FCC	ISED
Maximum output power	
Conducted: 1.0 W – antenna gain max. 6 dBi	

Results:

	Frequency		
	2402 MHz	2440 MHz	2480 MHz
Maximum output power conducted [dBm] 1 Mbit/s	5.5	6.3	5.1
Maximum output power conducted [dBm] 2 Mbit/s	5.8	6.6	5.6

12.6 Band edge compliance radiated

Description:

Measurement of the radiated band edge compliance. The EUT is turned in the position that results in the maximum level at the band edge. Then a sweep over the corresponding restricted band is performed. The EUT is set to single channel mode and the transmit frequency 2402 MHz for the lower restricted band and 2480 MHz for the upper restricted band. Measurement distance is 3m.

Measurement parameters	
Detector	Peak / RMS
Sweep time	Auto
Resolution bandwidth	1 MHz
Video bandwidth	3 MHz
Span	Lower Band: 2300 – 2400 MHz higher Band: 2480 – 2500 MHz
Trace mode	Max hold
Test setup	See sub clause 8.2 A
Measurement uncertainty	See sub clause 9

Limits:

FCC	ISED
Band edge compliance radiated	
<p>In any 100 kHz bandwidth outside the frequency band in which the spread spectrum or digitally modulated intentional radiator is operating, the radio frequency power that is produced by the intentional radiator shall be at least 20 dB below that in the 100 kHz bandwidth within the band that contains the highest level of the desired power, based on either an RF conducted or a radiated measurement. Attenuation below the general limits specified in Section 15.209(a) is not required. In addition, radiated emissions which fall in the restricted bands, as defined in Section 15.205(a), must also comply with the radiated emission limits specified in Section 15.209(a) (see Section 5.205(c)).</p>	
54 dB μ V/m AVG 74 dB μ V/m Peak	

Result:

Scenario	Band edge compliance radiated [dB μ V/m]
Data rate	1 Mbit/s
Lower restricted band	33.0 dB μ V/m AVG 43.6 dB μ V/m Peak
Upper restricted band	52.2 dB μ V/m AVG 61.0 dB μ V/m Peak
Data rate	2 Mbit/s
Lower restricted band	33.9 dB μ V/m AVG 44.9 dB μ V/m Peak
Upper restricted band	53.1 dB μ V/m AVG 63.1 dB μ V/m Peak

Plots:

Plot 1: Lower restricted band, 1 Mbit/s

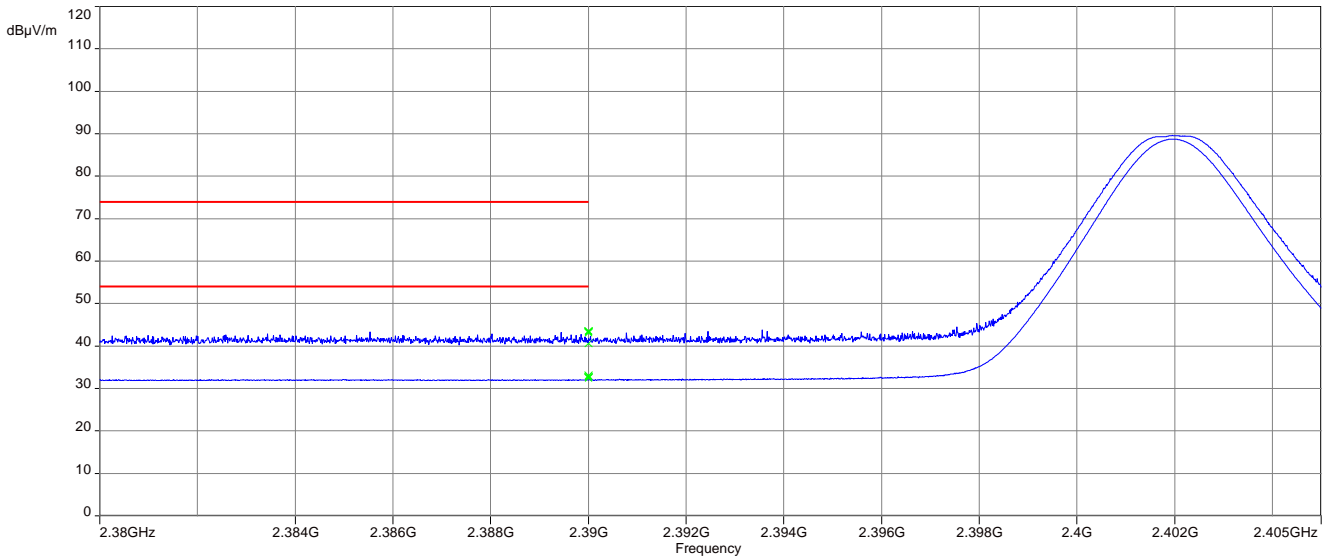

Plot 2: Upper restricted band, 1 Mbit/s

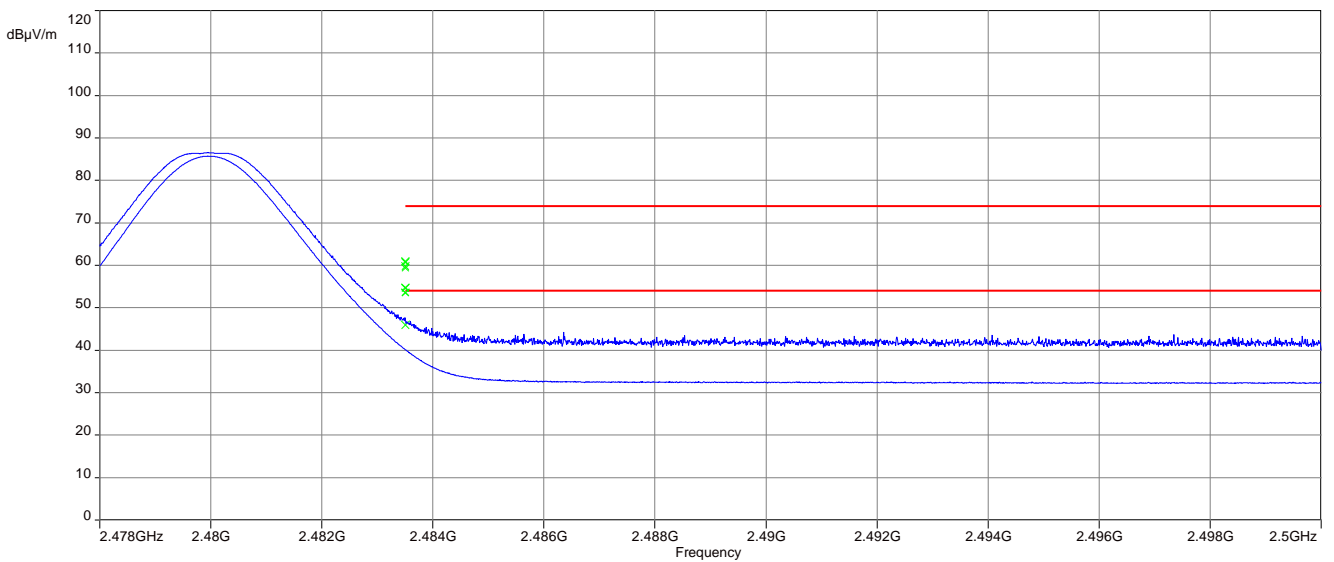

Plot 3: Lower restricted band, 2 Mbit/s

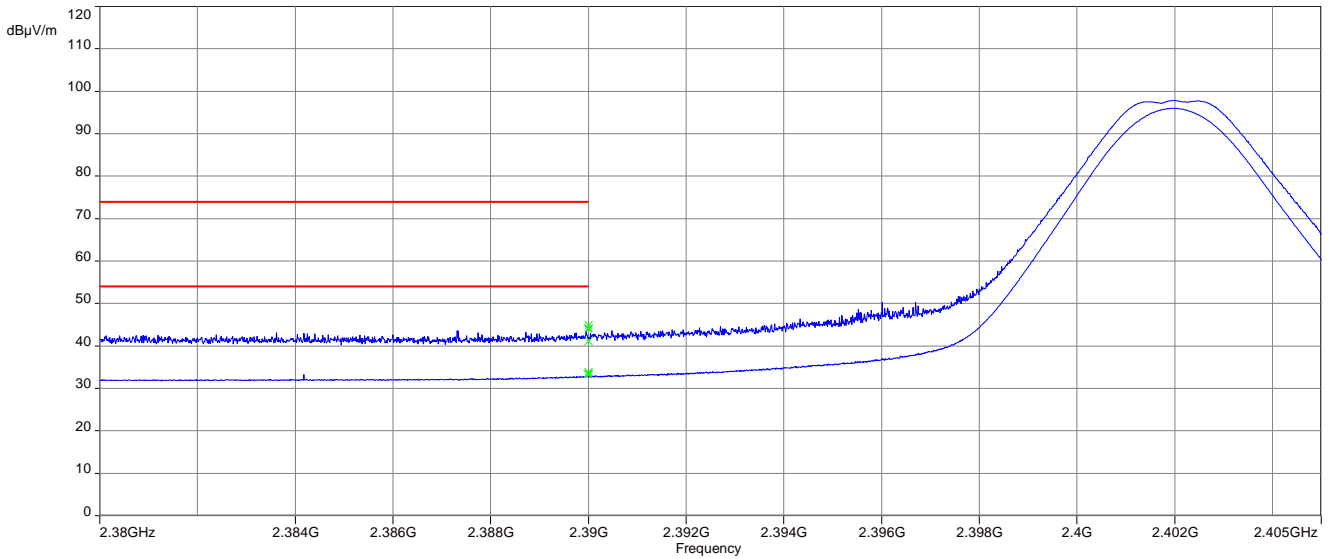

Plot 4: Upper restricted band, 2 Mbit/s

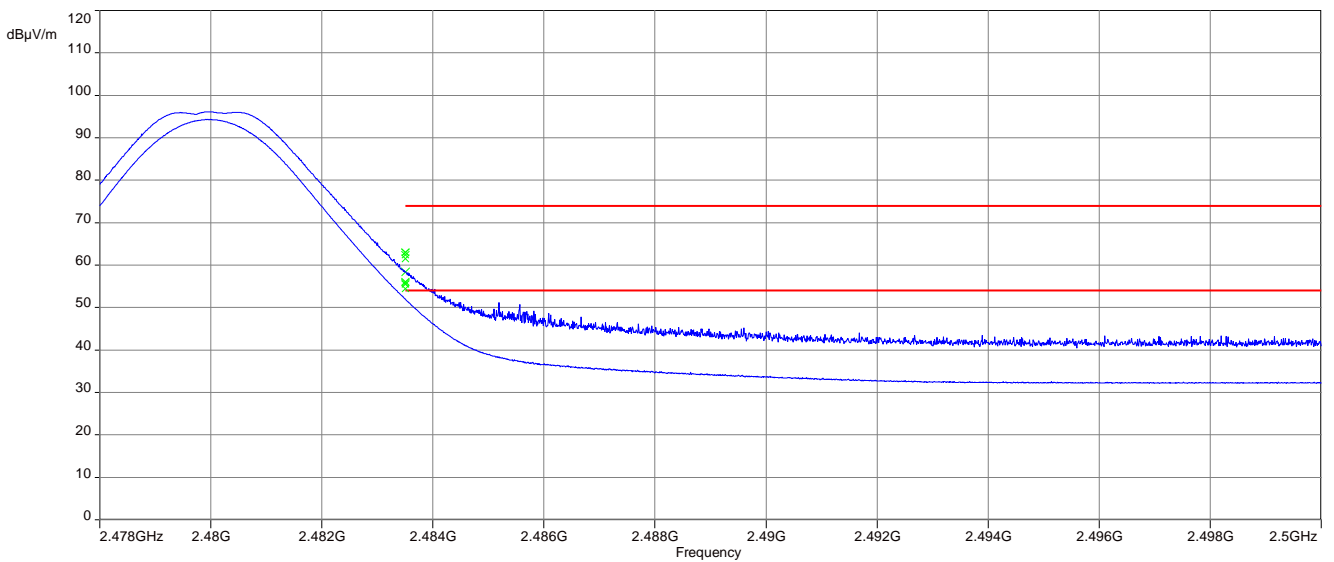

12.7 TX spurious emissions conducted

Description:

Measurement of the conducted spurious emissions in transmit mode. The EUT is set to single channel mode and the transmit frequencies are 2402 MHz, 2440 MHz and 2480 MHz.

Measurement parameters	
External result file	1-6194_23-02-06_Annex_MR.pdf FCC Part 15.247 TX Spurious Conducted
Test setup	See sub clause 8.4 A
Measurement uncertainty	See sub clause 9

Limits:

FCC	ISED
TX spurious emissions conducted	
In any 100 kHz bandwidth outside the frequency band in which the spread spectrum or digitally modulated intentional radiator is operating, the radio frequency power that is produced by the intentional radiator shall be at least 20 dB below that in the 100 kHz bandwidth within the band that contains the highest level of the desired power, based on either an RF conducted or a radiated measurement. Attenuation below the general limits specified in Section 15.209(a) is not required	

Results: Compliant (see external result file)

12.8 Spurious emissions radiated below 30 MHz

Description:

Measurement of the radiated spurious emissions in transmit mode below 30 MHz. The EUT is set to single channel mode and the transmit frequencies are 2402 MHz, 2440 MHz and 2480 MHz. The limits are recalculated to a measurement distance of 3 m according the ANSI C63.10.

Measurement parameters	
Detector	Peak / Quasi peak
Sweep time	Auto
Resolution bandwidth	F < 150 kHz: 200 Hz F > 150 kHz: 9 kHz
Video bandwidth	F < 150 kHz: 1 kHz F > 150 kHz: 30 kHz
Span	9 kHz to 30 MHz
Trace mode	Max hold
Test setup	See sub clause 8.2 C
Measurement uncertainty	See sub clause 9

Limits:

FCC		ISED
TX spurious emissions radiated below 30 MHz		
Frequency (MHz)	Field strength (dB μ V/m)	Measurement distance
0.009 – 0.490	2400/F(kHz)	300
0.490 – 1.705	24000/F(kHz)	30
1.705 – 30.0	30	30

Results:

TX spurious emissions radiated below 30 MHz [dB μ V/m]		
F [MHz]	Detector	Level [dB μ V/m]
All detected emissions are more than 20 dB below the limit.		

Plots:

Plot 1: 9 kHz to 30 MHz, 2402 MHz, transmit mode, 1 Mbit/s

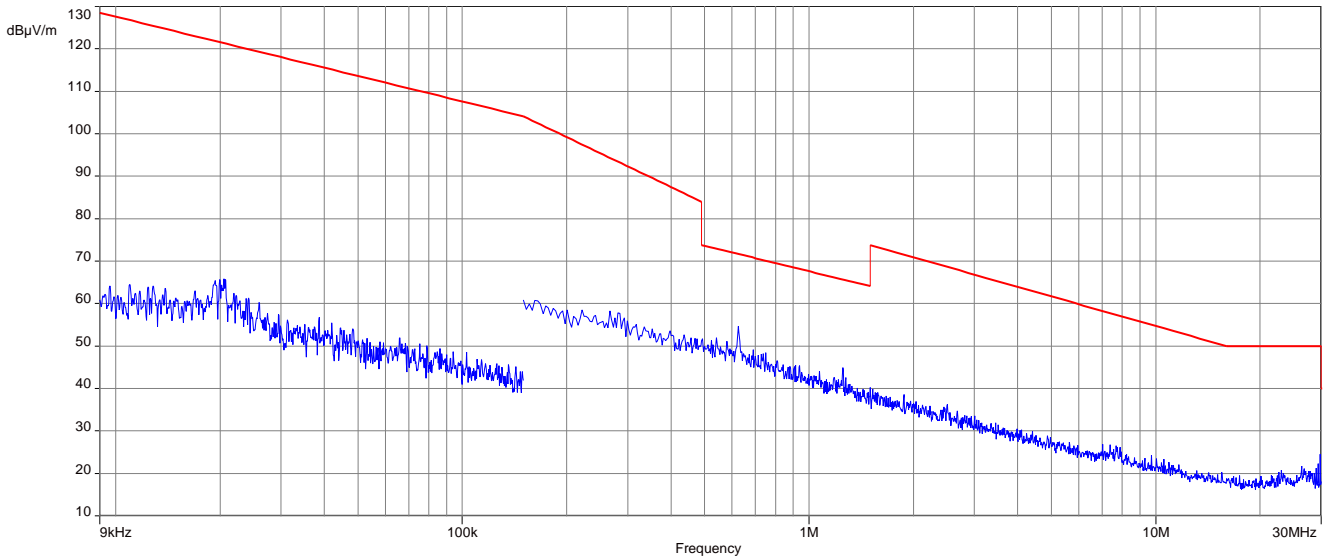

Plot 2: 9 kHz to 30 MHz, 2440 MHz, transmit mode, 1 Mbit/s

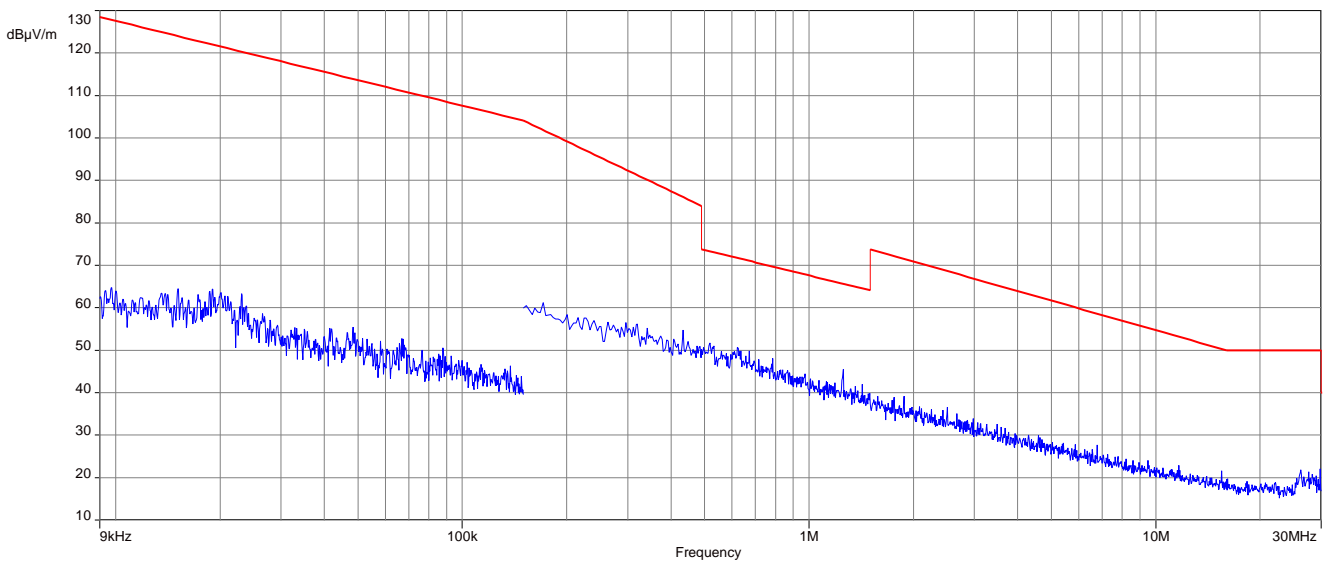

Plot 3: 9 kHz to 30 MHz, 2480 MHz, transmit mode, 1 Mbit/s

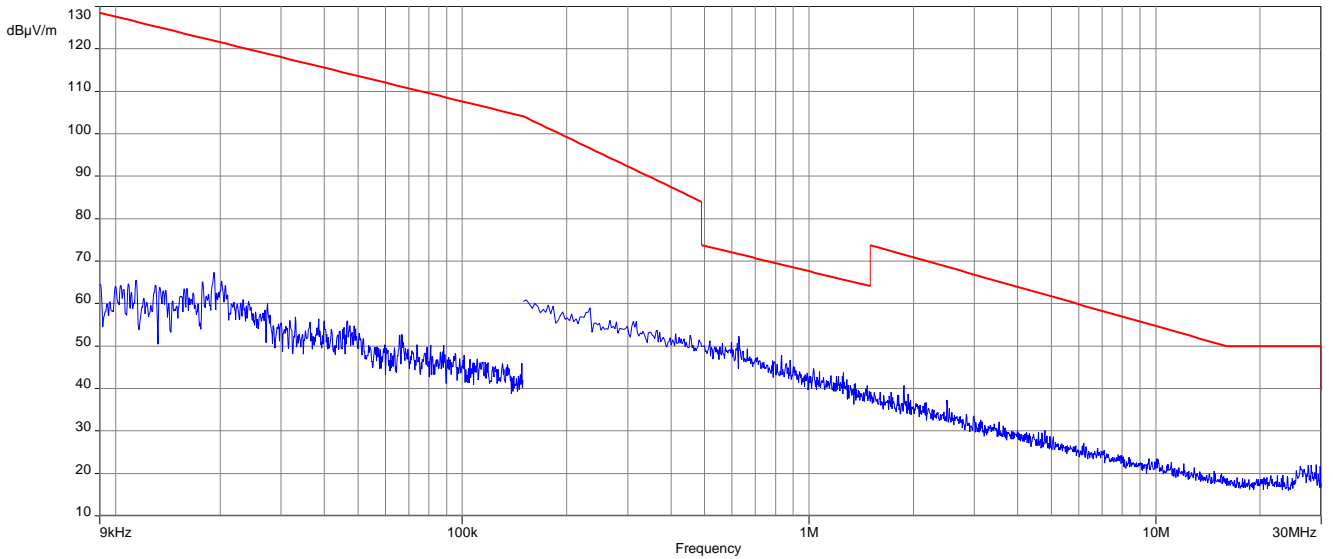

Plot 4: 9 kHz to 30 MHz, 2402 MHz, transmit mode, 2 Mbit/s

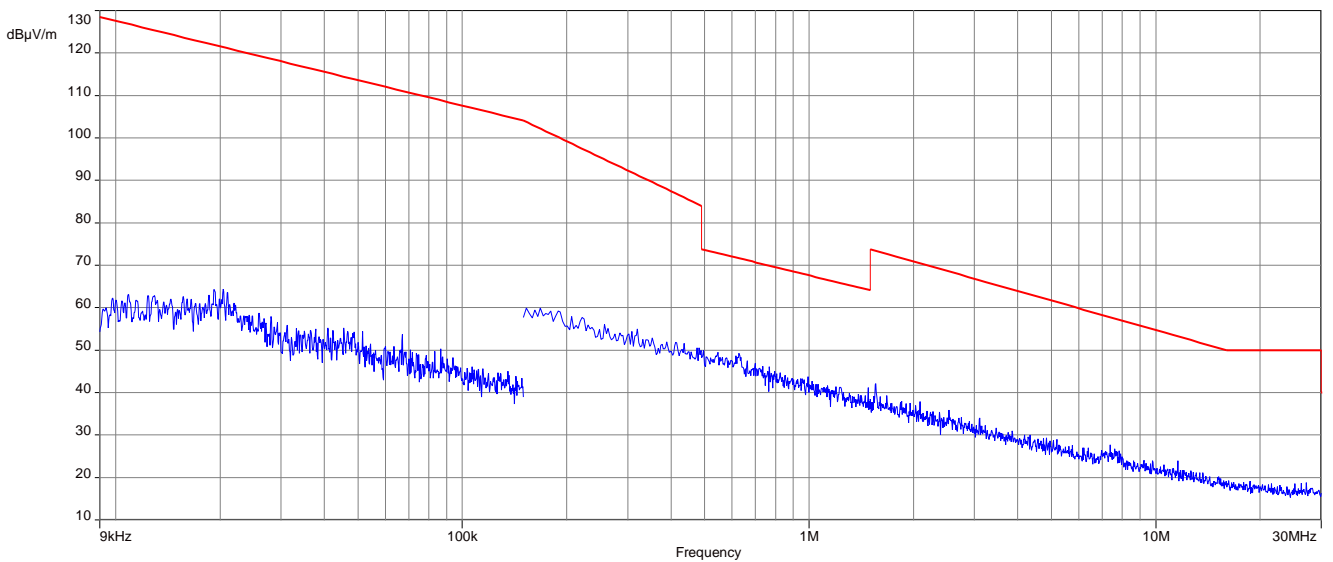

Plot 5: 9 kHz to 30 MHz, 2440 MHz, transmit mode, 2 Mbit/s

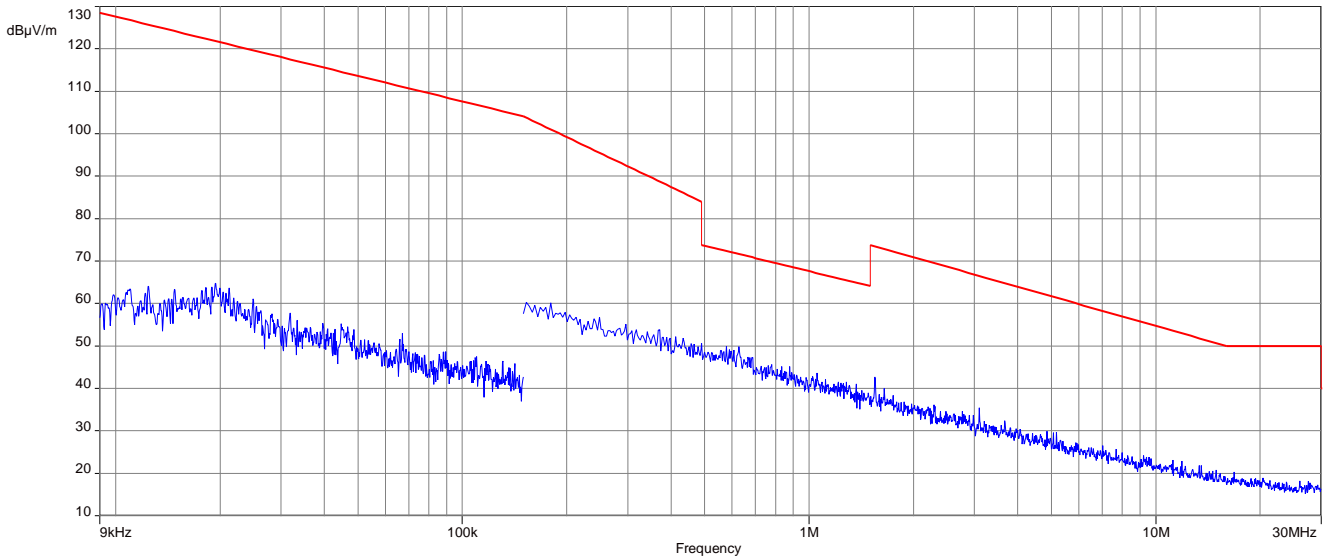

Plot 6: 9 kHz to 30 MHz, 2480 MHz, transmit mode, 2 Mbit/s

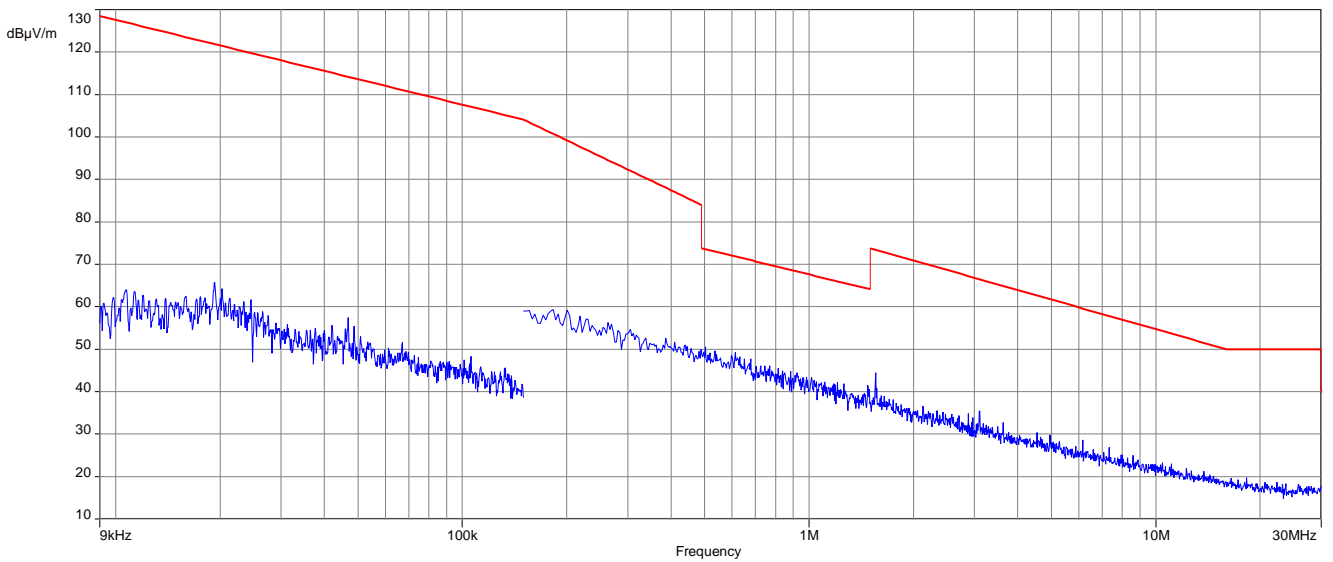

12.9 Spurious emissions radiated 30 MHz to 1 GHz

Description:

Measurement of the radiated spurious emissions in transmit mode. The EUT is set to single channel mode and the transmit frequencies are 2402 MHz, 2440 MHz and 2480 MHz.

Measurement parameters	
Detector	Peak / Quasi Peak
Sweep time	Auto
Resolution bandwidth	120 kHz
Video bandwidth	3 x RBW
Span	30 MHz to 1 GHz
Trace mode	Max hold
Measured modulation	GFSK
Test setup	See sub clause 8.1 A
Measurement uncertainty	See sub clause 9

Limits:

FCC	ISED	
TX spurious emissions radiated		
<p>In any 100 kHz bandwidth outside the frequency band in which the spread spectrum or digitally modulated intentional radiator is operating, the radio frequency power that is produced by the intentional radiator shall be at least 20 dB below that in the 100 kHz bandwidth within the band that contains the highest level of the desired power, based on either an RF conducted or a radiated measurement. Attenuation below the general limits specified in Section 15.209(a) is not required. In addition, radiated emissions which fall in the restricted bands, as defined in §15.205(a), must also comply with the radiated emission limits specified in §15.209(a) (see §15.205(c)).</p>		
§15.209		
Frequency (MHz)	Field strength (dB μ V/m)	Measurement distance
30 - 88	30.0	10
88 - 216	33.5	10
216 - 960	36.0	10
Above 960	54.0	3

Plots: Transmit mode

Plot 1: 30 MHz to 1 GHz, TX mode, vertical & horizontal polarization, valid for all channels of 1 Mbit/s

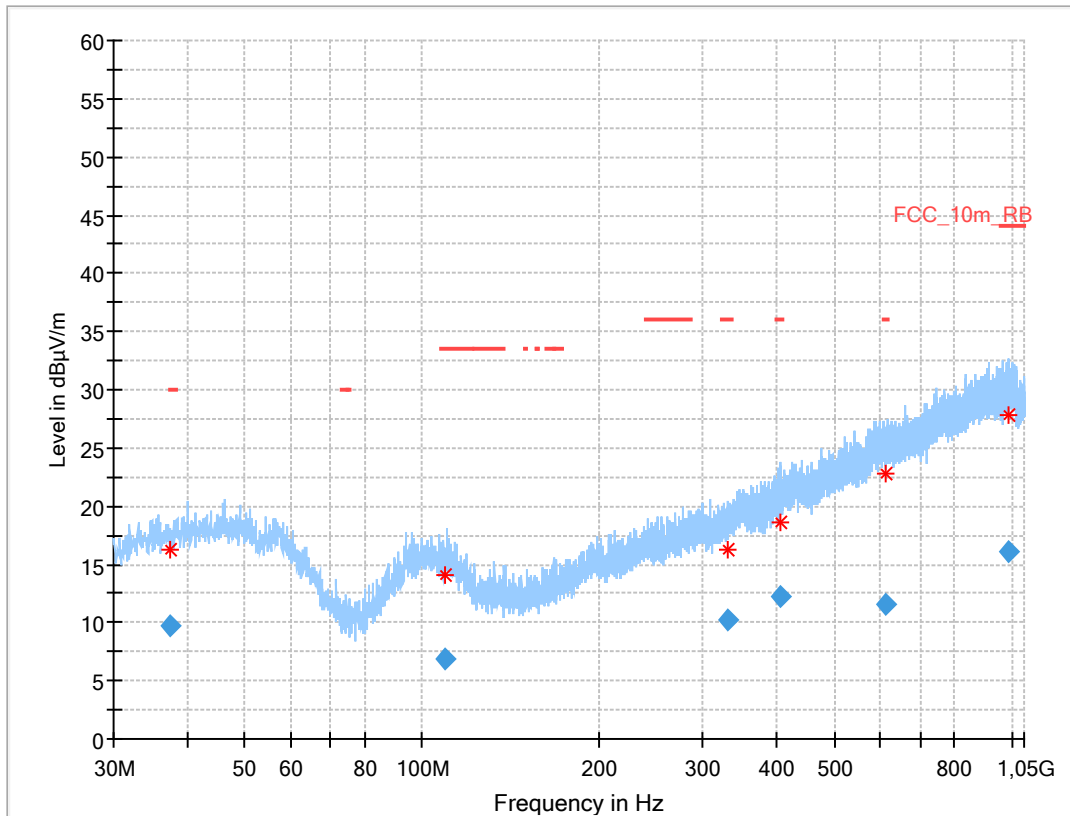

Final results:

Frequency (MHz)	QuasiPeak (dBµV/m)	Limit (dBµV/m)	Margin (dB)	Meas. Time (ms)	Bandwidth (kHz)	Height (cm)	Pol	Azimuth (deg)	Corr. (dB)
37.339	9.79	---	---	1000	120.0	400.0	V	225	15
109.640	6.89	33.5	26.6	1000	120.0	292.0	V	90	13
330.980	10.22	36.0	25.8	1000	120.0	129.0	H	0	16
406.387	12.31	36.0	23.7	1000	120.0	173.0	V	-17	18
611.115	11.57	36.0	24.4	1000	120.0	112.0	V	45	22
987.859	16.15	44.0	27.9	1000	120.0	262.0	H	225	26

Plot 2: 30 MHz to 1 GHz, TX mode, vertical & horizontal polarization, valid for all channels of 2 Mbit/s

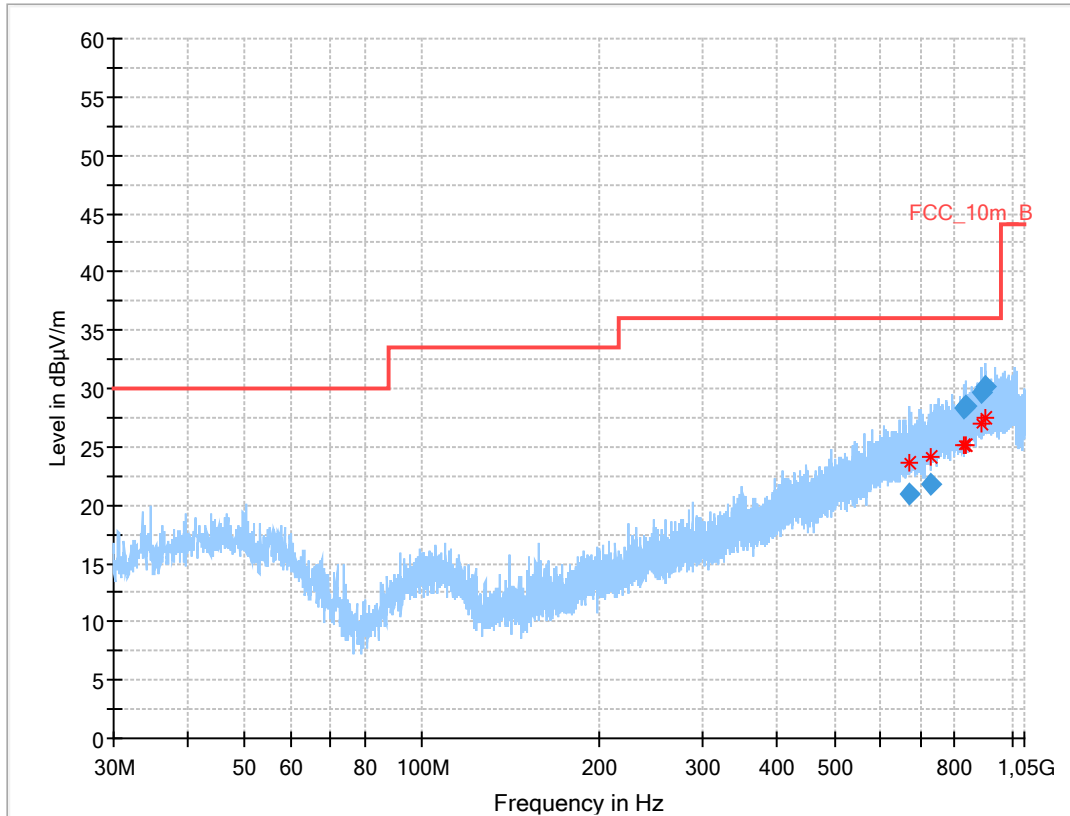

Final results:

Frequency (MHz)	QuasiPeak (dBµV/m)	Limit (dBµV/m)	Margin (dB)	Meas. Time (ms)	Bandwidth (kHz)	Height (cm)	Pol	Azimuth (deg)	Corr. (dB)
667.662	21.01	36.0	15.0	1000	120.0	195.0	H	232	22
730.059	21.85	36.0	14.2	1000	120.0	195.0	H	52	23
828.142	28.38	36.0	7.6	1000	120.0	195.0	H	232	24
832.990	28.45	36.0	7.6	1000	120.0	195.0	H	142	24
886.906	29.69	36.0	6.3	1000	120.0	110.0	H	3	25
905.100	30.09	36.0	5.9	1000	120.0	195.0	V	-15	26

12.10 Spurious emissions radiated above 1 GHz

Description:

Measurement of the radiated spurious emissions in transmit mode. The EUT is set to single channel mode and the transmit frequencies are 2402 MHz, 2440 MHz and 2480 MHz.

Measurement parameters	
Detector	Peak / RMS
Sweep time	Auto
Resolution bandwidth	1 MHz
Video bandwidth	3 x RBW
Span	1 GHz to 26 GHz
Trace mode	Max hold
Measured modulation	GFSK
Test setup	See sub clause 8.2 B (1 GHz - 18 GHz) See sub clause 8.3 A (18 GHz - 26 GHz)
Measurement uncertainty	See sub clause 9

Limits:

FCC		ISED	
TX spurious emissions radiated			
In any 100 kHz bandwidth outside the frequency band in which the spread spectrum or digitally modulated intentional radiator is operating, the radio frequency power that is produced by the intentional radiator shall be at least 20 dB below that in the 100 kHz bandwidth within the band that contains the highest level of the desired power, based on either an RF conducted or a radiated measurement. Attenuation below the general limits specified in Section 15.209(a) is not required. In addition, radiated emissions which fall in the restricted bands, as defined in §15.205(a), must also comply with the radiated emission limits specified in §15.209(a) (see §15.205(c)).			
§15.209			
Frequency (MHz)	Field strength (dB μ V/m)	Measurement distance	
Above 960	54.0 (Average)	3	
Above 960	74.0 (Peak)	3	

Results: Transmitter mode, 1 Mbit/s

TX spurious emissions radiated [dBµV/m]								
2402 MHz			2440 MHz			2480 MHz		
F [MHz]	Detector	Level [dBµV/m]	F [MHz]	Detector	Level [dBµV/m]	F [MHz]	Detector	Level [dBµV/m]
-/-	Peak	-/-	7319	Peak	57.7	7440	Peak	57.0
	AVG	-/-		AVG	52.3		AVG	51.8

Results: Transmitter mode, 2 Mbit/s

TX spurious emissions radiated [dBµV/m]								
2402 MHz			2440 MHz			2480 MHz		
F [MHz]	Detector	Level [dBµV/m]	F [MHz]	Detector	Level [dBµV/m]	F [MHz]	Detector	Level [dBµV/m]
-/-	Peak	-/-	7321	Peak	58.3	7438	Peak	57.2
	AVG	-/-		AVG	52.2		AVG	50.8

Plots: Transmitter mode

Plot 1: 1 GHz to 18 GHz, TX mode, 2402 MHz, vertical & horizontal polarization, 1 Mbit/s

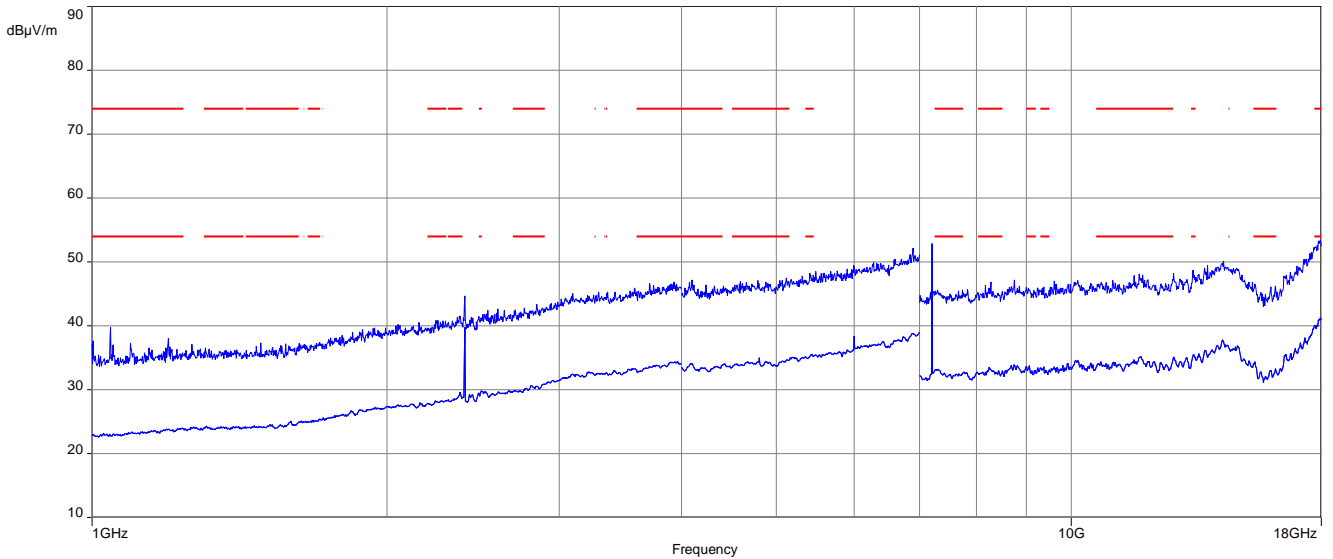

The carrier signal is notched with a 2.4 GHz band rejection filter.

Plot 2: 1 GHz to 18 GHz, TX mode, 2440 MHz, vertical & horizontal polarization, 1 Mbit/s

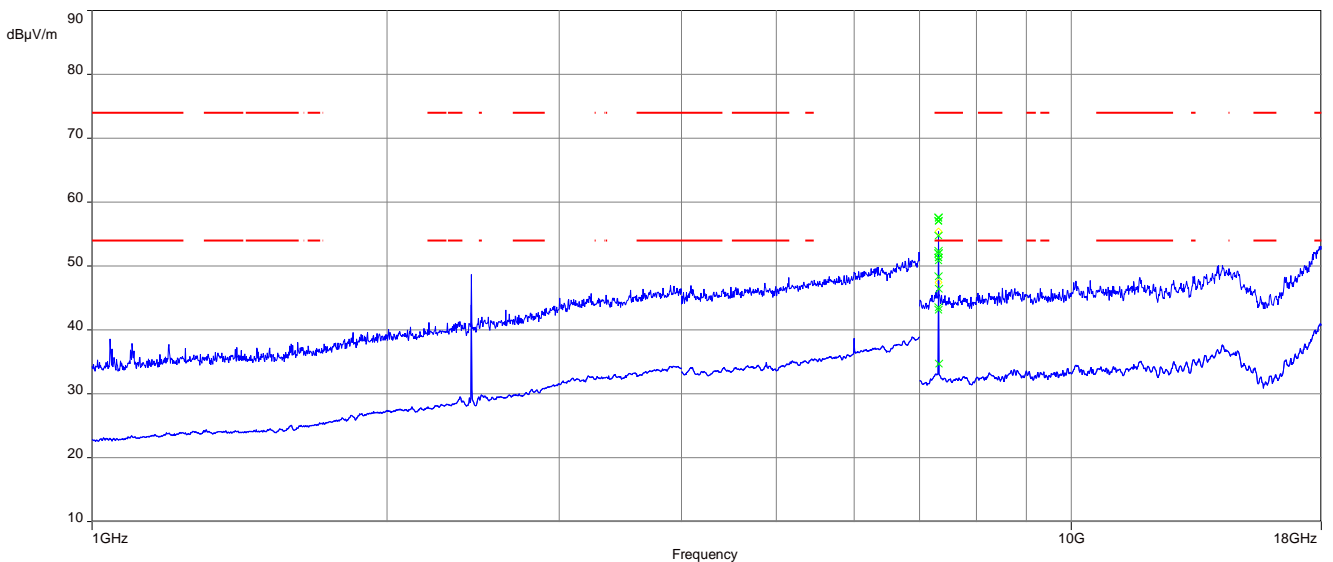

The carrier signal is notched with a 2.4 GHz band rejection filter.

Plot 3: 1 GHz to 18 GHz, TX mode, 2480 MHz, vertical & horizontal polarization, 1 Mbit/s

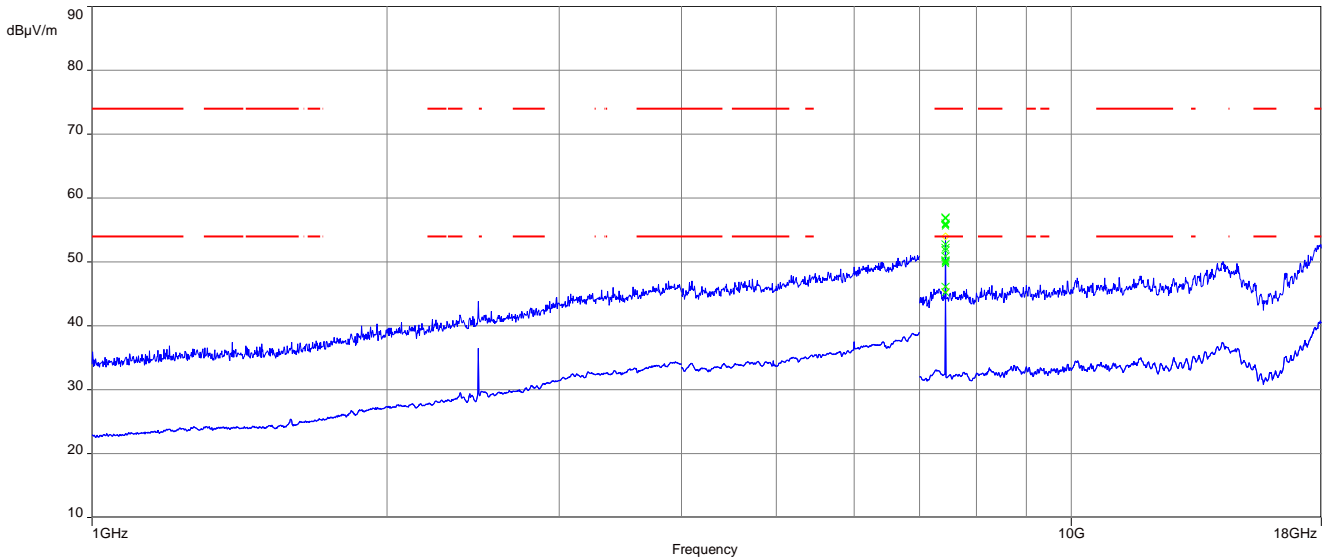

The carrier signal is notched with a 2.4 GHz band rejection filter.

Plot 4: 1 GHz to 18 GHz, TX mode, 2402 MHz, vertical & horizontal polarization, 2 Mbit/s

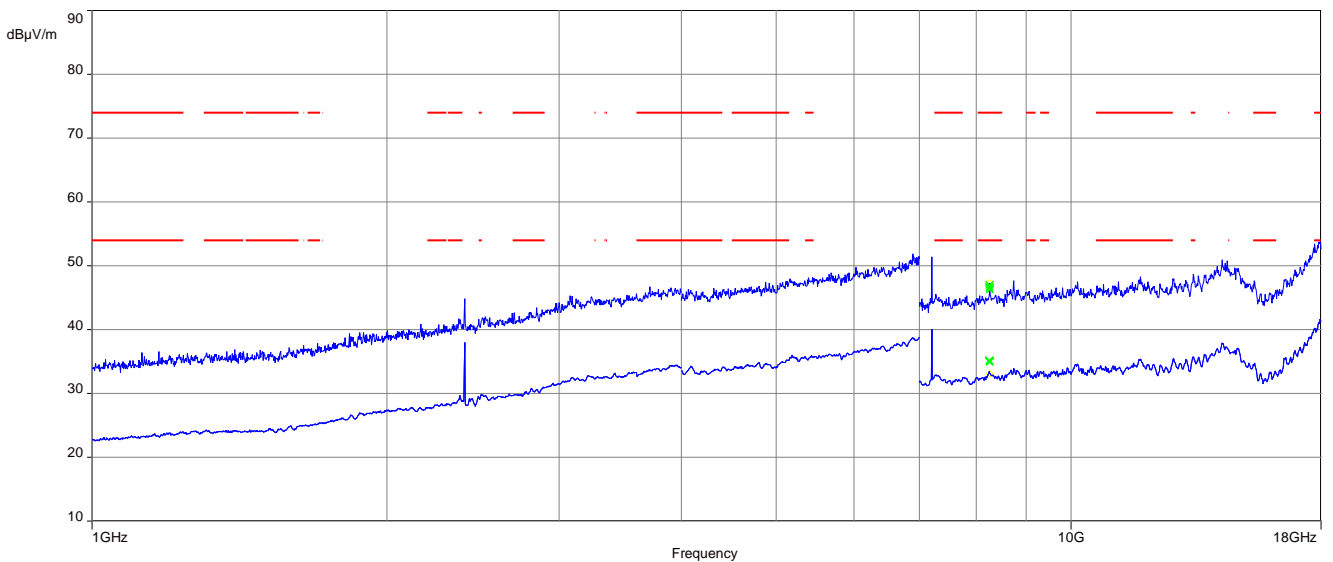

The carrier signal is notched with a 2.4 GHz band rejection filter.

Plot 5: 1 GHz to 18 GHz, TX mode, 2440 MHz, vertical & horizontal polarization, 2 Mbit/s

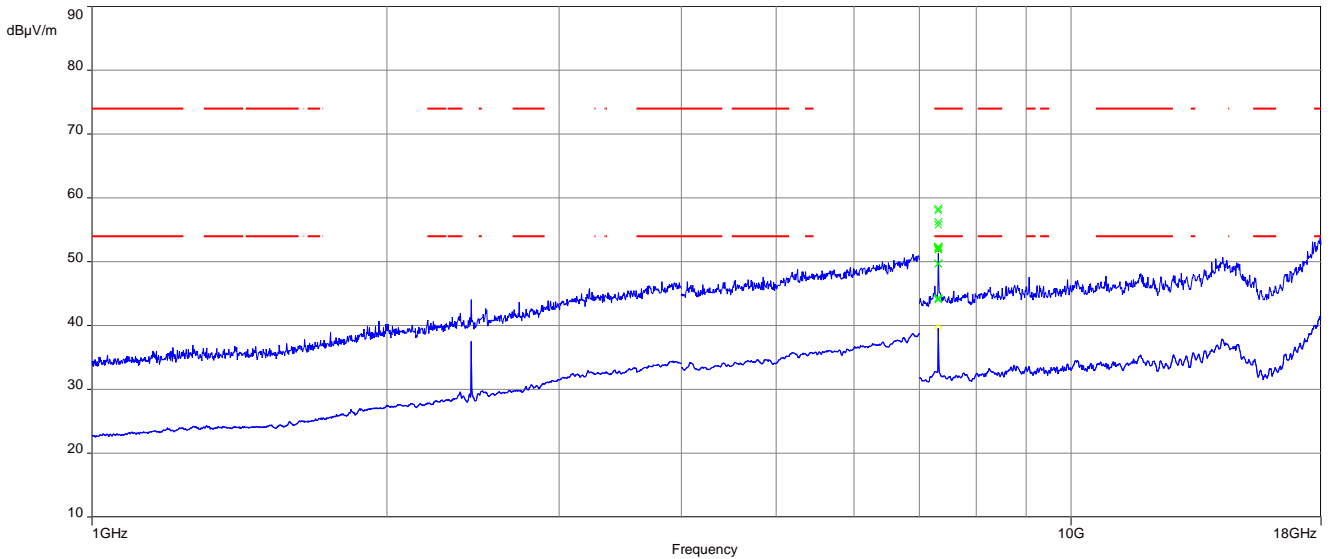

The carrier signal is notched with a 2.4 GHz band rejection filter.

Plot 6: 1 GHz to 18 GHz, TX mode, 2480 MHz, vertical & horizontal polarization, 2 Mbit/s

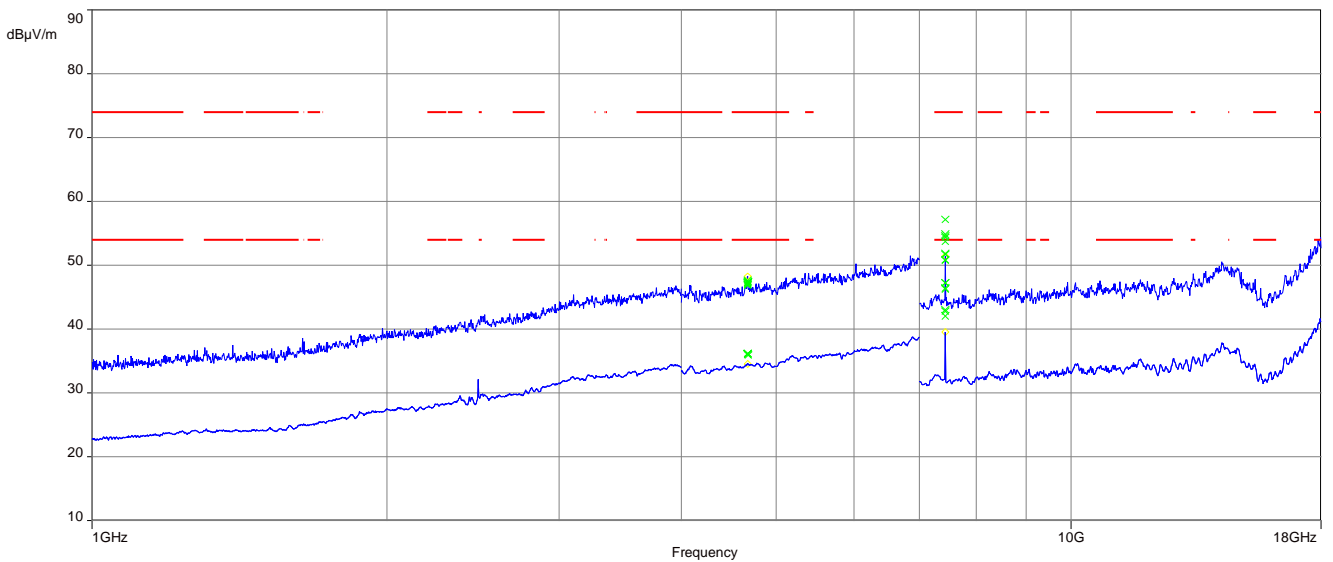

The carrier signal is notched with a 2.4 GHz band rejection filter.

Plot 7: 18 GHz to 26 GHz, TX mode, vertical & horizontal polarization, valid for all channels and modes

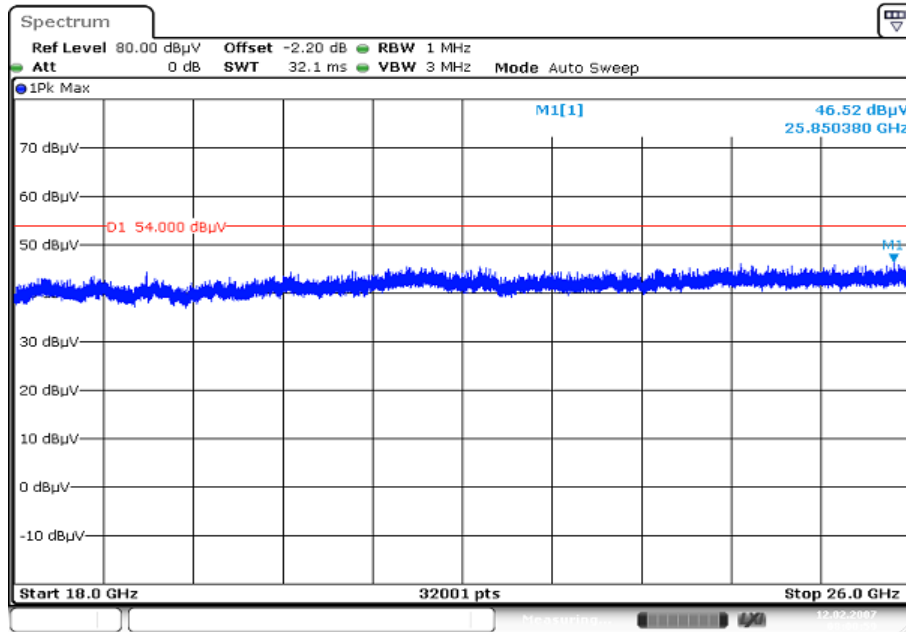

12.11 Spurious emissions conducted below 30 MHz (AC conducted)

Description:

Measurement of the conducted spurious emissions in transmit mode below 30 MHz. The EUT is set to single channel mode and the transmit frequency is 2440 MHz. This measurement is representative for all channels and modes. If critical peaks are found frequency 2402 MHz and 2480 MHz will be measured too. The measurement is performed in the mode with the highest output power. Both power lines, phase and neutral line, are measured. Found peaks are remeasured with average and quasi peak detection to show compliance to the limits.

Measurement parameters	
Detector	Peak - Quasi peak / average
Sweep time	Auto
Resolution bandwidth	F < 150 kHz: 200 Hz F > 150 kHz: 9 kHz
Video bandwidth	F < 150 kHz: 1 kHz F > 150 kHz: 100 kHz
Span:	9 kHz to 30 MHz
Trace mode:	Max hold
Test setup	See sub clause 8.5. A
Measurement uncertainty	See sub clause 9

Limits:

FCC		ISED	
TX spurious emissions conducted < 30 MHz			
Frequency (MHz)	Quasi-peak (dB μ V/m)	Average (dB μ V/m)	
0.15 – 0.5	66 to 56*	56 to 46*	
0.5 – 5	56	46	
5 – 30.0	60	50	

*Decreases with the logarithm of the frequency

Plots:

Plot 1: 150 kHz to 30 MHz, phase line

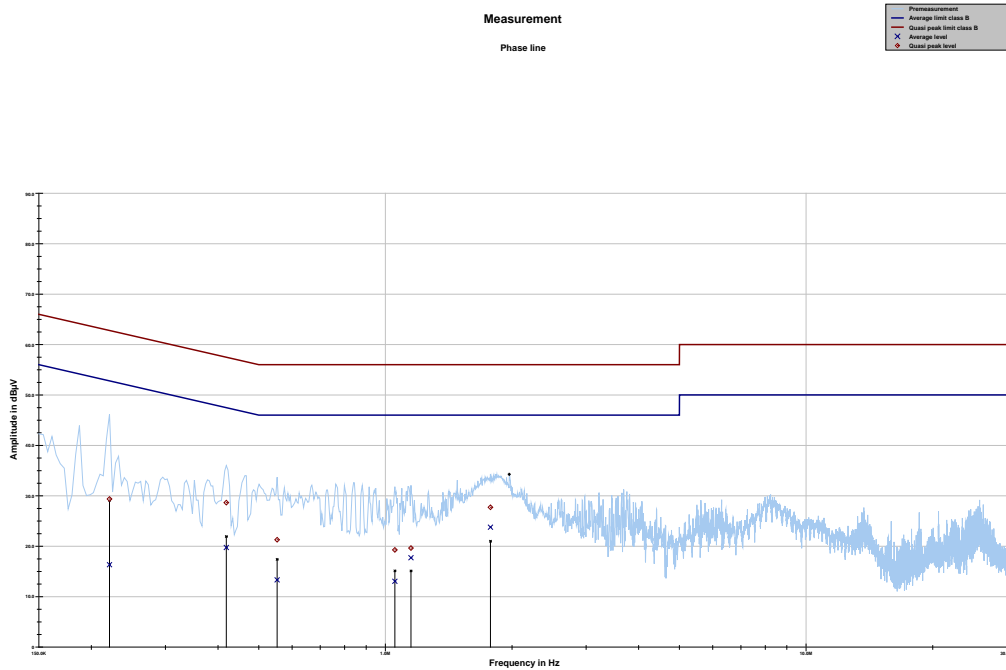

Project ID: 61942_02_09

Final results:

Frequency	Quasi peak level	Margin quasi peak	Limit QP	Average level	Margin average	Limit AV
MHz	dBµV	dB	dBµV	dBµV	dB	dBµV
0.176119	34.92	29.75	64.667	17.14	38.12	55.254
0.381337	22.44	35.81	58.250	15.83	33.56	49.390
0.493275	21.60	34.51	56.112	14.79	31.40	46.192
1.261912	21.17	34.83	56.000	15.32	30.68	46.000
1.474594	23.29	32.71	56.000	18.05	27.95	46.000
1.806675	27.49	28.51	56.000	23.37	22.63	46.000

Plot 2: 150 kHz to 30 MHz, neutral line

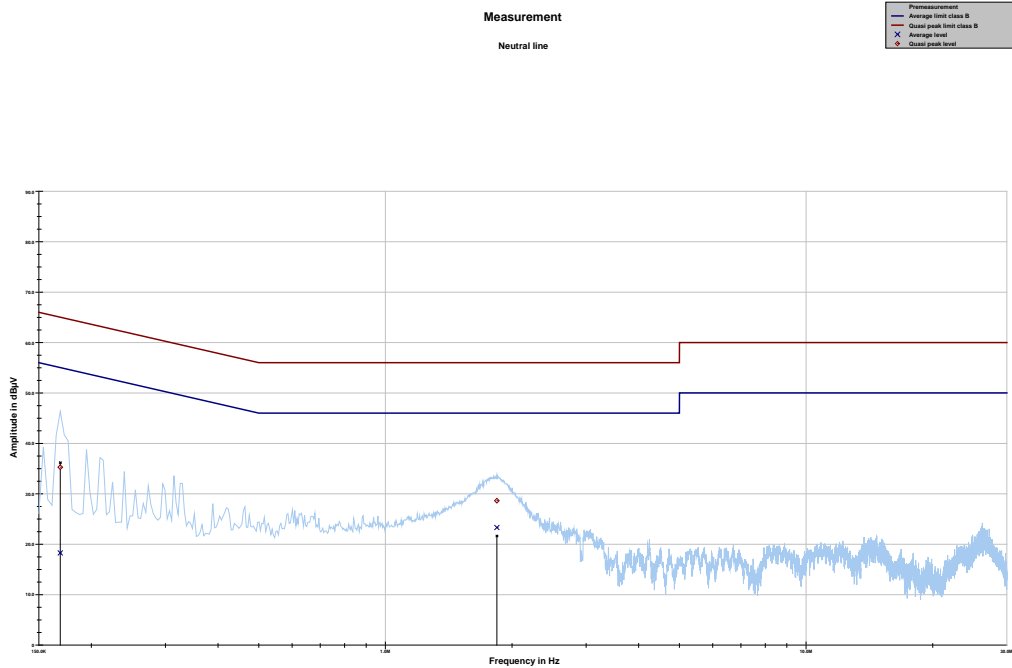

Project ID: 61942_02_09

Final results:

Frequency	Quasi peak level	Margin quasi peak	Limit QP	Average level	Margin average	Limit AV
MHz	dBµV	dB	dBµV	dBµV	dB	dBµV
0.150000	36.75	29.25	66.000	18.39	37.61	56.000
0.164925	35.84	29.37	65.212	18.64	36.94	55.574
1.847719	28.26	27.74	56.000	23.28	22.72	46.000

13 Glossary

EUT	Equipment under test
DUT	Device under test
UUT	Unit under test
GUE	GNSS User Equipment
ETSI	European Telecommunications Standards Institute
EN	European Standard
FCC	Federal Communications Commission
FCC ID	Company Identifier at FCC
IC	Industry Canada
PMN	Product marketing name
HMN	Host marketing name
HVIN	Hardware version identification number
FVIN	Firmware version identification number
EMC	Electromagnetic Compatibility
HW	Hardware
SW	Software
Inv. No.	Inventory number
S/N or SN	Serial number
C	Compliant
NC	Not compliant
NA	Not applicable
NP	Not performed
PP	Positive peak
QP	Quasi peak
AVG	Average
OC	Operating channel
OCW	Operating channel bandwidth
OBW	Occupied bandwidth
OOB	Out of band
DFS	Dynamic frequency selection
CAC	Channel availability check
OP	Occupancy period
NOP	Non occupancy period
DC	Duty cycle
PER	Packet error rate
CW	Clean wave
MC	Modulated carrier
WLAN	Wireless local area network
RLAN	Radio local area network
DSSS	Dynamic sequence spread spectrum
OFDM	Orthogonal frequency division multiplexing
FHSS	Frequency hopping spread spectrum
GNSS	Global Navigation Satellite System
C/N₀	Carrier to noise-density ratio, expressed in dB-Hz

14 Document history

Version	Applied changes	Date of release
-/-	Initial release	2023-08-23
A	Conducted tests repeated, 2 Mbit/s results added	2023-09-07

END OF TEST REPORT