



FCC TEST REPORT

Test report
On Behalf of
Dongguan Desheng Industrial Co., Ltd
For
G01 wireless game headset
Model No.: G01, G03, G05, G06, G07, G08, G09, G10, G11, G12,
G13, G15, G16, G17, G18, G19, G20

FCC ID: 2AXCY-G01RX

Prepared for : Dongguan Desheng Industrial Co., Ltd
Area A5, Shichong Industrial Park, Shipai Town, Dongguan City, China

Prepared By : Shenzhen HUAKE Testing Technology Co., Ltd.
1F, B2 Building, Junfeng Zhongcheng Zhizao Innovation Park, Fuhai Street,
Bao'an District, Shenzhen City, China

Date of Test: Sep. 03, 2020 ~ Sep. 14, 2020

Date of Report: Sep. 14, 2020

Report Number: HK2009142558-E



TEST RESULT CERTIFICATION

Applicant's name : Dongguan Desheng Industrial Co., Ltd
Address : Area A5, Shichong Industrial Park, Shipai Town, Dongguan City, China
Manufacture's Name..... : Dongguan Desheng Industrial Co., Ltd
Address : Area A5, Shichong Industrial Park, Shipai Town, Dongguan City, China

Product description

Trade Mark: XIBERIN
Product name : G01 wireless game headset
Model and/or type reference : G01, G03, G05, G06, G07, G08, G09, G10, G11, G12, G13, G15, G16, G17, G18, G19, G20
Standards : FCC Rules and Regulations Part 15 Subpart C Section 15.249
 ANSI C63.10: 2013

This publication may be reproduced in whole or in part for non-commercial purposes as long as the Shenzhen HUAKE Testing Technology Co., Ltd. is acknowledged as copyright owner and source of the material. Shenzhen HUAKE Testing Technology Co., Ltd. takes no responsibility for and will not assume liability for damages resulting from the reader's interpretation of the reproduced material due to its placement and context.

Date of Test..... :
Date (s) of performance of tests : **Sep. 03, 2020 ~ Sep. 14, 2020**
Date of Issue..... : **Sep. 14, 2020**
Test Result : **Pass**

Testing Engineer : Gary Qian
 (Gary Qian)
 Technical Manager : Eden Hu
 (Eden Hu)
 Authorized Signatory : Jason Zhou
 (Jason Zhou)



Table of Contents	Page
1 . TEST SUMMARY	5
2 . GENERAL INFORMATION	6
2.1 GENERAL DESCRIPTION OF EUT	6
2.2 Operation of EUT during testing	7
2.3 DESCRIPTION OF TEST SETUP	8
2.4 MEASUREMENT INSTRUMENTS LIST	9
3 . CONDUCTED EMISSIONS TEST	10
3.1 Conducted Power Line Emission Limit	10
3.2 Test Setup	10
3.3 Test Procedure	10
3.4 Test Result	11
4 RADIATED EMISSION TEST	13
4.1 Radiation Limit	13
4.2 Test Setup	13
4.3 Test Procedure	14
4.4 Test Result	14
5.1 Limits	20
5.2 Test Procedure	20
6 OCCUPIED BANDWIDTH MEASUREMENT	23
6.1 Test Setup	23
6.2 Test Procedure	23
6.3 Measurement Equipment Used	23
6.4 Test Result	23
7 ANTENNA REQUIREMENT	25
8 PHOTOGRAPH OF TEST	26
8.1 Radiated Emission	26
8.2 Conducted Emission	27
9 PHOTOS OF THE EUT	28



**** Modified History ****

Revision	Description	Issued Data	Remark
Revision 1.0	Initial Test Report Release	Sep. 14, 2020	Jason Zhou



1. TEST SUMMARY

1.1 TEST PROCEDURES AND RESULTS

DESCRIPTION OF TEST		RESULT
CONDUCTED EMISSIONS TEST	15.207	COMPLIANT
RADIATED EMISSION TEST	15.249(a) /15.209	COMPLIANT
BAND EDGE	15.249(d)/15.205	COMPLIANT
OCCUPIED BANDWIDTH MEASUREMENT	15.215 (c)	COMPLIANT
ANTENNA REQUIREMENT	15.203	COMPLIANT

1.2 TEST FACILITY

Test Firm : Shenzhen HUAKE Testing Technology Co., Ltd.

Address : 1F, B2 Building, Junfeng Zhongcheng Zhizao Innovation Park, Fuhai Street, Bao'an District, Shenzhen City, China

1.3 MEASUREMENT UNCERTAINTY

Measurement Uncertainty

Conducted Emission Expanded Uncertainty	=	2.23dB, k=2
Radiated emission expanded uncertainty(9kHz-30MHz)	=	3.08dB, k=2
Radiated emission expanded uncertainty(30MHz-1000MHz)	=	4.42dB, k=2
Radiated emission expanded uncertainty(Above 1GHz)	=	4.06dB, k=2



2. GENERAL INFORMATION

2.1 GENERAL DESCRIPTION OF EUT

Equipment	G01 wireless game headset
Model Name	G01
Serial Model	G03, G05, G06, G07, G08, G09, G10, G11, G12, G13, G15, G16, G17, G18, G19, G20
Model Difference	All model's the function, software and electric circuit are the same, only with a product model named different. Test sample model: G01
FCC ID	2AXCY-G01RX
Antenna Type	PCB Antenna
Antenna Gain	0 dBi
Operation frequency	2403-2478MHz
Number of Channels	26CH
Modulation Type	GFSK
Power Source	DC 3.7V from battery or DC 5V, 2A from USB or DC 3.7V from battery or DC 5V, 2A from TYPE-C
Power Rating	DC 3.7V from battery or DC 5V, 2A from USB or DC 3.7V from battery or DC 5V, 2A from TYPE-C



2.1.1 Carrier Frequency of Channels

Channel	Frequency (MHz)	Channel	Frequency (MHz)	Channel	Frequency (MHz)
1	2403	13	2439	25	2475
2	2406	14	2442	26	2478
3	2409	15	2445		
4	2412	16	2448		
5	2415	17	2451		
6	2418	18	2454		
7	2421	19	2457		
8	2424	20	2460		
9	2427	21	2463		
10	2430	22	2466		
11	2433	23	2469		
12	2436	24	2472		

2.2 Operation of EUT during testing

Operating Mode

The mode is used: **Transmitting mode**

Low Channel: 2403MHz

Middle Channel: 2439MHz

High Channel: 2478MHz



2.3 DESCRIPTION OF TEST SETUP

Operation of EUT during conducted testing and radiation below 1GHz testing:

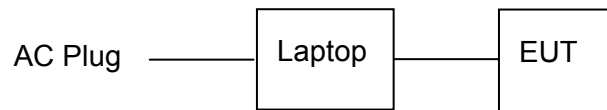

Operation of EUT during radiation above 1GHz testing



Laptop information
Model: TP00018A
Input: 20V, 3.25A/4.5A

The sample was placed (0.8m below 1GHz, 1.5m above 1GHz) above the ground plane of 3m chamber. Measurements in both horizontal and vertical polarities were performed. During the test, each emission was maximized by: having the EUT continuously working, investigated all operating modes, rotated about all 3 axis (X, Y & Z) and considered typical configuration to obtain worst position, manipulating interconnecting cables, rotating the turntable, varying antenna height from 1m to 4m in both horizontal and vertical polarizations. The emissions worst-case are shown in Test Results of the following pages. The worst case is X position



2.4 MEASUREMENT INSTRUMENTS LIST

Item	Equipment	Manufacturer	Model No.	Serial No.	Last Cal.	Cal. Interval
1.	L.I.S.N. Artificial Mains Network	R&S	ENV216	HKE-002	Dec. 26, 2019	1 Year
2.	Receiver	R&S	ESCI 7	HKE-010	Dec. 26, 2019	1 Year
3.	RF automatic control unit	Tonscend	JS0806-2	HKE-060	Dec. 26, 2019	1 Year
4.	Spectrum analyzer	R&S	FSP40	HKE-025	Dec. 26, 2019	1 Year
5.	Spectrum analyzer	Agilent	N9020A	HKE-048	Dec. 26, 2019	1 Year
6.	Preamplifier	Schwarzbeck	BBV 9743	HKE-006	Dec. 26, 2019	1 Year
7.	EMI Test Receiver	Rohde & Schwarz	ESCI 7	HKE-010	Dec. 26, 2019	1 Year
8.	Bilog Broadband Antenna	Schwarzbeck	VULB9163	HKE-012	Dec. 26, 2019	1 Year
9.	Loop Antenna	Schwarzbeck	FMZB 1519 B	HKE-014	Dec. 26, 2019	1 Year
10.	Horn Antenna	Schwarzbeck	9120D	HKE-013	Dec. 26, 2019	1 Year
11.	Pre-amplifier	EMCI	EMC051845 SE	HKE-015	Dec. 26, 2019	1 Year
12.	Pre-amplifier	Agilent	83051A	HKE-016	Dec. 26, 2019	1 Year
13.	EMI Test Software EZ-EMC	Tonscend	JY3120-B Version	HKE-083	Dec. 26, 2019	N/A
14.	Power Sensor	Agilent	E9300A	HKE-086	Dec. 26, 2019	1 Year
15.	Spectrum analyzer	Agilent	N9020A	HKE-048	Dec. 26, 2019	1 Year
16.	Signal generator	Agilent	N5182A	HKE-029	Dec. 26, 2019	1 Year
17.	Signal Generator	Agilent	83630A	HKE-028	Dec. 26, 2019	1 Year
18.	Shielded room	Shiel Hong	4*3*3	HKE-039	Dec. 26, 2017	3 Year
19.	Hight gain antenna	Schwarzbeck	LB-180400K F	HKE-054	Dec. 26, 2019	1 Year

3. CONDUCTED EMISSIONS TEST

3.1 Conducted Power Line Emission Limit

For unintentional device, according to § 15.107(a) Line Conducted Emission Limits is as following

Frequency (MHz)	Maximum RF Line Voltage (dBµV)			
	CLASS A		CLASS B	
	Q.P.	Ave.	Q.P.	Ave.
0.15 - 0.50	79	66	66-56*	56-46*
0.50 - 5.00	73	60	56	46
5.00 - 30.0	73	60	60	50

* Decreasing linearly with the logarithm of the frequency

For intentional device, according to §15.207(a) Line Conducted Emission Limit is same as above table.

3.2 Test Setup

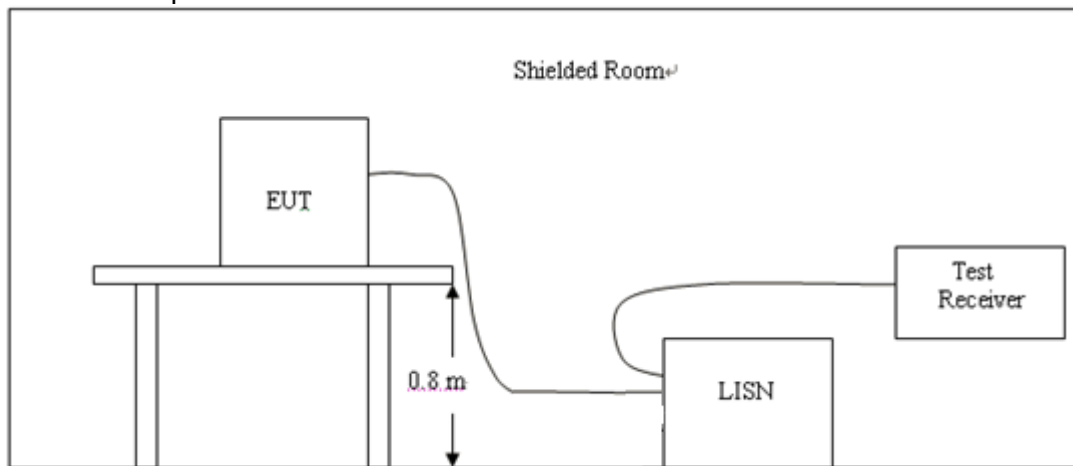

3.3 Test Procedure

- 1, The equipment was set up as per the test configuration to simulate typical actual usage per the user's manual. The EUT is a tabletop system, a wooden table with a height of 0.8 meters is used and is placed on the ground plane as per ANSI C63.10.
- 2, Support equipment, if needed, was placed as per ANSI C63.10.
- 3, All I/O cables were positioned to simulate typical actual usage as per ANSI C63.10.
- 4, If a EUT received DC power from the USB Port of Notebook PC, the PC's adapter received AC120V/60Hz power through a Line Impedance Stabilization Network (LISN) which supplied power source and was grounded to the ground plane.
- 5, All support equipments received AC power from a second LISN, if any.
- 6, The EUT test program was started. Emissions were measured on each current carrying line of the EUT using a spectrum Analyzer / Receiver connected to the LISN powering the EUT. The LISN has two monitoring points: Line 1 (Hot Side) and Line 2 (Neutral Side). Two scans were taken: one with Line 1 connected to Analyzer / Receiver and Line 2 connected to a 50 ohm load; the second scan had Line 1 connected to a 50 ohm load and Line 2 connected to the Analyzer / Receiver.
- 7, Analyzer / Receiver scanned from 150 KHz to 30MHz for emissions in each of the test modes.



3.4 Test Result

PASS

All the test modes completed for test. only the worst result of High Channel was reported as below:

Test Specification: Line

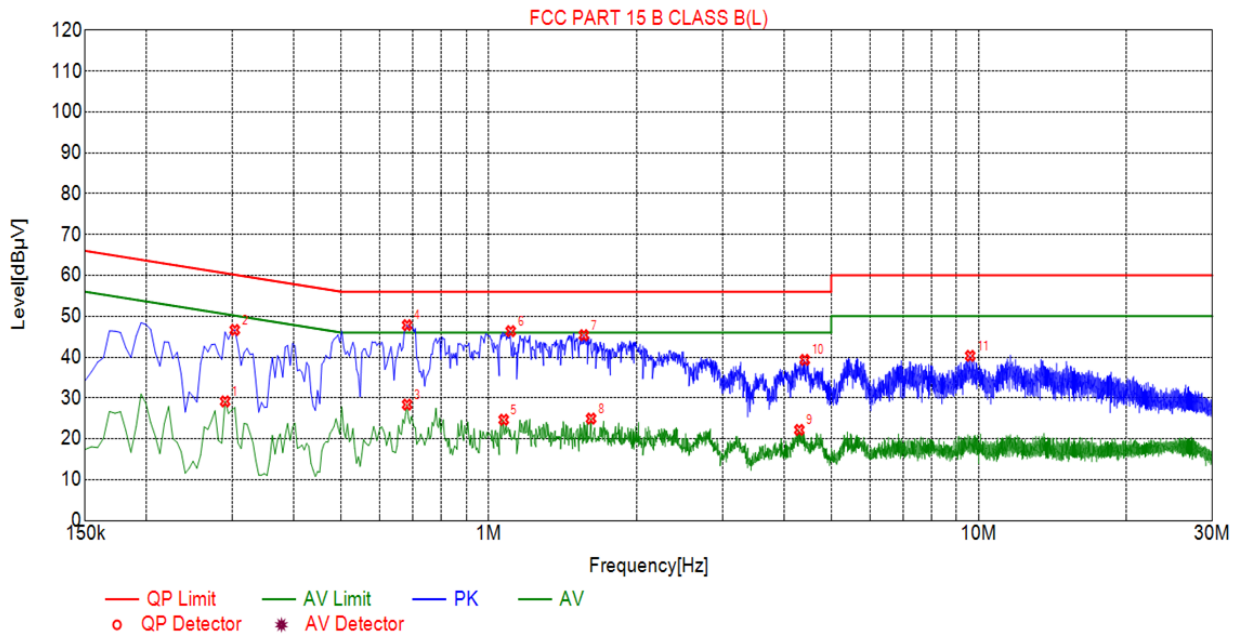

Suspected List								
NO.	Freq. [MHz]	Level [dBµV]	Factor [dB]	Limit [dBµV]	Margin [dB]	Reading [dBµV]	Detector	Type
1	0.2895	29.16	20.03	50.54	21.38	9.13	AV	L
2	0.3030	46.65	20.04	60.16	13.51	26.61	PK	L
3	0.6810	28.38	20.05	46.00	17.62	8.33	AV	L
4	0.6810	47.82	20.05	56.00	8.18	27.77	PK	L
5	1.0725	24.67	20.07	46.00	21.33	4.60	AV	L
6	1.1085	46.35	20.08	56.00	9.65	26.27	PK	L
7	1.5630	45.37	20.11	56.00	10.63	25.26	PK	L
8	1.6170	24.95	20.11	46.00	21.05	4.84	AV	L
9	4.3035	22.19	20.25	46.00	23.81	1.94	AV	L
10	4.4160	39.32	20.25	56.00	16.68	19.07	PK	L
11	9.6090	40.31	20.08	60.00	19.69	20.23	PK	L

Remark: Margin = Limit – Level

Correction factor = Cable lose + LISN insertion loss

Level=Test receiver reading + correction factor



Test Specification: Neutral

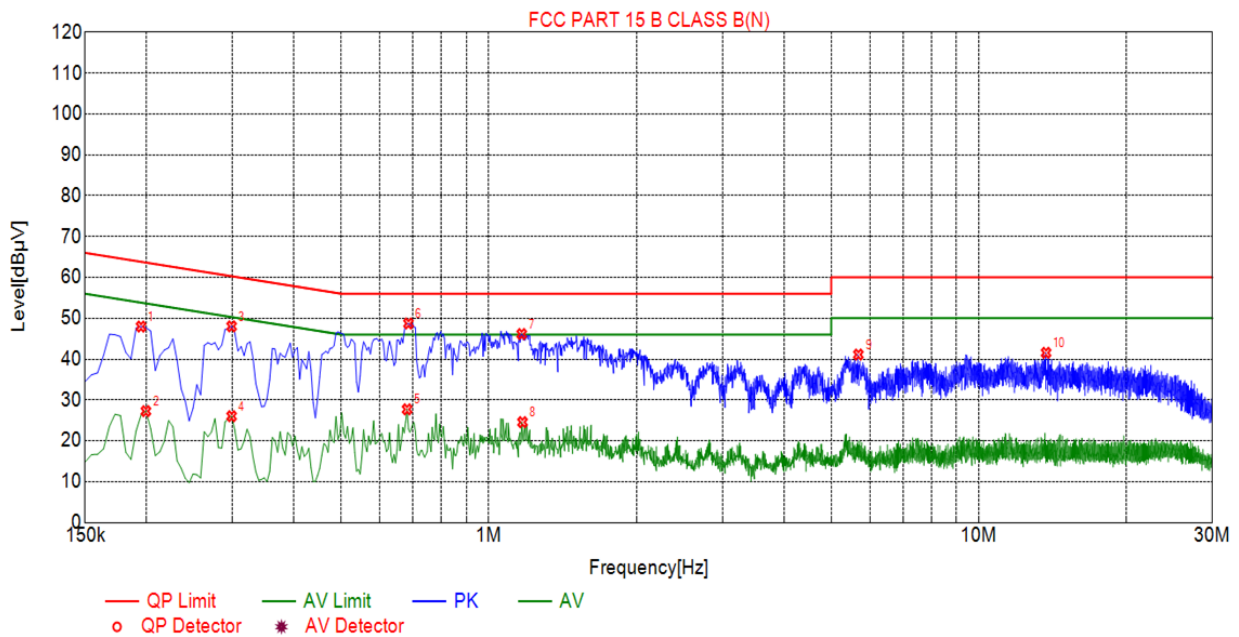

Suspected List								
NO.	Freq. [MHz]	Level [dBµV]	Factor [dB]	Limit [dBµV]	Margin [dB]	Reading [dBµV]	Detector	Type
1	0.1950	47.97	20.03	63.82	15.85	27.94	PK	N
2	0.1995	27.27	20.03	53.63	26.36	7.24	AV	N
3	0.2985	48.02	20.04	60.28	12.26	27.98	PK	N
4	0.2985	26.03	20.04	50.28	24.25	5.99	AV	N
5	0.6810	27.71	20.05	46.00	18.29	7.66	AV	N
6	0.6855	48.72	20.05	56.00	7.28	28.67	PK	N
7	1.1670	46.14	20.09	56.00	9.86	26.05	PK	N
8	1.1715	24.57	20.09	46.00	21.43	4.48	AV	N
9	5.6805	41.12	20.24	60.00	18.88	20.88	PK	N
10	13.7265	41.55	19.96	60.00	18.45	21.59	PK	N

Remark: Margin = Limit – Level

Correction factor = Cable lose + LISN insertion loss

Level=Test receiver reading + correction factor

4 RADIATED EMISSION TEST

4.1 Radiation Limit

For unintentional device, according to § 15.109(a), except for Class A digital devices, the field strength of radiated emissions from unintentional radiators at a distance of 3 meters shall not exceed the following values:

Frequency (MHz)	Distance (Meters)	Radiated (dB μ V/m)	Radiated (μ V/m)
0.009-0.490	300	$20\log 2400/F$ (kHz)	$2400/F$ (kHz)
0.490-1.705	30	$20\log 24000/F$ (kHz)	$24000/F$ (kHz)
1.705-30	30	$20\log 30$	30
30-88	3	40	100
88-216	3	43.5	150
216-960	3	46	200
Above 960	3	54	500

For intentional device, according to § 15.209(a), the general requirement of field strength of radiated emissions from intentional radiators at a distance of 3 meters shall not exceed the above table.

4.2 Test Setup

(1) Radiated Emission Test-Up Frequency Below 30MHz

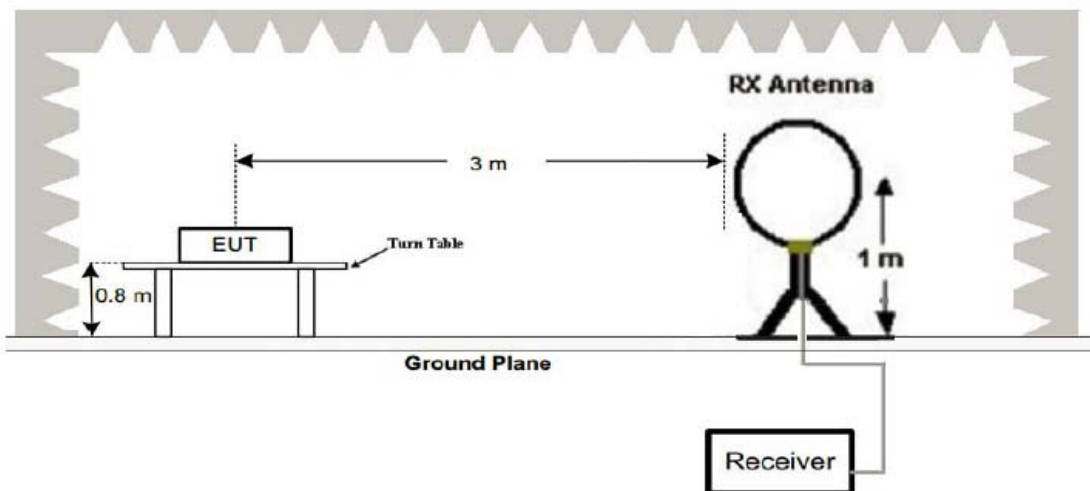

(2) Radiated Emission Test-Up Frequency 30MHz~1GHz

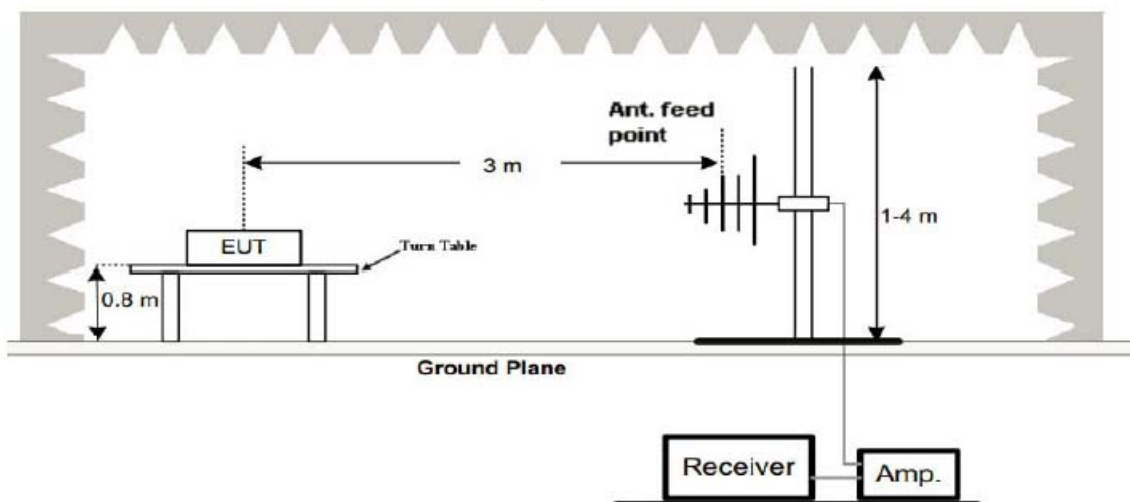

(3) Radiated Emission Test-Up Frequency Above 1GHz

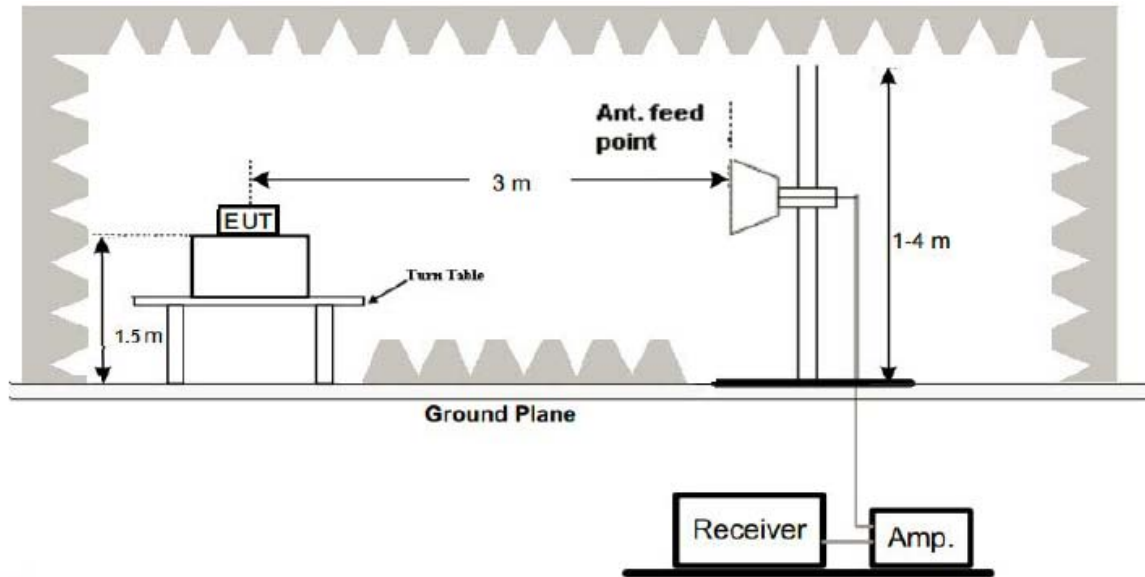

4.3 Test Procedure

1. Below 1GHz measurement the EUT is placed on turntable which is 0.8m above ground plane. And above 1GHz measurement EUT was placed on low permittivity and low tangent turn table which is 1.5m above ground plane.
2. The turntable shall be rotated for 360 degrees to determine the position of maximum emission level.
3. EUT is set 3m away from the receiving antenna, which is varied from 1m to 4m to find out the highest emissions.
4. Maximum procedure was performed on the six highest emissions to ensure EUT compliance.
5. And also, each emission was to be maximized by changing the polarization of receiving antenna both horizontal and vertical.
6. Repeat above procedures until the measurements for all frequencies are complete.
7. The test frequency range from 9KHz to 25GHz per FCC PART 15.33(a).

Note:

For battery operated equipment, the equipment tests shall be performed using a new battery.

4.4 Test Result

PASS

All the test modes completed for test. The worst case of Radiated Emission is CH 01; the test data of this mode was reported.



Below 1GHz Test Results:

Antenna polarity: H

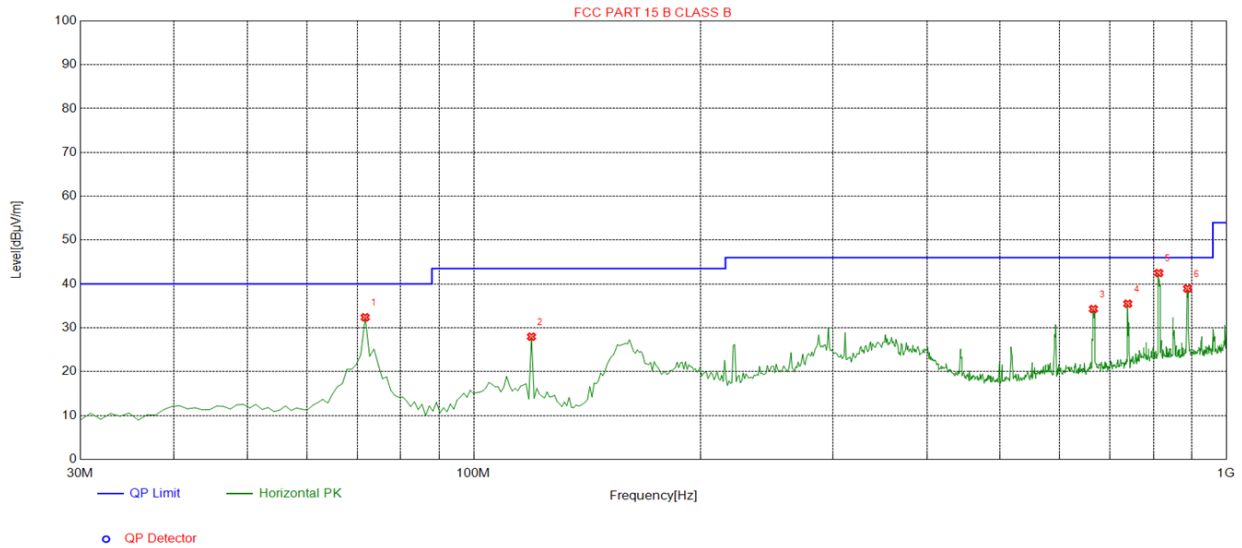

Suspected List									
NO.	Freq. [MHz]	Factor [dB]	Reading [dBµV/m]	Level [dBµV/m]	Limit [dBµV/m]	Margin [dB]	Height [cm]	Angle [°]	Polarity
1	71.7518	-17.99	50.38	32.39	40.00	7.61	100	12	Horizontal
2	119.3293	-16.99	44.96	27.97	43.50	15.53	100	80	Horizontal
3	665.9860	-4.81	39.09	34.28	46.00	11.72	100	76	Horizontal
4	739.7798	-4.14	39.63	35.49	46.00	10.51	100	284	Horizontal
5	813.5736	-2.87	45.36	42.49	46.00	3.51	100	290	Horizontal
6	888.3383	-1.91	40.86	38.95	46.00	7.05	100	293	Horizontal

Remark: Factor = Cable loss + Antenna factor – Pre-amplifier; Level = Reading + Factor; Margin = Limit – Level



Antenna polarity: V

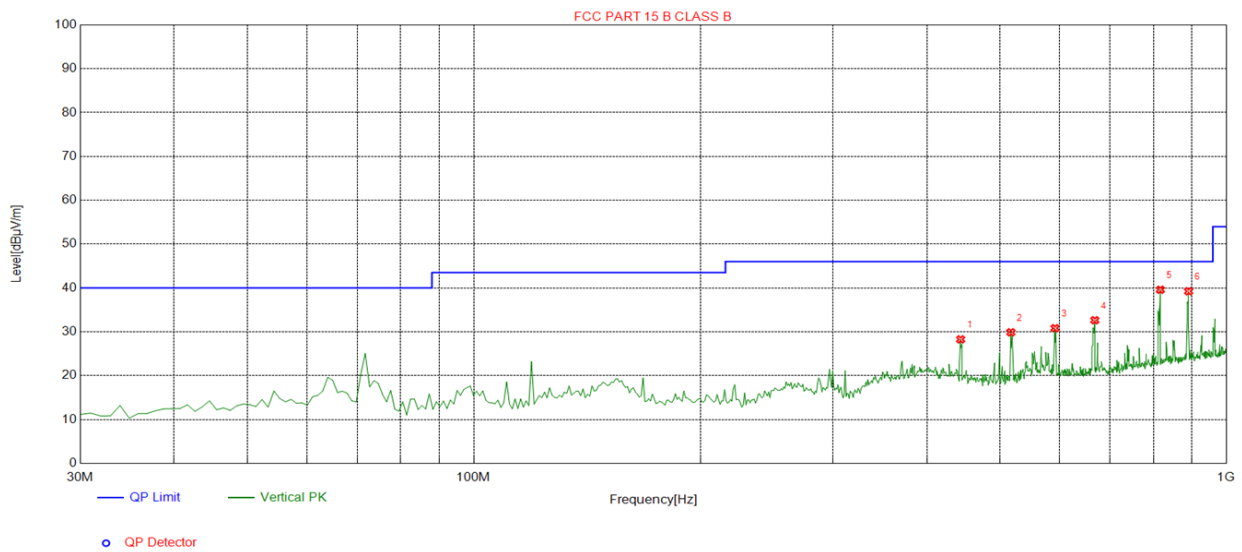

Suspected List									
NO.	Freq. [MHz]	Factor [dB]	Reading [dBµV/m]	Level [dBµV/m]	Limit [dBµV/m]	Margin [dB]	Height [cm]	Angle [°]	Polarity
1	443.6336	-9.26	37.53	28.27	46.00	17.73	100	281	Vertical
2	517.4274	-7.80	37.68	29.88	46.00	16.12	100	242	Vertical
3	592.1922	-6.63	37.45	30.82	46.00	15.18	100	214	Vertical
4	668.8989	-4.63	37.27	32.64	46.00	13.36	100	91	Vertical
5	817.4575	-2.77	42.36	39.59	46.00	6.41	100	319	Vertical
6	891.2513	-1.87	41.11	39.24	46.00	6.76	100	313	Vertical

Remark: Factor = Cable loss + Antenna factor – Pre-amplifier; Level = Reading + Factor; Margin = Limit – Level

Harmonics and Spurious Emissions

Frequency Range (9 kHz-30MHz)

Frequency (MHz)	Level@3m (dBµV/m)	Limit@3m (dBµV/m)
--	--	--
--	--	--
--	--	--
--	--	--

Note: 1. Emission Level = Reading + Cable loss + Antenna factor - Amp factor

2. The emission levels are 20 dB below the limit value, which are not reported. It is deemed to comply with the requirement



Above 1 GHz Test Results:
CH Low (2403MHz)

Horizontal:

Frequency	Meter Reading	Factor	Emission Level	Limits	Margin	Detector Type
(MHz)	(dB μ V)	(dB)	(dB μ V/m)	(dB μ V/m)	(dB)	
2403	108.24	-5.84	102.4	114	-11.6	peak
2403	87.33	-5.84	81.49	94	-12.51	AVG
4806	59.52	-3.64	55.88	74	-18.12	peak
4806	47.44	-3.64	43.8	54	-10.2	AVG
7209	55.32	-0.95	54.37	74	-19.63	peak
7209	43.11	-0.95	42.16	54	-11.84	AVG

Remark: Factor = Antenna Factor + Cable Loss – Pre-amplifier.

Vertical:

Frequency	Meter Reading	Factor	Emission Level	Limits	Margin	Detector Type
(MHz)	(dB μ V)	(dB)	(dB μ V/m)	(dB μ V/m)	(dB)	
2403	111.42	-5.84	105.58	114	-8.42	peak
2403	83.33	-5.84	77.49	94	-16.51	AVG
4806	57.53	-3.64	53.89	74	-20.11	peak
4806	46.12	-3.64	42.48	54	-11.52	AVG
7209	55.33	-0.95	54.38	74	-19.62	peak
7209	42.42	-0.95	41.47	54	-12.53	AVG

Remark: Factor = Antenna Factor + Cable Loss – Pre-amplifier.



CH Middle (2439MHz)

Horizontal:

Frequency	Meter Reading	Factor	Emission Level	Limits	Margin	Detector Type
(MHz)	(dB μ V)	(dB)	(dB μ V/m)	(dB μ V/m)	(dB)	
2439	108.13	-5.71	102.42	114	-11.58	peak
2439	80.33	-5.71	74.62	94	-19.38	AVG
4878	56.55	-3.51	53.04	74	-20.96	peak
4878	46.32	-3.51	42.81	54	-11.19	AVG
7317	57.41	-0.82	56.59	74	-17.41	peak
7317	42.22	-0.82	41.4	54	-12.6	AVG

Remark: Factor = Antenna Factor + Cable Loss – Pre-amplifier.

Vertical:

Frequency	Meter Reading	Factor	Emission Level	Limits	Margin	Detector Type
(MHz)	(dB μ V)	(dB)	(dB μ V/m)	(dB μ V/m)	(dB)	
2439	104.33	-5.71	98.62	114	-15.38	peak
2439	84.42	-5.71	78.71	94	-15.29	AVG
4878	56.22	-3.51	52.71	74	-21.29	peak
4878	47.41	-3.51	43.9	54	-10.1	AVG
7317	55.33	-0.82	54.51	74	-19.49	peak
7317	42.52	-0.82	41.7	54	-12.3	AVG

Remark: Factor = Antenna Factor + Cable Loss – Pre-amplifier.



CH High (2478MHz)

Horizontal:

Frequency	Meter Reading	Factor	Emission Level	Limits	Margin	Detector Type
(MHz)	(dB μ V)	(dB)	(dB μ V/m)	(dB μ V/m)	(dB)	
2478	105.44	-5.65	99.79	114	-14.21	peak
2478	82.32	-5.65	76.67	94	-17.33	AVG
4956	55.44	-3.43	52.01	74	-21.99	peak
4956	45.64	-3.43	42.21	54	-11.79	AVG
7434	56.72	-0.75	55.97	74	-18.03	peak
7434	41.33	-0.75	40.58	54	-13.42	AVG

Remark: Factor = Antenna Factor + Cable Loss – Pre-amplifier.

Vertical:

Frequency	Meter Reading	Factor	Emission Level	Limits	Margin	Detector Type
(MHz)	(dB μ V)	(dB)	(dB μ V/m)	(dB μ V/m)	(dB)	
2478	106.29	-5.65	100.64	114	-13.36	peak
2478	82.33	-5.65	76.68	94	-17.32	AVG
4956	56.53	-3.43	53.1	74	-20.9	peak
4956	45.66	-3.43	42.23	54	-11.77	AVG
7434	55.43	-0.75	54.68	74	-19.32	peak
7434	39.32	-0.75	38.57	54	-15.43	AVG

Remark: Factor = Antenna Factor + Cable Loss – Pre-amplifier.

Remark :

- (1) Measuring frequencies from 1 GHz to the 25 GHz ◦
- (2) "F" denotes fundamental frequency; "H" denotes spurious frequency. "E" denotes band edge frequency.
- (3) * denotes emission frequency which appearing within the Restricted Bands specified in provision of 15.205, then the general radiated emission limits in 15.209 apply.
- (4) The emissions are attenuated more than 20dB below the permissible limits are not record in the report.
- (5) The IF bandwidth of EMI Test Receiver between 30MHz to 1GHz was 120KHz, 1 MHz for measuring above 1 GHz, below 30MHz was 10KHz. The resolution bandwidth of test receiver/spectrum analyzer is 1MHz and video bandwidth is 3MHz for peak measurement with peak detector at frequency above 1GHz. The resolution bandwidth of test receiver/spectrum analyzer is 1MHz and video bandwidth is 10Hz for Average measurement with peak detection at frequency above 1GHz.
- (6) When the test results of Peak Detected below the limits of Average Detected, the Average Detected is not need completed. For example: Top Channel at Fundamental 73.16dBuV/m(PK Value) <93.98(AV Limit), at harmonic 53.20 dBuV/m(PK Value) <54 dBuV/m(AV Limit), the Average Detected not need to completed.
- (7) All modes of operation were investigated and the worst-case emissions are reported.



5 BAND EDGE

5.1 Limits

FCC PART 15.249(d) Emissions radiated outside of the specified frequency bands, except for harmonics, shall be attenuated by at least 50 dB below the level of the fundamental or to the general radiated emission limits in §15.209, whichever is the lesser attenuation.

5.2 Test Procedure

The band edge compliance of RF radiated emission should be measured by following the guidance in ANSI C63.10 with respect to maximizing the emission by rotating the EUT, measuring the emission while the EUT is situated in three orthogonal planes (if appropriate), adjusting the measurement antenna height and polarization etc. Set RBW to 100KHz and VBM to 300KHz to measure the peak field strength and set RBW to 1MHz and VBW to 10Hz to measure the average radiated field strength. The conducted RF band edge was measured by using a spectrum analyzer. Set span wide enough to capture the highest in-band emission and the emission at the band edge. Set RBW to 100 KHz and VBW to 300 KHz, to measure the conducted peak band edge.



5.3 Test Result

PASS

Radiated Band Edge Test:

Operation Mode: TX CH Low (2403MHz)

Horizontal (Worst case)

Frequency	Meter Reading	Factor	Emission Level	Limits	Margin	Detector Type
(MHz)	(dB μ V)	(dB)	(dB μ V/m)	(dB μ V/m)	(dB)	
2310	58.23	-5.81	52.42	74	-21.58	peak
2310	/	-5.81	/	54	/	AVG
2390	52.22	-5.84	46.38	74	-27.62	peak
2390	/	-5.84	/	54	/	AVG
2400	51.43	-5.84	45.59	74	-28.41	peak
2400	/	-5.84	/	54	/	AVG

Remark: Factor = Antenna Factor + Cable Loss – Pre-amplifier.

Vertical:

Frequency	Meter Reading	Factor	Emission Level	Limits	Margin	Detector Type
(MHz)	(dB μ V)	(dB)	(dB μ V/m)	(dB μ V/m)	(dB)	
2310	55.22	-5.81	49.41	74	-24.59	peak
2310	/	-5.81	/	54	/	AVG
2390	52.54	-5.84	46.7	74	-27.3	peak
2390	/	-5.84	/	54	/	AVG
2400	55.33	-5.84	49.49	74	-24.51	peak
2400	/	-5.84	/	54	/	AVG

Remark: Factor = Antenna Factor + Cable Loss – Pre-amplifier.



Operation Mode: TX CH High (2478MHz)

Horizontal (Worst case)

Frequency	Reading Result	Factor	Emission Level	Limits	Margin	Detector Type
(MHz)	(dB μ V)	(dB)	(dB μ V/m)	(dB μ V/m)	(dB)	
2483.50	56.22	-5.65	50.57	74	-23.43	peak
2483.50	/	-5.65	/	54	/	AVG
2500.00	53.43	-5.65	47.78	74	-26.22	peak
2500.00	/	-5.65	/	54	/	AVG

Remark: Factor = Antenna Factor + Cable Loss – Pre-amplifier.

Vertical:

Frequency	Reading Result	Factor	Emission Level	Limits	Margin	Detector Type
(MHz)	(dB μ V)	(dB)	(dB μ V/m)	(dB μ V/m)	(dB)	
2483.50	56.63	-5.65	50.98	74	-23.02	peak
2483.50	/	-5.65	/	54	/	AVG
2500.00	52.32	-5.65	46.67	74	-27.33	peak
2500.00	/	-5.65	/	54	/	AVG

Remark: Factor = Antenna Factor + Cable Loss – Pre-amplifier.

Remark: All the other emissions not reported were too low to read and deemed to comply with FCC limit.



6 OCCUPIED BANDWIDTH MEASUREMENT

6.1 Test Setup

Same as Radiated Emission Measurement

6.2 Test Procedure

1. The EUT was placed on a turn table which is 0.8m above ground plane.
2. Set EUT as normal operation.
3. Based on ANSI C63.10 section 6.9.2: RBW= 100KHz. VBW= 300 KHz, Span=12MHz.
4. The useful radiated emission from the EUT was detected by the spectrum analyser with peak detector.

6.3 Measurement Equipment Used

Same as Radiated Emission Measurement

6.4 Test Result

PASS

Frequency	20dB Bandwidth (MHz)	Result
2403 MHz	3.533	PASS
2439 MHz	3.917	PASS
2478 MHz	3.595	PASS

CH: 2403MHz

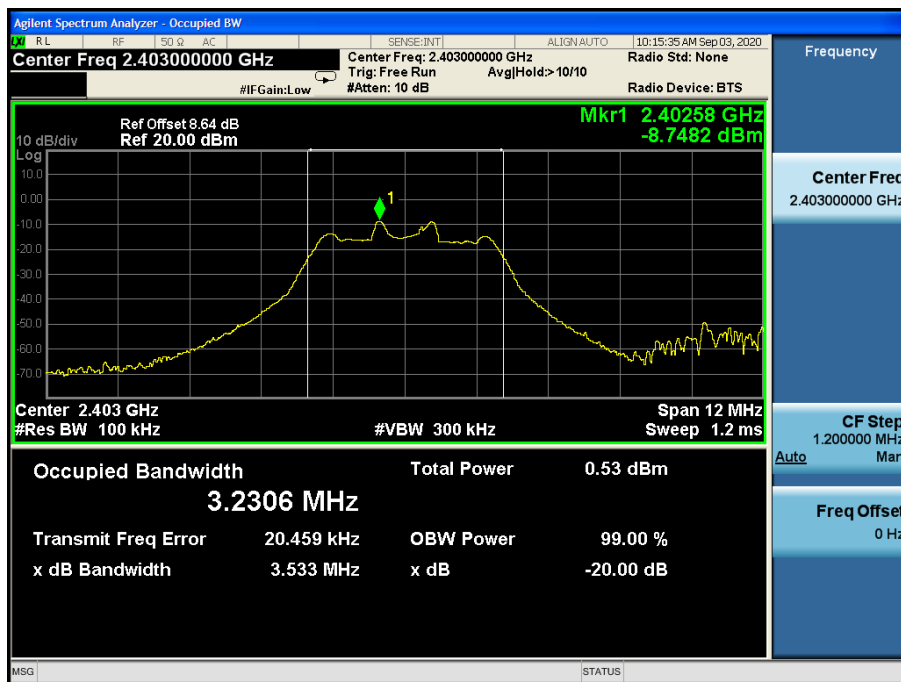



CH: 2439MHz

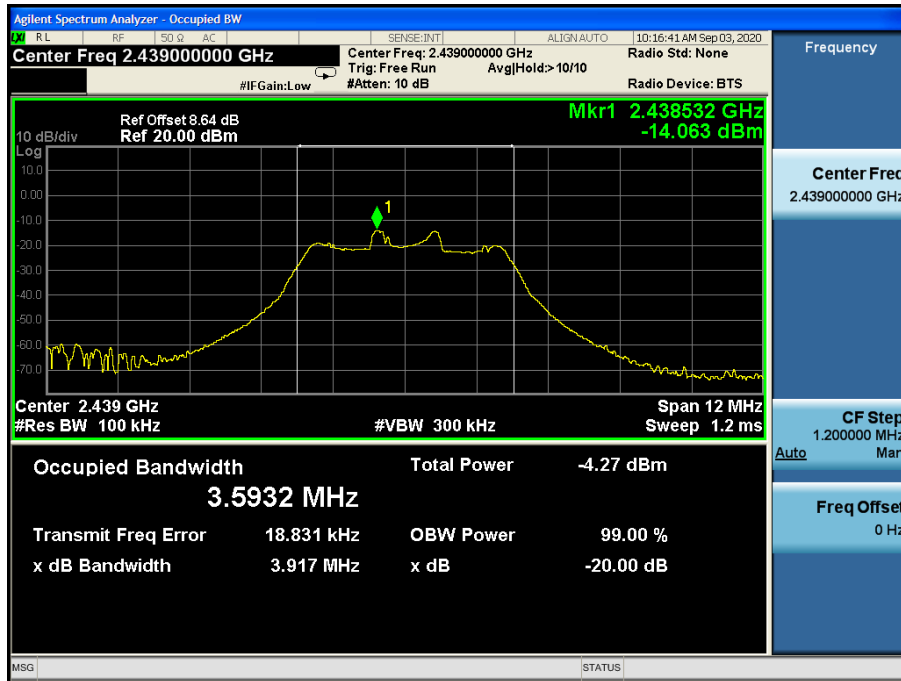

CH: 2478MHz

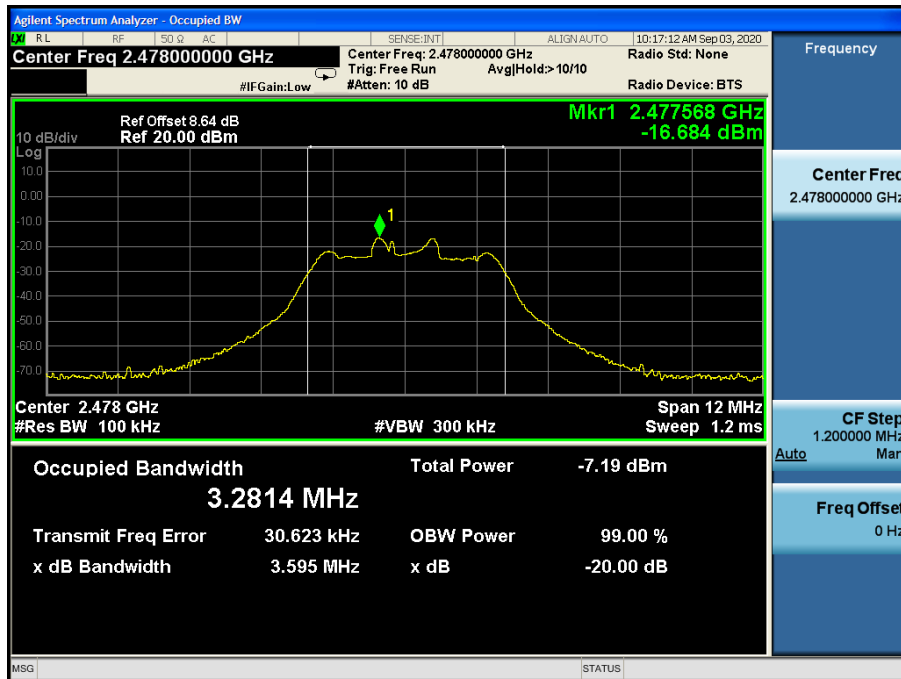

7 ANTENNA REQUIREMENT

Standard Applicable

For intentional device, according to FCC 47 CFR Section 15.203, an intentional radiator shall be designed to ensure that no antenna other than that furnished by the responsible party shall be used with the device.

Antenna Connected Construction

The antenna used in this product is a PCB Antenna which permanently attached. It conforms to the standard requirements. The directional gains of antenna used for transmitting is 0dBi.

ANTENNA

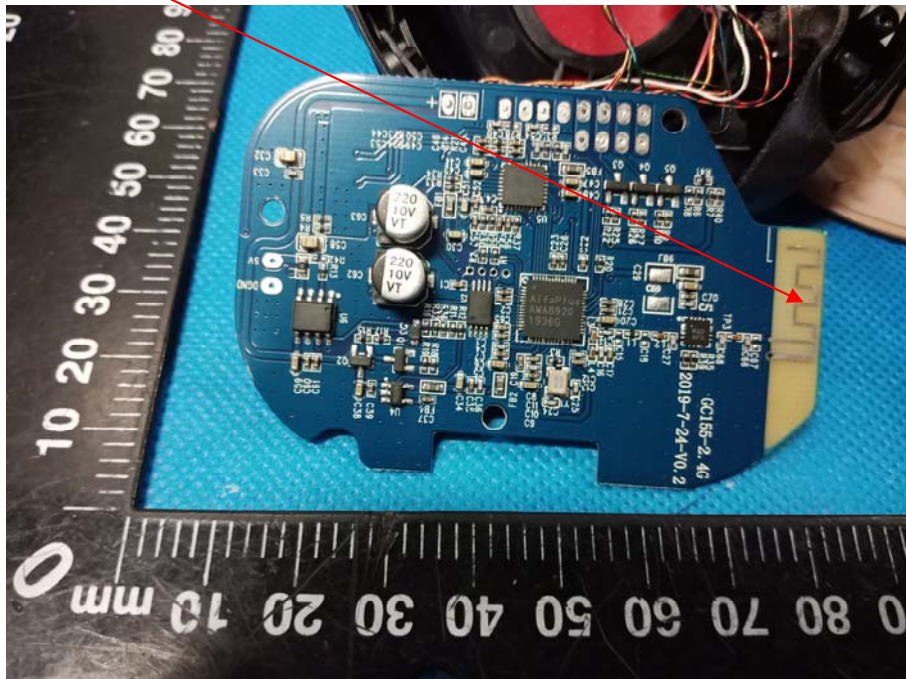

8 PHOTOGRAPH OF TEST

8.1 Radiated Emission

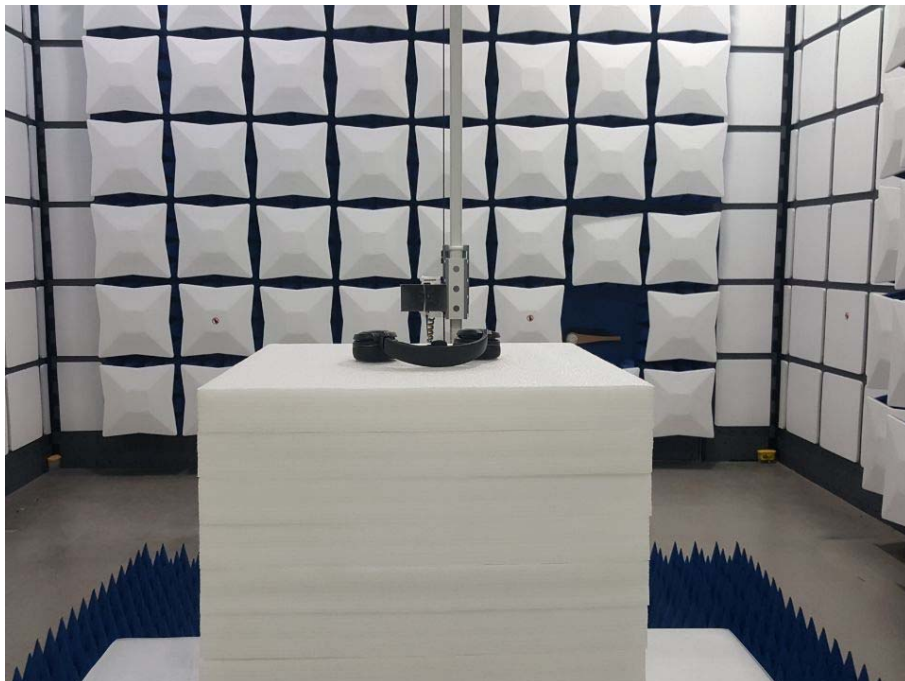



8.2 Conducted Emission





9 PHOTOS OF THE EUT

Reference to the reporter : ANNEX A of external photos and ANNEX B of internal photos

-----End of test report-----