

FCC TEST REPORT

FCC ID:2AXCX-VERTS0722

Report Number: BTF230721R01301-1

Date of Test..... Jul. 11, 2023- Aug. 01, 2023

Date of issue.....: Aug. 01, 2023

Total number of pages 81

Test Result: PASS

Testing Laboratory.....: BTF Testing Lab (Shenzhen) Co., Ltd.

Address: F101, 201 and 301, Building 1, Block 2, Tantou Industrial Park,
Tantou Community, Songgang Street, Bao'an District, Shenzhen,
China

Applicant's name: Shenzhen Foxwell Technology Co., Ltd

Address: 5/F, Plant C, Baocheng 71st Zone, Xin'an Street, Baoan
District, Shenzhen 518106 · China

Manufacturer's name: Shenzhen Foxwell Technology Co., Ltd

Address: 5/F, Plant C, Baocheng 71st Zone, Xin'an Street, Baoan
District, Shenzhen 518106 · China

Test specification:

Standard: FCC CFR Title 47 Part 15 Subpart C Section 15.247
ANSI C63.10:2013

Test procedure: /

Non-standard test method: N/A

Test Report Form No.: TRF-EL-112_V0

Test Report Form(s) Originator: BTF Testing

Master TRF: Dated: 2022-02-21

This device described above has been tested by BTF, and the test results show that the equipment under test (EUT) is in compliance with the FCC requirements. And it is applicable only to the tested sample identified in the report.

This report shall not be reproduced except in full, without the written approval of BTF, this document may be altered or revised by BTF, personal only, and shall be noted in the revision of the document.

Product name.....: Premium Diagnostic & TPMS Scanner

Trademark: N/A

Model/Type reference.....: TS5000
TS7000

Ratings.....: Input:DC 5V
Battery:DC 3.7V

Testing procedure and testing location:

Testing Laboratory: Shenzhen BTF Technology Co., Ltd.

Address.....: F101, 201 and 301, Building 1, Block 2, Tantou Industrial Park, Tantou Community, Songgang Street, Bao'an District, Shenzhen, China

Tested by (name + signature): elma.yang

Elma.Yang

Reviewer (name + signature).....: elma.yang

Elma.Yang

Approved (name + signature): Ryan.CJ



Table of Contents

	Page
1. VERSION	5
2. TEST SUMMARY	6
2.1 TEST FACILITY	7
2.2 MEASUREMENT UNCERTAINTY	7
3. GENERAL INFORMATION	8
3.1 GENERAL DESCRIPTION OF EUT	8
3.2 Test Setup Configuration	9
3.3 Support Equipment	9
3.4 Test Mode	11
3.5 EQUIPMENTS LIST FOR ALL TEST ITEMS	12
4. EMC EMISSION TEST	12
4.1 Conducted emissions	16
4.1.1 POWER LINE CONDUCTED EMISSION Limits	16
4.1.2 TEST PROCEDURE	16
4.1.3 DEVIATION FROM TEST STANDARD	16
4.1.4 TEST SETUP	17
4.1.5 EUT OPERATING CONDITIONS	17
4.1.6 Test Result	18
4.2 Radiated emissions	20
4.2.1 Radiated Emission Limits	20
4.2.2 TEST PROCEDURE	20
4.2.3 DEVIATION FROM TEST STANDARD	21
4.2.4 TEST SETUP	21
4.2.5 EUT OPERATING CONDITIONS	22
4.2.6 TEST RESULTS	22
5. RADIATED BAND EMISSION MEASUREMENT	31
5.1 Test Requirement:	31
5.2 TEST PROCEDURE	31
5.3 DEVIATION FROM TEST STANDARD	32
5.4 TEST SETUP	32
5.5 EUT OPERATING CONDITIONS	32
5.6 TEST RESULT	33
6. CONDUCTED BAND EDGE AND SPURIOUS EMISSION	35
6.1 Limit	35
6.2 Test Setup	35
6.3 Test procedure	35
6.4 DEVIATION FROM STANDARD	35
6.5 Test Result	36
7. 20DB&99% BANDWIDTH	51
7.1 Test Setup	51
7.2 Limit	51
7.3 Test procedure	51
7.4 DEVIATION FROM STANDARD	51

7.5 Test Result	51
8. MAXIMUM PEAK OUTPUT POWER	58
8.1 Block Diagram Of Test Setup	58
8.2 Limit	58
8.3 Test procedure	58
8.4 DEVIATION FROM STANDARD	58
8.5 Test Result	58
9. HOPPING CHANNEL SEPARATION	64
9.1 Test Setup	64
9.2 Test procedure	64
9.3 DEVIATION FROM STANDARD	64
9.4 Test Result	65
10.NUMBER OF HOPPING FREQUENCY	70
10.1 Test Setup	70
10.2 Test procedure	70
10.3 DEVIATION FROM STANDARD	70
10.4 Test Result	71
11. DWELL TIME	73
11.1 Test Setup	73
11.2 Test procedure	73
11.3 DEVIATION FROM STANDARD	73
11.4 Test Result	74
12. ANTENNA REQUIREMENT	80
13. TEST SETUP PHOTO	81
14. EUT CONSTRUCTIONAL DETAILS	81

1. VERSION

Report No.	Version	Description	Approved
BTF230721R01301-1	Rev.01	Initial issue of report	Aug. 01, 2023

2. TEST SUMMARY

Test procedures according to the technical standards:

FCC Part15 (15.247) , Subpart C			
Standard Section	Test Item	Result	Remark
15.203/15.247 (c)	Antenna Requirement	PASS	
15.207	AC Power Line Conducted Emission	PASS	
15.247 (b)(1)	Conducted Peak Output Power	PASS	
15.247 (a)(1)	20dB Occupied Bandwidth 99% OCB	PASS	
15.247 (a)(1)	Carrier Frequencies Separation	PASS	
15.247 (a)(1)(iii)	Hopping Channel Number	PASS	
15.247 (a)(1)(iii)	Dwell Time	PASS	
15.205/15.209	Radiated Emission and Restricted Band	PASS	
15.247(d)	Conducted Unwanted emissions and Band Edge	PASS	

NOTE:

(1) " N/A" denotes test is not applicable in this Test Report

2.1 TEST FACILITY

BTF Testing Lab (Shenzhen) Co., Ltd.
Add. : F101, 201 and 301, Building 1, Block 2, Tantou Industrial Park, Tantou Community, Songgang Street, Bao'an District, Shenzhen, China

FCC Registration Number: 518915
Designation Number: CN1330
Company Number: 27844
CAB Identifier: CN0135

2.2 MEASUREMENT UNCERTAINTY

The reported uncertainty of measurement $y \pm U$, where expanded uncertainty U is based on a standard uncertainty multiplied by a coverage factor of $k=2$, providing a level of confidence of approximately 95%.

No.	Item	Uncertainty
1	3m chamber Radiated spurious emission(9KHz-30MHz)	U=4.5dB
2	3m chamber Radiated spurious emission(30MHz-1GHz)	U=4.8dB
3	3m chamber Radiated spurious emission(1GHz-6GHz)	U=4.9dB
4	3m chamber Radiated spurious emission(6GHz-40GHz)	U=5.0dB
5	Conducted disturbance	U=3.2dB
6	RF Band Edge	U=1.68dB
7	RF power conducted	U=1.86dB
8	RF conducted Spurious Emission	U=2.2dB
9	RF Occupied Bandwidth	U=1.8dB
10	RF Power Spectral Density	U=1.75dB
11	humidity uncertainty	U=5.3%
12	Temperature uncertainty	U=0.59°C

3. GENERAL INFORMATION

3.1 GENERAL DESCRIPTION OF EUT

Product Name:	Premium Diagnostic & TPMS Scanner
Model No.:	TS5000 TS7000
Model Different.:	All models have the same circuit and RF module, only the appearance color are different
Sample ID	BTF230721R01301-1
Sample(s) Status:	Engineer sample
Channel numbers:	79
Operation Frequency:	2402MHz~2480MHz
Modulation technology:	GFSK, $\pi/4$ -DQPSK, 8-DPSK
Antenna Type:	PCB Antenna
Antenna gain:	1.5 dBi
Power supply:	Input: DC 5V Battery: DC 3.7V
Battery:	3.7V 5000mAh 18.5Wh
SWITCHING POWER SUPPLY	Model:PSY0502000 INPUT:AC 100-240V 50/60Hz 0.6A Max OUTPUT:DC 5V 2.0A

Operation Frequency each of channel							
Channel	Frequency	Channel	Frequency	Channel	Frequency	Channel	Frequency
1	2402MHz	21	2422MHz	41	2442MHz	61	2462MHz
2	2403MHz	22	2423MHz	42	2443MHz	62	2463MHz
3	2404MHz	23	2424MHz	43	2444MHz	63	2464MHz
4	2405MHz	24	2425MHz	44	2445MHz	64	2465MHz
5	2406MHz	25	2426MHz	45	2446MHz	65	2466MHz
6	2407MHz	26	2427MHz	46	2447MHz	66	2467MHz
7	2408MHz	27	2428MHz	47	2448MHz	67	2468MHz
8	2409MHz	28	2429MHz	48	2449MHz	68	2469MHz
9	2410MHz	29	2430MHz	49	2450MHz	69	2470MHz
10	2411MHz	30	2431MHz	50	2451MHz	70	2471MHz
11	2412MHz	31	2432MHz	51	2452MHz	71	2472MHz
12	2413MHz	32	2433MHz	52	2453MHz	72	2473MHz
13	2414MHz	33	2434MHz	53	2454MHz	73	2474MHz
14	2415MHz	34	2435MHz	54	2455MHz	74	2475MHz
15	2416MHz	35	2436MHz	55	2456MHz	75	2476MHz
16	2417MHz	36	2437MHz	56	2457MHz	76	2477MHz

17	2418MHz	37	2438MHz	57	2458MHz	77	2478MHz
18	2419MHz	38	2439MHz	58	2459MHz	78	2479MHz
19	2420MHz	39	2440MHz	59	2460MHz	79	2480MHz
20	2421MHz	40	2441MHz	60	2461MHz		

Note:

In section 15.31(m), regards to the operating frequency range over 10 MHz, the Lowest frequency, the middle frequency, and the highest frequency of channel were selected to perform the test, and the selected channel see below:

Test channel	Frequency
The lowest channel	2402MHz
The middle channel	2441MHz
The Highest channel	2480MHz

3.2 Test Setup Configuration
Conducted Emission

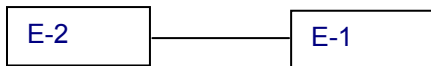

Radiated Emission

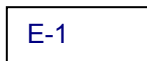

Conducted Spurious

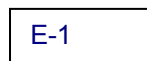

3.3 Support Equipment

The EUT has been tested as an independent unit together with other necessary accessories or support units. The following support units or accessories were used to form a representative test configuration during the tests.

Item	Equipment	Mfr/Brand	Model/Type No.	Series No.	Note
E-1	Premium Diagnostic & TPMS Scanner	N/A	TS5000	N/A	EUT
E-2	SWITCHING POWER SUPPLY	N/A	PSY0502000	N/A	EUT

Item	Shielded Type	Ferrite Core	Length	Note

Note:

- (1) The support equipment was authorized by Declaration of Confirmation.
- (2) For detachable type I/O cable should be specified the length in cm in 『Length』 column.

3.4 Test Mode

Transmitting mode	Keep the EUT in continuously transmitting mode.
Charging mode	Keep the EUT in Charging mode.
Remark: During the test, the test voltage was tuned from 85% to 115% of the nominal rated supply voltage, and found that the worst case was under the nominal rated supply condition. So the report just shows that condition's data.	

Test Software	BT Test Tool
Power level setup	<7dBm

3.5 EQUIPMENTS LIST FOR ALL TEST ITEMS

Conducted Emission at AC power line					
Equipment	Manufacturer	Model No	Inventory No	Cal Date	Cal Due Date
Pulse Limiter	SCHWARZBECK	VTSD 9561-F	00953	2022-11-24	2023-11-23
Coaxial Switcher	SCHWARZBECK	CX210	CX210	2022-11-24	2023-11-23
V-LISN	SCHWARZBECK	NSLK 8127	01073	2022-11-24	2023-11-23
LISN	AFJ	LS16/110VAC	16010020076	2023-02-23	2024-02-22
EMI Receiver	ROHDE&SCHWARZ	ESCI3	101422	2022-11-24	2023-11-23

Occupied Bandwidth					
Equipment	Manufacturer	Model No	Inventory No	Cal Date	Cal Due Date
RFTTest software	/	V1.00	/	/	/
RF Control Unit	Techy	TR1029-1	/	2022-11-24	2023-11-23
RF Sensor Unit	Techy	TR1029-2	/	2022-11-24	2023-11-23
Programmable constant temperature and humidity box	ZZCKONG	ZZ-K02A	20210928007	2022-11-24	2023-11-23
Adjustable Direct Current Regulated Power Supply	Dongguan Tongmen Electronic Technology Co., LTD	etm-6050c	20211026123	2022-11-24	2023-11-23
WIDEBAND RADIO COMMUNICATION TESTER	Rohde & Schwarz	CMW500	161997	2022-11-24	2023-11-23
MXA Signal Analyzer	KEYSIGHT	N9020A	MY50410020	2022-11-24	2023-11-23

Maximum Conducted Output Power					
Equipment	Manufacturer	Model No	Inventory No	Cal Date	Cal Due Date
RFTTest software	/	V1.00	/	/	/
RF Control Unit	Techy	TR1029-1	/	2022-11-24	2023-11-23
RF Sensor Unit	Techy	TR1029-2	/	2022-11-24	2023-11-23
Programmable constant temperature and humidity box	ZZCKONG	ZZ-K02A	20210928007	2022-11-24	2023-11-23
Adjustable Direct Current Regulated Power Supply	Dongguan Tongmen Electronic Technology Co., LTD	etm-6050c	20211026123	2022-11-24	2023-11-23
WIDEBAND RADIO COMMUNICATION TESTER	Rohde & Schwarz	CMW500	161997	2022-11-24	2023-11-23
MXA Signal Analyzer	KEYSIGHT	N9020A	MY50410020	2022-11-24	2023-11-23
RF Power Meter	KEYSIGHT	N1912A P	/	2022-11-24	2023-11-23

Power Spectral Density					
Equipment	Manufacturer	Model No	Inventory No	Cal Date	Cal Due Date
RFTest software	/	V1.00	/	/	/
RF Control Unit	Techy	TR1029-1	/	2022-11-24	2023-11-23
RF Sensor Unit	Techy	TR1029-2	/	2022-11-24	2023-11-23
Programmable constant temperature and humidity box	ZZCKONG	ZZ-K02A	20210928007	2022-11-24	2023-11-23
Adjustable Direct Current Regulated Power Supply	Dongguan Tongmen Electronic Technology Co., LTD	etm-6050c	20211026123	2022-11-24	2023-11-23
WIDEBAND RADIO COMMUNICATION TESTER	Rohde & Schwarz	CMW500	161997	2022-11-24	2023-11-23
MXA Signal Analyzer	KEYSIGHT	N9020A	MY50410020	2022-11-24	2023-11-23

Emissions in non-restricted frequency bands					
Equipment	Manufacturer	Model No	Inventory No	Cal Date	Cal Due Date
RF Test software	/	V1.00	/	/	/
RF Control Unit	Techy	TR1029-1	/	2022-11-24	2023-11-23
RF Sensor Unit	Techy	TR1029-2	/	2022-11-24	2023-11-23
Programmable constant temperature and humidity box	ZZCKONG	ZZ-K02A	20210928007	2022-11-24	2023-11-23
Adjustable Direct Current Regulated Power Supply	Dongguan Tongmen Electronic Technology Co., LTD	etm-6050c	20211026123	2022-11-24	2023-11-23
WIDEBAND RADIO COMMUNICATION TESTER	Rohde & Schwarz	CMW500	161997	2022-11-24	2023-11-23
MXA Signal Analyzer	KEYSIGHT	N9020A	MY50410020	2022-11-24	2023-11-23

Band edge emissions (Radiated)					
Equipment	Manufacturer	Model No	Inventory No	Cal Date	Cal Due Date
Coaxial cable Multiflex 141	Schwarzbeck	N/SMA 0.5m	517386	2023-03-24	2024-03-23
Preamplifier	SCHWARZBECK	BBV9744	00246	2022-11-24	2023-11-23
RE Cable	REBES Talent	UF1-SMASMAM-10m	21101566	2022-11-24	2023-11-23
RE Cable	REBES Talent	UF2-NMNM-10m	21101570	2022-11-24	2023-11-23
RE Cable	REBES Talent	UF1-SMASMAM-1m	21101568	2022-11-24	2023-11-23
RE Cable	REBES Talent	UF2-NMNM-1m	21101576	2022-11-24	2023-11-23
RE Cable	REBES Talent	UF2-NMNM-2.5m	21101573	2022-11-24	2023-11-23
POSITIONAL CONTROLLER	SKET	PCI-GPIB	/	/	/
Horn Antenna	SCHWARZBECK	BBHA9170	01157	2021-11-28	2023-11-27
EMI TEST RECEIVER	ROHDE&SCHWARZ	ESCI7	101032	2022-11-24	2023-11-23
SIGNAL ANALYZER	ROHDE&SCHWARZ	FSQ40	100010	2022-11-24	2023-11-23
POSITIONAL CONTROLLER	SKET	PCI-GPIB	/	/	/
Broadband	SCHWARZBECK	BBV9718D	00008	2023-03-24	2024-03-23

Preamplifier					
Horn Antenna	SCHWARZBECK	BBHA9120D	2597	2022-05-22	2024-05-21
EZ EMC	Frad	FA-03A2 RE+	/	/	/
POSITIONAL CONTROLLER	SKET	PCI-GPIB	/	/	/
Log periodic antenna	SCHWARZBECK	VULB 9168	01328	2021-11-28	2023-11-27

Emissions in restricted frequency bands (below 1GHz)					
Equipment	Manufacturer	Model No	Inventory No	Cal Date	Cal Due Date
Coaxial cable Multiflex 141	Schwarzbeck	N/SMA 0.5m	517386	2023-03-24	2024-03-23
Preamplifier	SCHWARZBECK	BBV9744	00246	2022-11-24	2023-11-23
RE Cable	REBES Talent	UF1-SMASMAM-10m	21101566	2022-11-24	2023-11-23
RE Cable	REBES Talent	UF2-NMNM-10m	21101570	2022-11-24	2023-11-23
RE Cable	REBES Talent	UF1-SMASMAM-1m	21101568	2022-11-24	2023-11-23
RE Cable	REBES Talent	UF2-NMNM-1m	21101576	2022-11-24	2023-11-23
RE Cable	REBES Talent	UF2-NMNM-2.5m	21101573	2022-11-24	2023-11-23
POSITIONAL CONTROLLER	SKET	PCI-GPIB	/	/	/
Horn Antenna	SCHWARZBECK	BBHA9170	01157	2021-11-28	2023-11-27
EMI TEST RECEIVER	ROHDE&SCHWARZ	ESC17	101032	2022-11-24	2023-11-23
SIGNAL ANALYZER	ROHDE&SCHWARZ	FSQ40	100010	2022-11-24	2023-11-23
POSITIONAL CONTROLLER	SKET	PCI-GPIB	/	/	/
Broadband Preamplifier	SCHWARZBECK	BBV9718D	00008	2023-03-24	2024-03-23
Horn Antenna	SCHWARZBECK	BBHA9120D	2597	2022-05-22	2024-05-21
EZ EMC	Frad	FA-03A2 RE+	/	/	/
POSITIONAL CONTROLLER	SKET	PCI-GPIB	/	/	/
Log periodic antenna	SCHWARZBECK	VULB 9168	01328	2021-11-28	2023-11-27

Emissions in restricted frequency bands (above 1GHz)					
Equipment	Manufacturer	Model No	Inventory No	Cal Date	Cal Due Date
Coaxial cable Multiflex 141	Schwarzbeck	N/SMA 0.5m	517386	2023-03-24	2024-03-23
Preamplifier	SCHWARZBECK	BBV9744	00246	2022-11-24	2023-11-23
RE Cable	REBES Talent	UF1-SMASMAM-10m	21101566	2022-11-24	2023-11-23
RE Cable	REBES Talent	UF2-NMNM-10m	21101570	2022-11-24	2023-11-23
RE Cable	REBES Talent	UF1-SMASMAM-1m	21101568	2022-11-24	2023-11-23
RE Cable	REBES Talent	UF2-NMNM-1m	21101576	2022-11-24	2023-11-23
RE Cable	REBES Talent	UF2-NMNM-2.5m	21101573	2022-11-24	2023-11-23
POSITIONAL CONTROLLER	SKET	PCI-GPIB	/	/	/
Horn Antenna	SCHWARZBECK	BBHA9170	01157	2021-11-28	2023-11-27
EMI TEST RECEIVER	ROHDE&SCHWARZ	ESC17	101032	2022-11-24	2023-11-23
SIGNAL ANALYZER	ROHDE&SCHWARZ	FSQ40	100010	2022-11-24	2023-11-23
POSITIONAL CONTROLLER	SKET	PCI-GPIB	/	/	/

Broadband Preamplifier	SCHWARZBECK	BBV9718D	00008	2023-03-24	2024-03-23
Horn Antenna	SCHWARZBECK	BBHA9120D	2597	2022-05-22	2024-05-21
EZ_EMCC	Frad	FA-03A2 RE+	/	/	/
POSITIONAL CONTROLLER	SKET	PCI-GPIB	/	/	/
Log periodic antenna	SCHWARZBECK	VULB 9168	01328	2021-11-28	2023-11-27

4. EMC EMISSION TEST

4.1 Conducted emissions

Test Requirement:	FCC Part15 C Section 15.207
Test Method:	ANSI C63.10:2013
Test Frequency Range:	150KHz to 30MHz
Receiver setup:	RBW=9KHz, VBW=30KHz, Sweep time=auto

4.1.1 POWER LINE CONDUCTED EMISSION Limits

FREQUENCY (MHz)	Limit (dBuV)		Standard
	Quasi-peak	Average	
0.15 -0.5	66 - 56 *	56 - 46 *	FCC
0.50 -5.0	56.00	46.00	FCC
5.0 -30.0	60.00	50.00	FCC

Note:

- (1) *Decreases with the logarithm of the frequency.

4.1.2 TEST PROCEDURE

- a. The EUT was placed 0.8 meters from the horizontal ground plane with EUT being connected to the power mains through a line impedance stabilization network (LISN). All other support equipments powered from additional LISN(s). The LISN provide 50 Ohm/ 50uH of coupling impedance for the measuring instrument.
- b. Interconnecting cables that hang closer than 40 cm to the ground plane shall be folded back and forth in the center forming a bundle 30 to 40 cm long.
- c. I/O cables that are not connected to a peripheral shall be bundled in the center. The end of the cable may be terminated, if required, using the correct terminating impedance. The overall length shall not exceed 1 m.
- d. LISN at least 80 cm from nearest part of EUT chassis.
- e. For the actual test configuration, please refer to the related Item –EUT Test Photos.

4.1.3 DEVIATION FROM TEST STANDARD

No deviation

4.1.4 TEST SETUP

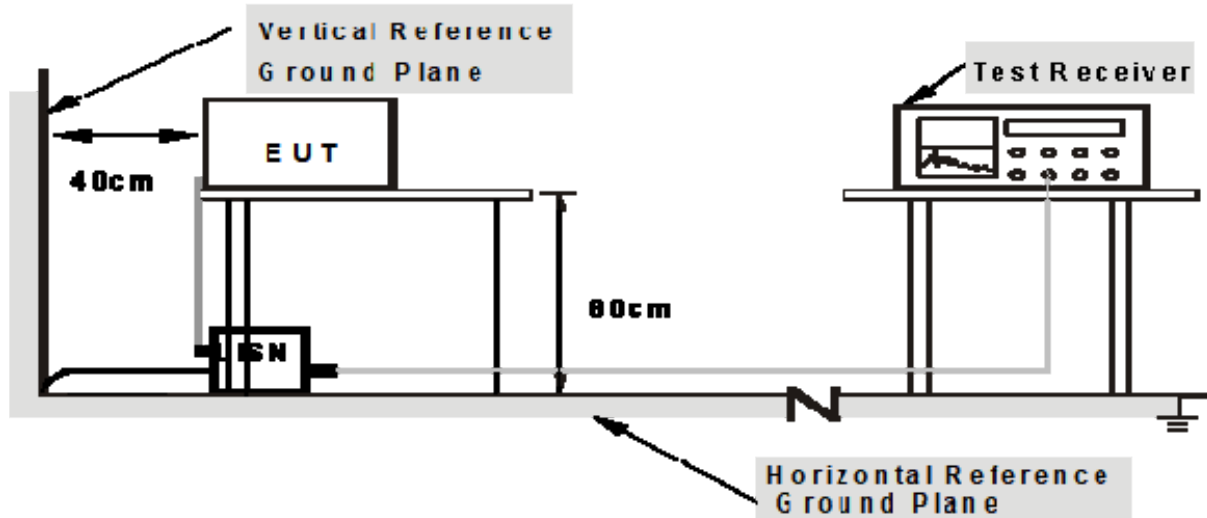

- Note: 1. Support units were connected to second LISN.**
2. Both of LISNs (AMN) are 80 cm from EUT and at least 80 cm from other units and other metal planes

4.1.5 EUT OPERATING CONDITIONS

The EUT was configured for testing in a typical fashion (as a customer would normally use it). The EUT has been programmed to continuously transmit during test. This operating condition was tested and used to collect the included data.

4.1.6 Test Result

Temperature :	26°C	Relative Humidity:	54%
Pressure :	101kPa	Phase :	L
Test Voltage :	AC 120V/60Hz		

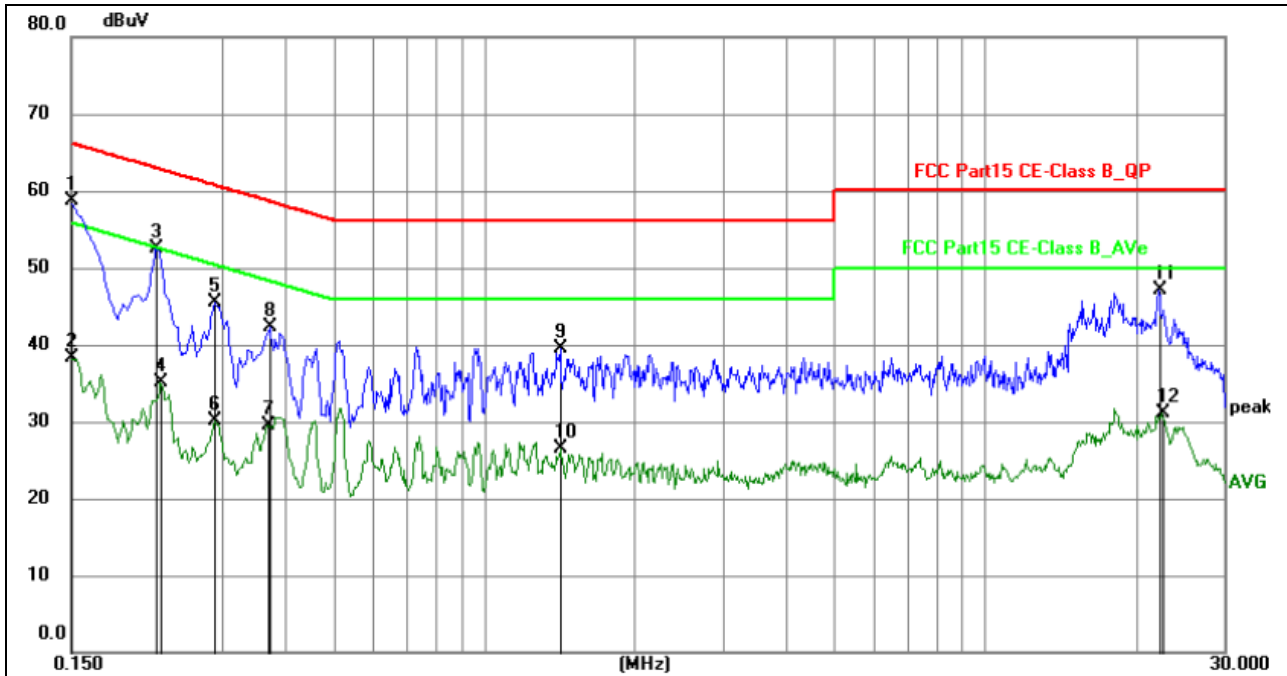

No.	Frequency (MHz)	Reading (dBuV)	Factor (dB)	Level (dBuV)	Limit (dBuV)	Margin (dB)	Detector	P/F	Remark
1	0.1500	38.22	20.48	58.70	66.00	-7.30	QP	P	
2	0.1500	17.73	20.48	38.21	56.00	-17.79	AVG	P	
3	0.2220	31.87	20.67	52.54	62.74	-10.20	QP	P	
4	0.2265	14.41	20.67	35.08	52.58	-17.50	AVG	P	
5	0.2895	24.95	20.65	45.60	60.54	-14.94	QP	P	
6	0.2895	9.44	20.65	30.09	50.54	-20.45	AVG	P	
7	0.3704	8.87	20.61	29.48	48.49	-19.01	AVG	P	
8	0.3750	21.66	20.61	42.27	58.39	-16.12	QP	P	
9	1.4235	18.78	20.80	39.58	56.00	-16.42	QP	P	
10	1.4235	5.77	20.80	26.57	46.00	-19.43	AVG	P	
11	22.1820	25.38	21.73	47.11	60.00	-12.89	QP	P	
12	22.5555	9.39	21.74	31.13	50.00	-18.87	AVG	P	

Notes:

1. An initial pre-scan was performed on the line and neutral lines with peak detector.
2. Quasi-Peak and Average measurement were performed at the frequencies with maximized peak emission.
3. Measurement Level = Reading level + Correct Factor

Temperature :	26°C	Relative Humidity:	54%
Pressure :	101kPa	Phase :	N
Test Voltage :	AC 120V/60Hz		

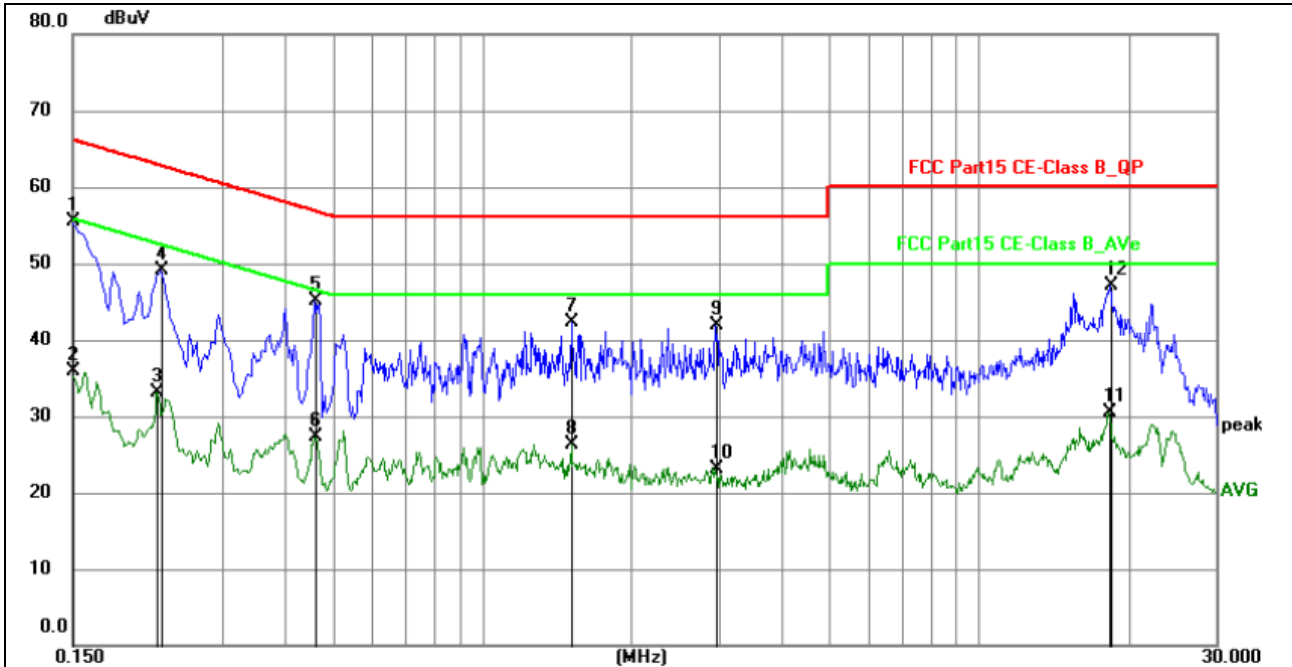

No.	Frequency (MHz)	Reading (dBuV)	Factor (dB)	Level (dBuV)	Limit (dBuV)	Margin (dB)	Detector	P/F	Remark
1	0.1500	34.95	20.58	55.53	66.00	-10.47	QP	P	
2	0.1500	15.28	20.58	35.86	56.00	-20.14	AVG	P	
3	0.2220	12.23	20.78	33.01	52.74	-19.73	AVG	P	
4	0.2265	28.30	20.78	49.08	62.58	-13.50	QP	P	
5	0.4605	24.32	20.70	45.02	56.68	-11.66	QP	P	
6	0.4605	6.51	20.70	27.21	46.68	-19.47	AVG	P	
7	1.5134	21.42	20.82	42.24	56.00	-13.76	QP	P	
8	1.5134	5.39	20.82	26.21	46.00	-19.79	AVG	P	
9	2.9534	20.95	20.91	41.86	56.00	-14.14	QP	P	
10	2.9534	2.13	20.91	23.04	46.00	-22.96	AVG	P	
11	18.2715	9.00	21.54	30.54	50.00	-19.46	AVG	P	
12	18.3570	25.49	21.53	47.02	60.00	-12.98	QP	P	

Notes:
 1.An initial pre-scan was performed on the line and neutral lines with peak detector.
 2.Quasi-Peak and Average measurement were performed at the frequencies with maximized peak emission.
 3.Measurement Level = Reading level + Correct Factor

4.2 Radiated emissions

Test Requirement:	FCC Part15 C Section 15.209				
Test Method:	ANSI C63.10:2013				
Test Frequency Range:	9kHz to 25GHz				
Test site:	Measurement Distance: 3m				
Receiver setup:	Frequency	Detector	RBW	VBW	Value
	9KHz-150KHz	Quasi-peak	200Hz	MX5Hz	Quasi-peak
	150KHz-30MHz	Quasi-peak	9KHz	30KHz	Quasi-peak
	30MHz-1GHz	Quasi-peak	100KHz	300KHz	Quasi-peak
	Above 1GHz	Peak	1MHz	3MHz	Peak
		Peak	1MHz	10Hz	Average

4.2.1 Radiated Emission Limits

Frequencies (MHz)	Field Strength (micorvolts/meter)	Measurement Distance (meters)
0.009~0.490	2400/F(KHz)	300
0.490~1.705	24000/F(KHz)	30
1.705~30.0	30	30
30~88	100	3
88~216	150	3
216~960	200	3
Above 960	500	3

LIMITS OF RADIATED EMISSION MEASUREMENT

FREQUENCY (MHz)	Limit (dBuV/m) (at 3M)	
	PEAK	AVERAGE
Above 1000	74	54

Notes:

- (1) The limit for radiated test was performed according to FCC PART 15C.
- (2) The tighter limit applies at the band edges.
- (3) Emission level (dBuV/m)=20log Emission level (uV/m).

4.2.2 TEST PROCEDURE

Below 1GHz test procedure as below:

- a. The measuring distance of at 3 m shall be used for measurements at frequency up to 25GHz. For frequencies above 1GHz, any suitable measuring distance may be used.
- b. The EUT was placed on the top of a rotating table 0.8 meters above the ground at a 3 meter semi-chamber test. The table was rotated 360 degrees to determine the position of the highest radiation.
- c. The height of the equipment or of the substitution antenna shall be 1m; above 1GHz, the height was 1.5m, the height of the test antenna shall vary between 1 m to 4 m. Both horizontal and vertical polarizations of the antenna are set to make the measurement.

- d. The initial step in collecting conducted emission data is a spectrum analyzer peak detector mode pre-scanning the measurement frequency range. Significant peaks are then marked and then Quasi Peak detector mode re-measured.
- e. If the Peak Mode measured value compliance with and lower than Quasi Peak Mode Limit, the EUT shall be deemed to meet QP Limits and then no additional QP Mode measurement performed.
- f. For the actual test configuration, please refer to the related Item –EUT Test Photos.

Above 1GHz test procedure as below:

g: Place the measurement antenna away from each area of the EUT determined to be a source of emissions at the specified measurement distance, while keeping the measurement antenna aimed at the source of emissions at each frequency of significant emissions, with polarization oriented for maximum response. The measurement antenna may have to be higher or lower than the EUT, depending on the radiation pattern of the emission and staying aimed at the emission source for receiving the maximum signal. The final measurement antenna elevation shall be that which maximizes the emissions. The measurement antenna elevation for maximum emissions shall be restricted to a range of heights of from 1 m to 4 m above the ground or reference ground plane.

Note:

Both horizontal and vertical antenna polarities were tested and performed pretest to three orthogonal axis. The worst case emissions were reported

4.2.3 DEVIATION FROM TEST STANDARD

No deviation

4.2.4 TEST SETUP

(A) Radiated Emission Test-Up Frequency Below 30MHz

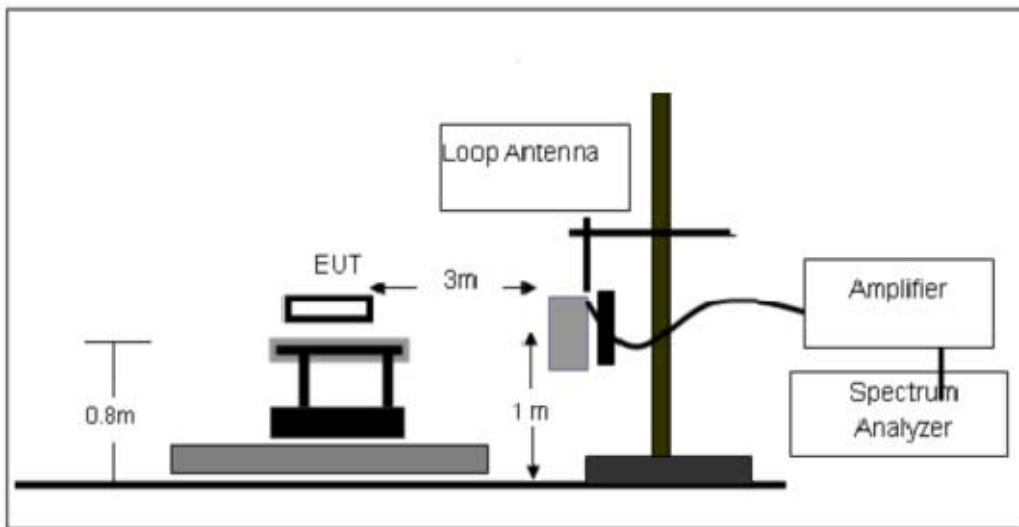

(B) Radiated Emission Test-Up Frequency 30MHz~1GHz

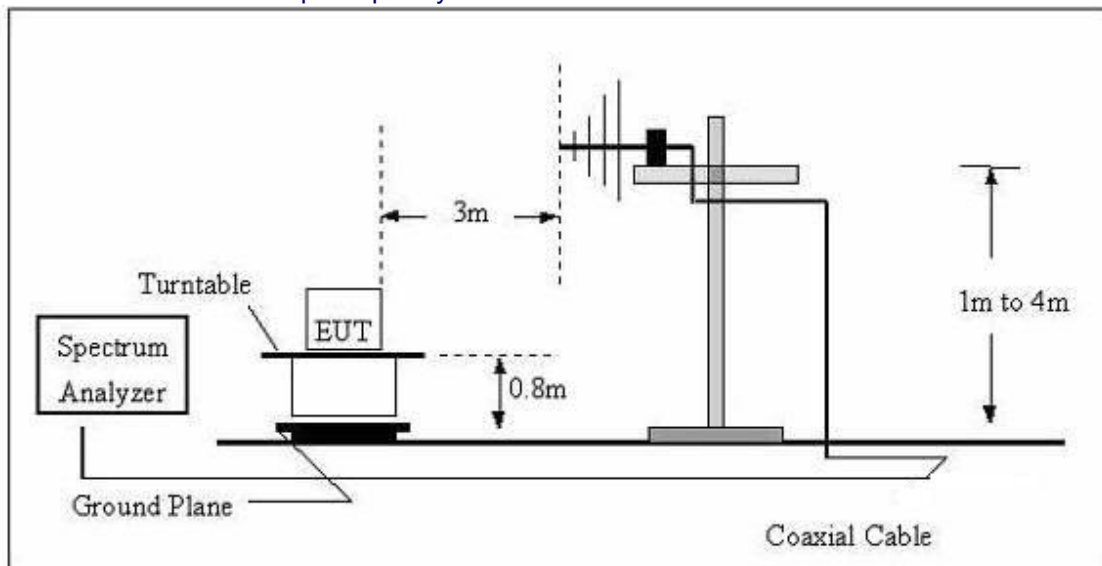

(C)

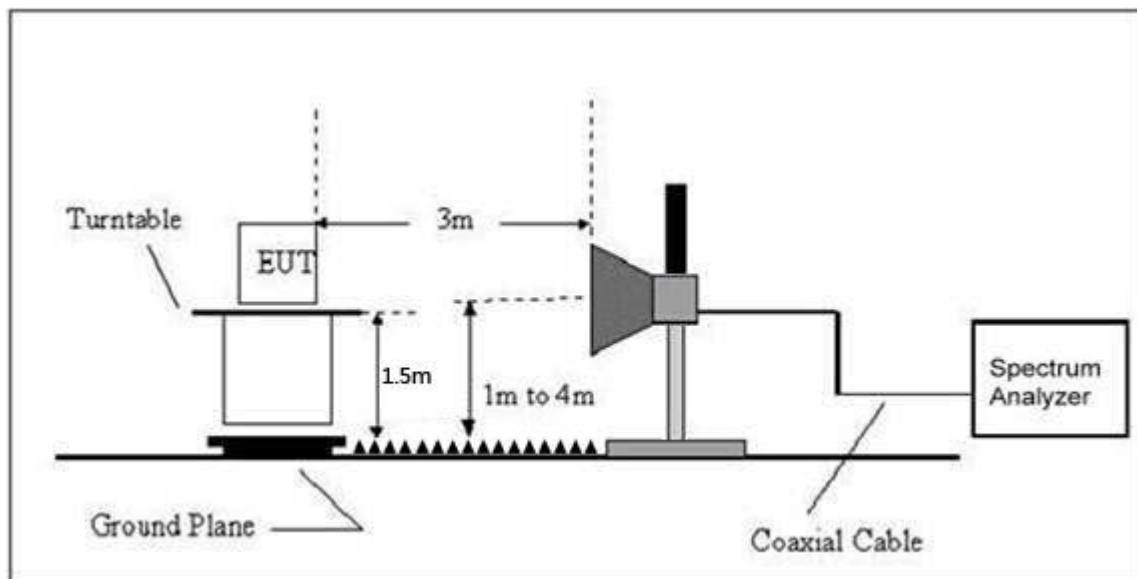

4.2.5 EUT OPERATING CONDITIONS

The EUT tested system was configured as the statements of 2.4 Unless otherwise a special operating condition is specified in the follows during the testing.

4.2.6 TEST RESULTS

Between 9KHz – 30MHz

The emission from 9 kHz to 30MHz was pre-tested and found the result was 20dB lower than the limit, and according to 15.31(o) & RSS-Gen 6.13, the test result no need to reported.

Between 30MHz – 1GHz

Temperature:	26°C	Relative Humidity:	54%
Pressure:	101 kPa	Polarization:	Horizontal
Test Voltage:	DC 3.7V		

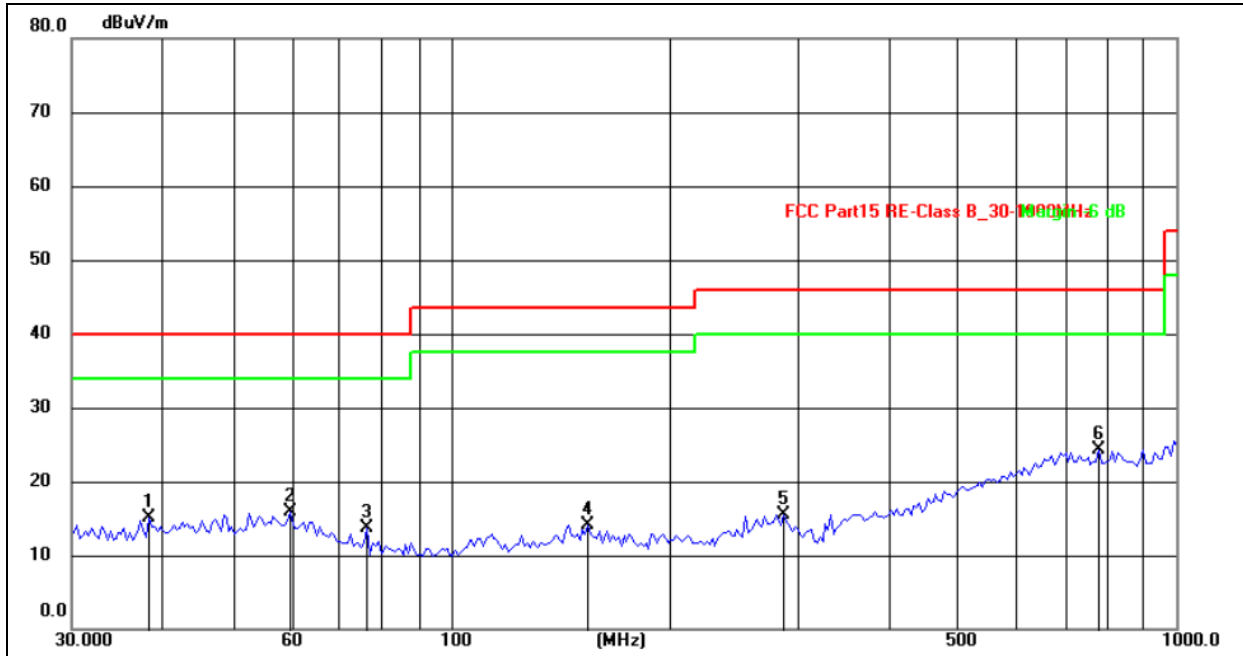

No.	Frequency (MHz)	Reading (dBuV)	Factor (dB/m)	Level (dBuV/m)	Limit (dBuV/m)	Margin (dB)	Detector
1	38.3462	23.54	-8.43	15.11	40.00	-24.89	QP
2	59.9637	24.20	-8.24	15.96	40.00	-24.04	QP
3	76.6461	26.36	-12.61	13.75	40.00	-26.25	QP
4	154.5491	24.48	-10.39	14.09	43.50	-29.41	QP
5	287.9904	24.84	-9.40	15.44	46.00	-30.56	QP
6	782.3452	25.14	-0.90	24.24	46.00	-21.76	QP

Temperature:	26°C	Relative Humidity:	54%
Pressure:	101kPa	Polarization:	Vertical
Test Voltage:	DC 3.7V		

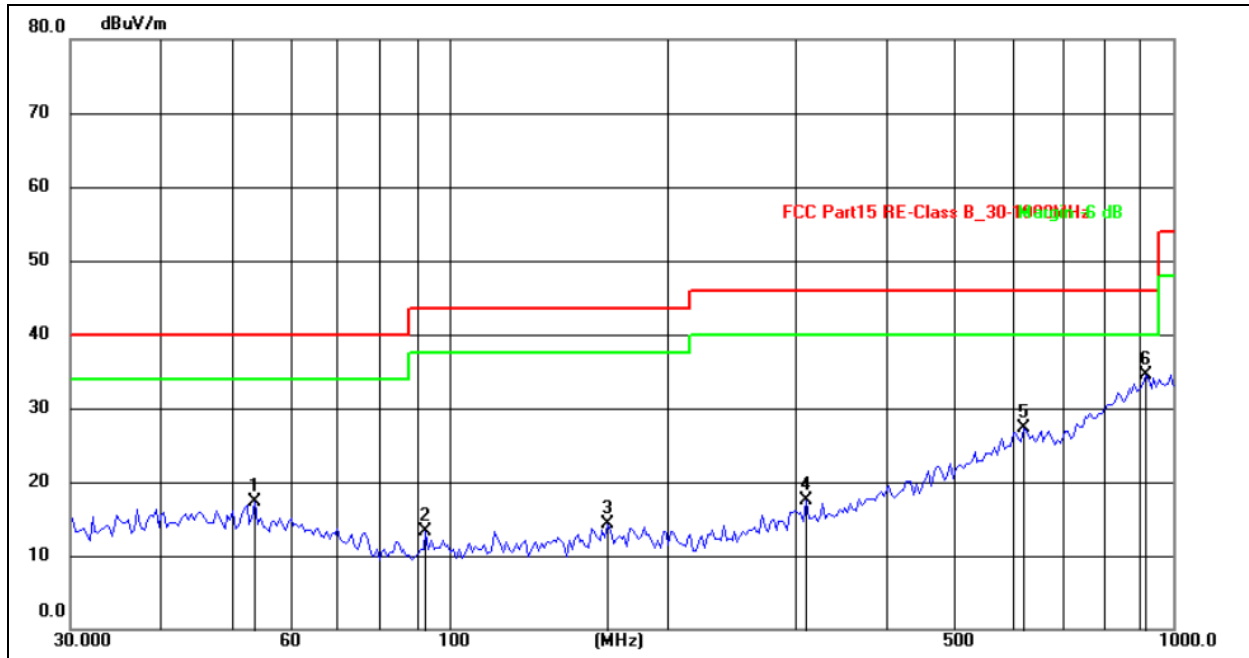

No.	Frequency (MHz)	Reading (dBuV)	Factor (dB/m)	Level (dBuV/m)	Limit (dBuV/m)	Margin (dB)	Detector
1	53.9763	28.98	-11.71	17.27	40.00	-22.73	QP
2	92.9500	28.63	-15.41	13.22	43.50	-30.28	QP
3	165.7771	28.44	-14.09	14.35	43.50	-29.15	QP
4	311.6325	29.40	-11.95	17.45	46.00	-28.55	QP
5	622.8900	28.99	-1.73	27.26	46.00	-18.74	QP
6	916.0686	29.14	5.35	34.49	46.00	-11.51	QP

Remarks:

1. Final Level = Receiver Read level + Antenna Factor + Cable Loss
2. The emission levels of other frequencies are very lower than the limit and not show in test report.
3. The test data shows only the worst case GFSK 2402MHz mode

1GHz~25GHz

GFSK

Polar (H/V)	Frequency	Meter Reading	Pre-amplifier	Cable Loss	Antenna Factor	Emission Level	Limits	Margin	Detector Type
	(MHz)	(dBuV)	(dB)	(dB)	(dB)	(dBuV/m)	(dBuV/m)	(dB)	
Low Channel:2402MHz									
V	4804.00	53.61	30.55	5.77	24.66	53.49	74.00	-20.51	Pk
V	4804.00	43.14	30.55	5.77	24.66	43.02	54.00	-10.98	AV
V	7206.00	53.41	30.33	6.32	24.55	53.95	74.00	-20.05	Pk
V	7206.00	43.33	30.33	6.32	24.55	43.87	54.00	-10.13	AV
V	9608.00	50.62	30.85	7.45	24.69	51.91	74.00	-22.09	Pk
V	9608.00	43.46	30.85	7.45	24.69	44.75	54.00	-9.25	AV
V	12010.00	50.96	31.02	8.99	25.57	54.50	74.00	-19.50	Pk
V	12010.00	43.58	31.02	8.99	25.57	47.12	54.00	-6.88	AV
H	4804.00	50.84	30.55	5.77	24.66	50.72	74.00	-23.28	Pk
H	4804.00	43.44	30.55	5.77	24.66	43.32	54.00	-10.68	AV
H	7206.00	52.04	30.33	6.32	24.55	52.58	74.00	-21.42	Pk
H	7206.00	43.59	30.33	6.32	24.55	44.13	54.00	-9.87	AV
H	9608.00	52.40	30.85	7.45	24.69	53.69	74.00	-20.31	Pk
H	9608.00	43.94	30.85	7.45	24.69	45.23	54.00	-8.77	AV
H	12010.00	54.58	31.02	8.99	25.57	58.12	74.00	-15.88	Pk
H	12010.00	43.97	31.02	8.99	25.57	47.51	54.00	-6.49	AV

Polar (H/V)	Frequency	Meter Reading	Pre-amplifier	Cable Loss	Antenna Factor	Emission Level	Limits	Margin	Detector Type
	(MHz)	(dBuV)	(dB)	(dB)	(dB)	(dBuV/m)	(dBuV/m)	(dB)	
Middle Channel:2441MHz									
V	4882.00	51.72	30.55	5.77	24.66	51.60	74.00	-22.40	Pk
V	4882.00	43.65	30.55	5.77	24.66	43.53	54.00	-10.47	AV
V	7323.00	50.91	30.33	6.32	24.55	51.45	74.00	-22.55	Pk
V	7323.00	43.61	30.33	6.32	24.55	44.15	54.00	-9.85	AV
V	9764.00	52.75	30.85	7.45	24.69	54.04	74.00	-19.96	Pk
V	9764.00	43.90	30.85	7.45	24.69	45.19	54.00	-8.81	AV
V	12205.00	53.05	31.02	8.99	25.57	56.59	74.00	-17.41	Pk
V	12205.00	43.19	31.02	8.99	25.57	46.73	54.00	-7.27	AV
H	4882.00	51.47	30.55	5.77	24.66	51.35	74.00	-22.65	Pk
H	4882.00	43.05	30.55	5.77	24.66	42.93	54.00	-11.07	AV
H	7323.00	51.73	30.33	6.32	24.55	52.27	74.00	-21.73	Pk
H	7323.00	43.25	30.33	6.32	24.55	43.79	54.00	-10.21	AV
H	9764.00	51.60	30.85	7.45	24.69	52.89	74.00	-21.11	Pk
H	9764.00	43.81	30.85	7.45	24.69	45.10	54.00	-8.90	AV
H	12205.00	53.92	31.02	8.99	25.57	57.46	74.00	-16.54	Pk
H	12205.00	43.28	31.02	8.99	25.57	46.82	54.00	-7.18	AV

Polar (H/V)	Frequency	Meter Reading	Pre-ampli fier	Cable Loss	Antenna Factor	Emission Level	Limits	Margin	Detector Type
	(MHz)	(dBuV)	(dB)	(dB)	(dB)	(dBuV/m)	(dBuV/m)	(dB)	
High Channel:2480MHz									
V	4960.00	53.73	30.55	5.77	24.66	53.61	74.00	-20.39	Pk
V	4960.00	43.14	30.55	5.77	24.66	43.02	54.00	-10.98	AV
V	7440.00	53.34	30.33	6.32	24.55	53.88	74.00	-20.12	Pk
V	7440.00	43.16	30.33	6.32	24.55	43.70	54.00	-10.30	AV
V	9920.00	50.19	30.85	7.45	24.69	51.48	74.00	-22.52	Pk
V	9920.00	43.36	30.85	7.45	24.69	44.65	54.00	-9.35	AV
V	12400.00	53.41	31.02	8.99	25.57	56.95	74.00	-17.05	Pk
V	12400.00	43.56	31.02	8.99	25.57	47.10	54.00	-6.90	AV
H	4960.00	52.65	30.55	5.77	24.66	52.53	74.00	-21.47	Pk
H	4960.00	43.90	30.55	5.77	24.66	43.78	54.00	-10.22	AV
H	7440.00	53.91	30.33	6.32	24.55	54.45	74.00	-19.55	Pk
H	7440.00	43.02	30.33	6.32	24.55	43.56	54.00	-10.44	AV
H	9920.00	52.81	30.85	7.45	24.69	54.10	74.00	-19.90	Pk
H	9920.00	43.10	30.85	7.45	24.69	44.39	54.00	-9.61	AV
H	12400.00	51.53	31.02	8.99	25.57	55.07	74.00	-18.93	Pk
H	12400.00	43.07	31.02	8.99	25.57	46.61	54.00	-7.39	AV

Remark:

1. Emission Level = Meter Reading + Antenna Factor + Cable Loss – Pre-amplifier,
Margin= Emission Level - Limit
2. If peak below the average limit, the average emission was no test.
3. The amplitude of spurious emissions which are attenuated by more than 20dB below the permissible value has no need to be reported.

$\pi/4$ -DQPSK

Polar (H/V)	Frequency	Meter Reading	Pre-amplifier	Cable Loss	Antenna Factor	Emission Level	Limits	Margin	Detector Type
	(MHz)	(dBuV)	(dB)	(dB)	(dB)	(dBuV/m)	(dBuV/m)	(dB)	
Low Channel:2402MHz									
V	4804.00	50.22	30.55	5.77	24.66	50.10	74.00	-23.90	Pk
V	4804.00	43.81	30.55	5.77	24.66	43.69	54.00	-10.31	AV
V	7206.00	53.38	30.33	6.32	24.55	53.92	74.00	-20.08	Pk
V	7206.00	43.14	30.33	6.32	24.55	43.68	54.00	-10.32	AV
V	9608.00	50.34	30.85	7.45	24.69	51.63	74.00	-22.37	Pk
V	9608.00	43.27	30.85	7.45	24.69	44.56	54.00	-9.44	AV
V	12010.00	52.38	31.02	8.99	25.57	55.92	74.00	-18.08	Pk
V	12010.00	43.16	31.02	8.99	25.57	46.70	54.00	-7.30	AV
H	4804.00	50.76	30.55	5.77	24.66	50.64	74.00	-23.36	Pk
H	4804.00	43.97	30.55	5.77	24.66	43.85	54.00	-10.15	AV
H	7206.00	52.31	30.33	6.32	24.55	52.85	74.00	-21.15	Pk
H	7206.00	43.48	30.33	6.32	24.55	44.02	54.00	-9.98	AV
H	9608.00	52.70	30.85	7.45	24.69	53.99	74.00	-20.01	Pk
H	9608.00	43.73	30.85	7.45	24.69	45.02	54.00	-8.98	AV
H	12010.00	53.23	31.02	8.99	25.57	56.77	74.00	-17.23	Pk
H	12010.00	43.05	31.02	8.99	25.57	46.59	54.00	-7.41	AV

Polar (H/V)	Frequency	Meter Reading	Pre-amplifier	Cable Loss	Antenna Factor	Emission Level	Limits	Margin	Detector Type
	(MHz)	(dBuV)	(dB)	(dB)	(dB)	(dBuV/m)	(dBuV/m)	(dB)	
Middle Channel:2441MHz									
V	4882.00	53.23	30.55	5.77	24.66	53.11	74.00	-20.89	Pk
V	4882.00	43.73	30.55	5.77	24.66	43.61	54.00	-10.39	AV
V	7323.00	54.59	30.33	6.32	24.55	55.13	74.00	-18.87	Pk
V	7323.00	43.96	30.33	6.32	24.55	44.50	54.00	-9.50	AV
V	9764.00	52.93	30.85	7.45	24.69	54.22	74.00	-19.78	Pk
V	9764.00	43.03	30.85	7.45	24.69	44.32	54.00	-9.68	AV
V	12205.00	52.86	31.02	8.99	25.57	56.40	74.00	-17.60	Pk
V	12205.00	43.67	31.02	8.99	25.57	47.21	54.00	-6.79	AV
H	4882.00	52.15	30.55	5.77	24.66	52.03	74.00	-21.97	Pk
H	4882.00	43.56	30.55	5.77	24.66	43.44	54.00	-10.56	AV
H	7323.00	54.47	30.33	6.32	24.55	55.01	74.00	-18.99	Pk
H	7323.00	43.76	30.33	6.32	24.55	44.30	54.00	-9.70	AV
H	9764.00	54.55	30.85	7.45	24.69	55.84	74.00	-18.16	Pk
H	9764.00	43.89	30.85	7.45	24.69	45.18	54.00	-8.82	AV
H	12205.00	50.37	31.02	8.99	25.57	53.91	74.00	-20.09	Pk
H	12205.00	43.12	31.02	8.99	25.57	46.66	54.00	-7.34	AV

Polar (H/V)	Frequency	Meter Reading	Pre-ampli fier	Cable Loss	Antenna Factor	Emission Level	Limits	Margin	Detector Type
	(MHz)	(dBuV)	(dB)	(dB)	(dB)	(dBuV/m)	(dBuV/m)	(dB)	
High Channel:2480MHz									
V	4960.00	52.41	30.55	5.77	24.66	52.29	74.00	-21.71	Pk
V	4960.00	43.27	30.55	5.77	24.66	43.15	54.00	-10.85	AV
V	7440.00	52.13	30.33	6.32	24.55	52.67	74.00	-21.33	Pk
V	7440.00	43.77	30.33	6.32	24.55	44.31	54.00	-9.69	AV
V	9920.00	50.94	30.85	7.45	24.69	52.23	74.00	-21.77	Pk
V	9920.00	43.29	30.85	7.45	24.69	44.58	54.00	-9.42	AV
V	12400.00	51.02	31.02	8.99	25.57	54.56	74.00	-19.44	Pk
V	12400.00	43.54	31.02	8.99	25.57	47.08	54.00	-6.92	AV
H	4960.00	53.59	30.55	5.77	24.66	53.47	74.00	-20.53	Pk
H	4960.00	43.69	30.55	5.77	24.66	43.57	54.00	-10.43	AV
H	7440.00	50.34	30.33	6.32	24.55	50.88	74.00	-23.12	Pk
H	7440.00	43.53	30.33	6.32	24.55	44.07	54.00	-9.93	AV
H	9920.00	52.33	30.85	7.45	24.69	53.62	74.00	-20.38	Pk
H	9920.00	43.21	30.85	7.45	24.69	44.50	54.00	-9.50	AV
H	12400.00	54.81	31.02	8.99	25.57	58.35	74.00	-15.65	Pk
H	12400.00	43.45	31.02	8.99	25.57	46.99	54.00	-7.01	AV

Remark:

1. Emission Level = Meter Reading + Antenna Factor + Cable Loss – Pre-amplifier,
Margin= Emission Level - Limit
2. If peak below the average limit, the average emission was no test.
3. The amplitude of spurious emissions which are attenuated by more than 20dB below the permissible value has no need to be reported.

8-DPSK

Polar (H/V)	Frequency	Meter Reading	Pre-amplifier	Cable Loss	Antenna Factor	Emission Level	Limits	Margin	Detector Type
	(MHz)	(dBuV)	(dB)	(dB)	(dB)	(dBuV/m)	(dBuV/m)	(dB)	
Low Channel:2402MHz									
V	4804.00	52.10	30.55	5.77	24.66	51.98	74.00	-22.02	Pk
V	4804.00	43.56	30.55	5.77	24.66	43.44	54.00	-10.56	AV
V	7206.00	52.65	30.33	6.32	24.55	53.19	74.00	-20.81	Pk
V	7206.00	43.31	30.33	6.32	24.55	43.85	54.00	-10.15	AV
V	9608.00	54.69	30.85	7.45	24.69	55.98	74.00	-18.02	Pk
V	9608.00	43.15	30.85	7.45	24.69	44.44	54.00	-9.56	AV
V	12010.00	54.87	31.02	8.99	25.57	58.41	74.00	-15.59	Pk
V	12010.00	43.68	31.02	8.99	25.57	47.22	54.00	-6.78	AV
H	4804.00	53.35	30.55	5.77	24.66	53.23	74.00	-20.77	Pk
H	4804.00	43.28	30.55	5.77	24.66	43.16	54.00	-10.84	AV
H	7206.00	52.62	30.33	6.32	24.55	53.16	74.00	-20.84	Pk
H	7206.00	43.62	30.33	6.32	24.55	44.16	54.00	-9.84	AV
H	9608.00	51.03	30.85	7.45	24.69	52.32	74.00	-21.68	Pk
H	9608.00	43.18	30.85	7.45	24.69	44.47	54.00	-9.53	AV
H	12010.00	52.42	31.02	8.99	25.57	55.96	74.00	-18.04	Pk
H	12010.00	43.06	31.02	8.99	25.57	46.60	54.00	-7.40	AV

Polar (H/V)	Frequency	Meter Reading	Pre-amplifier	Cable Loss	Antenna Factor	Emission Level	Limits	Margin	Detector Type
	(MHz)	(dBuV)	(dB)	(dB)	(dB)	(dBuV/m)	(dBuV/m)	(dB)	
Middle Channel:2441MHz									
V	4882.00	53.72	30.55	5.77	24.66	53.60	74.00	-20.40	Pk
V	4882.00	43.67	30.55	5.77	24.66	43.55	54.00	-10.45	AV
V	7323.00	52.82	30.33	6.32	24.55	53.36	74.00	-20.64	Pk
V	7323.00	43.04	30.33	6.32	24.55	43.58	54.00	-10.42	AV
V	9764.00	54.27	30.85	7.45	24.69	55.56	74.00	-18.44	Pk
V	9764.00	43.92	30.85	7.45	24.69	45.21	54.00	-8.79	AV
V	12205.00	50.16	31.02	8.99	25.57	53.70	74.00	-20.30	Pk
V	12205.00	43.69	31.02	8.99	25.57	47.23	54.00	-6.77	AV
H	4882.00	54.64	30.55	5.77	24.66	54.52	74.00	-19.48	Pk
H	4882.00	43.96	30.55	5.77	24.66	43.84	54.00	-10.16	AV
H	7323.00	53.58	30.33	6.32	24.55	54.12	74.00	-19.88	Pk
H	7323.00	43.62	30.33	6.32	24.55	44.16	54.00	-9.84	AV
H	9764.00	52.97	30.85	7.45	24.69	54.26	74.00	-19.74	Pk
H	9764.00	43.56	30.85	7.45	24.69	44.85	54.00	-9.15	AV
H	12205.00	53.38	31.02	8.99	25.57	56.92	74.00	-17.08	Pk
H	12205.00	43.01	31.02	8.99	25.57	46.55	54.00	-7.45	AV

Polar (H/V)	Frequency	Meter Reading	Pre-ampli fier	Cable Loss	Antenna Factor	Emission Level	Limits	Margin	Detector Type
	(MHz)	(dBuV)	(dB)	(dB)	(dB)	(dBuV/m)	(dBuV/m)	(dB)	
High Channel:2480MHz									
V	4960.00	54.40	30.55	5.77	24.66	54.28	74.00	-19.72	Pk
V	4960.00	43.65	30.55	5.77	24.66	43.53	54.00	-10.47	AV
V	7440.00	53.49	30.33	6.32	24.55	54.03	74.00	-19.97	Pk
V	7440.00	43.29	30.33	6.32	24.55	43.83	54.00	-10.17	AV
V	9920.00	50.71	30.85	7.45	24.69	52.00	74.00	-22.00	Pk
V	9920.00	43.78	30.85	7.45	24.69	45.07	54.00	-8.93	AV
V	12400.00	54.14	31.02	8.99	25.57	57.68	74.00	-16.32	Pk
V	12400.00	43.69	31.02	8.99	25.57	47.23	54.00	-6.77	AV
H	4960.00	50.99	30.55	5.77	24.66	50.87	74.00	-23.13	Pk
H	4960.00	43.74	30.55	5.77	24.66	43.62	54.00	-10.38	AV
H	7440.00	53.16	30.33	6.32	24.55	53.70	74.00	-20.30	Pk
H	7440.00	43.57	30.33	6.32	24.55	44.11	54.00	-9.89	AV
H	9920.00	51.28	30.85	7.45	24.69	52.57	74.00	-21.43	Pk
H	9920.00	43.34	30.85	7.45	24.69	44.63	54.00	-9.37	AV
H	12400.00	51.32	31.02	8.99	25.57	54.86	74.00	-19.14	Pk
H	12400.00	43.42	31.02	8.99	25.57	46.96	54.00	-7.04	AV

Remark:

1. Emission Level = Meter Reading + Antenna Factor + Cable Loss – Pre-amplifier,
Margin= Emission Level - Limit
2. If peak below the average limit, the average emission was no test.
3. The amplitude of spurious emissions which are attenuated by more than 20dB below the permissible value has no need to be reported.

5. RADIATED BAND EMISSION MEASUREMENT

5.1 Test Requirement:

Test Requirement:	FCC Part15 C Section 15.209 and 15.205				
Test Method:	ANSI C63.10: 2013				
Test Frequency Range:	All of the restrict bands were tested, only the worst band's (2310MHz to 2500MHz) data was showed.				
Test site:	Measurement Distance: 3m				
Receiver setup:	Frequency	Detector	RBW	VBW	Value
	Above 1GHz	Peak	1MHz	3MHz	Peak
		Average	1MHz	3MHz	Average

LIMITS OF RADIATED EMISSION MEASUREMENT (Above 1000MHz)

FREQUENCY (MHz)	Limit (dBuV/m) (at 3M)	
	PEAK	AVERAGE
Above 1000	74	54

Notes:

- (1) The limit for radiated test was performed according to FCC PART 15C.
- (2) The tighter limit applies at the band edges.
- (3) Emission level (dBuV/m)=20log Emission level (uV/m).

Spectrum Parameter	Setting
Attenuation	Auto
Start Frequency	2300MHz
Stop Frequency	2520
RB / VB (emission in restricted band)	1 MHz / 1 MHz for Peak, 1 MHz / 10Hz for Average

5.2 TEST PROCEDURE

Above 1GHz test procedure as below:

- a. 1. The EUT was placed on the top of a rotating table 1.5 meters above the ground at a 3 meter camber. The table was rotated 360 degrees to determine the position of the highest radiation.
- b. The EUT was set 3 meters away from the interference-receiving antenna, which was mounted on the top of a variable-height antenna tower.
- c. The antenna height is varied from one meter to four meters above the ground to determine the maximum value of the field strength. Both horizontal and vertical polarizations of the antenna are set to make the measurement.
- d. For each suspected emission, the EUT was arranged to its worst case and then the antenna was tuned to heights from 1 meter to 4 meters and the rota table was turned from 0 degrees to 360 degrees to find the maximum reading.
- e. The test-receiver system was set to Peak Detect Function and Specified Bandwidth with Maximum Hold Mode.
- f. If the emission level of the EUT in peak mode was 10dB lower than the limit specified, then testing could be stopped and the peak values of the EUT would be reported. Otherwise the emissions that did not have 10dB margin would be re-tested one by one using peak, quasi-peak or average method as specified and then reported in a data sheet.
- g. Test the EUT in the lowest channel, the Highest channel

Note:

Both horizontal and vertical antenna polarities were tested and performed pretest to three orthogonal axis. The worst case emissions were reported

5.3 DEVIATION FROM TEST STANDARD

No deviation

5.4 TEST SETUP

Radiated Emission Test-Up Frequency Above 1GHz

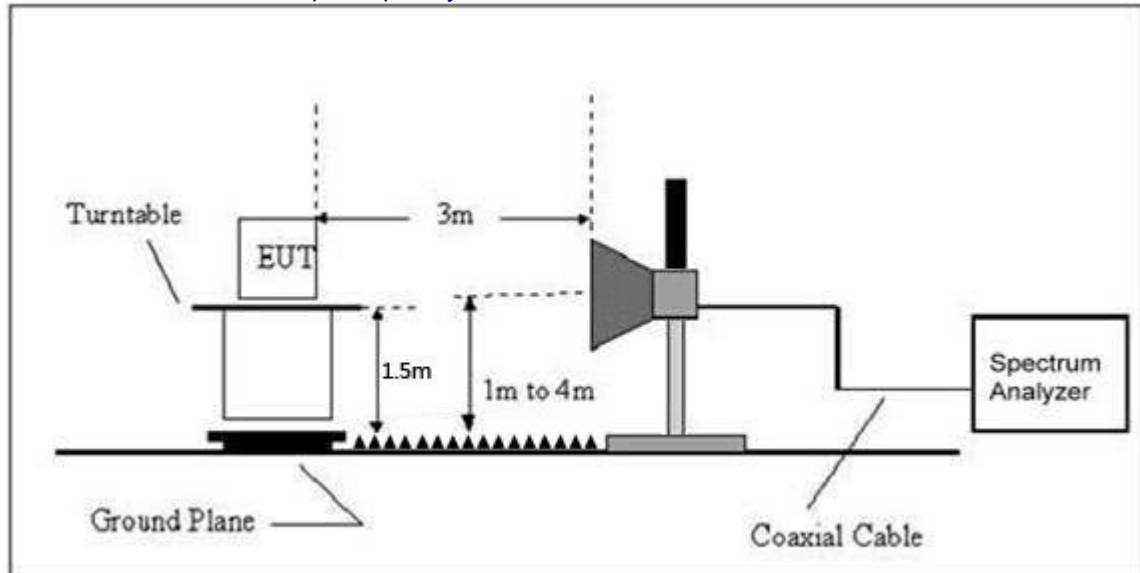

5.5 EUT OPERATING CONDITIONS

The EUT tested system was configured as the statements of 2.3 Unless otherwise a special operating condition is specified in the follows during the testing.

5.6 TEST RESULT

	Polar (H/V)	Frequency (MHz)	Meter Reading (dBuV)	Pre-amplifier (dB)	Cable Loss (dB)	Antenna Factor (dB/m)	Emission level (dBuV/m)	Limit (dBuV/m)	Detector Type	Result
GFSK	Low Channel: 2402MHz									
	H	2390.00	53.74	30.22	4.85	23.98	52.35	74.00	PK	PASS
	H	2390.00	44.52	30.22	4.85	23.98	43.13	54.00	AV	PASS
	H	2400.00	54.07	30.22	4.85	23.98	52.68	74.00	PK	PASS
	H	2400.00	44.46	30.22	4.85	23.98	43.07	54.00	AV	PASS
	V	2390.00	54.41	30.22	4.85	23.98	53.02	74.00	PK	PASS
	V	2390.00	44.36	30.22	4.85	23.98	42.97	54.00	AV	PASS
	V	2400.00	53.64	30.22	4.85	23.98	52.25	74.00	PK	PASS
	V	2400.00	44.11	30.22	4.85	23.98	42.72	54.00	AV	PASS
	High Channel: 2480MHz									
	H	2483.50	53.82	30.22	4.85	23.98	52.43	74.00	Pk	PASS
	H	2483.50	44.93	30.22	4.85	23.98	43.54	54.00	AV	PASS
	H	2500.00	53.88	30.22	4.85	23.98	52.49	74.00	Pk	PASS
	H	2500.00	44.86	30.22	4.85	23.98	43.47	54.00	AV	PASS
	V	2483.50	54.55	30.22	4.85	23.98	53.16	74.00	Pk	PASS
	V	2483.50	44.08	30.22	4.85	23.98	42.69	54.00	AV	PASS
V	2500.00	53.89	30.22	4.85	23.98	52.50	74.00	Pk	PASS	
V	2500.00	44.29	30.22	4.85	23.98	42.90	54.00	AV	PASS	
π/4-DQPSK	Low Channel: 2402MHz									
	H	2390.00	53.75	30.22	4.85	23.98	52.36	74.00	PK	PASS
	H	2390.00	44.23	30.22	4.85	23.98	42.84	54.00	AV	PASS
	H	2400.00	54.14	30.22	4.85	23.98	52.75	74.00	PK	PASS
	H	2400.00	44.90	30.22	4.85	23.98	43.51	54.00	AV	PASS
	V	2390.00	54.43	30.22	4.85	23.98	53.04	74.00	PK	PASS
	V	2390.00	44.42	30.22	4.85	23.98	43.03	54.00	AV	PASS
	V	2400.00	54.73	30.22	4.85	23.98	53.34	74.00	PK	PASS
	V	2400.00	44.11	30.22	4.85	23.98	42.72	54.00	AV	PASS
	High Channel: 2480MHz									
	H	2483.50	54.43	30.22	4.85	23.98	53.04	74.00	PK	PASS
	H	2483.50	44.68	30.22	4.85	23.98	43.29	54.00	AV	PASS
	H	2500.00	53.28	30.22	4.85	23.98	51.89	74.00	PK	PASS
	H	2500.00	44.63	30.22	4.85	23.98	43.24	54.00	AV	PASS
	V	2483.50	54.21	30.22	4.85	23.98	52.82	74.00	PK	PASS
	V	2483.50	44.00	30.22	4.85	23.98	42.61	54.00	AV	PASS
V	2500.00	54.68	30.22	4.85	23.98	53.29	74.00	PK	PASS	
V	2500.00	44.48	30.22	4.85	23.98	43.09	54.00	AV	PASS	
8-DPSK	Low Channel: 2402MHz									
	H	2390.00	53.90	30.22	4.85	23.98	52.51	74.00	PK	PASS
	H	2390.00	44.96	30.22	4.85	23.98	43.57	54.00	AV	PASS
	H	2400.00	53.32	30.22	4.85	23.98	51.93	74.00	PK	PASS
	H	2400.00	44.11	30.22	4.85	23.98	42.72	54.00	AV	PASS
	V	2390.00	54.64	30.22	4.85	23.98	53.25	74.00	PK	PASS
	V	2390.00	44.31	30.22	4.85	23.98	42.92	54.00	AV	PASS
	V	2400.00	54.23	30.22	4.85	23.98	52.84	74.00	PK	PASS
	V	2400.00	44.43	30.22	4.85	23.98	43.04	54.00	AV	PASS
	High Channel: 2480MHz									
	H	2483.50	54.53	30.22	4.85	23.98	53.14	74.00	PK	PASS
	H	2483.50	44.31	30.22	4.85	23.98	42.92	54.00	AV	PASS
	H	2500.00	53.69	30.22	4.85	23.98	52.30	74.00	PK	PASS
	H	2500.00	44.29	30.22	4.85	23.98	42.90	54.00	AV	PASS
	V	2483.50	53.52	30.22	4.85	23.98	52.13	74.00	PK	PASS
	V	2483.50	44.19	30.22	4.85	23.98	42.80	54.00	AV	PASS

	V	2500.00	53.26	30.22	4.85	23.98	51.87	74.00	PK	PASS
	V	2500.00	44.39	30.22	4.85	23.98	43.00	54.00	AV	PASS

Remark:

1. Emission Level = Meter Reading + Antenna Factor + Cable Loss – Pre-amplifier, Margin= Emission Level - Limit

6. CONDUCTED BAND EDGE AND SPURIOUS EMISSION

Test Requirement:	FCC Part15 C Section 15.247 (d)
Test Method:	KDB558074 D0115.247 Meas Guidancev05r02

6.1 Limit

Regulation 15.247 (d), In any 100 kHz bandwidth outside the frequency band in which the spread spectrum or digitally modulated intentional radiator is operating, the radio frequency power that is produced by the intentional radiator shall be at least 20 dB below that in the 100 kHz bandwidth within the band that contains the highest level of the desired power, based on either an RF conducted or a radiated measurement, provided the transmitter demonstrates compliance with the peak conducted power limits. If the transmitter complies with the conducted power limits based on the use of RMS averaging over a time interval, as permitted under paragraph (b)(3) of this section, the attenuation required under this paragraph shall be 30 dB instead of 20 dB. Attenuation below the general limits specified in §15.209(a) is not required. In addition, radiated emissions which fall in the restricted bands, as defined in §15.205(a), must also comply with the radiated emission limits specified in §15.209(a) (see §15.205(c)).

6.2 Test Setup

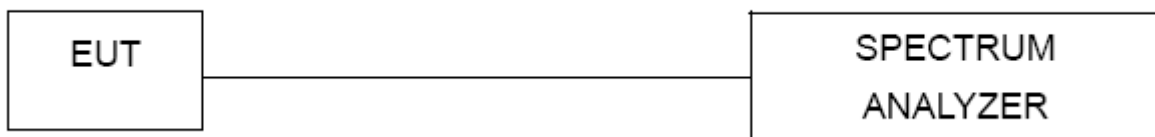

6.3 Test procedure

Using the following spectrum analyzer setting:

- A) Set the RBW = 100KHz.
- B) Set the VBW = 300KHz.
- C) Sweep time = auto couple.
- D) Detector function = peak.
- E) Trace mode = max hold.
- F) Allow trace to fully stabilize.

6.4 DEVIATION FROM STANDARD

No deviation.

6.5 Test Result

GFSK mode:

Test channel:	Lowest channel
---------------	----------------

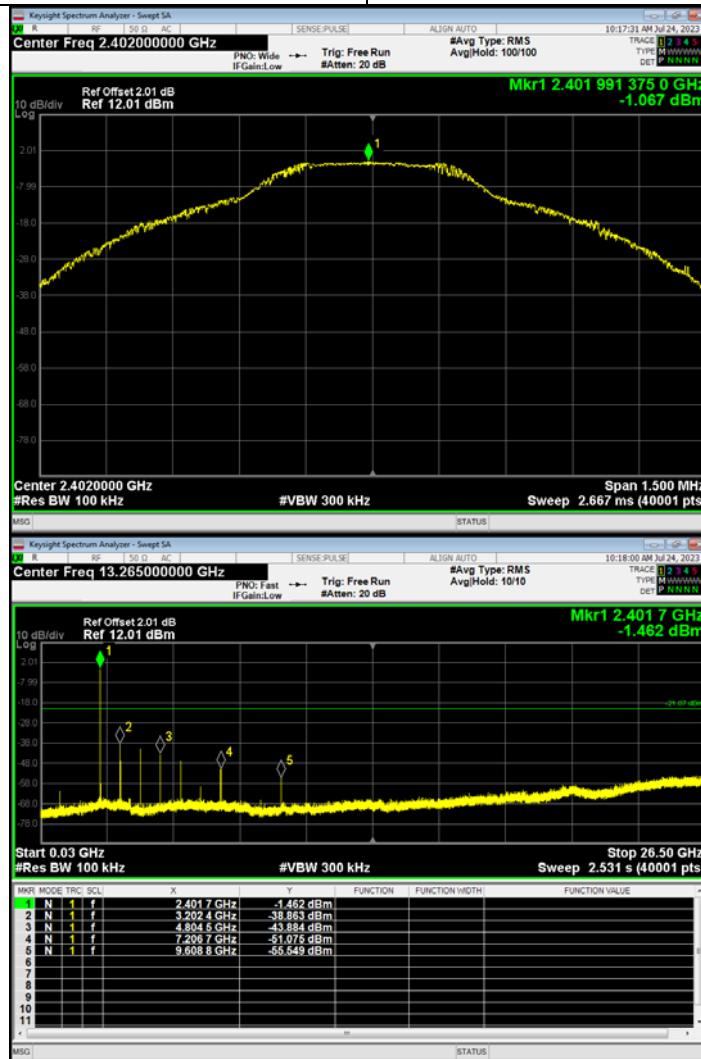

30MHz~26.5GHz

Test channel: Middle channel

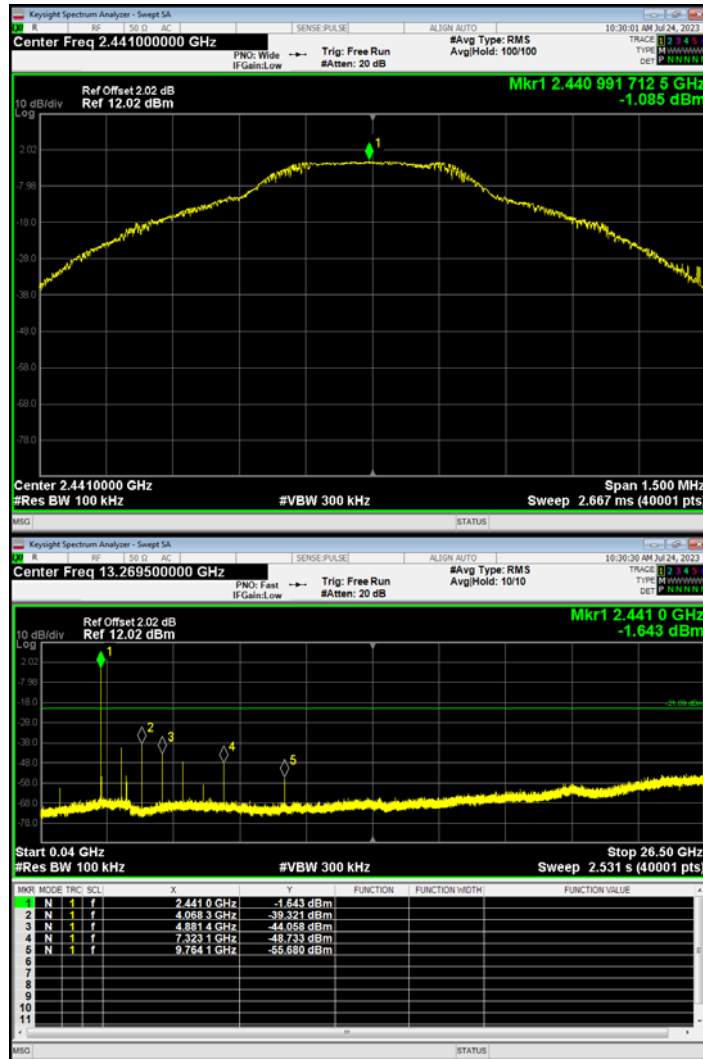

30MHz~26.5GHz

Test channel: Highest channel

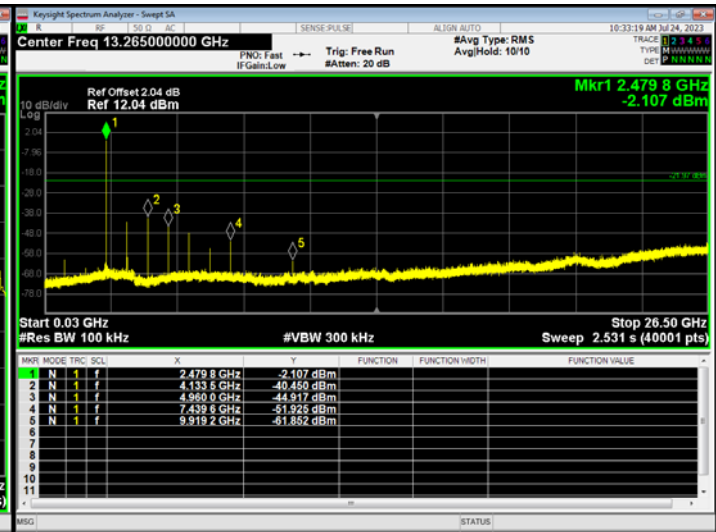
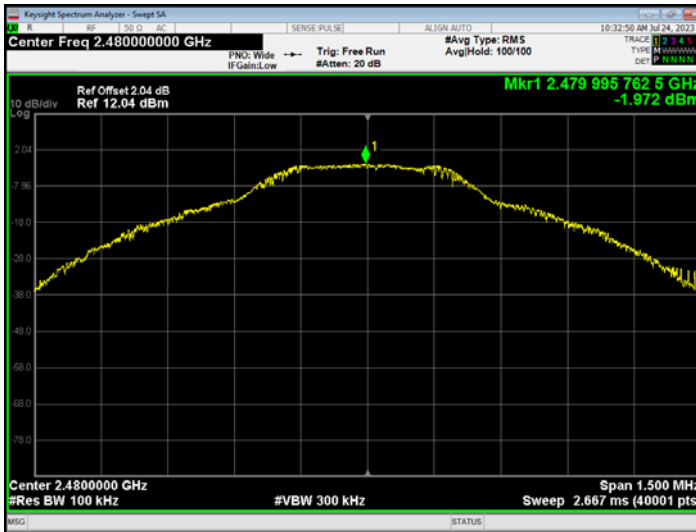

30MHz~26.5GHz

$\pi/4$ -DQPSK mode:

Test channel:	Lowest channel
---------------	----------------

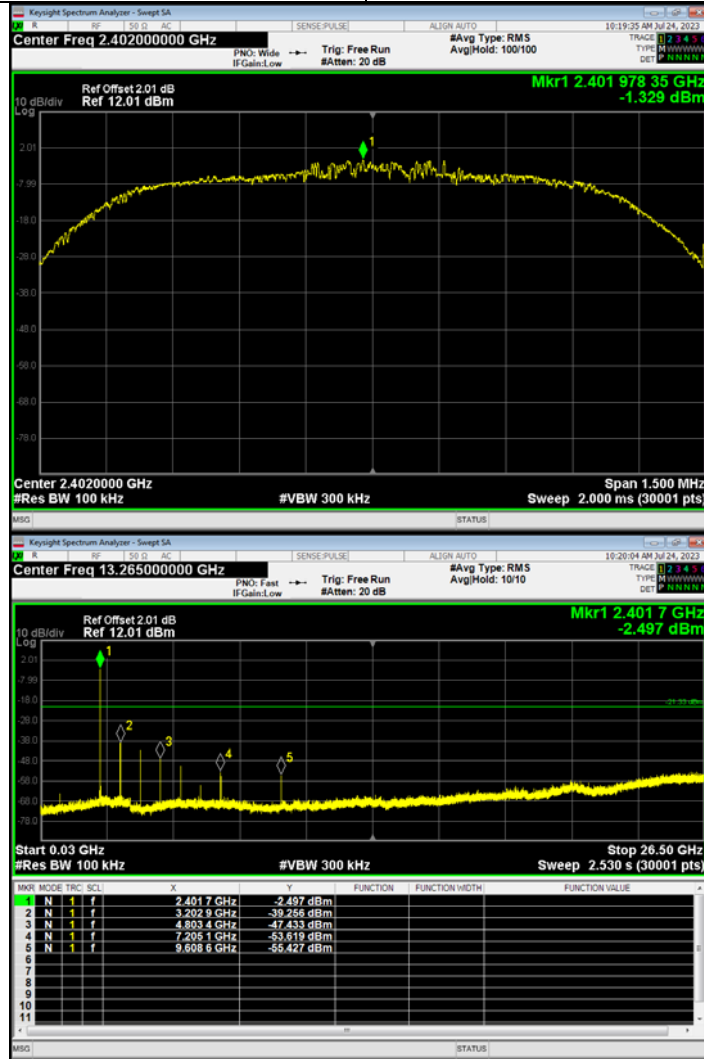

30MHz~26.5GHz

Test channel: Middle channel

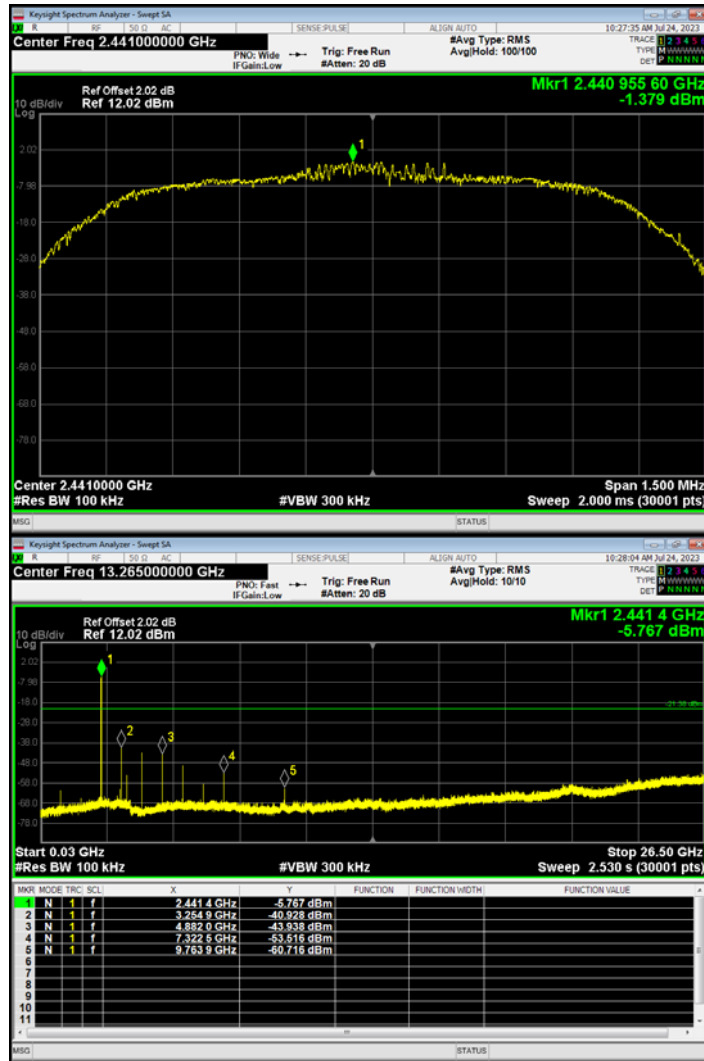

30MHz~26.5GHz

Test channel: _____ Highest channel _____

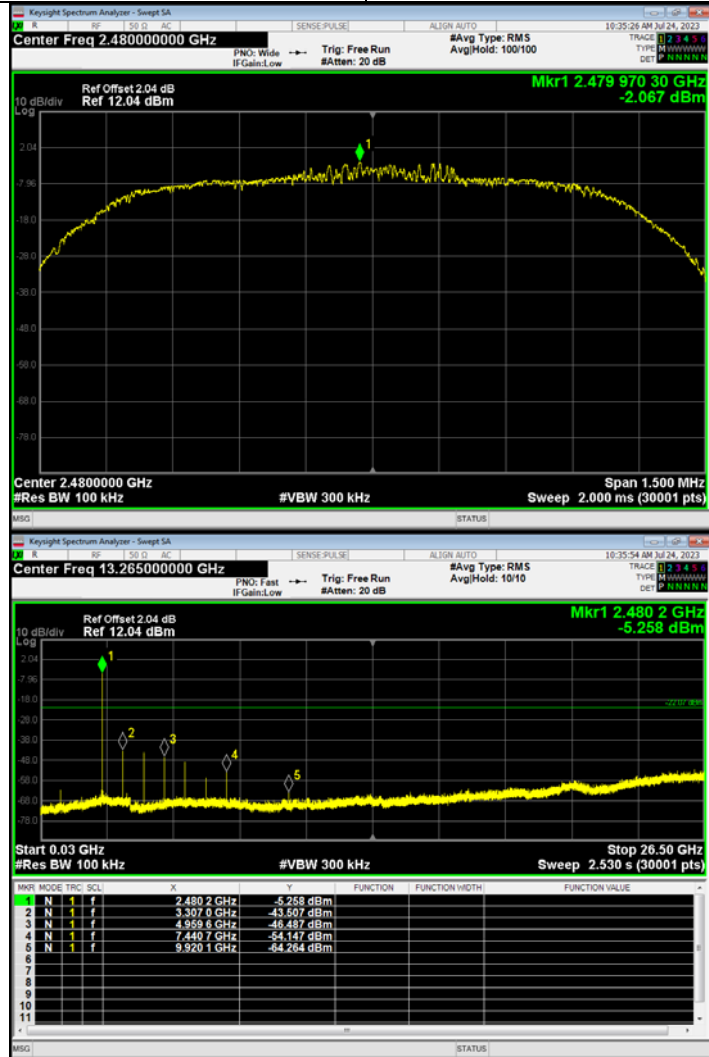

30MHz~26.5GHz

8-DPSK mode:

Test channel:	Lowest channel
---------------	----------------

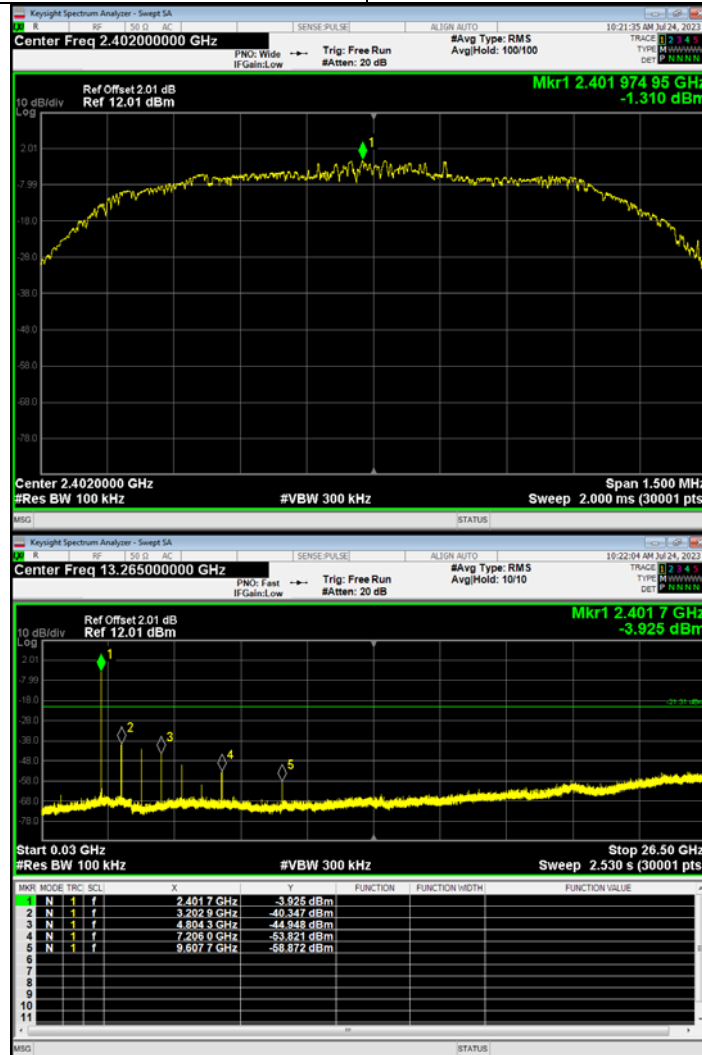

30MHz~26.5GHz

Test channel: Middle channel

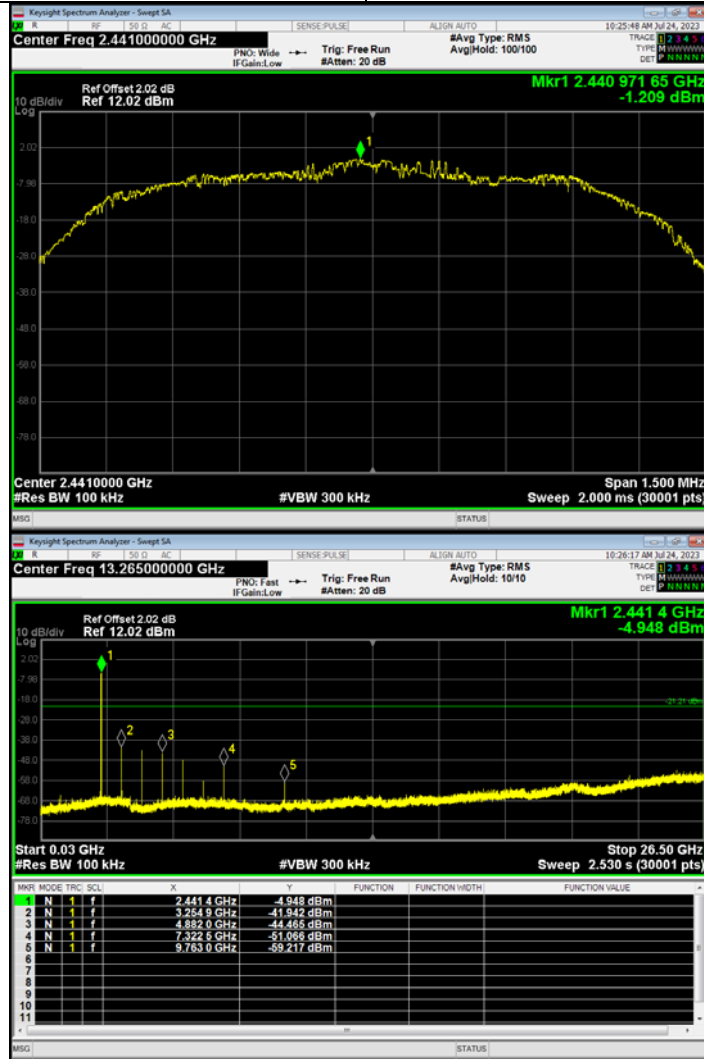

30MHz~26.5GHz

Test channel: Highest channel

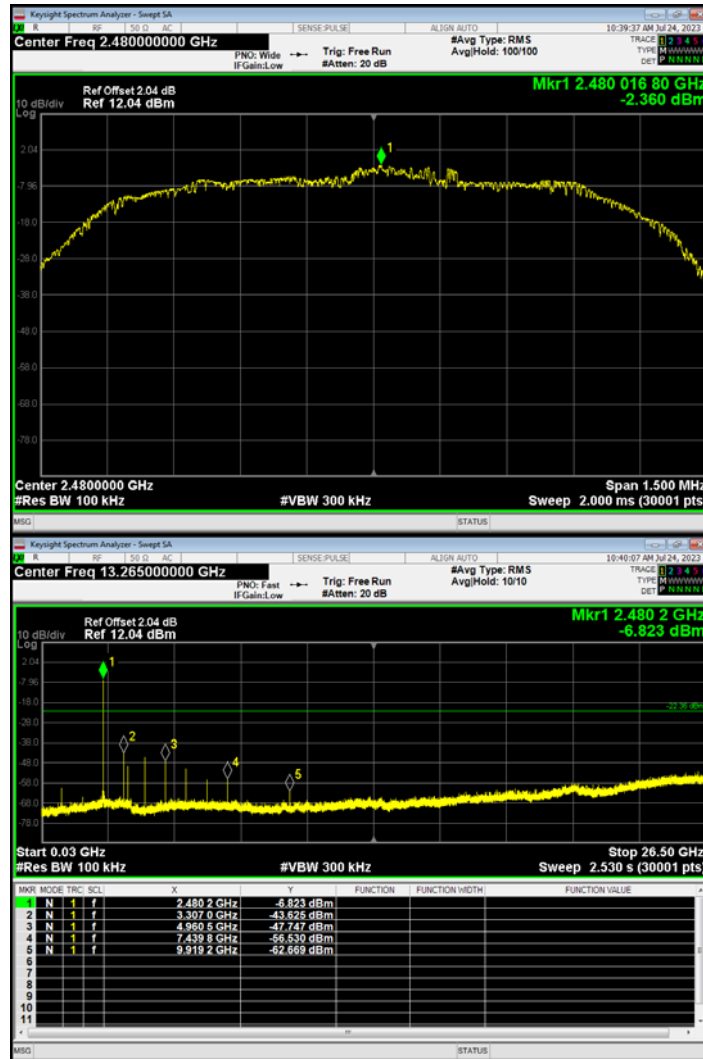

30MHz~26.5GHz

GFSK No-hopping Band edge-left side

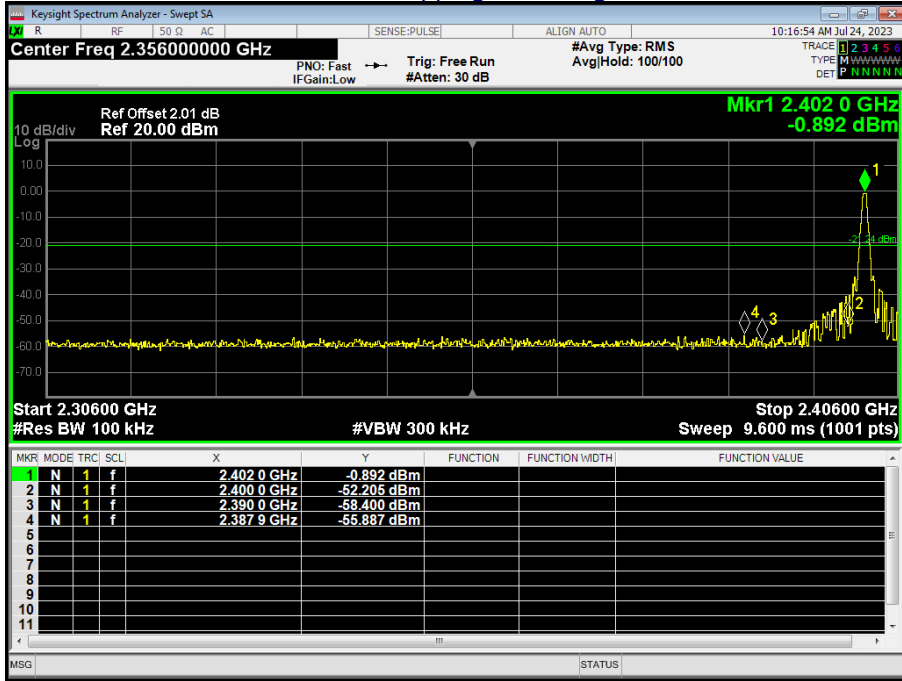

GFSK Hopping Band edge-left side

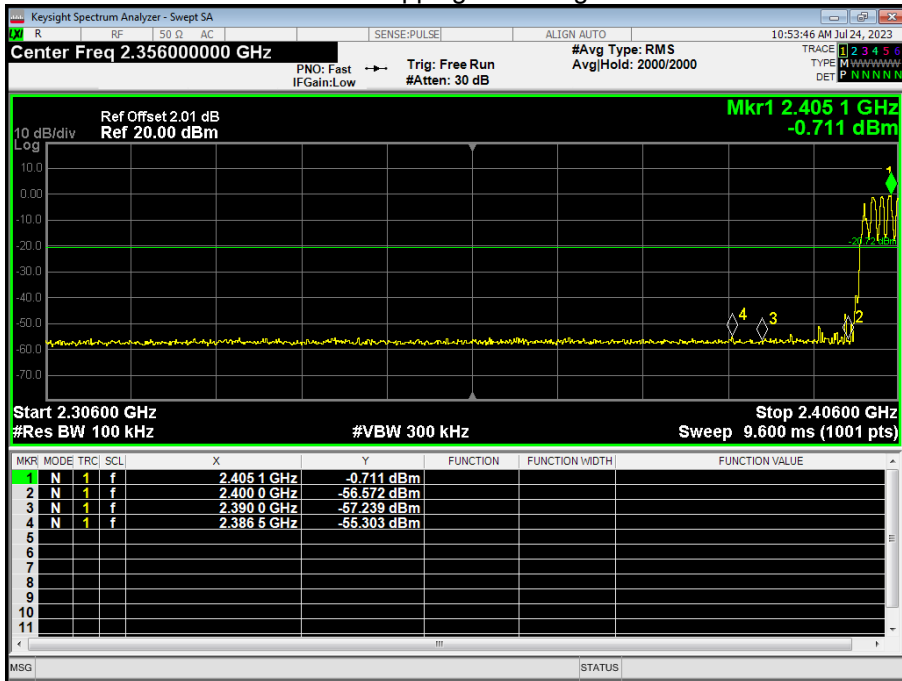

GFSK No-hopping Band edge-right side

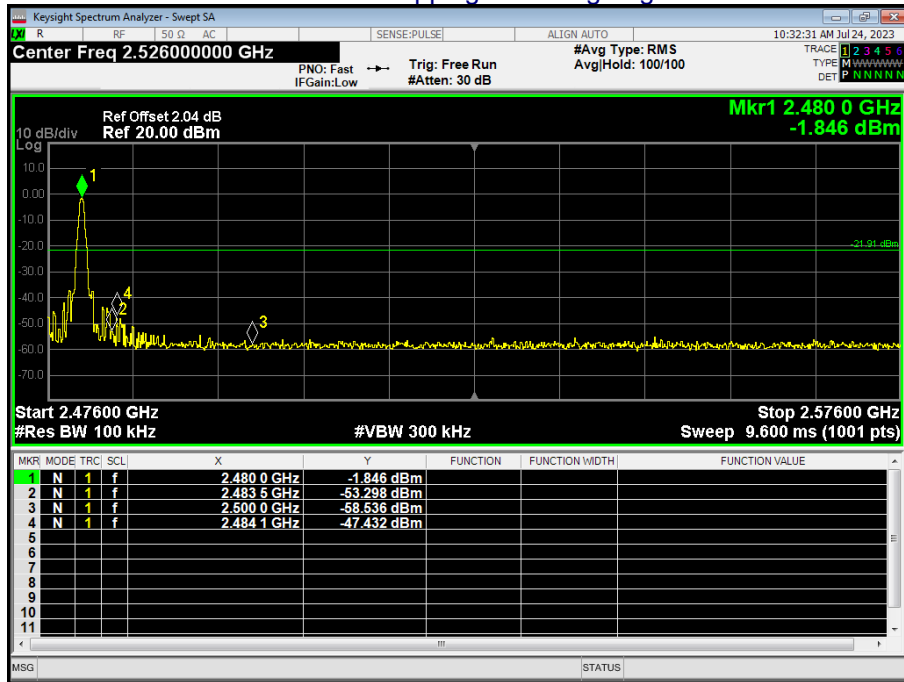

GFSK Hopping Band edge-right side

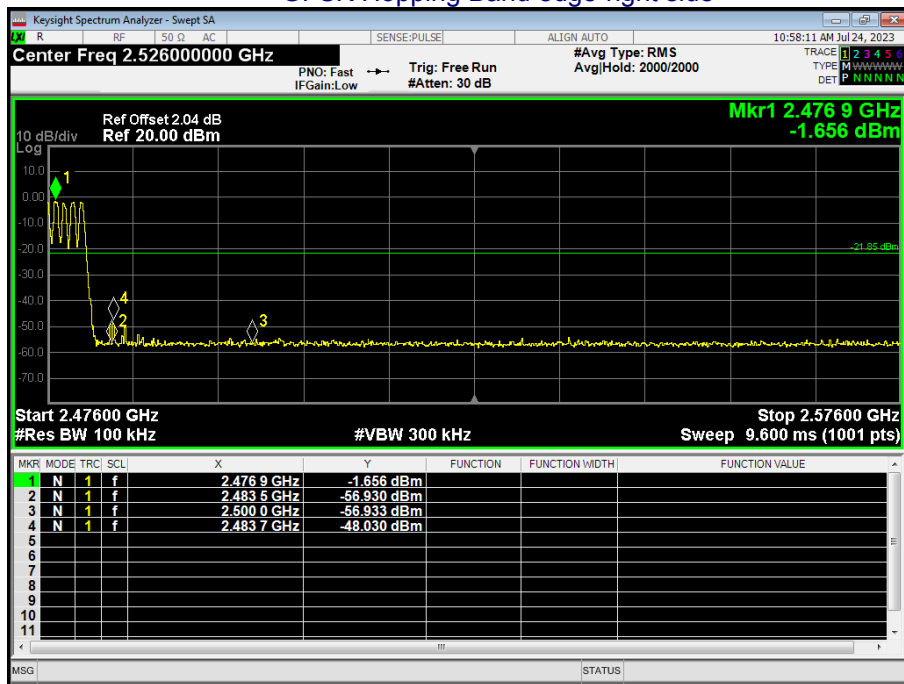

$\pi/4$ -DQPSK No-hopping Band edge-left side

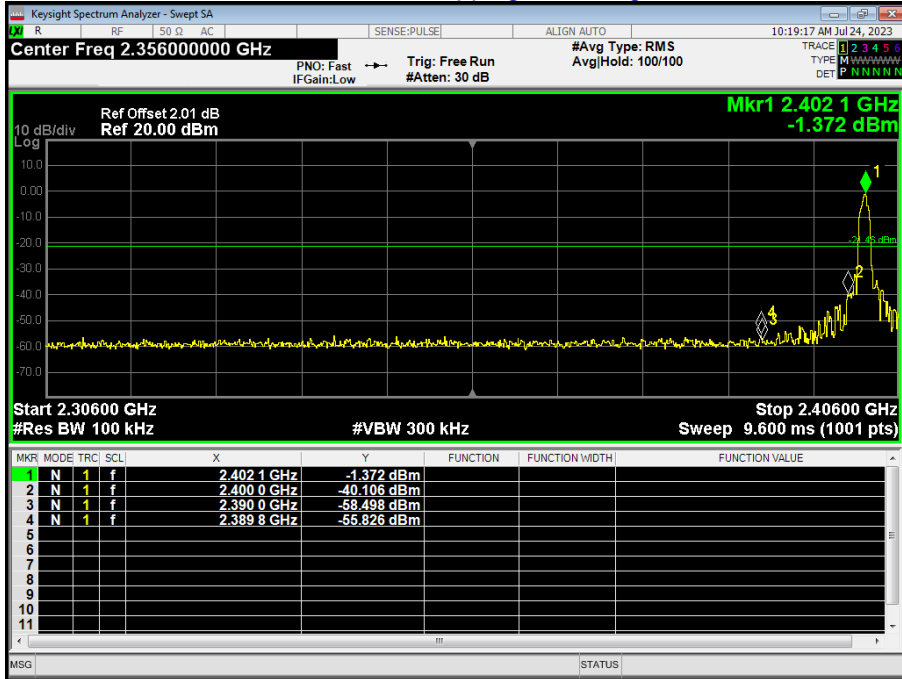

$\pi/4$ -DQPSK Hopping Band edge-left side

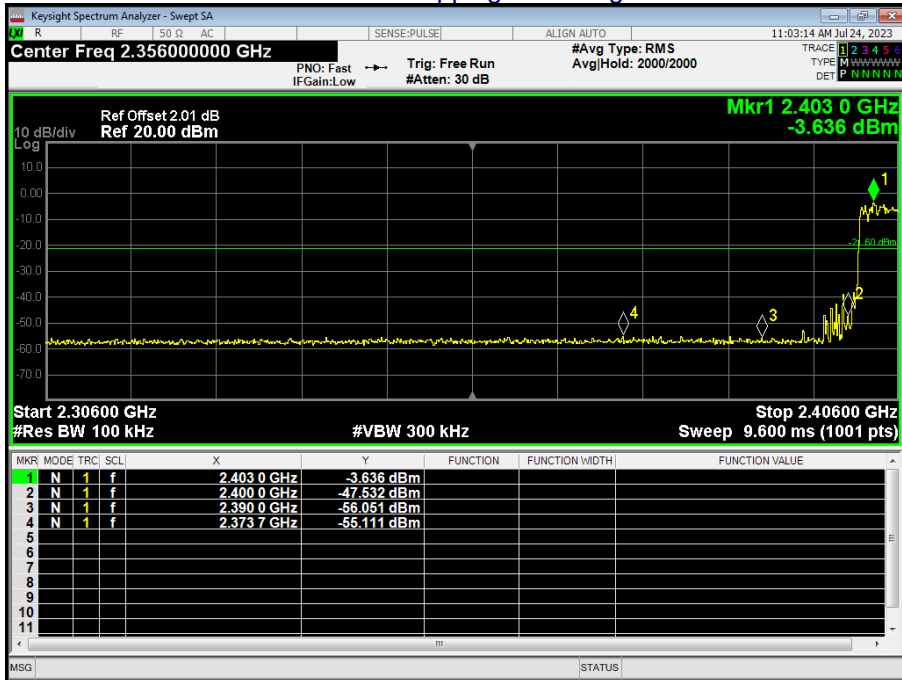

$\pi/4$ -DQPSK No-hopping Band edge-right side

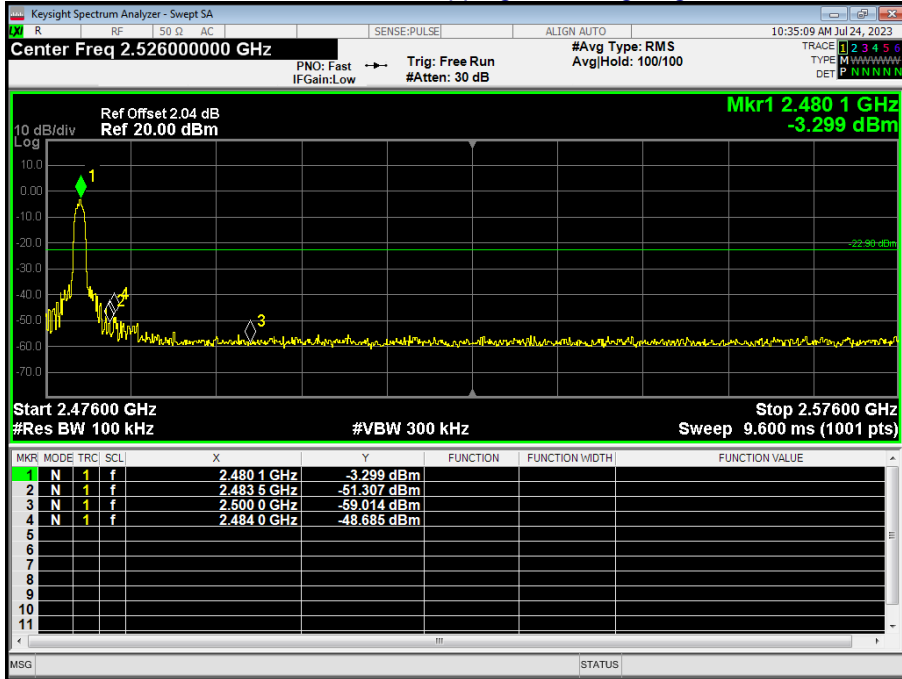

$\pi/4$ -DQPSK Hopping Band edge-right side

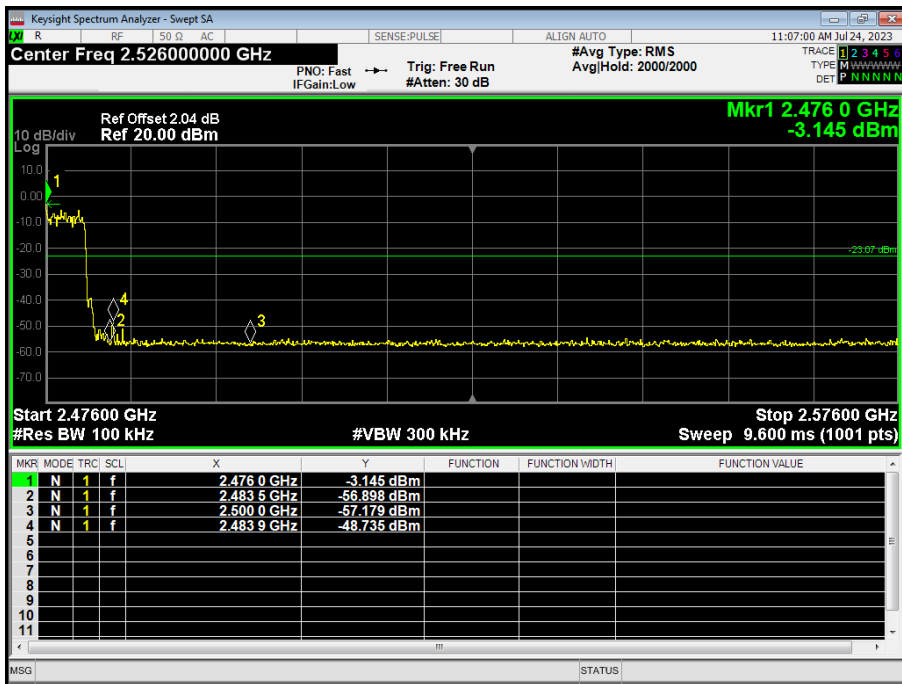

8-DPSK No-hopping Band edge-left side

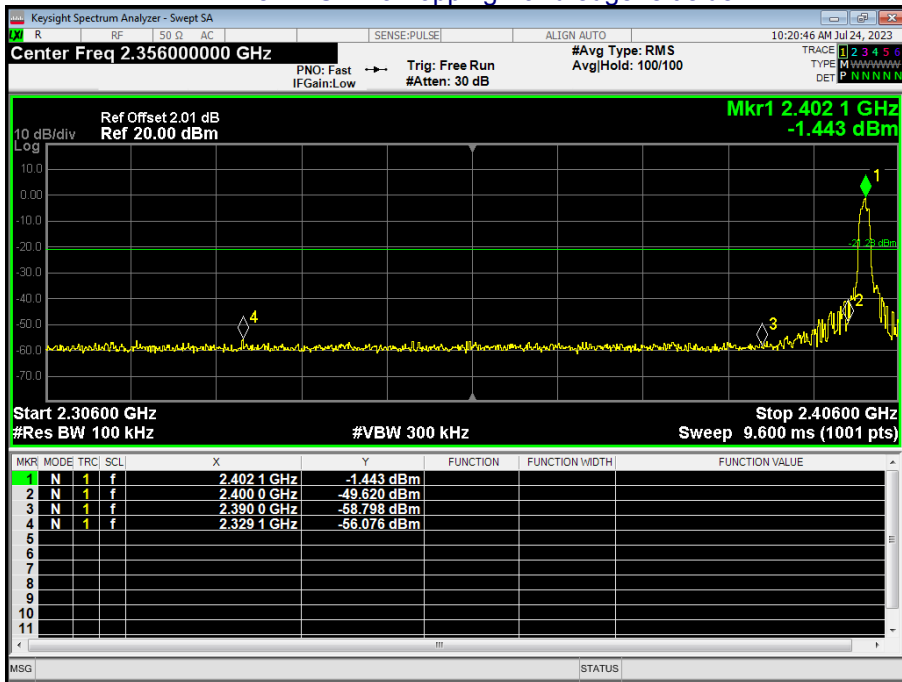

8-DPSK Hopping Band edge-left side

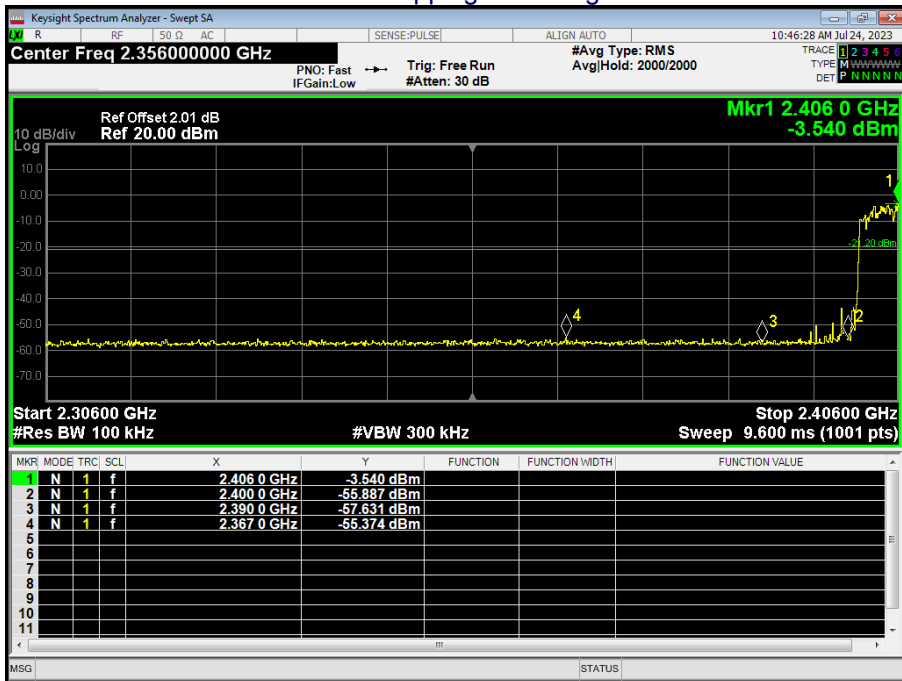

8-DPSK No-hopping Band edge-right side

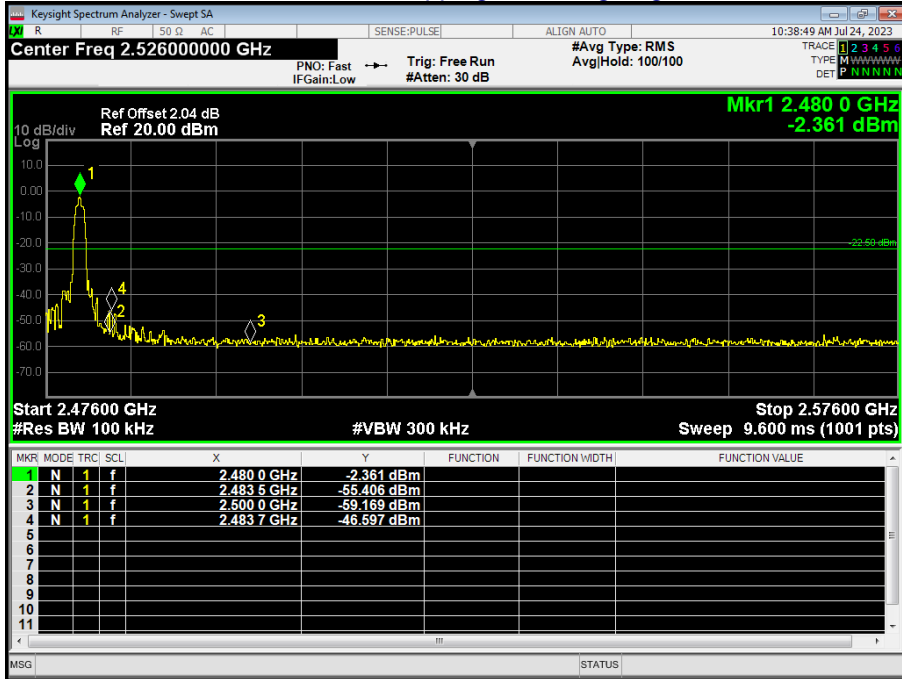

8-DPSK Hopping Band edge-right side

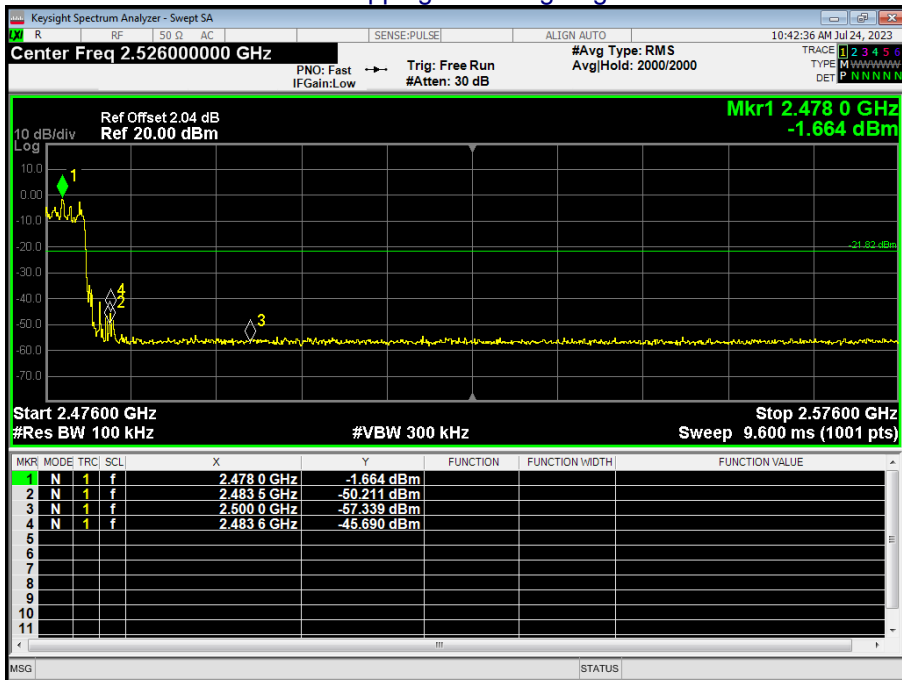

7. 20DB&99% BANDWIDTH

Test Requirement:	FCC Part15 C Section 15.247 (a)(1)
Test Method:	ANSI C63.10:2013

7.1 Test Setup

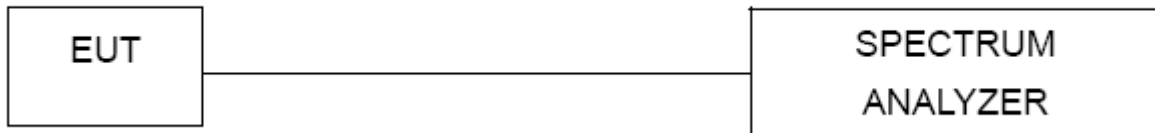

7.2 Limit

N/A

7.3 Test procedure

1. Set RBW = 30 kHz.
2. Set the video bandwidth (VBW) $\geq 3 \times$ RBW.
3. Detector = Peak.
4. Trace mode = max hold.
5. Sweep = auto couple.
6. Allow the trace to stabilize.
7. Measure the maximum width of the emission that is constrained by the frequencies associated with the two outermost amplitude points (upper and lower frequencies) that are attenuated by 6 dB relative to the maximum level measured in the fundamental emission.

7.4 DEVIATION FROM STANDARD

No deviation.

7.5 Test Result

Mode	Test channel	20dB Emission Bandwidth (MHz)	Result
GFSK	Lowest	0.947	Pass
	Middle	0.961	
	Highest	0.962	
$\pi/4$ -DQPSK	Lowest	1.320	Pass
	Middle	1.338	
	Highest	1.316	
8-DPSK	Lowest	1.329	Pass
	Middle	1.309	
	Highest	1.301	

Test plots

GFSK Low Channel

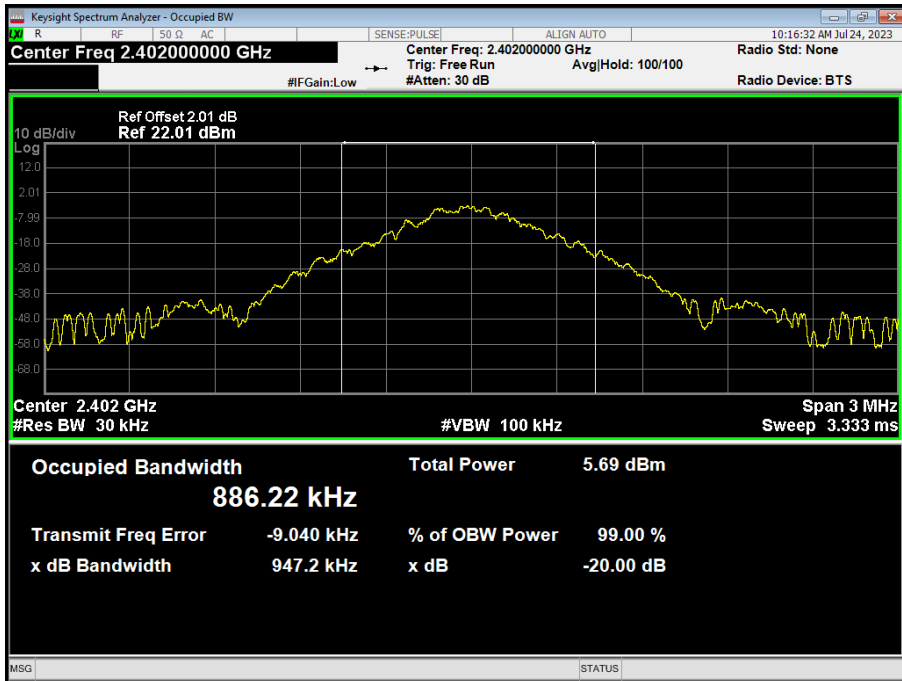

GFSK Middle Channel

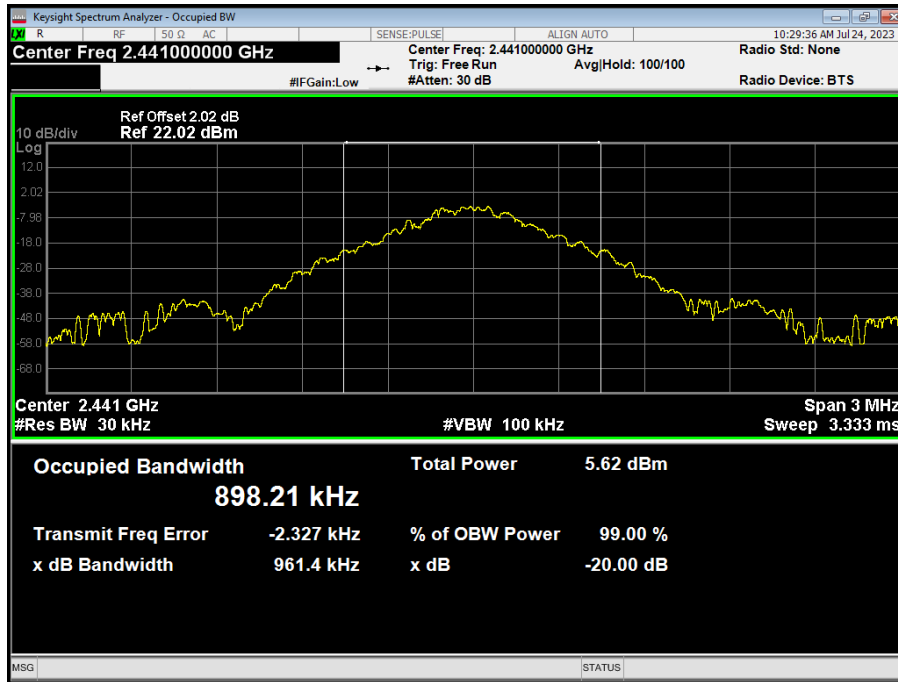

GFSK High Channel

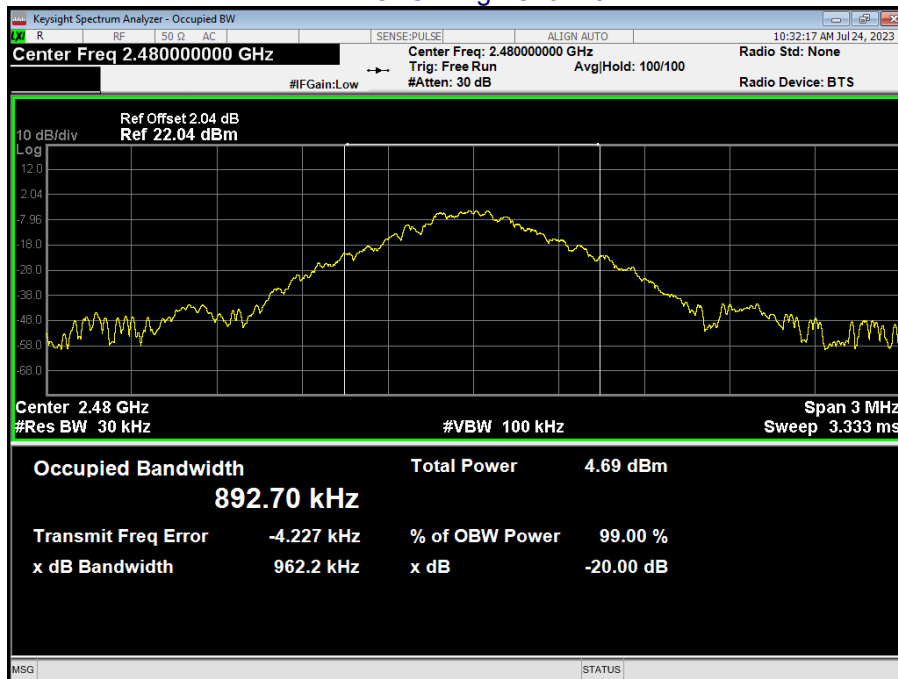

$\pi/4$ -DQPSK Low Channel

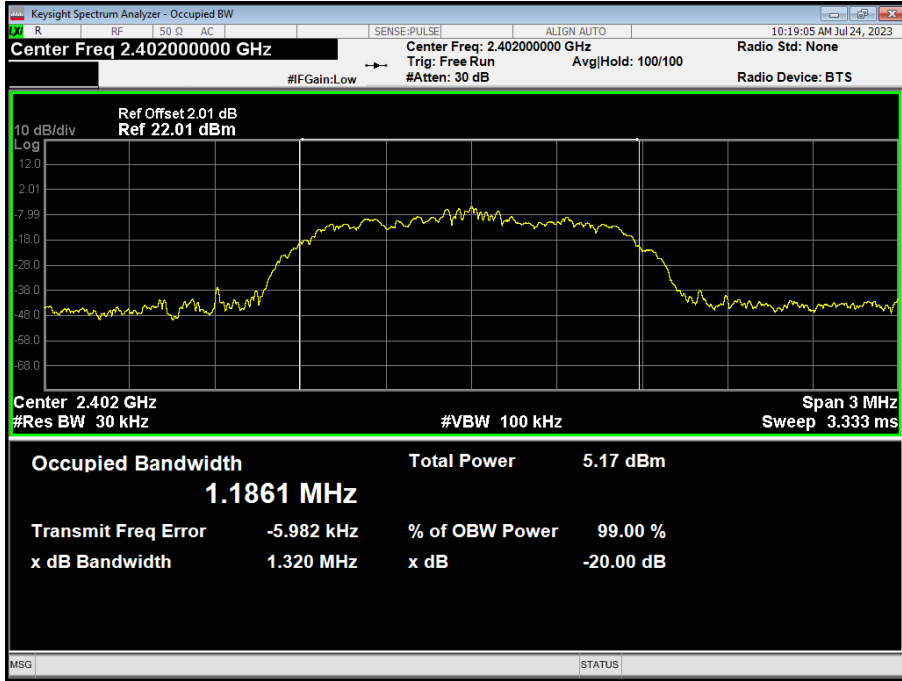

$\pi/4$ -DQPSK Middle Channel

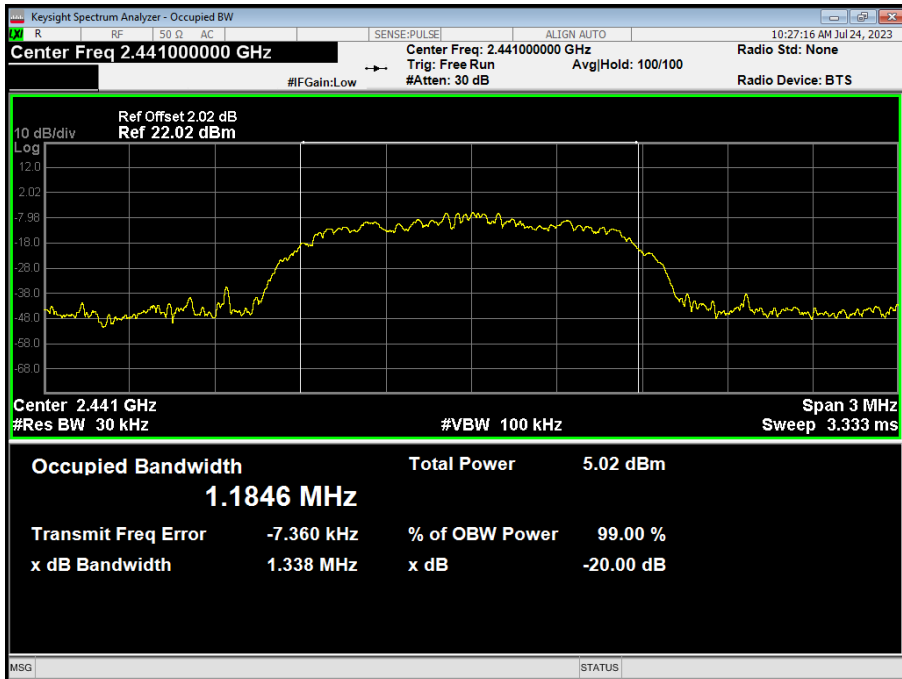

$\pi/4$ -DQPSK High Channel

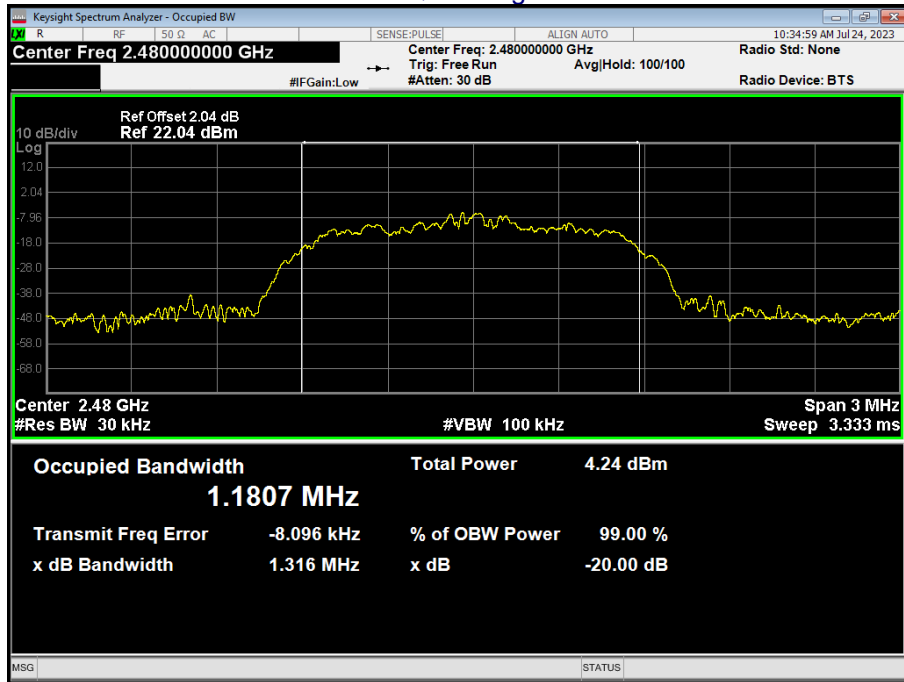

8-DPSK Low Channel

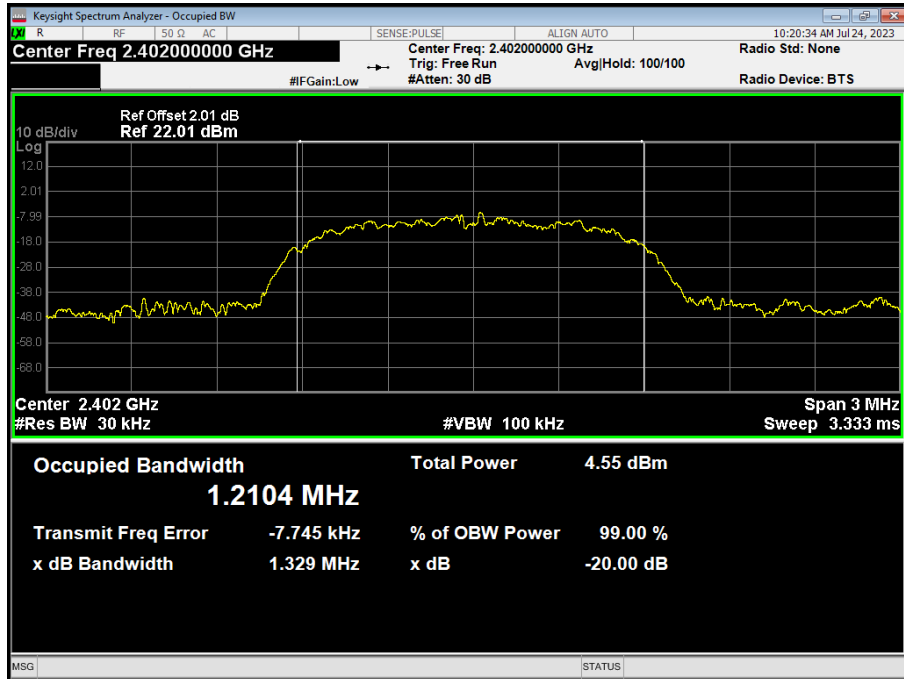

8-DPSK Middle Channel

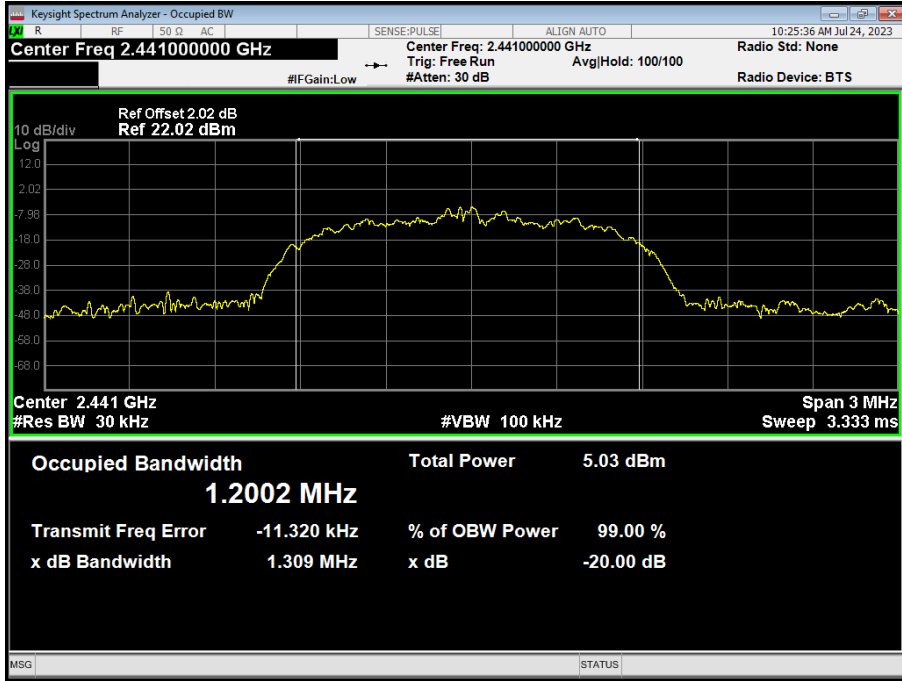

8-DPSK High Channel

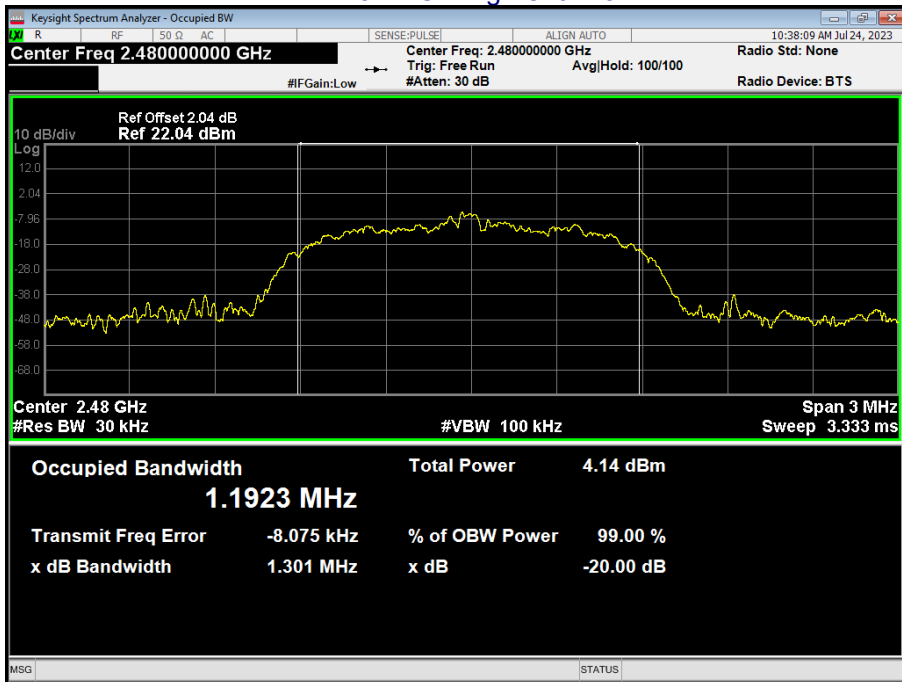

8. Maximum Peak Output Power

Test Requirement:	FCC Part15 C Section 15.247 (b)(1)
Test Method:	ANSI C63.10:2013
Limit:	GFSK:30 dBm $\pi/4$ -DQPSK & 8-DPSK:20.97 dBm

8.1 Block Diagram Of Test Setup



8.2 Limit

For frequency hopping systems operating in the 2400-2483.5 MHz band employing at least 75 non-overlapping hopping channels, and all frequency hopping systems in the 5725-5850 MHz band: 1 watt. For all other frequency hopping systems in the 2400-2483.5 MHz band: 0.125 watts.

For FHSs operating in the band 2400-2483.5 MHz, the maximum peak conducted output power shall not exceed 1.0 W if the hopset uses 75 or more hopping channels; the maximum peak conducted output power shall not exceed 0.125 W if the hopset uses less than 75 hopping channels. The e.i.r.p. shall not exceed 4 W.

8.3 Test procedure

1. Remove the antenna from the EUT and then connect a low RF cable from the antenna port to the spectrum.
2. Set the spectrum analyzer: RBW = 2MHz. VBW =6MHz. Sweep = auto; Detector Function = Peak.
3. Keep the EUT in transmitting at lowest, medium and highest channel individually. Record the max value.

8.4 DEVIATION FROM STANDARD

No deviation.

8.5 Test Result

Mode	Test channel	Peak Output Power (dBm)	FCC Limit (dBm)	Result
GFSK	Lowest	-0.209	30.00	Pass
	Middle	-0.373		
	Highest	-1.248		
$\pi/4$ -DQPSK	Lowest	-0.054	21.00	Pass
	Middle	-0.086		
	Highest	-1.047		
8-DPSK	Lowest	0.13	21.00	Pass
	Middle	0.043		
	Highest	-0.891		

Test plots

GFSK Low Channel

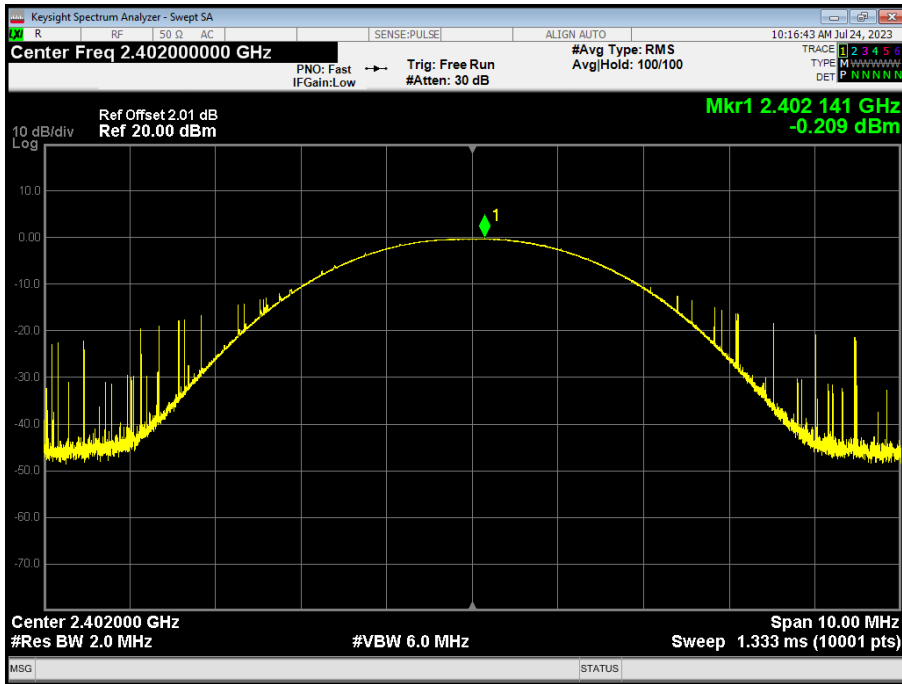

GFSK Middle Channel

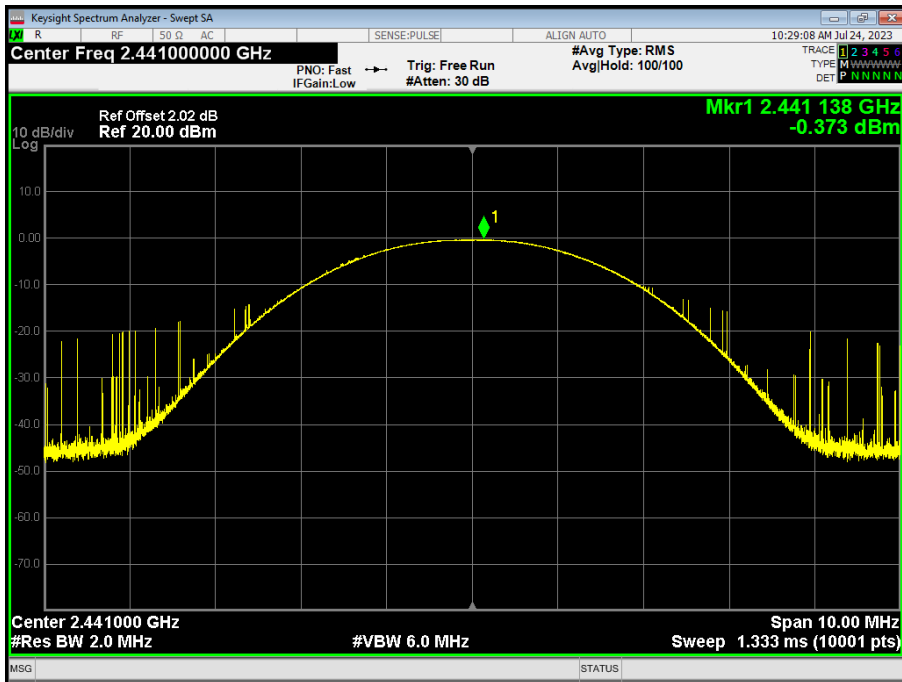

GFSK High Channel

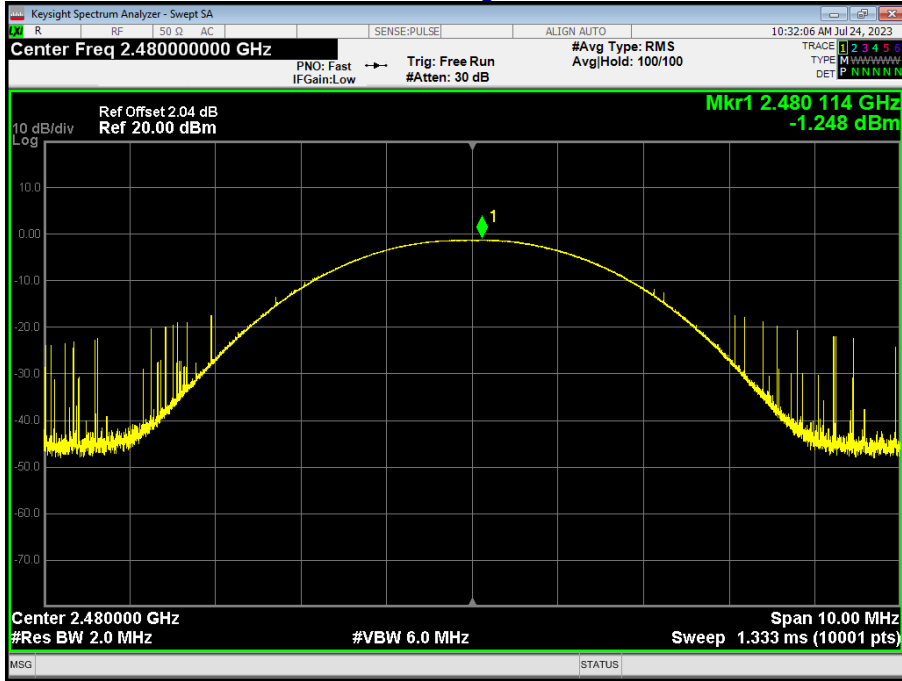

$\pi/4$ -DQPSK Low Channel

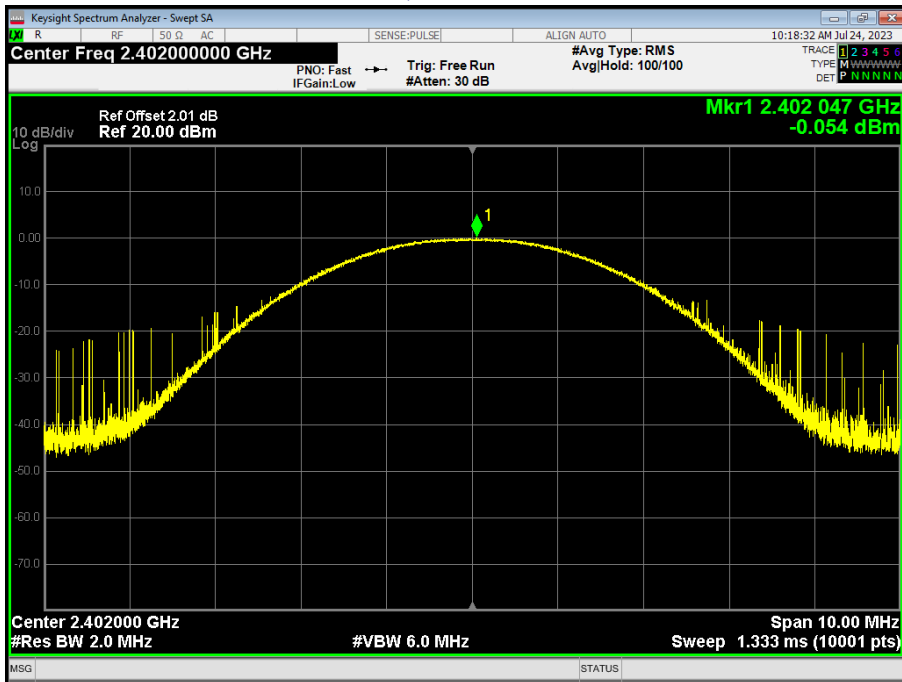

$\pi/4$ -DQPSK Middle Channel

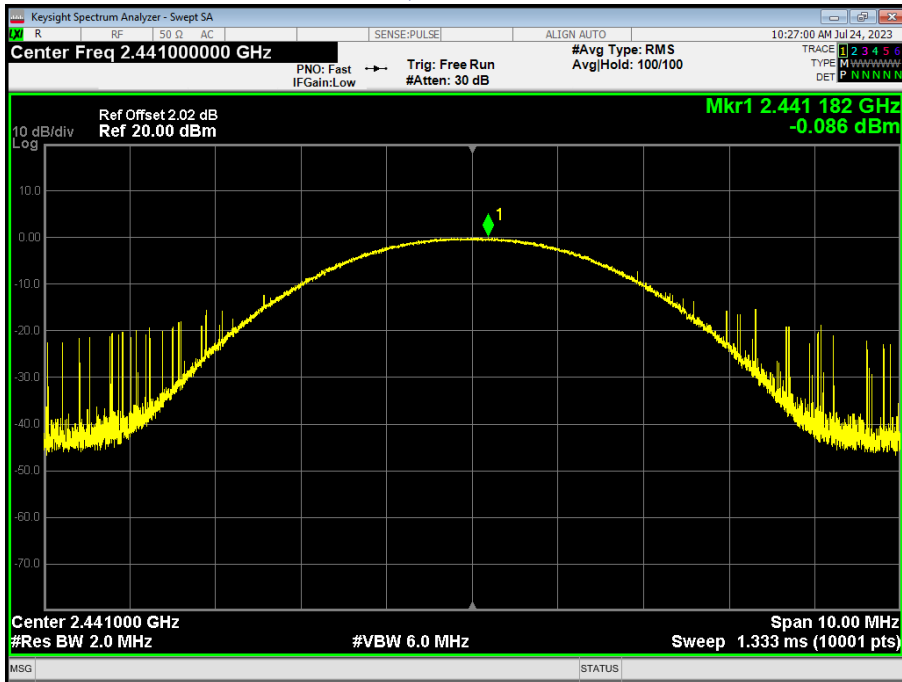

$\pi/4$ -DQPSK High Channel

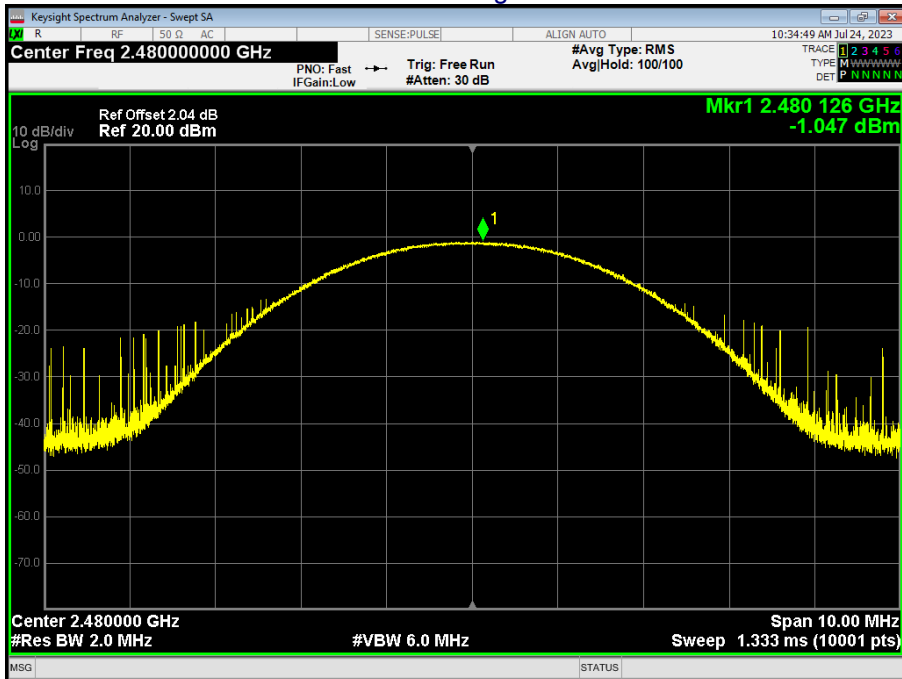

8-DPSK Low Channel

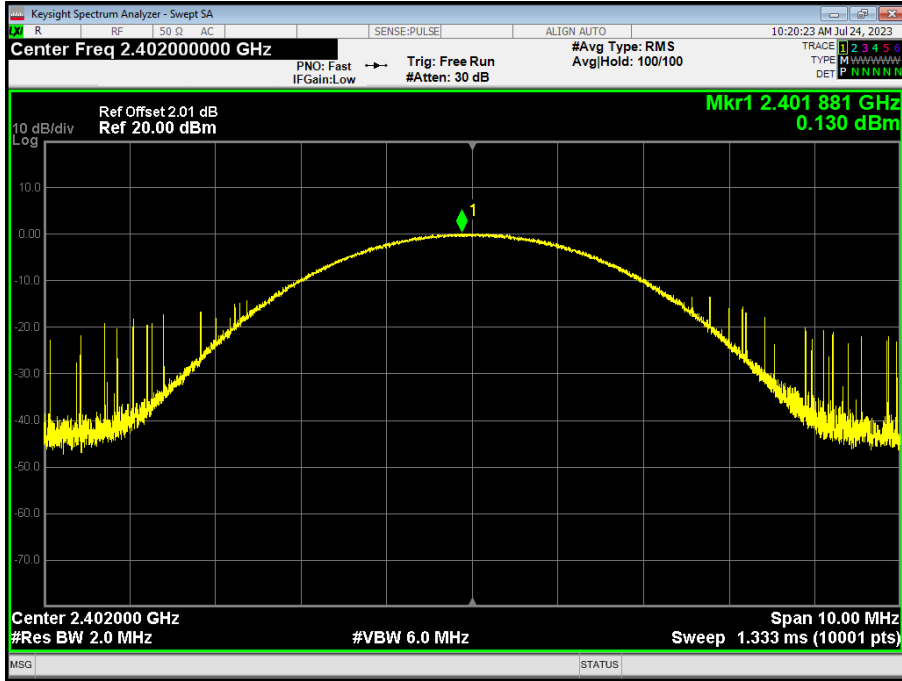

8-DPSK Middle Channel

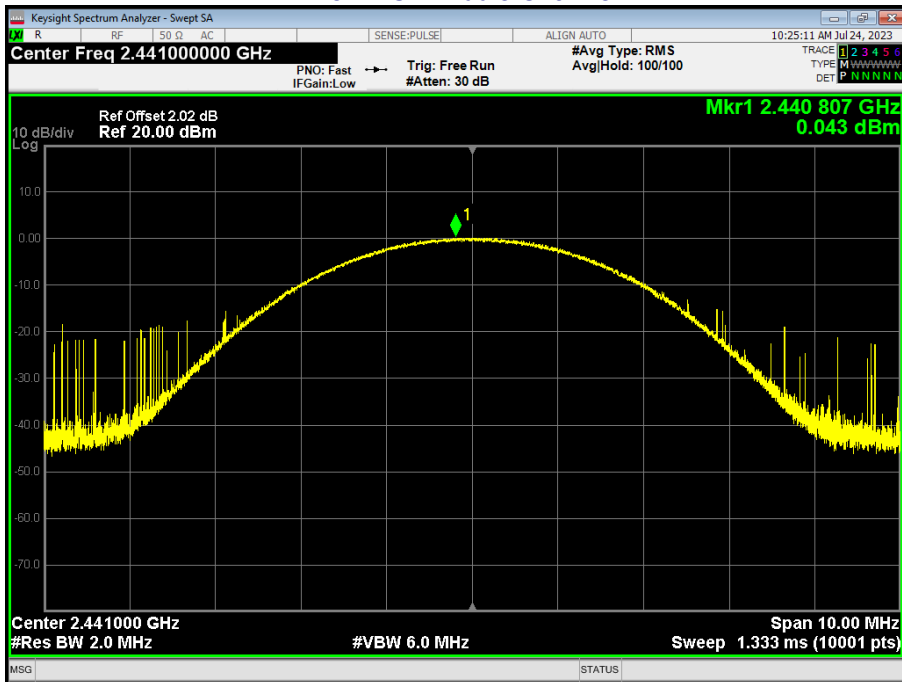

8-DPSK High Channel

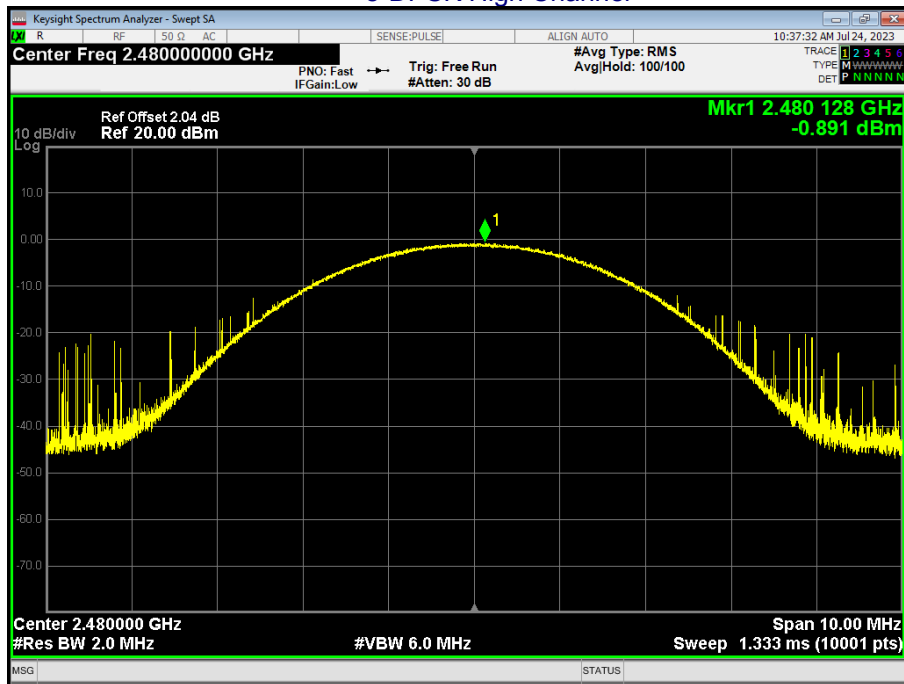

9. HOPPING CHANNEL SEPARATION

Test Requirement:	FCC Part15 C Section 15.247 (a)(1)
Test Method:	ANSI C63.10:2013
Receiver setup:	RBW=30KHz, VBW=100KHz, detector=Peak
Limit:	GFSK: 20dB bandwidth $\pi/4$ -DQPSK & 8DSK: 0.025MHz or 2/3 of the 20dB bandwidth (whichever is greater)

9.1 Test Setup



9.2 Test procedure

1. Remove the antenna from the EUT and then connect a low RF cable from the antenna port to the spectrum.
2. Set the spectrum analyzer: RBW = 30kHz. VBW = 100kHz , Span = 3.0MHz. Sweep = auto; Detector Function = Peak. Trace = Max hold.
3. Allow the trace to stabilize. Use the marker-delta function to determine the separation between the peaks of the adjacent channels. The limit is specified in one of the subparagraphs of this Section Submit this plot.

9.3 DEVIATION FROM STANDARD

No deviation.

10.NUMBER OF HOPPING FREQUENCY

Test Requirement:	FCC Part15 C Section 15.247 (a)(1)(iii)
Test Method:	ANSI C63.10:2013
Receiver setup:	RBW=100kHz, VBW=300kHz, Frequency range=2400MHz-2483.5MHz, Detector=Peak
Limit:	15 channels

10.1 Test Setup



10.2 Test procedure

1. Remove the antenna from the EUT and then connect a low RF cable from the antenna port to the spectrum.
2. Set the spectrum analyzer: RBW = 100kHz. VBW = 300kHz. Sweep = auto; Detector Function = Peak. Trace = Max hold.
3. Allow the trace to stabilize. It may prove necessary to break the span up to sections. in order to clearly show all of the hopping frequencies. The limit is specified in one of the subparagraphs of this Section.
4. Set the spectrum analyzer: Start Frequency = 2.4GHz, Stop Frequency = 2.4835GHz. Sweep=auto;

10.3 DEVIATION FROM STANDARD

No deviation.

11. DWELL TIME

Test Requirement:	FCC Part15 C Section 15.247 (a)(1)(iii)
Test Method:	ANSI C63.10:2013
Receiver setup:	RBW=1MHz, VBW=3MHz, Span=0Hz, Detector=Peak
Limit:	0.4 Second

11.1 Test Setup



11.2 Test procedure

1. Remove the antenna from the EUT and then connect a low RF cable from the antenna port to the spectrum.
2. Set spectrum analyzer span = 0Hz;
3. Set RBW = 1MHz and VBW = 3MHz. Sweep = as necessary to capture the entire dwell time per hopping channel. Set the EUT for DH5, DH3 and DH1 packet transmitting.
4. Use the marker-delta function to determine the dwell time. If this value varies with different modes of operation (e.g.. data rate. modulation format. etc.). repeat this test for each variation. The limit is specified in one of the subparagraphs of this Section. Submit this plot(s).

11.3 DEVIATION FROM STANDARD

No deviation.

11.4 Test Result

GFSK mode:

Frequency	Packet	Dwell time(ms)	Limit(ms)	Result
2441MHz	DH1	138.24	400	Pass
2441MHz	DH3	261.12	400	Pass
2441MHz	DH5	302.08	400	Pass

Remarks:

The test period: $T = 0.4 \text{ Second/Channel} \times 79 \text{ Channel} = 31.6 \text{ s}$
 Test channel: as blow
 CH:2441MHz time slot= $0.432(\text{ms}) \times (1600 / (2 \times 79)) \times 31.6 = 138.24\text{ms}$
 CH:2441MHz time slot= $1.632(\text{ms}) \times (1600 / (4 \times 79)) \times 31.6 = 261.12\text{ms}$
 CH:2441MHz time slot= $2.832(\text{ms}) \times (1600 / (6 \times 79)) \times 31.6 = 302.08\text{ms}$

$\pi/4$ -DQPSK mode:

Frequency	Packet	Dwell time(ms)	Limit(ms)	Result
2441MHz	2DH1	157.44	400	Pass
2441MHz	2DH3	270.56	400	Pass
2441MHz	2DH5	294.72	400	Pass

Remarks:

The test period: $T = 0.4 \text{ Second/Channel} \times 79 \text{ Channel} = 31.6 \text{ s}$
 Test channel: as blow
 CH:2441MHz time slot= $0.492(\text{ms}) \times (1600 / (2 \times 79)) \times 31.6 = 157.44\text{ms}$
 CH:2441MHz time slot= $1.691(\text{ms}) \times (1600 / (4 \times 79)) \times 31.6 = 270.56\text{ms}$
 CH:2441MHz time slot= $2.892(\text{ms}) \times (1600 / (6 \times 79)) \times 31.6 = 308.48\text{ms}$

8-DPSK mode:

Frequency	Packet	Dwell time(ms)	Limit(ms)	Result
2441MHz	3DH1	133.44	400	Pass
2441MHz	3DH3	267.2	400	Pass
2441MHz	3DH5	294.507	400	Pass

Remarks:

The test period: $T = 0.4 \text{ Second/Channel} \times 79 \text{ Channel} = 31.6 \text{ s}$
 Test channel: as blow
 CH:2441MHz time slot= $0.417(\text{ms}) \times (1600 / (2 \times 79)) \times 31.6 = 133.44\text{ms}$
 CH:2441MHz time slot= $1.67(\text{ms}) \times (1600 / (4 \times 79)) \times 31.6 = 267.2\text{ms}$
 CH:2441MHz time slot= $2.763(\text{ms}) \times (1600 / (6 \times 79)) \times 31.6 = 294.72\text{ms}$

Test Plots

GFSK DH1 2441MHz

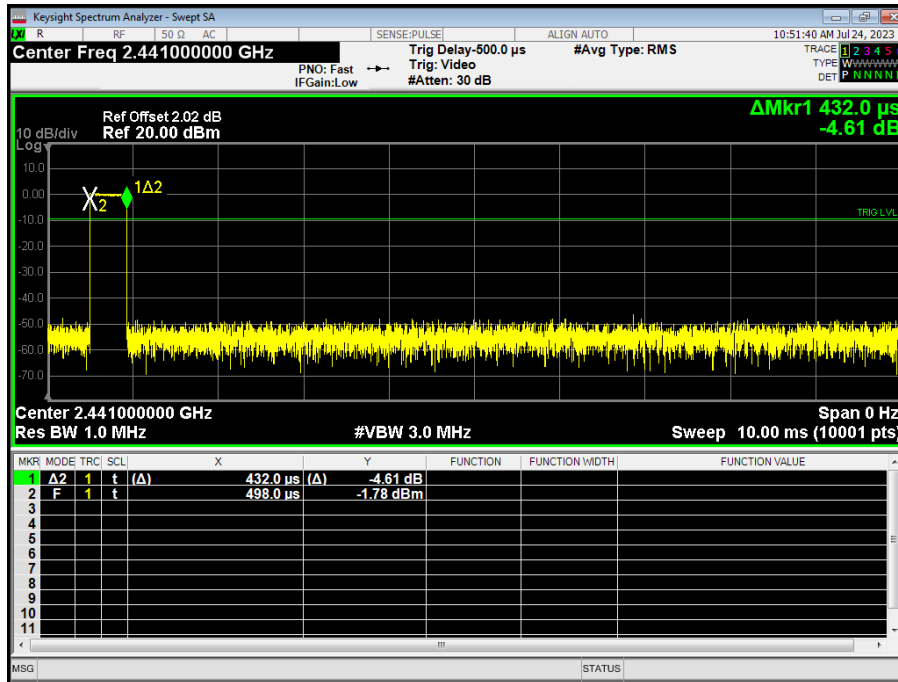

GFSK DH3 2441MHz

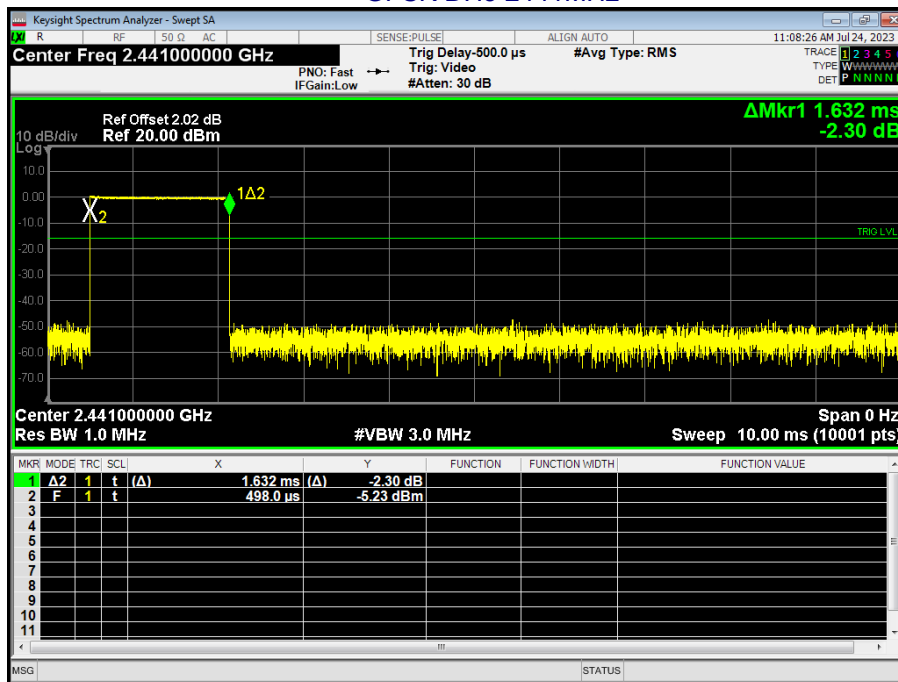

$\pi/4$ -DQPSK 2DH3 2441MHz

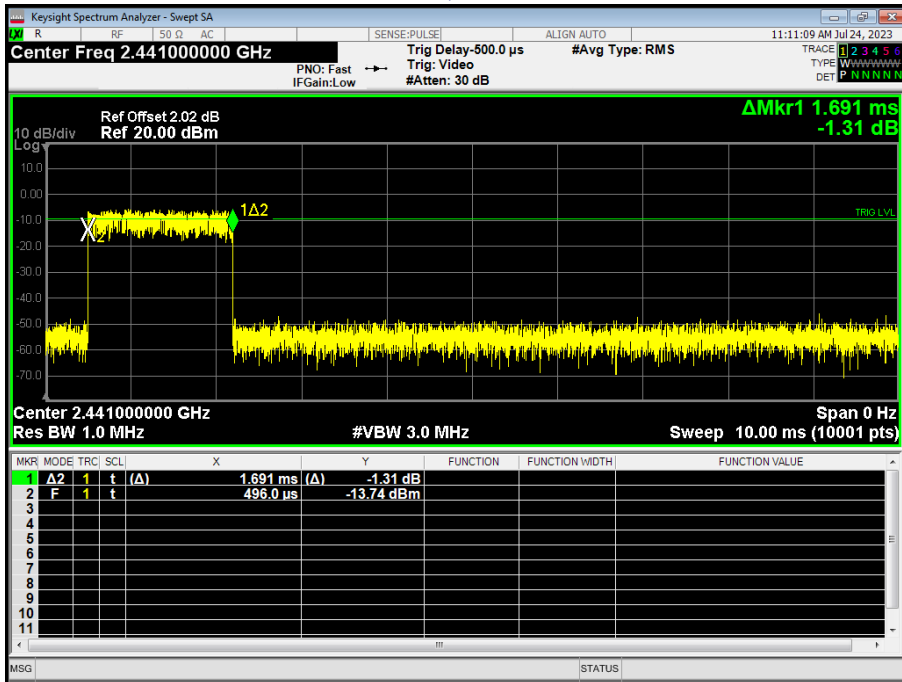

$\pi/4$ -DQPSK 2DH5 2441MHz

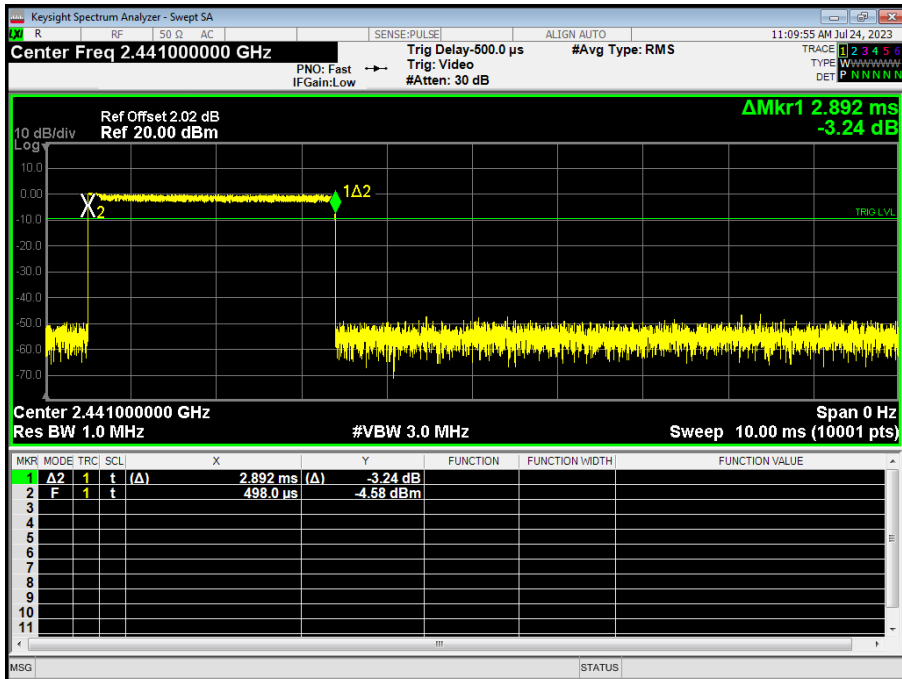

8-DPSK 3DH1 2441MHz

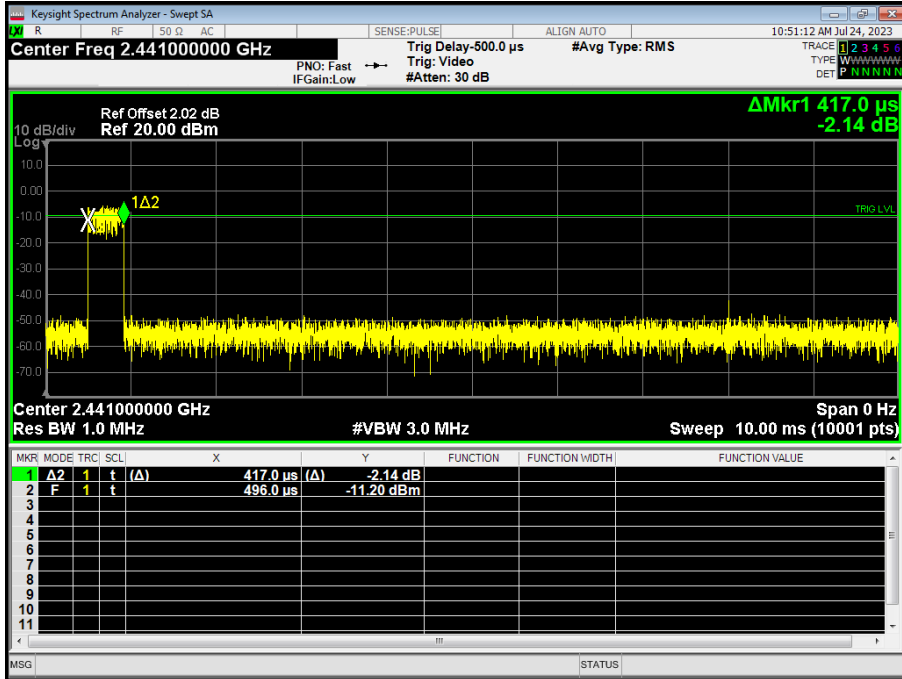

8-DPSK 3DH3 2441MHz

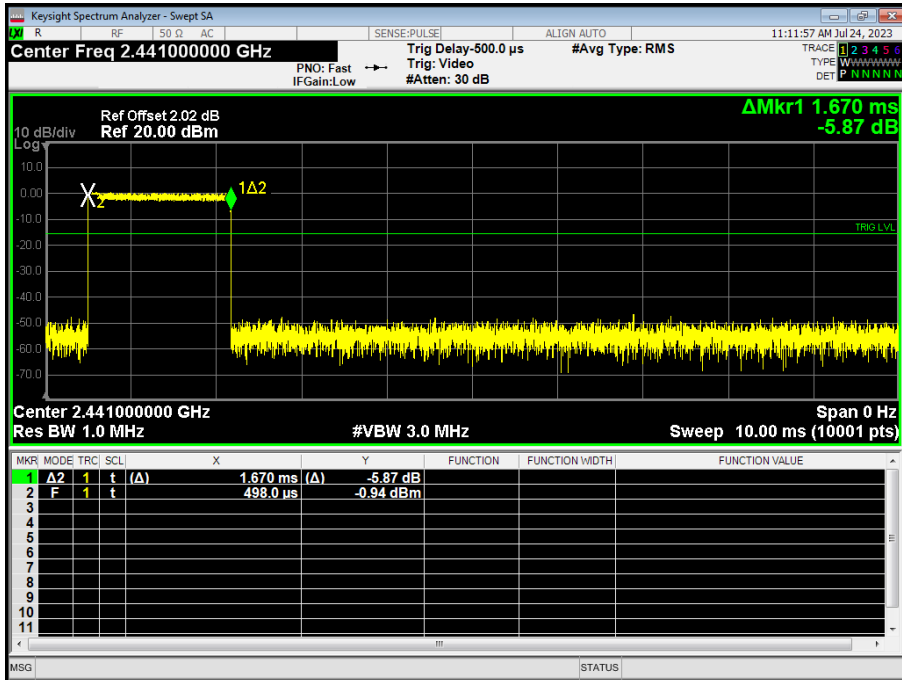

12. Antenna Requirement

Standard requirement:	FCC Part15 C Section 15.203 /247(c)
<p>15.203 requirement: An intentional radiator shall be designed to ensure that no antenna other than that furnished by the responsible party shall be used with the device. The use of a permanently attached antenna or of an antenna that uses a unique coupling to the intentional radiator, the manufacturer may design the unit so that a broken antenna can be replaced by the user, but the use of a standard antenna jack or electrical connector is prohibited.</p> <p>15.247(c) (1)(i) requirement: (i) Systems operating in the 2400-2483.5 MHz band that is used exclusively for fixed. Point-to-point operations may employ transmitting antennas with directional gain greater than 6dBi provided the maximum conducted output power of the intentional radiator is reduced by 1 dB for every 3 dB that the directional gain of the antenna exceeds 6dBi.</p>	
EUT Antenna:	
The antenna is PCB antenna, the best case gain of the antennas is 1.5 dBi, reference to the appendix II for details	

13. Test Setup Photo

Reference to the appendix I for details.

14. EUT Constructional Details

Reference to the appendix II for details.

******* END OF REPORT *******