



# FCC TEST REPORT

## FCC ID:2AXCX-LTPMS0124

**Report Number**..... : ZKT-2401301426E-3

Date of Test..... Feb. 21, 2024 to Mar. 14, 2024

Date of issue..... : Mar. 14, 2024

Total number of pages..... 29

Test Result ..... : PASS

**Testing Laboratory**..... : **Shenzhen ZKT Technology Co., Ltd.**

Address ..... : 1/F, No. 101, Building B, No. 6, Tangwei Community Industrial Avenue, Fuhai Street, Bao'an District, Shenzhen, China

**Applicant's name** ..... : **Shenzhen Foxwell Technology Co., Ltd**

Address ..... : 5/F, Plant C, Baocheng 71st Zone, Xin'ao Street, Baoan District, Shenzhen 518106, China

**Manufacturer's name** ..... : **Shenzhen Foxwell Technology Co., Ltd**

Address ..... : 5/F, Plant C, Baocheng 71st Zone, Xin'ao Street, Baoan District, Shenzhen 518106, China

**Test specification:**

Standard..... : FCC CFR Title 47 Part 15 Subpart C Section 15.231  
ANSI C63.10:2013

Test procedure..... : /

Non-standard test method ..... : N/A

**Test Report Form No**..... : TRF-EL-108\_V0

**Test Report Form(s) Originator**..... : ZKT Testing

**Master TRF** ..... : Dated: 2020-01-06

This device described above has been tested by ZKT, and the test results show that the equipment under test (EUT) is in compliance with the FCC requirements. And it is applicable only to the tested sample identified in the report.

This report shall not be reproduced except in full, without the written approval of ZKT, this document may be altered or revised by ZKT, personal only, and shall be noted in the revision of the document.

**Product name**..... : **TPMS Service Tool (WiFi Version)**

Trademark ..... : N/A

Model/Type reference..... : T2000WF  
T66WF, TP300WF, TS300WF, PS100WF, H020WF, LT200WF,  
HT600WF.

Ratings..... : Input : 5V===2.0A  
Battery : 3.7V, 3000mAh, 11.1Wh



**Testing procedure and testing location:**

**Testing Laboratory**.....: **Shenzhen ZKT Technology Co., Ltd.**

**Address**.....: 1/F, No. 101, Building B, No. 6, Tangwei Community  
Industrial Avenue, Fuhai Street, Bao'an District,  
Shenzhen, China

---

**Tested by (name + signature)**.....: Jim Liu

**Reviewer (name + signature)**.....: Jackson Fang

**Approved (name + signature)**.....: Lake Xie





Table of Contents

Page

<b>1. VERSION</b> .....	<b>5</b>
<b>2. SUMMARY OF TEST RESULTS</b> .....	<b>6</b>
2.1 TEST FACILITY .....	7
2.2 MEASUREMENT UNCERTAINTY .....	7
<b>3. GENERAL INFORMATION</b> .....	<b>8</b>
3.1 GENERAL DESCRIPTION OF EUT .....	8
3.2 DESCRIPTION OF TEST MODES .....	9
3.3 BLOCK DIGRAM SHOWING THE CONFIGURATION OF SYSTEM TESTED .....	9
3.4 DESCRIPTION OF SUPPORT UNITS(CONDUCTED MODE) .....	9
3.5 EQUIPMENTS LIST FOR ALL TEST ITEMS .....	10
<b>4. EMC EMISSION TEST</b> .....	<b>12</b>
4.1 CONDUCTED EMISSION MEASUREMENT .....	12
4.1.1 POWER LINE CONDUCTED EMISSION LIMITS .....	12
4.1.2 TEST PROCEDURE .....	13
4.1.3 DEVIATION FROM TEST STANDARD .....	13
4.1.4 TEST SETUP .....	13
4.1.5 EUT OPERATING CONDITIONS .....	13
4.2 RADIATED EMISSION MEASUREMENT .....	16
4.2.1 RADIATED EMISSION LIMITS .....	16
4.2.2 TEST PROCEDURE .....	17
4.2.3 TEST SETUP .....	18
4.2.4 EUT OPERATING CONDITIONS .....	19
4.2.5 TEST RESULTS .....	19
5.1 APPLIED PROCEDURES / LIMIT .....	24
5.2 TEST PROCEDURE .....	24
5.3 DEVIATION FROM STANDARD .....	24
5.4 TEST SETUP .....	24
5.5 EUT OPERATION CONDITIONS .....	24
5.6 TEST RESULTS .....	25
<b>6. CALCULATION OF AVERAGE FACTOR</b> .....	<b>26</b>
<b>7. DWELL TIME</b> .....	<b>28</b>
7.1 APPLICABLE STANDARD .....	28
7.2 TEST PROCEDURE .....	28
7.5 EUT OPERATION CONDITIONS .....	28
7.6 TEST RESULTS .....	29
<b>8. ANTENNA REQUIREMENT</b> .....	<b>29</b>



**Table of Contents**

**Page**

**9. TEST SETUP PHOTO .....31**

**10. EUT CONSTRUCTIONAL DETAILS .....31**



**1. VERSION**

Report No.	Version	Description	Approved
ZKT-2401301426E-3	Rev.01	Initial issue of report	Mar. 14, 2024



## 2. SUMMARY OF TEST RESULTS

Test procedures according to the technical standards:

FCC Part15 (15.231) , Subpart C			
Standard Section	Test Item	Judgment	Remark
15.207	AC Power Line Conducted Emission	PASS	
15.209,15.231b	Fundamental & Radiated Spurious Emission Measurement	PASS	
15.231c	Occupy Bandwidth	PASS	
15.231a	Dwell time	PASS	
15.203	Antenna Requirement	PASS	

NOTE:

(1) "N/A" denotes test is not applicable in this Test Report



## 2.1 TEST FACILITY

Shenzhen ZKT Technology Co., Ltd.  
Add. : 1/F, No. 101, Building B, No. 6, Tangwei Community Industrial Avenue, Fuhai Street, Bao'an District, Shenzhen, China

FCC Test Firm Registration Number: 692225  
Designation Number: CN1299  
IC Registered No.: 27033  
CAB identifier: CN0110

## 2.2 MEASUREMENT UNCERTAINTY

The reported uncertainty of measurement  $y \pm U$  · where expended uncertainty U is based on a standard uncertainty multiplied by a coverage factor of  $k=2$  · providing a level of confidence of approximately 95 % ·

No.	Item	Uncertainty
1	3m chamber Radiated spurious emission(9KHz-30MHz)	U=4.5dB
2	3m chamber Radiated spurious emission(30MHz-1GHz)	U=4.8dB
3	3m chamber Radiated spurious emission(1GHz-6GHz)	U=4.9dB
4	3m chamber Radiated spurious emission(6GHz-40GHz)	U=5.0dB
5	Conducted disturbance	U=3.2dB
6	RF Band Edge	U=1.68dB
7	RF power conducted	U=1.86dB
8	RF conducted Spurious Emission	U=2.2dB
9	RF Occupied Bandwidth	U=1.8dB
10	RF Power Spectral Density	U=1.75dB
11	humidity uncertainty	U=5.3%
12	Temperature uncertainty	U=0.59°C



### 3. GENERAL INFORMATION

#### 3.1 GENERAL DESCRIPTION OF EUT

Equipment	TPMS Service Tool (WiFi Version)
Trade Name	N/A
Model Name	T2000WF
Serial Model	T66WF, TP300WF, TS300WF, PS100WF, H020WF, LT200WF, HT600WF.
Model Difference	These additional model numbers are only different in model naming from the main measuring model
Hardware version	H1.0
Software version	S1.0
Operation Frequency:	433.92MHz
Modulation Type:	ASK
Antenna Type:	Spring Coil Antenna
Antenna Gain:	0.84dBi
Ratings	Input : 5V===2.0A Battery : 3.7V, 3000mAh, 11.1Wh





### 3.2 DESCRIPTION OF TEST MODES

For All Emission	
Final Test Mode	Description
Transmitting mode	Keep the EUT in continuously transmitting mode

Note:

- (1) Fully-charged battery is used during the test

### 3.3 BLOCK DIGRAM SHOWING THE CONFIGURATION OF SYSTEM TESTED

Conducted Emission



Radiated Emission

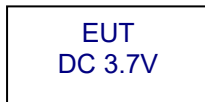

Conducted Spurious

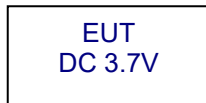

### 3.4 DESCRIPTION OF SUPPORT UNITS(CONDUCTED MODE)

The EUT has been tested as an independent unit together with other necessary accessories or support units. The following support units or accessories were used to form a representative test configuration during the tests.

Item	Equipment	Mfr/Brand	Model/Type No.	Series No.	Note
E-1	TPMS Service Tool (WiFi Version)	N/A	T2000WF	N/A	EUT
A1	AC/DC Adapter	GVE	GM53-240200-F	N/A	EUT

Item	Shielded Type	Ferrite Core	Length	Note

Note:

- (1) The support equipment was authorized by Declaration of Confirmation.
- (2) For detachable type I/O cable should be specified the length in cm in 『Length』 column.
- (3) “YES” is means “shielded” “with core”; “NO” is means “unshielded” “without core”.



### 3.5 EQUIPMENTS LIST FOR ALL TEST ITEMS

#### Conduction Test equipment

Item	Kind of Equipment	Manufacturer	Type No.	Serial No.	Firmware Version	Last calibration	Calibrated until
1	LISN	R&S	ENV216	101471	N/A	Nov. 14, 2023	Nov. 13, 2024
2	LISN	CYBERTEK	EM5040A	E1850400149	N/A	Nov. 02, 2023	Nov. 01, 2024
3	Test Cable	N/A	C-01	N/A	N/A	Nov. 02, 2023	Nov. 01, 2024
4	Test Cable	N/A	C-02	N/A	N/A	Nov. 02, 2023	Nov. 01, 2024
5	Test Cable	N/A	C-03	N/A	N/A	Nov. 02, 2023	Nov. 01, 2024
6	EMI Test Receiver	R&S	ESCI3	101393	4.42 SP3	Nov. 02, 2023	Nov. 01, 2024
7	Triple-Loop Antenna	N/A	RF300	N/A	N/A	Nov. 02, 2023	Nov. 01, 2024
8	Absorbing Clamp	DZ	ZN23201	15034	N/A	Nov. 07, 2023	Nov. 06, 2024
9	EMC Software	Frad	EZ-EMC	Ver.EMC-CON 3A1.1	N/A	\	\

#### Radiation Test equipment

Item	Equipment	Manufacturer	Type No.	Serial No.	Firmware Version	Last calibration	Calibrated until
1	Spectrum Analyzer (9kHz-26.5GHz)	KEYSIGHT	9020A	MY55370835	A.17.05	Nov. 02, 2023	Nov. 01, 2024
2	Spectrum Analyzer (10kHz-39.9GHz)	R&S	FSV40-N	100363	1.71 SP2	Nov. 02, 2023	Nov. 01, 2024
3	EMI Test Receiver (9kHz-7GHz)	R&S	ESCI7	101169	4.32	Nov. 02, 2023	Nov. 01, 2024
4	Bilog Antenna (30MHz-1500MHz)	Schwarzbeck	VULB9168	N/A	N/A	Nov. 13, 2023	Nov. 12, 2024
5	Horn Antenna (1GHz-18GHz)	Agilent	AH-118	071145	N/A	Nov. 13, 2023	Nov. 12, 2024
6	Horn Antenna (15GHz-40GHz)	A.H.System	SAS-574	588	N/A	Nov. 13, 2023	Nov. 12, 2024
7	Loop Antenna	TESEQ	HLA6121	58357	N/A	Nov. 16, 2023	Nov. 15, 2024
8	Amplifier (30-1000MHz)	EM Electronics	EM330 Amplifier	060747	N/A	Nov. 02, 2023	Nov. 01, 2024
9	Amplifier (1GHz-26.5GHz)	Agilent	8449B	3008A00315	N/A	Nov. 02, 2023	Nov. 01, 2024
10	Amplifier (500MHz-40GHz)	QuanJuDa	DLE-161	097	N/A	Nov. 02, 2023	Nov. 01, 2024
11	Test Cable	N/A	R-01	N/A	N/A	Nov. 02, 2023	Nov. 01, 2024
12	Test Cable	N/A	R-02	N/A	N/A	Nov. 02, 2023	Nov. 01, 2024
13	Test Cable	N/A	R-03	N/A	N/A	Nov. 02, 2023	Nov. 01, 2024
14	D.C. Power Supply	LongWei	TPR-6405D	N/A	N/A	\	\
15	EMC Software	Frad	EZ-EMC	Ver.EMC-CO N 3A1.1	N/A	\	\
16	Turntable	MF	MF-7802BS	N/A	N/A	\	\
17	Antenna tower	MF	MF-7802BS	N/A	N/A	\	\



## RF Test equipment

Item	Equipment	Manufacturer	Type No.	Serial No.	Firmware Version	Last calibration	Calibrated until
1	Spectrum Analyzer (9kHz-26.5GHz)	KEYSIGHT	9020A	MY55370835	A.17.05	Nov. 02, 2023	Nov. 01, 2024
2	Spectrum Analyzer (10kHz-39.9GHz)	R&S	FSV40-N	100363	1.71 SP2	Nov. 02, 2023	Nov. 01, 2024
3	Test Cable	N/A	RF-01	N/A	N/A	Nov. 02, 2023	Nov. 01, 2024
4	Test Cable	N/A	RF-02	N/A	N/A	Nov. 02, 2023	Nov. 01, 2024
5	Test Cable	N/A	RF-03	N/A	N/A	Nov. 02, 2023	Nov. 01, 2024
6	ESG Signal Generator	Agilent	E4421B	N/A	B.03.84	Nov. 02, 2023	Nov. 01, 2024
7	Signal Generator	Agilent	N5182A	N/A	A.01.87	Nov. 02, 2023	Nov. 01, 2024
8	Magnetic Field Probe Tester	Narda	ELT-400	0-0344	N/A	Nov. 16, 2023	Nov. 15, 2024
9	Wideband Radio Communication Test	R&S	CMW500	106504	V 3.7.22	Nov. 02, 2023	Nov. 01, 2024
10	MWRF Power Meter Test system	MW	MW100-RF CB	N/A	N/A	Nov. 02, 2023	Nov. 01, 2024
11	Power Meter	KEYSIGHT	N1912A P	N/A	A.05.00	Nov. 02, 2023	Nov. 01, 2024
12	D.C. Power Supply	LongWei	TPR-6405D	N/A	N/A	\	\
13	RF Software	MW	MTS8310	V2.0.0.0	N/A	\	\



#### 4. EMC EMISSION TEST

##### 4.1 CONDUCTED EMISSION MEASUREMENT

Test Requirement:	FCC Part15 C Section 15.207
Test Method:	ANSI C63.10:2013
Test Frequency Range:	150KHz to 30MHz
Receiver setup:	RBW=9KHz, VBW=30KHz, Sweep time=auto

##### 4.1.1 POWER LINE CONDUCTED EMISSION LIMITS

(Frequency Range 150KHz-30MHz)

FREQUENCY (MHz)	Limit (dBuV)		Standard
	Quasi-peak	Average	
0.15 -0.5	66 - 56 *	56 - 46 *	FCC
0.50 -5.0	56.00	46.00	FCC
5.0 -30.0	60.00	50.00	FCC

Note:

- (1) The tighter limit applies at the band edges.
- (2) The limit of " \* " marked band means the limitation decreases linearly with the logarithm of the frequency in the range.

The following table is the setting of the receiver

Receiver Parameters	Setting
Attenuation	10 dB
Start Frequency	0.15 MHz
Stop Frequency	30 MHz
IF Bandwidth	9 kHz



#### 4.1.2 TEST PROCEDURE

- a. The EUT was placed 0.8 meters from the horizontal ground plane with EUT being connected to the power mains through a line impedance stabilization network (LISN). All other support equipments powered from additional LISN(s). The LISN provide 50 Ohm/ 50uH of coupling impedance for the measuring instrument.
- b. Interconnecting cables that hang closer than 40 cm to the ground plane shall be folded back and forth in the center forming a bundle 30 to 40 cm long.
- c. I/O cables that are not connected to a peripheral shall be bundled in the center. The end of the cable may be terminated, if required, using the correct terminating impedance. The overall length shall not exceed 1 m.
- d. LISN at least 80 cm from nearest part of EUT chassis.
- e. For the actual test configuration, please refer to the related Item –EUT Test Photos.

#### 4.1.3 DEVIATION FROM TEST STANDARD

No deviation

#### 4.1.4 TEST SETUP

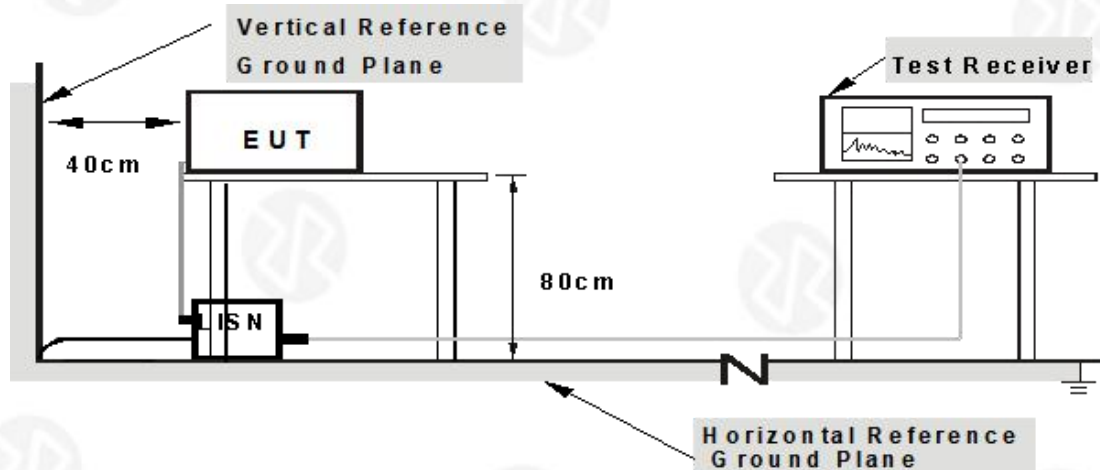

- Note: 1.Support units were connected to second LISN.**  
**2.Both of LISN's (AMN) are 80 cm from EUT and at least 80 from other units and other metal planes**

#### 4.1.5 EUT OPERATING CONDITIONS

The EUT was configured for testing in a typical fashion (as a customer would normally use it). The EUT has been programmed to continuously transmit during test. This operating condition was tested and used to collect the included data.



4.1.6 Test Result

Temperature:	26°C	Relative Humidity:	54%
Pressure:	101kPa	Phase :	L
Test Voltage :	AC 120V/60Hz	Test Mode:	TX ASK 433.92MHz

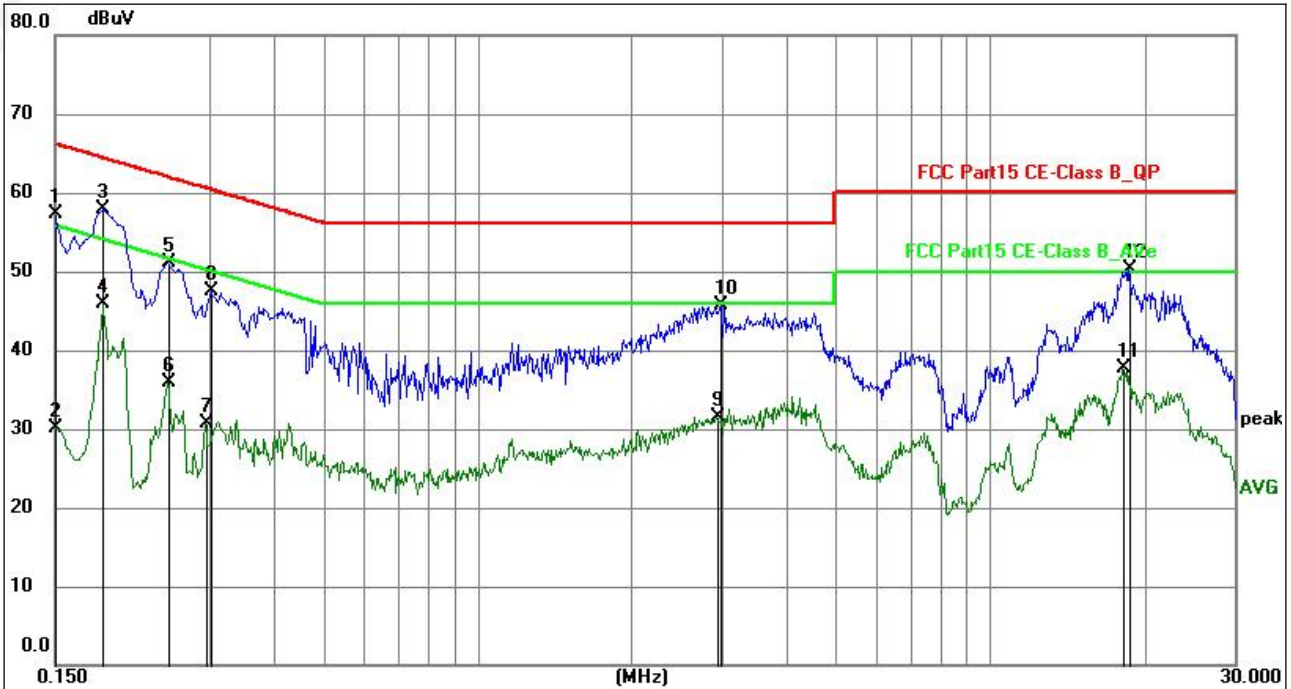

No.	Frequency (MHz)	Reading (dBuV)	Factor (dB)	Level (dBuV)	Limit (dBuV)	Margin (dB)	Detector	P/F
1	0.1500	36.74	20.48	57.22	66.00	-8.78	QP	P
2	0.1500	9.70	20.48	30.18	56.00	-25.82	AVG	P
3	0.1860	37.22	20.63	57.85	64.21	-6.36	QP	P
4	0.1860	25.26	20.63	45.89	54.21	-8.32	AVG	P
5	0.2490	30.44	20.67	51.11	61.79	-10.68	QP	P
6	0.2490	15.19	20.67	35.86	51.79	-15.93	AVG	P
7	0.2940	9.97	20.65	30.62	50.41	-19.79	AVG	P
8	0.3030	26.81	20.65	47.46	60.16	-12.70	QP	P
9	2.9355	10.70	20.78	31.48	46.00	-14.52	AVG	P
10	2.9895	24.93	20.77	45.70	56.00	-10.30	QP	P
11	18.1770	16.13	21.63	37.76	50.00	-12.24	AVG	P
12	18.6494	28.59	21.63	50.22	60.00	-9.78	QP	P

Notes:

1. An initial pre-scan was performed on the line and neutral lines with peak detector.
2. Quasi-Peak and Average measurement were performed at the frequencies with maximized peak emission.
3. Measurement Level = Reading level + Correct Factor



Temperature:	26°C	Relative Humidity:	54%
Pressure:	101kPa	Phase :	N
Test Voltage :	AC 120V/60Hz	Test Mode:	TX ASK 433.92MHz

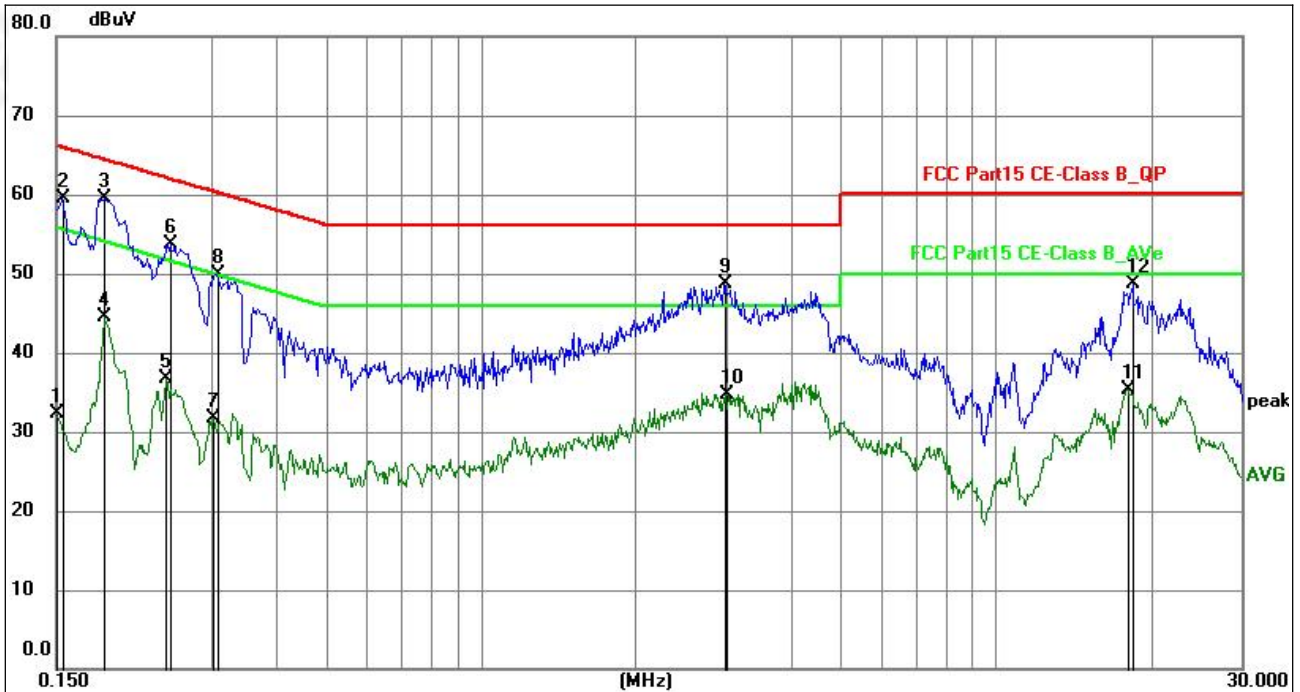

No.	Frequency (MHz)	Reading (dBuV)	Factor (dB)	Level (dBuV)	Limit (dBuV)	Margin (dB)	Detector	P/F
1	0.1500	11.74	20.58	32.32	56.00	-23.68	AVG	P
2	0.1544	38.92	20.60	59.52	65.76	-6.24	QP	P
3	0.1860	38.67	20.74	59.41	64.21	-4.80	QP	P
4	0.1860	23.80	20.74	44.54	54.21	-9.67	AVG	P
5	0.2455	15.88	20.78	36.66	51.91	-15.25	AVG	P
6	0.2494	33.00	20.78	53.78	61.78	-8.00	QP	P
7	0.3030	11.01	20.76	31.77	50.16	-18.39	AVG	P
8	0.3075	29.12	20.75	49.87	60.04	-10.17	QP	P
9	2.9760	27.83	20.91	48.74	56.00	-7.26	QP	P
10	2.9940	13.85	20.91	34.76	46.00	-11.24	AVG	P
11	18.0285	13.72	21.54	35.26	50.00	-14.74	AVG	P
12	18.4380	27.14	21.53	48.67	60.00	-11.33	QP	P

## Notes:

- 1.An initial pre-scan was performed on the line and neutral lines with peak detector.
- 2.Quasi-Peak and Average measurement were performed at the frequencies with maximized peak emission.
- 3.Measurement Level = Reading level + Correct Factor



#### 4.2 RADIATED EMISSION MEASUREMENT

Test Requirement:	FCC Part15 C Section 15.209				
Test Method:	ANSI C63.10:2013				
Test Frequency Range:	9kHz to 25GHz				
Test site:	Measurement Distance: 3m				
Receiver setup:	Frequency	Detector	RBW	VBW	Value
	9KHz-150KHz	Quasi-peak	200Hz	600Hz	Quasi-peak
	150KHz-30MHz	Quasi-peak	9KHz	30KHz	Quasi-peak
	30MHz-1GHz	Quasi-peak	100KHz	300KHz	Quasi-peak
	Above 1GHz	Peak	1MHz	3MHz	Peak
Peak		1MHz	10Hz	Average	

#### 4.2.1 RADIATED EMISSION LIMITS

20dBc in any 100 kHz bandwidth outside the operating frequency band. In case the emission fall within the restricted band specified on 15.205(a), then the 15.231(b) limit in the table below has to be followed.

Frequencies(MHz)	Field Strength(micorvolts/meter)	Measurement Distance(meters)
0.009~0.490	2400/F(KHz)	300
0.490~1.705	24000/F(KHz)	30
1.705~30.0	30	30
30~88	100	3
88~216	150	3
216~960	200	3
Above 960	500	3

#### LIMITS OF RADIATED EMISSION MEASUREMENT

FREQUENCY (MHz)	Limit (dBuV/m) (at 3M)	
	PEAK	AVERAGE
Above 1000	74	54

Notes:

- (1) The limit for radiated test was performed according to FCC PART 15C.
- (2) The tighter limit applies at the band edges.
- (3) Emission level (dBuV/m)=20log Emission level (uV/m).





### FUNDAMENTAL AND HARMONICS EMISSION LIMITS

Fundamental Frequency (MHz)	Field Strength of Fundamental (microvolts/meter)	Field Strength of Spurious Emissions (microvolts/meter)
40.66 - 40.70	2,250	225
70 - 130	1,250	125
130 - 174	1,250 to 3,750 **	125 to 375 **
174 - 260	3,750	375
260 - 470	3,750 to 12,500 **	375 to 1,250 **
Above 470	12,500	1,250

\*\* linear interpolations

[Where F is the frequency in MHz, the formulas for calculating the maximum permitted fundamental field strengths are as follows: for the band 130-174 MHz,  $\mu\text{V/m}$  at 3 meters =  $56.81818(F) - 6136.3636$ ; for the band 260-470 MHz,  $\mu\text{V/m}$  at 3 meters =  $41.6667(F) - 7083.3333$ . The maximum permitted unwanted emission level is 20 dB below the maximum permitted fundamental level.]

### FREQUENCY RANGE OF RADIATED MEASUREMENT (For unintentional radiators)

Highest frequency generated or Upper frequency of measurement used in the device or on which the device operates or tunes (MHz)	Range (MHz)
Below 1.705	30
1.705 – 108	1000
108 – 500	2000
500 – 1000	5000
Above 1000	5 <sup>th</sup> harmonic of the highest frequency or 40 GHz, whichever is lower

Spectrum Parameter	Setting
Attenuation	Auto
Start Frequency	1000 MHz
Stop Frequency	10th carrier harmonic
RBW / VBW setting	1 MHz / 1 MHz for Peak, 1 MHz / 10Hz for Average

Receiver Parameter	Setting
Attenuation	Auto
Start ~ Stop Frequency	9kHz~150kHz / RB 200Hz for QP
Start ~ Stop Frequency	150kHz~30MHz / RB 9kHz for QP
Start ~ Stop Frequency	30MHz~1000MHz / RB 120kHz for QP

### 4.2.2 TEST PROCEDURE

- The measuring distance of at 3 m shall be used for measurements at frequency up to 1GHz. For frequencies above 1GHz, any suitable measuring distance may be used.
- The EUT was placed on the top of a rotating table 0.8 meters above the ground at a 3 meter open area test site. The table was rotated 360 degrees to determine the position of the highest radiation.



- c. The height of the equipment or of the substitution antenna shall be 0.8 m; above 1GHz, the height was 1.5m, the height of the test antenna shall vary between 1 m to 4 m. Both horizontal and vertical polarizations of the antenna are set to make the measurement.
- d. The initial step in collecting conducted emission data is a spectrum analyzer peak detector mode pre-scanning the measurement frequency range. Significant peaks are then marked and then Quasi Peak detector mode re-measured.
- e. If the Peak Mode measured value compliance with and lower than Quasi Peak Mode Limit, the EUT shall be deemed to meet QP Limits and then no additional QP Mode measurement performed.
- f. For the actual test configuration, please refer to the related Item –EUT Test Photos.

Note:

Both horizontal and vertical antenna polarities were tested and performed pretest to three orthogonal axis. The worst case was X axis and the emissions were reported

#### 4.2.3 TEST SETUP

##### (A) Radiated Emission Test-Up Frequency Below 30MHz

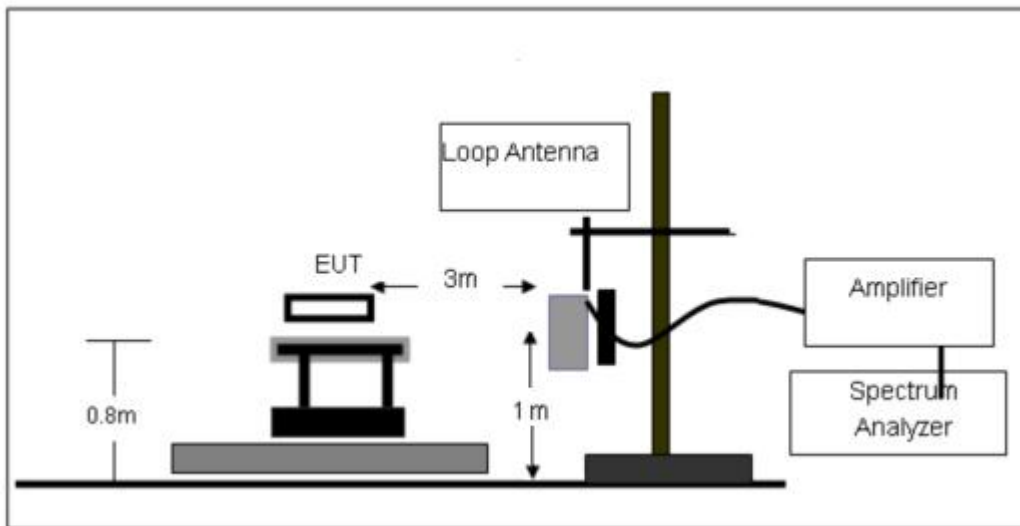

##### (B) Radiated Emission Test-Up Frequency 30MHz~1GHz

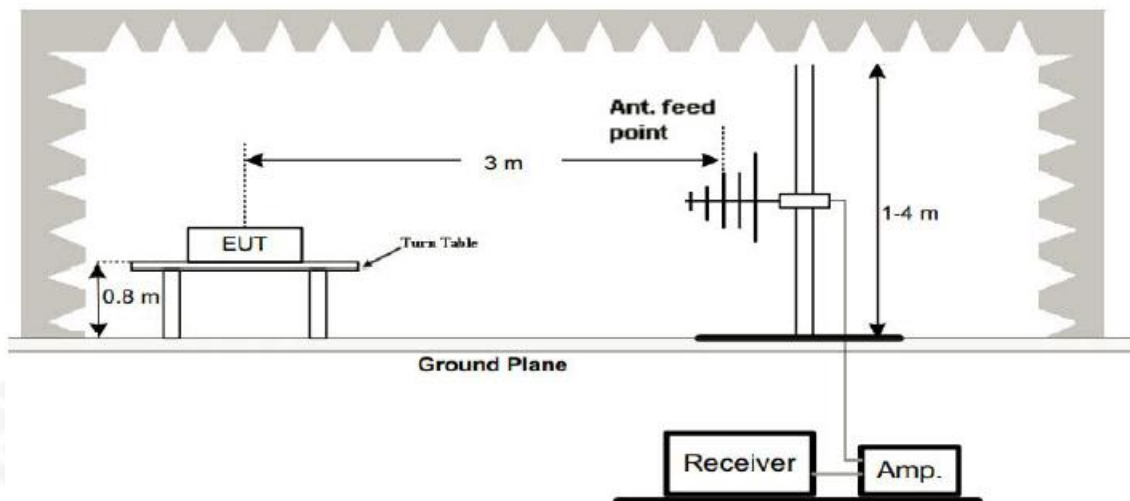



(C) Radiated Emission Test-Up Frequency Above 1GHz

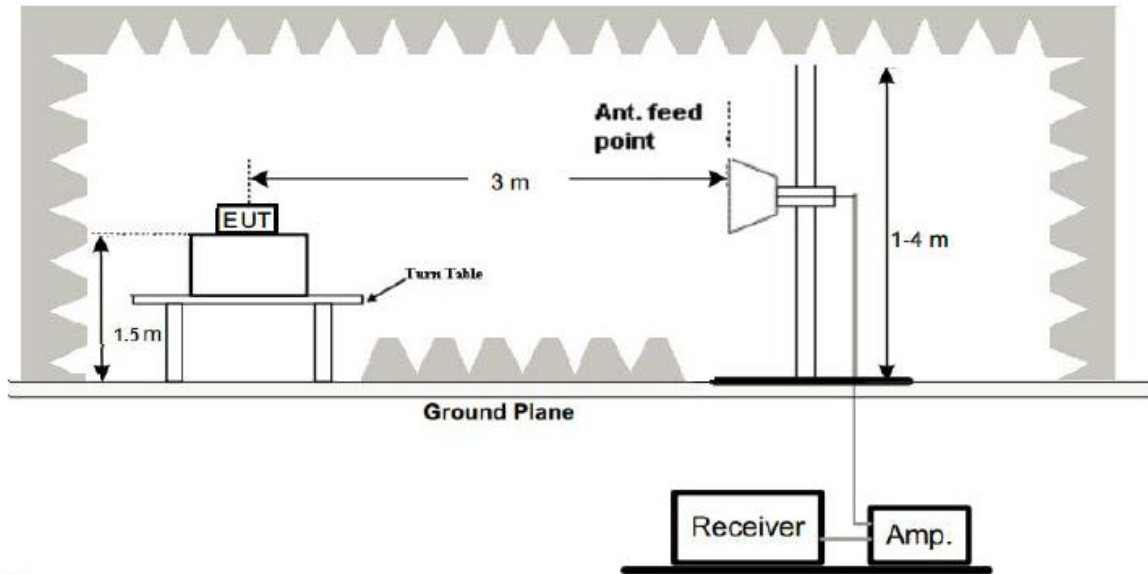

4.2.4 EUT OPERATING CONDITIONS

The EUT tested system was configured as the statements of 2.4 Unless otherwise a special operating condition is specified in the follows during the testing.

4.2.5 TEST RESULTS

Radiated Spurious Emission (Below 9KHz – 30MHz )

Temperature :	26 °C	Relative Humidity :	54%
Pressure :	101 kPa	Polarization :	---
Test Voltage :	DC 3.7V		
Test Mode :	TX Mode		

Freq. (MHz)	Reading (dBuV/m)	Limit (dBuV/m)	Margin (dB)	State P/F
--	--	--	--	PASS
--	--	--	--	PASS

NOTE:

The amplitude of spurious emissions which are attenuated by more than 20dB below the permissible value has no need to be reported.  
Distance extrapolation factor = 40 log (specific distance/test distance)(dB);  
Limit line = specific limits(dBuv) + distance extrapolation factor.



Radiated Spurious Emission (Between 30MHz – 1GHz)

Temperature :	26 °C	Relative Humidity :	54%
Pressure :	101 kPa	Polarization :	Horizontal
Test Voltage :	DC 3.7V		
Test Mode :	TX Mode		

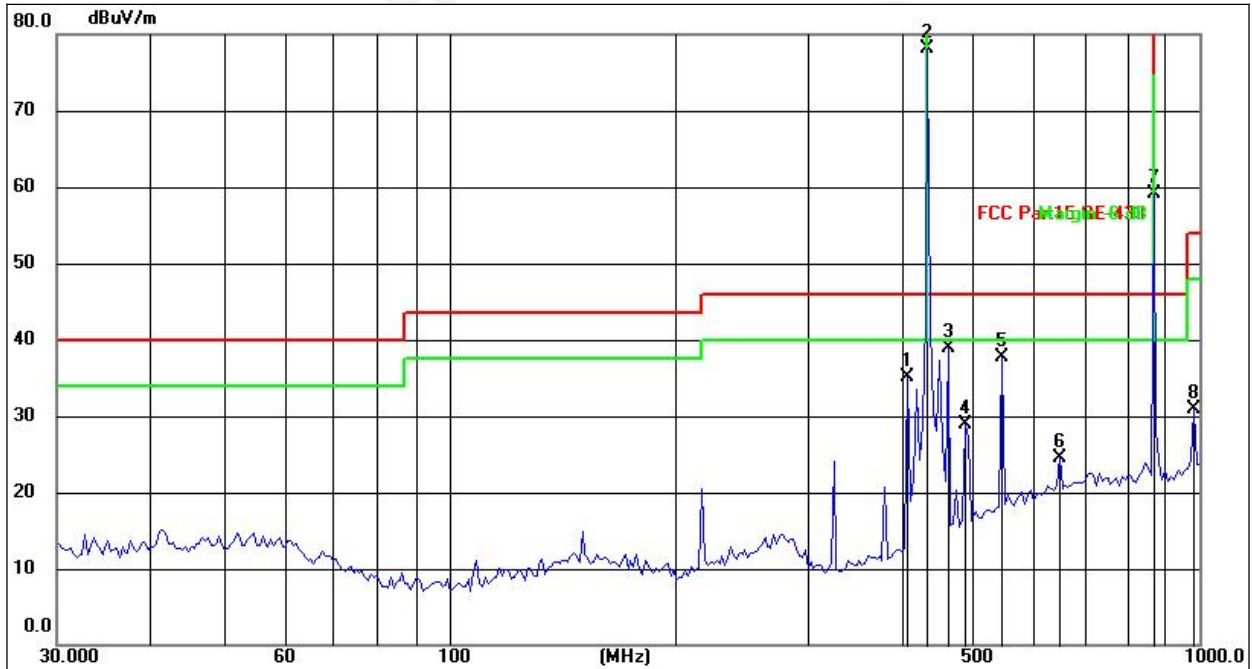

No.	Frequency (MHz)	Reading (dBuV)	Factor (dB/m)	Level (dBuV/m)	Limit (dBuV/m)	Margin (dB)	Detector
1	408.9459	51.32	-16.13	35.19	46.00	-10.81	QP
2	433.9200	92.93	-14.90	78.03	100.80	-22.77	peak
3	462.3455	52.30	-13.49	38.81	46.00	-7.19	QP
4	487.3150	41.09	-12.26	28.83	46.00	-17.17	QP
5	546.1392	48.13	-10.34	37.79	46.00	-8.21	QP
6	650.7997	32.35	-7.75	24.60	46.00	-21.40	QP
7	867.8400	66.07	-6.98	59.09	80.80	-21.71	peak
8	982.6200	36.23	-5.24	30.99	54.00	-23.01	QP

Remarks:

- 1.Final Level =Receiver Read level + Antenna Factor + Cable Loss – Preamplifier Factor
- 2.The emission levels of other frequencies are very lower than the limit and not show in test report.



Temperature :	26 °C	Relative Humidity :	54%
Pressure :	101 kPa	Polarization :	Vertical
Test Voltage :	DC 3.7V		
Test Mode :	TX Mode		

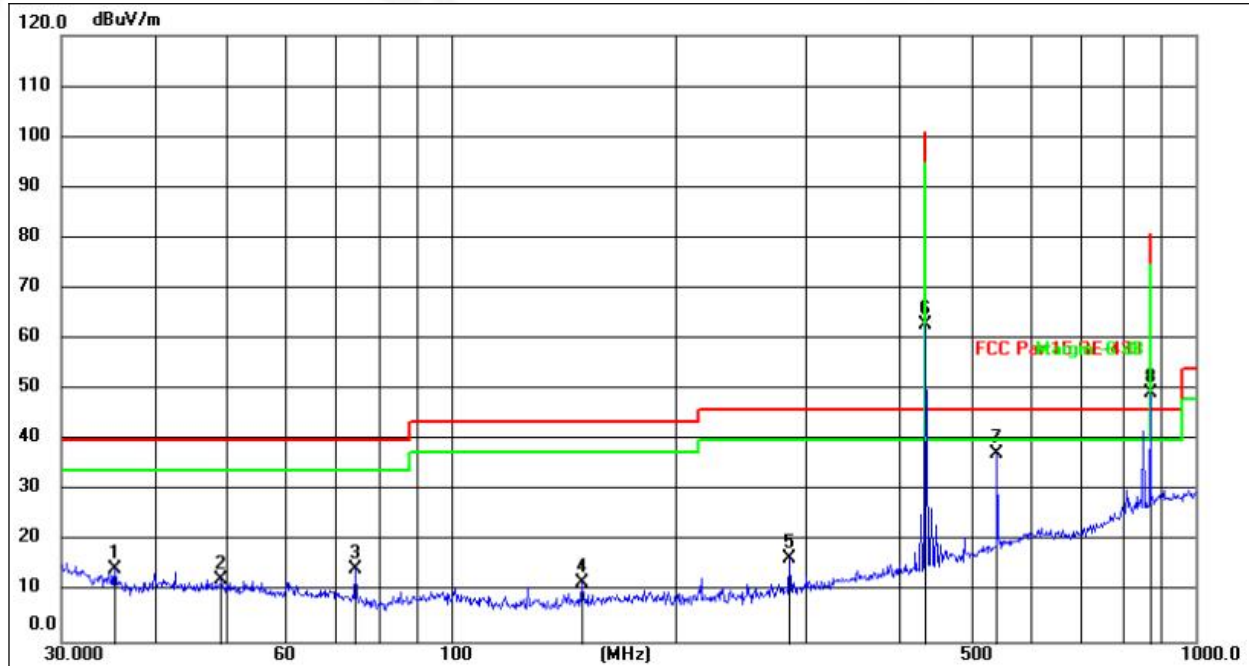

No.	Frequency (MHz)	Reading (dBuV)	Factor (dB/m)	Level (dBuV/m)	Limit (dBuV/m)	Margin (dB)	Detector
1	35.3750	31.99	-17.55	14.44	40.00	-25.56	QP
2	49.1865	29.76	-17.26	12.50	40.00	-27.50	QP
3	74.3954	35.14	-20.45	14.69	40.00	-25.31	QP
4	150.0107	32.54	-20.56	11.98	43.50	-31.52	QP
5	284.9766	35.53	-18.80	16.73	46.00	-29.27	QP
6	433.9200	76.56	-13.85	62.71	100.80	-38.09	peak
7	541.3724	47.29	-10.00	37.29	46.00	-8.71	QP
8	867.8400	51.12	-1.66	49.46	80.80	-31.34	peak

Remarks:

- 1.Final Level =Receiver Read level + Antenna Factor + Cable Loss – Preamplifier Factor
- 2.The emission levels of other frequencies are very lower than the limit and not show in test report.



For average Emission

Frequency MHz	Peak Level dBuV/m	Duty cycle factor	AverageLevel dBuV/m	Limit AV	Margin	Polarization
433.92	78.03	-7.58	70.48	80.80	-10.32	Horizontal
867.84	59.09	-7.58	51.51	60.80	-9.29	Horizontal

Notes: 1. Average emission Level = Peak Level + Duty cycle factor  
2. Duty cycle level please see clause 5.

Frequency MHz	Peak Level dBuV/m	Duty cycle factor	AverageLevel dBuV/m	Limit AV	Margin	Polarization
433.92	62.71	-7.58	55.13	80.80	-25.67	Vertical
867.84	49.46	-7.58	41.88	60.80	-18.92	Vertical

Notes: 1. Average emission Level = Peak Level + Duty cycle factor  
2. Duty cycle level please see clause 6.



Radiated Spurious Emission ( 1GHz to 10<sup>th</sup> harmonics)

Frequency MHz	Peak Level dBuV/m	Duty cycle factor	Average Level dBuV/m	Limit		Margin dB		Polarization
				PK	AV	PK	AV	
1305.88	59.02	-7.58	51.44	74.00	54.00	-22.56	-2.56	Vertical
1735.49	54.27	-7.58	46.69	80.80	60.80	-34.11	-14.11	Vertical
2606.25	51.17	-7.58	43.59	80.80	60.80	-37.21	-17.21	Vertical
3041.80	56.06	-7.58	48.48	74.00	54.00	-25.52	-5.52	Vertical
3472.72	53.90	-7.58	46.32	80.80	60.80	-34.48	-14.48	Vertical
3905.61	48.02	-7.58	40.44	74.00	54.00	-33.56	-13.56	Vertical
1303.66	52.92	-7.58	45.34	74.00	54.00	-28.66	-8.66	Horizontal
1740.08	50.73	-7.58	43.15	80.80	60.80	-37.65	-17.65	Horizontal
2606.04	52.47	-7.58	44.89	80.80	60.80	-35.91	-15.91	Horizontal
3038.19	50.05	-7.58	42.47	74.00	54.00	-31.53	-11.53	Horizontal
3476.02	49.49	-7.58	41.91	80.80	60.80	-38.89	-18.89	Horizontal
3910.10	49.45	-7.58	41.87	74.00	54.00	-32.13	-12.13	Horizontal

- Notes: 1.Average emission Level = Peak Level + Duty cycle factor  
2.Duty cycle level please see clause 6.



## 5. BANDWIDTH TEST

### 5.1 APPLIED PROCEDURES / LIMIT

According to FCC 15.231(c) requirement:

The bandwidth of the emission shall be no wider than 0.25% of the center frequency for devices operating between 70 MHz to 900 MHz. Those devices operating above 900 MHz, the emission spurious shall be no wider than 0.5% of the center frequency. Bandwidth is determined at the points 20 dB down from the modulated carrier.

$$B.W (20dBc) \text{ Limit} = 0.25\% * f(\text{MHz}) = 0.25\% * 433.92\text{MHz} = 1.0848\text{MHz}$$

Spectrum Parameter	Setting
Attenuation	Auto
Span Frequency	1.5*OBW ~ 5*OBW
RB	1%-5%OBW
VB	3 RBW,
Detector	Peak
Trace	Max Hold
Sweep Time	Auto

### 5.2 TEST PROCEDURE

- The EUT was directly connected to the spectrum analyzer and antenna output port as show in the block diagram below,
- Spectrum Setting : RBW= 1%-5%OBW, VBW≥3 RBW, Sweep time = Auto.

### 5.3 DEVIATION FROM STANDARD

No deviation.

### 5.4 TEST SETUP



### 5.5 EUT OPERATION CONDITIONS

The EUT tested system was configured as the statements of 2.4 Unless otherwise a special operating condition is specified in the follows during the testing.





5.6 TEST RESULTS

Temperature :	26 °C	Relative Humidity :	54%
Pressure :	101kPa	Test Voltage :	DC 3.7V
Test Mode :	TX Mode		

Frequency	20dB Bandwidth (kHz)	Limit (MHz)	Result
433.92MHz	145.6	0.25%*433.92=1.0848	PASS

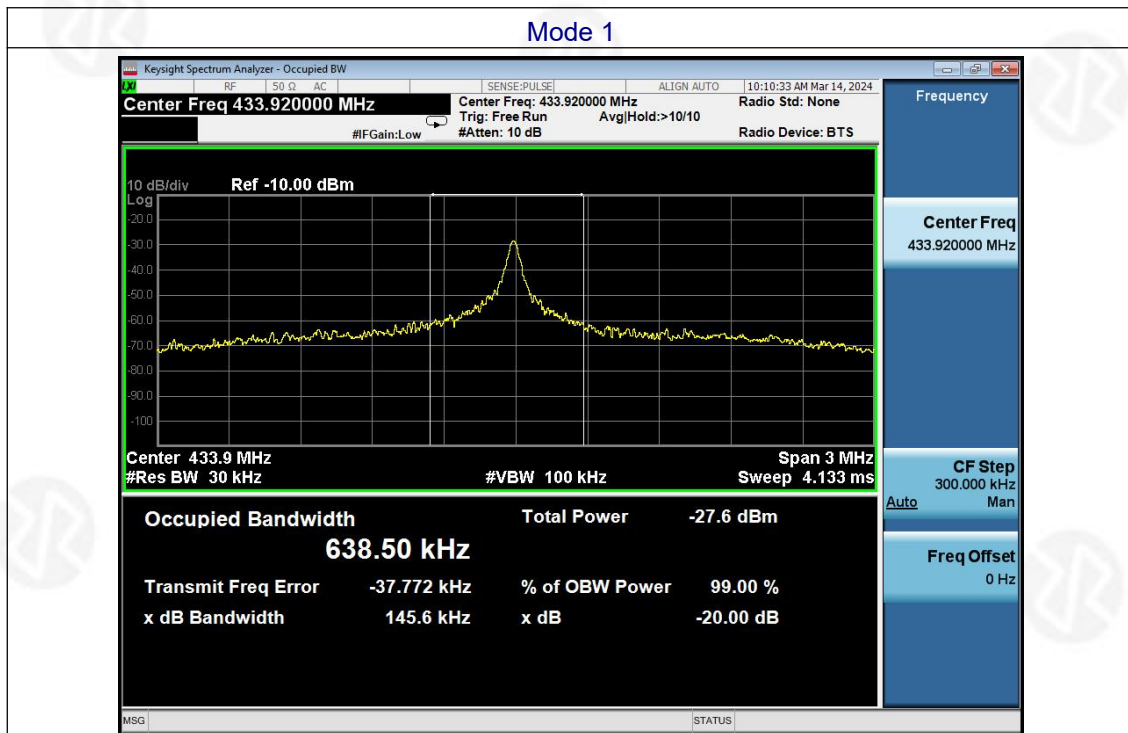



## 6. CALCULATION OF AVERAGE FACTOR

The output field strengths of specification in accordance with the FCC rules specify measurements with an average detector. During the test, a spectrum analyzer incorporating a peak detector was used. Therefore, a reduction factor can be applied to the resultant peak signal level and compared to the limit for measurement instrumentation incorporating an average detector.

The duty cycle is measured in 100 ms or the repetition cycle period, whichever is a shorter time frame. The duty cycle is measured by placing the spectrum analyzer to set zero span at 1MHz resolution bandwidth.

Averaging factor in dB =  $20\log(\text{duty cycle})$

The duration of one cycle = 54.40ms

The duty cycle is simply the on-time divided the duration of one cycle

Duty Cycle =  $(0.960\text{ms} \cdot 15 + 0.320\text{ms} \cdot 26) / 54.40\text{ms}$

=  $22.72\text{ms} / 54.40\text{ms}$

= 0.418

Therefore, the averaging factor is found by  $20\log 0.418 = -7.576\text{dB}$

Test plot as follows:

Note: During the 160ms, the amount of pulse and on-time of pulse are the same for every pulse train.

Cycle

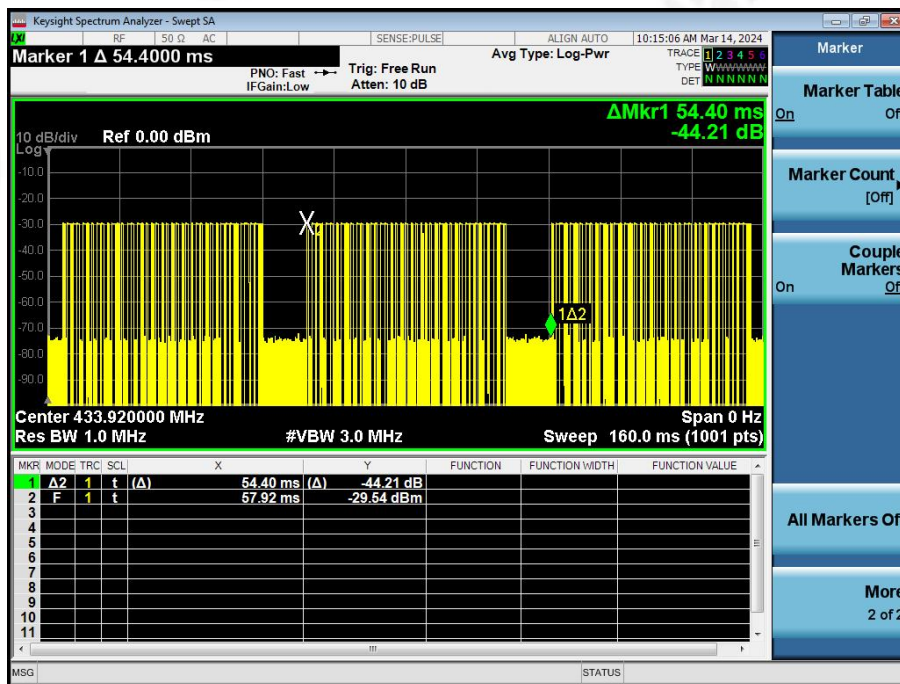



### Pulse

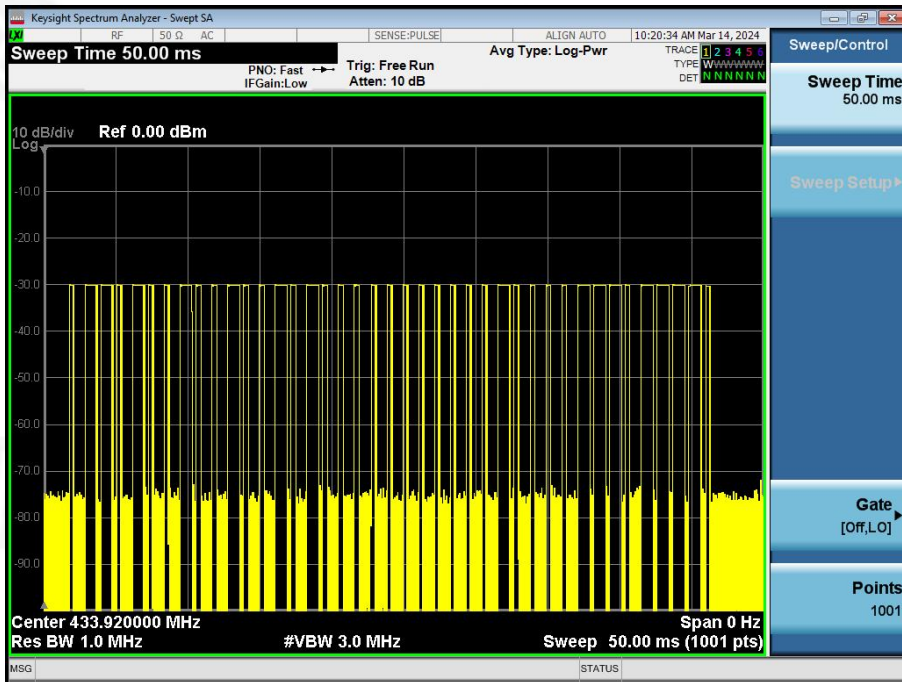

### On-time

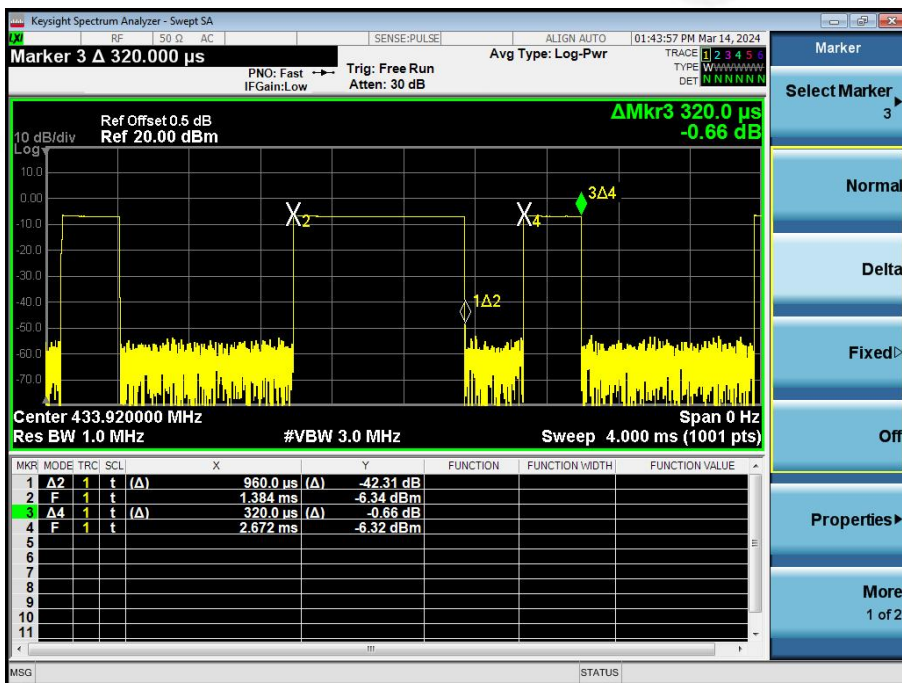



## 7. DWELL TIME

### 7.1 APPLICABLE STANDARD

According to FCC 15.231(a) requirement:

A manually operated transmitter shall employ a switch that will automatically deactivate the transmitter within not more than 5 seconds of being released.

### 7.2 TEST PROCEDURE

Check the calibration of the measuring instrument using either an internal calibrator or a known signal from an external generator.

- 1.Position the EUT without connection to measurement instrument. Turn on the EUT and connect its antenna terminal to measurement instrument via a low loss cable. Then set it to any one measured frequency within its operating range, and make sure the instrument is operated in its linear range.
- 2.Set RBW to 100 kHz and VBW of spectrum analyzer to 300 kHz with a convenient frequency span including 100 kHz bandwidth from band edge.
- 3.Measure the highest amplitude appearing on spectral display and set it as a reference level. Plot the graph with marking the highest point and edge frequency.
- 4.Repeat above procedures until all measured frequencies were complete.

### 7.3 DEVIATION FROM STANDARD

No deviation.

### 7.4 TEST SETUP



### 7.5 EUT OPERATION CONDITIONS

The EUT tested system was configured as the statements of 2.4 Unless otherwise a special operating condition is specified in the follows during the testing.



### 7.6 TEST RESULTS

Dwell time (millisecond)	Limit (second)	Result
3.960s	<5s	Pass

Test plot as follows:

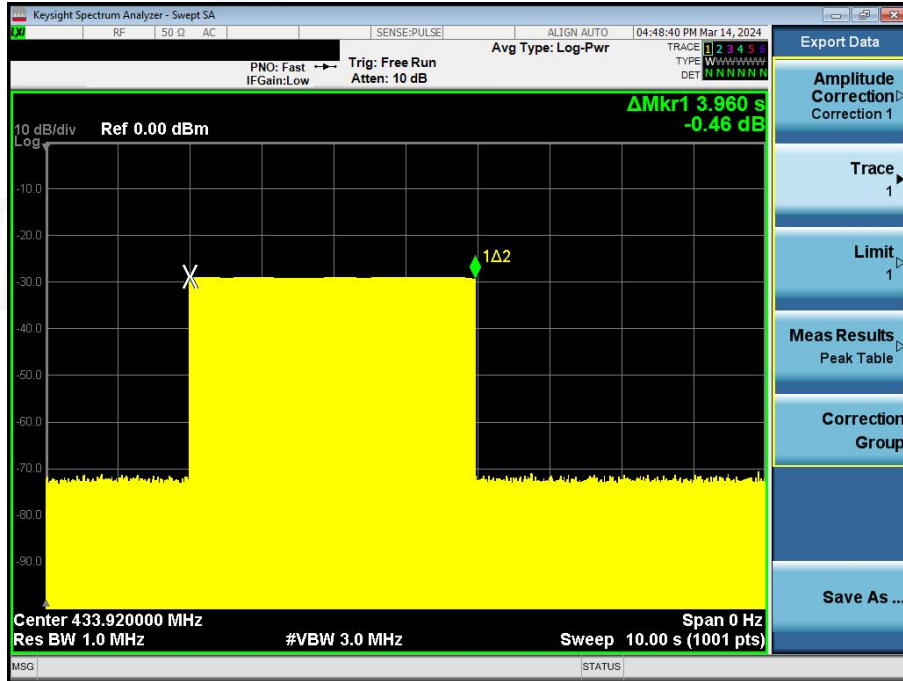



## 8. ANTENNA REQUIREMENT

Standard requirement:	FCC Part15 C Section 15.203
15.203 requirement: An intentional radiator shall be designed to ensure that no antenna other than that furnished by the responsible party shall be used with the device. The use of a permanently attached antenna or of an antenna that uses a unique coupling to the intentional radiator, the manufacturer may design the unit so that a broken antenna can be replaced by the user, but the use of a standard antenna jack or electrical connector is prohibited.	
EUT Antenna:	
The antenna is Spring Coil Antenna, the best case gain of the antennas are 0.84dBi, reference to the appendix II for details	



## 9. TEST SETUP PHOTO

Reference to the appendix I for details.

## 10. EUT CONSTRUCTIONAL DETAILS

Reference to the appendix II for details.

\*\*\*\*\* END OF REPORT \*\*\*\*\*