



FCC TEST REPORT

FCC ID:2AXCX-LTPMS0124

Report Number.....: **ZKT-2401301426E-5**

Date of Test..... Feb. 21, 2024 to Mar. 14, 2024

Date of issue.....: Mar. 14, 2024

Total number of pages..... 23

Test Result: PASS

Testing Laboratory.....: **Shenzhen ZKT Technology Co., Ltd.**

Address: 1/F, No. 101, Building B, No. 6, Tangwei Community Industrial Avenue, Fuhai Street, Bao'an District, Shenzhen, China

Applicant's name: **Shenzhen Foxwell Technology Co., Ltd**

Address: 5/F, Plant C, Baocheng 71st Zone, Xin'an Street, Baoan District, Shenzhen 518106, China

Manufacturer's name: **Shenzhen Foxwell Technology Co., Ltd**

Address: 5/F, Plant C, Baocheng 71st Zone, Xin'an Street, Baoan District, Shenzhen 518106, China

Test specification:

Standard.....: FCC CFR Title 47 Part 15 Subpart C

Test procedure.....: /

Non-standard test method: N/A

Test Report Form No.....: TRF-EL-112_V0

Test Report Form(s) Originator.....: ZKT Testing

Master TRF: Dated: 2020-01-06

This device described above has been tested by ZKT, and the test results show that the equipment under test (EUT) is in compliance with the FCC requirements. And it is applicable only to the tested sample identified in the report.

This report shall not be reproduced except in full, without the written approval of ZKT, this document may be altered or revised by ZKT, personal only, and shall be noted in the revision of the document.

Product name.....: **TPMS Service Tool (WiFi Version)**

Trademark: N/A

Model/Type reference.....: T2000WF

T66WF, TP300WF, TS300WF, PS100WF, H020WF, LT200WF, HT600WF.

Ratings.....: Input : 5V $\overline{=}$ 2.0A

Battery : 3.7V, 3000mAh, 11.1Wh



Testing procedure and testing location:

Testing Laboratory.....: **Shenzhen ZKT Technology Co., Ltd.**

Address.....: 1/F, No. 101, Building B, No. 6, Tangwei Community Industrial Avenue, Fuhai Street, Bao'an District, Shenzhen, China

Tested by (name + signature).....: Tom Zou

Tom Zou

Reviewer (name + signature).....: Jackson Fang

Jackson Fang

Approved (name + signature).....: Lake Xie





Table of Contents	Page
1.VERSION	4
2. SUMMARY OF TEST RESULTS	5
2.1 TEST FACILITY	6
2.2 MEASUREMENT UNCERTAINTY	6
3. GENERAL INFORMATION	7
3.1 GENERAL DESCRIPTION OF EUT	7
3.3 DESCRIPTION OF TEST MODES	8
3.4 BLOCK DIGRAM SHOWING THE CONFIGURATION OF SYSTEM TESTED	8
3.5 DESCRIPTION OF SUPPORT UNITS(CONDUCTED MODE)	8
3.6 EQUIPMENTS LIST FOR ALL TEST ITEMS	9
4. EMC EMISSION TEST	11
4.1 CONDUCTED EMISSION MEASUREMENT	11
4.1.1 POWER LINE CONDUCTED EMISSION Limits	11
4.1.2 TEST PROCEDURE	11
4.1.3 DEVIATION FROM TEST STANDARD	11
4.1.4 TEST SETUP	12
4.1.5 EUT OPERATING CONDITIONS	12
4.2 RADIATED EMISSION MEASUREMENT	15
4.2.1 RADIATED EMISSION LIMITS	15
4.2.2 TEST PROCEDURE	15
4.2.3 DEVIATION FROM TEST STANDARD	16
4.2.4 TEST SETUP	16
4.2.5 EUT OPERATING CONDITIONS	17
5. CHANNEL BANDWIDTH	20
6.1 APPLIED PROCEDURES / LIMIT	20
6.2 TEST PROCEDURE	20
6.3 DEVIATION FROM STANDARD	20
6.4 TEST SETUP	20
6.5 EUT OPERATION CONDITIONS	20
6.6 TEST RESULT	21
7.ANTENNA REQUIREMENT	22
8. TEST SETUP PHOTO	23
9. EUT CONSTRUCTIONAL DETAILS	23



1.VERSION

Report No.	Version	Description	Approved
ZKT-2401301426E-5	Rev.01	Initial issue of report	Mar. 14, 2024



2. SUMMARY OF TEST RESULTS

Test procedures according to the technical standards:

FCC Part15 (15.225) , Subpart C			
Standard Section	Test Item	Judgment	Remark
FCC part 15.203	Antenna requirement	PASS	
FCC part 15.207	AC Power Line Conducted Emission	PASS	
FCC part 15.209	Radiated Spurious Emission Measurement	PASS	
FCC part 15.215	Channel Bandwidth	PASS	

NOTE:

(1) "N/A" denotes test is not applicable in this Test Report



2.1 TEST FACILITY

Shenzhen ZKT Technology Co., Ltd.

Add. : 1/F, No. 101, Building B, No. 6, Tangwei Community Industrial Avenue, Fuhai Street, Bao'an District, Shenzhen, China

FCC Test Firm Registration Number: 692225

Designation Number: CN1299

IC Registered No.: 27033

2.2 MEASUREMENT UNCERTAINTY

The reported uncertainty of measurement $y \pm U$ · where expanded uncertainty U is based on a standard uncertainty multiplied by a coverage factor of $k=2$ · providing a level of confidence of approximately 95 % .

No.	Item	Uncertainty
1	3m chamber Radiated spurious emission(9KHz-30MHz)	U=4.5dB
2	3m chamber Radiated spurious emission(30MHz-1GHz)	U=4.8dB
3	3m chamber Radiated spurious emission(1GHz-6GHz)	U=4.9dB
4	3m chamber Radiated spurious emission(6GHz-40GHz)	U=5.0dB
5	Conducted disturbance	U=3.2dB
6	RF conducted Spurious Emission	U=2.2dB
7	RF Occupied Bandwidth	U=1.8MHz
8	humidity uncertainty	U=5.3%
9	Temperature uncertainty	U=0.59°C



3. GENERAL INFORMATION

3.1 GENERAL DESCRIPTION OF EUT

Product Name:	TPMS Service Tool (WiFi Version)
Model No.:	T2000WF
Model Different.:	All the model are the same circuit and RF module, only the model name is different.
Serial No.:	T66WF, TP300WF, TS300WF, PS100WF, H020WF, LT200WF, HT600WF.
Hardware Version:	H1.0
Software Version:	S1.0
Sample(s) Status:	Engineer sample
Operation Frequency:	125kHz
Channel Numbers:	1
Channel Separation:	N/A
Modulation Type:	ASK
Antenna Type:	Spring Coil Antenna
Antenna gain:	0.50dBi
Power supply:	Input : 5V===2.0A Battery : 3.7V, 3000mAh, 11.1Wh

3.2 TEST CHANNEL

Channel List			
Channel	Frequency(kHz)	Channel	Frequency(kHz)
01	125		



3.3 DESCRIPTION OF TEST MODES

Transmitting mode	Keep the EUT in continuously transmitting NFC mode
Remark: During the test, the test voltage was tuned from 85% to 115% of the nominal rated supply voltage, and found that the worst case was under the nominal rated supply condition. So the report just shows that condition's data.	

3.4 BLOCK DIGRAM SHOWING THE CONFIGURATION OF SYSTEM TESTED

Conducted Emission

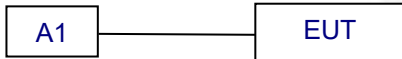

Radiated Emission

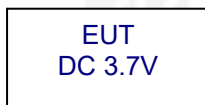

Conducted Spurious

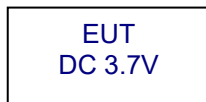

3.5 DESCRIPTION OF SUPPORT UNITS(CONDUCTED MODE)

The EUT has been tested as an independent unit together with other necessary accessories or support units. The following support units or accessories were used to form a representative test configuration during the tests.

Item	Equipment	Mfr/Brand	Model/Type No.	Series No.	Note
E-1	TPMS Service Tool (WiFi Version)	N/A	BCST-21	BCST-22	EUT
A-1	Adapter	HUAWEI	HW-050100B3W	N/A	Auxiliary

Item	Shielded Type	Ferrite Core	Length	Note

Note:

- (1) The support equipment was authorized by Declaration of Confirmation.
- (2) For detachable type I/O cable should be specified the length in cm in 『Length』 column.
- (3) EUT used new batteries during test.



3.6 EQUIPMENTS LIST FOR ALL TEST ITEMS

Conducted emissions Test

Item	Kind of Equipment	Manufacturer	Type No.	Serial No.	Firmware Version	Last calibration	Calibrated until
1	LISN	R&S	ENV216	101471	N/A	Oct. 21, 2023	Oct. 20, 2024
2	LISN	CYBERTEK	EM5040A	E1850400149	N/A	Oct. 21, 2023	Oct. 20, 2024
3	Test Cable	N/A	C-01	N/A	N/A	Oct. 21, 2023	Oct. 20, 2024
4	Test Cable	N/A	C-02	N/A	N/A	Oct. 21, 2023	Oct. 20, 2024
5	Test Cable	N/A	C-03	N/A	N/A	Oct. 21, 2023	Oct. 20, 2024
6	EMI Test Receiver	R&S	ESCI3	101393	4.42 SP3	Oct. 28, 2023	Oct. 27, 2024
7	Triple-Loop Antenna	N/A	RF300	N/A	N/A	Oct. 28, 2023	Oct. 27, 2024
8	Absorbing Clamp	DZ	ZN23201	15034	N/A	Oct. 31, 2024	Oct. 30, 2024
9	EMC Software	Frad	EZ-EMC	Ver.EMC-CO N 3A1.1	N/A	\	\

Radiated emissions Test & Radio Test equipment

Item	Equipment	Manufacturer	Type No.	Serial No.	Firmware Version	Last calibration	Calibrated until
1	Spectrum Analyzer (9kHz-26.5GHz)	KEYSIGHT	9020A	MY55370835	A.17.05	Oct. 28, 2023	Oct. 27, 2024
2	Spectrum Analyzer (10kHz-39.9GHz)	R&S	FSV40-N	100363	1.71 SP2	Oct. 28, 2023	Oct. 27, 2024
3	EMI Test Receiver (9kHz-7GHz)	R&S	ESCI7	101169	4.32	Oct. 28, 2023	Oct. 27, 2024
4	Bilog Antenna (30MHz-1500MHz)	Schwarzbeck	VULB9168	N/A	N/A	Nov. 02, 2022	Mar. 14, 2024
5	Horn Antenna (1GHz-18GHz)	Agilent	AH-118	071145	N/A	Mar. 14, 2024	Oct. 31, 2024
6	Horn Antenna (15GHz-40GHz)	A.H.System	SAS-574	588	N/A	Oct. 28, 2023	Oct. 27, 2024
7	Loop Antenna	TESEQ	HLA6121	58357	N/A	Mar. 14, 2024	Oct. 31, 2024
8	Amplifier (30-1000MHz)	EM Electronics	EM330 Amplifier	060747	N/A	Nov. 15, 2022	Nov. 14, 2023
9	Amplifier (1GHz-26.5GHz)	Agilent	8449B	3008A00315	N/A	Oct. 28, 2023	Oct. 27, 2024
10	Amplifier (500MHz-40GHz)	Quanjuda	DLE-161	097	N/A	Oct. 28, 2023	Oct. 27, 2024
11	Test Cable	N/A	R-01	N/A	N/A	Oct. 28, 2023	Oct. 27, 2024
12	Test Cable	N/A	R-02	N/A	N/A	Oct. 28, 2023	Oct. 27, 2024
13	Test Cable	N/A	R-03	N/A	N/A	Oct. 28, 2023	Oct. 27, 2024
14	Test Cable	N/A	RF-01	N/A	N/A	Oct. 28, 2023	Oct. 27, 2024
15	Test Cable	N/A	RF-02	N/A	N/A	Oct. 28, 2023	Oct. 27, 2024
16	Test Cable	N/A	RF-03	N/A	N/A	Oct. 28, 2023	Oct. 27, 2024
17	ESG Signal Generator	Agilent	E4421B	N/A	B.03.84	Oct. 21, 2023	Oct. 20, 2024
18	Signal Generator	Agilent	N5182A	N/A	A.01.87	Oct. 21, 2023	Oct. 20, 2024



19	Magnetic Field Probe Tester	Narda	ELT-400	0-0344	N/A	Nov. 15, 2022	Nov. 14, 2023
20	Wideband Radio Communication Test	R&S	CMW500	106504	V 3.7.22	Oct. 28, 2023	Oct. 27, 2024
21	RF Power Meter	KEYSIGHT	N1912A P	N/A	A.05.00	Oct. 21, 2023	Oct. 20, 2024
22	D.C. Power Supply	LongWei	TPR-6405D	N/A	N/A	\	\
23	EMC Software	Frad	EZ-EMC	Ver.EMC-CO N 3A1.1	N/A	\	\
24	RF Software	MW	MTS8310	V2.0.0.0	N/A	\	\
25	Turntable	MF	MF-7802BS	N/A	N/A	\	\
26	Antenna tower	MF	MF-7802BS	N/A	N/A	\	\



4. EMC EMISSION TEST

4.1 CONDUCTED EMISSION MEASUREMENT

Test Requirement:	FCC Part15 C Section 15.207
Test Method:	ANSI C63.10:2013
Test Frequency Range:	150KHz to 30MHz
Receiver setup:	RBW=9KHz, VBW=30KHz, Sweep time=auto

4.1.1 POWER LINE CONDUCTED EMISSION Limits

FREQUENCY (MHz)	Limit (dBuV)		Standard
	Quas-peak	Average	
0.15 -0.5	66 - 56 *	56 - 46 *	FCC
0.50 -5.0	56.00	46.00	FCC
5.0 -30.0	60.00	50.00	FCC

Note:

(1) *Decreases with the logarithm of the frequency.

4.1.2 TEST PROCEDURE

- The EUT was placed 0.8 meters from the horizontal ground plane with EUT being connected to the power mains through a line impedance stabilization network (LISN). All other support equipments powered from additional LISN(s). The LISN provide 50 Ohm/ 50uH of coupling impedance for the measuring instrument.
- Interconnecting cables that hang closer than 40 cm to the ground plane shall be folded back and forth in the center forming a bundle 30 to 40 cm long.
- I/O cables that are not connected to a peripheral shall be bundled in the center. The end of the cable may be terminated, if required, using the correct terminating impedance. The overall length shall not exceed 1 m.
- LISN at least 80 cm from nearest part of EUT chassis.
- For the actual test configuration, please refer to the related Item –EUT Test Photos.

4.1.3 DEVIATION FROM TEST STANDARD

No deviation



4.1.4 TEST SETUP

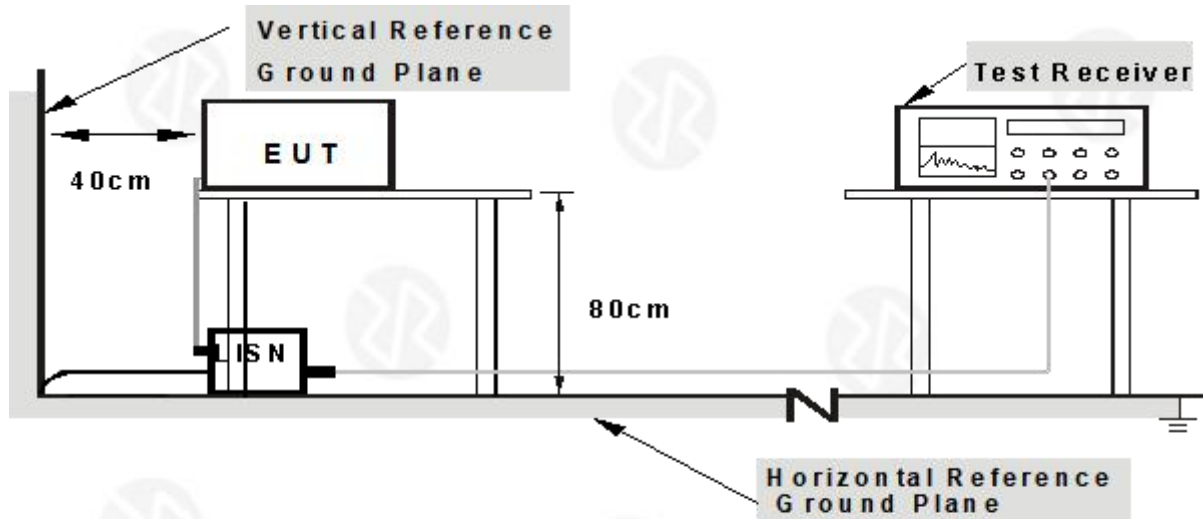

- Note: 1.Support units were connected to second LISN.**
2.Both of LISNs (AMN) are 80 cm from EUT and at least 80 cm from other units and other metal planes

4.1.5 EUT OPERATING CONDITIONS

The EUT was configured for testing in a typical fashion (as a customer would normally use it). The EUT has been programmed to continuously transmit during test. This operating condition was tested and used to collect the included data.



4.1.6 Test Result

Temperature :	26°C	Relative Humidity:	54%
Pressure :	101kPa	Phase :	L
Test Voltage :	AC 120V/60Hz	Mode:	TX ASK 125KHz

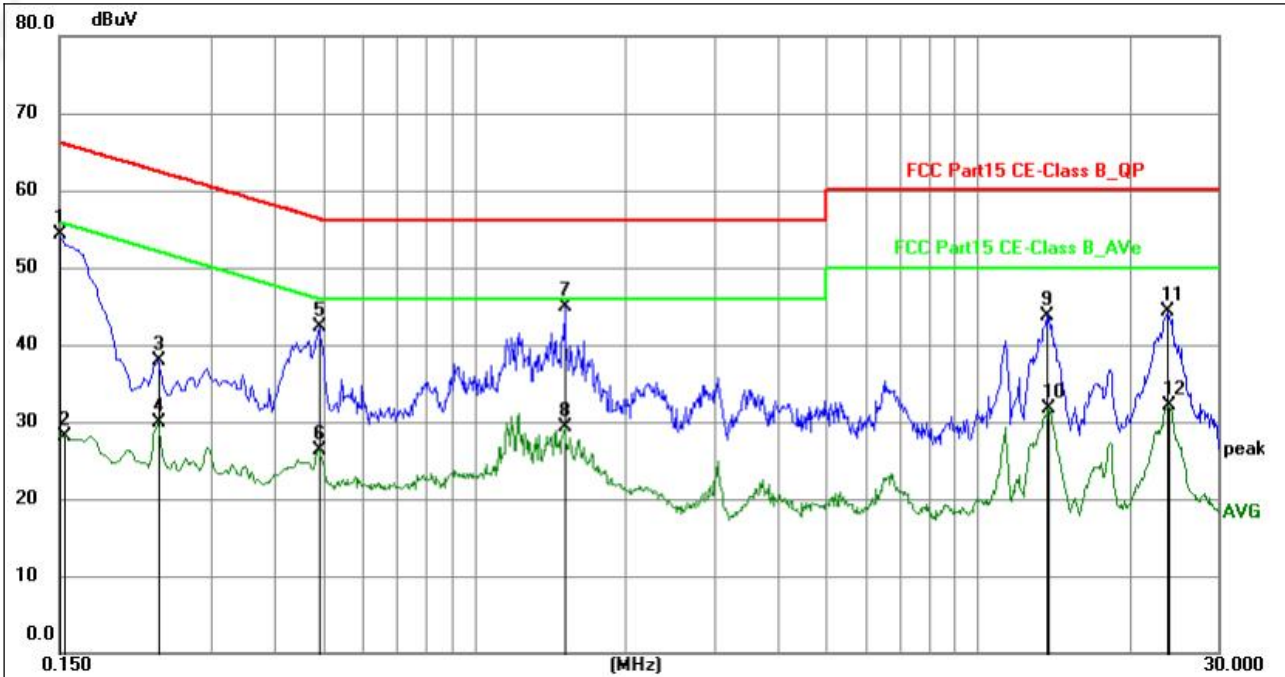

No.	Frequency (MHz)	Reading (dBuV)	Factor (dB)	Level (dBuV)	Limit (dBuV)	Margin (dB)	Detector	P/F
1	0.1500	33.90	20.48	54.38	66.00	-11.62	QP	P
2	0.1532	7.70	20.49	28.19	55.82	-27.63	AVG	P
3	0.2355	17.31	20.67	37.98	62.25	-24.27	QP	P
4	0.2355	9.33	20.67	30.00	52.25	-22.25	AVG	P
5	0.4920	21.67	20.55	42.22	56.13	-13.91	QP	P
6	0.4920	5.85	20.55	26.40	46.13	-19.73	AVG	P
7	1.5179	24.15	20.81	44.96	56.00	-11.04	QP	P
8	1.5179	8.52	20.81	29.33	46.00	-16.67	AVG	P
9	13.6995	22.20	21.60	43.80	60.00	-16.20	QP	P
10	13.8120	10.15	21.61	31.76	50.00	-18.24	AVG	P
11	23.8110	22.54	21.79	44.33	60.00	-15.67	QP	P
12	23.9460	10.29	21.80	32.09	50.00	-17.91	AVG	P

Notes:

1. An initial pre-scan was performed on the line and neutral lines with peak detector.
2. Quasi-Peak and Average measurement were performed at the frequencies with maximized peak emission.
3. Measurement Level = Reading level + Correct Factor



Temperature :	26°C	Relative Humidity:	54%
Pressure :	101kPa	Phase :	N
Test Voltage :	AC 120V/60Hz	Mode:	TX ASK 125KHz

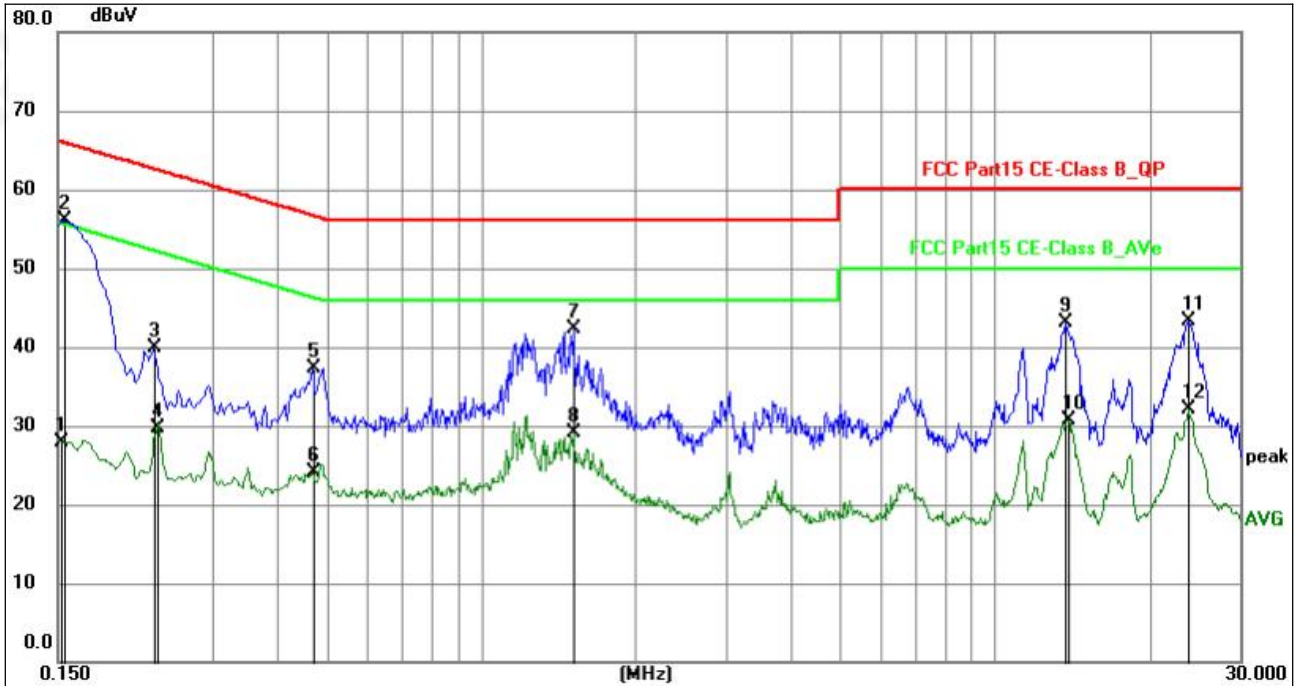

No.	Frequency (MHz)	Reading (dBuV)	Factor (dB)	Level (dBuV)	Limit (dBuV)	Margin (dB)	Detector	P/F
1	0.1524	7.40	20.59	27.99	55.87	-27.88	AVG	P
2	0.1544	35.46	20.60	56.06	65.76	-9.70	QP	P
3	0.2310	19.20	20.78	39.98	62.41	-22.43	QP	P
4	0.2340	9.01	20.78	29.79	52.31	-22.52	AVG	P
5	0.4695	16.70	20.70	37.40	56.52	-19.12	QP	P
6	0.4695	3.34	20.70	24.04	46.52	-22.48	AVG	P
7	1.5134	21.39	20.82	42.21	56.00	-13.79	QP	P
8	1.5134	8.21	20.82	29.03	46.00	-16.97	AVG	P
9	13.7130	21.67	21.53	43.20	60.00	-16.80	QP	P
10	13.8975	9.14	21.54	30.68	50.00	-19.32	AVG	P
11	23.8875	21.61	21.73	43.34	60.00	-16.66	QP	P
12	23.8875	10.30	21.73	32.03	50.00	-17.97	AVG	P

Notes:

- 1.An initial pre-scan was performed on the line and neutral lines with peak detector.
- 2.Quasi-Peak and Average measurement were performed at the frequencies with maximized peak emission.
- 3.Measurement Level = Reading level + Correct Factor



4.2 RADIATED EMISSION MEASUREMENT

Test Requirement:	FCC Part15 C Section 15.209				
Test Method:	ANSI C63.10:2013				
Test Frequency Range:	9kHz to 1GHz				
Test site:	Measurement Distance: 3m				
Receiver setup:	Frequency	Detector	RBW	VBW	Value
	9KHz-150KHz	Quasi-peak	200Hz	600Hz	Quasi-peak
	150KHz-30MHz	Quasi-peak	9KHz	30KHz	Quasi-peak
	30MHz-1GHz	Quasi-peak	100KHz	300KHz	Quasi-peak
	Above 1GHz	Peak	1MHz	3MHz	Peak
Peak		1MHz	10Hz	Average	

4.2.1 RADIATED EMISSION LIMITS

Frequencies (MHz)	Field Strength (micorvolts/meter)	Measurement Distance (meters)
0.009~0.490	2400/F(KHz)	300
0.490~1.705	24000/F(KHz)	30
1.705~30.0	30	30
30~88	100	3
88~216	150	3
216~960	200	3
Above 960	500	3

4.2.2 TEST PROCEDURE

- The measuring distance of at 3 m shall be used for measurements at frequency up to 25GHz. For frequencies above 1GHz, any suitable measuring distance may be used.
- The EUT was placed on the top of a rotating table 0.8 meters above the ground at a 3 meter semi-chamber test. The table was rotated 360 degrees to determine the position of the highest radiation.
- The height of the equipment or of the substitution antenna shall be 0.8m; above 1GHz, the height was 1.5m, the height of the test antenna shall vary between 1 m to 4 m. Both horizontal and vertical polarizations of the antenna are set to make the measurement.
- The initial step in collecting conducted emission data is a spectrum analyzer peak detector mode pre-scanning the measurement frequency range. Significant peaks are then marked and then Quasi Peak detector mode re-measured.
- If the Peak Mode measured value compliance with and lower than Quasi Peak Mode Limit, the EUT shall be deemed to meet QP Limits and then no additional QP Mode measurement performed.
- For the actual test configuration, please refer to the related Item –EUT Test Photos.



g. For the radiated emission test above 1GHz:

Place the measurement antenna away from each area of the EUT determined to be a source of emissions at the specified measurement distance, while keeping the measurement antenna aimed at the source of emissions at each frequency of significant emissions, with polarization oriented for maximum response.

The measurement antenna may have to be higher or lower than the EUT, depending on the radiation pattern of the emission and staying aimed at the emission source for receiving the maximum signal. The final measurement antenna elevation shall be that which maximizes the emissions. The measurement antenna elevation for maximum emissions shall be restricted to a range of heights of from 1 m to 4 m above the ground or reference ground plane.

Note:

Both horizontal and vertical antenna polarities were tested and performed pretest to three orthogonal axis. The worst case emissions were reported

4.2.3 DEVIATION FROM TEST STANDARD

No deviation

4.2.4 TEST SETUP

(A) Radiated Emission Test-Up Frequency Below 30MHz

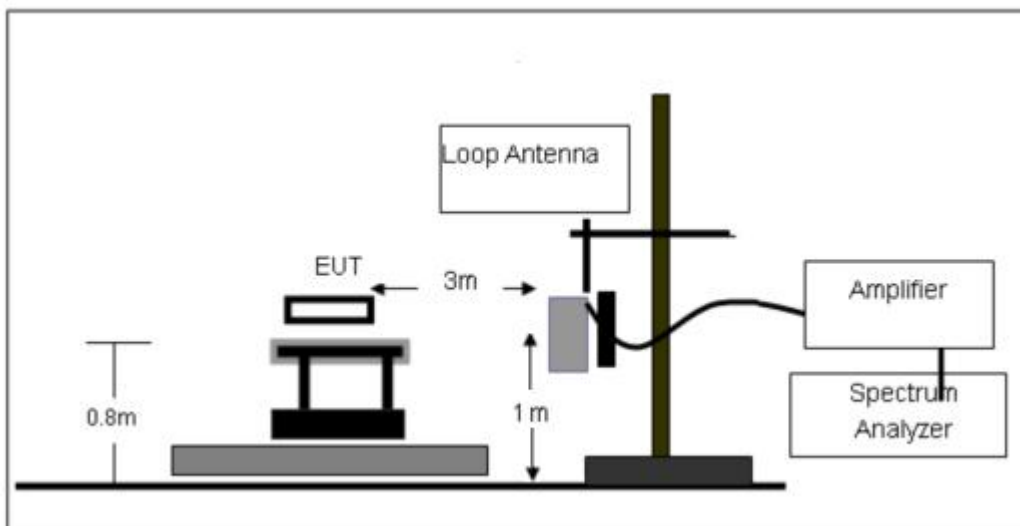

(B) Radiated Emission Test-Up Frequency 30MHz~1GHz

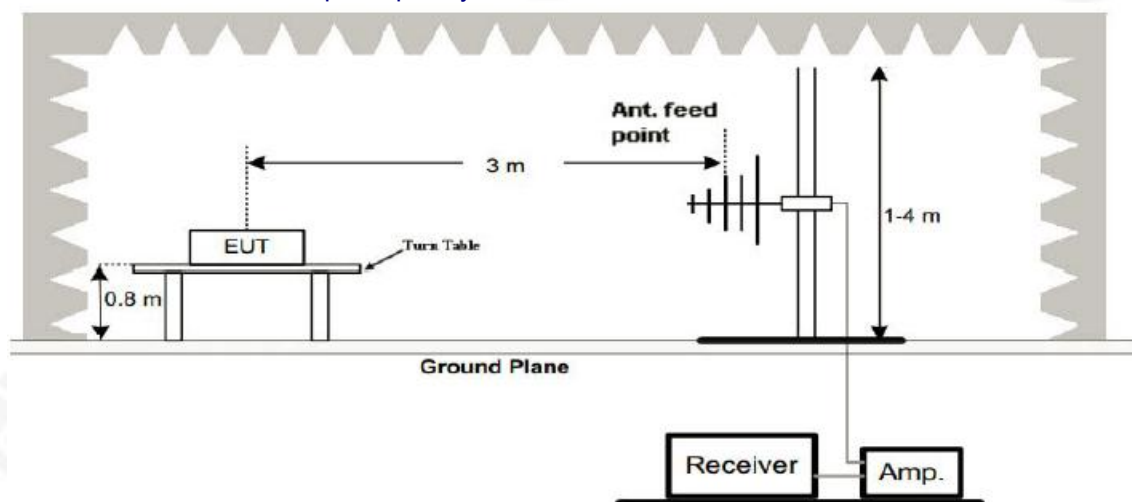



(C) Radiated Emission Test-Up Frequency Above 1GHz

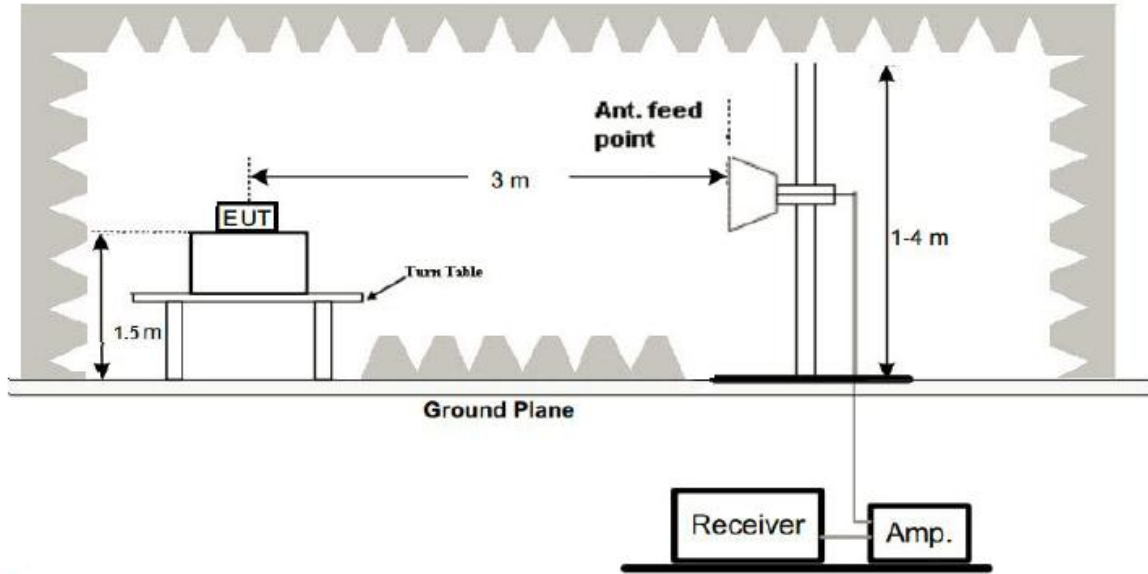

4.2.5 EUT OPERATING CONDITIONS

The EUT was configured for testing in a typical fashion (as a customer would normally use it). The EUT has been programmed to continuously transmit during test. This operating condition was tested and used to collect the included data.

4.2.6 TEST RESULTS

Field Strength of Fundamental

Between 9KHz – 30 MHz

Note: Limit dBuV/m @3m = Limit dBuV/m @300m+ 80
Limit dBuV/m @3m = Limit dBuV/m @30m + 40

Frequency (kHz)	Meter Reading (dBμV)	Factor (dB/m)	Emission Level (dBμV/m)	Limits (dBμV/m)	Margin (dB)	Detector Type
23.85	37.52	15.35	52.87	120.05	-67.18	AV
59.33	38.64	15.26	53.90	112.14	-58.24	AV
125.00	56.69	16.89	73.58	105.67	-32.09	AV
1237.15	38.45	15.87	54.32	65.76	-11.44	QP
2136.25	36.36	17.48	53.84	69.54	-15.70	QP
3217.92	34.59	18.72	53.31	69.54	-16.23	QP
6845.63	32.38	16.34	48.72	69.54	-20.82	QP
9272.28	30.74	12.85	43.59	69.54	-25.95	QP
11136.58	31.85	11.36	43.21	69.54	-26.33	QP

Note:
Pre-scan in the all of mode, the worst case in of was recorded.
Factor = antenna factor + cable loss – pre-amplifier.
Margin = Emission Level- Limit.



Between 30MHz – 1GHz

Temperature:	26°C	Relative Humidity:	54%
Pressure:	101 kPa	Polarization:	Horizontal
Test Voltage:	AC 120V/60Hz	Mode:	TX ASK 125KHz

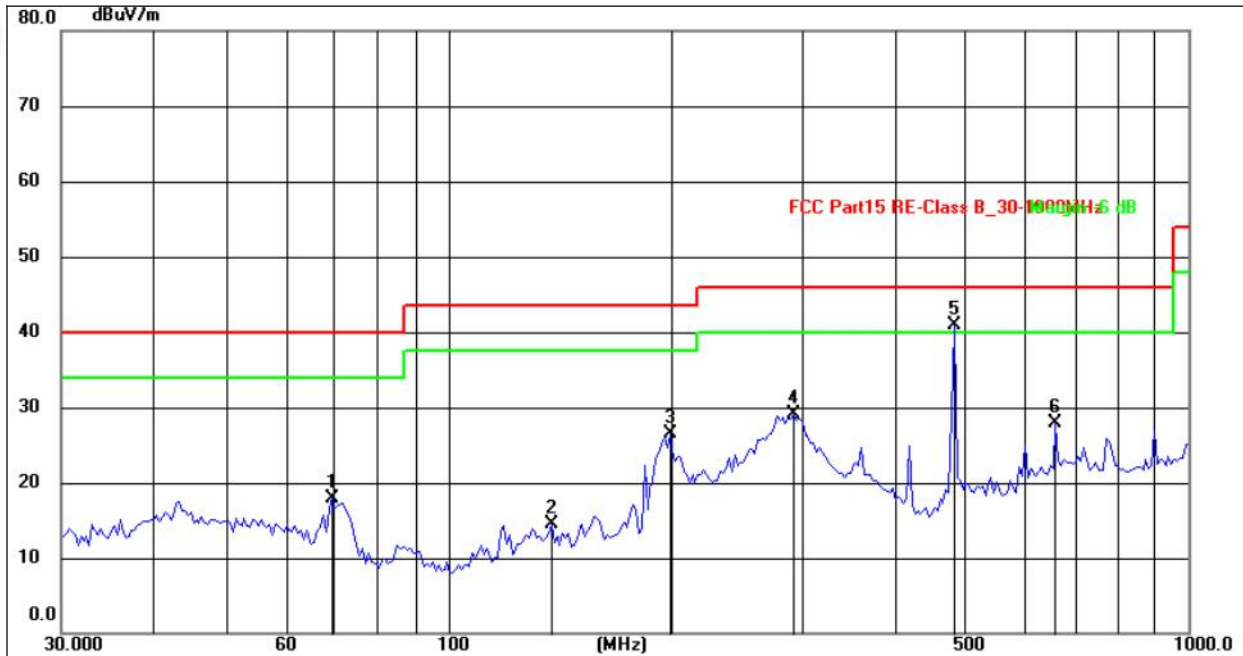

No.	Frequency (MHz)	Reading (dBuV)	Factor (dB/m)	Level (dBuV/m)	Limit (dBuV/m)	Margin (dB)	Detector
1	69.6004	34.79	-16.79	18.00	40.00	-22.00	QP
2	137.9028	31.63	-17.10	14.53	43.50	-28.97	QP
3	199.2855	45.35	-18.76	26.59	43.50	-16.91	QP
4	293.0842	45.18	-16.07	29.11	46.00	-16.89	QP
5	483.0617	53.37	-12.45	40.92	46.00	-5.08	QP
6	662.3106	35.41	-7.49	27.92	46.00	-18.08	QP



Temperature:	26°C	Relative Humidity:	54%
Pressure:	101kPa	Polarization:	Vertical
Test Voltage:	AC 120V/60Hz	Mode:	TX ASK 125KHz

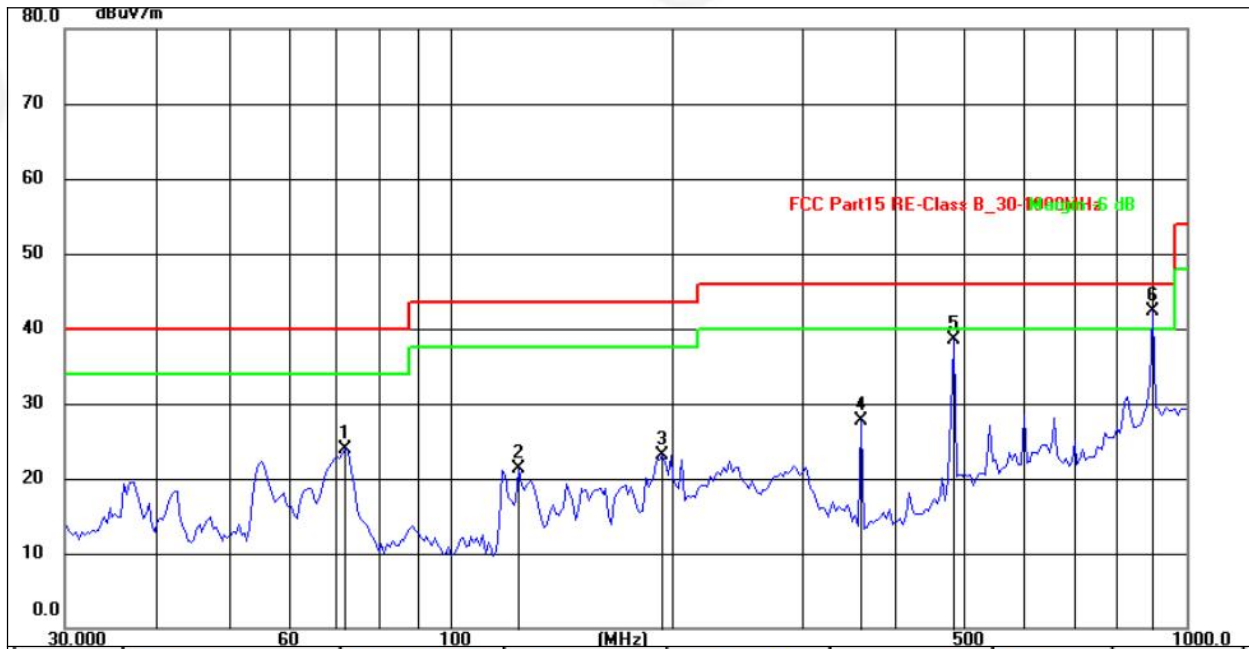

No.	Frequency (MHz)	Reading (dBUV)	Factor (dB/m)	Level (dBUV/m)	Limit (dBUV/m)	Margin (dB)	Detector
1	72.0843	43.83	-19.87	23.96	40.00	-16.04	QP
2	124.1329	42.55	-21.28	21.27	43.50	-22.23	QP
3	194.1128	43.51	-20.45	23.06	43.50	-20.44	QP
4	361.7138	43.92	-16.30	27.62	46.00	-18.38	QP
5	483.0617	50.67	-12.15	38.52	46.00	-7.48	QP
6	900.1474	42.97	-0.74	42.23	46.00	-3.77	QP

Remarks:

- 1.Final Level =Receiver Read level + Antenna Factor + Cable Loss – Pre-amplifier Factor
- 2.The emission levels of other frequencies are very lower than the limit and not show in test report.



5. CHANNEL BANDWIDTH

Test Requirement:	FCC Part15 C Section 15.215
Test Method:	ANSI C63.10: 2013

6.1 APPLIED PROCEDURES / LIMIT

Intentional radiators operating under the alternative provisions to the general emission limits, as contained in §§15.217 through 15.257 and in subpart E of this part, must be designed to ensure that 20dB bandwidth of the emission, or whatever bandwidth may otherwise be specified in the specific rule section under which the equip compliance with the 20dB attenuation specification may base on measurement at the intentional radiator's antenna output terminal unless the intentional radiator uses a permanently attached antenna, in which case compliance shall be demonstrated by measuring the radiated emissions.

6.2 TEST PROCEDURE

1. Set RBW = 200 Hz.
2. Set the video bandwidth (VBW) \geq RBW.
3. Detector = Peak.
4. Trace mode = max hold.
5. Sweep = auto couple.
6. Allow the trace to stabilize.
7. Measure the maximum width of the emission that is constrained by the frequencies associated with the two outermost amplitude points (upper and lower frequencies) that are attenuated by 20 dB relative to the maximum level measured in the fundamental emission.

6.3 DEVIATION FROM STANDARD

No deviation.

6.4 TEST SETUP



6.5 EUT OPERATION CONDITIONS

The EUT tested system was configured as the statements of 2.4 Unless otherwise a special operating condition is specified in the follows during the testing.



6.6 TEST RESULT

Temperature :	26°C	Relative Humidity :	54%
Test Mode :	ASK	Test Voltage :	AC 120V/60Hz

Test channel	20dB Channel Bandwidth (KHz)	Result
1	4.012	Pass

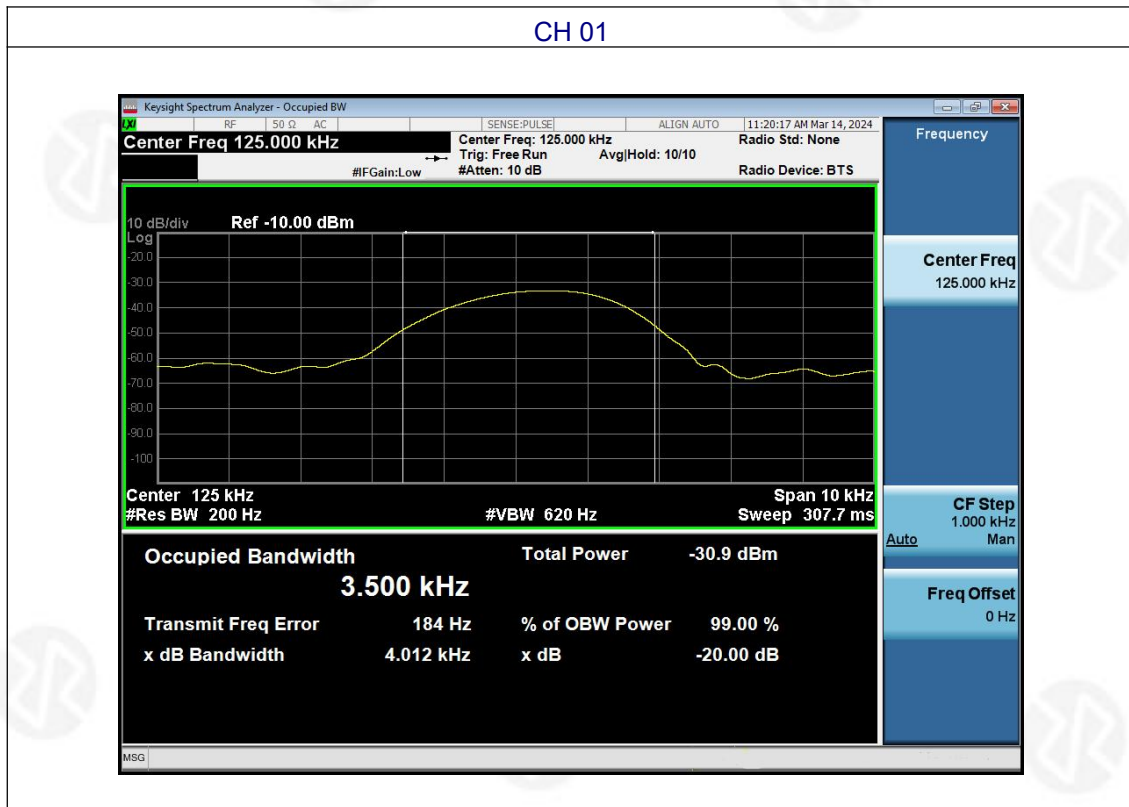



7.ANTENNA REQUIREMENT

Standard requirement:	FCC Part15 C Section 15.203
15.203 requirement: An intentional radiator shall be designed to ensure that no antenna other than that furnished by the responsible party shall be used with the device. The use of a permanently attached antenna or of an antenna that uses a unique coupling to the intentional radiator, the manufacturer may design the unit so that a broken antenna can be replaced by the user, but the use of a standard antenna jack or electrical connector is prohibited.	
EUT Antenna:	
The antennas is Spring Coil Antenna, the best case gain of the antennas is 0.50dBi, reference to the appendix II for details	



8. TEST SETUP PHOTO

Reference to the appendix I for details.

9. EUT CONSTRUCTIONAL DETAILS

Reference to the appendix II for details.

******* END OF REPORT *******