

TEST REPORT

Report No.: BCTC2212475002-1E

Applicant: LONGCONN ELECTRONICS (SHENZHEN) CO LTD

Product Name: Samba Pad Pro

Model/Type Ref.: W326

Tested Date: 2022-11-22 to 2022-12-05

Issued Date: 2022-12-21

Shenzhen BCTC Testing Co., Ltd.



FCC ID: 2AXAXW326

Product Name: Samba Pad Pro
Trademark: ZECHIN
Model/Type Ref.: W326
Prepared For: LONGCONN ELECTRONICS (SHENZHEN) CO LTD
Address: Floor 3,B1 Block ,Xu Jing Chang Industrial Park, NO.39 HaoyeRoad,FuhaiStreet, Bao'an, Shenzhen, China
Manufacturer: LONGCONN ELECTRONICS (SHENZHEN) CO LTD
Address: Floor 3,B1 Block ,Xu Jing Chang Industrial Park, NO.39 HaoyeRoad,FuhaiStreet, Bao'an, Shenzhen, China
Prepared By: Shenzhen BCTC Testing Co., Ltd.
Address: 1-2/F., Building B, Pengzhou Industrial Park, No.158, Fuyuan 1st Road, Tangwei, Fuhai Subdistrict, Bao'an District, Shenzhen, Guangdong, China
Sample Received Date: 2022-11-22
Sample tested Date: 2022-11-22 to 2022-12-05
Report No.: BCTC2212475002-1E
Test Standards: FCC Part15.209
ANSI C63.10-2013
Test Results: PASS

Tested by:

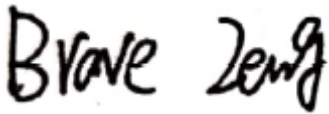

Brave Zeng/ Project Handler

Approved by:



Zero Zhou/Reviewer

The test report is effective only with both signature and specialized stamp. This result(s) shown in this report refer only to the sample(s) tested. Without written approval of Shenzhen BCTC Testing Co., Ltd, this report can't be reproduced except in full. The tested sample(s) and the sample information are provided by the client.

Table of Content

| Test Report Declaration | Page |
|---|------|
| 1. Version | 4 |
| 2. Test Summary | 5 |
| 3. Measurement Uncertainty | 6 |
| 4. Product Information and Test Setup | 7 |
| 4.1 Product Information | 7 |
| 4.2 Test Setup Configuration | 7 |
| 4.3 Support Equipment | 8 |
| 4.4 Test Mode | 8 |
| 5. Test Facility and Test Instrument Used | 9 |
| 5.1 Test Facility | 9 |
| 5.2 Test Instrument Used | 9 |
| 6. Conducted Emissions | 11 |
| 6.1 Block Diagram Of Test Setup | 11 |
| 6.2 Limit | 11 |
| 6.3 Test Procedure | 11 |
| 6.4 EUT Operating Conditions | 12 |
| 6.5 Test Result | 13 |
| 7. Radiated Emissions | 15 |
| 7.1 Block Diagram Of Test Setup | 15 |
| 7.2 Limit | 16 |
| 7.3 Test Procedure | 16 |
| 7.4 Test Result | 17 |
| 8. Bandwidth Test | 20 |
| 9. Antenna Requirements | 22 |
| 10. EUT Test Setup Photographs | 23 |

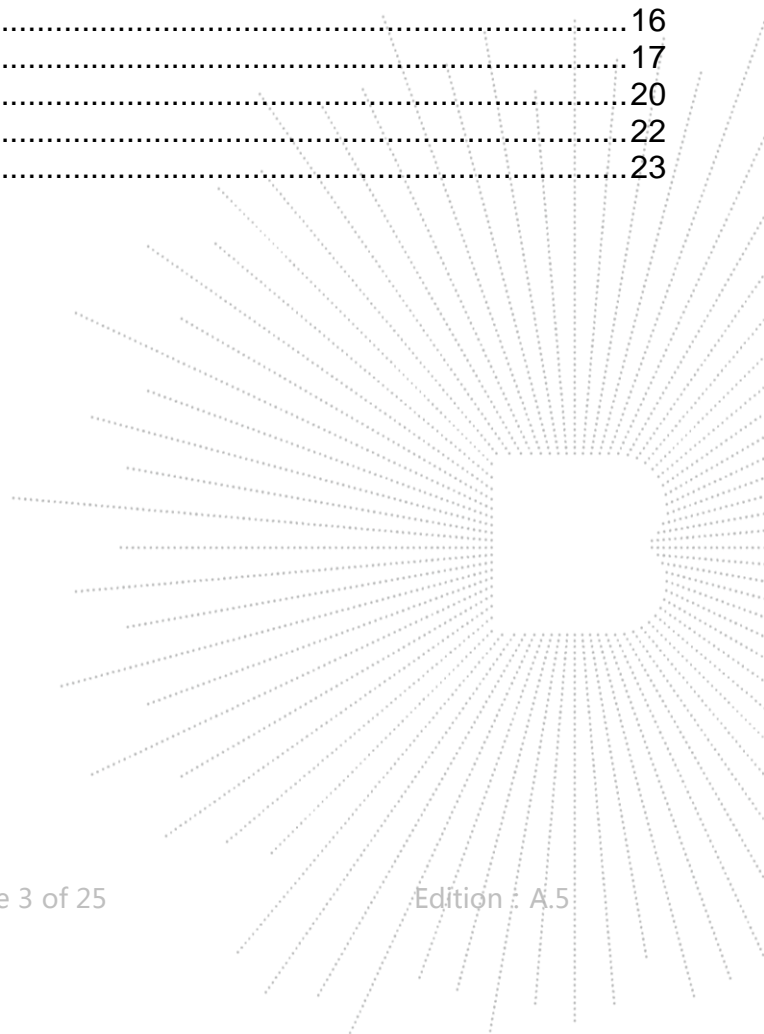

1. Version

| Report No. | Issue Date | Description | Approved |
|-------------------|-------------------|--------------------|-----------------|
| BCTC2212475002-1E | 2022-12-21 | Original | Valid |
| | | | |

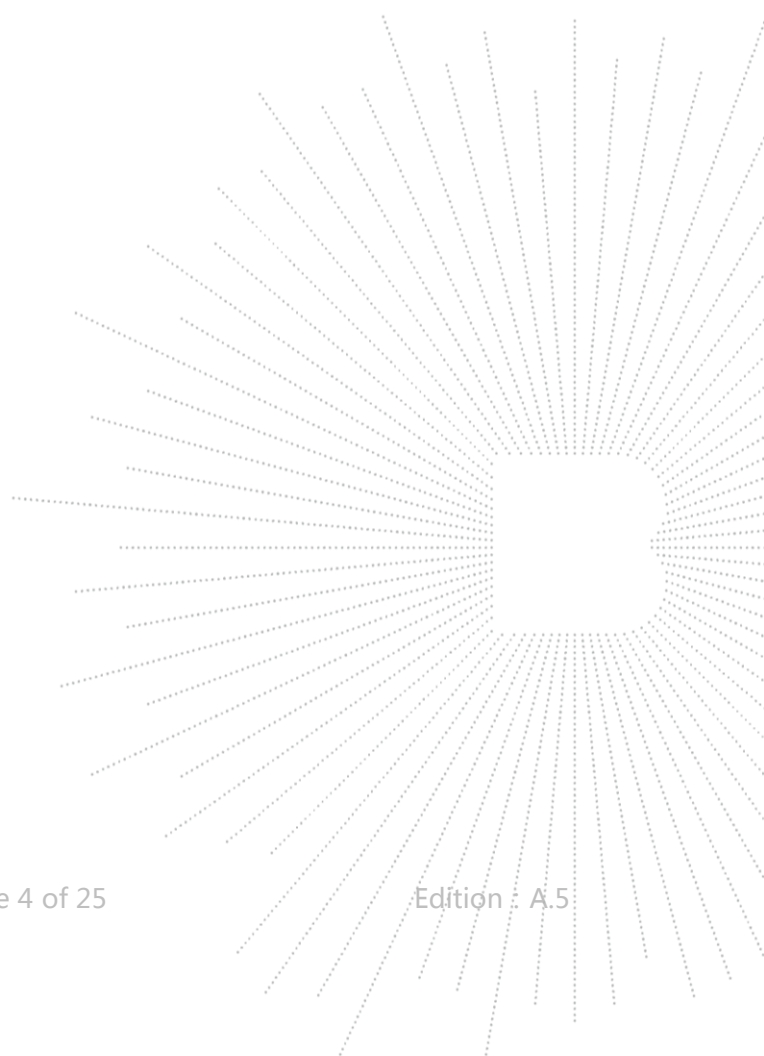

2. Test Summary

The Product has been tested according to the following specifications:

| No. | Test Parameter | Clause No | Results |
|-----|---------------------|-----------|---------|
| 1 | Conducted Emission | 15.207 | PASS |
| 2 | Radiated Emission | 15.209 | PASS |
| 3 | 20dB Bandwidth | 15.215 | PASS |
| 4 | Antenna Requirement | 15.203 | PASS |

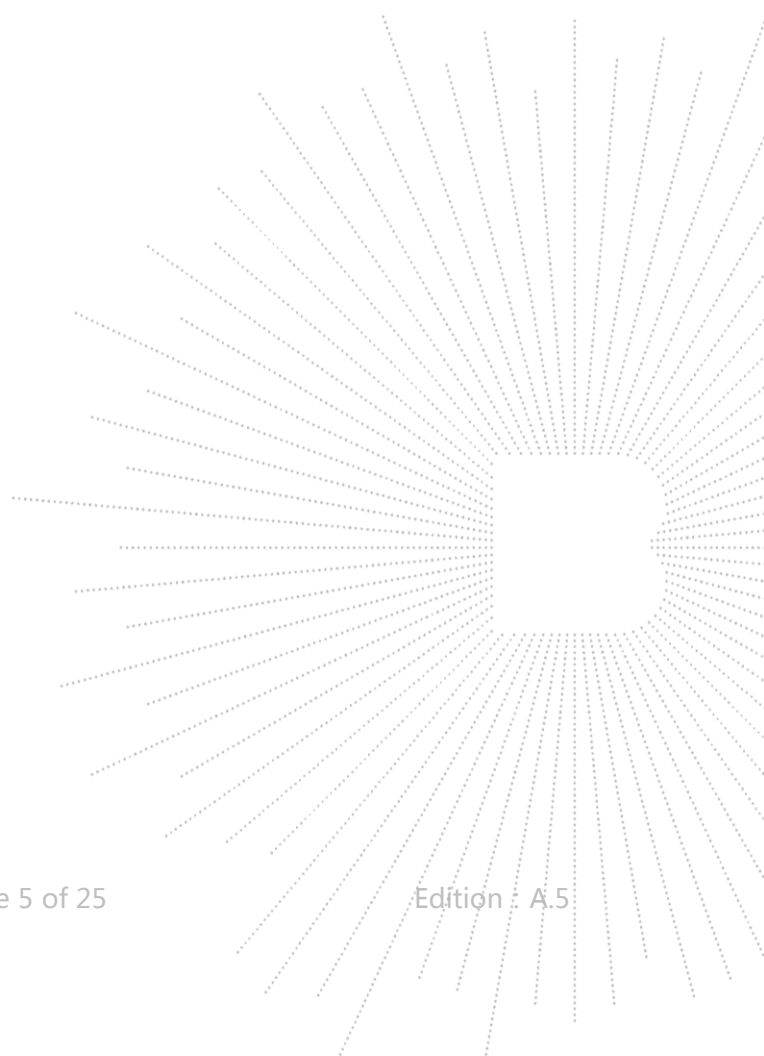

3. Measurement Uncertainty

Where relevant, the following measurement uncertainty levels have been estimated for tests performed on the Product as specified in CISPR 16-4-2. This uncertainty represents an expanded uncertainty expressed at approximately the 95% confidence level using a coverage factor of $k=2$.

| No. | Item | Uncertainty |
|-----|--|-------------|
| 1 | 3m chamber Radiated spurious emission(9kHz-30MHz) | U=3.7dB |
| 2 | 3m chamber Radiated spurious emission(30MHz-1GHz) | U=4.3dB |
| 3 | 3m chamber Radiated spurious emission(1GHz-18GHz) | U=4.5dB |
| 4 | 3m chamber Radiated spurious emission(18GHz-40GHz) | U=3.34dB |
| 5 | Conducted Emission(150kHz-30MHz) | U=3.20dB |
| 6 | Conducted Adjacent channel power | U=1.38dB |
| 7 | Conducted output power uncertainty Above 1G | U=1.576dB |
| 8 | Conducted output power uncertainty below 1G | U=1.28dB |
| 9 | humidity uncertainty | U=5.3% |
| 10 | Temperature uncertainty | U=0.59°C |

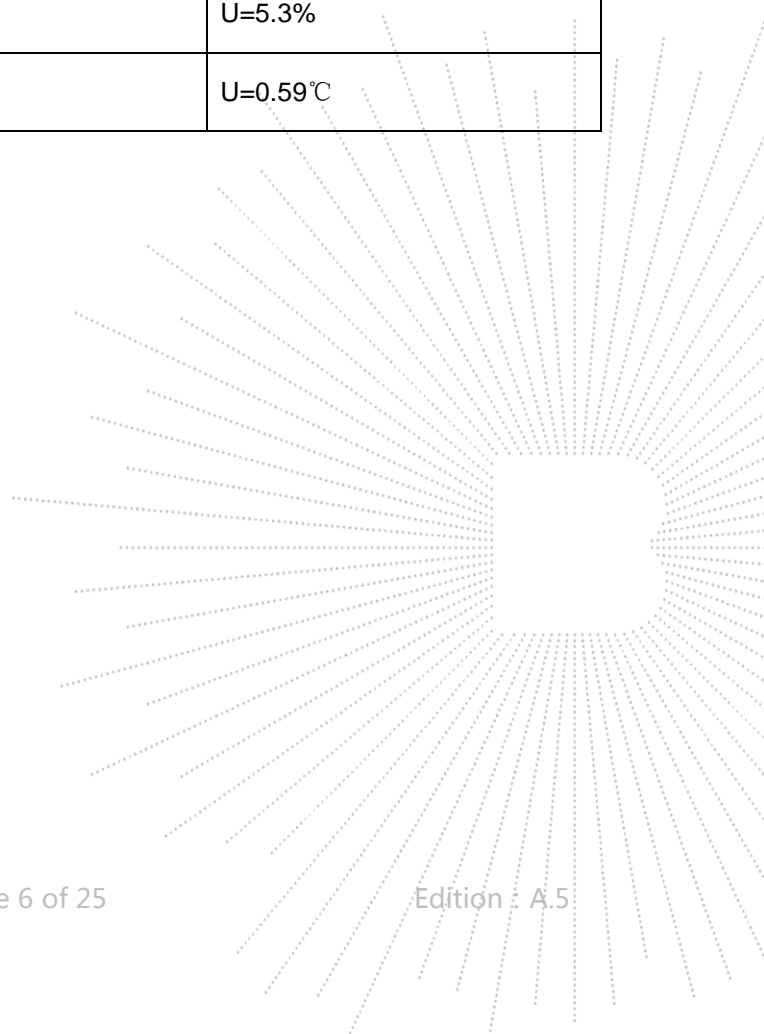

4. Product Information and Test Setup

4.1 Product Information

| | |
|-----------------------|--|
| Model/Type Ref.: | W326 |
| Model differences: | N/A |
| Product Description: | Multi-function wireless charger |
| Operation Frequency: | 112-205KHz |
| Antenna installation: | Loop coil antenna |
| Ratings: | Output: Phone:10W AirPods: 10W Watch: 2.5W |
| Hardware Version: | N/A |
| Software Version: | N/A |

4.2 Test Setup Configuration

See test photographs attached in EUT TEST SETUP Photographs for the actual connections between Product and support equipment.

Conducted Emission/Radiated Spurious Emission:

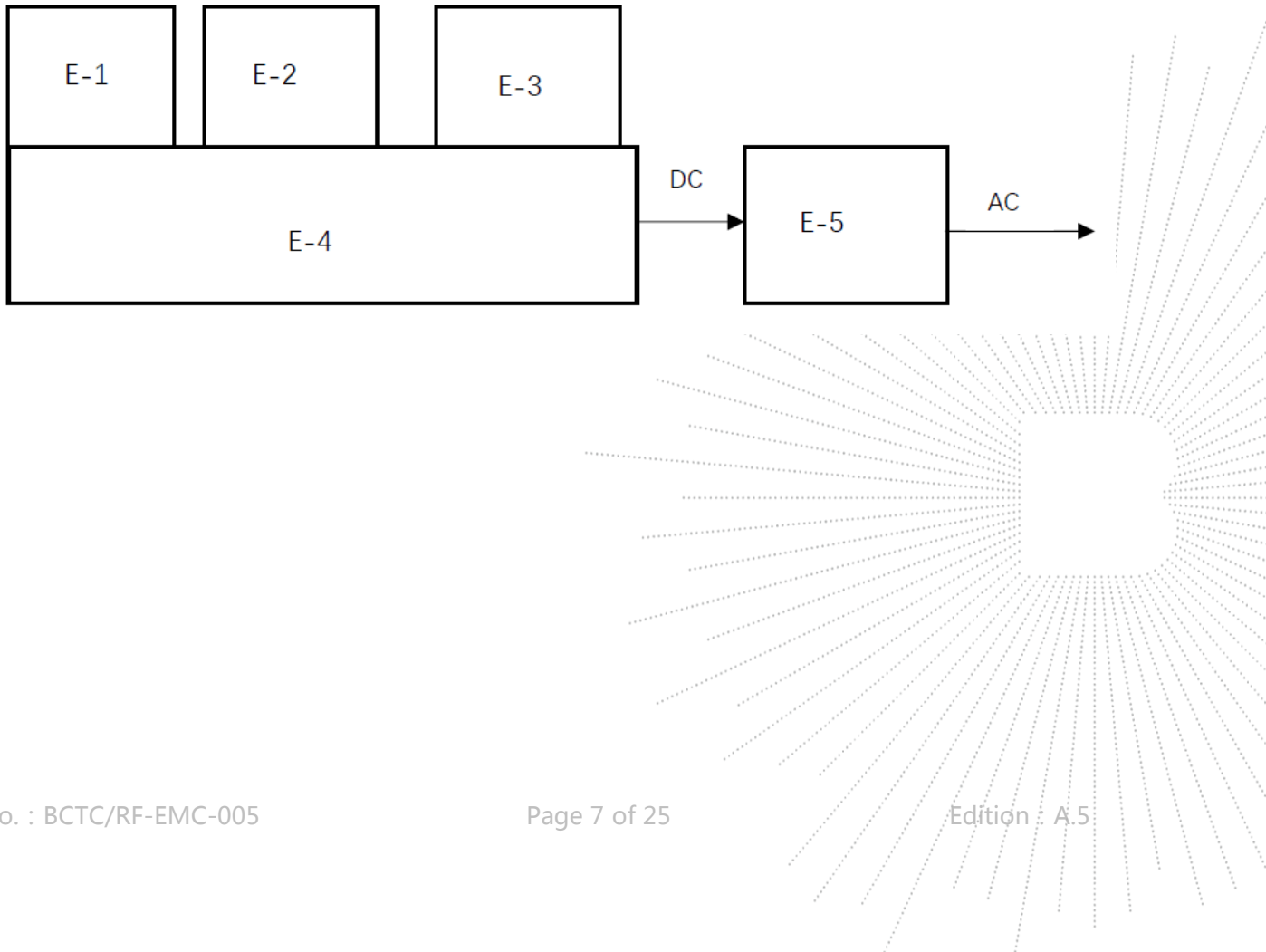

4.3 Support Equipment

| No. | Device Type | Brand | Model | Series No. | Note |
|-----|---------------------------------|--------|-------------|------------|-----------|
| E-1 | Dummy load | N/A | DL01 | N/A | Auxiliary |
| E-2 | Dummy load | N/A | DL02 | N/A | Auxiliary |
| E-3 | Earphone | N/A | AirPods pro | N/A | Auxiliary |
| E-4 | Multi-function wireless charger | Zechin | E6 | N/A | EUT |
| E-5 | Adapter | N/A | N/A | N/A | EUT |

Notes:

1. All the equipment/cables were placed in the worst-case configuration to maximize the emission during the test.
2. Grounding was established in accordance with the manufacturer's requirements and conditions for the intended use.

4.4 Test Mode

To investigate the maximum EMI emission characteristics generates from EUT, the test system was pre-scanning tested base on the consideration of following EUT operation mode or test configuration mode which possible have effect on EMI emission level. Each of these EUT operation mode(s) or test config

| | |
|--------------|---|
| Test Modes 1 | Phone: 10W |
| Test Modes 2 | AirPods: 10W |
| Test Modes 3 | Watch: 2.5W |
| Test Modes 4 | Phone:10W + AirPods: 10W |
| Test Modes 5 | Phone: 10W + Watch: 2.5W |
| Test Modes 6 | AirPods: 10W + Watch: 2.5W |
| Test Modes 7 | Phone: 10W + AirPods: 10W + Watch: 2.5W |

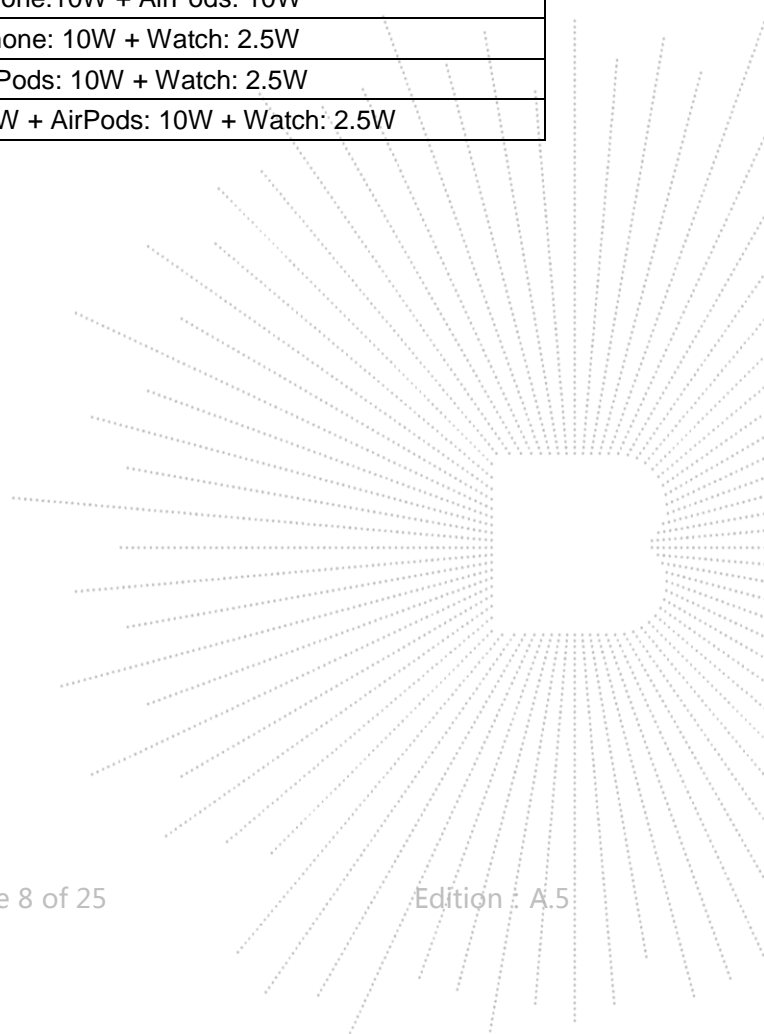

5. Test Facility and Test Instrument Used

5.1 Test Facility

All measurement facilities used to collect the measurement data are located at Shenzhen BCTC Testing Co., Ltd. Address: 1-2/F., Building B, Pengzhou Industrial Park, No.158, Fuyuan 1st Road, Tangwei, Fuhai Subdistrict, Bao'an District, Shenzhen, Guangdong, China. The site and apparatus are constructed in conformance with the requirements of ANSI C63.4 and CISPR 16-1-1 other equivalent standards. FCC Test Firm Registration Number: 712850
IC Registered No.: 23583

5.2 Test Instrument Used

| Conducted emissions Test | | | | | |
|--------------------------|--------------|-----------------|----------------|--------------|--------------|
| Equipment | Manufacturer | Model# | Serial# | Last Cal. | Next Cal. |
| Receiver | R&S | ESR3 | 102075 | May 24, 2022 | May 23, 2023 |
| LISN | R&S | ENV216 | 101375 | May 24, 2022 | May 23, 2023 |
| Software | Frad | EZ-EMC | EMC-CON 3A1 | \ | \ |
| Attenuator | \ | 10dB DC-6GHz | 1650 | May 24, 2022 | May 23, 2023 |

| RF Conducted Test | | | | | |
|------------------------------|--------------|--------|------------|--------------|--------------|
| Equipment | Manufacturer | Model# | Serial# | Last Cal. | Next Cal. |
| Power Metter | Keysight | E4419 | \ | May 24, 2022 | May 23, 2023 |
| Power Sensor (AV) | Keysight | E9300A | \ | May 24, 2022 | May 23, 2023 |
| Signal Analyzer20kHz-26.5GHz | Keysight | N9020A | MY49100060 | May 24, 2022 | May 23, 2023 |
| Spectrum Analyzer9kHz-40GHz | R&S | FSP40 | \ | May 24, 2022 | May 23, 2023 |

| Radiated Emissions Test (966 Chamber) | | | | | |
|---|--------------|----------------------|-------------------|---------------|---------------|
| Equipment | Manufacturer | Model# | Serial# | Last Cal. | Next Cal. |
| 966 chamber | ChengYu | 966 Room | 966 | Jun. 06. 2020 | Jun. 05, 2023 |
| Receiver | R&S | ESR3 | 102075 | May 24, 2022 | May 23, 2023 |
| Receiver | R&S | ESRP | 101154 | May 24, 2022 | May 23, 2023 |
| Amplifier | SKET | LAPA_01G18 G-45dB | \ | May 24, 2022 | May 23, 2023 |
| Amplifier | Schwarzbeck | BBV9744 | 9744-0037 | May 24, 2022 | May 23, 2023 |
| TRILOG Broadband Antenna | Schwarzbeck | VULB9163 | 942 | May 26, 2022 | May 25, 2023 |
| Horn Antenna | Schwarzbeck | BBHA9120D | 1541 | May 24, 2022 | May 23, 2023 |
| Horn Antenn (18GHz-40GHz) | Schwarzbeck | BBHA9170 | 00822 | Jun. 15, 2021 | May 23, 2023 |
| Amplifier (18GHz-40GHz) | MITEQ | TTA1840-35- HG | 2034381 | May 26, 2022 | May 25, 2023 |
| Loop Antenna (9kHz-30MHz) | Schwarzbeck | FMZB1519B | 00014 | May 26, 2022 | May 25, 2023 |
| RF cables1 (9kHz-30MHz) | Huber+Suhnar | 9kHz-30MHz | B1702988-000 8 | May 26, 2022 | May 25, 2023 |
| RF cables2 (30MHz-1GHz) | Huber+Suhnar | 30MHz-1GHz | 1486150 | May 26, 2022 | May 25, 2023 |
| RF cables3 (1GHz-40GHz) | Huber+Suhnar | 1GHz-40GHz | 1607106 | May 26, 2022 | May 25, 2023 |
| Power Metter | Keysight | E4419 | \ | May 26, 2022 | May 25, 2023 |
| Power Sensor (AV) | Keysight | E9300A | \ | May 26, 2022 | May 25, 2023 |
| Signal Analyzer 20kHz-26.5G Hz | Keysight | N9020A | MY49100060 | May 26, 2022 | May 25, 2023 |
| Spectrum Analyzer 9kHz-40GHz | R&S | FSP 40 | \ | May 26, 2022 | May 25, 2023 |
| Software | Frad | EZ-EMC | FA-03A2 RE | \ | \ |

6. Conducted Emissions

6.1 Block Diagram Of Test Setup



6.2 Limit

| FREQUENCY (MHz) | Limit (dBuV) | |
|-----------------|--------------|-----------|
| | Quas-peak | Average |
| 0.15 -0.5 | 66 - 56 * | 56 - 46 * |
| 0.50 -5.0 | 56.00 | 46.00 |
| 5.0 -30.0 | 60.00 | 50.00 |

Notes:
 1. *Decreasing linearly with logarithm of frequency.
 2. The lower limit shall apply at the transition frequencies.

6.3 Test Procedure

| Receiver Parameters | Setting |
|---------------------|----------|
| Attenuation | 10 dB |
| Start Frequency | 0.15 MHz |
| Stop Frequency | 30 MHz |
| IF Bandwidth | 9 kHz |

- The Product was placed on a nonconductive table 0.8 m above the horizontal ground reference plane, and 0.4 m from the vertical ground reference plane, and connected to the main through Line Impedance Stability Network (L.I.S.N).
- The RBW of the receiver was set at 9 kHz in 150 kHz ~ 30MHz with Peak and AVG detector in Max Hold mode. Run the receiver's pre-scan to record the maximum disturbance generated from Product in all power lines in the full band.
- For each frequency whose maximum record was higher or close to limit, measure its QP and AVG values and record.

6.4 EUT Operating Conditions

The EUT was configured for testing in a typical fashion (as a customer would normally use it). The EUT has been programmed to continuously transmit during test. This operating condition was tested and used to collect the included data.

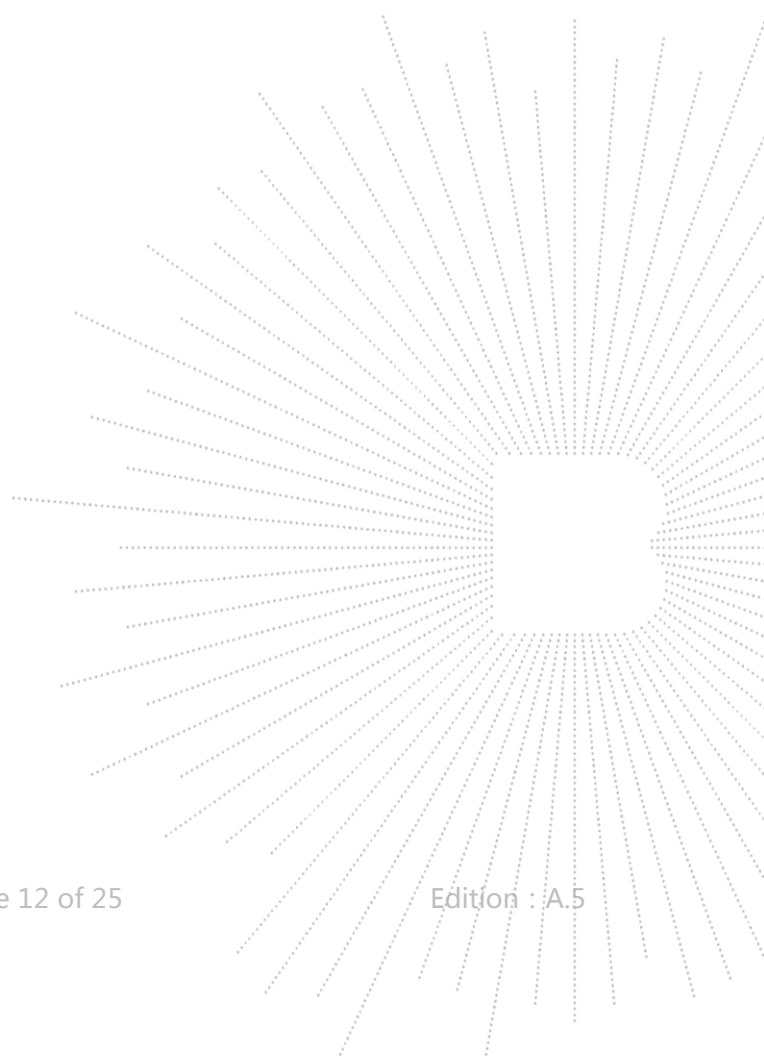

6.5 Test Result

| | | | |
|----------------|--------------|--------------------|--------|
| Temperature: | 26 °C | Relative Humidity: | 54% |
| Pressure: | 101kPa | Phase: | L |
| Test Voltage : | AC 120V/60Hz | Test Mode: | Mode 7 |

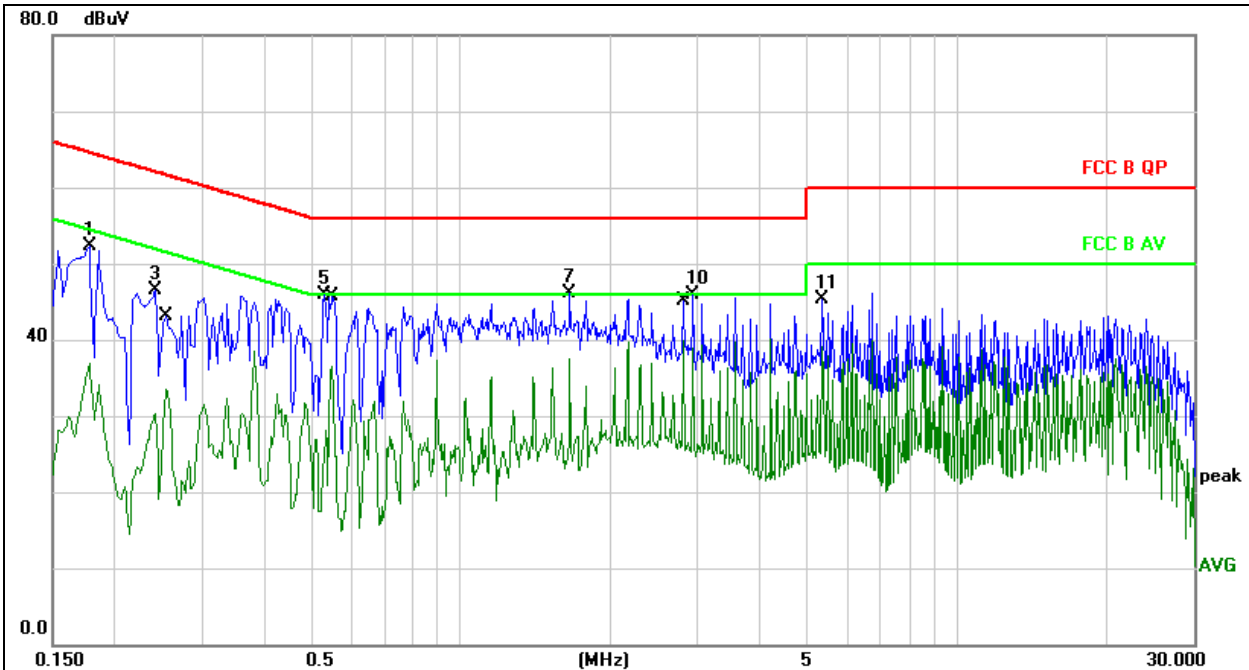

Remark:

1. All readings are Quasi-Peak and Average values.
2. Factor = Insertion Loss + Cable Loss.
3. Measurement=Reading Level+ Correct Factor
4. Over=Measurement-Limit

| No. Mk. | Freq. MHz | Reading Level dBuV | Correct Factor dB | Measure- ment dBuV | Limit dBuV | Over dB | Detector | Comment |
|---------|--------------|--------------------------|-------------------------|--------------------------|---------------|------------|----------|---------|
| 1 | 0.1819 | 38.44 | 9.99 | 48.43 | 64.39 | -15.96 | QP | |
| 2 | 0.1819 | 21.96 | 9.99 | 31.95 | 54.39 | -22.44 | AVG | |
| 3 | 0.6460 | 33.01 | 10.15 | 43.16 | 56.00 | -12.84 | QP | |
| 4 | 0.6460 | 25.93 | 10.15 | 36.08 | 46.00 | -9.92 | AVG | |
| 5 | 0.9060 | 34.24 | 10.12 | 44.36 | 56.00 | -11.64 | QP | |
| 6 | 0.9060 | 26.17 | 10.12 | 36.29 | 46.00 | -9.71 | AVG | |
| 7 | 1.6820 | 34.70 | 10.19 | 44.89 | 56.00 | -11.11 | QP | |
| 8 | 1.6820 | 27.39 | 10.19 | 37.58 | 46.00 | -8.42 | AVG | |
| 9 | 3.7500 | 35.95 | 10.57 | 46.52 | 56.00 | -9.48 | QP | |
| 10 * | 3.7500 | 29.34 | 10.57 | 39.91 | 46.00 | -6.09 | AVG | |
| 11 | 7.3700 | 36.35 | 10.84 | 47.19 | 60.00 | -12.81 | QP | |
| 12 | 7.3700 | 28.48 | 10.84 | 39.32 | 50.00 | -10.68 | AVG | |

| | | | |
|----------------|--------------|--------------------|--------|
| Temperature: | 26 °C | Relative Humidity: | 54% |
| Pressure: | 101kPa | Phase: | N |
| Test Voltage : | AC 120V/60Hz | Test Mode: | Mode 7 |

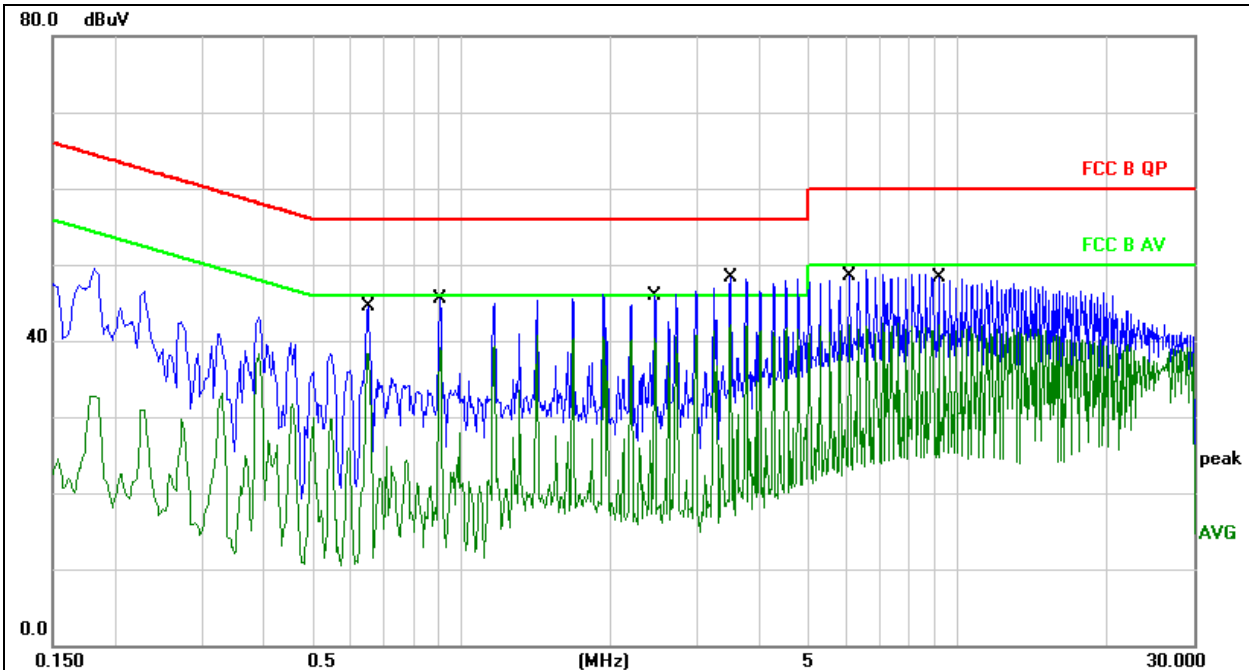
Remark:

1. All readings are Quasi-Peak and Average values.
2. Factor = Insertion Loss + Cable Loss.
3. Measurement=Reading Level+ Correct Factor
4. Over=Measurement-Limit

| No. Mk. | Freq. MHz | Reading Level dBuV | Correct Factor dB | Measure- ment dBuV | Limit dBuV | Over dB | Detector | Comment |
|---------|--------------|--------------------------|-------------------------|--------------------------|---------------|------------|----------|---------|
| 1 | 0.6460 | 34.28 | 10.15 | 44.43 | 56.00 | -11.57 | QP | |
| 2 | 0.6460 | 28.24 | 10.15 | 38.39 | 46.00 | -7.61 | AVG | |
| 3 | 0.9060 | 35.35 | 10.12 | 45.47 | 56.00 | -10.53 | QP | |
| 4 | 0.9060 | 28.91 | 10.12 | 39.03 | 46.00 | -6.97 | AVG | |
| 5 | 2.4539 | 35.65 | 10.32 | 45.97 | 56.00 | -10.03 | QP | |
| 6 | 2.4539 | 29.88 | 10.32 | 40.20 | 46.00 | -5.80 | AVG | |
| 7 | 3.4940 | 37.76 | 10.52 | 48.28 | 56.00 | -7.72 | QP | |
| 8 * | 3.4940 | 31.62 | 10.52 | 42.14 | 46.00 | -3.86 | AVG | |
| 9 | 6.0658 | 37.76 | 10.76 | 48.52 | 60.00 | -11.48 | QP | |
| 10 | 6.0658 | 31.40 | 10.76 | 42.16 | 50.00 | -7.84 | AVG | |
| 11 | 9.1618 | 37.50 | 10.90 | 48.40 | 60.00 | -11.60 | QP | |
| 12 | 9.1618 | 31.16 | 10.90 | 42.06 | 50.00 | -7.94 | AVG | |

Note: The worst Mode is Mode 7.

7. Radiated Emissions

7.1 Block Diagram Of Test Setup

(A) Radiated Emission Test-Up Frequency Below 30MHz

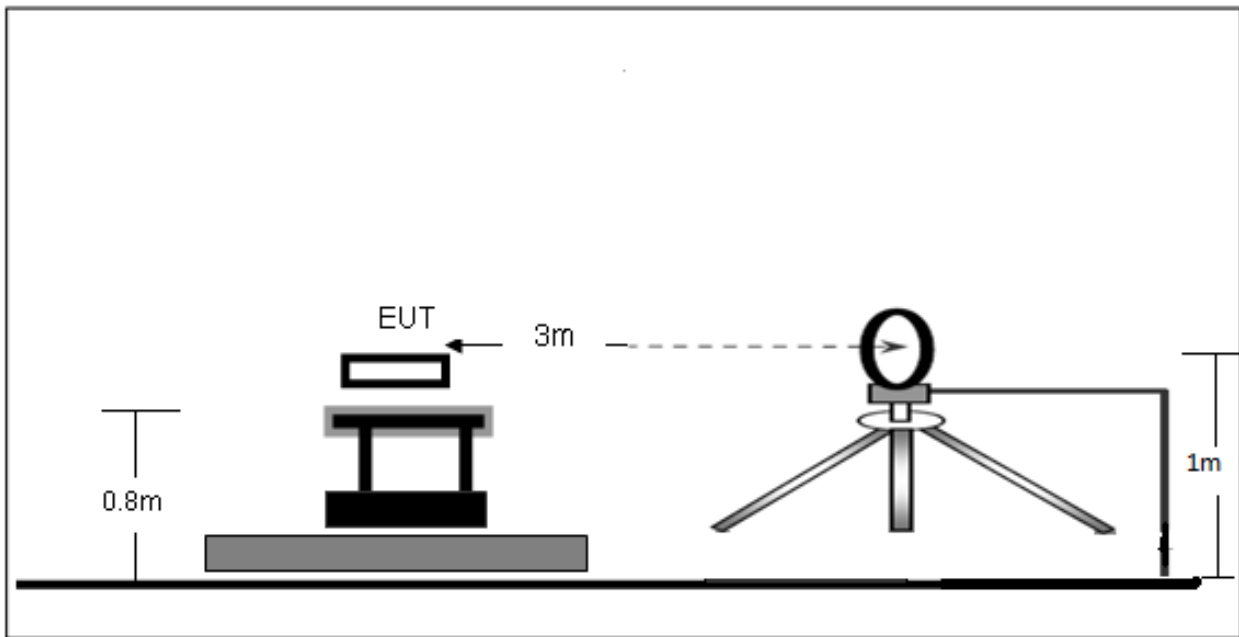

(B) Radiated Emission Test-Up Frequency 30MHz~1GHz

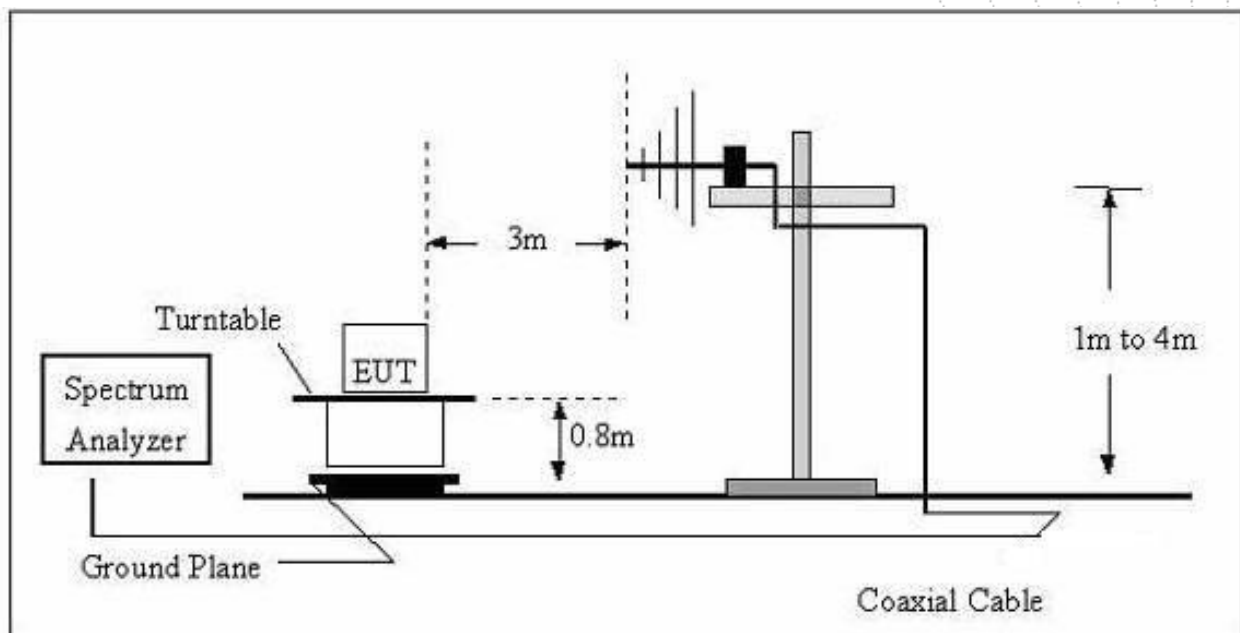

7.2 Limit

FCC §15.209; §15.205.

| Frequency (MHz) | Field Strength uV/m | Distance (m) | Field Strength Limit at 3m Distance | |
|--------------------|------------------------|-----------------|-------------------------------------|--------------------------------|
| | | | uV/m | dBuV/m |
| 0.009 ~ 0.490 | 2400/F(kHz) | 300 | 10000 * 2400/F(kHz) | $20\log^{(2400/F(kHz))} + 80$ |
| 0.490 ~ 1.705 | 24000/F(kHz) | 30 | 100 * 24000/F(kHz) | $20\log^{(24000/F(kHz))} + 40$ |
| 1.705 ~ 30 | 30 | 30 | 100 * 30 | $20\log^{(30)} + 40$ |
| 30 ~ 88 | 100 | 3 | 100 | $20\log^{(100)}$ |
| 88 ~ 216 | 150 | 3 | 150 | $20\log^{(150)}$ |
| 216 ~ 960 | 200 | 3 | 200 | $20\log^{(200)}$ |
| Above 960 | 500 | 3 | 500 | $20\log^{(500)}$ |

7.3 Test Procedure

| Receiver Parameter | Setting |
|--------------------|-------------------|
| Attenuation | Auto |
| 9kHz~150kHz | RBW 200Hz for QP |
| 150kHz~30MHz | RBW 9kHz for QP |
| 30MHz~1000MHz | RBW 120kHz for QP |

Below 1GHz test procedure as below:

- a. The EUT was placed on the top of a rotating table 0.8 meters above the ground at a 3 meter semi-anechoic chamber. The table was rotated 360 degrees to determine the position of the highest radiation.
- b. The EUT was set 3 meters away from the interference-receiving antenna, which was mounted on the top of a variable-height antenna tower.
- c. The antenna height is varied from one meter to four meters above the ground to determine the maximum value of the field strength. Both horizontal and vertical polarizations of the antenna are set to make the measurement.
- d. For each suspected emission, the EUT was arranged to its worst case and then the antenna was tuned to heights from 1 meter to 4 meters (for the test frequency of below 30MHz, the antenna was tuned to heights 1 meter) and the rotatable table was turned from 0 degrees to 360 degrees to find the maximum reading.
- e. The test-receiver system was set to Peak Detect Function and Specified Bandwidth with Maximum Hold Mode.
- f. If the emission level of the EUT in peak mode was 10dB lower than the limit specified, then testing could be stopped and the peak values of the EUT would be reported. Otherwise the emissions that did not have 10dB margin would be re-tested one by one using peak, quasi-peak or average method as specified and then reported in a data sheet.
- g. Different between above is the test site, change from Semi- Anechoic Chamber to fully Anechoic Chamber and change form table 0.8 metre to 1.5 metre(Above 18GHz the distance is 1 meter and table is 1.5 metre).
- h. Test the EUT in the lowest channel ,the middle channel ,the Highest channel.

7.4 Test Result

Below 30MHz

| | | | |
|--------------|---------|--------------------|--------------|
| Temperature: | 26°C | Relative Humidity: | 54% |
| Pressure: | 101 kpa | Test Voltage : | AC 120V/60Hz |
| Test Mode : | Mode 7 | Polarization: | / |

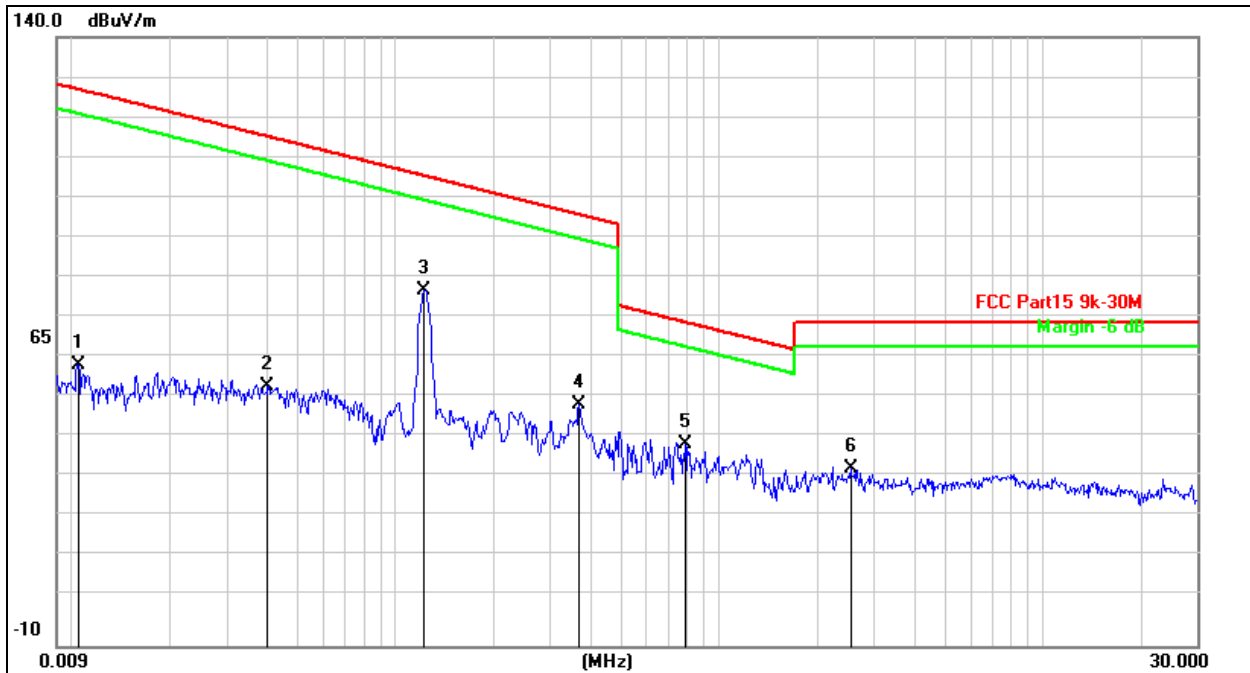

Remark:

1. Factor = Antenna Factor + Cable Loss – Pre-amplifier.
2. Measurement=Reading Level+ Correct Factor
3. Over=Measurement-Limit

| No. | Mk. | Freq. MHz | Reading Level dBuV | Correct Factor dB | Measure- ment dBuV/m | Limit dB/m | Over dB | Detector |
|-----|-----|--------------|--------------------------|-------------------------|----------------------------|---------------|------------|----------|
| 1 | | 0.0105 | 69.70 | -10.37 | 59.33 | 127.1 | -67.85 | QP |
| 2 | | 0.0403 | 64.64 | -10.68 | 53.96 | 115.5 | -61.54 | QP |
| 3 | * | 0.1226 | 87.75 | -10.13 | 77.62 | 105.8 | -28.21 | QP |
| 4 | | 0.3694 | 59.61 | -10.27 | 49.34 | 96.25 | -46.91 | QP |
| 5 | | 0.7859 | 50.00 | -10.25 | 39.75 | 69.71 | -29.96 | QP |
| 6 | | 2.5478 | 43.61 | -10.08 | 33.53 | 69.54 | -36.01 | QP |

Note: The worst Mode is Mode 7.

Between 30MHz – 1GHz

| | | | |
|--------------|---------|--------------------|--------------|
| Temperature: | 26°C | Relative Humidity: | 54% |
| Pressure: | 101 kPa | Test Voltage: | AC 120V/60Hz |
| Test Mode: | Mode 7 | Polarization: | Horizontal |

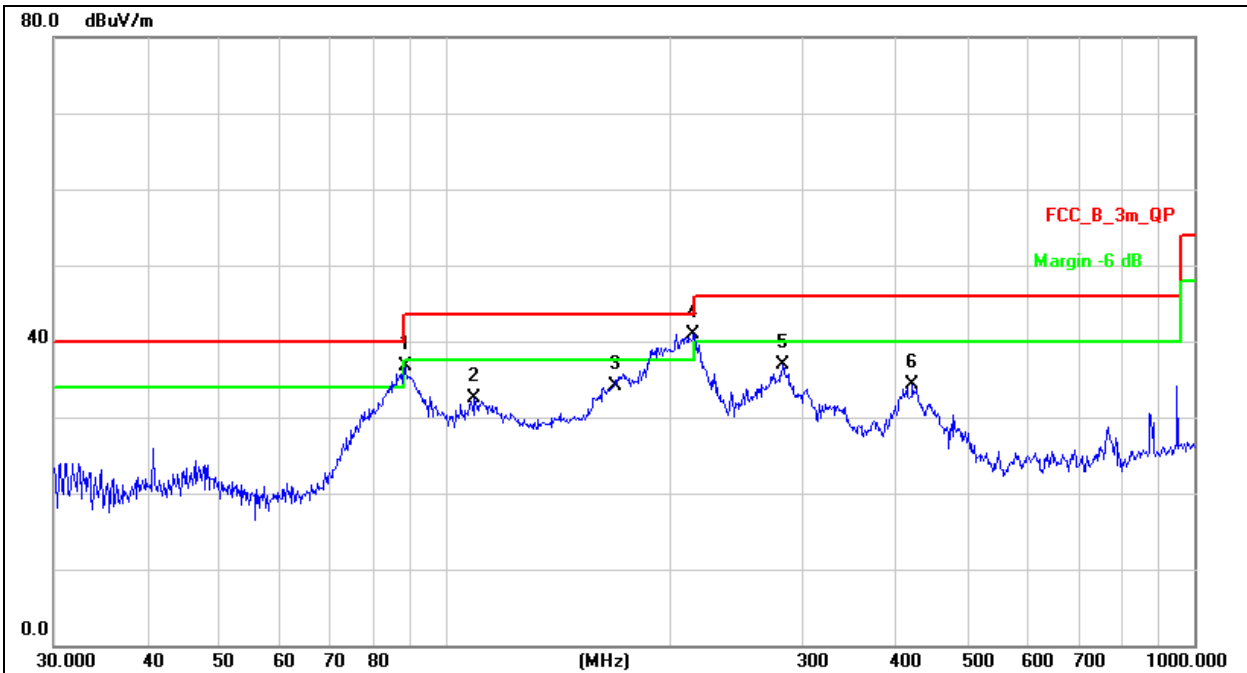

Remark:

- Factor = Antenna Factor + Cable Loss – Pre-amplifier.
- Measurement=Reading Level+ Correct Factor
- Over=Measurement-Limit

| No. | Mk. | Freq. MHz | Reading Level dBuV | Correct Factor dB/m | Measure- ment dBuV/m | Limit dBuV/m | Over dB | Detector |
|-----|-----|--------------|--------------------------|---------------------------|----------------------------|-----------------|------------|----------|
| 1 | | 88.3421 | 48.20 | -11.50 | 36.70 | 43.50 | -6.80 | QP |
| 2 | | 109.4116 | 41.55 | -9.13 | 32.42 | 43.50 | -11.08 | QP |
| 3 | | 167.8243 | 41.11 | -6.91 | 34.20 | 43.50 | -9.30 | QP |
| 4 | * | 214.5143 | 49.77 | -8.77 | 41.00 | 43.50 | -2.50 | QP |
| 5 | | 281.9946 | 43.27 | -6.27 | 37.00 | 46.00 | -9.00 | QP |
| 6 | | 420.5803 | 36.59 | -2.29 | 34.30 | 46.00 | -11.70 | QP |

| | | | |
|--------------|---------|--------------------|--------------|
| Temperature: | 26°C | Relative Humidity: | 54% |
| Pressure: | 101 kpa | Test Voltage : | AC 120V/60Hz |
| Test Mode: | Mode 7 | Polarization: | Vertical |

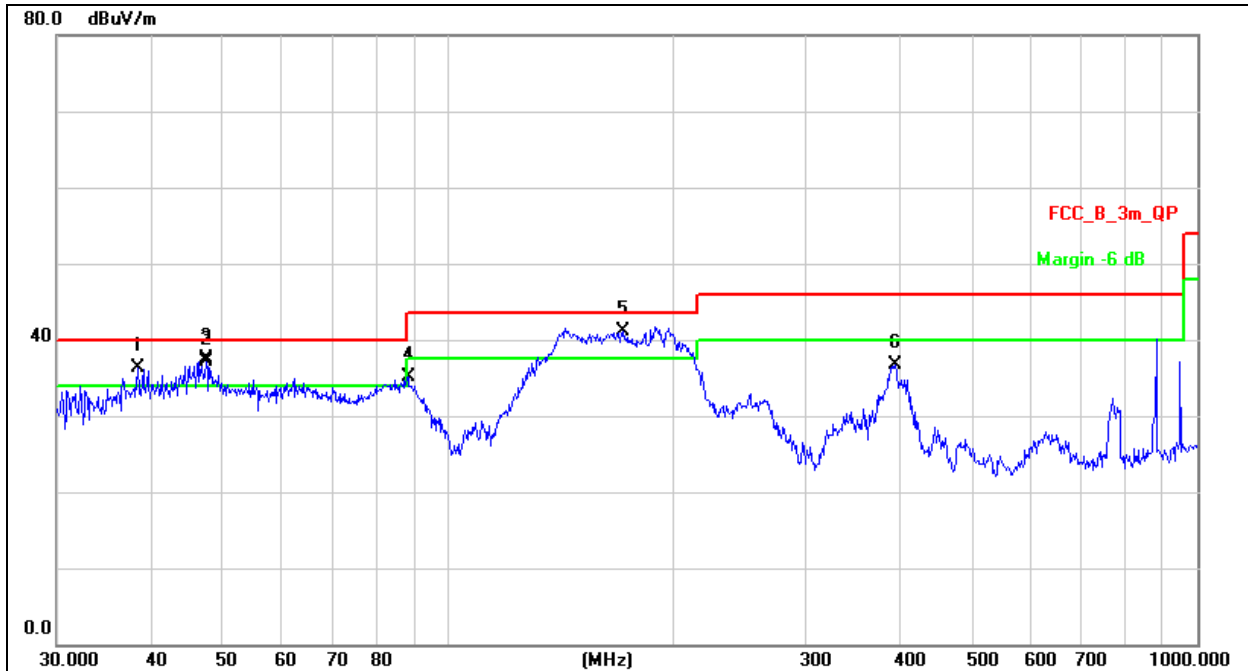
Remark:

1. Factor = Antenna Factor + Cable Loss – Pre-amplifier.
2. Measurement=Reading Level+ Correct Factor
3. Over=Measurement-Limit

| No. | Mk. | Freq. | Reading Level | Correct Factor | Measurement | Limit | Over | Detector |
|-----|-----|----------|---------------|----------------|-------------|--------|-------|----------|
| | | MHz | dBuV | dB/m | dBuV/m | dBuV/m | dB | |
| 1 | ! | 38.4808 | 44.68 | -8.39 | 36.29 | 40.00 | -3.71 | QP |
| 2 | ! | 47.4917 | 45.97 | -8.89 | 37.08 | 40.00 | -2.92 | QP |
| 3 | * | 47.4917 | 46.47 | -8.89 | 37.58 | 40.00 | -2.42 | QP |
| 4 | | 88.3421 | 46.61 | -11.50 | 35.11 | 43.50 | -8.39 | QP |
| 5 | ! | 171.3925 | 48.23 | -7.18 | 41.05 | 43.50 | -2.45 | QP |
| 6 | | 394.8543 | 39.79 | -3.13 | 36.66 | 46.00 | -9.34 | QP |

Note: The worst Mode is Mode 7.

8. Bandwidth Test

1. Set RBW = 1%~5% OBW.
2. Set the video bandwidth (VBW) $\geq 3 \times$ RBW.
3. Detector = Peak.
4. Trace mode = max hold.
5. Sweep = auto couple.
6. Allow the trace to stabilize.
7. Measure the maximum width of the emission that is constrained by the frequencies associated with the two outermost amplitude points (upper and lower frequencies) that are attenuated by 20 dB relative to the maximum level measured in the fundamental emission.

TEST SETUP

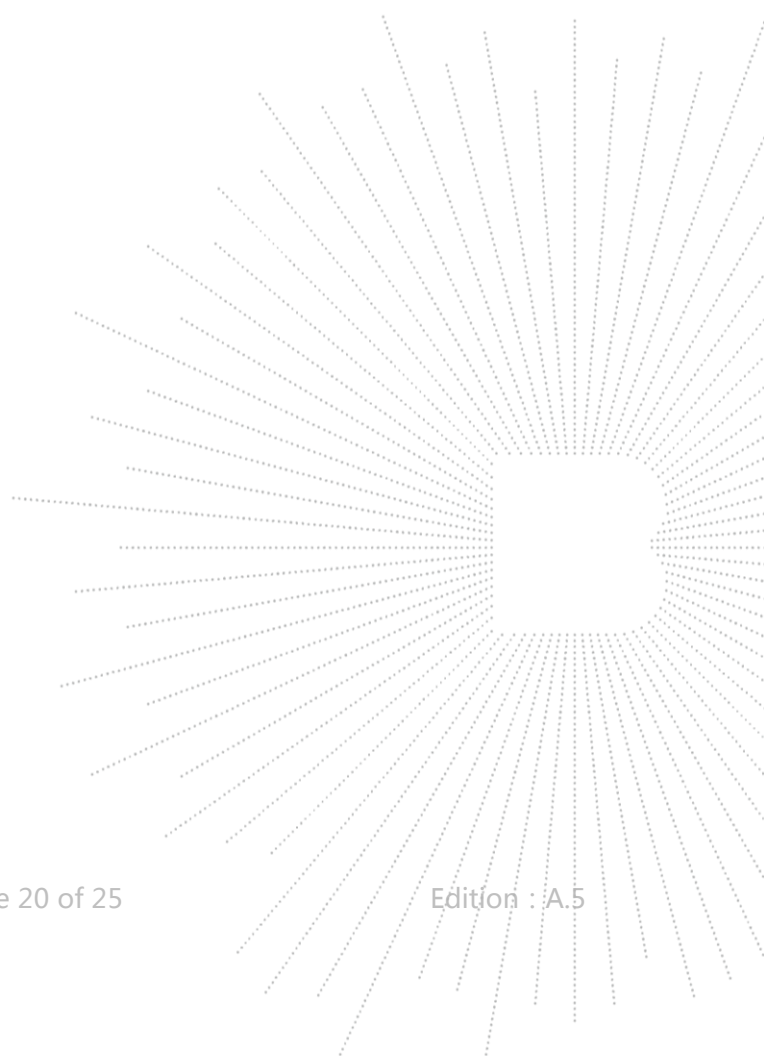

| | | | |
|--------------|--------|--------------------|-----|
| Temperature: | 26 °C | Relative Humidity: | 54% |
| Pressure: | 101kPa | | |

| Frequency (KHz) | 20dB bandwidth (KHz) | Result |
|-----------------|----------------------|--------|
| 129 | 0.925 | Pass |



9. Antenna Requirements

For intentional device, according to FCC 47 CFR Section 15.203, An intentional radiator shall be designed to ensure that no antenna other than that furnished by the responsible party shall be used with the device. The use of a permanently attached antenna or of an antenna that uses a unique coupling to the intentional radiator shall be considered sufficient to comply with the provisions of this section. The manufacturer may design the unit so that a broken antenna can be replaced by the user, but the use of a standard antenna jack or electrical connector is prohibited. The antenna used for this product is Inductive loop coil antenna.

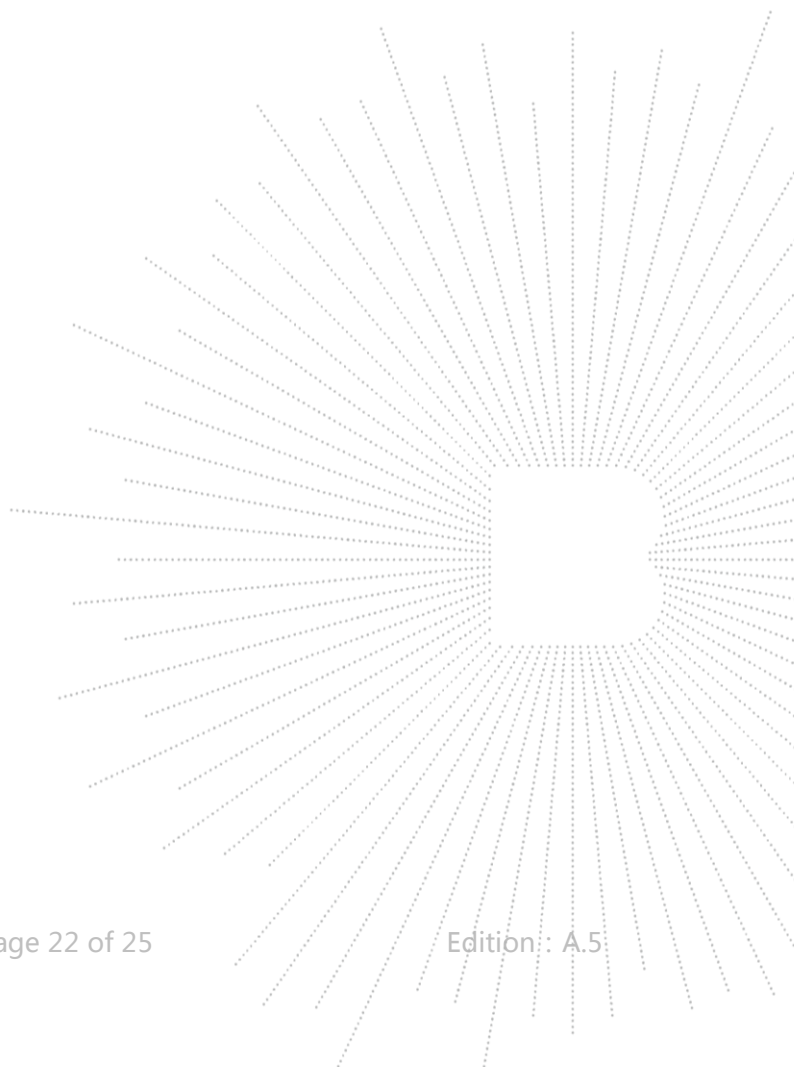

10. EUT Test Setup Photographs

Conducted emissions



Radiated Measurement Photos



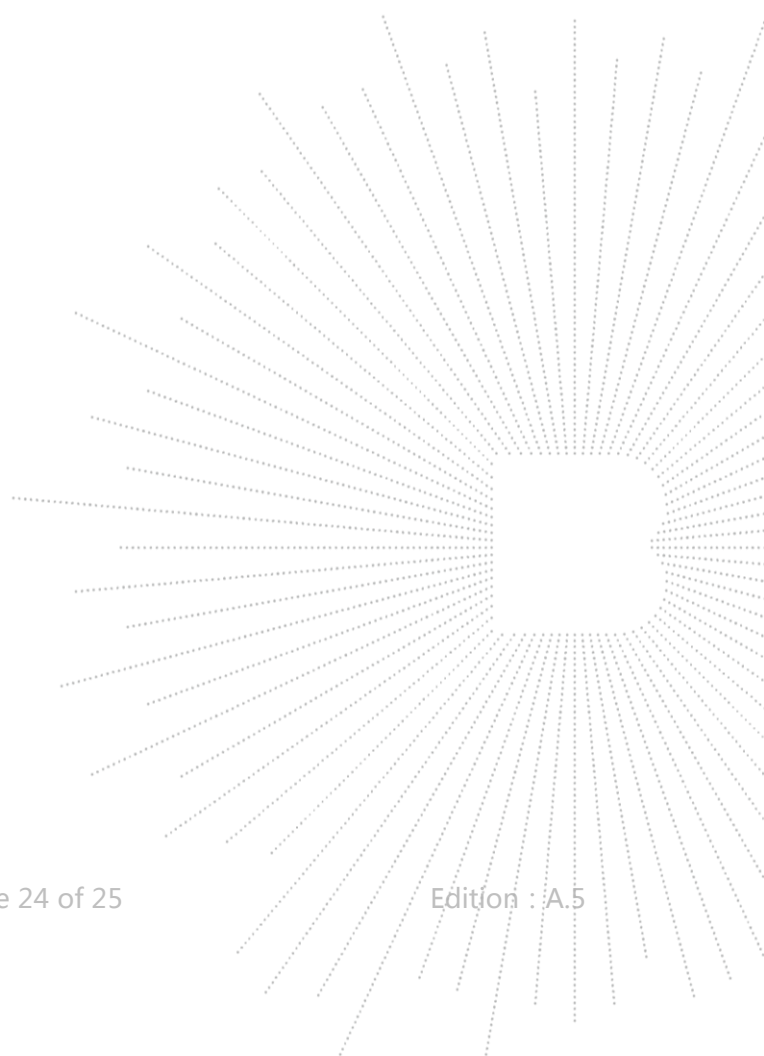
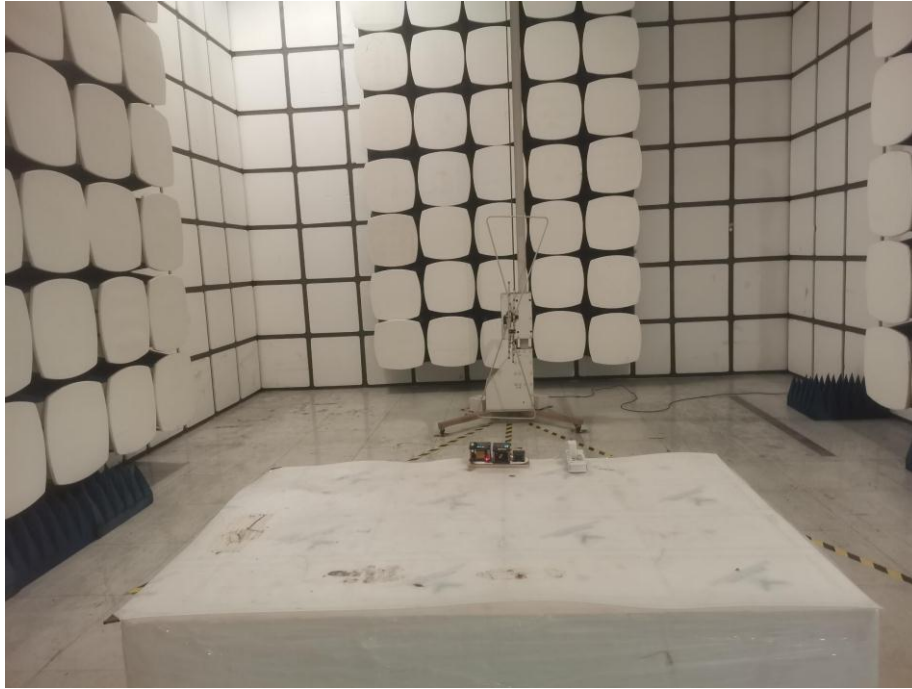

STATEMENT

- 1.The equipment lists are traceable to the national reference standards.
- 2.The test report can not be partially copied unless prior written approval is issued from our lab.
- 3.The test report is invalid without stamp of laboratory.
- 4.The test report is invalid without signature of person(s) testing and authorizing.
- 5.The test process and test result is only related to the Unit Under Test.
- 6.The quality system of our laboratory is in accordance with ISO/IEC17025.
- 7.If there is any objection to report, the client should inform issuing laboratory within 15 days from the date of receiving test report.

Address:

1-2/F., Building B, Pengzhou Industrial Park, No.158, Fuyuan 1st Road, Tangwei, Fuhai Subdistrict, Bao'an District, Shenzhen, Guangdong, China

TEL:400-788-9558

P.C.: 518103

FAX:0755-33229357

Website:<http://www.chnbctc.com>

E-Mail:bctc@bctc-lab.com.cn

***** END *****

