

FCC TEST REPORT

Report No. : NTC-ER2009024
Applicant's name : Shenzhen CWCE Lighting Technology Co.,Ltd.
Address : A/area, 9F/Bldg,Cuijing Rd 28, Longtian Town,Pingshan
New District,SHENZHEN Guangdong China 518122

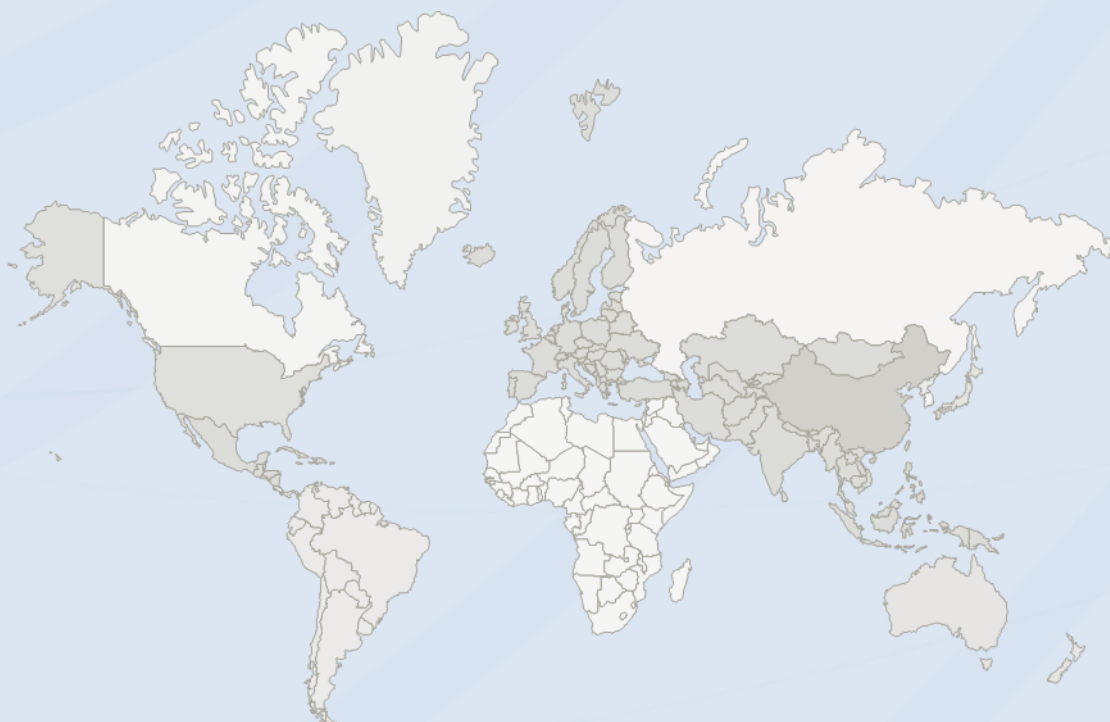

Tested Laboratory:
DONGGUAN NEW TESTING CENTRE CO., LTD

ⓄAddress: 3F, No. 1 the 1st North Industry Road, Songshan Lake Science & Technology Park, Dongguan, Guangdong, China, 523808

A2LA Number:5426.01

ISED#: 25295, CAB identifier: CN0087

☎Tel: +86-769-22212079

🌐Web: <http://www.ntc-cert.com>

✉E-mail:

dave@ntc-cert.com

TABLE OF CONTENTS

TEST REPORT DECLARE	3
1. Summary of test results	4
2. General test information	5
2.1. Detail models.....	7
2.2. Test Peripheral List.....	7
2.3. Block diagram EUT configuration for test	8
2.4. Test environment conditions	8
2.5. Measurement uncertainty	8
3. Power Line Conducted Emission Test	9
3.1. Test equipment	9
3.2. Block diagram of test setup.....	9
3.3. Power Line Conducted Emission Limits (Class B)	9
3.4. Test Procedure.....	10
3.5. Test Result.....	10
4. Radiated emission test.....	13
4.1. Test equipment	13
4.2. Block diagram of test setup.....	14
4.3. Limit	16
4.4. Test Procedure.....	17
4.5. Test result	17
5. Output Power	23
5.1. Test equipment	23
5.2. Block diagram of test setup.....	23
5.3. Limit	23
5.4. Test Procedure.....	23
5.5. Test result	24
6. -6dB Bandwidth.....	26
6.1. Test equipment	26
6.2. Block diagram of test setup.....	26
6.3. Limit	26
6.4. Test Procedure.....	26
6.5. Test result	27
7. Band Edges Measurement.....	29
7.1. Test equipment	29

7.2.	Block diagram of test setup.....	29
7.3.	Limit	29
7.4.	Test Procedure.....	29
7.5.	Test result	30
8.	Conducted Spurious Emission.....	31
8.1.	Test equipment	31
8.2.	Block diagram of test setup.....	31
8.3.	Limit	31
8.4.	Test Procedure.....	31
8.5.	Test result	32
9.	Conducted Output Power Spectral Density	36
9.1.	Test equipment	36
9.2.	Block diagram of test setup.....	36
9.3.	Limit	36
9.4.	Test Procedure.....	36
9.5.	Test result	37
10.	Antenna Requirement.....	39
10.1.	Standard requirement	39
10.2.	EUT Antenna.....	39
11.	Test setup photograph.....	40
11.1.	Photos of power line conducted emission test.....	40
11.2.	Photos of radiated emission test.....	40
12.	Photos of the EUT	42

TEST REPORT DECLARE

FCC ID	:	2AXAA-HN030-01
Applicant	:	CWCE Lighting (Shenzhen) Co., Ltd.
Address	:	A/area, 9F/Bldg,Cuijing Rd 28, Longtian Town,Pingshan New District,SHENZHEN Guangdong China 518122
Equipment under Test	:	WIFI MODULE
Model No	:	HN030-01
Trade Mark	:	 中奇創享
Manufacturer	:	CWCE Lighting (Shenzhen) Co., Ltd.
Address	:	A/area, 9F/Bldg,Cuijing Rd 28, Longtian Town,Pingshan New District,SHENZHEN Guangdong China 518122
Test Laboratory	:	Dongguan New Testing Centre Co., Ltd
Address	:	3F, No. 1 the 1st North Industry Road, Songshan Lake Science &Technology Park, Dongguan, Guangdong, China, 523808

Test Standard Used:

FCC Rules and Regulations Part 15 Subpart C: 2018, ANSI C63.10:2013.

We Declare:

The equipment described above is tested by Dongguan New Testing Centre Co., Ltd and in the configuration tested the equipment complied with the standards specified above. The test results are contained in this test report and Dongguan New Testing Centre Co., Ltd is assumed of full responsibility for the accuracy and completeness of these tests.

After test and evaluation, our opinion is that the equipment provided for test compliance with the requirement of the above FCC standards.

Report No.:	NTC-ER2009024		
Date of Test:	Sep.17, 2020 to Oct.30, 2020	Date of Report:	Oct.30, 2020

Prepared By:

Jeffrey Zhang

Jeffrey Zhang/Engineer



Dave Gao
Dave Gao/LAB Manager

Note: This report applies to above tested sample only. This report shall not be reproduced in parts without written approval of Dongguan New Testing Centre Co., Ltd

1. Summary of test results

Description of Test Item	Standard	Results
Conducted Emission Test	FCC Part 15 Subpart C:2017 ANSI C63.10:2013	PASS
Radiated Emission Test	FCC Part 15 Subpart C:2017 ANSI C63.10:2013	PASS
Output Power	FCC Part 15 Subpart C:2017 ANSI C63.10:2013	PASS
6 dB Bandwidth	FCC Part 15 Subpart C:2017 ANSI C63.10:2013	PASS
Conducted Spurious Emission	FCC Part 15 Subpart C:2017 ANSI C63.10:2013	PASS
Conducted Output Power Spectral Density	FCC Part 15 Subpart C:2017 ANSI C63.10:2013	PASS
Band Edges	FCC Part 15 Subpart C:2017 ANSI C63.10:2013	PASS
Antenna Requirement	FCC PART 15 C section 15.247 (c) and Section 15.203	PASS

2. General test information

Description of EUT

EUT* Name	:	WIFI MODULE
Test model	:	HN030-01
EUT function description	:	Please reference user manual of this device
Power supply	:	DC 12V
Operation frequency:	:	2412 MHz to 2462 MHz for 802.11b/g/n(HT20) 2422 MHz to 2452 MHz for 802.11n(HT40) 2402 MHz to 2480 MHz for Bluetooth (BLE)
Number of Channels:	:	11 Channels for 802.11b/g/n(HT20) 7 Channels for 802.11n(HT40) 40 Channels for Bluetooth (BLE)
Modulation Technology:	:	802.11b: CCK/QPSK/BPSK 802.11g/n: BPSK/QPSK/16QAM/64QAM Bluetooth (BLE):GFSK
Transmit Data Rate:	:	802.11b :1/2/5.5/11 Mbps 802.11g :6/9/12/18/24/36/48/54 Mbps 802.11n(HT20): 7.2/14.4/21.7/28.9/43.3/57.8/65/72.2 Mbps 802.11n(HT40): 15/30/45/60/90/120/135/150 Mbps Bluetooth (BLE):1Mbps
Channel Separation:	:	WiFi: 5 MHz Bluetooth (BLE):2MHz
Antenna Type	:	PCB antenna
Gain:	:	maximum 0 dBi
H/W No.:	:	V1.0
S/W No.:	:	V1.0

Note: 1, EUT is the ab. of equipment under test.

2, This report number “NTC-ER2009024” only report BT-BLE test summary, details and results; For WIFI part, WIFI test summary, details and results is reported in “NTC-ER2009023” .

Frequency list:

1. Test frequencies are lowest channel: 2412 MHz, middle channel: 2437 MHz and highest channel: 2462 MHz for 802.11b/g/n(HT20)

Channel	Frequency (MHz)	Channel	Frequency (MHz)
1	2412	7	2442
2	2417	8	2447
3	2422	9	2452
4	2427	10	2457
5	2432	11	2462
6	2437		

2. Test frequencies are lowest channel: 2422 MHz, middle channel: 2437 MHz and highest channel: 2452 MHz for 802.11n(HT40)

Channel	Frequency (MHz)	Channel	Frequency (MHz)
3	2422	7	2442
4	2427	8	2447
5	2432	9	2452
6	2437		

3. 2.Test frequencies are lowest channel: 2402 MHz, middle channel: 2440 MHz and highest channel: 2480 MHz for Bluetooth(BLE):

Channel	Frequency (MHz)	Channel	Frequency (MHz)	Channel	Frequency (MHz)
0	2402	14	2430	28	2458
1	2404	15	2432	29	2460
2	2406	16	2434	30	2462
3	2408	17	2436	31	2464
4	2410	18	2438	32	2466
5	2412	19	2440	33	2468
6	2414	20	2442	34	2470
7	2416	21	2444	35	2472
8	2418	22	2446	36	2474
9	2420	23	2448	37	2476
10	2422	24	2450	38	2478
11	2424	25	2452	39	2480
12	2426	26	2454	/	/
13	2428	27	2456	/	/

Description of test modes

No.	TEST Mode DESCRIPTION
1	Low channel TX
2	Middle channel TX
3	High channel TX
4	Keeping TX mode
Note: low channel: 2402 MHz, middle channel: 2440 MHz and high channel: 2480 MHz for Bluetooth (BLE).	

Note:

- 1.The EUT has been set to operate continuously on the lowest, middle and highest operation frequency Individually, and the EUT is operating at its maximum duty cycle>or equal 98%
2. All modes under which configure applicable have been tested and the worst mode test data recording in the test report, if no other mode data.
3. For Radiated Emission, 3 axis were chosen for testing for each applicable mode.

2.1. Detail models

Model	Rating	Note
HN030-01	DC 12V	/

Note: All the same except model name.

2.2. Test Peripheral List

No.	Equipment	Manufacturer	Model No.	Serial No.	Note
1	Notebook	Lenovo	ThinkPadE450	PF-0LRXDH	--
2	AC/DC Adapter	Yuewei	YW-212W	--	--

2.3. Block diagram EUT configuration for test

For EUT Tx mode:

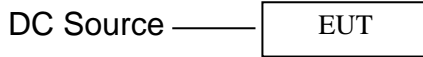

2.4. Test environment conditions

During the measurement the environmental conditions were within the listed ranges:

Temperature range:	21-24°C
Humidity range:	40-75%
Pressure range:	86-106kPa

2.5. Measurement uncertainty

Test Item	Uncertainty
Uncertainty for Conduction emission test	2.44dB
Uncertainty for Radiation Emission test (30MHz – 1GHz)	3.14 dB (Polarize: V)
	3.16 dB (Polarize: H)
Uncertainty for Radiation Emission test (1GHz – 18GHz)	4.27 dB (Polarize: V)
	4.51 dB (Polarize: H)
Bandwidth	±1.2%
Stop Transmitting Time Test	±0.5%
Uncertainty for frequency error	5.8 x 10 ⁻⁸

Note: This uncertainty represents an expanded uncertainty expressed at approximately the 95% confidence level using a coverage factor of k=2.

3. Power Line Conducted Emission Test

3.1. Test equipment

Item	Equipment	Manufacturer	Model No.	Serial No.	Last Cal.	Cal. Interval
1	Test Receiver	R&S	ESCS30	8341151006	2019-12-09	1 Year
2	LISN	R&S	ENV216	3650.6550.06	2020-05-25	1 Year
3	Pulse Limiter	R&S	ESH3-Z2	0357-8810.54	2020-05-25	1 Year
4	RF Cable	HUBER	SUCOFLEX100	30722/4E	2019-05-13	2 Year
5	MEASUREMENT SOFTWARE	FARAD	EZ-EMC(VER:1.1.4.2)	N/A	N/A	N/A

3.2. BLOCK DIAGRAM OF TEST SETUP

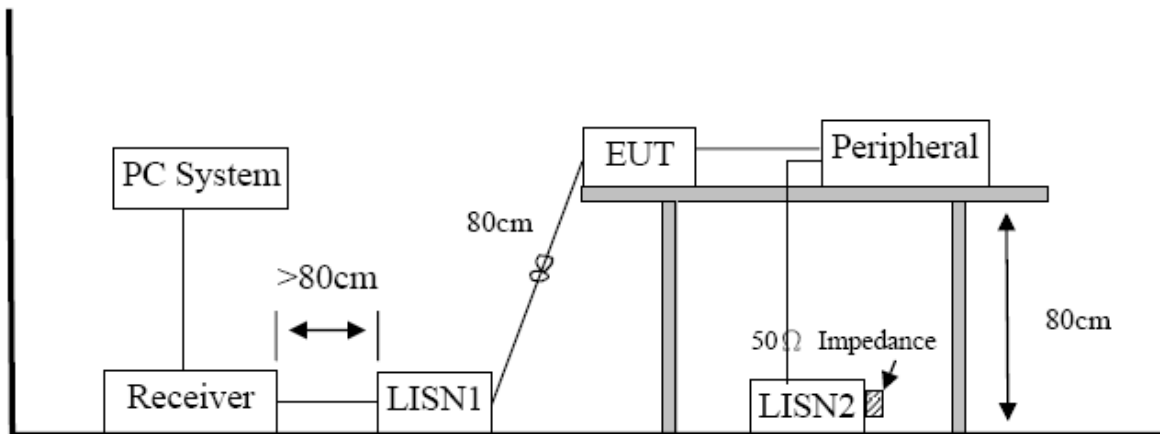

3.3. Power Line Conducted Emission Limits (Class B)

Frequency	Quasi-Peak Level dB(μ V)	Average Level dB(μ V)
150kHz ~ 500kHz	66 ~ 56*	56 ~ 46*
500kHz ~ 5MHz	56	46
5MHz ~ 30MHz	60	50

Note 1: * Decreasing linearly with logarithm of frequency.

Note 2: The lower limit shall apply at the transition frequencies.

3.4. Test Procedure

The EUT and Support equipment, if needed, were put placed on a non-metallic table, 80cm above the ground plane.

Configuration EUT to simulate typical usage as described in clause 2.3 and test equipment as described in clause 3.2 of this report.

All I/O cables were positioned to simulate typical actual usage as per ANSI C63.10.

All support equipment power received from a second LISN.

Emissions were measured on each current carrying line of the EUT using an EMI Test Receiver connected to the LISN powering the EUT.

The Receiver scanned from 150 kHz to 30MHz for emissions in each of the test modes.

During the above scans, the emissions were maximized by cable manipulation.

The test mode(s) described in clause 2.3 were scanned during the preliminary test.

After the preliminary scan, we found the test mode producing the highest emission level.

The EUT configuration and worse cable configuration of the above highest emission levels were recorded for reference of the final test.

EUT and support equipment were set up on the test bench as per the configuration with highest emission level in the preliminary test.

A scan was taken on both power lines, Neutral and Line, recording at least the six highest emissions. Emission frequency and amplitude were recorded into a computer in which correction factors were used to calculate the emission level and compare reading to the applicable limit.

The test data of the worst-case condition(s) was recorded.

The bandwidth of test receiver is set at 9 KHz.

3.5. Test Result

PASS. (See below detailed test result)

Note1: All emissions not reported below are too low against the prescribed limits.

Note2: “-----” means Peak detection; “-----” mans Average detection

Note3: Measurement = Reading Level + Factor, Margin= Measurement-Limit

Conducted Emission Test Result

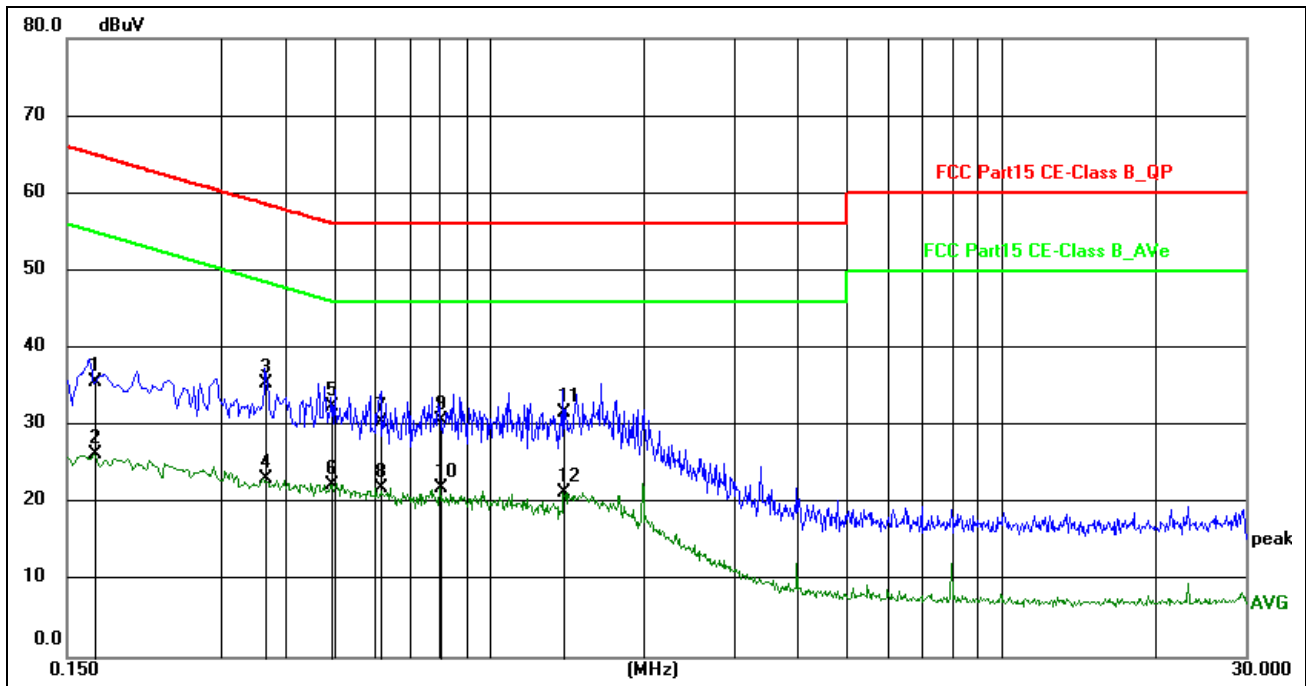

Site:		Phase: N	Temperature(C): 24(C)
Limit:	FCC Part15 CE-Class B_QP		Humidity(%): 63%
EUT:	WIFI MODULE	Test Time:	2020/10/30 16:15:43
M/N.:	HN030-01	Power Rating:	DC 12V by adapter input AC 120V/60Hz
Mode:	Tx mode (2402MHz-Worst case)	Test Engineer:	
Note:			

No.	Frequency (MHz)	Reading Level(dBuV)	Factor (dB)	Measurement(dBuV)	Limit (dBuV)	Margin (dB)	Detector	Comment
1	0.1700	25.71	9.84	35.55	64.96	-29.41	QP	
2	0.1700	16.46	9.84	26.30	54.96	-28.66	AVG	
3 *	0.3659	25.64	9.76	35.40	58.59	-23.19	QP	
4	0.3659	13.29	9.76	23.05	48.59	-25.54	AVG	
5	0.4939	22.80	9.66	32.46	56.10	-23.64	QP	
6	0.4939	12.73	9.66	22.39	46.10	-23.71	AVG	
7	0.6139	20.77	9.65	30.42	56.00	-25.58	QP	
8	0.6139	12.28	9.65	21.93	46.00	-24.07	AVG	
9	0.8020	21.06	9.64	30.70	56.00	-25.30	QP	
10	0.8020	12.27	9.64	21.91	46.00	-24.09	AVG	
11	1.4015	21.95	9.63	31.58	56.00	-24.42	QP	
12	1.4015	11.66	9.63	21.29	46.00	-24.71	AVG	

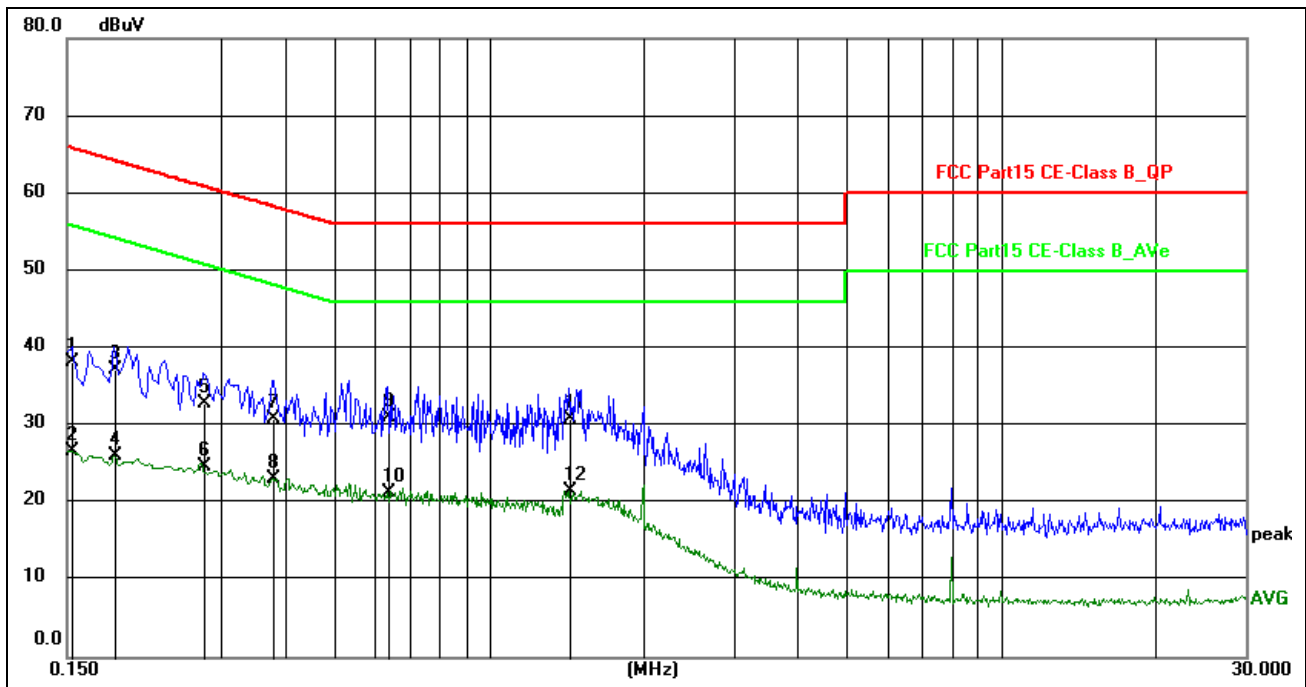

Site:	Phase:L1	Temperature(C):24(C)
Limit: FCC Part15 CE-Class B_QP	Humidity(%):63%	
EUT: WIFI MODULE	Test Time: 2020/10/30 16:10:17	
M/N.: HN030-01	Power Rating: DC 12V by adapter input AC 120V/60Hz	
Mode: Tx mode (2402MHz-Worst case)	Test Engineer:	
Note:		

No.	Frequency (MHz)	Reading Level(dBuV)	Factor (dB)	Measurement(dBuV)	Limit (dBuV)	Margin (dB)	Detector	Comment
1	0.1539	28.31	9.84	38.15	65.79	-27.64	QP	
2	0.1539	16.91	9.84	26.75	55.79	-29.04	AVG	
3	0.1859	27.34	9.86	37.20	64.22	-27.02	QP	
4	0.1859	16.21	9.86	26.07	54.22	-28.15	AVG	
5	0.2779	23.11	9.81	32.92	60.88	-27.96	QP	
6	0.2779	14.83	9.81	24.64	50.88	-26.24	AVG	
7	0.3780	21.16	9.75	30.91	58.32	-27.41	QP	
8	0.3780	13.46	9.75	23.21	48.32	-25.11	AVG	
9	0.6340	21.47	9.65	31.12	56.00	-24.88	QP	
10	0.6340	11.70	9.65	21.35	46.00	-24.65	AVG	
11	1.4377	21.16	9.63	30.79	56.00	-25.21	QP	
12	1.4377	11.95	9.63	21.58	46.00	-24.42	AVG	
*								

4. Radiated emission test

4.1. Test equipment

Item	Equipment	Manufacturer	Model No.	Serial No.	Last Cal.	Cal. Interval
1	EMI Test Receiver	R&S	ESR	7250-30406 7528	2020-04-30	1Year
2	Trilog Broadband Antenna	Schwarzbeck	VULB9168	00969	2019-06-14	2 Year
3	Pre-amplifier	R&S	8447F	3113A04553	2020-05-13	1Year
4	Active Loop antenna	Schwarzbeck	FMZB-1519	1519-038	2020-05-23	1Year
5	Horn antenna	Schwarzbeck	BBHA9120D	453	2019-05-23	2Year
6	Double Ridged Horn Antenna	A.H. System	SAS-574	584	2019-05-13	2Year
7	Pre-amplifier	R&S	SCU18	105326	2020-05-23	1Year
8	RF Cable	GORE	OSQ01Q010 78.7	SN1545847 3	2020-05-23	1Year
9	RF Cable	GORE	OSQ01Q010 78.7	SN1545847 4	2020-05-23	1Year
10	RF Cable	ESCO	ETS-LINGR EN	RFC-SMS-1 00-SMS-340 -IN	2020-05-23	1Year
11	Measurement software	Farad	EZ-EMC(VE R:1.1.4.2)	N/A	N/A	N/A

4.2. Block diagram of test setup

In 3m Anechoic Chamber Test Setup Diagram for 9KHz to 30MHz:

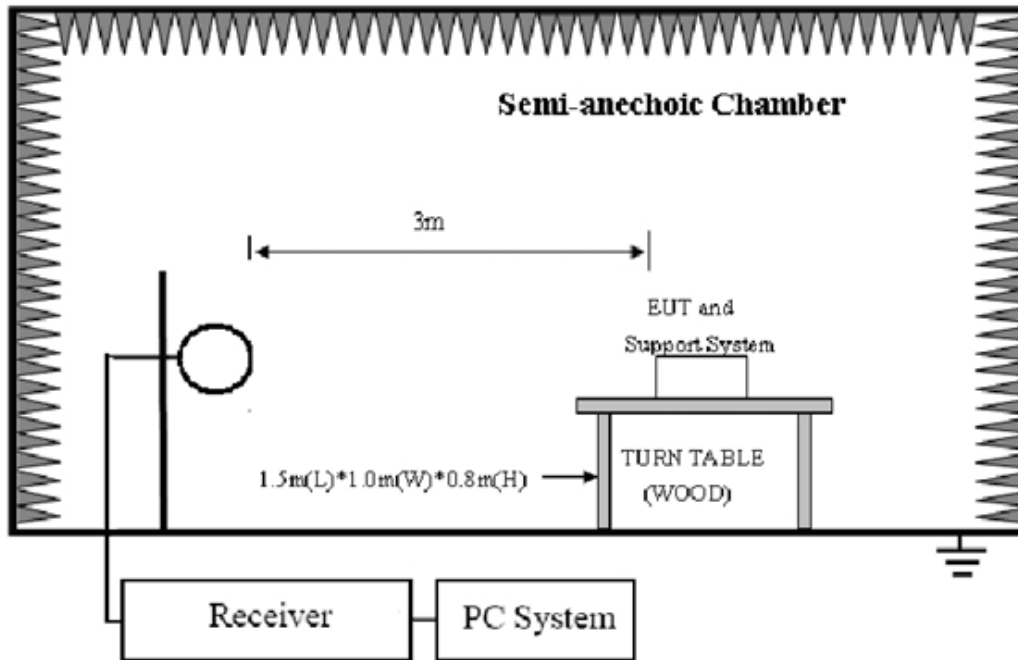

In 3m Anechoic Chamber Test Setup Diagram for 30MHz to 1GHz:

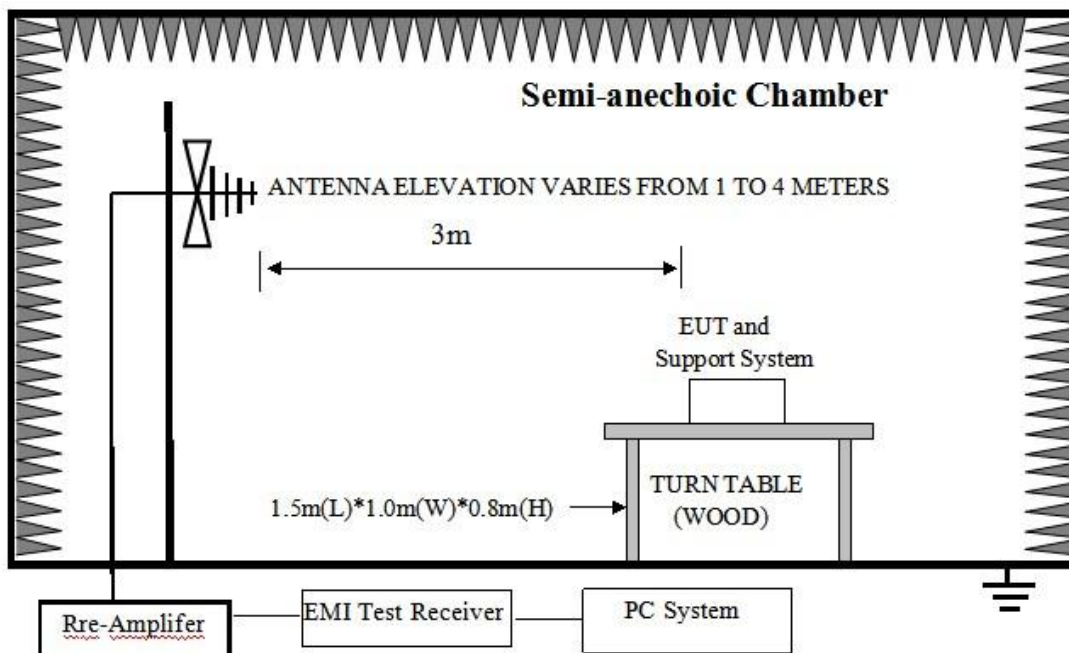

In 3m Anechoic Chamber Test Setup Diagram for frequency above 1GHz:

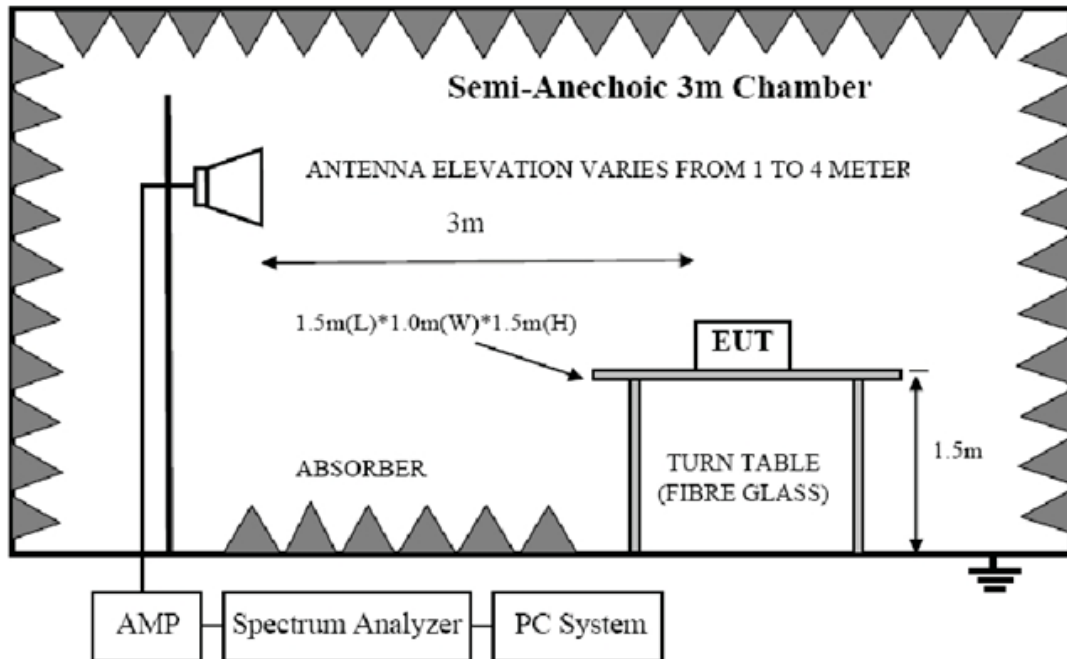

4.3. Limit

FCC 15.205 Restricted frequency band:

MHz	MHz	MHz	GHz
0.090 - 0.110	16.42 - 16.423	399.9 - 410	4.5 - 5.15
¹ 0.495 - 0.505	16.69475 - 16.69525	608 - 614	5.35 - 5.46
2.1735 - 2.1905	16.80425 - 16.80475	960 - 1240	7.25 - 7.75
4.125 - 4.128	25.5 - 25.67	1300 - 1427	8.025 - 8.5
4.17725 - 4.17775	37.5 - 38.25	1435 - 1626.5	9.0 - 9.2
4.20725 - 4.20775	73 - 74.6	1645.5 - 1646.5	9.3 - 9.5
6.215 - 6.218	74.8 - 75.2	1660 - 1710	10.6 - 12.7
6.26775 - 6.26825	108 - 121.94	1718.8 - 1722.2	13.25 - 13.4
6.31175 - 6.31225	123 - 138	2200 - 2300	14.47 - 14.5
8.291 - 8.294	149.9 - 150.05	2310 - 2390	15.35 - 16.2
8.362 - 8.366	156.52475 - 156.52525	2483.5 - 2500	17.7 - 21.4
8.37625 - 8.38675	156.7 - 156.9	2690 - 2900	22.01 - 23.12
8.41425 - 8.41475	162.0125 - 167.17	3260 - 3267	23.6 - 24.0
12.29 - 12.293	167.72 - 173.2	3332 - 3339	31.2 - 31.8
12.51975 - 12.52025	240 - 285	3345.8 - 3358	36.43 - 36.5
12.57675 - 12.57725	322 - 335.4	3600 - 4400	(²)

FCC 15.109 Limit

Frequency (MHz)	Distance (Meters)	Field Strengths Limits dB(μV)/m
30--88	3	40.0
88--216	3	43.5
216--960	3	46.0
960--1000	3	54.0
Above 1GHz	3	Peak: 74.0
	3	Average:54.0

Note: (1) The smaller limit shall apply at the cross point between two frequency bands.

(2)Distance is the distance in meters between the measuring instrument, antenna and the closest point of any part of the device or system.

(3)The emission limits shown in the above table are based on measurements employing a CISPR QP detector except for the frequency bands 9-90KHz, 110-490KHz and above 1000MHz.Radiated emissions limits in these three bands are based on measurements employing an average detector.

(4) At frequencies below 30MHz, measurement may be performed at a distance closer then that specified, and the limit at closer measurement distance can be extrapolated by below formula:

$$\text{Limit } 3\text{m(dBuV/m)} = \text{Limit}30\text{m(dBuV/m)} + 40\text{Log}(30\text{m}/3\text{m})$$

(5)All the emissions appearing within 15.205 restricted frequency bands shall not exceed the limits shown in 15.109, all the other emissions shall be at least 20dB below the fundamental emissions, or comply with 15.109 limits.

4.4. Test Procedure

Procedure of Preliminary Test

Configuration EUT to simulate typical usage as described in clause 2.3 and test equipment as described in clause 4.2 of this report.

Mains cables, telephone lines or other connections to auxiliary equipment located outside the test are shall drape to the floor, be fitted with ferrite clamps or ferrite tubes placed on the floor at the point where the cable reaches the floor and then routed to the place where they leave the turntable. No extension cords shall be used to mains receptacle.

EUT height should be 0.8m for below 1GHz and 1.5m for above 1GHz at ground with absorbers.

The antenna was placed at 3 meter away from the EUT as stated in ANSI C63.10. The antenna connected to the Spectrum Analyzer via a cable and at times a pre-amplifier would be used.

The Analyzer / Receiver quickly scanned from 30MHz to 18GHz. The EUT test program was started. Emissions were scanned and measured rotating the EUT to 360 degrees and positioning the antenna 1 to 4 meters above the ground plane, in both the vertical and the horizontal polarization, to maximize the emission reading level.

The X, Y, Z three axial are tested and the report only the worst case.

The emissions from 9KHz to 1GHz, QP or average values were measured with EMI receiver with below RBW:

Frequency band	RBW
9KHz-150KHz	200Hz
150KHz-30MHz	9KHz
30MHz-1GHz	120KHz

For emissions above 1GHz, both Peak and Average level were measured with Spectrum Analyzer, and the RBW is set at 1MHz, VBW is set at 3MHz for Peak measure; RMS detector RBW 1MHz VBW 3MHz for Average measure.

4.5. Test result

PASS. (See below detailed test result)

Radiated Emissions Test Data Below 30MHz:

No emission found between lowest internal used/generated frequencies to 30MHz.

Radiated Emission Test Result

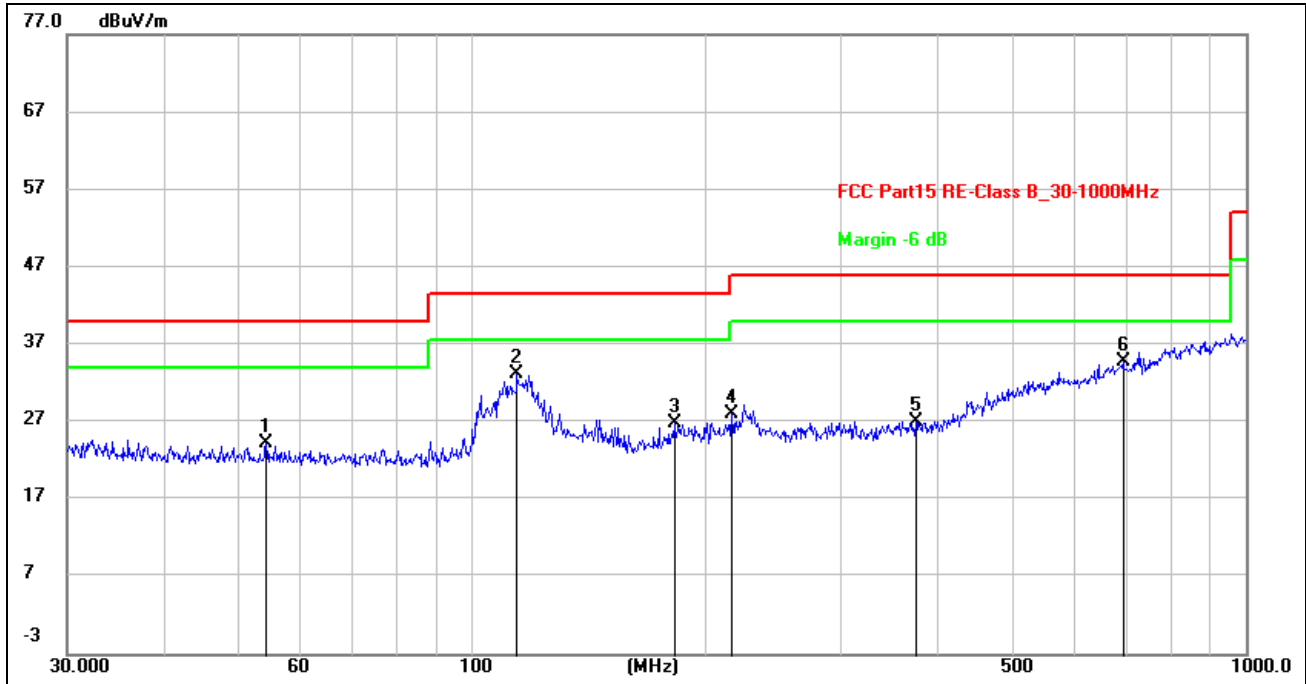

Site:		Antenna:: Horizontal	Temperature(C): 24(C)
Limit:	FCC Part15 RE-Class B_30-1000MHz		Humidity(%): 60%
EUT:	WIFI MODULE	Test Time:	2020/10/30 17:57:58
M/N.:	HN030-01	Power Rating:	DC 12V by adapter input AC 120V/60Hz
Mode:	Tx mode (2402MHz-Worst case)	Test Engineer:	
Note:			

No.	Frequency (MHz)	Reading (dBuV)	Factor (dB/m)	Level (dBuV/m)	Limit (dBuV/m)	Margin (dB)	Det.	Height (cm)	Azimuth (deg)	Remark
1	54.2609	11.28	13.04	24.32	40.00	-15.68	peak	200	295	
2 *	114.5146	21.14	12.07	33.21	43.50	-10.29	peak	200	3	
3	182.5592	13.88	12.92	26.80	43.50	-16.70	peak	100	254	
4	216.7828	14.20	13.83	28.03	46.00	-17.97	peak	200	241	
5	374.6225	12.06	15.06	27.12	46.00	-18.88	peak	200	40	
6	694.4174	13.83	21.05	34.88	46.00	-11.12	peak	200	3	

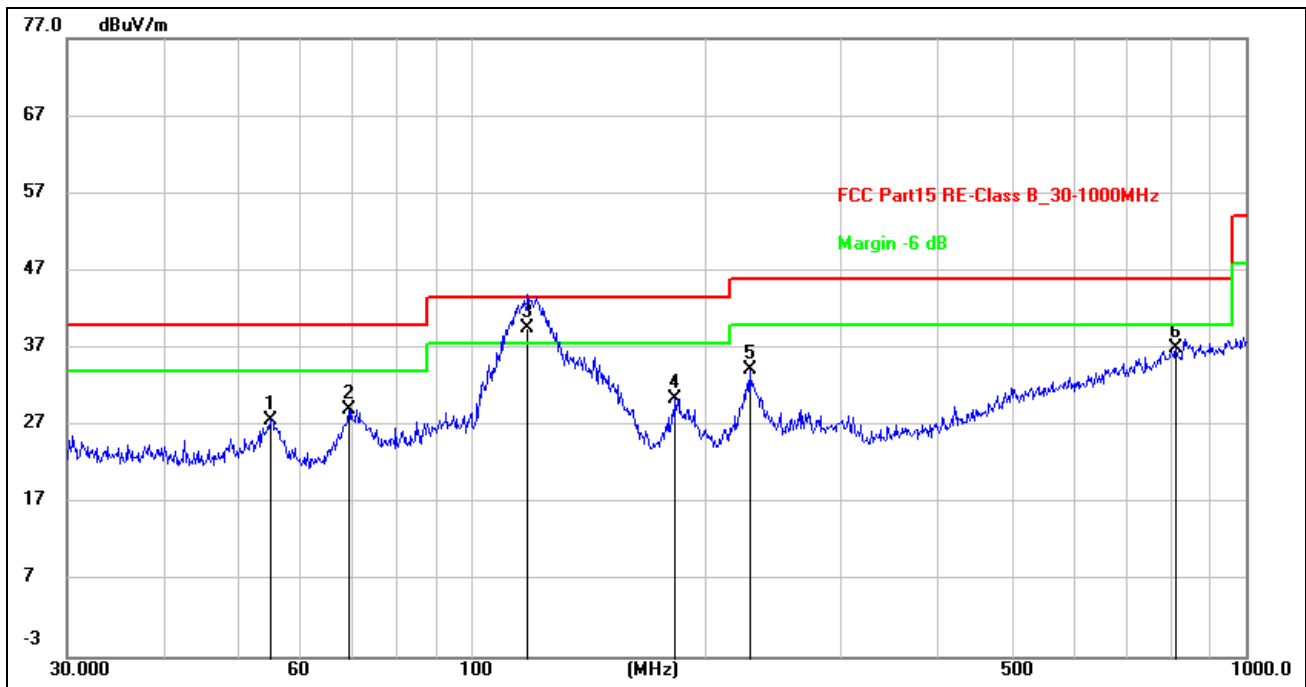

Site:		Antenna::Vertical	Temperature(C):24(C)
Limit:	FCC Part15 RE-Class B_30-1000MHz		Humidity(%):60%
EUT:	WIFI MODULE	Test Time:	2020/10/30 17:49:14
M/N.:	HN030-01	Power Rating:	DC 12V by adapter input AC 120V/60Hz
Mode:	Tx mode (2402MHz-Worst case)	Test Engineer:	
Note:			

No.	Frequency (MHz)	Reading (dBuV)	Factor (dB/m)	Level (dBuV/m)	Limit (dBuV/m)	Margin (dB)	Det.	Height (cm)	Azimuth (deg)	Remark
1	55.0274	14.71	13.04	27.75	40.00	-12.25	peak	100	260	
2	69.3568	16.45	12.57	29.02	40.00	-10.98	peak	100	323	
3 *	118.1862	27.14	12.41	39.55	43.50	-3.95	QP	100	3	
4	183.2005	17.51	12.95	30.46	43.50	-13.04	peak	100	119	
5	228.2595	20.35	13.88	34.23	46.00	-11.77	peak	200	16	
6	813.1115	13.25	23.67	36.92	46.00	-9.08	peak	100	3	

Site:	966 LAB	Antenna::H / V	Temperature(C):24(C)
Limit:	FCC Part 15.247		Humidity(%):60%
EUT:	WIFI MODULE	Test Time:	2020/09/24
M/N.:	HN030-01	Power Rating:	DC 3.3V
Mode:	Tx mode (2402MHz)	Test Engineer:	
Note:			

Frequency (MHz)	Reading (dBuV)	Factor (dB/m)	Pre-amp (dB)	Cable lost (dB)	Result (dBuV/m)	Limit (dBuV/m)	Margin (dB)	Detect	Antenna polarization
2390.00	55.42	26.33	40.23	8.46	49.98	74.00	-24.02	peak	H
2390.00	44.17	26.33	40.23	8.46	38.73	54.00	-15.27	AVG	H
2400.00	55.40	26.38	40.20	8.49	50.07	74.00	-23.93	peak	H
2400.00	44.98	26.38	40.20	8.49	39.65	54.00	-14.35	AVG	H
4804.00	52.61	26.41	40.21	8.51	47.32	74.00	-26.68	peak	H
4804.00	43.49	26.41	40.21	8.51	38.20	54.00	-15.80	AVG	H
7206.00	50.03	31.01	40.19	9.53	50.38	74.00	-23.62	peak	H
7206.00	36.57	31.01	40.19	9.53	36.92	54.00	-17.08	AVG	H
2390.00	55.36	26.33	40.23	8.46	49.92	74.00	-24.08	peak	V
2390.00	43.04	26.33	40.23	8.46	37.60	54.00	-16.40	AVG	V
2400.00	50.89	26.38	40.20	8.49	45.56	74.00	-28.44	peak	V
2400.00	43.61	26.38	40.20	8.49	38.28	54.00	-15.72	AVG	V
4804.00	54.48	26.41	40.21	8.51	49.19	74.00	-24.81	peak	V
4804.00	40.70	26.41	40.21	8.51	35.41	54.00	-18.59	AVG	V
7206.00	48.69	31.01	40.19	9.53	49.04	74.00	-24.96	peak	V
7206.00	36.32	31.01	40.19	9.53	36.67	54.00	-17.33	AVG	V

Note: 1. Result Level = Reading Level + Antenna Factor + Cable loss – Pre-amp Factor.

2. Antenna polarization: “H” means Horizontal, “V” means Vertical.

Site:	966 LAB	Antenna::H / V	Temperature(C):24(C)
Limit:	FCC Part 15.247		Humidity(%):60%
EUT:	WIFI MODULE	Test Time:	2020/09/24
M/N.:	HN030-01	Power Rating:	DC 3.3V
Mode:	Tx mode (2440MHz)	Test Engineer:	
Note:			

Frequency (MHz)	Reading (dBuV)	Factor (dB/m)	Pre-amp (dB)	Cable lost (dB)	Result (dBuV/m)	Limit (dBuV/m)	Margin (dB)	Detect	Antenna polarization
4880.00	53.56	31.04	40.19	9.59	54.00	74.00	-20.00	peak	H
4880.00	41.67	31.04	40.19	9.59	42.11	54.00	-11.89	AVG	H
7320.00	49.99	35.25	40.47	12.22	56.99	74.00	-17.01	peak	H
7320.00	34.10	35.25	40.47	12.22	41.10	54.00	-12.90	AVG	H
4880.00	50.96	31.04	40.19	9.59	51.40	74.00	-22.60	peak	V
4880.00	40.54	31.04	40.19	9.59	40.98	54.00	-13.02	AVG	V
7320.00	49.99	35.25	40.47	12.22	56.99	74.00	-17.01	peak	V
7320.00	36.70	35.25	40.47	12.22	43.70	54.00	-10.30	AVG	V

Note: 1. Result Level = Reading Level + Antenna Factor + Cable loss – Pre-amp Factor.

2. Antenna polarization: “H” means Horizontal, “V” means Vertical.

Site:	966 LAB	Antenna::H / V	Temperature(C):24(C)
Limit:	FCC Part 15.247		Humidity(%):60%
EUT:	WIFI MODULE	Test Time:	2020/09/24
M/N.:	HN030-01	Power Rating:	DC 3.3V
Mode:	Tx mode (2480MHz)	Test Engineer:	
Note:			

Frequency (MHz)	Reading (dBuV)	Factor (dB/m)	Pre-amp (dB)	Cable lost (dB)	Result (dBuV/m)	Limit (dBuV/m)	Margin (dB)	Detect	Antenna polarization
2483.50	56.11	26.56	40.29	8.65	51.03	74.00	-22.97	peak	H
2483.50	43.13	26.56	40.29	8.65	38.05	54.00	-15.95	AVG	H
4960.00	53.67	26.51	40.21	8.54	48.51	74.00	-25.49	peak	H
4960.00	41.50	26.51	40.21	8.54	36.34	54.00	-17.66	AVG	H
7440.00	44.48	31.04	40.19	9.62	44.95	74.00	-29.05	peak	H
7440.00	35.48	31.04	40.19	9.62	35.95	54.00	-18.05	AVG	H
2483.50	50.09	26.56	40.29	8.65	45.01	74.00	-28.99	peak	V
2483.50	42.31	26.56	40.29	8.65	37.23	54.00	-16.77	AVG	V
4960.00	49.76	26.51	40.21	8.54	44.60	74.00	-29.40	peak	V
4960.00	42.02	26.51	40.21	8.54	36.86	54.00	-17.14	AVG	V
7440.00	48.92	31.04	40.19	9.62	49.39	74.00	-24.61	peak	V
7440.00	32.66	31.04	40.19	9.62	33.13	54.00	-20.87	AVG	V

Note: 1. Result Level = Reading Level + Antenna Factor + Cable loss – Pre-amp Factor.

2. Antenna polarization: “H” means Horizontal, “V” means Vertical.

5. Output Power

5.1. Test equipment

Item	Equipment	Manufacturer	Model No.	Serial No.	Last Cal.	Cal. Interval
1	MXA Signal Analyzer	KEYSIGHT	N9020A	MY5451047 6	2020/05/25	1 Year

5.2. BLOCK DIAGRAM OF TEST SETUP

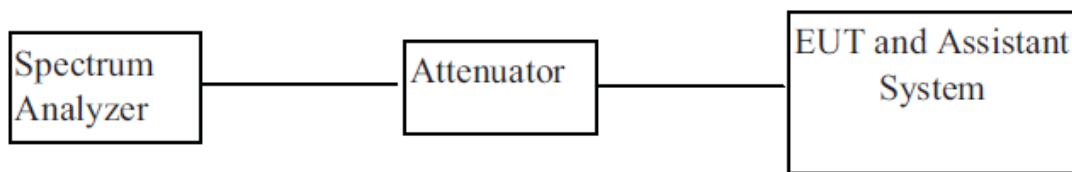

5.3. Limit

For systems using digital modulation in the 902-928 MHz, 2400-2483.5 MHz, and 5725-5850 MHz bands: 1 Watt (30dBm).

5.4. Test Procedure

For output power test:

1. Connect EUT RF output port to power sensor through an RF attenuator.
2. Connect the power sensor to the PC.
3. Set the EUT Work on the top, the middle and the bottom operation frequency individually.
4. Record the maximum power from the software.

Note : The EUT was tested according to KDB 558074v03r04 for compliance to FCC 47CFR 15.247 requirements.

5.5. Test result

Condition	Mode	Frequency (MHz)	Antenna	Conducted Power (dBm)	Duty Factor (dB)	Total Power (dBm)	Limit (dBm)	Verdict
NVNT	BLE	2402	Ant 1	-0.822	0	-0.822	30	Pass
NVNT	BLE	2440	Ant 1	-0.522	0	-0.522	30	Pass
NVNT	BLE	2480	Ant 1	-0.576	0	-0.576	30	Pass

Power NVNT BLE 2402MHz Ant1

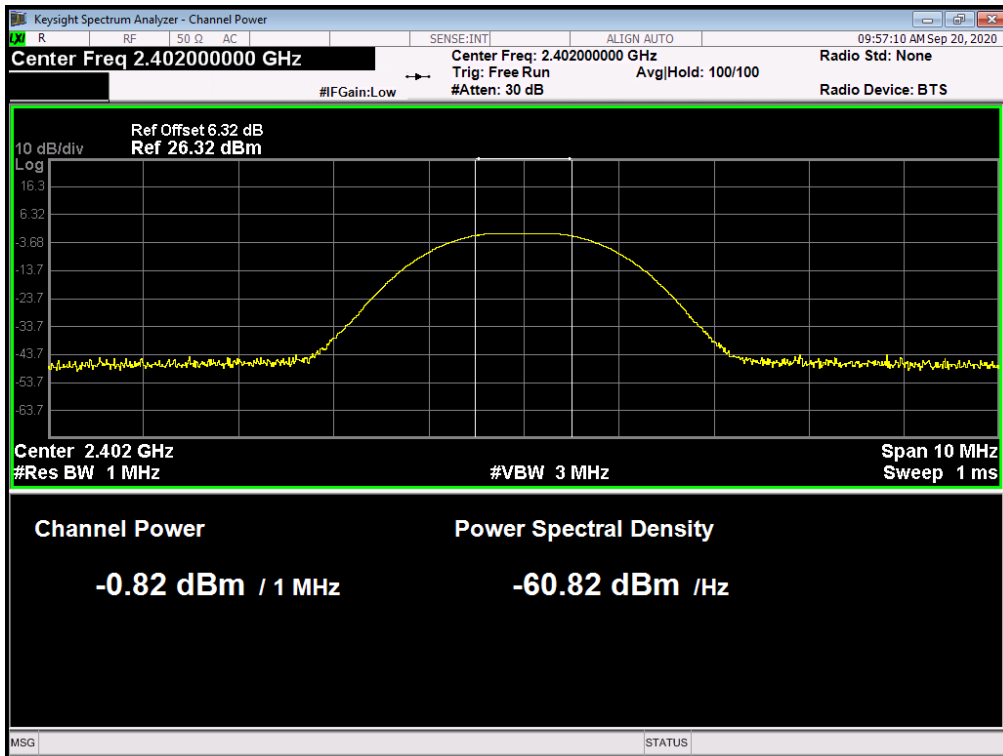

Power NVNT BLE 2440MHz Ant1

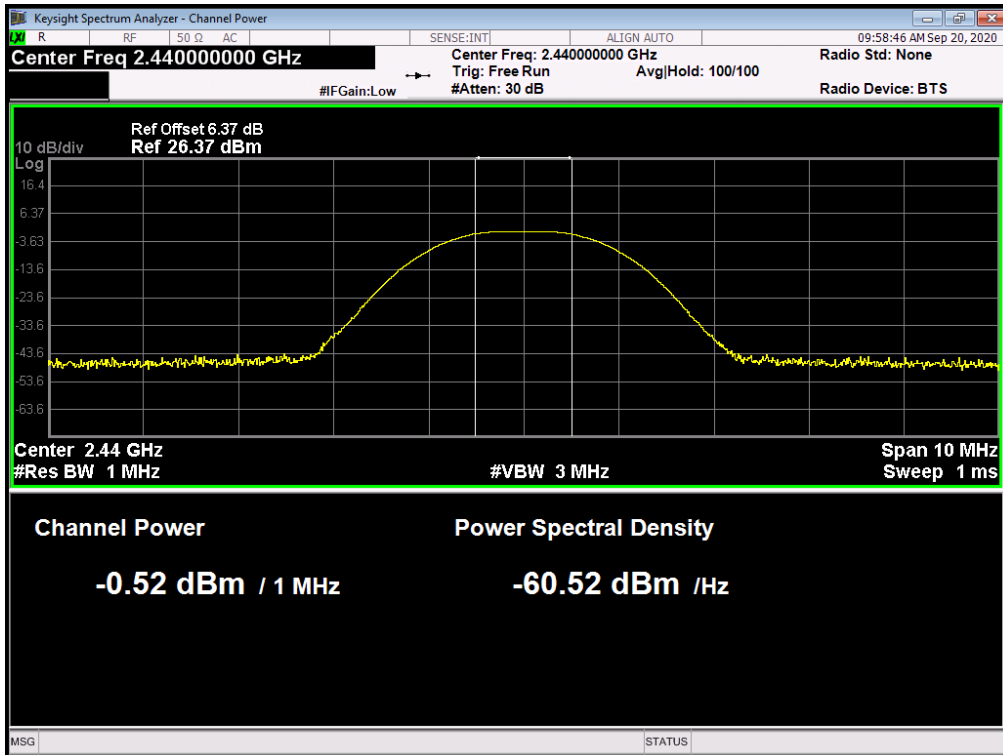

Power NVNT BLE 2480MHz Ant1

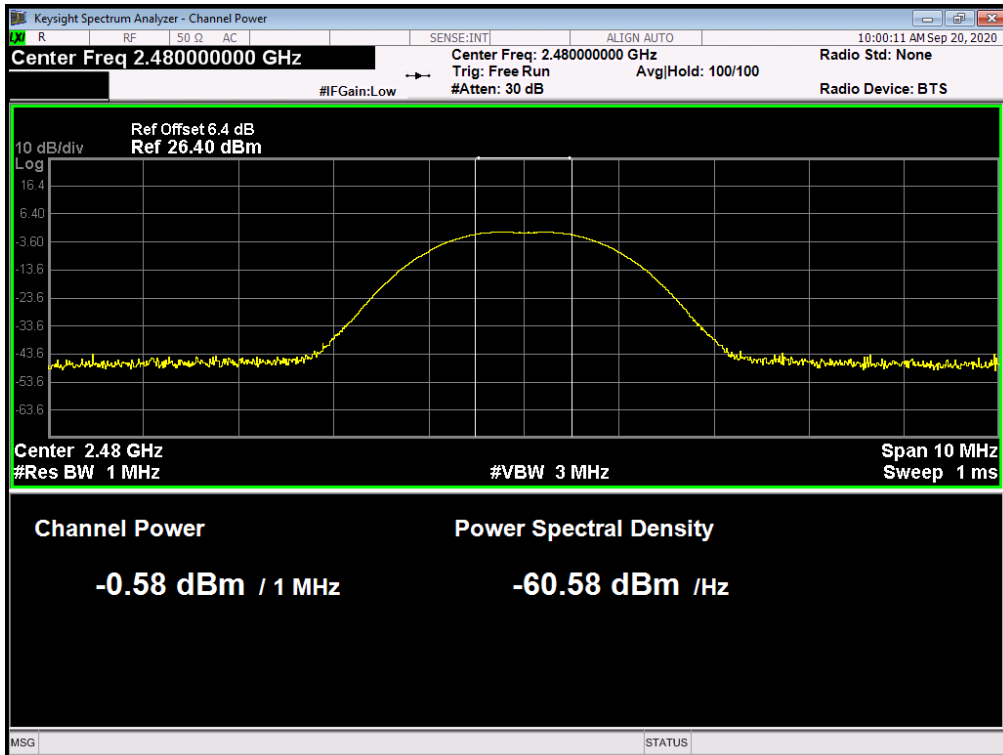

6. -6dB Bandwidth

6.1. Test equipment

Item	Equipment	Manufacturer	Model No.	Serial No.	Last Cal.	Cal. Interval
1	MXA Signal Analyzer	KEYSIGHT	N9020A	MY5451047 6	2020/05/25	1 Year

6.2. BLOCK DIAGRAM OF TEST SETUP

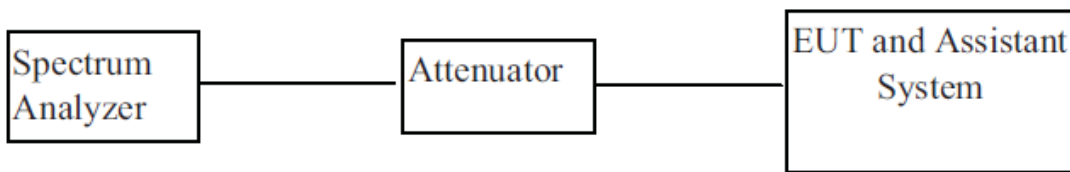

6.3. Limit

Systems using digital modulation techniques may operate in the 902 - 928 MHz, 2400 - 2483.5 MHz, and 5725 - 5850 MHz bands. The minimum 6 dB bandwidth shall be at least 500 kHz.

6.4. Test Procedure

1. Connect EUT RF output port to the Spectrum Analyzer through an RF attenuator
2. Set the EUT Work on the top, the middle and the bottom operation frequency individually.
3. Set SPA Centre Frequency = Operation Frequency, RBW= 100 KHz, VBW \geq 3 \times RBW.
4. Set SPA Trace 1 Max hold, then View.

Note: The EUT was tested according to KDB 558074 for compliance to FCC 47CFR 15.247 requirements.

6.5. Test result

Condition	Mode	Frequency (MHz)	Antenna	99% OBW (MHz)	-6 dB Bandwidth (MHz)	Limit -6 dB Bandwidth (MHz)	Verdict
NVNT	BLE	2402	Ant 1	1.0407	0.6163	0.5	Pass
NVNT	BLE	2440	Ant 1	1.0408	0.684	0.5	Pass
NVNT	BLE	2480	Ant 1	1.0292	0.6556	0.5	Pass

OBW NVNT BLE 2402MHz Ant1

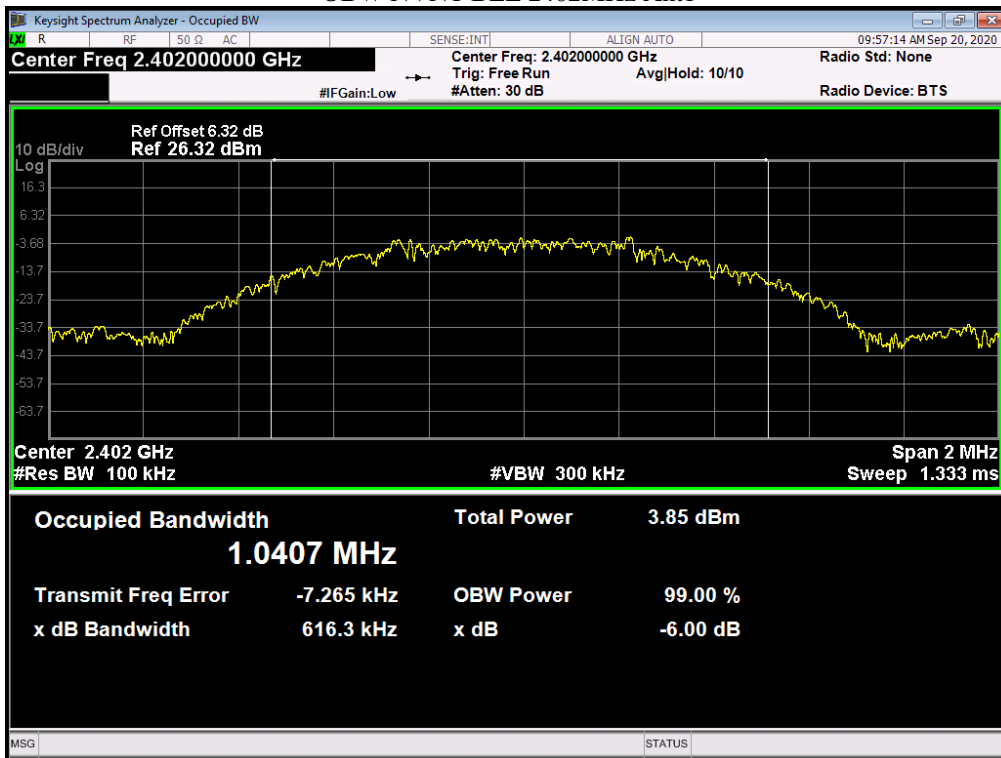

OBW NVNT BLE 2440MHz Ant1

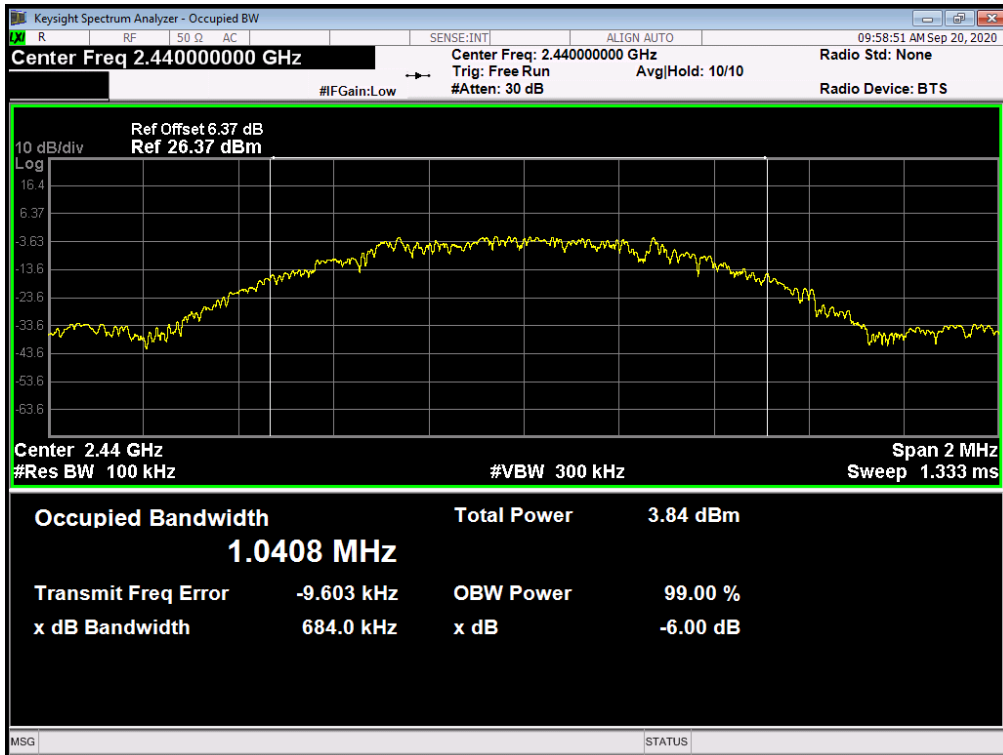

OBW NVNT BLE 2480MHz Ant1

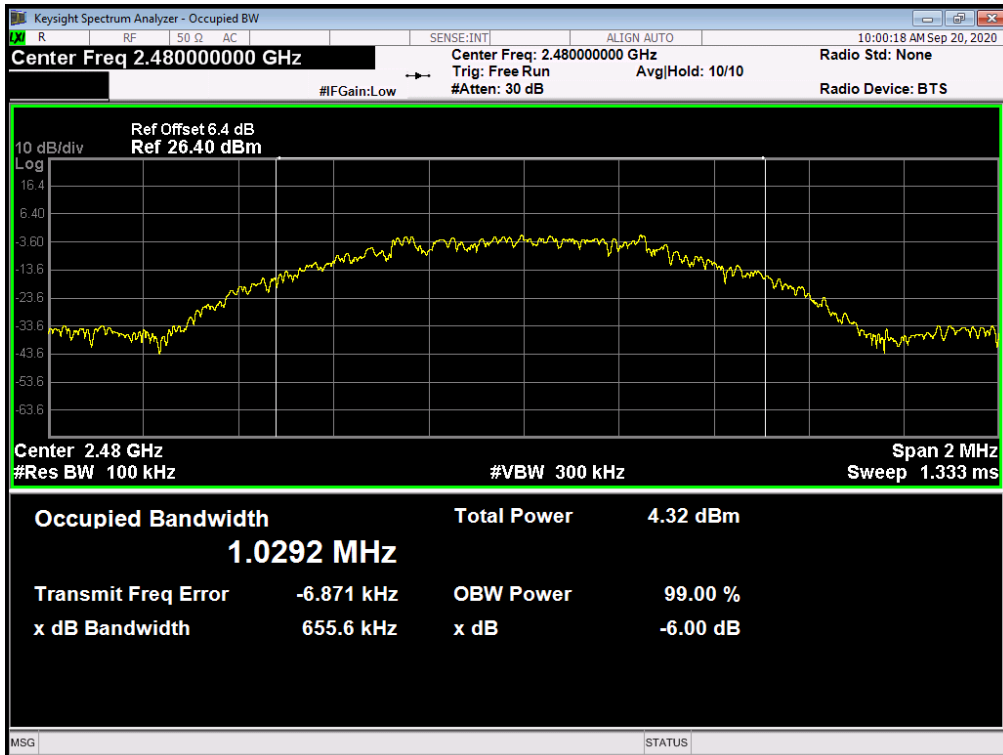

7. Band Edges Measurement

7.1. Test equipment

Item	Equipment	Manufacturer	Model No.	Serial No.	Last Cal.	Cal. Interval
1	MXA Signal Analyzer	KEYSIGHT	N9020A	MY5451047 6	2020/05/25	1 Year

7.2. BLOCK DIAGRAM OF TEST SETUP

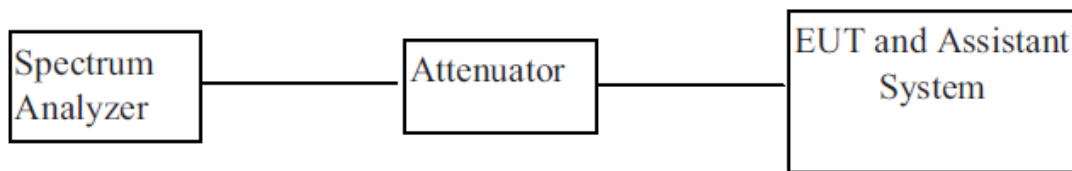

7.3. Limit

Below -30dB of the highest emission level of operating band (In 100 kHz Resolution Bandwidth)

7.4. Test Procedure

The transmitter output was connected to the spectrum analyzer via a low lose cable.

Set RBW of spectrum analyzer to 100 KHz and VBW of spectrum analyzer to 300 KHz with convenient frequency span including 100 KHz bandwidth from band edge.

Peak conducted output power measured within any 100 kHz outside the authorized frequency band shall be attenuated by at least 30dB relative to the maximum measured in-band peak PSD level.

The band edges was measured and recorded.

7.5. Test result

Condition	Mode	Frequency (MHz)	Antenna	Max Value (dBc)	Limit (dBc)	Verdict
NVNT	BLE	2402	Ant 1	-56.863	-30	Pass
NVNT	BLE	2480	Ant 1	-54.023	-30	Pass

Band Edge NVNT BLE 2402MHz Ant1 Emission

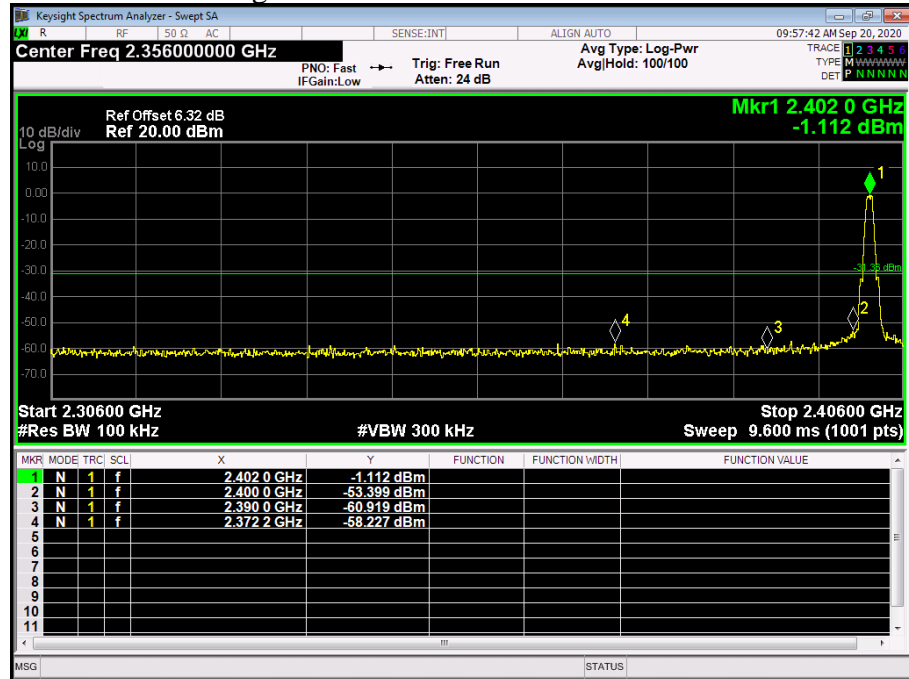

Band Edge NVNT BLE 2480MHz Ant1 Emission

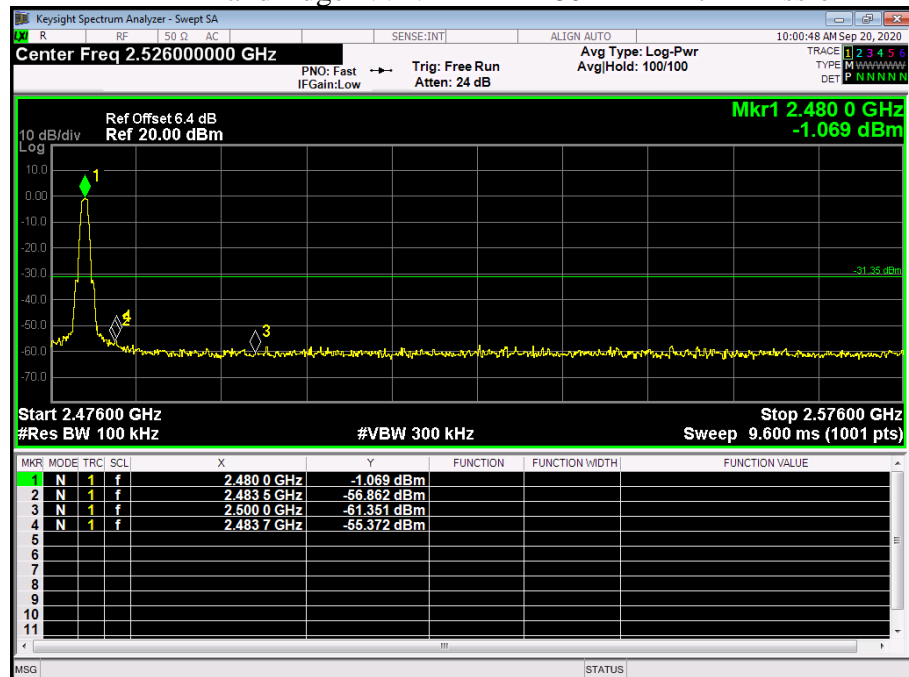

8. Conducted Spurious Emission

8.1. Test equipment

Item	Equipment	Manufacturer	Model No.	Serial No.	Last Cal.	Cal. Interval
1	MXA Signal Analyzer	KEYSIGHT	N9020A	MY5451047 6	2020/05/25	1 Year

8.2. BLOCK DIAGRAM OF TEST SETUP

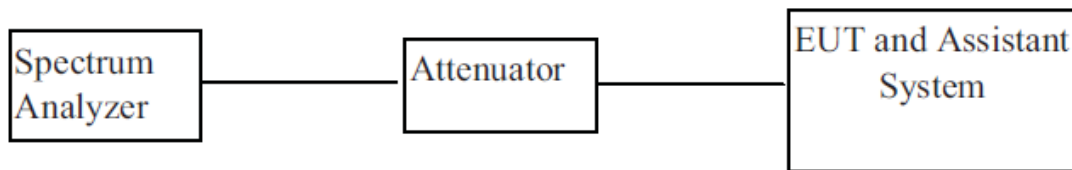

8.3. Limit

In any 100 KHz Bandwidth Outside the frequency band in which the spread spectrum intentional radiator is operating, the radio frequency power that is produce by the intentional radiator shall be at least 20 dB below that in 100KHz bandwidth within the band that contains the highest level of the desired power.

In addition, radiation emissions which fall in the restricted bands, as defined in §15.205(a), must also comply with the radiated emission limits specified in§15.209(a)

8.4. Test Procedure

1. Connect EUT RF output port to the Spectrum Analyzer through an RF attenuator
- 2, Set the EUT Work on the top, the middle and the bottom operation frequency individually.
3. Set SPA Trace 1 Max hold, then View.

Note: The EUT was tested according to KDB 558074 for compliance to FCC 47CFR 15.247 requirements. Owing to satisfy the requirements of the number of measurement points, we set the RBW=1MHz, VBW > RBW, scan up through 10th harmonic, and consider the tested results as the worst case, if the tested results conform to the requirement, we can deem that the real tested results(set the RBW=100KHz, VBW > RBW) are conform to the requirement.

8.5. Test result

Condition	Mode	Frequency (MHz)	Antenna	Max Value (dBc)	Limit (dBc)	Verdict
NVNT	BLE	2402	Ant 1	-40.173	-30	Pass
NVNT	BLE	2440	Ant 1	-40.426	-30	Pass
NVNT	BLE	2480	Ant 1	-40.159	-30	Pass

Tx. Spurious NVNT BLE 2402MHz Ant1 Ref

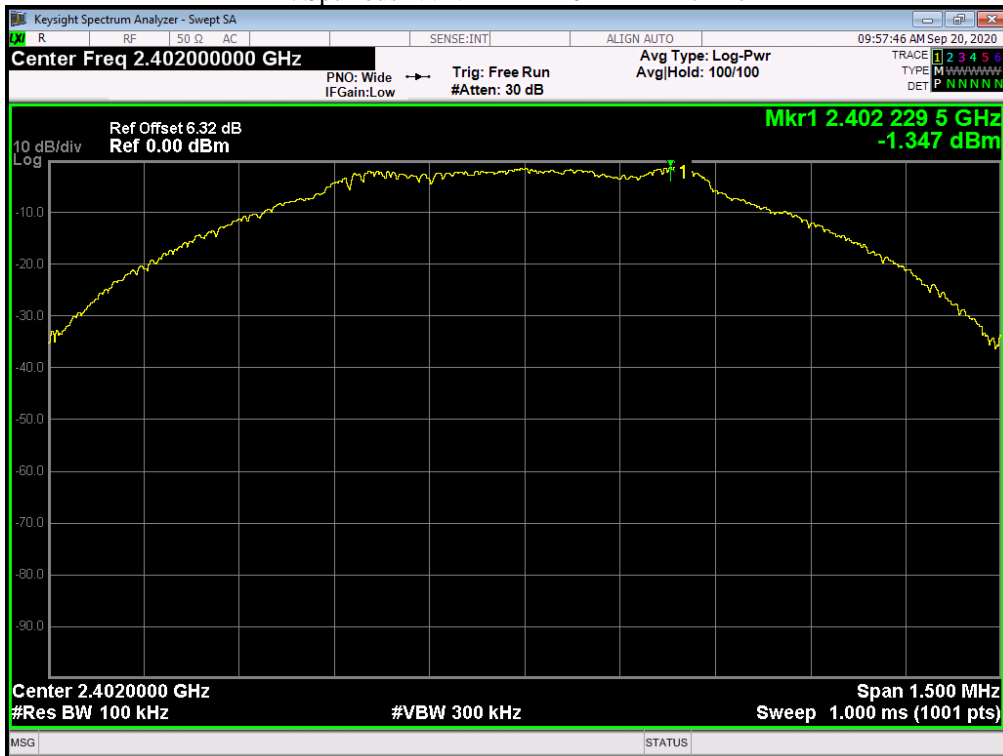

Tx. Spurious NVNT BLE 2402MHz Ant1 Emission

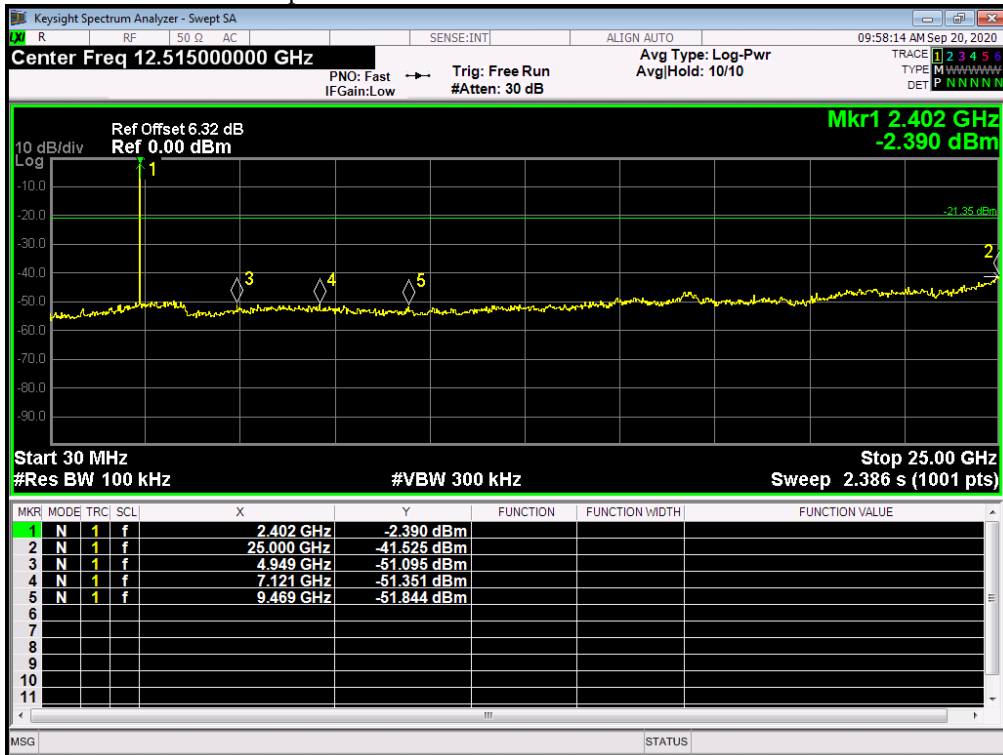

Tx. Spurious NVNT BLE 2440MHz Ant1 Ref

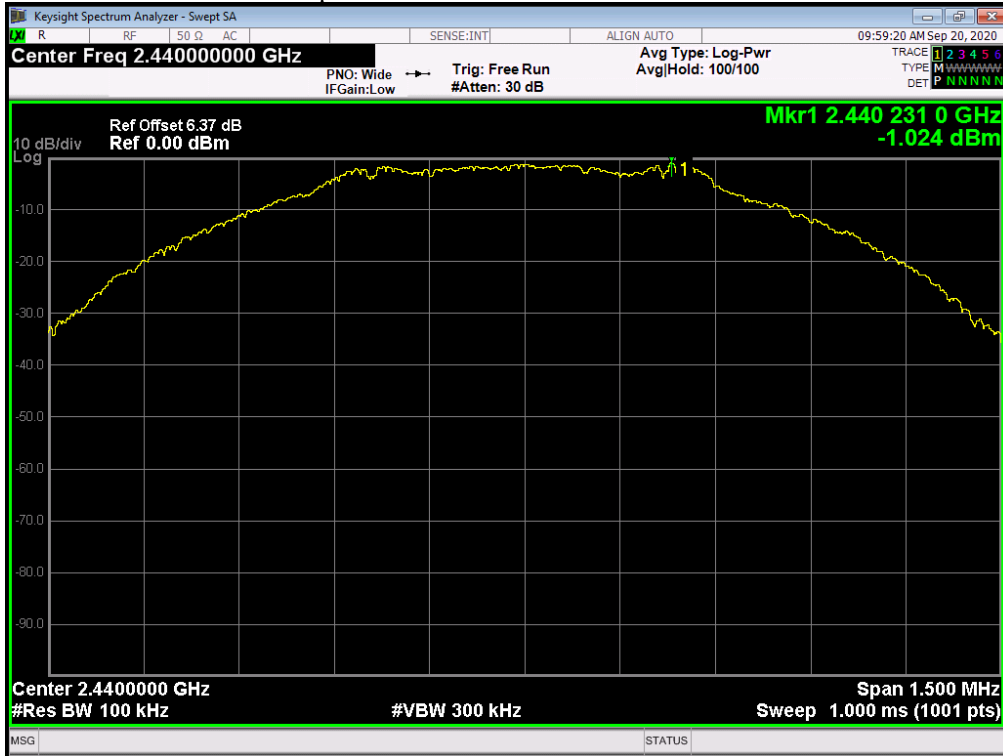

Tx. Spurious NVNT BLE 2440MHz Ant1 Emission

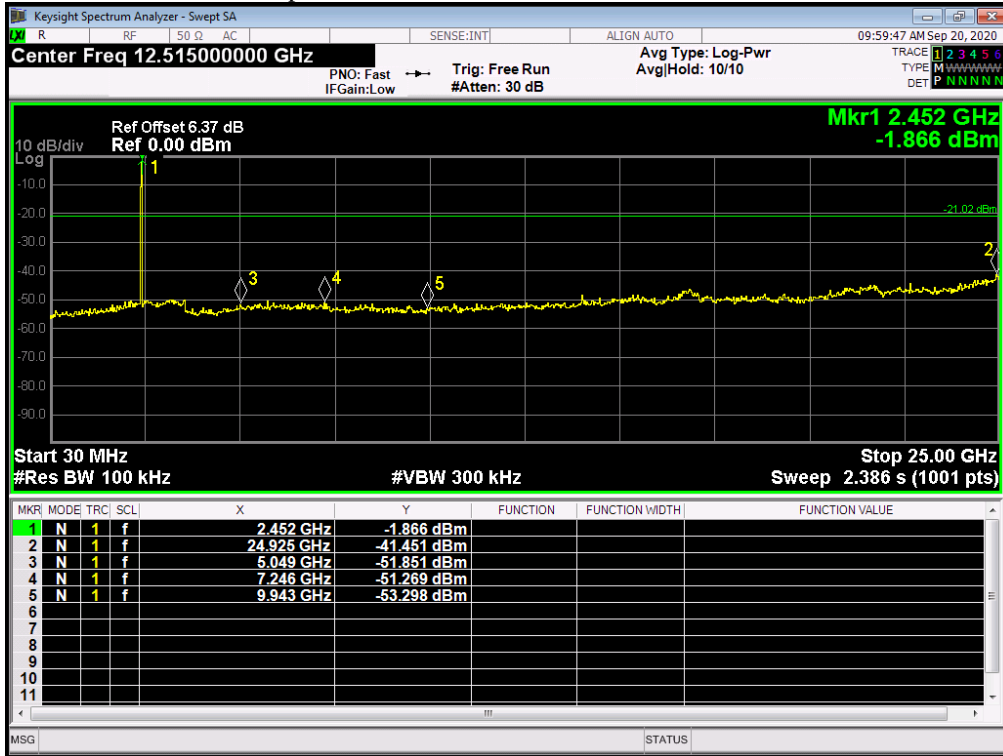

Tx. Spurious NVNT BLE 2480MHz Ant1 Ref

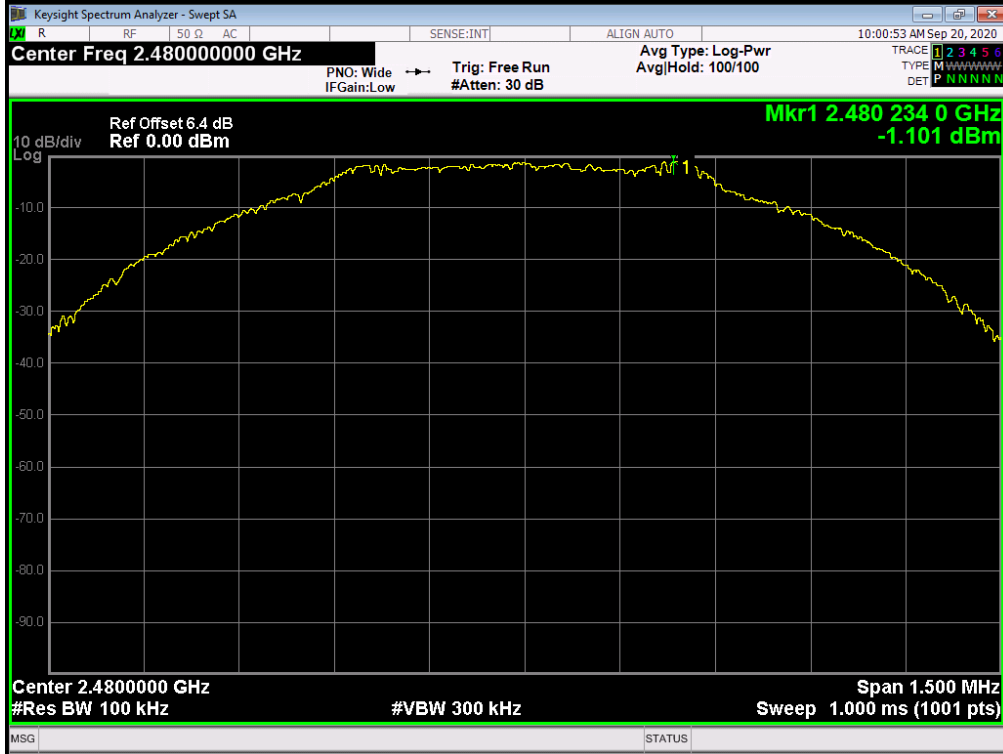

Tx. Spurious NVNT BLE 2480MHz Ant1 Emission

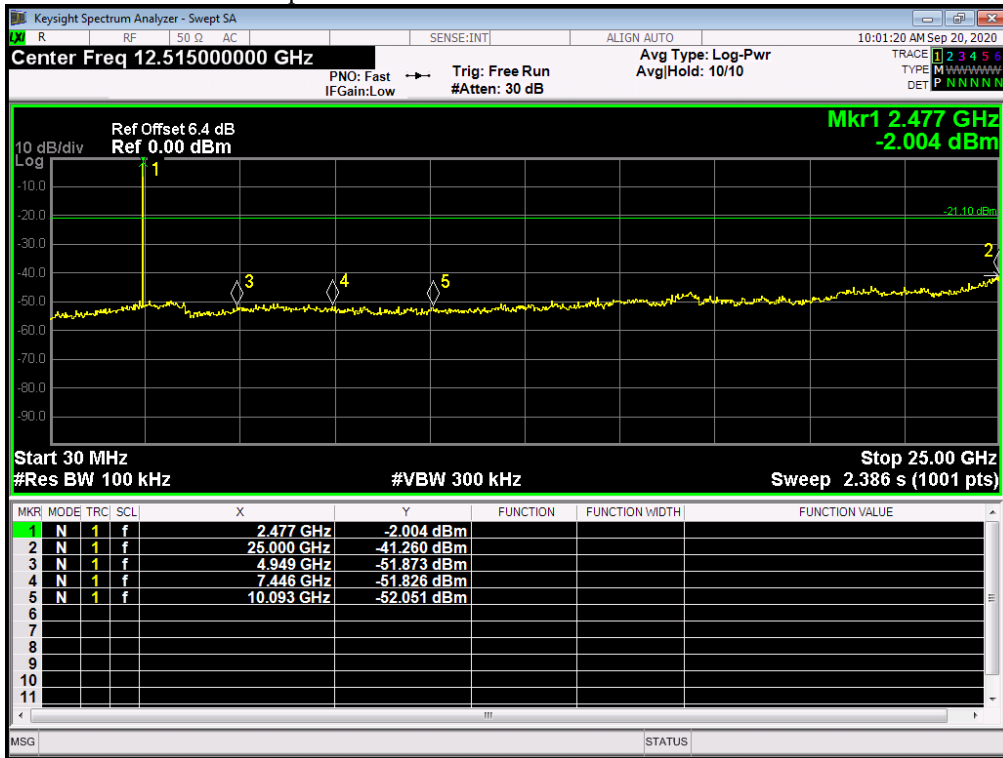

9. Conducted Output Power Spectral Density

9.1. Test equipment

Item	Equipment	Manufacturer	Model No.	Serial No.	Last Cal.	Cal. Interval
1	MXA Signal Analyzer	KEYSIGHT	N9020A	MY5451047 6	2020/05/25	1 Year

9.2. Block diagram of test setup

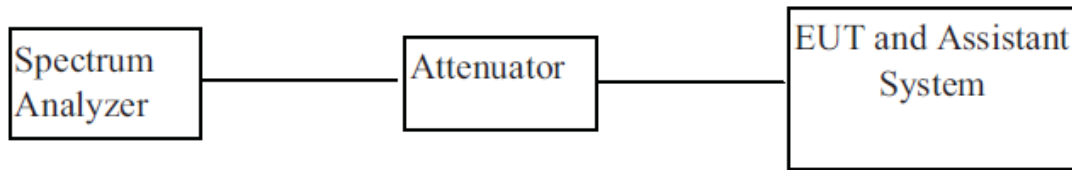

9.3. Limit

For digitally modulated systems, the power spectral density conducted from the intentional radiator to the antenna shall not be greater than 8 dBm in any 3 kHz band during any time interval of continuous transmission.

9.4. Test Procedure

- (1). Connect EUT RF output port to the Spectrum Analyzer through an RF attenuator
- (2). Set the EUT Work on the top, the middle and the bottom operation frequency individually.
- (3). Set SPA Trace 1 Max hold, then View.

9.5. Test result

Condition	Mode	Frequency (MHz)	Antenna	Max PSD (dBm/3kHz)	Limit (dBm/3kHz)	Verdict
NVNT	BLE	2402	Ant 1	-10.75	8	Pass
NVNT	BLE	2440	Ant 1	-12.522	8	Pass
NVNT	BLE	2480	Ant 1	-12.578	8	Pass

PSD NVNT BLE 2402MHz Ant1

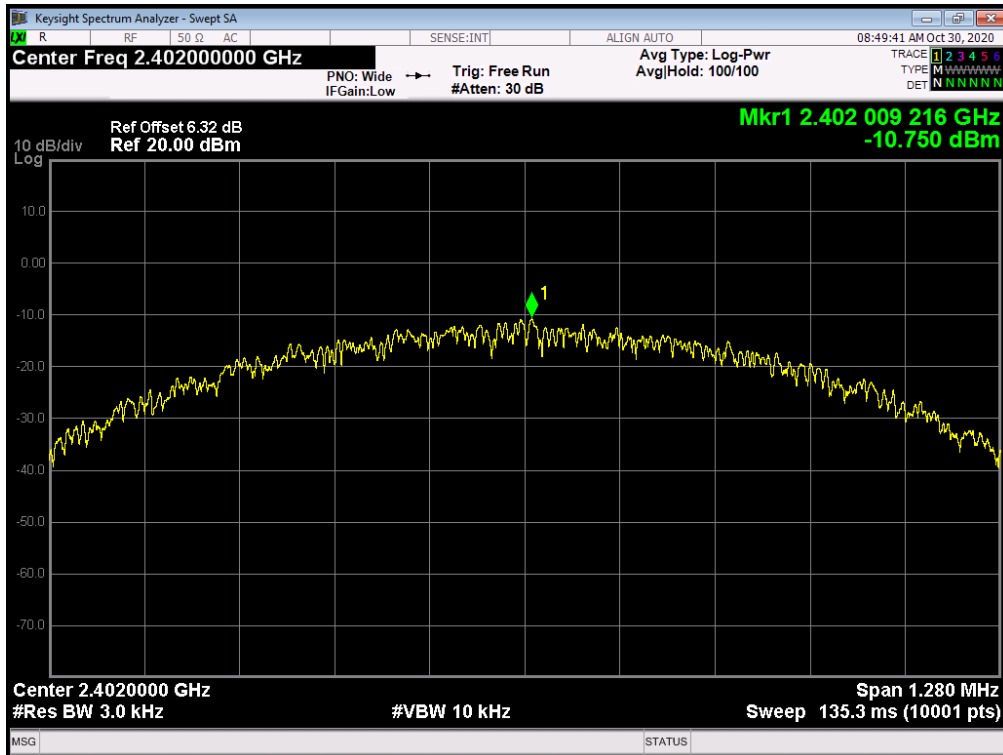

PSD NVNT BLE 2440MHz Ant1

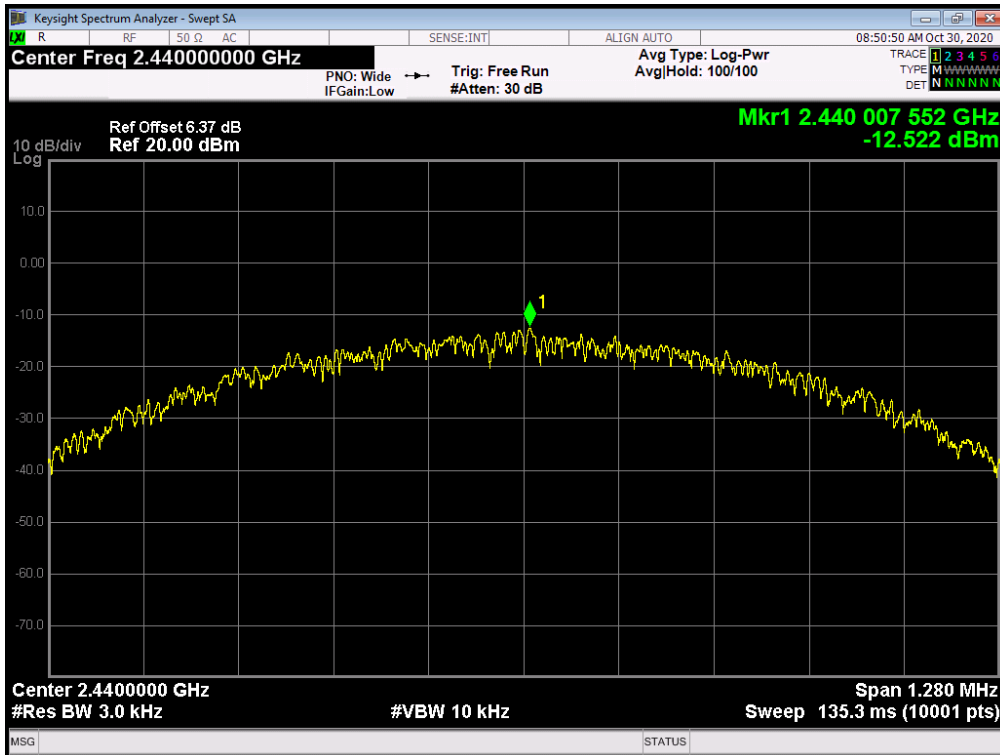

PSD NVNT BLE 2480MHz Ant1

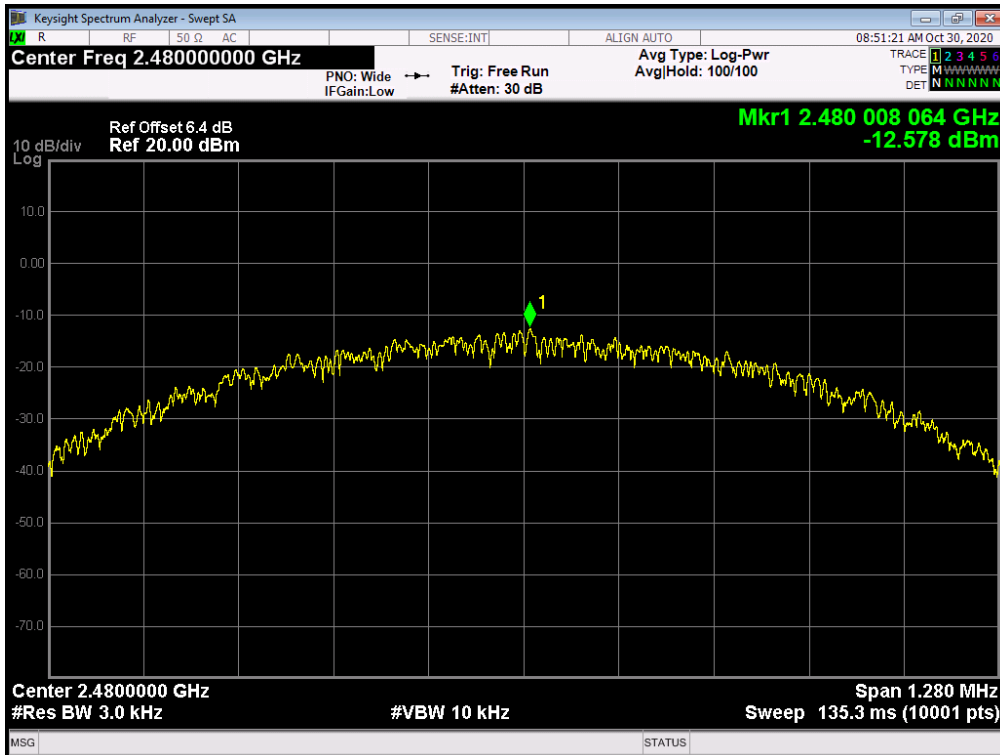

10. Antenna Requirement

10.1. Standard requirement

15.203 requirement: For intentional device, according to 15.203: an intentional radiator shall be designed to ensure that no antenna other than that furnished by the responsible party shall be used with the device.

15.247(c) (1)(i) requirement: (i) Systems operating in the 2400-2483.5 MHz band that is used exclusively for fixed. Point-to-point operations may employ transmitting antennas with directional gain greater than 6dBi provided the maximum conducted output power of the intentional radiator is reduced by 1 dB for every 3 dB that the directional gain of the antenna exceeds 6dBi.

10.2. EUT Antenna

The antenna is Integral Antenna and no consideration of replacement. Antenna gain is Maximum 0 dBi from 2.4GHz to 2.5GHz.

11. Test setup photograph

11.1. Photos of power line conducted emission test



11.2. Photos of radiated emission test

30MHz – 1GHz



Above 1GHz



12. Photos of the EUT

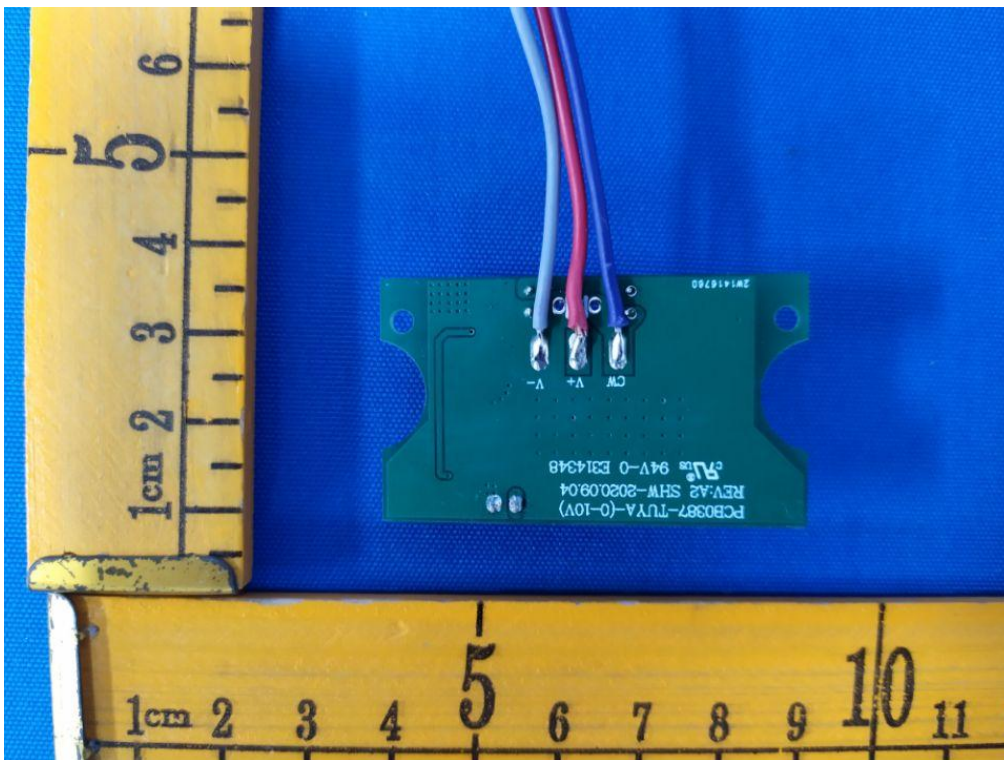
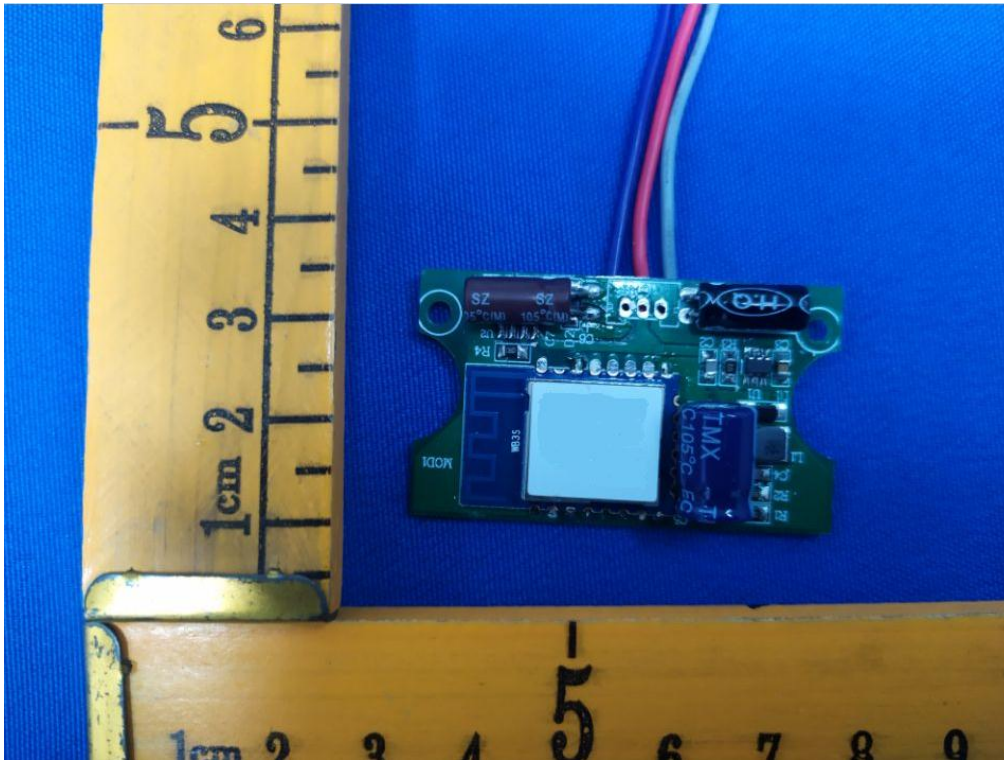

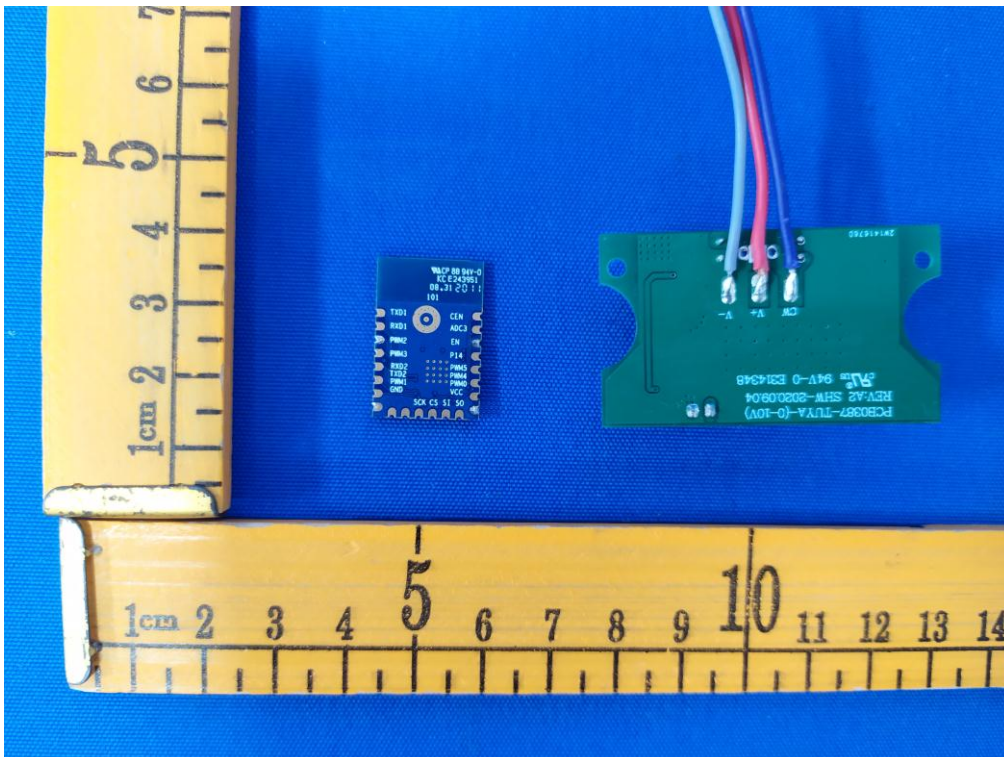
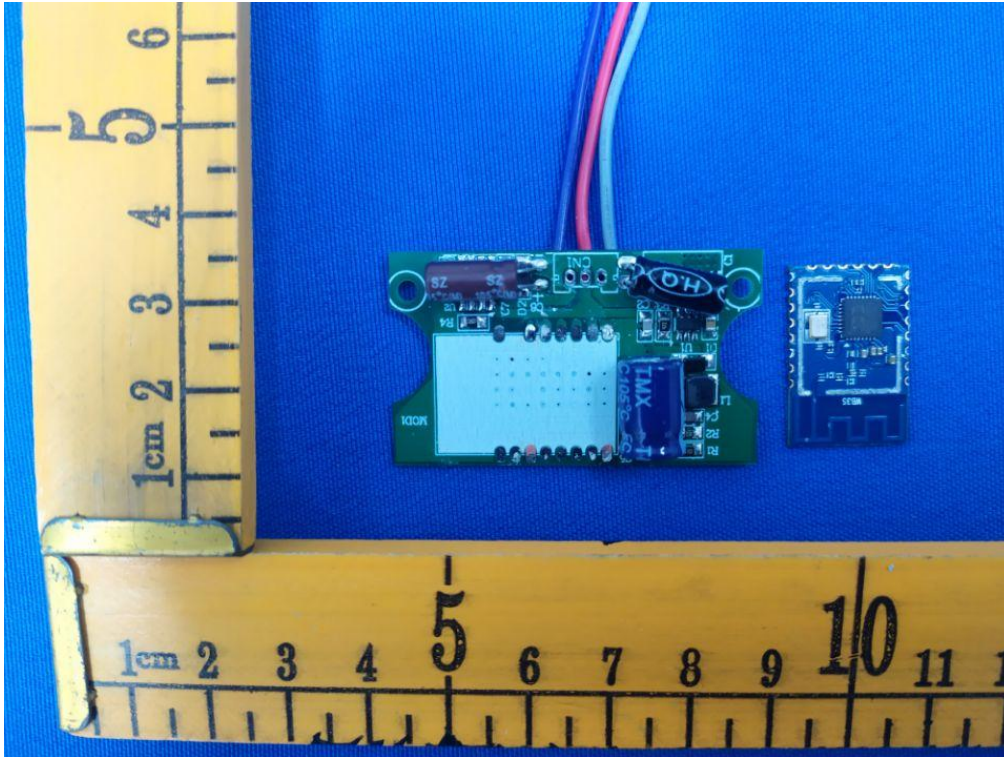

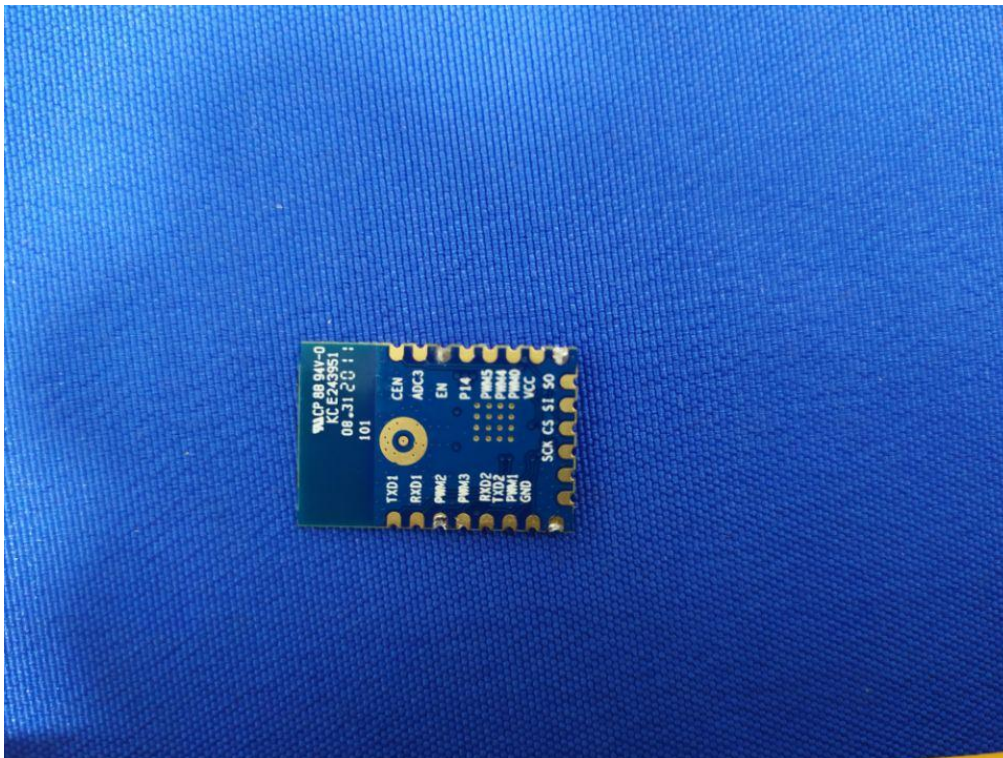
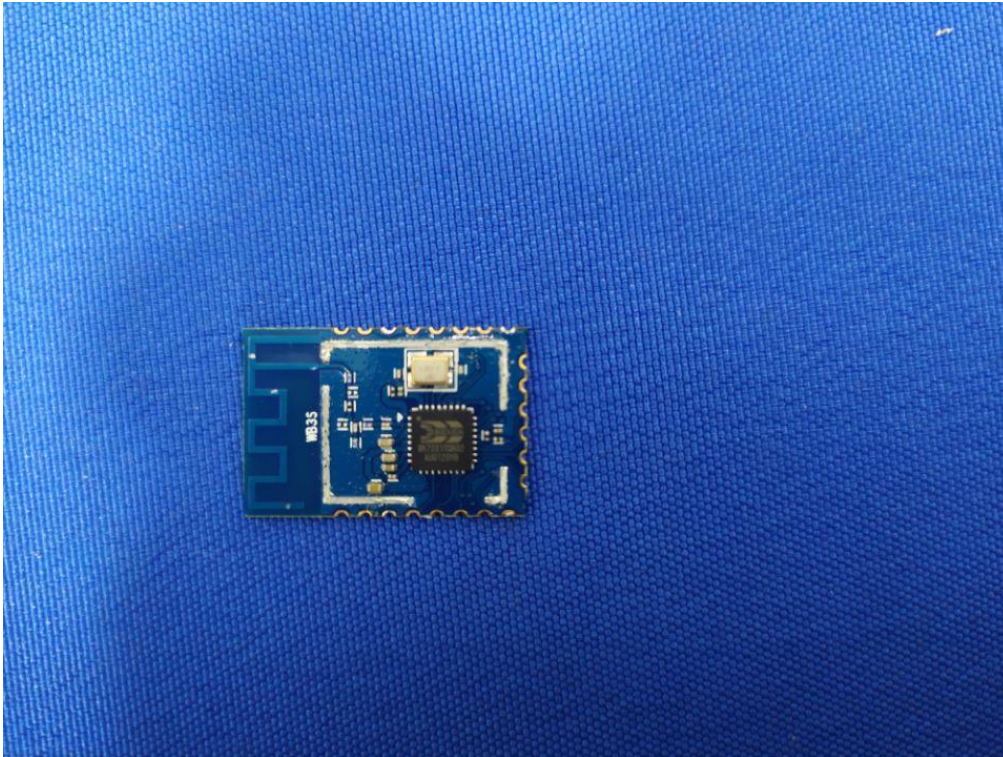

--END OF REPORT--