

FCC Test Report

Report No.: RFBGSN-WTW-P20070580-6

FCC ID: 2AX8C-3544

Test Model: FL44TE

Received Date: Jul. 29, 2020

Test Date: Nov. 07 ~ Nov. 25, 2020

Issued Date: Dec. 01, 2020

Applicant: Amazon.com Services LLC

Address: 410 Terry Ave N Seattle, WA 98109 650 694 8333

Issued By: Bureau Veritas Consumer Products Services (H.K.) Ltd., Taoyuan Branch
Lin Kou Laboratories

Lab Address: No. 47-2, 14th Ling, Chia Pau Vil., Lin Kou Dist., New Taipei City, Taiwan

Test Location: No.19, Hwa Ya 2nd Rd., Wen Hwa Vil., Kwei Shan Dist., Taoyuan City
33383, Taiwan

**FCC Registration /
Designation Number:** 788550 / TW0003



This report is for your exclusive use. Any copying or replication of this report to or for any other person or entity, or use of our name or trademark, is permitted only with our prior written permission. This report sets forth our findings solely with respect to the test samples identified herein. The results set forth in this report are not indicative or representative of the quality or characteristics of the lot from which a test sample was taken or any similar or identical product unless specifically and expressly noted. Our report includes all of the tests requested by you and the results thereof based upon the information that you provided to us. You have 60 days from date of issuance of this report to notify us of any material error or omission caused by our negligence, provided, however, that such notice shall be in writing and shall specifically address the issue you wish to raise. A failure to raise such issue within the prescribed time shall constitute your unqualified acceptance of the completeness of this report, the tests conducted and the correctness of the report contents. Unless specific mention, the uncertainty of measurement has been explicitly taken into account to declare the compliance or non-compliance to the specification.

Table of Contents

Release Control Record	4
1 Certificate of Conformity	5
2 Summary of Test Results	6
2.1 Measurement Uncertainty	7
2.2 Modification Record	7
3 General Information	8
3.1 General Description of EUT	8
3.2 Description of Test Modes	9
3.2.1 Test Mode Applicability and Tested Channel Detail	10
3.3 Duty Cycle of Test Signal	11
3.4 Description of Support Units	12
3.4.1 Configuration of System under Test	12
3.5 General Description of Applied Standards and References	13
4 Test Types and Results	14
4.1 Radiated Emission and Bandedge Measurement	14
4.1.1 Limits of Radiated Emission and Bandedge Measurement	14
4.1.2 Test Instruments	15
4.1.3 Test Procedures	16
4.1.4 Deviation from Test Standard	16
4.1.5 Test Set Up	17
4.1.6 EUT Operating Conditions	18
4.1.7 Test Results	19
4.2 Conducted Emission Measurement	27
4.2.1 Limits of Conducted Emission Measurement	27
4.2.2 Test Instruments	27
4.2.3 Test Procedures	28
4.2.4 Deviation from Test Standard	28
4.2.5 Test Setup	28
4.2.6 EUT Operating Condition	28
4.2.7 Test Results	29
4.3 Number of Hopping Frequency Used	31
4.3.1 Limits of Hopping Frequency Used Measurement	31
4.3.2 Test Setup	31
4.3.3 Test Instruments	31
4.3.4 Test Procedure	31
4.3.5 Deviation from Test Standard	31
4.3.6 Test Results	32
4.4 Dwell Time on Each Channel	33
4.4.1 Limits of Dwell Time on Each Channel Measurement	33
4.4.2 Test Setup	33
4.4.3 Test Instruments	33
4.4.4 Test Procedures	33
4.4.5 Deviation from Test Standard	33
4.4.6 Test Results	34
4.5 Channel Bandwidth	36
4.5.1 Limits of Channel Bandwidth Measurement	36
4.5.2 Test Setup	36
4.5.3 Test Instruments	36
4.5.4 Test Procedure	36
4.5.5 Deviation from Test Standard	36
4.5.6 EUT Operating Condition	36
4.5.7 Test Results	37
4.6 Occupied Bandwidth Measurement	38

4.6.1	Test Setup	38
4.6.2	Test Instruments	38
4.6.3	Test Procedure	38
4.6.4	Deviation from Test Standard	38
4.6.5	EUT Operating Conditions	38
4.6.6	Test Results	39
4.7	Hopping Channel Separation	40
4.7.1	Limits of Hopping Channel Separation Measurement	40
4.7.2	Test Setup	40
4.7.3	Test Instruments	40
4.7.4	Test Procedure	40
4.7.5	Deviation from Test Standard	40
4.7.6	Test Results	41
4.8	Maximum Output Power	42
4.8.1	Limits of Maximum Output Power Measurement	42
4.8.2	Test Setup	42
4.8.3	Test Instruments	42
4.8.4	Test Procedure	42
4.8.5	Deviation from Test Standard	42
4.8.6	EUT Operating Condition	42
4.8.7	Test Results	43
4.9	Conducted Out of Band Emission Measurement	44
4.9.1	Limits Of Conducted Out of Band Emission Measurement	44
4.9.2	Test Instruments	44
4.9.3	Test Procedure	44
4.9.4	Deviation from Test Standard	44
4.9.5	EUT Operating Condition	44
4.9.6	Test Results	44
5	Pictures of Test Arrangements	49
	Annex A- Band Edge Measurement	50
	Appendix – Information of the Testing Laboratories	52

Release Control Record

Issue No.	Description	Date Issued
RFBGSN-WTW-P20070580-6	Original Release	Dec. 01, 2020

1 Certificate of Conformity

Product: Fleet Edge

Brand: N/A

Test Model: FL44TE

Sample Status: Engineering Sample

Applicant: Amazon.com Services LLC

Test Date: Nov. 07 ~ Nov. 25, 2020

Standards: 47 CFR FCC Part 15, Subpart C (Section 15.247)
ANSI C63.10:2013

The above equipment has been tested by **Bureau Veritas Consumer Products Services (H.K.) Ltd., Taoyuan Branch**, and found compliance with the requirement of the above standards. The test record, data evaluation & Equipment Under Test (EUT) configurations represented herein are true and accurate accounts of the measurements of the sample's RF characteristics under the conditions specified in this report.

Prepared by : , **Date:** Dec. 01, 2020
Gina Liu / Specialist

Approved by : , **Date:** Dec. 01, 2020
Dylan Chiou / Senior Project Engineer

2 Summary of Test Results

47 CFR FCC Part 15, Subpart C (Section 15.247)			
FCC Clause	Test Item	Result	Remarks
15.207	AC Power Conducted Emission	Pass	Meet the requirement of limit. Minimum passing margin is -13.29 dB at 11.97 MHz.
15.247(a)(1)(iii)	Number of Hopping Frequency Used	Pass	Meet the requirement of limit.
15.247(a)(1)(iii)	Dwell Time on Each Channel	Pass	Meet the requirement of limit.
15.247(a)(1)	1. Hopping Channel Separation 2. Spectrum Bandwidth of a Frequency Hopping Sequence Spread Spectrum System	Pass	Meet the requirement of limit.
15.247(a)(1)	Maximum Peak Output Power	Pass	Meet the requirement of limit.
---	Occupied Bandwidth Measurement	Pass	Reference only
15.205 & 209	Radiated Emissions	Pass	Meet the requirement of limit. Minimum passing margin is -3.44 dB at 713.85 MHz.
15.247(d)	Band Edge Measurement	Pass	Meet the requirement of limit.
15.247(d)	Antenna Port Emission	Pass	Meet the requirement of limit.
15.203	Antenna Requirement	Pass	No antenna connector is used.

Note:

1. If the Frequency Hopping System operating in 2400-2483.5 MHz band and the output power less than 125 mW. The hopping channel carrier frequencies separated by a minimum of 25 kHz or two-thirds of the 20 dB bandwidth of hopping channel whichever is greater.
2. For 2.4G band compliance with rule 15.247(d) of the band-edge items, the test plots were recorded in Annex A. Test Procedures refer to report 4.1.3.
3. Determining compliance based on the results of the compliance measurement, not taking into account measurement instrumentation uncertainty.

2.1 Measurement Uncertainty

Where relevant, the following measurement uncertainty levels have been estimated for tests performed on the EUT as specified in CISPR 16-4-2:

Measurement	Frequency	Expanded Uncertainty (k=2) (\pm)
Conducted Emissions at mains ports	150 kHz ~ 30 MHz	2.79 dB
Radiated Emissions up to 1 GHz	9 kHz ~ 30 MHz	3.04 dB
	30 MHz ~ 200 MHz	2.93 dB
	200 MHz ~ 1000 MHz	2.95 dB
Radiated Emissions above 1 GHz	1 GHz ~ 18 GHz	2.26 dB
	18 GHz ~ 40 GHz	1.94 dB

2.2 Modification Record

There were no modifications required for compliance.

3 General Information

3.1 General Description of EUT

Product	Fleet Edge
Brand	N/A
Test Model	FL44TE
Status of EUT	Engineering Sample
Power Supply Rating	12 Vdc
Modulation Type	GFSK, $\pi/4$ -DQPSK, 8DPSK
Transfer Rate	1/2/3 Mbps
Operating Frequency	2402 ~ 2480 MHz
Number of Channel	79
Output Power	9.954 mW
Antenna Type	Refer to Note as below
Antenna Connector	N/A
Accessory Device	Refer to Note as below
Data Cable Supplied	N/A

Note:

1. The EUT contains following accessory devices.

Product	Brand	Model	Description
BT/WLAN Module	Intel	9560NGW	802.11 a/b/g/n/ac Wireless LAN + Bluetooth 5
WWAN Module	Quectel	EM06-A	WCDMA, LTE

2. The antenna information is listed as below.

Antenna information				Peak gain w/ cable loss (dBi)			
Brand	Type	Antenna Part number	Ant.	BT/WLAN 2.4 GHz	WLAN 5.15~5.35 GHz	WLAN 5.47~5.725 GHz	WLAN 5.725~5.85 GHz
TAOGLAS	Multiband	MA491.A.BICG.005.gb	0	-1.85	-4.8	-4.8	-4.8
			1	-3.05	-3.5	-3.5	-3.5

3. The above Antenna information is declared by manufacturer and for more detailed features description, please refer to the manufacturer's specifications, the laboratory shall not be held responsible.

4. The above EUT information is declared by manufacturer and for more detailed features description, please refers to the manufacturer's specifications or User's Manual.

3.2 Description of Test Modes

79 channels are provided to this EUT:

Channel	Freq. (MHz)	Channel	Freq. (MHz)	Channel	Freq. (MHz)	Channel	Freq. (MHz)
0	2402	20	2422	40	2442	60	2462
1	2403	21	2423	41	2443	61	2463
2	2404	22	2424	42	2444	62	2464
3	2405	23	2425	43	2445	63	2465
4	2406	24	2426	44	2446	64	2466
5	2407	25	2427	45	2447	65	2467
6	2408	26	2428	46	2448	66	2468
7	2409	27	2429	47	2449	67	2469
8	2410	28	2430	48	2450	68	2470
9	2411	29	2431	49	2451	69	2471
10	2412	30	2432	50	2452	70	2472
11	2413	31	2433	51	2453	71	2473
12	2414	32	2434	52	2454	72	2474
13	2415	33	2435	53	2455	73	2475
14	2416	34	2436	54	2456	74	2476
15	2417	35	2437	55	2457	75	2477
16	2418	36	2438	56	2458	76	2478
17	2419	37	2439	57	2459	77	2479
18	2420	38	2440	58	2460	78	2480
19	2421	39	2441	59	2461		

3.2.1 Test Mode Applicability and Tested Channel Detail

EUT Configure Mode	Applicable To				Description
	RE \geq 1G	RE $<$ 1G	PLC	APCM	
-	√	√	√	√	-

Where **RE \geq 1G**: Radiated Emission above 1 GHz **RE $<$ 1G**: Radiated Emission below 1 GHz
PLC: Power Line Conducted Emission **APCM**: Antenna Port Conducted Measurement

Note:

1. For Radiated emission test, pre-tested GFSK, $\pi/4$ -DQPSK, 8DPSK modulation type and found GFSK was the worse, therefore chosen for the final test and presented in the test report.
2. The EUT had been pre-tested on the positioned of each 3 axis. The worst case was found when positioned on **Z-plane**.
3. For radiated emission (below 1GHz) and power line conducted emission test items, the worst radiated emission mode was selected.
4. "-" means no effect.

Radiated Emission Test (Above 1 GHz):

- Pre-Scan has been conducted to determine the worst-case mode from all possible combinations between available modulations, data rates and antenna ports (if EUT with antenna diversity architecture).
- Following channel(s) was (were) selected for the final test as listed below.

EUT Configure Mode	Available Channel	Tested Channel	Modulation Technology	Modulation Type	Packet Type
-	0 to 78	0, 39, 78	FHSS	GFSK	DH5
	0 to 78	0, 39, 78	FHSS	8DPSK	3DH5

Radiated Emission Test (Below 1 GHz):

- Pre-Scan has been conducted to determine the worst-case mode from all possible combinations between available modulations, data rates and antenna ports (if EUT with antenna diversity architecture).
- Following channel(s) was (were) selected for the final test as listed below.

EUT Configure Mode	Available Channel	Tested Channel	Modulation Technology	Modulation Type	Packet Type
-	0 to 78	0	FHSS	GFSK	DH5

Power Line Conducted Emission Test:

- Pre-Scan has been conducted to determine the worst-case mode from all possible combinations between available modulations, data rates and antenna ports (if EUT with antenna diversity architecture).
- Following channel(s) was (were) selected for the final test as listed below.

EUT Configure Mode	Available Channel	Tested Channel	Modulation Technology	Modulation Type	Packet Type
-	0 to 78	0	FHSS	GFSK	DH5

Antenna Port Conducted Measurement:

- This item includes all test value of each mode, but only includes spectrum plot of worst value of each mode.
- Pre-Scan has been conducted to determine the worst-case mode from all possible combinations between available modulations, data rates and antenna ports (if EUT with antenna diversity architecture).
- Following channel(s) was (were) selected for the final test as listed below.

EUT Configure Mode	Available Channel	Tested Channel	Modulation Technology	Modulation Type	Packet Type
-	0 to 78	0, 39, 78	FHSS	GFSK	DH5
-	0 to 78	0, 39, 78	FHSS	8DPSK	3DH5

Test Condition:

Applicable To	Environmental Conditions	Input Power	Tested by
RE≥1G	25 deg. C, 65 % RH	120 Vac, 60 Hz	Tim Chen
RE<1G	25 deg. C, 65 % RH	120 Vac, 60 Hz	Cyril Chen
PLC	24 deg. C, 67 % RH	120 Vac, 60 Hz	Tim Chen
APCM	25 deg. C, 60 % RH	120 Vac, 60 Hz	Gavin Wu

3.3 Duty Cycle of Test Signal

Duty Cycle = (2.908) / 100 = 0.02908, Duty Cycle Correction Factor = 20*log (0.02908) = -30.73

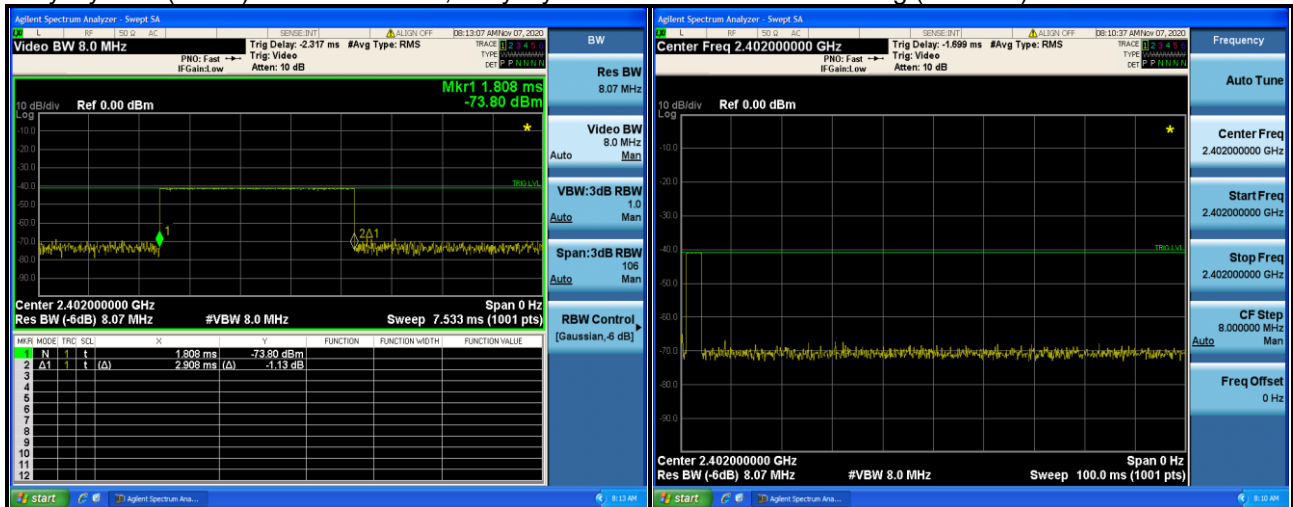

3.4 Description of Support Units

The EUT has been tested as an independent unit together with other necessary accessories or support units. The following support units or accessories were used to form a representative test configuration during the tests.

ID	Product	Brand	Model No.	Serial No.	FCC ID	Remarks
A	Keyboard	DELL	RT7D50	CN-0J4624-37172-44T-000M	FCC DOC Approved	--
B	Mouse	DELL	MS111-L	N/A	N/A	--
C	Monitor	ViewSonic	VX2457-MHD	UG0182942333	N/A	--
D	Bluetooth Tester	R&S	CBT	100980	N/A	--
E	Power Supply	NA	NA	NA	NA	--
F	WLAN&WWAN Antenna	TAOGLAS	MA491.A.BICG.005.gb	NA	NA	Provided by client
G	GPS Antenna	NA	NA	NA	NA	Provided by client

Note:

1. All power cords of the above support units are non-shielded (1.8m).
2. Item D acted as a communication partner to transfer data.

ID	Descriptions	Qty.	Length (m)	Shielding (Yes/No)	Cores (Qty.)	Remarks
1.	HDMI Cable	1	2	N	0	-
2.	RF Cable	1	0.5	N	0	-
3.	RF Cable	1	0.5	N	0	-
4.	RF Cable	1	0.5	N	0	-
5.	USB Cable	1	2.4	N	0	-
6.	USB Cable	1	2.2	N	0	-
7.	DC power Cable	1	1.2	N	0	-
8.	Power cord	1	1.8	N	0	-

3.4.1 Configuration of System under Test

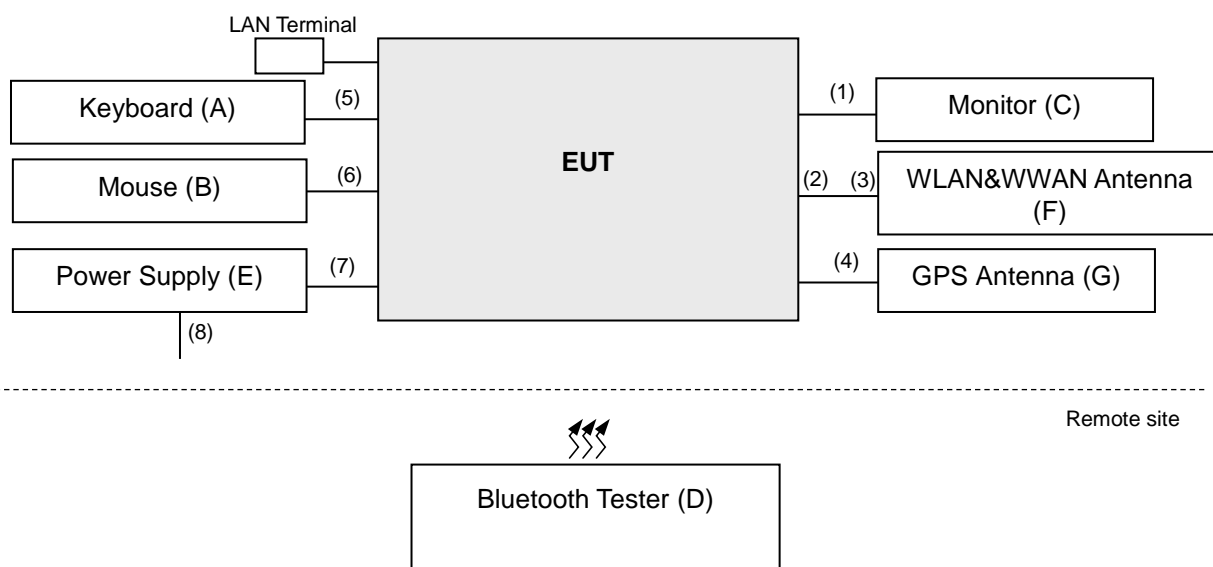

3.5 General Description of Applied Standards and References

The EUT is a RF Product. According to the specifications of the manufacturer, it must comply with the requirements of the following standards and references:

Test Standard:

FCC Part 15, Subpart C (15.247)

ANSI C63.10-2013

All test items have been performed and recorded as per the above standards.

References Test Guidance:

KDB 558074 D01 15.247 Meas Guidance v05r02

All test items have been performed as a reference to the above KDB test guidance.

4 Test Types and Results

4.1 Radiated Emission and Bandedge Measurement

4.1.1 Limits of Radiated Emission and Bandedge Measurement

Radiated emissions which fall in the restricted bands must comply with the radiated emission limits specified as below table. Other emissions shall be at least 20 dB below the highest level of the desired power:

Frequencies (MHz)	Field Strength (microvolts/meter)	Measurement Distance (meters)
0.009 ~ 0.490	2400/F (kHz)	300
0.490 ~ 1.705	24000/F (kHz)	30
1.705 ~ 30.0	30	30
30 ~ 88	100	3
88 ~ 216	150	3
216 ~ 960	200	3
Above 960	500	3

Note:

- a. The lower limit shall apply at the transition frequencies.
- b. Emission level (dBuV/m) = 20 log Emission level (uV/m).
- c. For frequencies above 1000 MHz, the field strength limits are based on average detector, however, the peak field strength of any emission shall not exceed the maximum permitted average limits, specified above by more than 20 dB under any condition of modulation.

4.1.2 Test Instruments

Description & Manufacturer	Model No.	Serial No.	Date of Calibration	Due Date of Calibration
Test Receiver Agilent	N9038A	MY51210203	Mar. 18, 2020	Mar. 17, 2021
Spectrum Analyzer Agilent	N9010A	MY52220314	Dec. 12, 2019	Dec. 11, 2020
Spectrum Analyzer ROHDE & SCHWARZ	FSU43	101261	Apr. 16, 2020	Apr. 15, 2021
Spectrum Analyzer ROHDE & SCHWARZ	FSV40	100980	Apr. 20, 2020	Apr. 19, 2021
HORN Antenna SCHWARZBECK	BBHA 9120D	9120D-969	Nov. 24, 2019	Nov. 23, 2020
			Nov. 22, 2020	Nov. 21, 2021
BILOG Antenna SCHWARZBECK	VULB 9168	9168-472	Nov. 06, 2020	Nov. 05, 2021
Fixed Attenuator WOKEN	MDCS18N-10	MDCS18N-10-01	Apr. 14, 2020	Apr. 13, 2021
Loop Antenna	EM-6879	269	Sep. 17, 2020	Sep. 16, 2021
Preamplifier EMCI	EMC001340	980201	Oct. 21, 2020	Oct. 20, 2021
Bluetooth Tester	CBT	100946	Aug. 06, 2020	Aug. 05, 2022
Preamplifier EMCI	EMC 012645	980115	Oct. 07, 2020	Oct. 06, 2021
Preamplifier EMCI	EMC 184045	980116	Oct. 07, 2020	Oct. 06, 2021
Preamplifier EMCI	EMC 330H	980112	Oct. 07, 2020	Oct. 06, 2021
Power Meter Anritsu	ML2495A	1012010	Sep. 01, 2020	Aug. 31, 2021
Power Sensor Anritsu	MA2411B	1315050	Sep. 01, 2020	Aug. 31, 2021
RF Coaxial Cable EMCI	EMC104-SM-SM-80 00	171005	Oct. 07, 2020	Oct. 06, 2021
RF Coaxial Cable HUBER+SUHNNER	SUCOFLEX 104	EMC104-SM-SM-10 00(140807)	Oct. 07, 2020	Oct. 06, 2021
RF Coaxial Cable WOKEN	8D-FB	Cable-Ch10-01	Oct. 07, 2020	Oct. 06, 2021
Boresight Antenna Fixture	FBA-01	FBA-SIP01	NA	NA
Software BV ADT	E3 6.120103	NA	NA	NA
Antenna Tower MF	MFA-440H	NA	NA	NA
Turn Table MF	MFT-201SS	NA	NA	NA
Antenna Tower & Turn Table Controller MF	MF-7802	NA	NA	NA
USB Wideband Power Sensor KEYSIGHT	U2021XA	MY55050005/MY551 90004/MY55190007/ MY55210005	Jul. 13, 2020	Jul. 12, 2021

Note: 1. The calibration interval of the above test instruments is 12 / 24 months and the calibrations are traceable to NML/ROC and NIST/USA.

2. The test was performed in HwaYa Chamber 10.

4.1.3 Test Procedures

For Radiated Emission below 30 MHz

- a. The EUT was placed on the top of a rotating table 0.8 meters above the ground at a 3 meter chamber room. The table was rotated 360 degrees to determine the position of the highest radiation.
- b. The EUT was set 3 meters away from the interference-receiving antenna, which was mounted on the top of a variable-height antenna tower.
- c. Parallel, perpendicular, and ground-parallel orientations of the antenna are set to make the measurement.
- d. For each suspected emission, the EUT was arranged to its worst case and the rotatable table was turned from 0 degrees to 360 degrees to find the maximum reading.
- e. The test-receiver system was set to Quasi-Peak Detect Function and Specified Bandwidth with Maximum Hold Mode.

Note:

1. The resolution bandwidth and video bandwidth of test receiver/spectrum analyzer is 9 kHz at frequency below 30 MHz.

For Radiated Emission above 30 MHz

- a. The EUT was placed on the top of a rotating table 0.8 meters (for 30 MHz ~ 1 GHz) / 1.5 meters (for above 1 GHz) above the ground at 3 meter chamber room for test. The table was rotated 360 degrees to determine the position of the highest radiation.
- b. The EUT was set 3 meters away from the interference-receiving antenna, which was mounted on the top of a variable-height antenna tower.
- c. The height of antenna is varied from one meter to four meters above the ground to determine the maximum value of the field strength. Both horizontal and vertical polarizations of the antenna are set to make the measurement.
- d. For each suspected emission, the EUT was arranged to its worst case and then the antenna was tuned to heights from 1 meter to 4 meters and the rotatable table was turned from 0 degrees to 360 degrees to find the maximum reading.
- e. The test-receiver system was set to quasi-peak detect function and specified bandwidth with maximum hold mode when the test frequency is below 1 GHz.
- f. The test-receiver system was set to peak and average detected function and specified bandwidth with maximum hold mode when the test frequency is above 1 GHz. If the peak reading value also meets average limit, measurement with the average detector is unnecessary.

Note:

1. The resolution bandwidth and video bandwidth of test receiver/spectrum analyzer is 120 kHz for Quasi-peak detection (QP) or Peak detection (PK) at frequency below 1 GHz.
2. The resolution bandwidth of test receiver/spectrum analyzer is 1 MHz and the video bandwidth is 3 MHz for Peak detection (PK) and Average detection (AV) at frequency above 1 GHz. For fundamental and harmonic signal measurement, according to ANSI C63.10 section 7.5, the average value = peak value + duty cycle correction factor. The duty cycle correction factor refer to Chapter 3.3 of this report.
3. All modes of operation were investigated and the worst-case emissions are reported.

4.1.4 Deviation from Test Standard

No deviation.

4.1.5 Test Set Up

<Radiated Emission below 30 MHz>

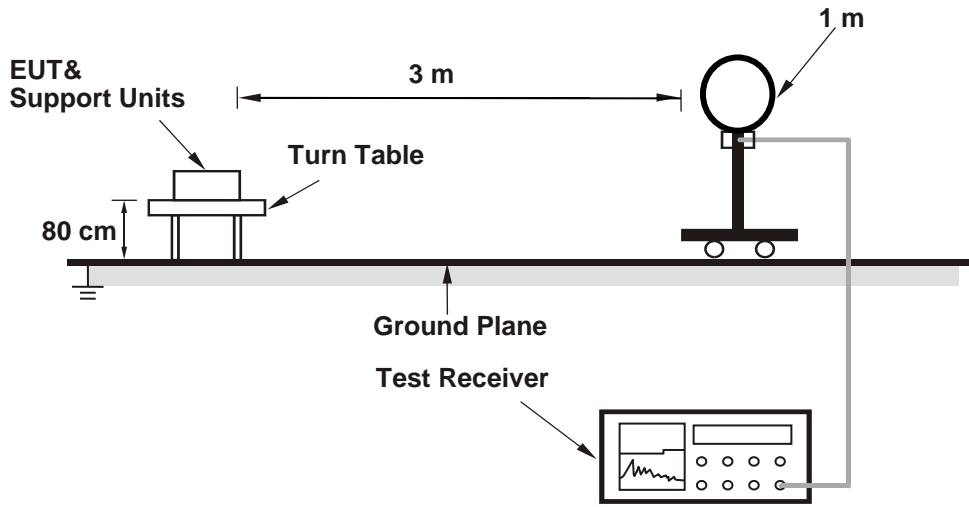

<Radiated Emission 30 MHz to 1 GHz>

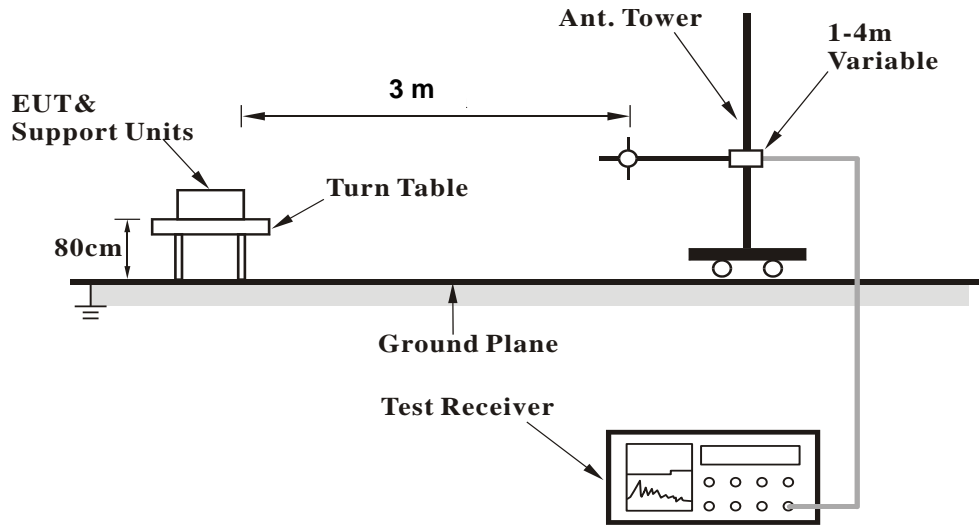

<Radiated Emission above 1 GHz>

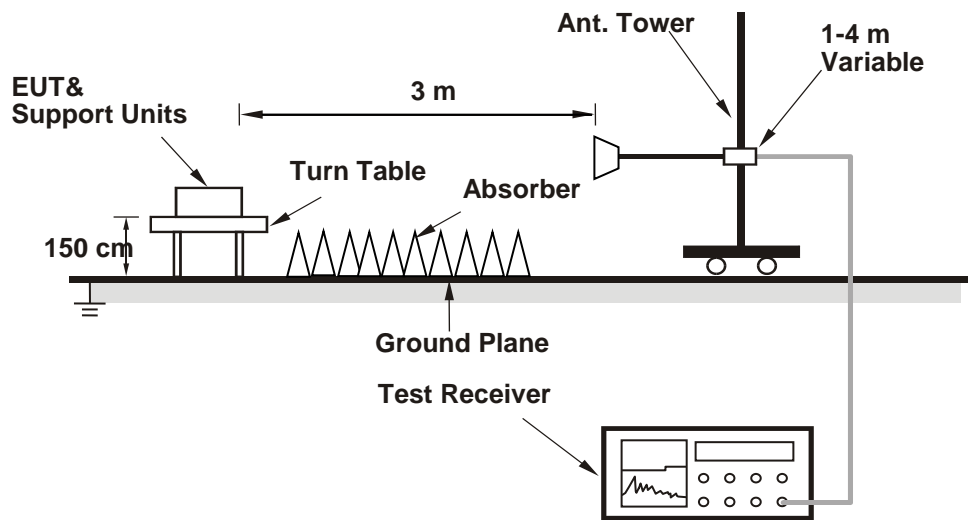

For the actual test configuration, please refer to the attached file (Test Setup Photo).

4.1.6 EUT Operating Conditions

Set the EUT under transmission condition continuously at specific channel frequency.

4.1.7 Test Results

Above 1 GHz Data:
GFSK

EUT Test Condition		Measurement Detail	
Channel	Channel 0	Frequency Range	1 GHz ~ 25 GHz
Input Power	120 Vac, 60 Hz	Detector Function	Peak (PK) Average (AV)
Environmental Conditions	25 deg. C, 65 % RH	Tested By	Tim Chen

Antenna Polarity & Test Distance: Horizontal at 3 m								
Frequency (MHz)	Emission Level (dBuV/m)	Read Level (dBuV)	Factor (dB/m)	Limit (dBuV/m)	Margin (dB)	Antenna Height (cm)	Table Angle (Degree)	Remark
2390	38.42	44.34	-5.92	54	-15.58	104	143	Average
2390	46.82	52.74	-5.92	74	-27.18	104	143	Peak
2402	68.16	74.1	-5.94	-----	-----	104	143	Average
2402	98.89	104.83	-5.94	-----	-----	104	143	Peak
4804	11.69	27.33	-15.64	54	-42.31	162	315	Average
4804	42.42	58.06	-15.64	74	-31.58	162	315	Peak

Antenna Polarity & Test Distance: Vertical at 3 m								
Frequency (MHz)	Emission Level (dBuV/m)	Read Level (dBuV)	Factor (dB/m)	Limit (dBuV/m)	Margin (dB)	Antenna Height (cm)	Table Angle (Degree)	Remark
2390	38.82	44.74	-5.92	54	-15.18	191	169	Average
2390	47.2	53.12	-5.92	74	-26.8	191	169	Peak
2402	66.05	71.99	-5.94	-----	-----	191	169	Average
2402	96.78	102.72	-5.94	-----	-----	191	169	Peak
4804	12.07	27.71	-15.64	54	-41.93	105	137	Average
4804	42.8	58.44	-15.64	74	-31.2	105	137	Peak

Remarks:

- Emission Level = Read Level + Factor
Margin value = Emission level – Limit value
- 2402 MHz: Fundamental frequency.
- The emission levels of other frequencies were very low against the limit.

EUT Test Condition		Measurement Detail	
Channel	Channel 39	Frequency Range	1 GHz ~ 25 GHz
Input Power	120 Vac, 60 Hz	Detector Function	Peak (PK) Average (AV)
Environmental Conditions	25 deg. C, 65 % RH	Tested By	Tim Chen

Antenna Polarity & Test Distance: Horizontal at 3 m								
Frequency (MHz)	Emission Level (dBuV/m)	Read Level (dBuV)	Factor (dB/m)	Limit (dBuV/m)	Margin (dB)	Antenna Height (cm)	Table Angle (Degree)	Remark
2441	67.81	73.62	-5.81	-----	-----	129	158	Average
2441	98.54	104.35	-5.81	-----	-----	129	158	Peak
4882	11.46	27.02	-15.56	54	-42.54	103	68	Average
4882	42.19	57.75	-15.56	74	-31.81	103	68	Peak
Antenna Polarity & Test Distance: Vertical at 3 m								
Frequency (MHz)	Emission Level (dBuV/m)	Read Level (dBuV)	Factor (dB/m)	Limit (dBuV/m)	Margin (dB)	Antenna Height (cm)	Table Angle (Degree)	Remark
2441	63.28	69.09	-5.81	-----	-----	169	178	Average
2441	94.01	99.82	-5.81	-----	-----	169	178	Peak
4882	10.61	26.17	-15.56	54	-43.39	125	166	Average
4882	41.34	56.9	-15.56	74	-32.66	125	166	Peak

Remarks:

- Emission Level = Read Level + Factor
Margin value = Emission level – Limit value
- 2441 MHz: Fundamental frequency.
- The emission levels of other frequencies were very low against the limit.

EUT Test Condition		Measurement Detail	
Channel	Channel 78	Frequency Range	1 GHz ~ 25 GHz
Input Power	120 Vac, 60 Hz	Detector Function	Peak (PK) Average (AV)
Environmental Conditions	25 deg. C, 65 % RH	Tested By	Tim Chen

Antenna Polarity & Test Distance: Horizontal at 3 m								
Frequency (MHz)	Emission Level (dBuV/m)	Read Level (dBuV)	Factor (dB/m)	Limit (dBuV/m)	Margin (dB)	Antenna Height (cm)	Table Angle (Degree)	Remark
2480	70.63	76.33	-5.7	-----	-----	193	159	Average
2480	101.36	107.06	-5.7	-----	-----	193	159	Peak
2483.5	19.76	25.46	-5.7	54	-34.24	193	159	Average
2483.5	50.49	56.19	-5.7	74	-23.51	193	159	Peak
4960	11.62	27.07	-15.45	54	-42.38	137	267	Average
4960	42.35	57.8	-15.45	74	-31.65	137	267	Peak
Antenna Polarity & Test Distance: Vertical at 3 m								
Frequency (MHz)	Emission Level (dBuV/m)	Read Level (dBuV)	Factor (dB/m)	Limit (dBuV/m)	Margin (dB)	Antenna Height (cm)	Table Angle (Degree)	Remark
2480	65.3	71	-5.7	-----	-----	102	217	Average
2480	96.03	101.73	-5.7	-----	-----	102	217	Peak
2483.5	17.11	22.81	-5.7	54	-36.89	102	217	Average
2483.5	47.84	53.54	-5.7	74	-26.16	102	217	Peak
4960	10.66	26.11	-15.45	54	-43.34	102	83	Average
4960	41.39	56.84	-15.45	74	-32.61	102	83	Peak

Remarks:

- Emission Level = Read Level + Factor
Margin value = Emission level – Limit value
- 2480 MHz: Fundamental frequency.
- The emission levels of other frequencies were very low against the limit.

8DPSK

EUT Test Condition		Measurement Detail	
Channel	Channel 0	Frequency Range	1 GHz ~ 25 GHz
Input Power	120 Vac, 60 Hz	Detector Function	Peak (PK) Average (AV)
Environmental Conditions	25 deg. C, 65 % RH	Tested By	Tim Chen

Antenna Polarity & Test Distance: Horizontal at 3 m

Frequency (MHz)	Emission Level (dBuV/m)	Read Level (dBuV)	Factor (dB/m)	Limit (dBuV/m)	Margin (dB)	Antenna Height (cm)	Table Angle (Degree)	Remark
2390	38.56	44.48	-5.92	54	-15.44	107	145	Average
2390	46.45	52.37	-5.92	74	-27.55	107	145	Peak
2402	66.17	72.11	-5.94	-----	-----	107	145	Average
2402	96.9	102.84	-5.94	-----	-----	107	145	Peak
4804	11.19	26.83	-15.64	54	-42.81	121	255	Average
4804	41.92	57.56	-15.64	74	-32.08	121	255	Peak

Antenna Polarity & Test Distance: Vertical at 3 m

Frequency (MHz)	Emission Level (dBuV/m)	Read Level (dBuV)	Factor (dB/m)	Limit (dBuV/m)	Margin (dB)	Antenna Height (cm)	Table Angle (Degree)	Remark
2390	38.36	44.28	-5.92	54	-15.64	189	168	Average
2390	47.13	53.05	-5.92	74	-26.87	189	168	Peak
2402	65.05	70.99	-5.94	-----	-----	189	168	Average
2402	95.78	101.72	-5.94	-----	-----	189	168	Peak
4804	11.22	26.86	-15.64	54	-42.78	121	233	Average
4804	41.95	57.59	-15.64	74	-32.05	121	233	Peak

Remarks:

- Emission Level = Read Level + Factor
Margin value = Emission level – Limit value
- 2402 MHz: Fundamental frequency.
- The emission levels of other frequencies were very low against the limit.

EUT Test Condition		Measurement Detail	
Channel	Channel 39	Frequency Range	1 GHz ~ 25 GHz
Input Power	120 Vac, 60 Hz	Detector Function	Peak (PK) Average (AV)
Environmental Conditions	25 deg. C, 65 % RH	Tested By	Tim Chen

Antenna Polarity & Test Distance: Horizontal at 3 m								
Frequency (MHz)	Emission Level (dBuV/m)	Read Level (dBuV)	Factor (dB/m)	Limit (dBuV/m)	Margin (dB)	Antenna Height (cm)	Table Angle (Degree)	Remark
2441	65.86	71.67	-5.81	-----	-----	168	151	Average
2441	96.59	102.4	-5.81	-----	-----	168	151	Peak
4882	10.77	26.33	-15.56	54	-43.23	123	191	Average
4882	41.5	57.06	-15.56	74	-32.5	123	191	Peak
Antenna Polarity & Test Distance: Vertical at 3 m								
Frequency (MHz)	Emission Level (dBuV/m)	Read Level (dBuV)	Factor (dB/m)	Limit (dBuV/m)	Margin (dB)	Antenna Height (cm)	Table Angle (Degree)	Remark
2441	62.08	67.89	-5.81	-----	-----	162	177	Average
2441	92.81	98.62	-5.81	-----	-----	162	177	Peak
4882	11.45	27.01	-15.56	54	-42.55	156	189	Average
4882	42.18	57.74	-15.56	74	-31.82	156	189	Peak

Remarks:

- Emission Level = Read Level + Factor
Margin value = Emission level – Limit value
- 2441 MHz: Fundamental frequency.
- The emission levels of other frequencies were very low against the limit.

EUT Test Condition		Measurement Detail	
Channel	Channel 78	Frequency Range	1 GHz ~ 25 GHz
Input Power	120 Vac, 60 Hz	Detector Function	Peak (PK) Average (AV)
Environmental Conditions	25 deg. C, 65 % RH	Tested By	Tim Chen

Antenna Polarity & Test Distance: Horizontal at 3 m								
Frequency (MHz)	Emission Level (dBuV/m)	Read Level (dBuV)	Factor (dB/m)	Limit (dBuV/m)	Margin (dB)	Antenna Height (cm)	Table Angle (Degree)	Remark
2480	69.34	75.04	-5.7	-----	-----	189	158	Average
2480	100.07	105.77	-5.7	-----	-----	189	158	Peak
2483.5	22.55	28.25	-5.7	54	-31.45	189	158	Average
2483.5	53.28	58.98	-5.7	74	-20.72	189	158	Peak
4960	11.5	26.95	-15.45	54	-42.5	153	188	Average
4960	42.23	57.68	-15.45	74	-31.77	153	188	Peak
Antenna Polarity & Test Distance: Vertical at 3 m								
Frequency (MHz)	Emission Level (dBuV/m)	Read Level (dBuV)	Factor (dB/m)	Limit (dBuV/m)	Margin (dB)	Antenna Height (cm)	Table Angle (Degree)	Remark
2480	63.33	69.03	-5.7	-----	-----	101	218	Average
2480	94.06	99.76	-5.7	-----	-----	101	218	Peak
2483.5	17.68	23.38	-5.7	54	-36.32	101	218	Average
2483.5	48.41	54.11	-5.7	74	-25.59	101	218	Peak
4960	11.57	27.02	-15.45	54	-42.43	156	189	Average
4960	42.3	57.75	-15.45	74	-31.7	156	189	Peak

Remarks:

- Emission Level = Read Level + Factor
Margin value = Emission level – Limit value
- 2480 MHz: Fundamental frequency.
- The emission levels of other frequencies were very low against the limit.

9 kHz ~ 30 MHz Data:

The amplitude of spurious emissions attenuated more than 20 dB below the permissible value is not required to be report.

30 MHz ~ 1 GHz Worst-Case Data:

EUT Test Condition		Measurement Detail	
Channel	Channel 0	Frequency Range	30 MHz ~ 1 GHz
Input Power	120 Vac, 60 Hz	Detector Function	Peak (PK) Quasi-peak (QP)
Environmental Conditions	25 deg. C, 65 % RH	Tested By	Cyril Chen

Horizontal

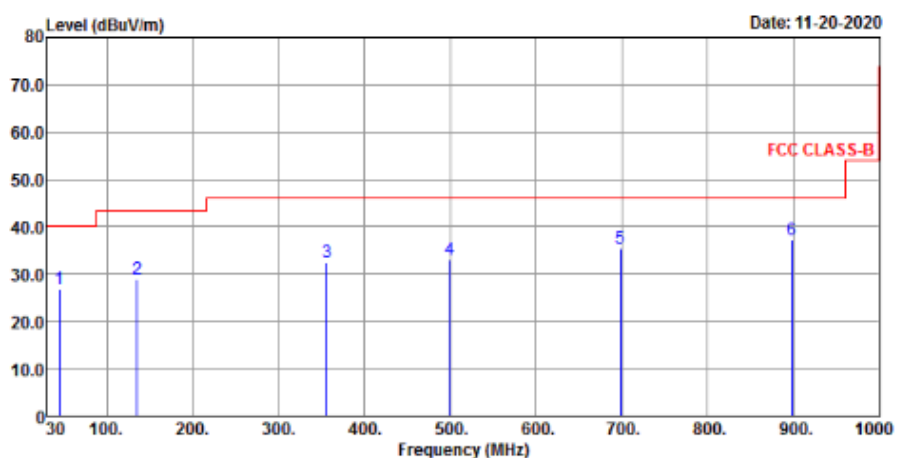

Vertical

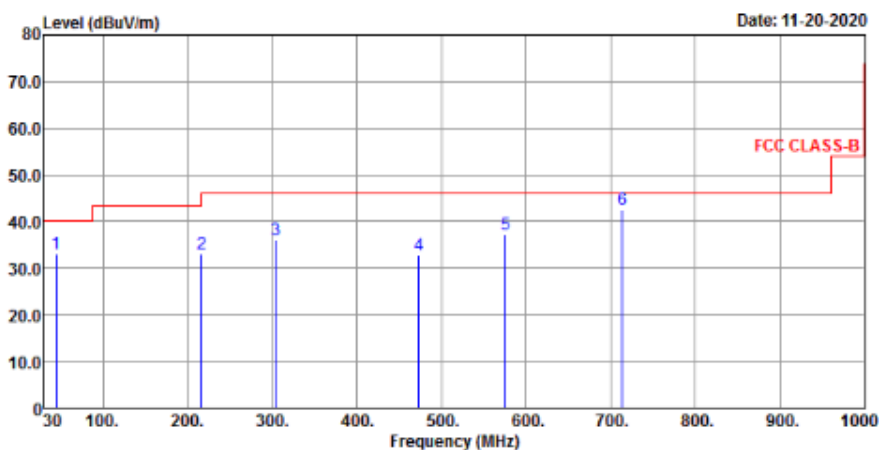

Antenna Polarity & Test Distance: Horizontal at 3 m

Frequency (MHz)	Emission Level (dBuV/m)	Read Level (dBuV)	Factor (dB/m)	Limit (dBuV/m)	Margin (dB)	Antenna Height (cm)	Table Angle (Degree)	Remark
44.55	26.77	38.64	-11.87	40	-13.23	106	108	QP
134.76	28.84	41.34	-12.5	43.5	-14.66	144	237	QP
355.92	32.38	41.94	-9.56	46	-13.62	123	139	QP
499.48	33.06	38.52	-5.46	46	-12.94	157	298	QP
698.33	35.32	35.99	-0.67	46	-10.68	163	258	QP
898.15	37.29	34.34	2.95	46	-8.71	184	236	QP

Antenna Polarity & Test Distance: Vertical at 3 m

Frequency (MHz)	Emission Level (dBuV/m)	Read Level (dBuV)	Factor (dB/m)	Limit (dBuV/m)	Margin (dB)	Antenna Height (cm)	Table Angle (Degree)	Remark
44.55	33.06	44.93	-11.87	40	-6.94	175	198	QP
216.24	32.94	47.91	-14.97	46	-13.06	143	262	QP
304.51	36.06	47.06	-11	46	-9.94	110	90	QP
473.29	32.77	38.7	-5.93	46	-13.23	144	237	QP
575.14	37.07	40.64	-3.57	46	-8.93	159	315	QP
713.85	42.56	42.96	-0.4	46	-3.44	137	258	QP

Remarks:

- Emission Level = Read Level + Factor
Margin value = Emission level – Limit value
- The emission levels of other frequencies were very low against the limit.

4.2 Conducted Emission Measurement

4.2.1 Limits of Conducted Emission Measurement

Frequency (MHz)	Conducted Limit (dBUV)	
	Quasi-Peak	Average
0.15 - 0.5	66 - 56	56 - 46
0.50 - 5.0	56	46
5.0 - 30.0	60	50

Note: 1. The lower limit shall apply at the transition frequencies.
 2. The limit decreases in line with the logarithm of the frequency in the range of 0.15 to 0.50 MHz.

4.2.2 Test Instruments

Description & Manufacturer	Model No.	Serial No.	Date of Calibration	Due Date of Calibration
Test Receiver ROHDE & SCHWARZ	ESCI	100613	Dec. 11, 2019	Dec. 10, 2020
RF signal cable Woken	5D-FB	Cable-cond1-01	Sep. 04, 2020	Sep. 03, 2021
LISN ROHDE & SCHWARZ (EUT)	ENV216	101826	Feb. 20, 2020	Feb. 19, 2021
V-LISN SCHWARZBECK (Peripheral)	NNBL 8226-2	8226-142	Jul. 31, 2020	Jul. 30, 2021
Software ADT	BV ADT_Cond_ V7.3.7.4	NA	NA	NA

Note: 1. The calibration interval of the above test instruments is 12 months and the calibrations are traceable to NML/ROC and NIST/USA.
 2. The test was performed in HwaYa Shielded Room 1. (Conduction 1)
 3. The VCCI Site Registration No. is C-12040.

4.2.3 Test Procedures

- The EUT was placed 0.4 meters from the conducting wall of the shielded room with EUT being connected to the power mains through a line impedance stabilization network (LISN). Other support units were connected to the power mains through another LISN. The two LISNs provide 50 ohm/ 50 uH of coupling impedance for the measuring instrument.
- Both lines of the power mains connected to the EUT were checked for maximum conducted interference.
- The frequency range from 150 kHz to 30 MHz was searched. Emission levels under (Limit – 20 dB) was not recorded.

Note: The resolution bandwidth and video bandwidth of test receiver is 9 kHz for quasi-peak detection (QP) and average detection (AV) at frequency 0.15 MHz - 30 MHz.

4.2.4 Deviation from Test Standard

No deviation.

4.2.5 Test Setup

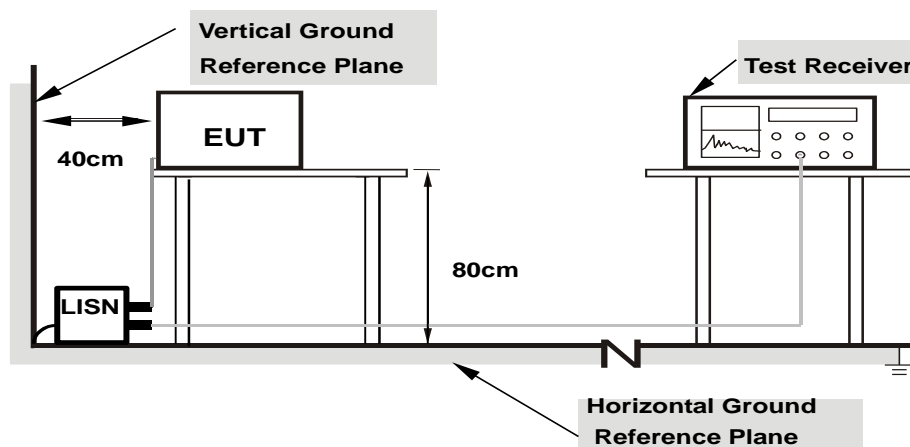

- Note:**
- Support units were connected to second LISN.
 - Both of LISNs (AMN) are 80 cm from EUT and at least 80 cm from other units and other metal planes

For the actual test configuration, please refer to the attached file (Test Setup Photo).

4.2.6 EUT Operating Condition

Set the EUT under transmission condition continuously at specific channel frequency.

4.2.7 Test Results

CONDUCTED WORST-CASE DATA : GFSK

Frequency Range	150kHz ~ 30MHz	Detector Function & Resolution Bandwidth	Quasi-Peak (QP) / Average (AV), 9kHz
Input Power	120Vac, 60Hz	Environmental Conditions	24°C, 67%RH
Tested by	Tim Chen	Test Date	2020/11/21

Phase Of Power : Line (L)										
No	Frequency (MHz)	Correction Factor (dB)	Reading Value (dBuV)		Emission Level (dBuV)		Limit (dBuV)		Margin (dB)	
			Q.P.	AV.	Q.P.	AV.	Q.P.	AV.	Q.P.	AV.
1	0.19728	9.66	28.87	24.60	38.53	34.26	63.72	53.72	-25.19	-19.46
2	0.53000	9.66	20.13	14.12	29.79	23.78	56.00	46.00	-26.21	-22.22
3	1.26200	9.68	16.11	9.91	25.79	19.59	56.00	46.00	-30.21	-26.41
4	4.83800	9.75	23.21	13.76	32.96	23.51	56.00	46.00	-23.04	-22.49
5	11.97000	9.81	31.49	26.90	41.30	36.71	60.00	50.00	-18.70	-13.29
6	17.49800	9.85	31.91	24.92	41.76	34.77	60.00	50.00	-18.24	-15.23

Remarks:

1. Q.P. and AV. are abbreviations of quasi-peak and average individually.
2. The emission levels of other frequencies were very low against the limit.
3. Margin value = Emission level – Limit value
4. Correction factor = Insertion loss + Cable loss
5. Emission Level = Correction Factor + Reading Value

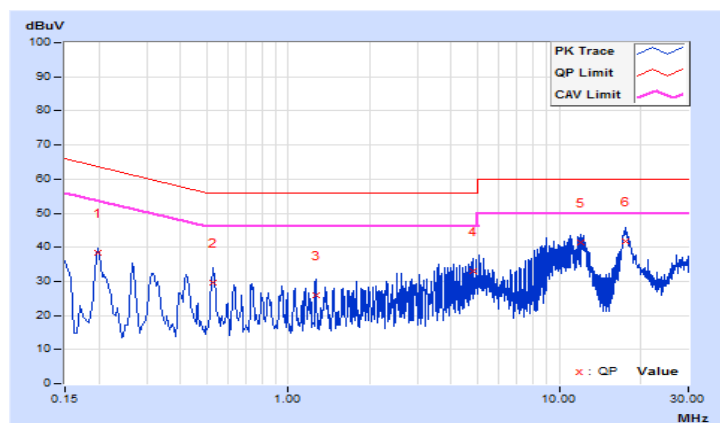

Frequency Range	150kHz ~ 30MHz	Detector Function & Resolution Bandwidth	Quasi-Peak (QP) / Average (AV), 9kHz
Input Power	120Vac, 60Hz	Environmental Conditions	24°C, 67%RH
Tested by	Tim Chen	Test Date	2020/11/21

Phase Of Power : Neutral (N)										
No	Frequency (MHz)	Correction Factor (dB)	Reading Value (dBuV)		Emission Level (dBuV)		Limit (dBuV)		Margin (dB)	
			Q.P.	AV.	Q.P.	AV.	Q.P.	AV.	Q.P.	AV.
1	0.19800	9.68	29.22	25.27	38.90	34.95	63.69	53.69	-24.79	-18.74
2	0.52984	9.68	19.63	13.65	29.31	23.33	56.00	46.00	-26.69	-22.67
3	2.51395	9.74	19.83	15.65	29.57	25.39	56.00	46.00	-26.43	-20.61
4	4.84200	9.78	24.17	19.30	33.95	29.08	56.00	46.00	-22.05	-16.92
5	8.74090	9.82	31.46	26.75	41.28	36.57	60.00	50.00	-18.72	-13.43
6	17.75400	9.96	33.95	26.74	43.91	36.70	60.00	50.00	-16.09	-13.30

Remarks:

1. Q.P. and AV. are abbreviations of quasi-peak and average individually.
2. The emission levels of other frequencies were very low against the limit.
3. Margin value = Emission level – Limit value
4. Correction factor = Insertion loss + Cable loss
5. Emission Level = Correction Factor + Reading Value

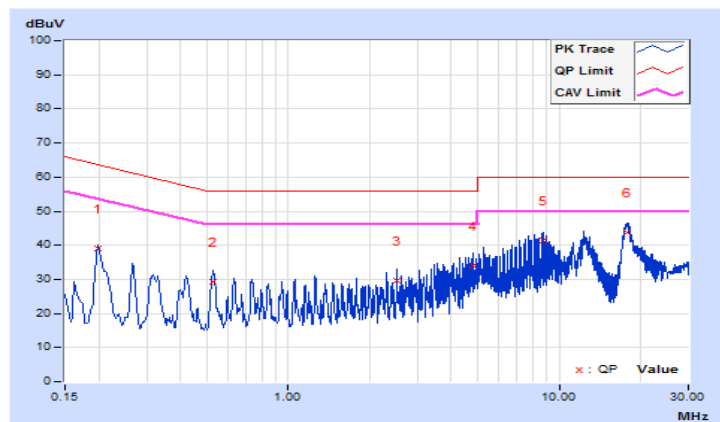

4.3 Number of Hopping Frequency Used

4.3.1 Limits of Hopping Frequency Used Measurement

At least 15 channels frequencies, and should be equally spaced.

4.3.2 Test Setup

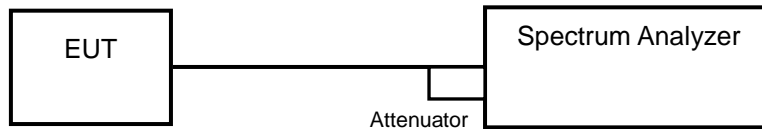

4.3.3 Test Instruments

Refer to section 4.1.2 to get information of above instrument.

4.3.4 Test Procedure

- a. Check the calibration of the measuring instrument (SA) using either an internal calibrator or a known signal from an external generator.
- b. Turn on the EUT and connect its antenna terminal to measurement via a low loss cable. Then set it to any one measured frequency within its operating range and make sure the instrument is operated in its linear range.
- c. Set the SA on MaxHold Mode, and then keep the EUT in hopping mode. Record all the signals from each channel until each one has been recorded.
- d. Set the SA on View mode and then plot the result on SA screen.
- e. Repeat above procedures until all frequencies measured were complete.

4.3.5 Deviation from Test Standard

No deviation.

4.3.6 Test Results

There are 79 hopping frequencies in the hopping mode. Please refer to next page for the test result. On the plots, it shows that the hopping frequencies are equally spaced.

<GFSK>

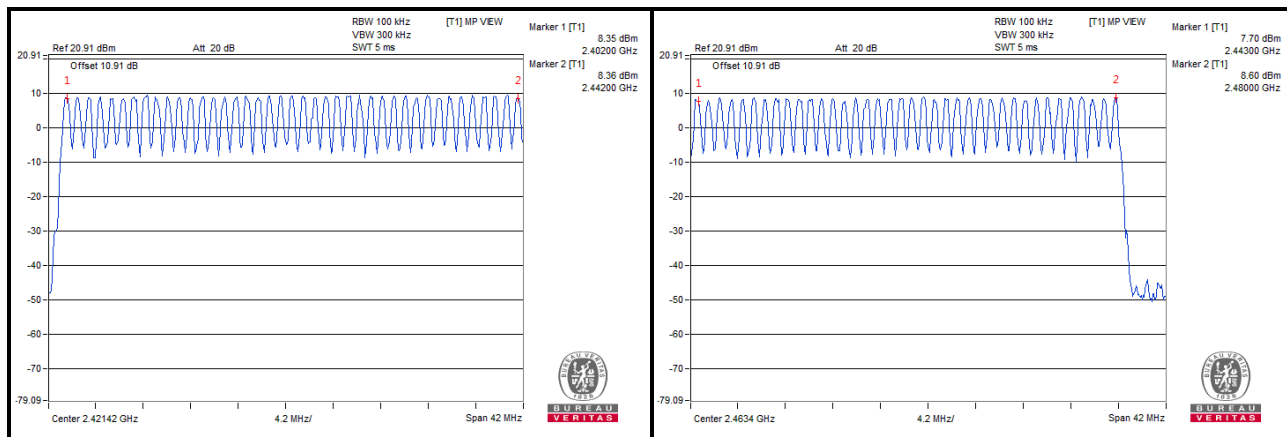

<8DPSK>

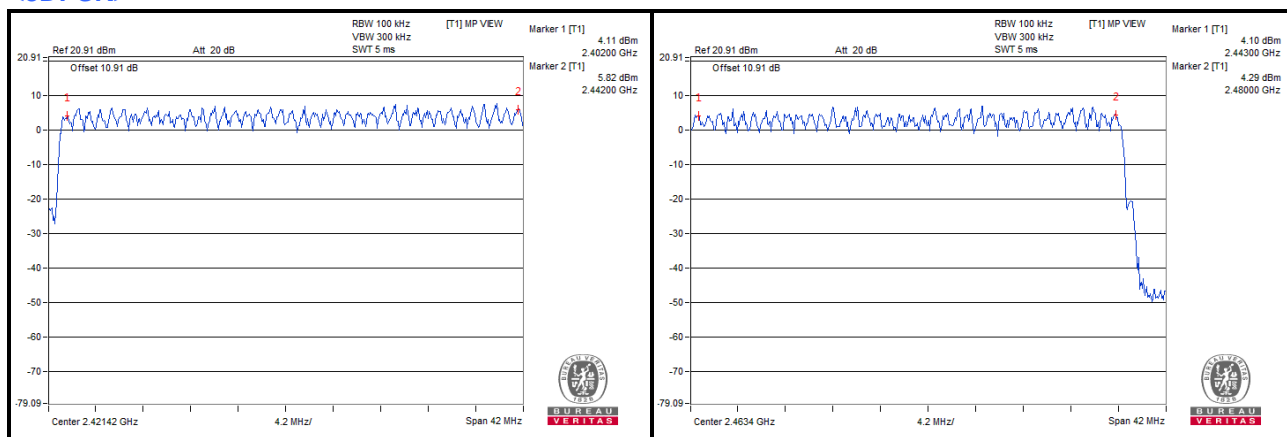

4.4 Dwell Time on Each Channel

4.4.1 Limits of Dwell Time on Each Channel Measurement

The average time of occupancy on any channel shall not be greater than 0.4 seconds within a period of 0.4 seconds multiplied by the number of hopping channels employed.

4.4.2 Test Setup

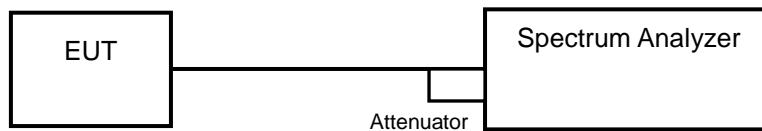

4.4.3 Test Instruments

Refer to section 4.1.2 to get information of above instrument.

4.4.4 Test Procedures

- a. Check the calibration of the measuring instrument (SA) using either an internal calibrator or a known signal from an external generator.
- b. Turn on the EUT and connect its antenna terminal to measurement via a low loss cable. Then set it to any one measured frequency within its operating range and make sure the instrument is operated in its linear range.
- c. Adjust the center frequency of SA on any frequency be measured and set SA to zero span mode. And then, set RBW and VBW of spectrum analyzer to proper value.
- d. Measure the time duration of one transmission on the measured frequency. And then plot the result with time difference of this time duration.
- e. Repeat above procedures until all different time-slot modes have been completed.

4.4.5 Deviation from Test Standard

No deviation.

4.4.6 Test Results

GFSK

Mode	Number of Transmission in a 31.6 (79 Hopping*0.4)	Length of Transmission Time (msec)	Result (msec)	Limit (msec)
DH1	51 (times / 5 sec) * 6.32 = 322.32 times	0.426	137.31	400
DH3	26 (times / 5 sec) * 6.32 = 164.32 times	1.74	285.92	400
DH5	16 (times / 5 sec) * 6.32 = 101.12 times	3.088	312.26	400

Note: Test plots of the transmitting time slot are shown as below.

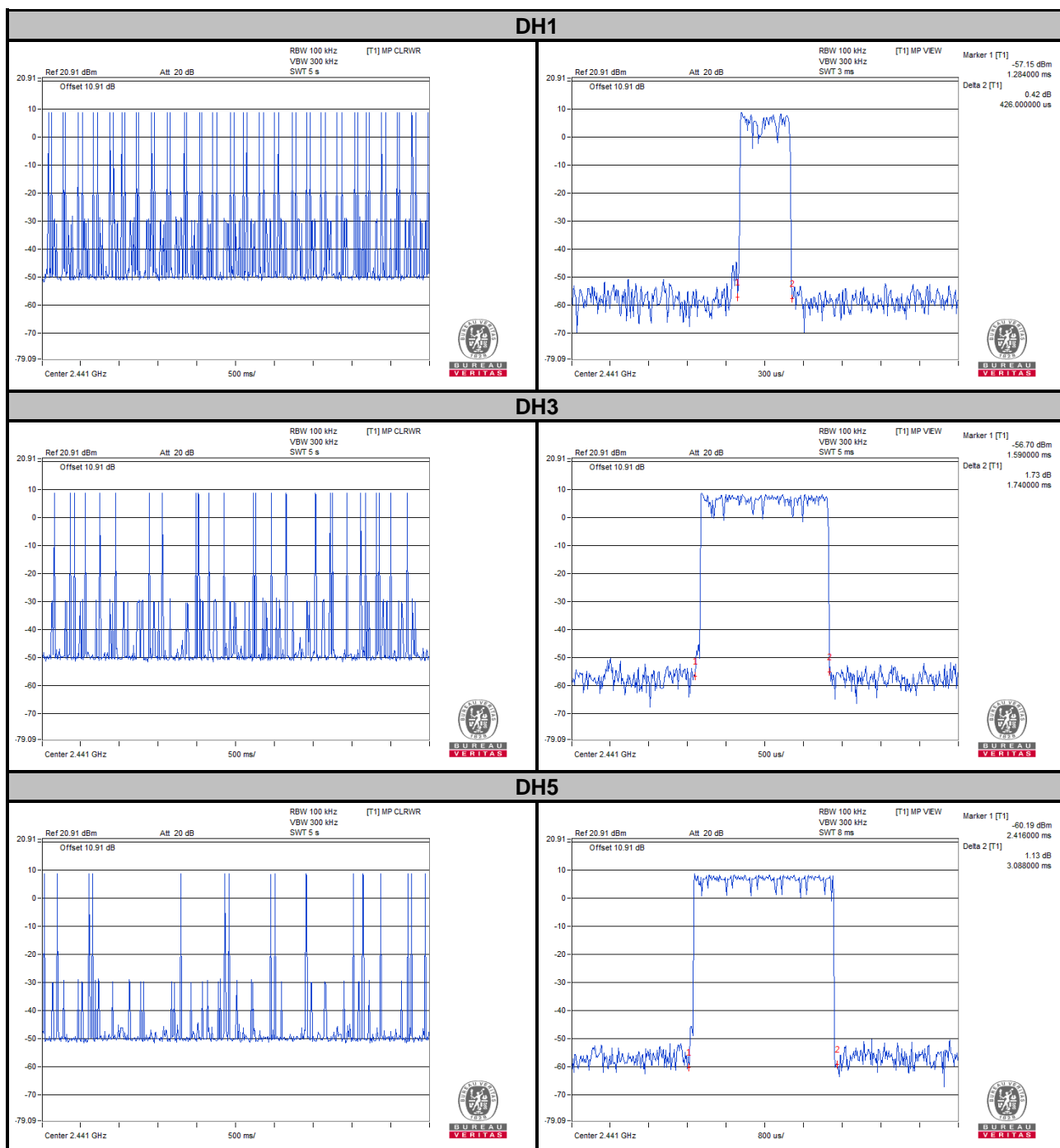

8DPSK

Mode	Number of Transmission in a 31.6 (79 Hopping*0.4)	Length of Transmission Time (msec)	Result (msec)	Limit (msec)
3DH1	50 (times / 5 sec) * 6.32 = 316 times	0.432	136.51	400
3DH3	25 (times / 5 sec) * 6.32 = 158 times	1.74	274.92	400
3DH5	17 (times / 5 sec) * 6.32 = 107.44 times	3.072	330.06	400

Note: Test plots of the transmitting time slot are shown as below.



4.5 Channel Bandwidth

4.5.1 Limits of Channel Bandwidth Measurement

For frequency hopping system operating in the 2400-2483.5 MHz, if the 20 dB bandwidth of hopping channel is greater than 25 kHz, two-thirds 20 dB bandwidth of hopping channel shall be a minimum limit for the hopping channel separation.

4.5.2 Test Setup



4.5.3 Test Instruments

Refer to section 4.1.2 to get information of above instrument.

4.5.4 Test Procedure

- Check the calibration of the measuring instrument using either an internal calibrator or a known signal from an external generator.
- Turn on the EUT and connect it to measurement instrument. Then set it to any one convenient frequency within its operating range. Set a reference level on the measuring instrument equal to the highest peak value.
- Measure the frequency difference of two frequencies that were attenuated 20 dB from the reference level. Record the frequency difference as the emission bandwidth.
- Repeat above procedures until all frequencies measured were complete.

4.5.5 Deviation from Test Standard

No deviation.

4.5.6 EUT Operating Condition

The software provided by client enabled the EUT to transmit and receive data at lowest, middle and highest channel frequencies individually.

4.5.7 Test Results

Channel	Frequency (MHz)	20 dB Bandwidth (MHz)	
		GFSK	8DPSK
0	2402	0.97	1.49
39	2441	0.96	1.48
78	2480	0.97	1.48

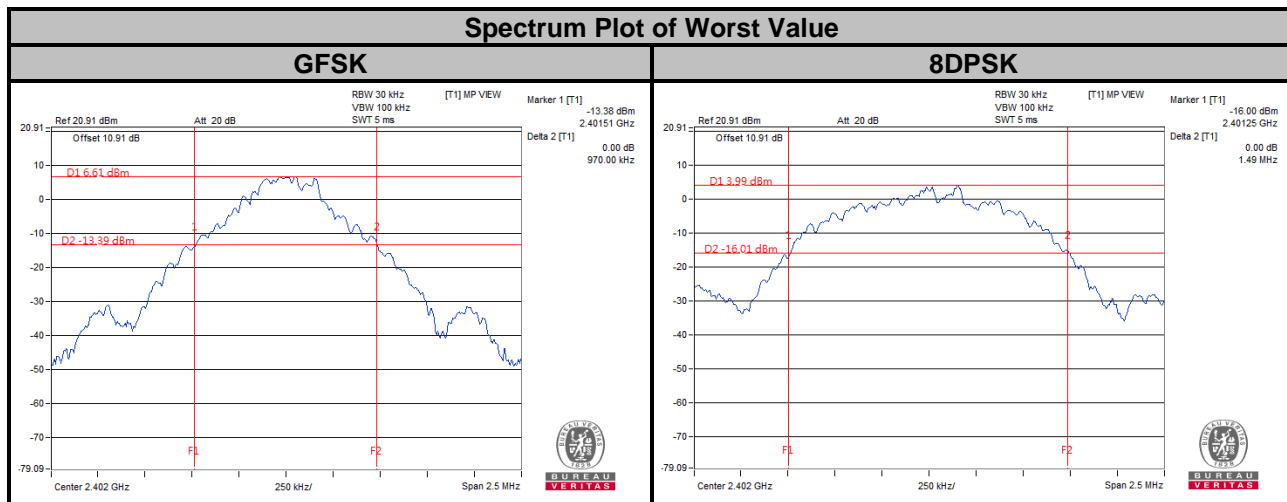

4.6 Occupied Bandwidth Measurement

4.6.1 Test Setup



4.6.2 Test Instruments

Refer to section 4.1.2 to get information of above instrument

4.6.3 Test Procedure

The transmitter output was connected to the spectrum analyzer through an attenuator. The bandwidth of the fundamental frequency was measured by spectrum analyzer with resolution bandwidth in the range of 1 % to 5 % of the anticipated emission bandwidth, and a video bandwidth at least 3x the resolution bandwidth and set the detector to sampling. The width of a frequency band such that, below the lower and above the upper frequency limits, the mean powers emitted are each equal to a specified percentage 0.5 % of the total mean power of a given emission.

4.6.4 Deviation from Test Standard

No deviation.

4.6.5 EUT Operating Conditions

The software provided by client to enable the EUT under transmission condition continuously at lowest, middle and highest channel frequencies individually.

4.6.6 Test Results

Channel	Frequency (MHz)	Occupied Bandwidth (MHz)	
		GFSK	8DPSK
0	2402	0.89	1.38
39	2441	0.88	1.38
78	2480	0.88	1.37

Spectrum Plot of Worst Value

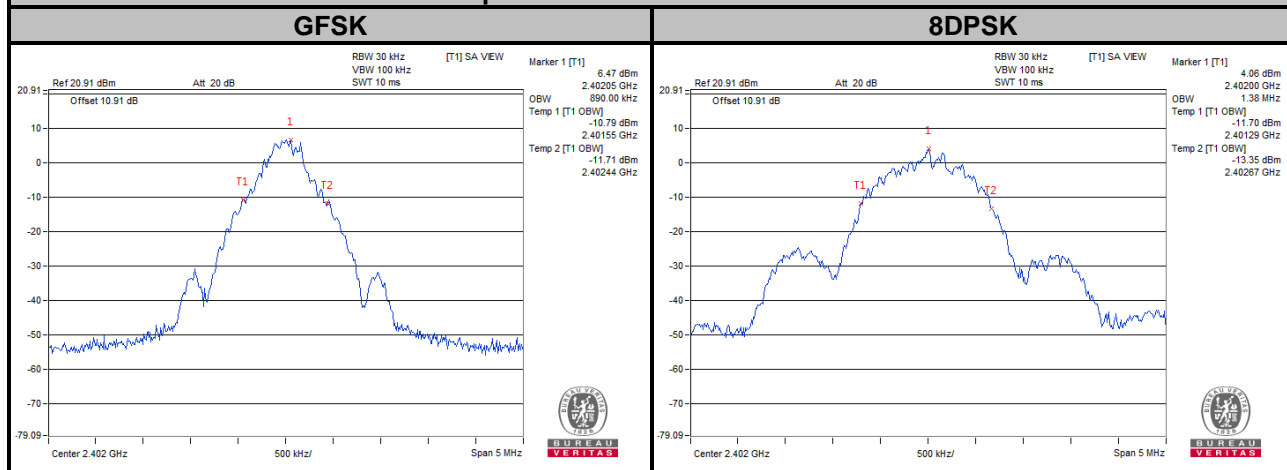

4.7 Hopping Channel Separation

4.7.1 Limits of Hopping Channel Separation Measurement

At least 25 kHz or two-third of 20 dB hopping channel bandwidth (whichever is greater).

4.7.2 Test Setup

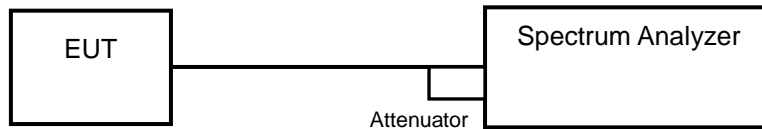

4.7.3 Test Instruments

Refer to section 4.1.2 to get information of above instrument.

4.7.4 Test Procedure

Measurement Procedure REF

- Check the calibration of the measuring instrument using either an internal calibrator or a known signal from an external generator.
- Turn on the EUT and connect it to measurement instrument. Then set it to any one convenient frequency within its operating range.
- By using the MaxHold function record the separation of two adjacent channels.
- Measure the frequency difference of these two adjacent channels by SA MARK function. And then plot the result on SA screen.
- Repeat above procedures until all frequencies measured were complete.

4.7.5 Deviation from Test Standard

No deviation.

4.7.6 Test Results

Channel	Freq. (MHz)	Adjacent Channel Separation (MHz)		20 dB Bandwidth (MHz)		Minimum Limit (MHz)		Pass / Fail
		GFSK	8DPSK	GFSK	8DPSK	GFSK	8DPSK	
0	2402	1.00	1.00	0.97	1.49	0.65	1.00	Pass
39	2441	1.00	1.00	0.96	1.48	0.64	0.99	Pass
78	2480	1.00	1.00	0.97	1.48	0.65	0.99	Pass

Note:

- The minimum limit is two-third 20 dB bandwidth.

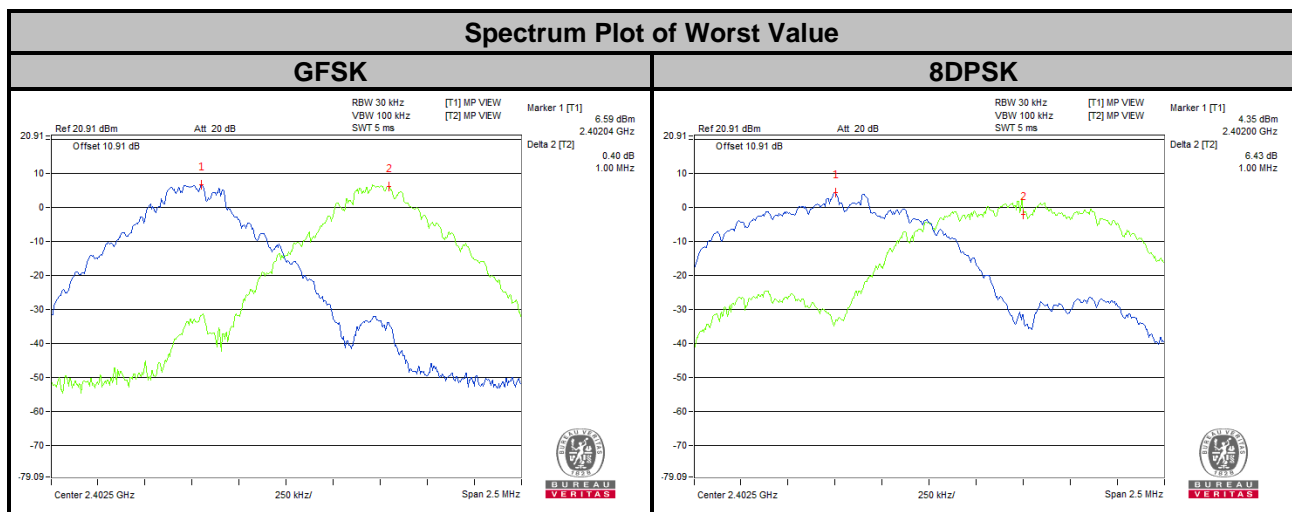

4.8 Maximum Output Power

4.8.1 Limits of Maximum Output Power Measurement

For frequency hopping systems operating in the 2400-2483.5 MHz band employing at least 75 non-overlapping hopping channels: 1 watt.

For all other frequency hopping systems in the 2400-2483.5 MHz band: 0.125 watts.

4.8.2 Test Setup

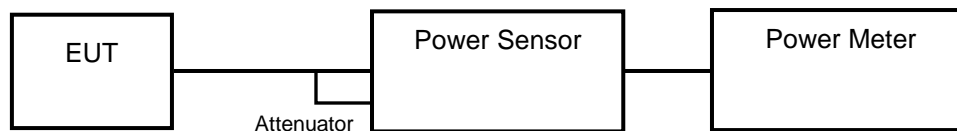

4.8.3 Test Instruments

Refer to section 4.1.2 to get information of above instrument.

4.8.4 Test Procedure

A peak power sensor was used on the output port of the EUT. A power meter was used to read the response of the peak power sensor. Record the power level.

Average power sensor was used to perform output power measurement, trigger and gating function of wide band power meter is enabled to measure max output power of TX on burst. Duty factor is not added to measured value.

4.8.5 Deviation from Test Standard

No deviation.

4.8.6 EUT Operating Condition

The software provided by client enabled the EUT to transmit and receive data at lowest, middle and highest channel frequencies individually.

4.8.7 Test Results

<GFSK>

Channel	Freq. (MHz)	Peak Power		Average Power		Power Limit (mW)	Pass / Fail
		(mW)	(dBm)	(mW)	(dBm)		
0	2402	8.63	9.36	8.492	9.29	125 / 1000 ^{Note}	Pass
39	2441	9.638	9.84	9.484	9.77	125 / 1000 ^{Note}	Pass
78	2480	9.954	9.98	9.84	9.93	125 / 1000 ^{Note}	Pass

Note: RF Output Power limit depends on the operating channel numbers, please refer to section 4.3 of the results.

<8DPSK>

Channel	Freq. (MHz)	Peak Power		Average Power		Power Limit (mW)	Pass / Fail
		(mW)	(dBm)	(mW)	(dBm)		
0	2402	7.745	8.89	5.2	7.16	125 / 1000 ^{Note}	Pass
39	2441	8.26	9.17	5.395	7.32	125 / 1000 ^{Note}	Pass
78	2480	8.204	9.14	5.236	7.19	125 / 1000 ^{Note}	Pass

Note: RF Output Power limit depends on the operating channel numbers, please refer to section 4.3 of the results.

4.9 Conducted Out of Band Emission Measurement

4.9.1 Limits Of Conducted Out of Band Emission Measurement

Below -20 dB of the highest emission level of operating band (in 100 kHz RBW).

4.9.2 Test Instruments

Refer to section 4.1.2 to get information of above instrument.

4.9.3 Test Procedure

The transmitter output was connected to the spectrum analyzer via a low lose cable. Set both RBW and VBW of spectrum analyzer to 100 kHz and 300 kHz with suitable frequency span including 100 MHz bandwidth from band edge. The band edges was measured and recorded.

4.9.4 Deviation from Test Standard

No deviation.

4.9.5 EUT Operating Condition

The software provided by client enabled the EUT to transmit and receive data at lowest, middle and highest channel frequencies individually.

4.9.6 Test Results

The spectrum plots are attached on the following images. D1 line indicates the highest level, D2 line indicates the 20 dB offset below D1. It shows compliance with the requirement.

GFSK

Hopping Disabled_Low Channel

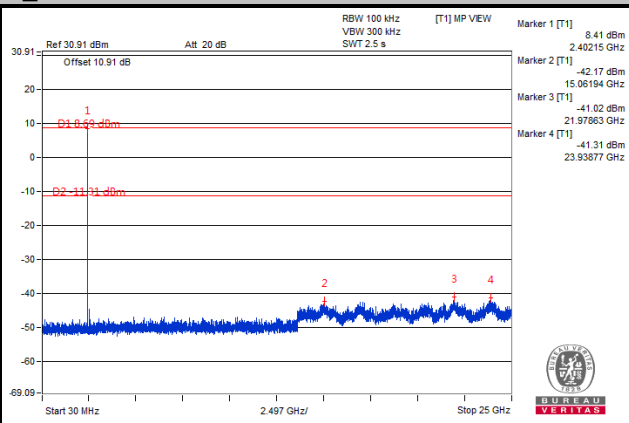
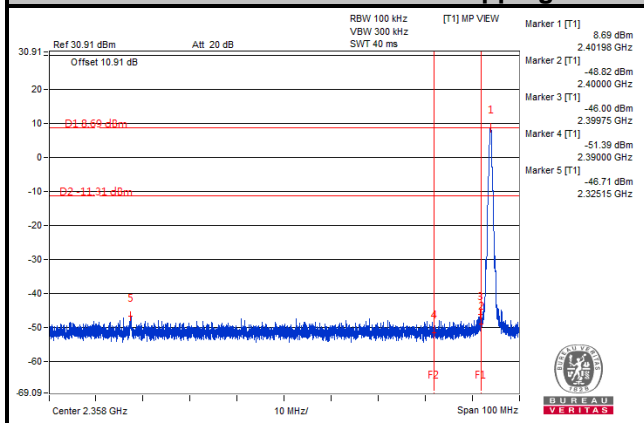

Hopping Disabled_Middle Channel

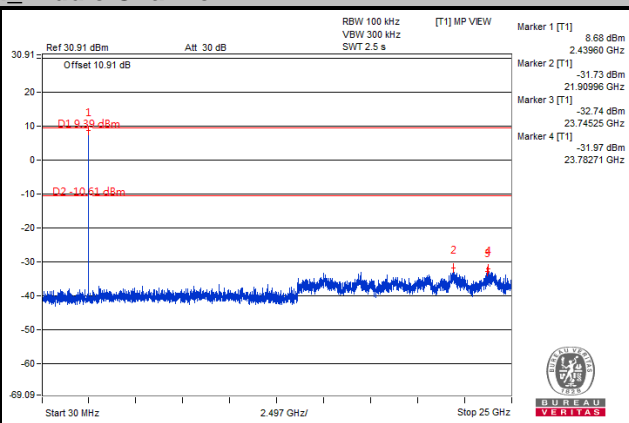
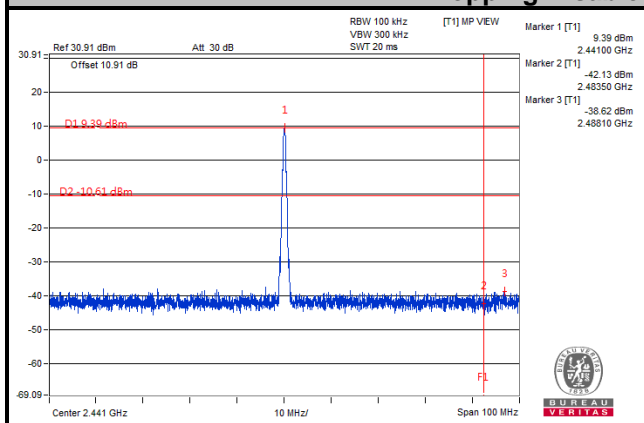

Hopping Disabled_High Channel

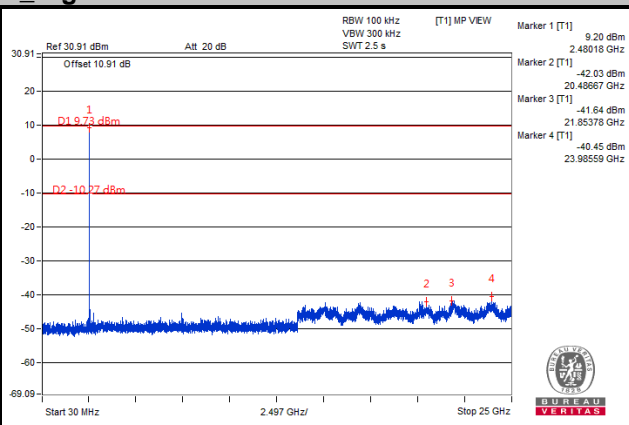
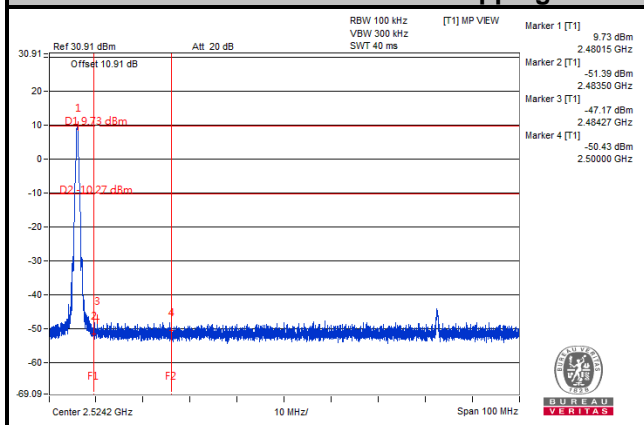

Hopping Enabled_Low Channel

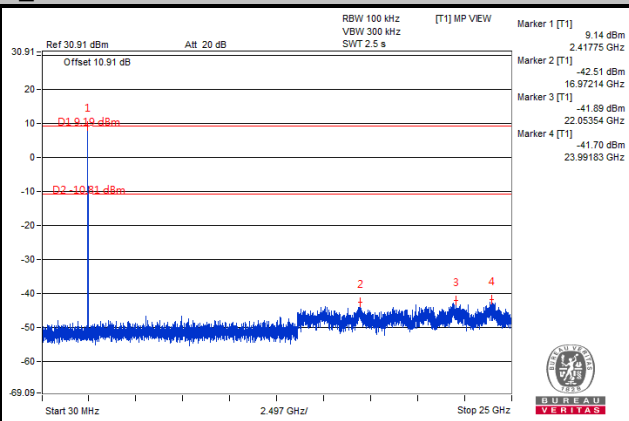
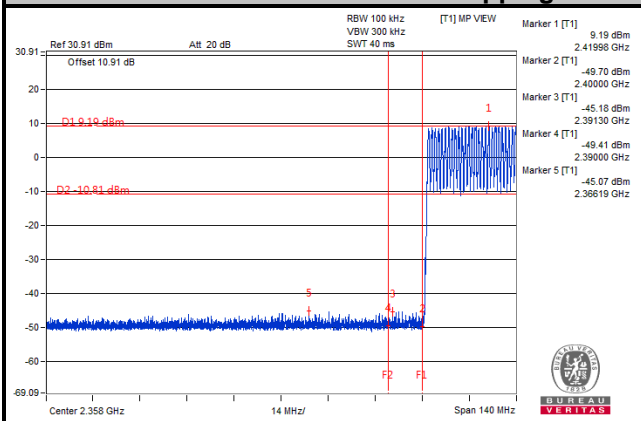

Hopping Enabled_High Channel

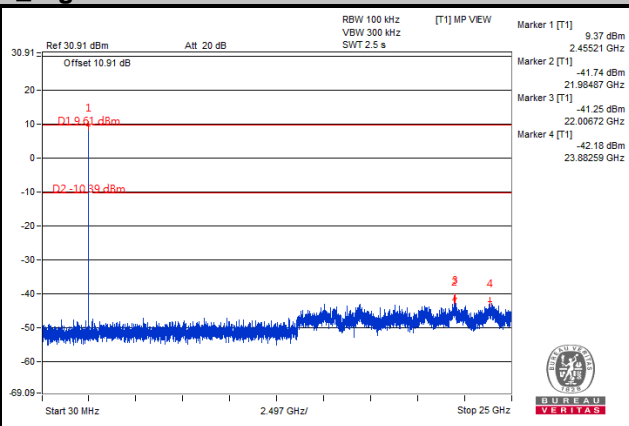
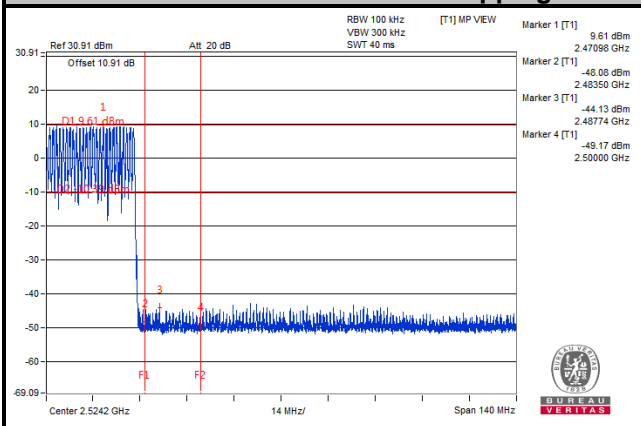

8DPSK

Hopping Disabled_Low Channel

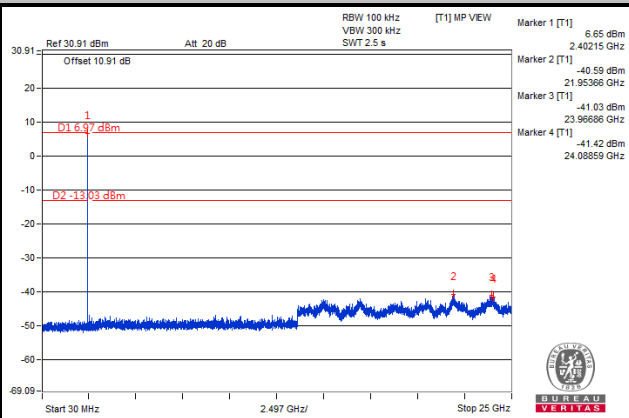
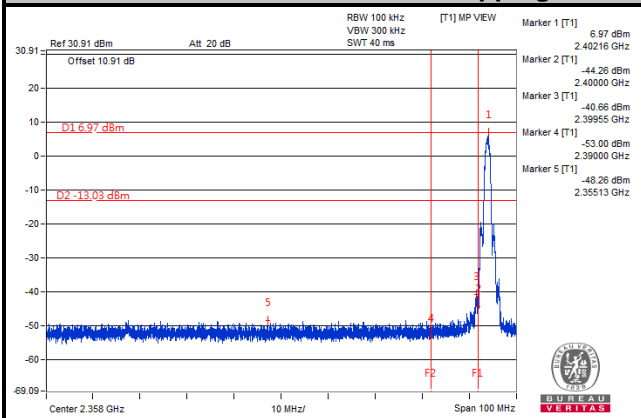

Hopping Disabled_Middle Channel

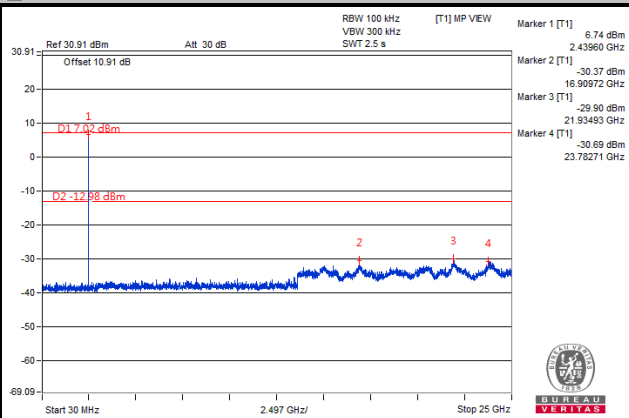
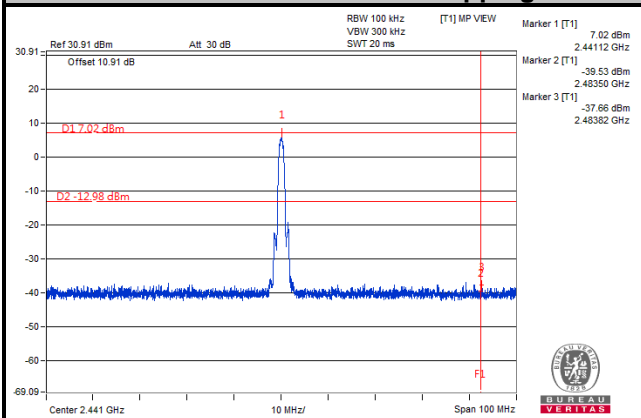

Hopping Disabled_High Channel

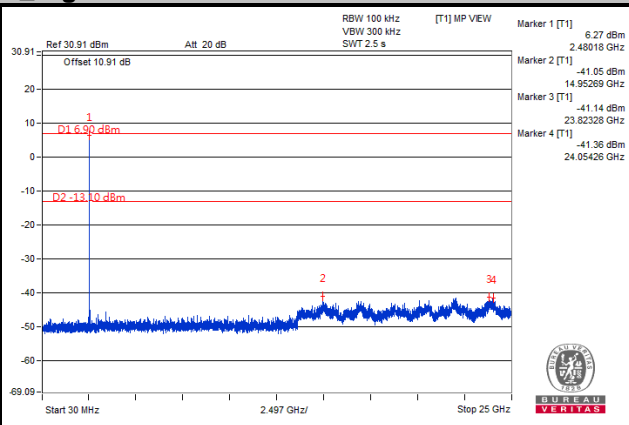
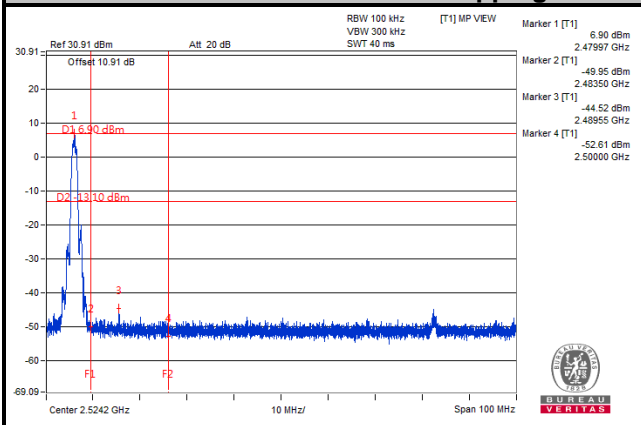

Hopping Enabled_Low Channel

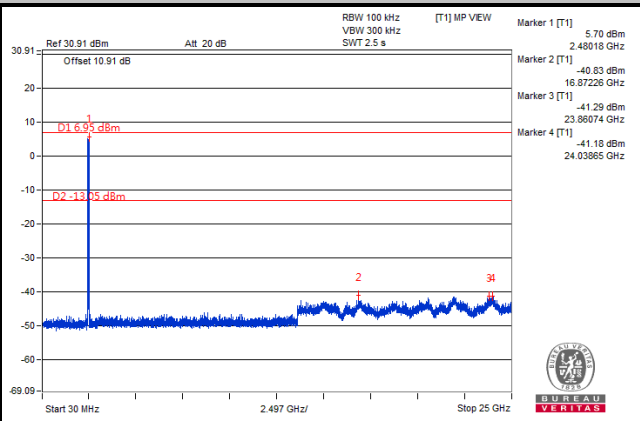
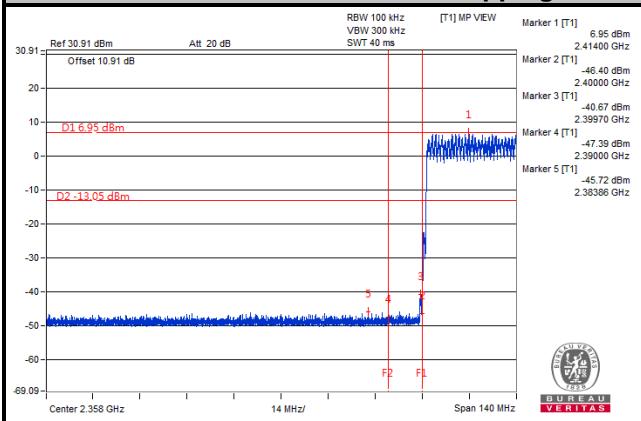

Hopping Enabled_High Channel

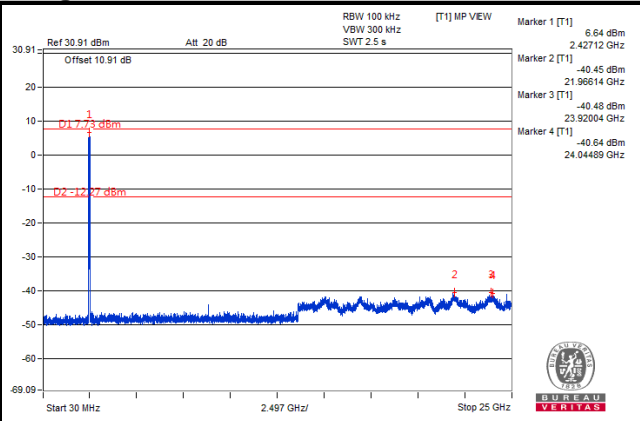
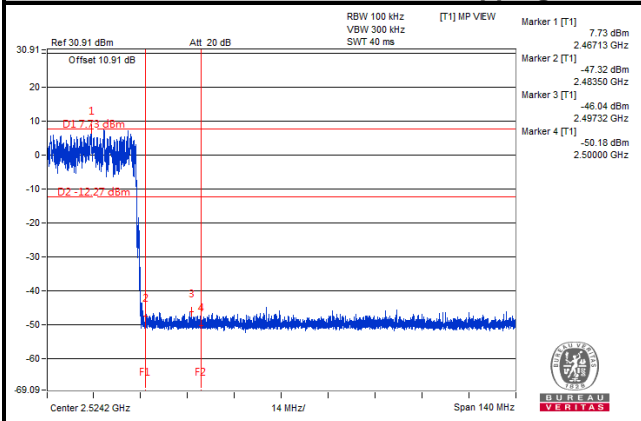

5 Pictures of Test Arrangements

Please refer to the attached file (Test Setup Photo).

Annex A- Band Edge Measurement

GFSK

CH 0 2402 MHz

Peak

Horizontal

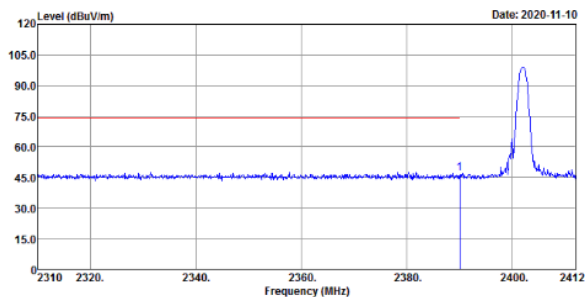

Vertical

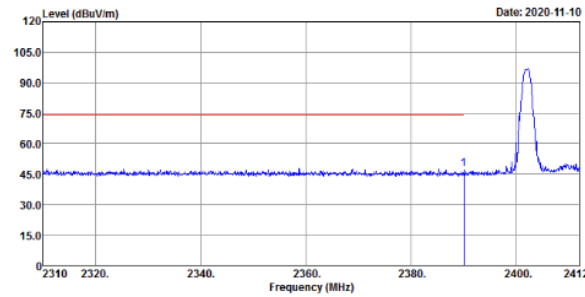

Average

Horizontal

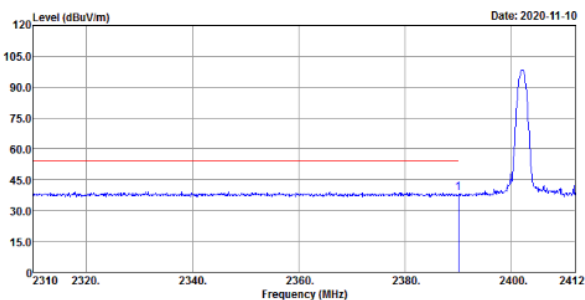

Vertical

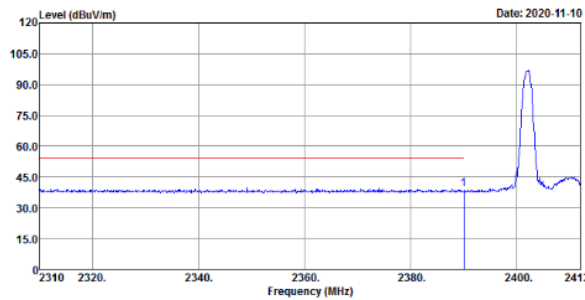

CH 78 2480 MHz

Peak

Horizontal

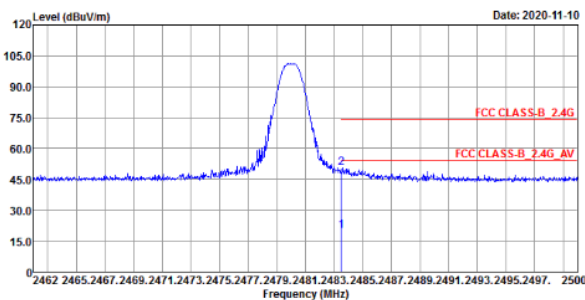

Vertical

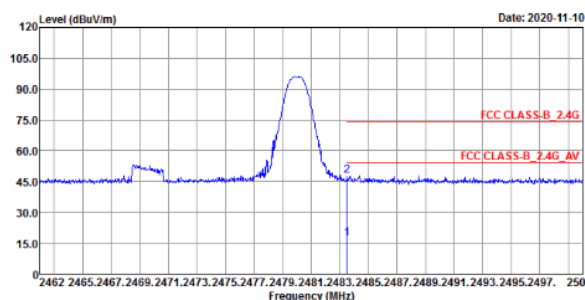

8DPSK

CH 0 2402 MHz

Peak

Horizontal

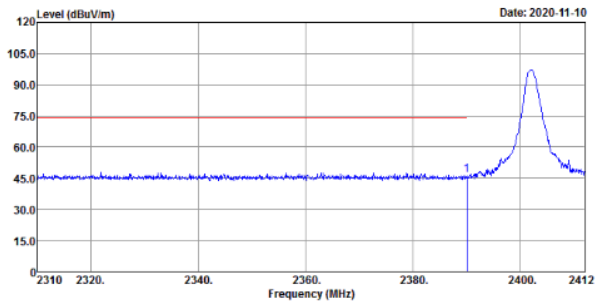

Vertical

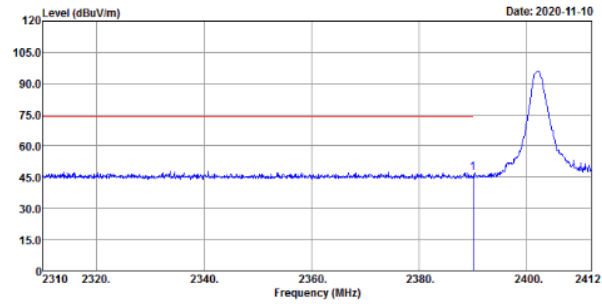

Average

Horizontal

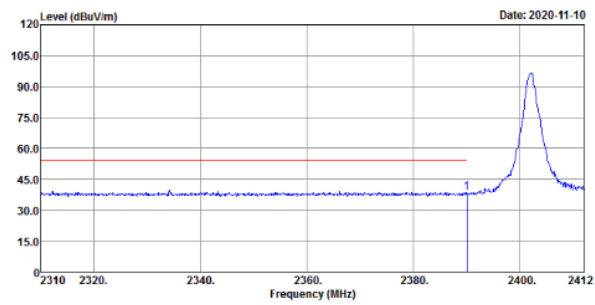

Vertical

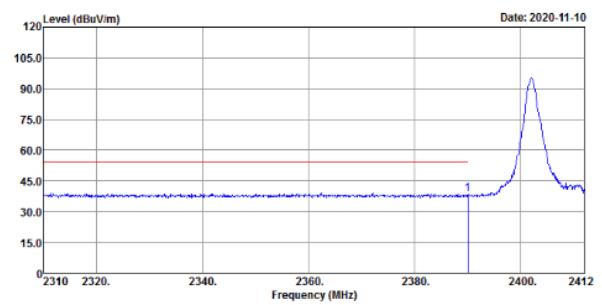

CH 78 2480 MHz

Peak

Horizontal

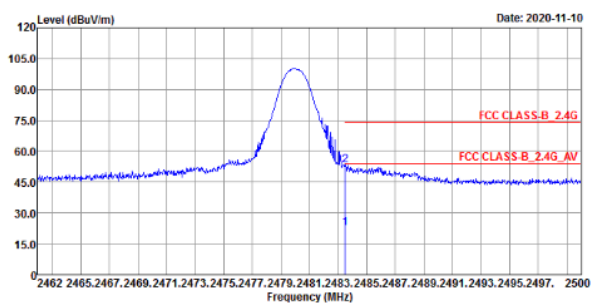

Vertical

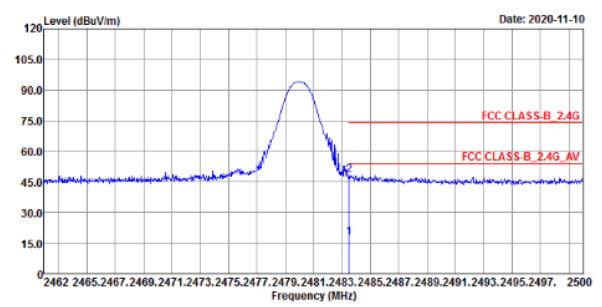

Appendix – Information of the Testing Laboratories

We, Bureau Veritas Consumer Products Services (H.K.) Ltd., Taoyuan Branch, were founded in 1988 to provide our best service in EMC, Radio, Telecom and Safety consultation. Our laboratories are FCC recognized accredited test firms and accredited according to ISO/IEC 17025.

If you have any comments, please feel free to contact us at the following:

Lin Kou EMC/RF Lab

Tel: 886-2-26052180

Fax: 886-2-26051924

Hsin Chu EMC/RF/Telecom Lab

Tel: 886-3-6668565

Fax: 886-3-6668323

Hwa Ya EMC/RF/Safety Lab

Tel: 886-3-3183232

Fax: 886-3-3270892

Email: service.adt@tw.bureauveritas.com

Web Site: www.bureauveritas-adt.com

The address and road map of all our labs can be found in our web site also.

--- END ---