

RADIO TEST REPORT

FCC 47 CFR PART 15 SUBPART C

Test Standard	FCC Part 15.247
Product name	Digital Paper System
Brand Name	Avalue
Model No.	EL310XX (X= 0~9 or A~Z)
Test Result	Pass
Statements of Conformity	Determination of compliance is based on the results of the compliance measurement, not taking into account measurement instrumentation uncertainty.

The test Result was tested by Compliance Certification Services Inc. The test data, data evaluation, test procedures, and equipment configurations shown in this report were given in ANSI C63.10: 2013 and compliance standards.

The test results of this report relate only to the tested sample (EUT) identified in this report.

The test Report of full or partial shall not copy. Without written approval of Compliance Certification Services Inc. (Wugu Laboratory).

Approved by:



Kevin Tsai
Deputy Manager

Unless otherwise stated the results shown in this test report refer only to the sample(s) tested and such sample(s) are retained for 90 days only.
除非另有說明，此報告結果僅對測試之樣品負責，同時此樣品僅保留90天。本報告未經本公司書面許可，不可部份複製。

This document is issued by the Company subject to its General Conditions of Service printed overleaf, available on request or accessible at <http://www.sgs.com.tw/Terms-and-Conditions> and, for electronic format documents, subject to Terms and Conditions for Electronic Documents at <http://www.sgs.com.tw/Terms-and-Conditions>. Attention is drawn to the limitation of liability, indemnification and jurisdiction issues defined therein. Any holder of this document is advised that information contained hereon reflects the Company's findings at the time of its intervention only and within the limits of client's instruction, if any. The Company's sole responsibility is to its Client and this document does not exonerate parties to a transaction from exercising all their rights and obligations under the transaction documents. This document cannot be reproduced, except in full, without prior written approval of the Company. Any unauthorized alteration, forgery or falsification of the content or appearance of this document is unlawful and offenders may be prosecuted to the fullest extent of the law.

Revision History

Rev.	Issue Date	Revisions	Effect Page	Revised By
00	January 11, 2021	Initial Issue	ALL	Mita Wu

Table of contents

1.	GENERAL INFORMATION.....	4
1.1	EUT INFORMATION.....	4
1.2	EUT CHANNEL INFORMATION.....	5
1.3	ANTENNA INFORMATION.....	5
1.4	MEASUREMENT UNCERTAINTY.....	6
1.5	FACILITIES AND TEST LOCATION.....	7
1.6	INSTRUMENT CALIBRATION	7
1.7	SUPPORT AND EUT ACCESSORIES EQUIPMENT	8
1.8	TEST METHODOLOGY AND APPLIED STANDARDS.....	8
2.	TEST SUMMERY.....	9
3.	DESCRIPTION OF TEST MODES.....	10
3.1	THE WORST MODE OF OPERATING CONDITION	10
3.2	THE WORST MODE OF MEASUREMENT.....	11
3.3	EUT DUTY CYCLE	12
4.	TEST RESULT.....	13
4.1	AC POWER LINE CONDUCTED EMISSION.....	13
4.2	6DB BANDWIDTH AND OCCUPIED BANDWIDTH (99%).....	16
4.3	OUTPUT POWER MEASUREMENT	30
4.4	POWER SPECTRAL DENSITY	32
4.5	CONDUCTED BANDEDGE AND SPURIOUS EMISSION.....	40
4.6	RADIATION BANDEDGE AND SPURIOUS EMISSION.....	59
	APPENDIX 1 - PHOTOGRAPHS OF EUT	A-1

Report No.: T201104D06-RP3

1. GENERAL INFORMATION

1.1 EUT INFORMATION

Applicant	AIMobile Co., Ltd. 6F., No. 166, Sec.4, Chengde Rd., Shilin Dist., Taipei City 11167 , Taiwan
Manufacturer	AIMobile Co., Ltd. 6F., No. 166, Sec.4, Chengde Rd., Shilin Dist., Taipei City 11167 , Taiwan
Equipment	Digital Paper System
Model Name	EL310XX (X= 0~9 or A~Z)
Model Discrepancy	All the above models are identical except for the designation of model numbers. The suffix of (X= 0~9 or A~Z) on model number is just for marketing purpose only
Trade Name	Avalue
Received Date	November 4, 2020
Date of Test	November 11 ~ December 8, 2020
Power Supply	1. Power from Host System. Rechargeable Li-Polymer Battery / LIS1633RDPCA Rating: 2000mAh, 7.4Wh 2. Power from Adapter.

Remark:

1. For more details, refer to the User's manual of the EUT.
2. Disclaimer: Antenna information is provided by the applicant, test results of this report are applicable to the sample EUT received.
3. Disclaimer: Variant information between/among model numbers / trademarks is provided by the applicant, test results of this report are applicable to the sample EUT received of main test model name.

Report No.: T201104D06-RP3

1.2 EUT CHANNEL INFORMATION

Frequency Range	802.11b/g/n HT 20: 2412MHz ~ 2462MHz
Modulation Type	1. IEEE 802.11b mode: CCK 2. IEEE 802.11g mode: OFDM 3. IEEE 802.11n HT 20 MHz mode : OFDM
Number of channel	1. IEEE 802.11b mode: 11 Channels 2. IEEE 802.11g mode: 11 Channels 3. IEEE 802.11n HT 20 MHz mode : 11 Channels

Remark:

Refer as ANSI C63.10: 2013 clause 5.6.1 Table 4 for test channels

Number of frequencies to be tested		
Frequency range in which device operates	Number of frequencies	Location in frequency range of operation
<input type="checkbox"/> 1 MHz or less	1	Middle
<input type="checkbox"/> 1 MHz to 10 MHz	2	1 near top and 1 near bottom
<input checked="" type="checkbox"/> More than 10 MHz	3	1 near top, 1 near middle, and 1 near bottom

1.3 ANTENNA INFORMATION

Antenna Specification	PIFA antenna
Antenna Gain	Chain 0: 2.8 dBi Chain 1: 2.94 dBi Power Directional Gain: 2.87 dBi
Antenna connector	IPEX

Notes:

1. Power Directional Gain = $10 \cdot \text{LOG}(((10^{\text{Ant1}/10}) + 10^{\text{Ant2}/10})/2)$

1.4 MEASUREMENT UNCERTAINTY

PARAMETER	UNCERTAINTY
AC Powerline Conducted Emission	+/- 1.2575
Emission bandwidth, 20dB bandwidth	+/- 0.0014
RF output power, conducted	+/- 1.14
Power density, conducted	+/- 1.40
3M Semi Anechoic Chamber / 30M~200M	+/- 4.12
3M Semi Anechoic Chamber / 200M~1000M	+/- 4.68
3M Semi Anechoic Chamber / 1G~8G	+/- 5.18
3M Semi Anechoic Chamber / 8G~18G	+/- 5.47
3M Semi Anechoic Chamber / 18G~26G	+/- 3.81
3M Semi Anechoic Chamber / 26G~40G	+/- 3.87

Remark:

- 1.This uncertainty represents an expanded uncertainty expressed at approximately the 95% confidence level using a coverage factor of k=2
2. ISO/IEC 17025 requires that an estimate of the measurement uncertainties associated with the emissions test results be included in the report.

Report No.: T201104D06-RP3

1.5 FACILITIES AND TEST LOCATION

All measurement facilities used to collect the measurement data are located at No.11, Wugong 6th Rd., Wugu Dist., New Taipei City, Taiwan. (R.O.C.)

Test site	Test Engineer	Remark
AC Conduction Room	Lance Chen	-
Radiation	Ray Li, Jerry Chang	-
RF Conducted	Rick Lee	-

Remark: The sites are constructed in conformance with the requirements of ANSI C63.7, ANSI C63.4 and CISPR Publication 22.

1.6 INSTRUMENT CALIBRATION

RF Conducted Test Site					
Name of Equipment	Manufacturer	Model	Serial Number	Calibration Date	Calibration Due
Coaxial Cable	Woken	WC12	CC003	06/29/2020	06/28/2021
Coaxial Cable	Woken	WC12	CC001	06/29/2020	06/28/2021
Signal Analyzer	R&S	FSV 40	101073	09/17/2020	09/16/2021
Power Meter	Anritsu	ML2495A	1149001	N.C.R	N.C.R
Power Seneor	Anritsu	MA2491A	030982	N.C.R	N.C.R
Software	N/A				

3M 966 Chamber Test Site					
Equipment	Manufacturer	Model	S/N	Cal Date	Cal Due
Band Reject Filters	MICRO TRONICS	BRM 50702	120	02/25/2020	02/24/2021
Bilog Antenna	Sunol Sciences	JB3	A030105	07/24/2020	07/23/2021
Coaxial Cable	HUBER SUHNER	SUCOFLEX 104PEA	20995	02/25/2020	02/24/2021
Coaxial Cable	EMCI	EMC105	190914+327109/4	09/19/2020	09/18/2021
Digital Thermo-Hygro Meter	WISEWIND	1206	D07	01/15/2020	01/14/2021
double Ridged Guide Horn Antenna	ETC	MCTD 1209	DRH13M02003	09/30/2020	09/29/2021
Loop Ant	COM-POWER	AL-130	121051	03/27/2020	03/26/2021
Pre-Amplifier	EMEC	EM330	060609	02/25/2020	02/24/2021
Pre-Amplifier	EMEC	EM01G26G	060570	06/29/2020	06/28/2021
PSA Series Spectrum Analyzer	Agilent	E4446A	MY46180323	07/24/2020	07/23/2021
Antenna Tower	CCS	CC-A-1F	N/A	N.C.R	N.C.R
Controller	CCS	CC-C-1F	N/A	N.C.R	N.C.R
Turn Table	CCS	CC-T-1F	N/A	N.C.R	N.C.R
Software	e3 6.11-20180413				

Remark: Each piece of equipment is scheduled for calibration once a year.

AC Power Line Conducted Emission Test Room					
Name of Equipment	Manufacturer	Model	Serial Number	Calibration Date	Calibration Due
CABLE	EMCI	CFD300-NL	CERF	06/29/2020	06/28/2021
EMI Test Receiver	R&S	ESCI	100064	07/17/2020	07/16/2021
LISN	SCHAFFNER	NNB 41	03/10013	02/13/2020	02/12/2021
Software	EZ-EMC(CCS-3A1-CE)				

Remark: Each piece of equipment is scheduled for calibration once a year.

1.7 SUPPORT AND EUT ACCESSORIES EQUIPMENT

Support Equipment					
No.	Equipment	Brand	Model	Series No.	FCC ID
	N/A				

Support Equipment					
No.	Equipment	Brand	Model	Series No.	FCC ID
1	Adapter	SAMSUNG	ETA-U90JWS	N/A	N/A

1.8 TEST METHODOLOGY AND APPLIED STANDARDS

The test methodology, setups and results comply with all requirements in accordance with ANSI C63.10:2013, FCC Part 2, FCC Part 15.247, KDB 662911 D01.

2. TEST SUMMARY

FCC Standard Section	Report Section	Test Item	Result
15.203	1.3	Antenna Requirement	Pass
15.207(a)	4.1	AC Conducted Emission	Pass
15.247(a)(2)	4.2	6 dB Bandwidth	Pass
-	4.2	Occupied Bandwidth (99%)	Pass
15.247(b)	4.3	Output Power Measurement	Pass
15.247(e)	4.4	Power Spectral Density	Pass
15.247(d)	4.5	Conducted Band Edge	Pass
15.247(d)	4.5	Conducted Spurious Emission	Pass
15.247(d)	4.6	Radiation Band Edge	Pass
15.247(d)	4.6	Radiation Spurious Emission	Pass

Report No.: T201104D06-RP3

3. DESCRIPTION OF TEST MODES

3.1 THE WORST MODE OF OPERATING CONDITION

<p>Operation mode</p>	<p>IEEE 802.11b mode :1Mbps IEEE 802.11g mode :6Mbps IEEE 802.11n HT20 mode :MCS8</p>
<p>Test Channel Frequencies</p>	<p>IEEE 802.11b mode : 1. Lowest Channel : 2412MHz 2. Middle Channel : 2437MHz 3. Highest Channel : 2462MHz IEEE 802.11g mode : 1. Lowest Channel : 2412MHz 2. Middle Channel : 2437MHz 3. Highest Channel : 2462MHz IEEE 802.11n HT20 mode : 1. Lowest Channel : 2412MHz 2. Middle Channel : 2437MHz 3. Highest Channel : 2462MHz</p>
<p>Operation Transmitter</p>	<p>IEEE 802.11b mode : 2T2R IEEE 802.11g mode : 2T2R IEEE 802.11n HT20 mode : 2T2R</p>

Remark:

1. EUT pre-scanned data rate of output power for each mode, the worst data rate were recorded in this report.

Report No.: T201104D06-RP3

3.2 THE WORST MODE OF MEASUREMENT

AC Power Line Conducted Emission	
Test Condition	AC Power line conducted emission for line and neutral
Power supply Mode	Mode 1: EUT power by Adapter
Worst Mode	<input checked="" type="checkbox"/> Mode 1 <input type="checkbox"/> Mode 2 <input type="checkbox"/> Mode 3 <input type="checkbox"/> Mode 4

Radiated Emission Measurement Below 1G	
Test Condition	Radiated Emission Below 1G
Power supply Mode	Mode 1: EUT power by host system
Worst Mode	<input checked="" type="checkbox"/> Mode 1 <input type="checkbox"/> Mode 2 <input type="checkbox"/> Mode 3 <input type="checkbox"/> Mode 4

Radiated Emission Measurement Above 1G	
Test Condition	Radiated Emission Above 1G
Power supply Mode	Mode 1: EUT power by host system
Worst Mode	<input checked="" type="checkbox"/> Mode 1 <input type="checkbox"/> Mode 2 <input type="checkbox"/> Mode 3 <input type="checkbox"/> Mode 4
Worst Position	<input type="checkbox"/> Placed in fixed position. <input checked="" type="checkbox"/> Placed in fixed position at X-Plane (E2-Plane) <input type="checkbox"/> Placed in fixed position at Y-Plane (E1-Plane) <input type="checkbox"/> Placed in fixed position at Z-Plane (H-Plane)

Remark:

1. The worst mode was record in this test report.
2. EUT pre-scanned in three axis ,X,Y, Z and two polarity, for radiated measurement. The worst case(X-Plane) were recorded in this report
3. AC power line conducted emission and for below 1G radiation emission were performed the EUT transmit at the highest output power channel as worse case.

Report No.: T201104D06-RP3

3.3 EUT DUTY CYCLE

Temperature: 24.9°C

Humidity: 58% RH

Tested by: Rick Lee

Test date: December 8, 2020

Duty Cycle				
Configuration	Duty Cycle (%)	Duty Factor (dB) =10*log (1/Duty Cycle)	1/T (kHz)	VBW setting (kHz)
802.11b	100%	0.00	N/A	0.01
802.11g	100%	0.00	N/A	0.01
802.11n HT20	100%	0.00	N/A	0.01

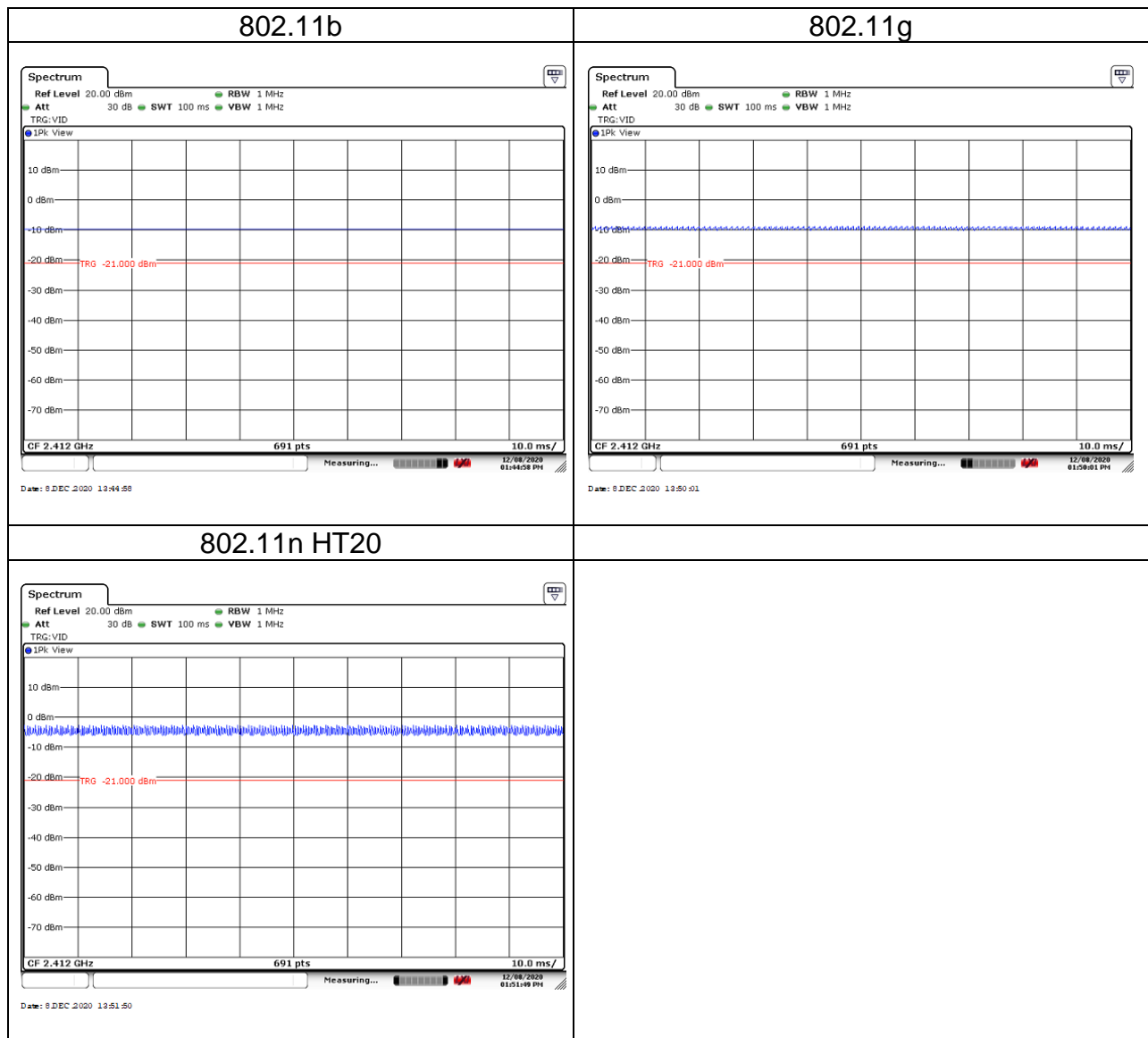

Report No.: T201104D06-RP3

4. TEST RESULT

4.1 AC POWER LINE CONDUCTED EMISSION

4.1.1 Test Limit

According to §15.207(a)(2),

Frequency Range (MHz)	Limits(dBµV)	
	Quasi-peak	Average
0.15 to 0.50	66 to 56*	56 to 46*
0.50 to 5	56	46
5 to 30	60	50

* Decreases with the logarithm of the frequency.

4.1.2 Test Procedure

Test method Refer as ANSI C63.10: 2013 clause 6.2,

1. The EUT was placed on a non-conducted table, which is 0.8m above horizontal ground plane and 0.4m above vertical ground plane.
2. EUT connected to the line impedance stabilization network (LISN)
3. Receiver set RBW of 9kHz and Detector Peak, and note as quasi-peak and average.
4. Maximum procedure was performed on the six highest emissions to ensure EUT compliance.
5. Recorded Line for Neutral and Line.

4.1.3 Test Setup

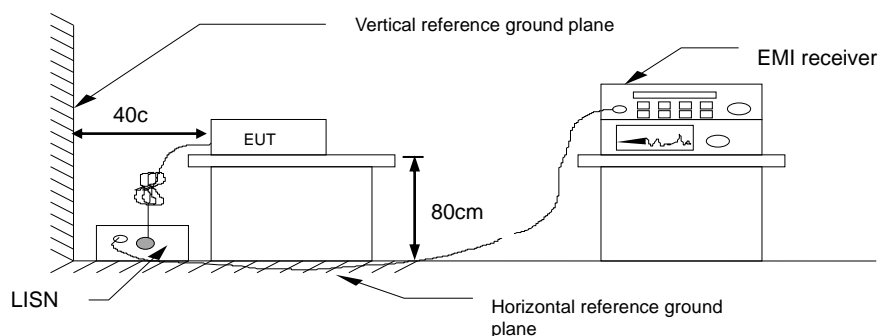

4.1.4 Test Result

Pass.

Test Data

Test Mode:	Mode 1	Temp/Hum	23.6(°C)/ 48%RH
Phase:	Line	Test Date	November 25, 2020
Test Voltage:	120Vac, 60Hz	Test Engineer	Lance Chen

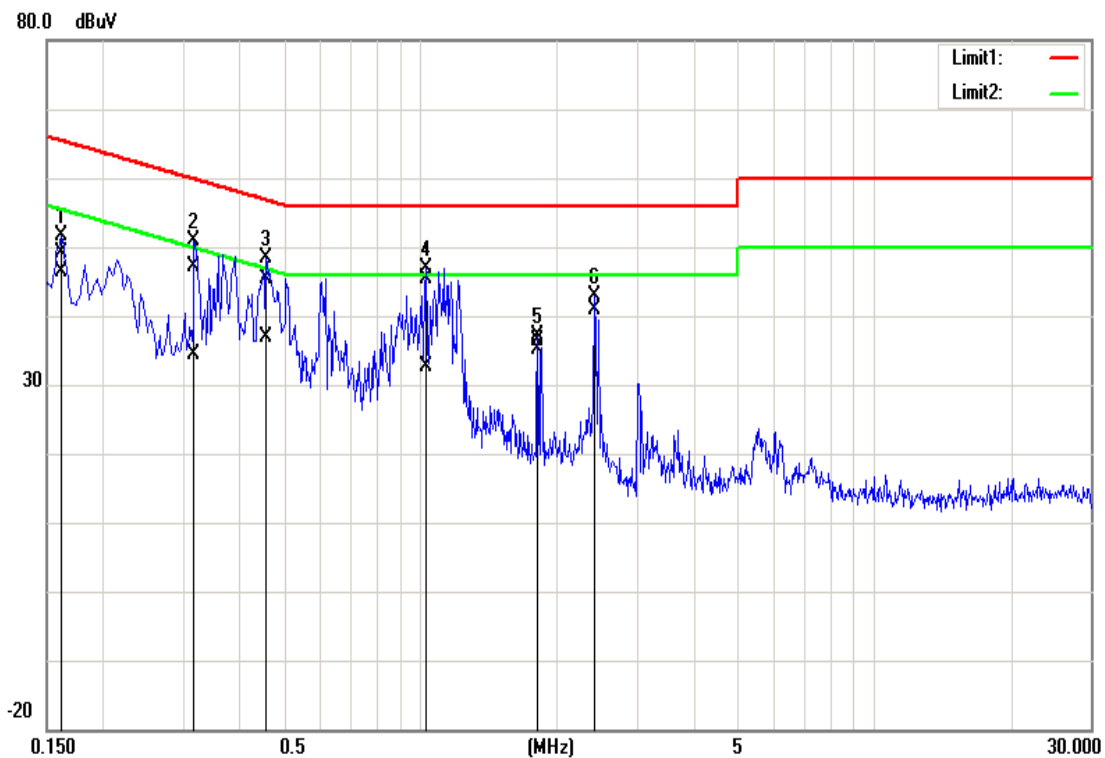

Frequency (MHz)	Quasi Peak reading (dBuV)	Average reading (d uV)	Correction factor (dB)	Quasi Peak result (dBuV)	Average result (dBuV)	Quasi Peak limit (dBuV)	Average limit (dBuV)	Quasi Peak margin (dB)	Average margin (dB)	Remark
0.1620	38.87	36.10	10.21	49.08	46.31	65.36	55.36	-16.28	-9.05	Pass
0.3180	36.93	24.13	10.22	47.15	34.35	59.76	49.76	-12.61	-15.41	Pass
0.4580	35.13	26.61	10.22	45.35	36.83	56.73	46.73	-11.38	-9.90	Pass
1.0300	35.20	22.42	10.24	45.44	32.66	56.00	46.00	-10.56	-13.34	Pass
1.8140	26.02	24.84	10.25	36.27	35.09	56.00	46.00	-19.73	-10.91	Pass
2.4180	32.70	30.74	10.26	42.96	41.00	56.00	46.00	-13.04	-5.00	Pass

Report No.: T201104D06-RP3

Test Mode:	Mode 1	Temp/Hum	23.6(°C)/ 48%RH
Phase:	Neutral	Test Date	November 25, 2020
Test Voltage:	120Vac, 60Hz	Test Engineer	Lance Chen

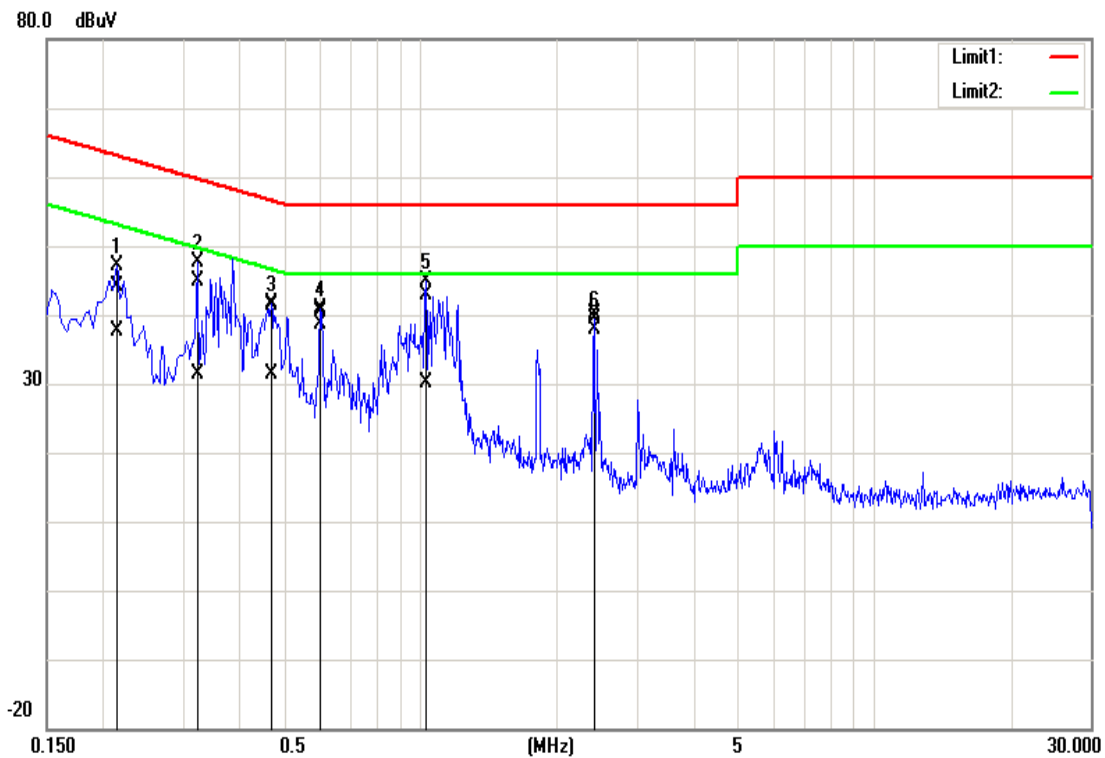

Frequency (MHz)	Quasi Peak reading (dBuV)	Average reading (dBuV)	Correction factor (dB)	Quasi Peak result (dBuV)	Average result (dBuV)	Quasi Peak limit (dBuV)	Average limit (dBuV)	Quasi Peak margin (dB)	Average margin (dB)	Remark
0.2140	34.03	27.44	10.19	44.22	37.63	63.05	53.05	-18.83	-15.42	Pass
0.3220	34.65	21.22	10.19	44.84	31.41	59.66	49.66	-14.82	-18.25	Pass
0.4700	31.30	21.13	10.19	41.49	31.32	56.51	46.51	-15.02	-15.19	Pass
0.6020	30.26	28.35	10.19	40.45	38.54	56.00	46.00	-15.55	-7.46	Pass
1.0300	32.67	19.81	10.21	42.88	30.02	56.00	46.00	-13.12	-15.98	Pass
2.4140	30.02	27.73	10.23	40.25	37.96	56.00	46.00	-15.75	-8.04	Pass

Report No.: T201104D06-RP3

4.2 6dB BANDWIDTH AND OCCUPIED BANDWIDTH (99%)

4.2.1 Test Limit

According to §15.247(a)(2),

6 dB Bandwidth :

Limit	Shall be at least 500kHz
-------	--------------------------

Occupied Bandwidth(99%) : For reporting purposes only.

4.2.2 Test Procedure

Test method Refer as ANSI C63.10: 2013,

1. The EUT RF output connected to the spectrum analyzer by RF cable.
2. Setting maximum power transmit of EUT
3. SA set RBW = 100kHz, VBW = 300kHz and Detector = Peak, to measurement 6 dB Bandwidth.
4. SA set RBW = 1% ~ 5% OBW, VBW = three times the RBW and Detector = Peak, to measurement 99% Bandwidth
5. Measure and record the result of 6 dB Bandwidth and 99% Bandwidth. in the test report.

4.2.3 Test Setup

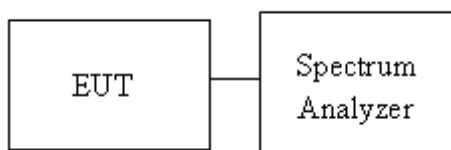

Report No.: T201104D06-RP3

4.2.4 Test Result

Chain 0:

Temperature: 24.7°C

Test date: November 13, 2020

Humidity: 55% RH

Tested by: Rick Lee

Chain 1:

Temperature: 27.1°C

Test date: November 24, 2020

Humidity: 48% RH

Tested by: Rick Lee

Test mode: IEEE 802.11b mode / 2412-2462 MHz						
Channel	Frequency (MHz)	Chain 0 OBW(99%) (MHz)	Chain 1 OBW(99%) (MHz)	Chain 0 6dB BW (MHz)	Chain 1 6dB BW (MHz)	6dB limit (kHz)
Low	2412	13.5021	13.5021	10.0435	10.0435	≥500
Mid	2437	13.5455	13.5021	10.0435	10.0435	
High	2462	13.5455	13.5021	10.0435	10.0435	

Test mode: IEEE 802.11g mode / 2412-2462 MHz						
Channel	Frequency (MHz)	Chain 0 OBW(99%) (MHz)	Chain 1 OBW(99%) (MHz)	Chain 0 6dB BW (MHz)	Chain 1 6dB BW (MHz)	6dB limit (kHz)
Low	2412	16.6714	16.6280	16.6087	16.6087	≥500
Mid	2437	16.6714	16.6280	16.6087	16.6087	
High	2462	16.6714	16.6280	16.6087	16.6087	

Test mode: IEEE 802.11n HT 20 MHz mode / 2412-2462 MHz						
Channel	Frequency (MHz)	Chain 0 OBW(99%) (MHz)	Chain 1 OBW(99%) (MHz)	Chain 0 6dB BW (MHz)	Chain 1 6dB BW (MHz)	6dB limit (kHz)
Low	2412	17.6266	17.6700	17.7391	17.6522	≥500
Mid	2437	17.7134	17.6700	17.6957	17.6522	
High	2462	17.6266	17.6700	17.7391	17.6522	

Report No.: T201104D06-RP3

Test Data

6dB BANDWIDTH

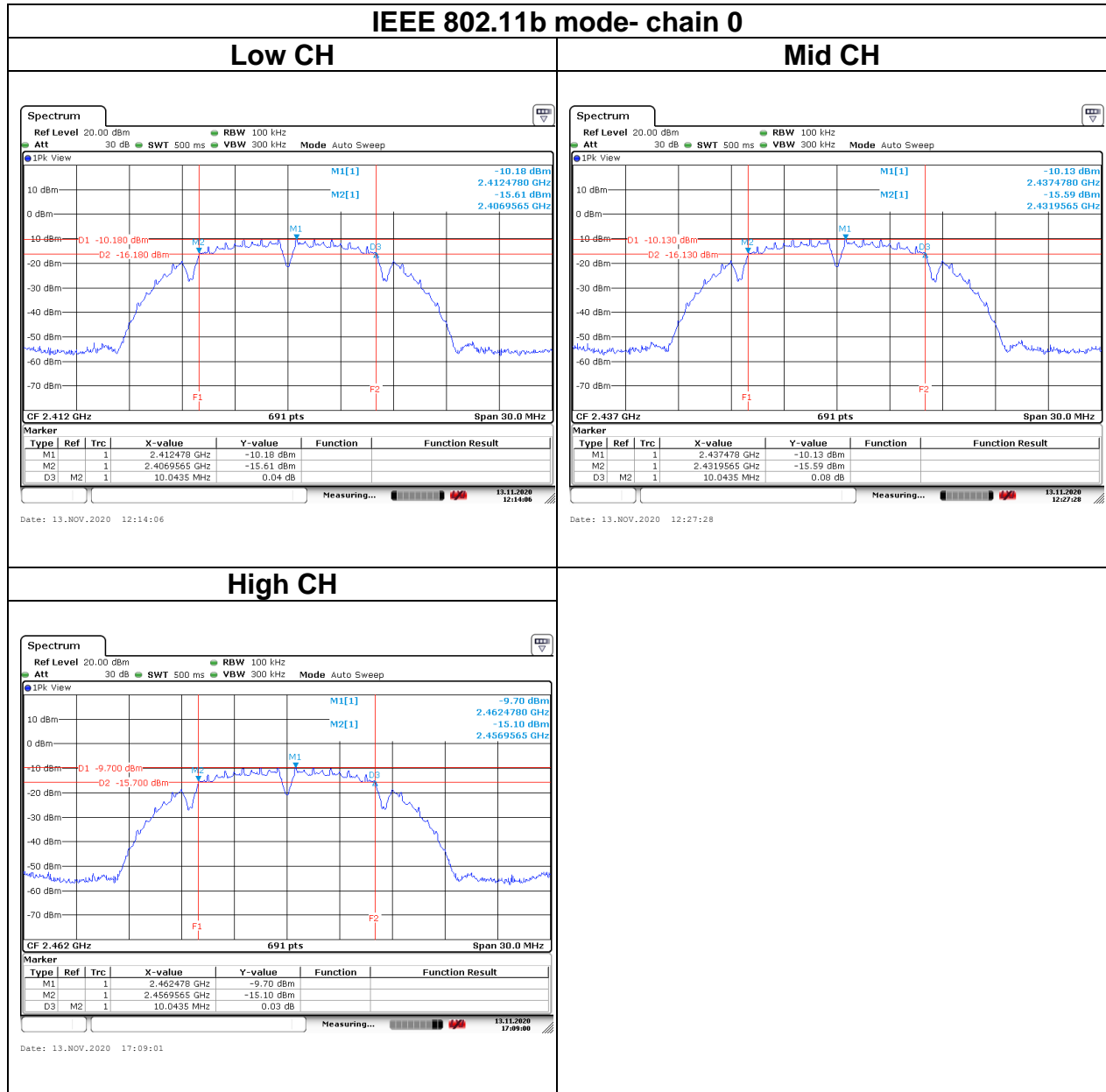

Report No.: T201104D06-RP3

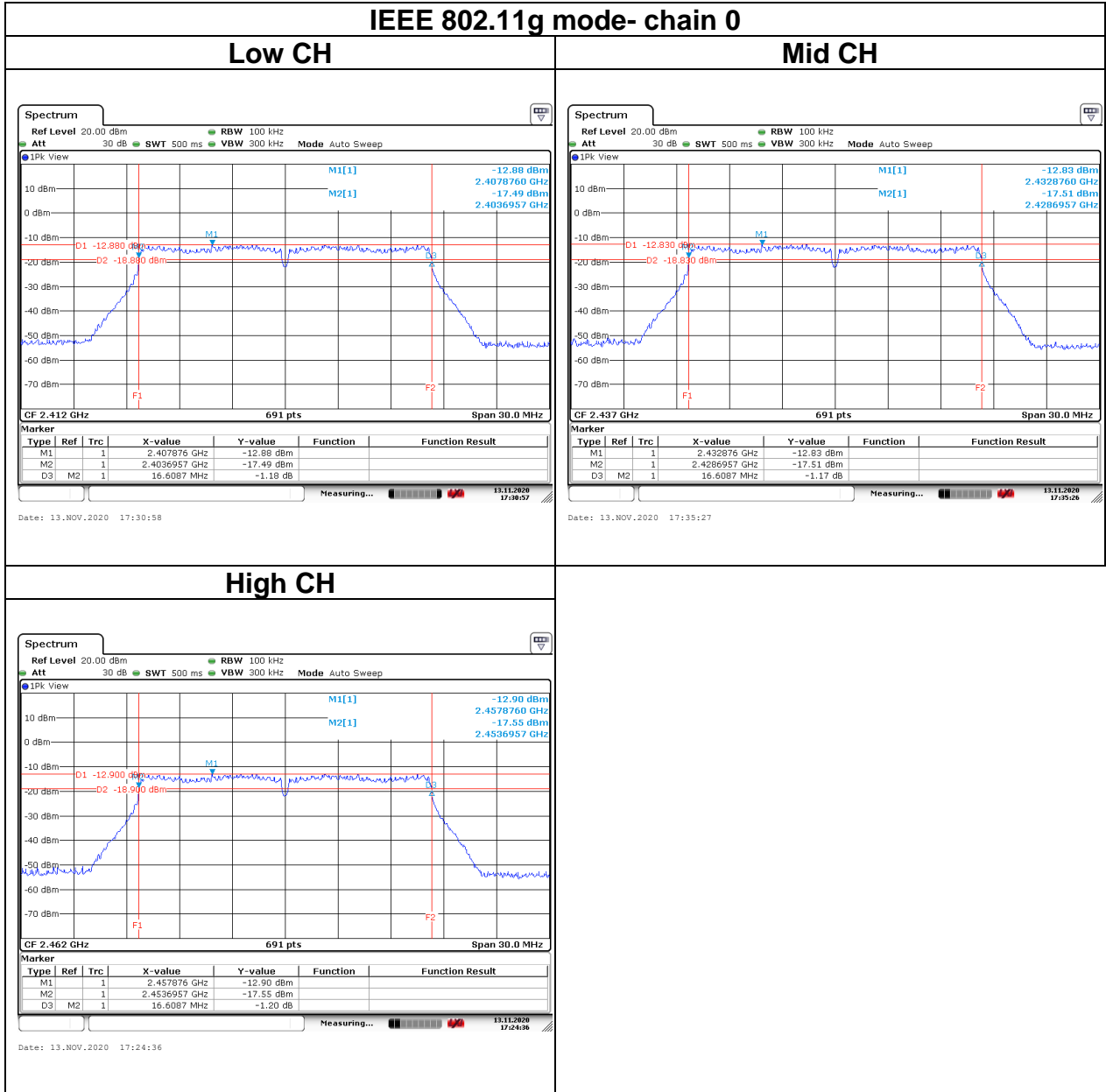

Report No.: T201104D06-RP3

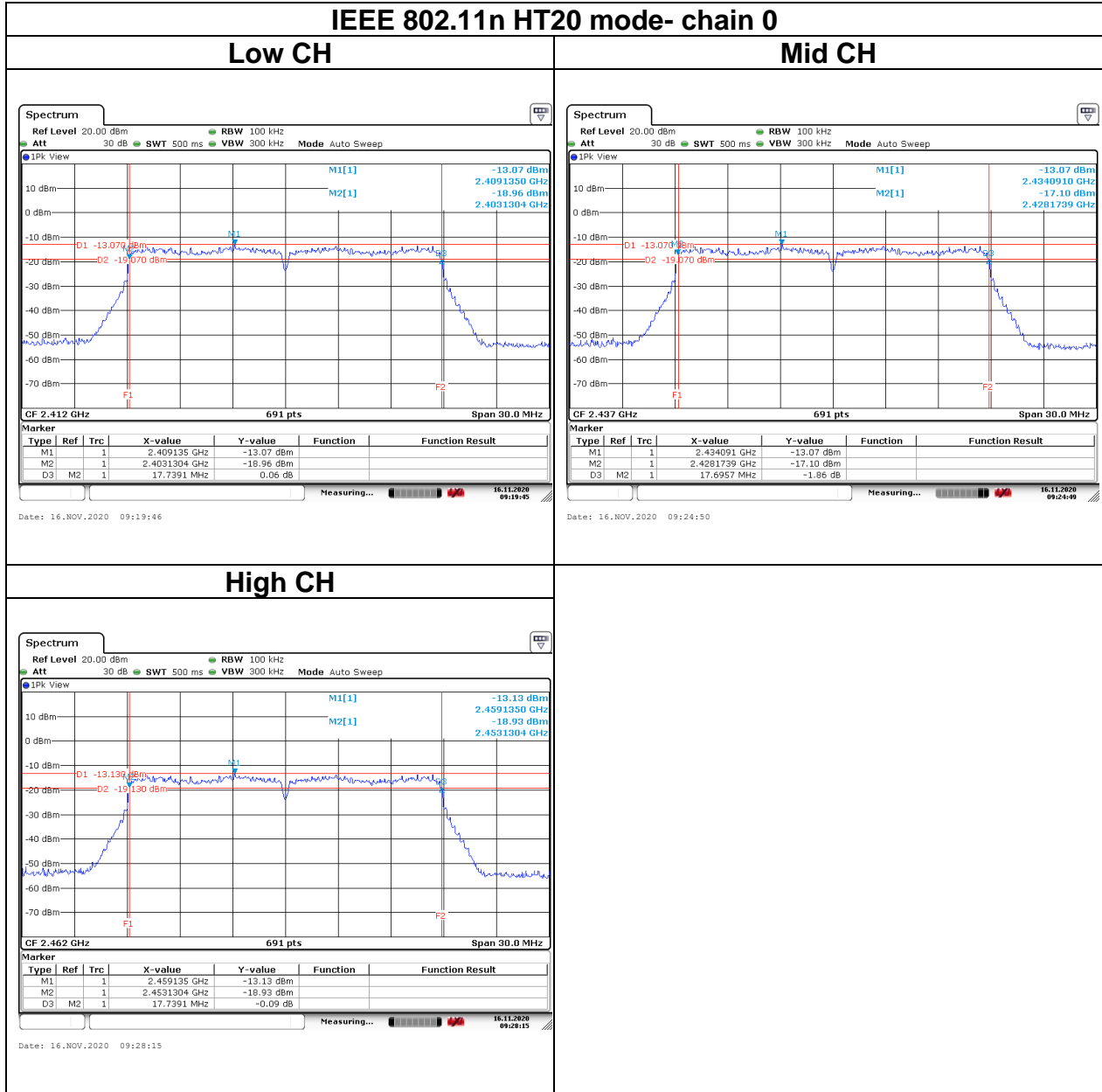

Report No.: T201104D06-RP3

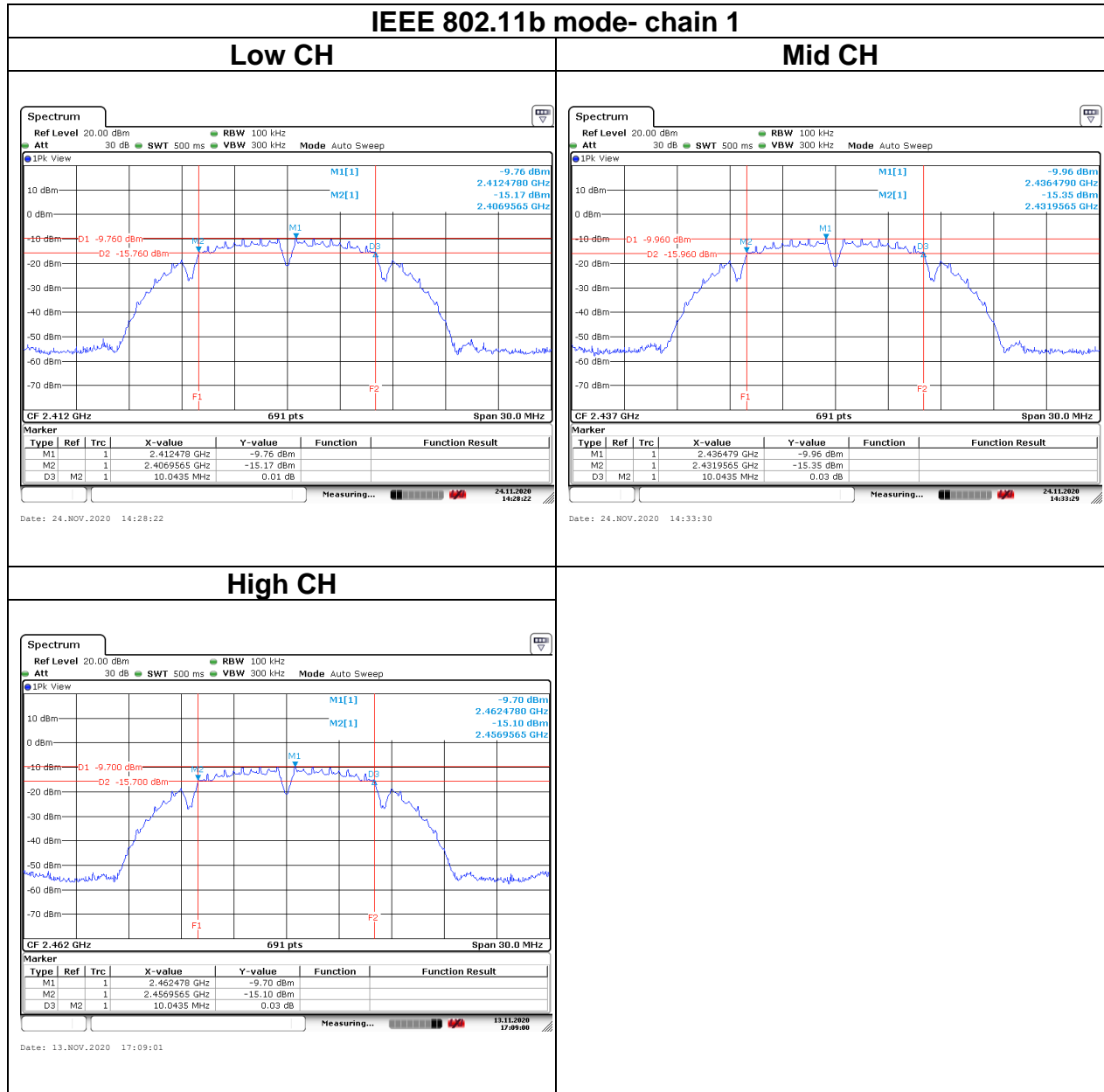

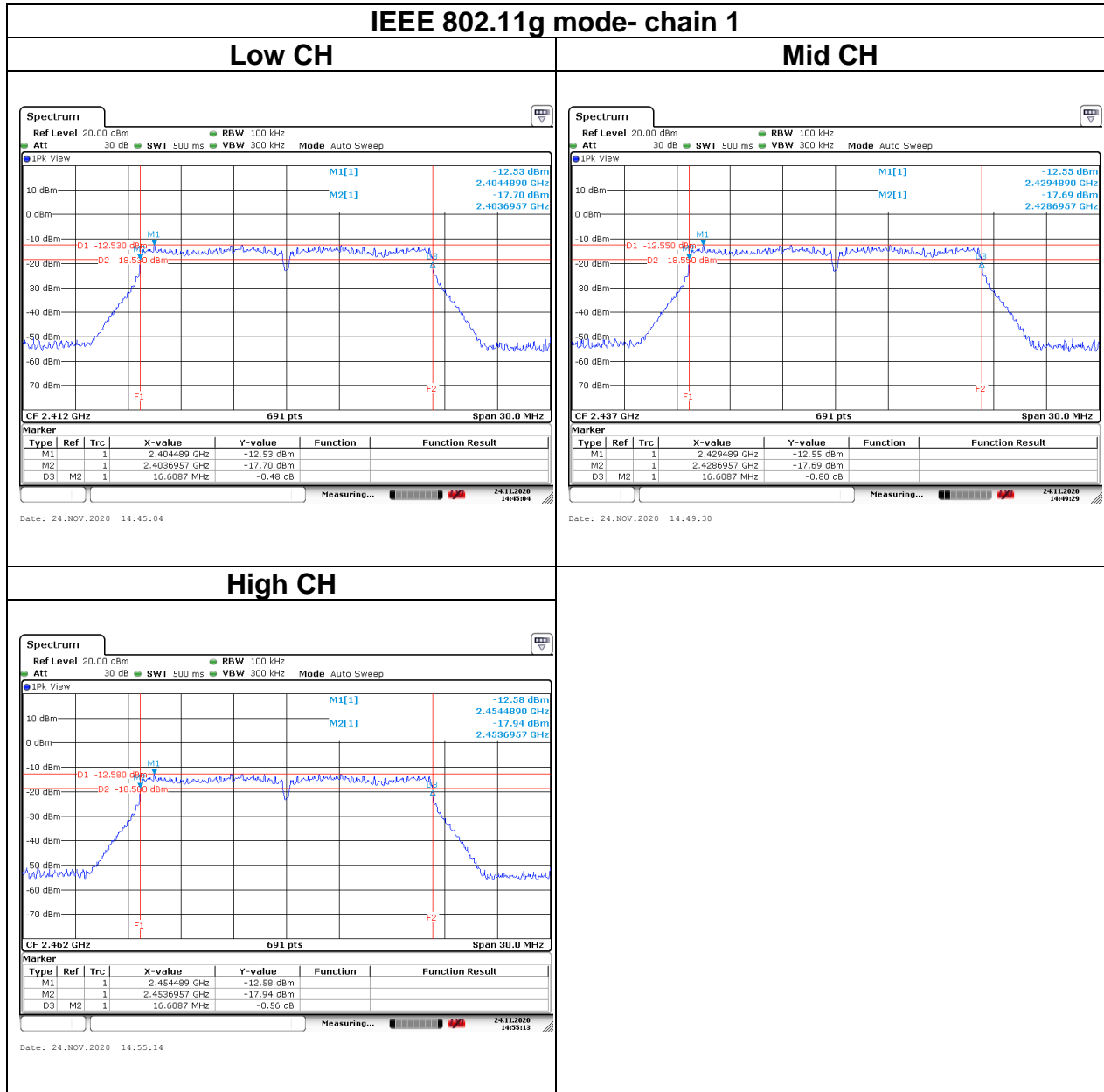

Report No.: T201104D06-RP3

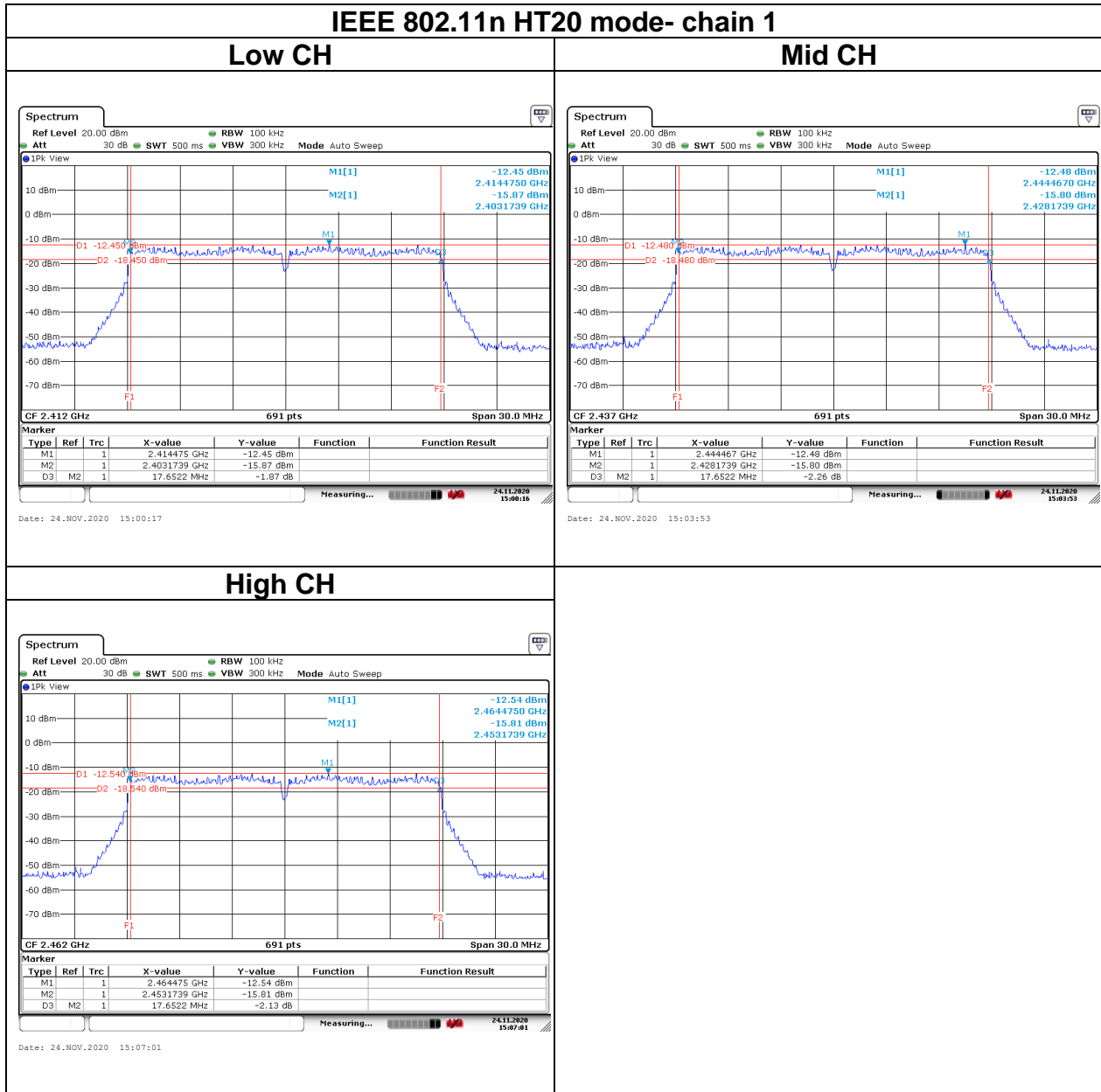

Report No.: T201104D06-RP3

Test Data

BANDWIDTH 99%

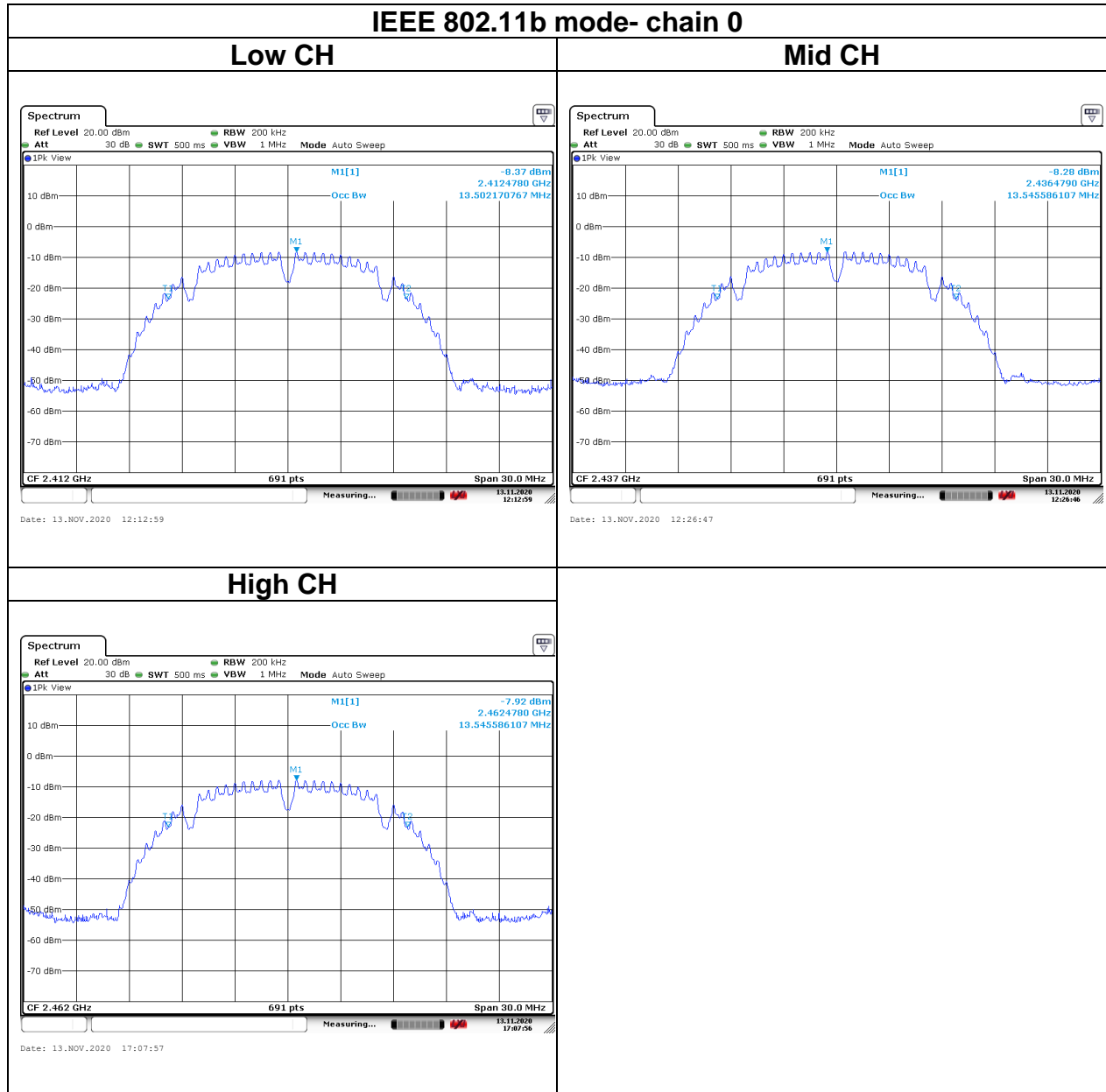

Report No.: T201104D06-RP3

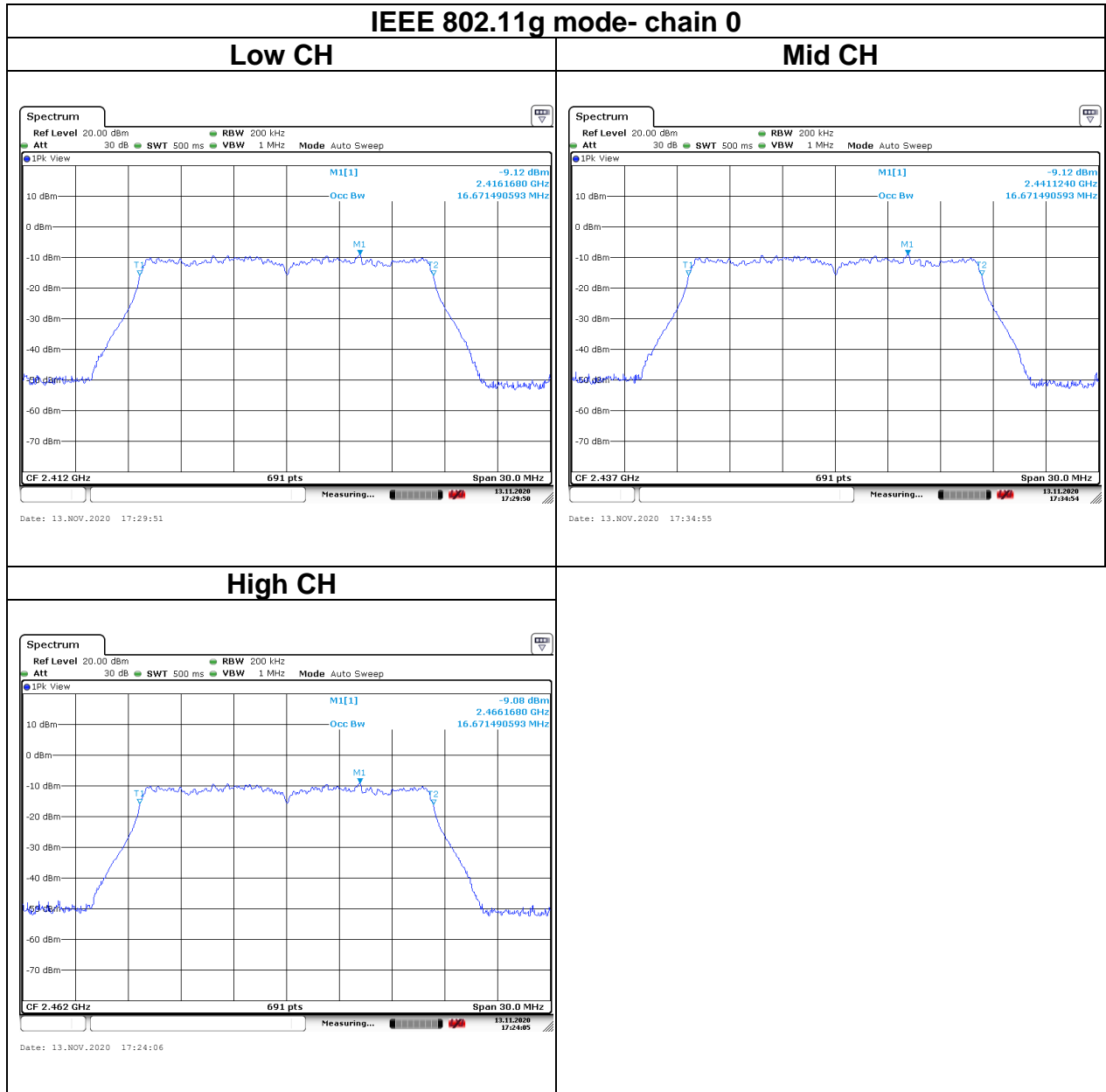

Report No.: T201104D06-RP3

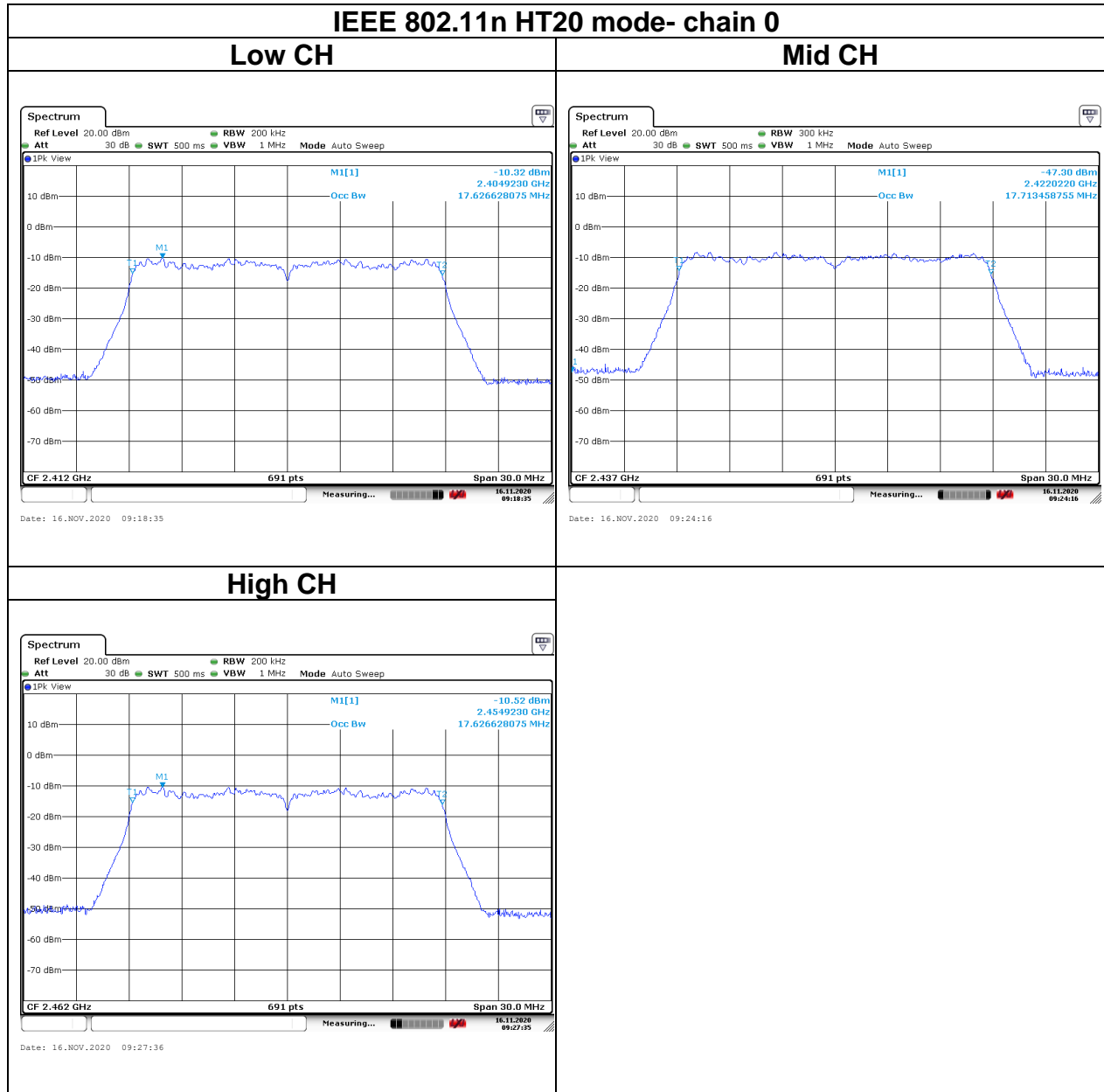

Report No.: T201104D06-RP3

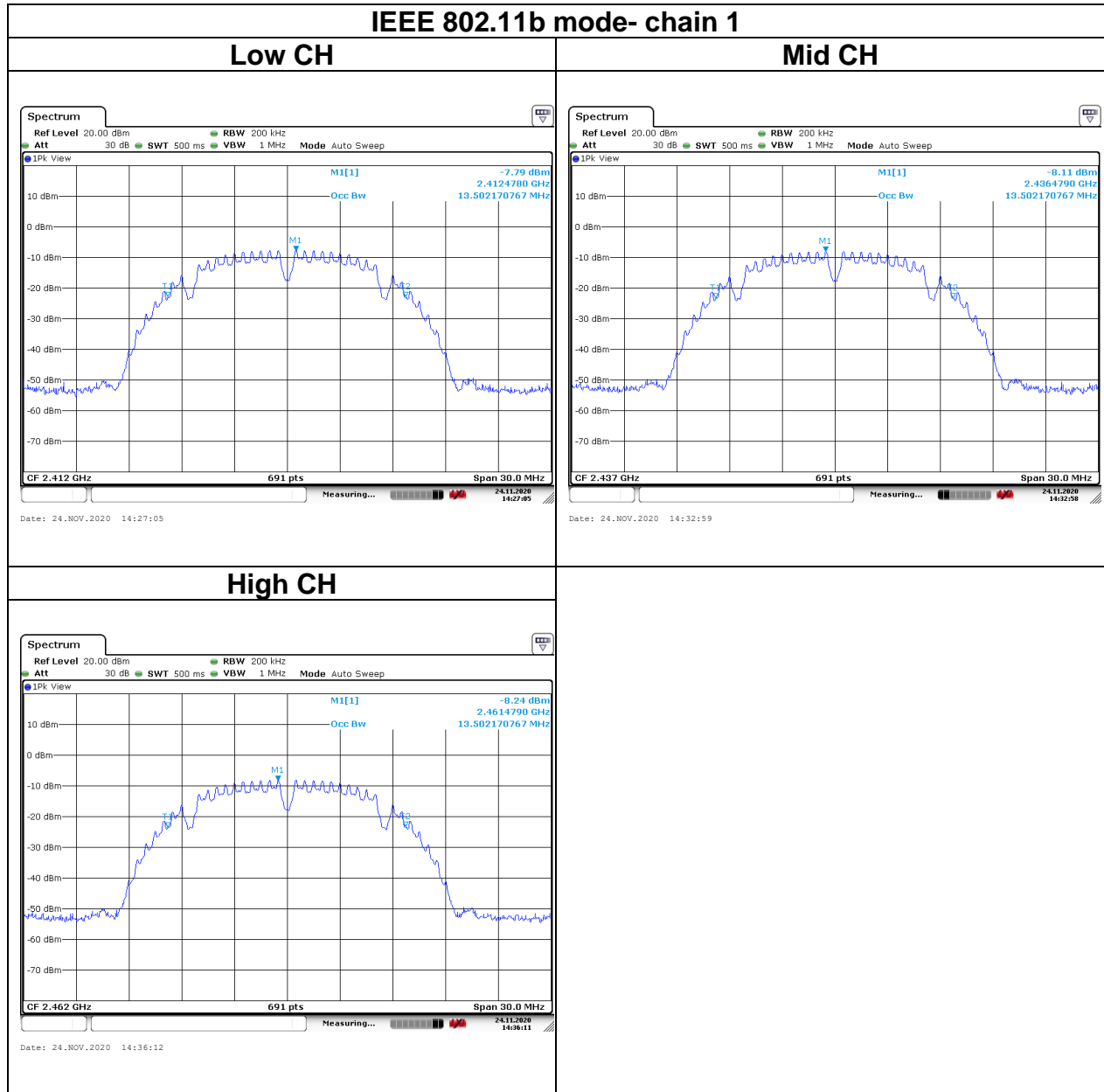

Report No.: T201104D06-RP3

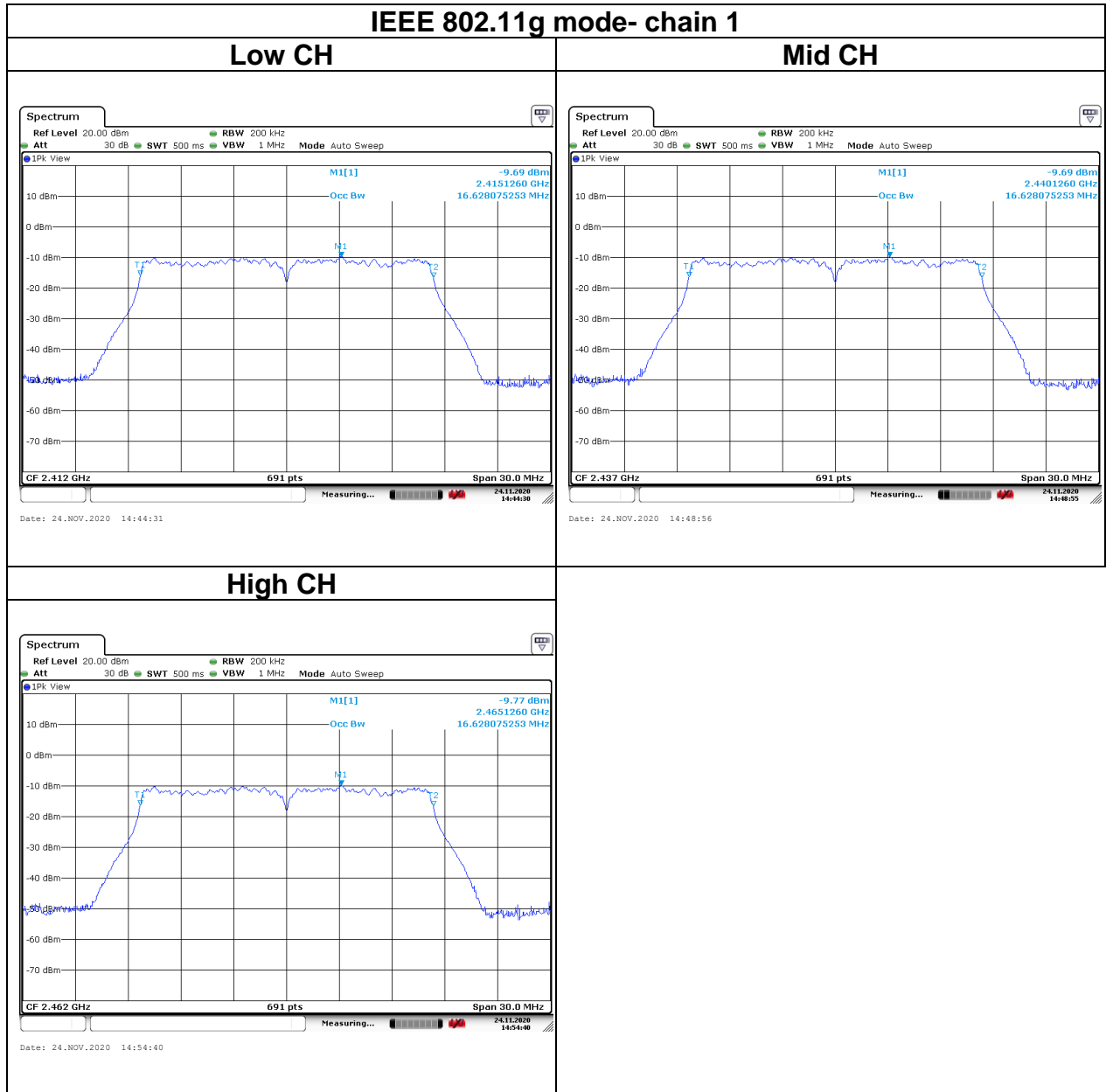

Report No.: T201104D06-RP3

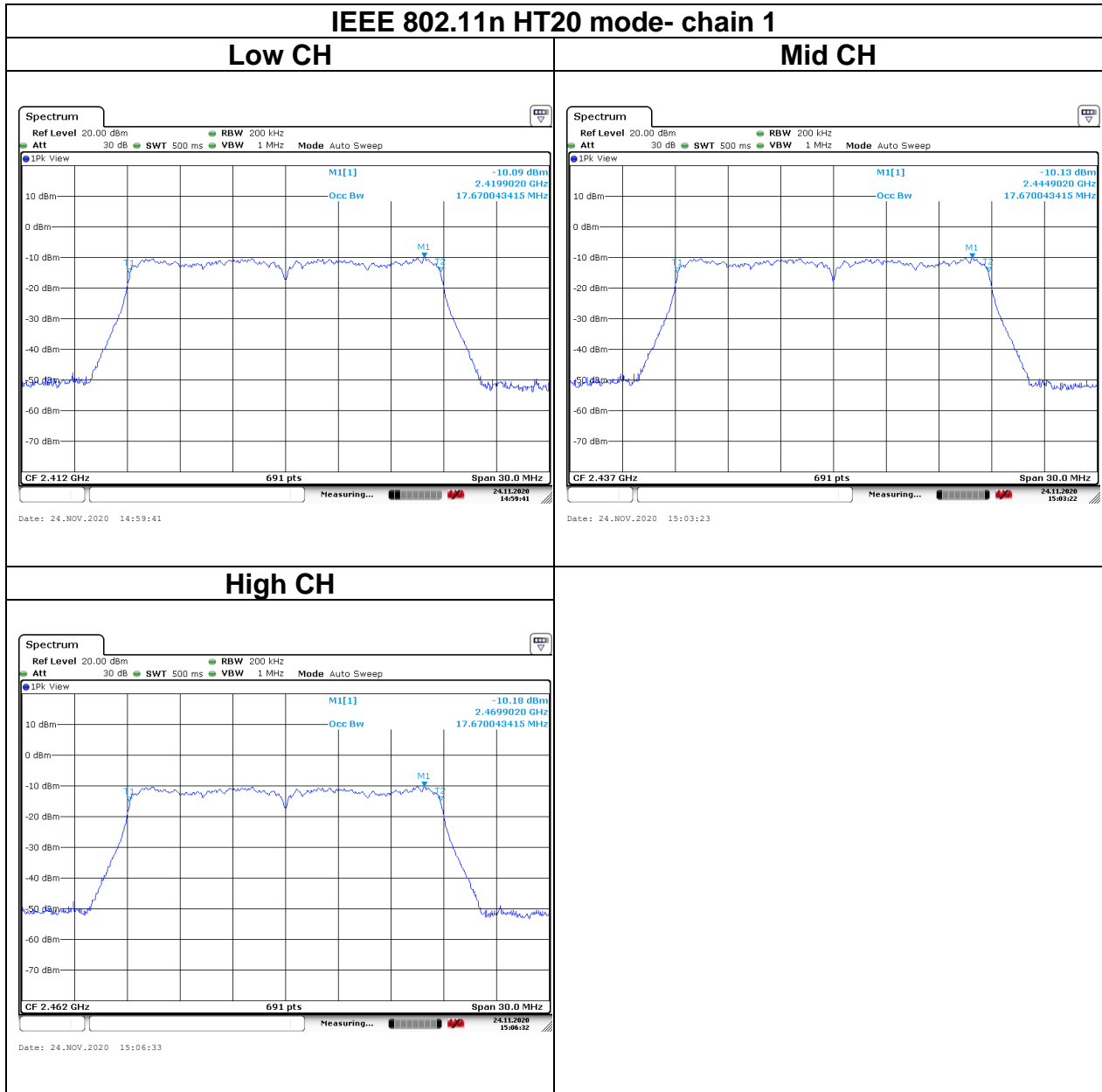

Report No.: T201104D06-RP3

4.3 OUTPUT POWER MEASUREMENT

4.3.1 Test Limit

According to §15.247(b),

Peak output power :

For systems using digital modulation in the 2400-2483.5 MHz, and 5725-5850 MHz bands: 1 Watt(30 dBm) and the e.i.r.p. shall not exceed 4Watt(36 dBm), base on the use of antennas with directional gain not exceed 6 dBi If transmitting antennas of directional gain greater than 6dBi are used the peak output power the conducted output power from the intentional radiator shall be reduced by the amount in dB that the directional gain of the antenna exceeds 6 dBi. In case of point-to-point operation, the limit has to be reduced by 1dB for every 3 dB that the directional gain of the antenna exceeds 6 dBi.

Limit	<input checked="" type="checkbox"/> Antenna not exceed 6 dBi : 30dBm <input type="checkbox"/> Antenna with DG greater than 6 dBi : [Limit = 30 – (DG – 6)] <input type="checkbox"/> Point-to-point operation :
-------	---

Average output power : For reporting purposes only.

4.3.2 Test Procedure

Test method Refer as ANSI C63.10:2013.

1. The EUT RF output connected to the power meter by RF cable.
2. Setting maximum power transmit of EUT.
3. The path loss was compensated to the results for each measurement.
4. Measure and record the result of Peak output power and Average output power. in the test report.

4.3.3 Test Setup

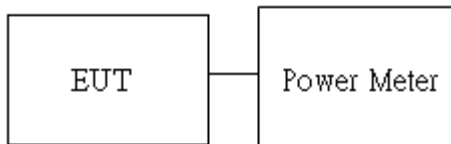

Report No.: T201104D06-RP3

4.4 POWER SPECTRAL DENSITY

4.4.1 Test Limit

According to §15.247(e),

For digitally modulated systems, the power spectral density conducted from the intentional radiator to the antenna shall not be greater than 8 dBm in any 3 kHz band during any time interval of continuous transmission.

Limit	<input checked="" type="checkbox"/> Antenna not exceed 6 dBi : 8dBm <input type="checkbox"/> Antenna with DG greater than 6 dBi : [Limit = 8 – (DG – 6)] <input type="checkbox"/> Point-to-point operation :
-------	---

4.4.2 Test Procedure

Test method Refer as ANSI C63.10:2013,

1. The EUT RF output connected to the spectrum analyzer by RF cable.
2. Setting maximum power transmit of EUT
3. SA set RBW = 3kHz, VBW = 30kHz, Span = 1.5 times DTS Bandwidth (6 dB BW), Detector = Peak, Sweep Time = Auto and Trace = Max hold.
4. The path loss and Duty Factor were compensated to the results for each measurement by SA.
5. Mark the maximum level.
6. Measure and record the result of power spectral density. in the test report.

4.4.3 Test Setup

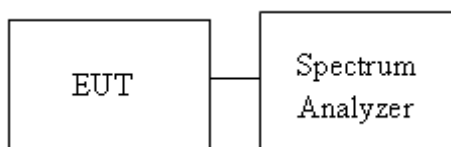

Report No.: T201104D06-RP3

4.4.4 Test Result

Chain 0:

Temperature: 24.7°C

Test date: November 13, 2020

Humidity: 55% RH

Tested by: Rick Lee

Chain 1:

Temperature: 27.1°C

Test date: November 24, 2020

Humidity: 48% RH

Tested by: Rick Lee

Test mode: IEEE 802.11b mode / 2412-2462 MHz					
Channel	Frequency (MHz)	Chain 0 PPSD (dBm)	Chain 1 PPSD (dBm)	Total PPSD (dBm)	Limit (dBm)
Low	2412	-17.82	-17.49	-14.64	8
Mid	2437	-17.80	-17.62	-14.70	
High	2462	-17.38	-17.77	-14.56	

Test mode: IEEE 802.11g mode / 2412-2462 MHz					
Channel	Frequency (MHz)	Chain 0 PPSD (dBm)	Chain 1 PPSD (dBm)	Total PPSD (dBm)	Limit (dBm)
Low	2412	-15.62	-15.62	-12.61	8
Mid	2437	-15.62	-15.64	-12.62	
High	2462	-15.60	-15.73	-12.65	

Test mode: IEEE 802.11n HT 20 MHz mode / 2412-2462 MHz					
Channel	Frequency (MHz)	Chain 0 PPSD (dBm)	Chain 1 PPSD (dBm)	Total PPSD (dBm)	Limit (dBm)
Low	2412	-16.29	-15.34	-12.78	8
Mid	2437	-16.38	-15.37	-12.84	
High	2462	-16.54	-15.40	-12.92	

Report No.: T201104D06-RP3

Test Data

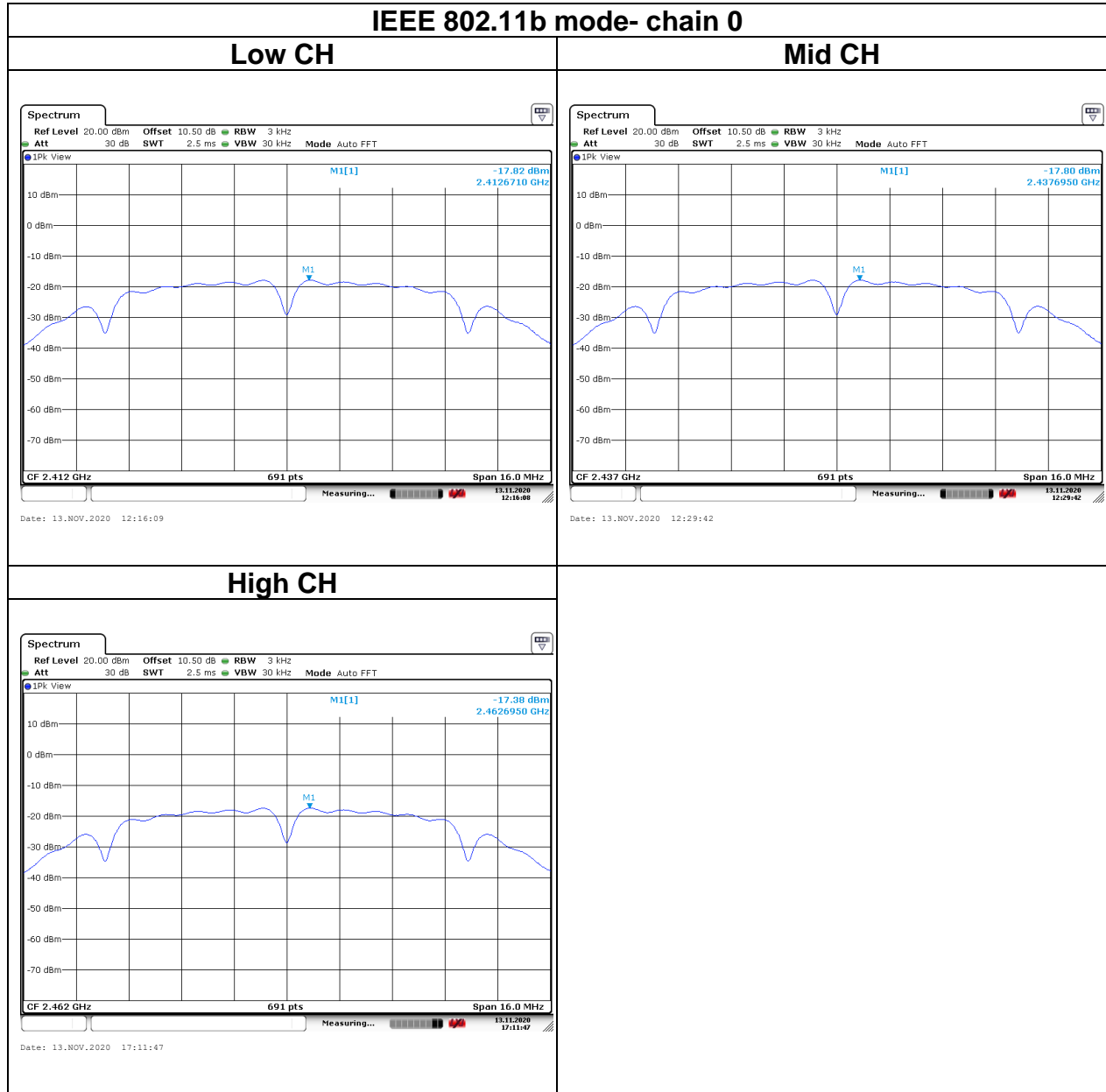

Report No.: T201104D06-RP3

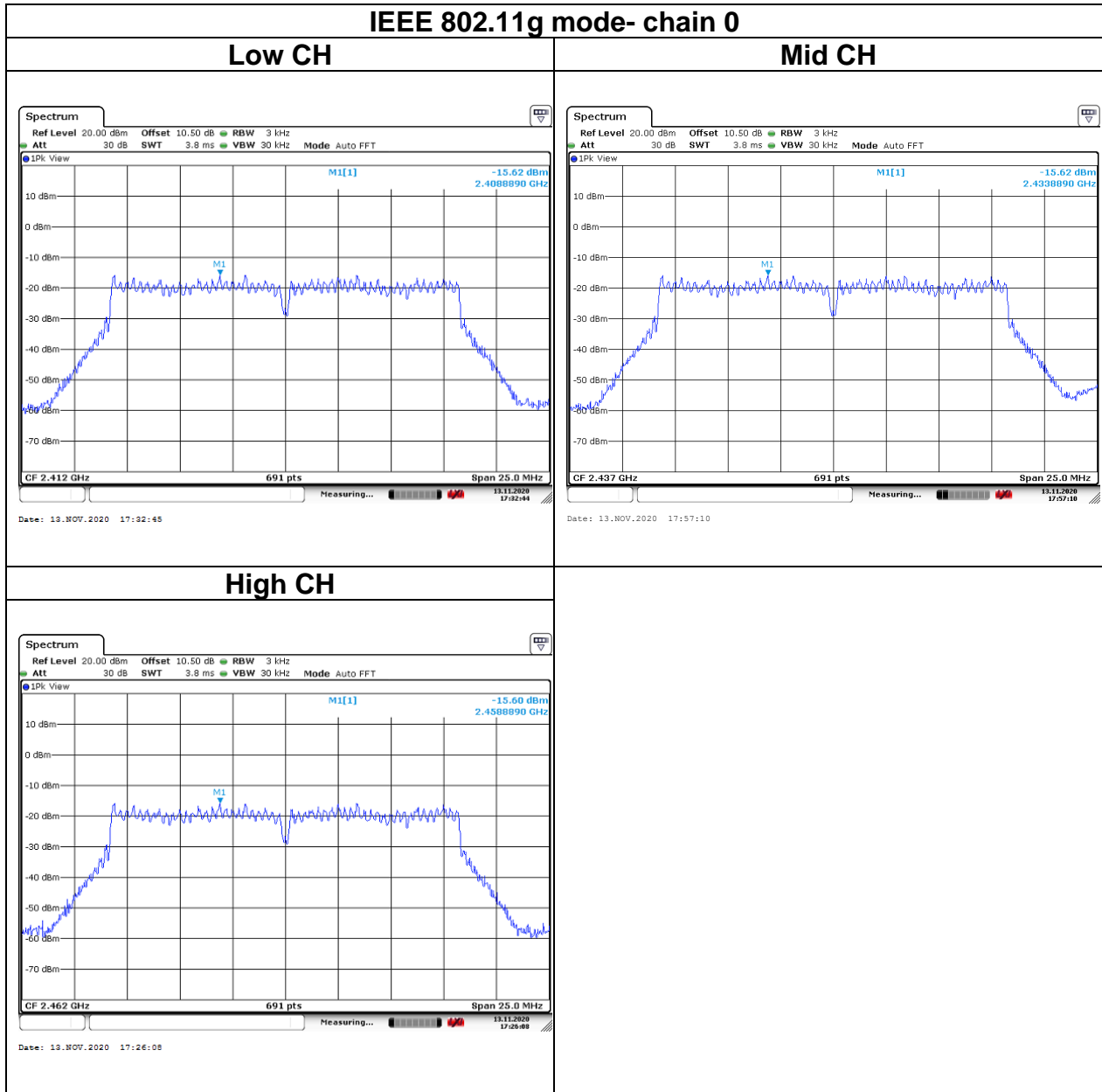

Report No.: T201104D06-RP3

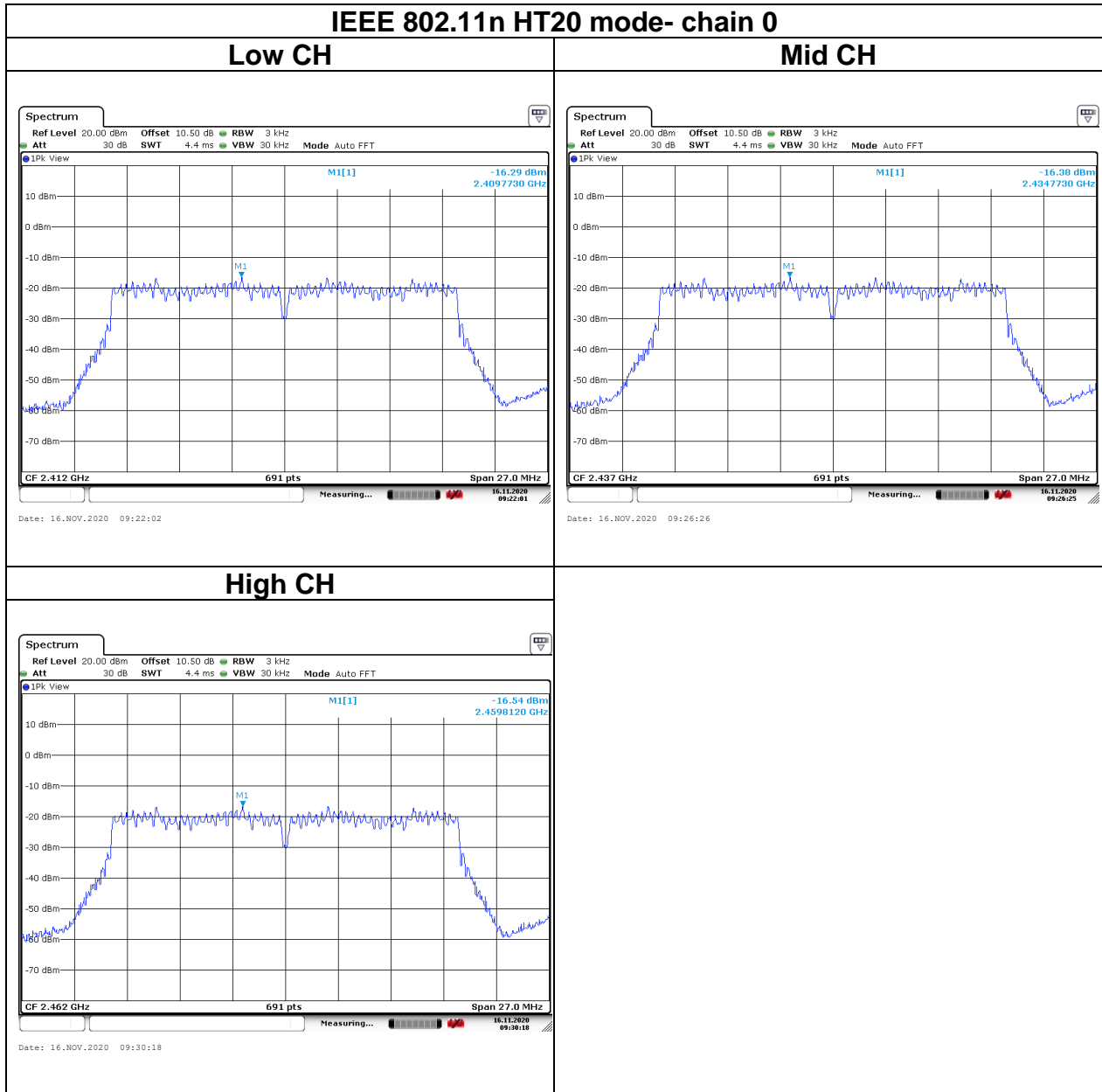

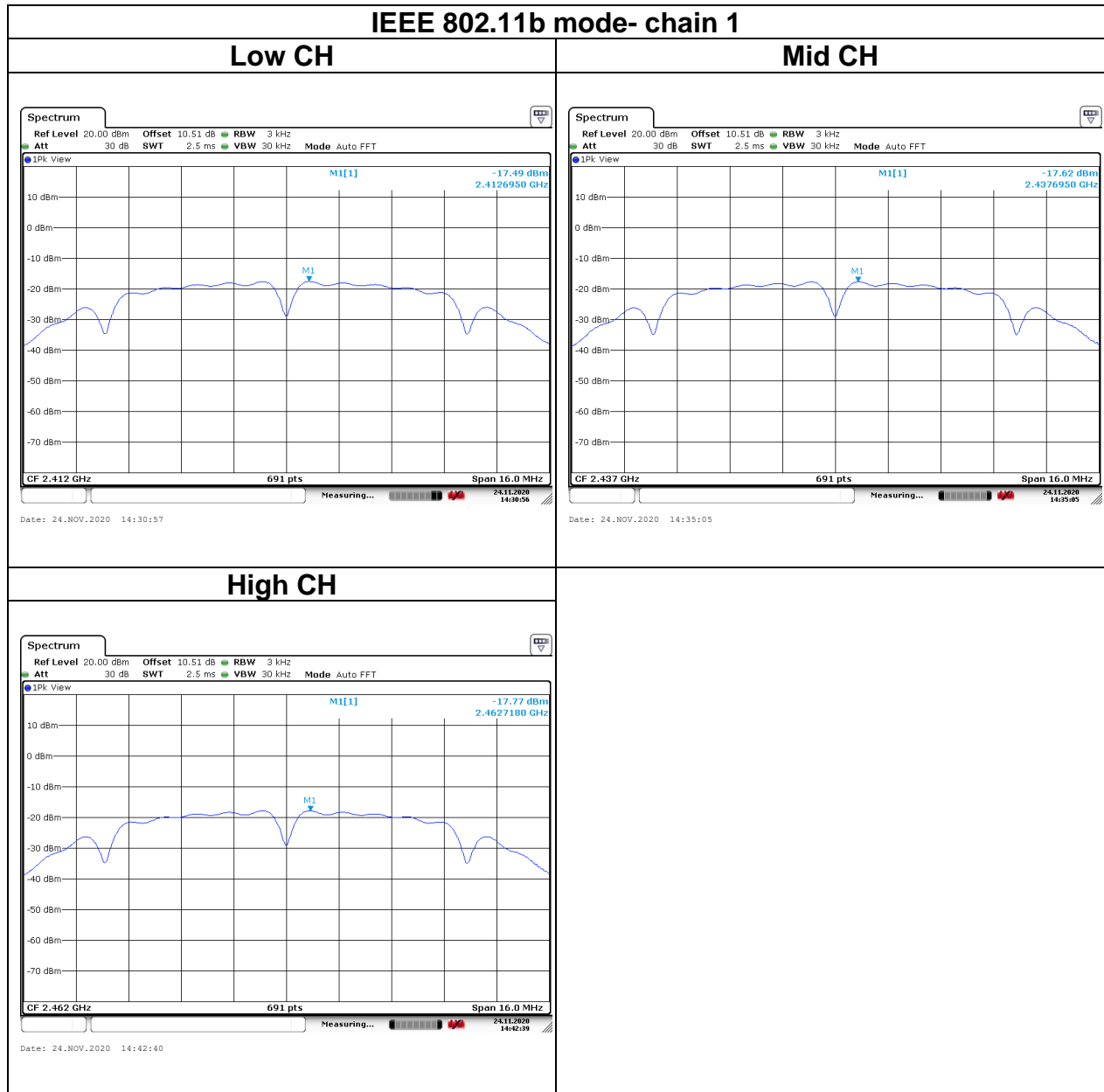

Report No.: T201104D06-RP3

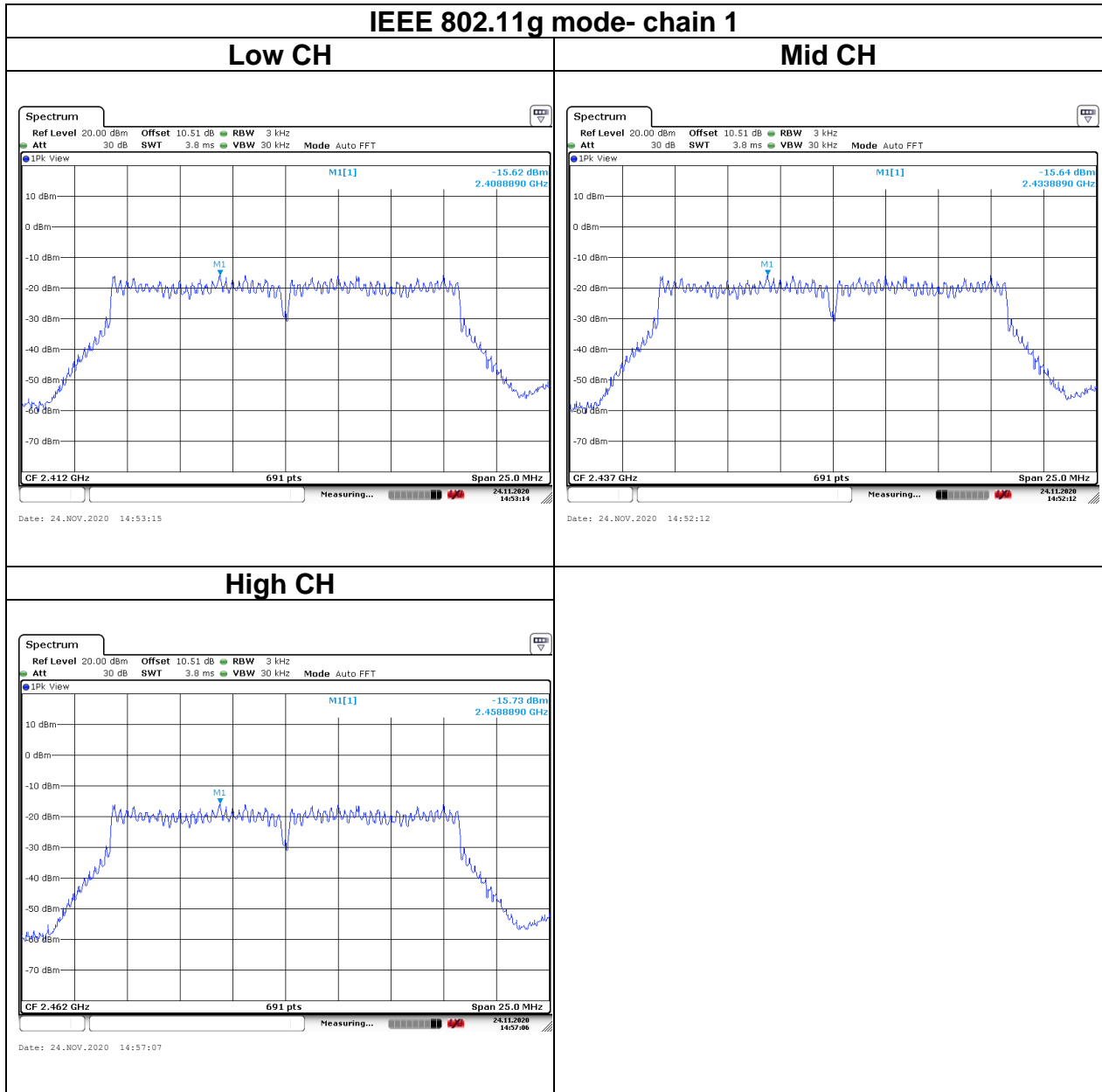

Report No.: T201104D06-RP3

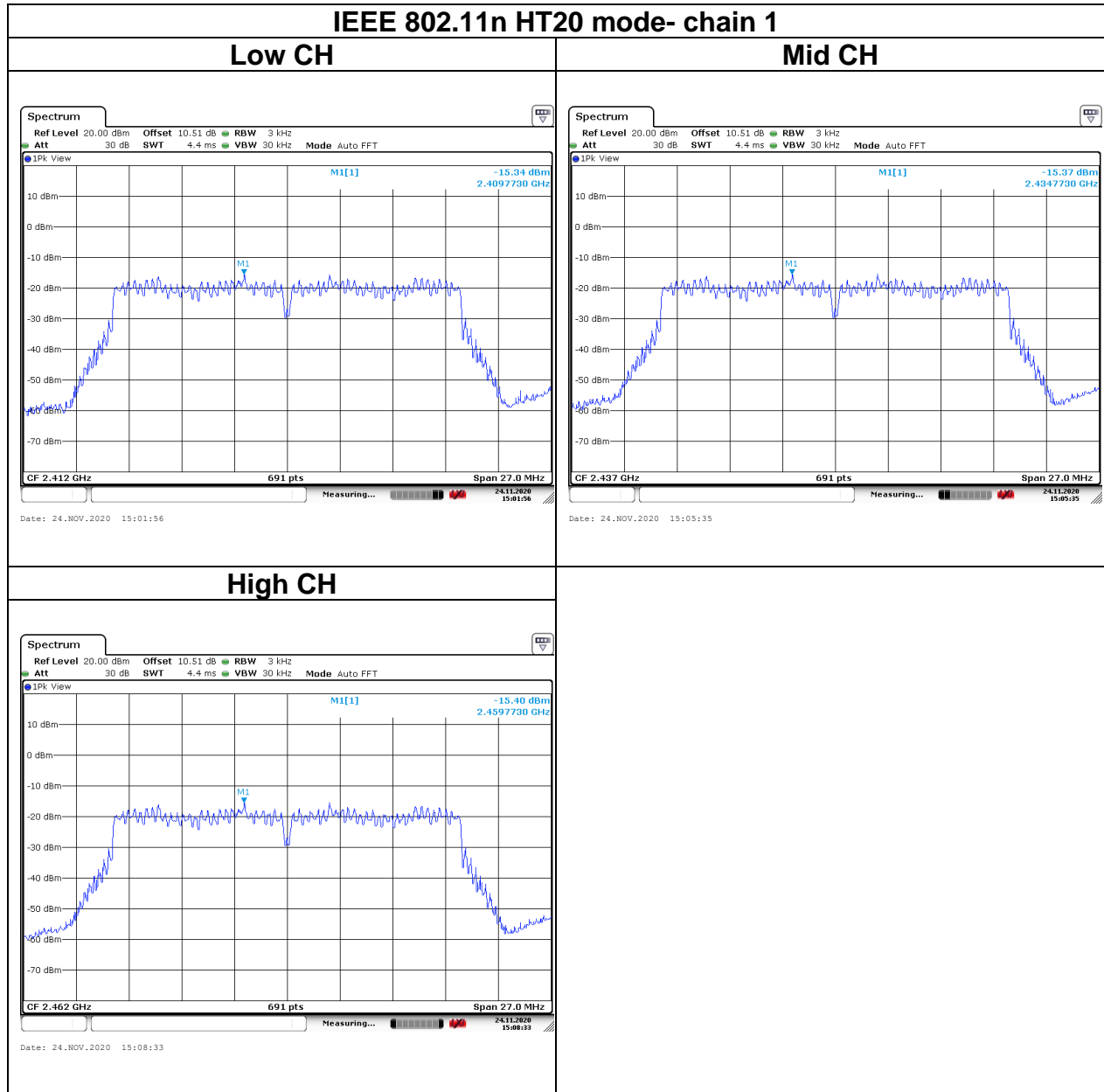

4.5 CONDUCTED BANDEDGE AND SPURIOUS EMISSION

4.5.1 Test Limit

According to §15.247(d),

In any 100 kHz bandwidth outside the authorized frequency band,

Non-restricted bands shall be attenuated at least 20 dB/30 dB relative to the maximum PSD level in 100 kHz by RF conducted or a radiated measurement which fall in the restricted bands, as defined in §15.205(a), must also comply with the radiated emission limits specified in §15.209(a).

4.5.2 Test Procedure

Test method Refer as KDB 662911 D01, ANSI C63.10:2013.

1. EUT RF output port connected to the SA by RF cable, and the path loss was compensated to result.
2. SA setting, RBW=100kHz, VBW=300kHz, Detector=Peak, Trace mode = max hold, SWT = Auto.
3. In any 100 kHz bandwidth outside the authorized frequency band, shall be attenuated at least 20 dB relative to the maximum in-band peak PSD level in 100 kHz when conducted power procedure is used. If the transmitter complies with the conducted power limits based on the use of RMS averaging over a time interval, the attenuation required under this paragraph shall be 30 dB instead of 20 dB.

4.5.3 Test Setup

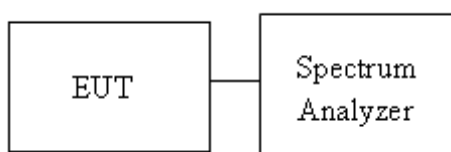

4.5.4 Test Result

Chain 0:

Temperature: 24.7°C

Humidity: 55% RH

Test date: November 13, 2020

Tested by: Rick Lee

Chain 1:

Temperature: 27.1°C

Humidity: 48% RH

Test date: November 24, 2020

Tested by: Rick Lee

Report No.: T201104D06-RP3

Test Data

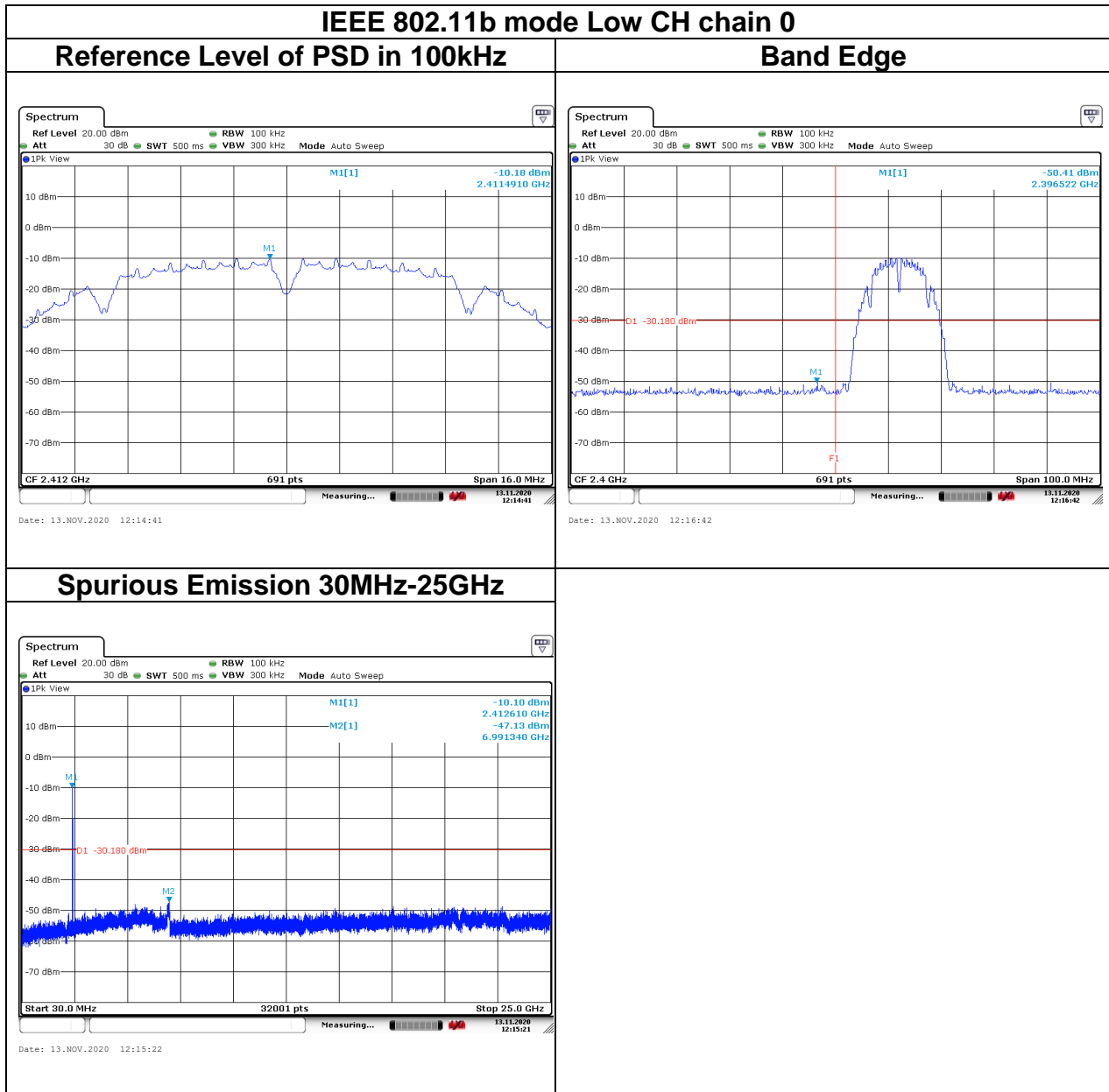

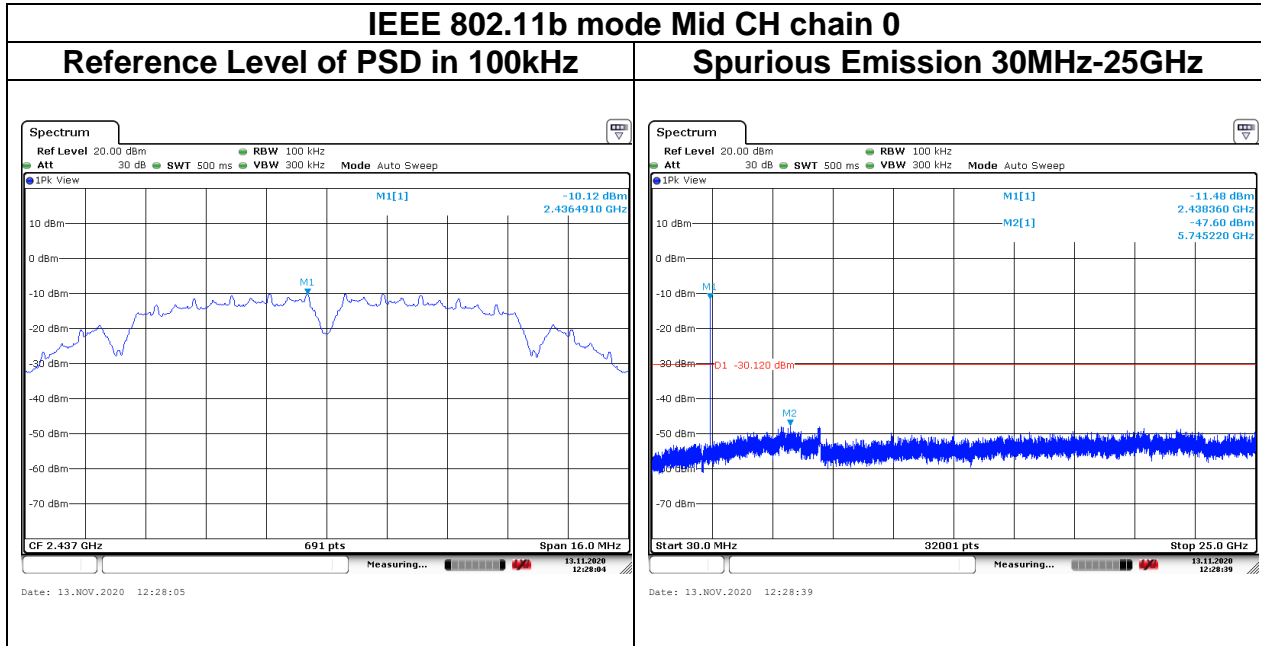

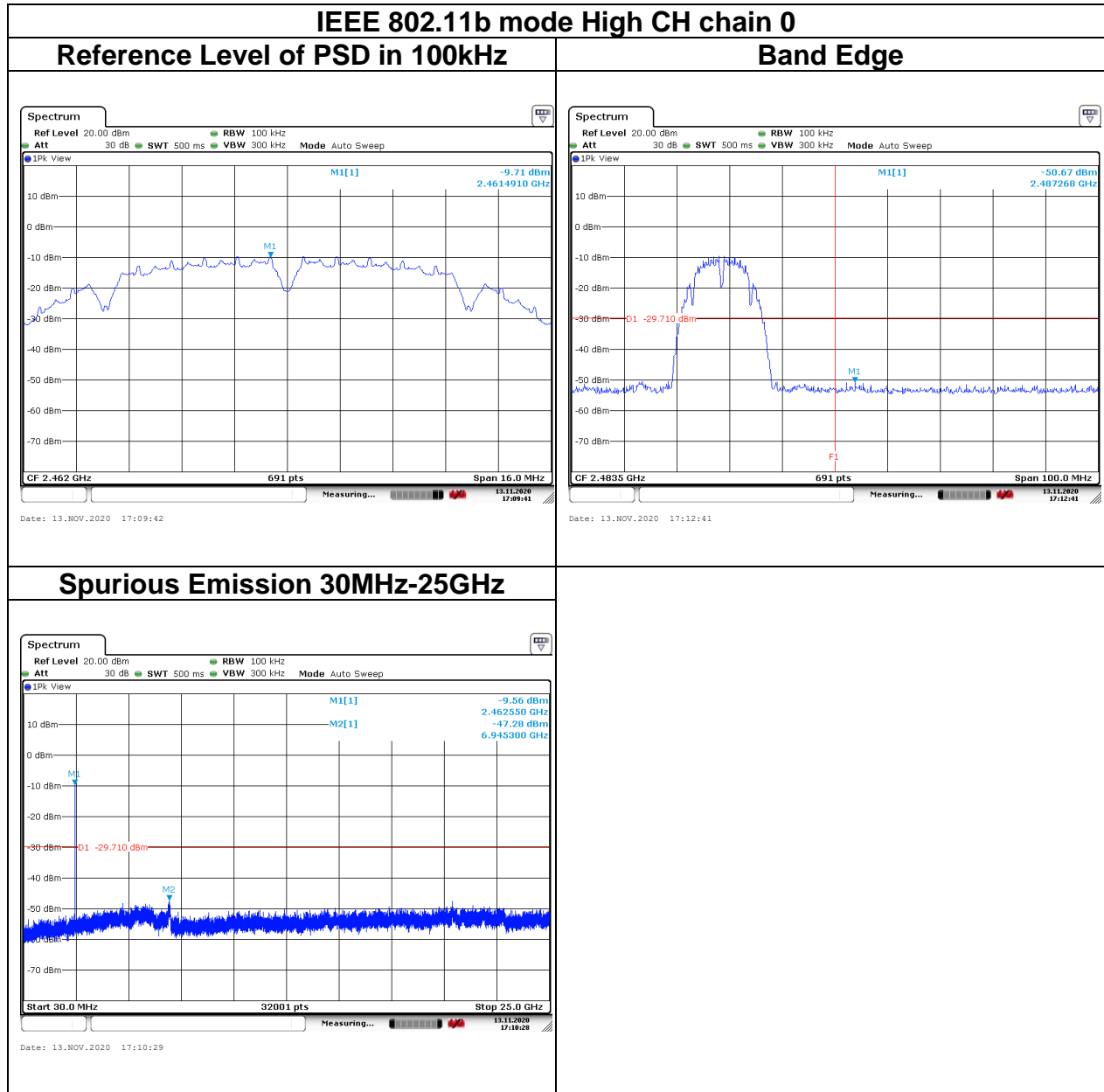

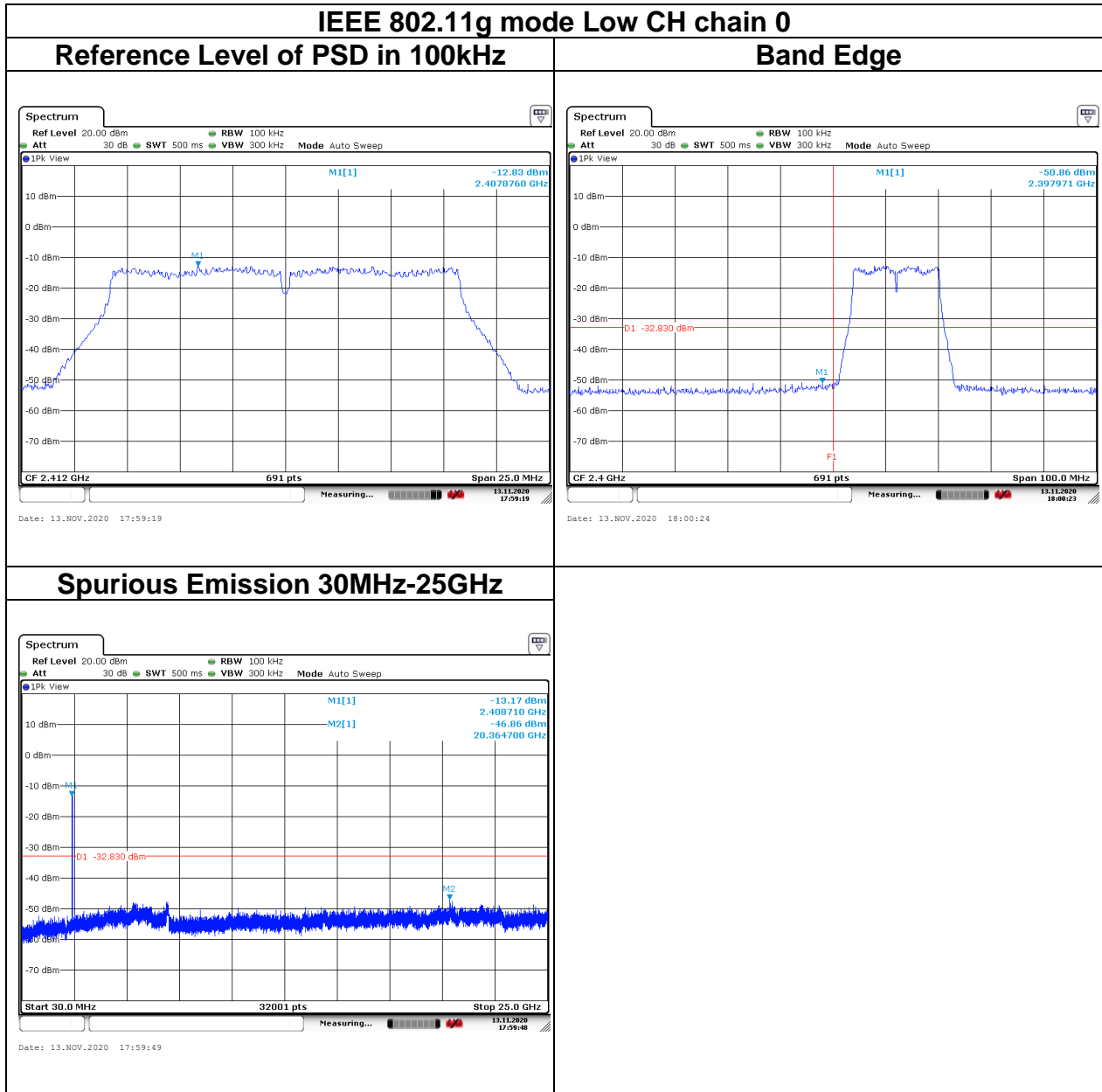

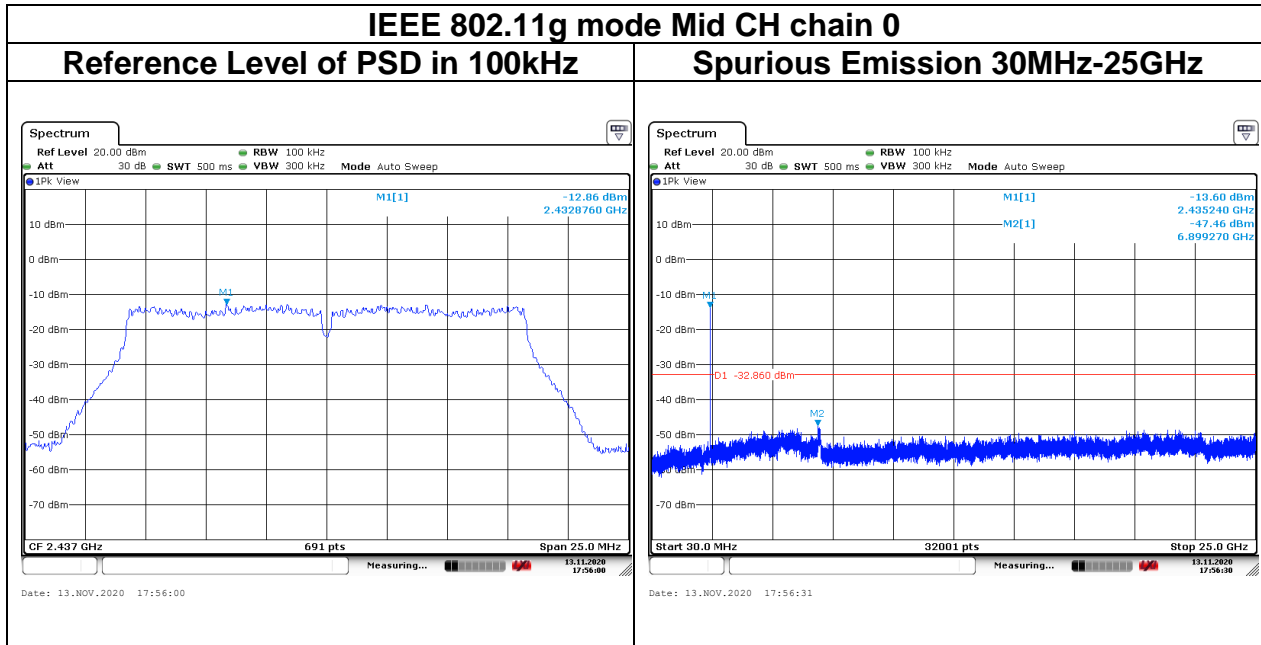

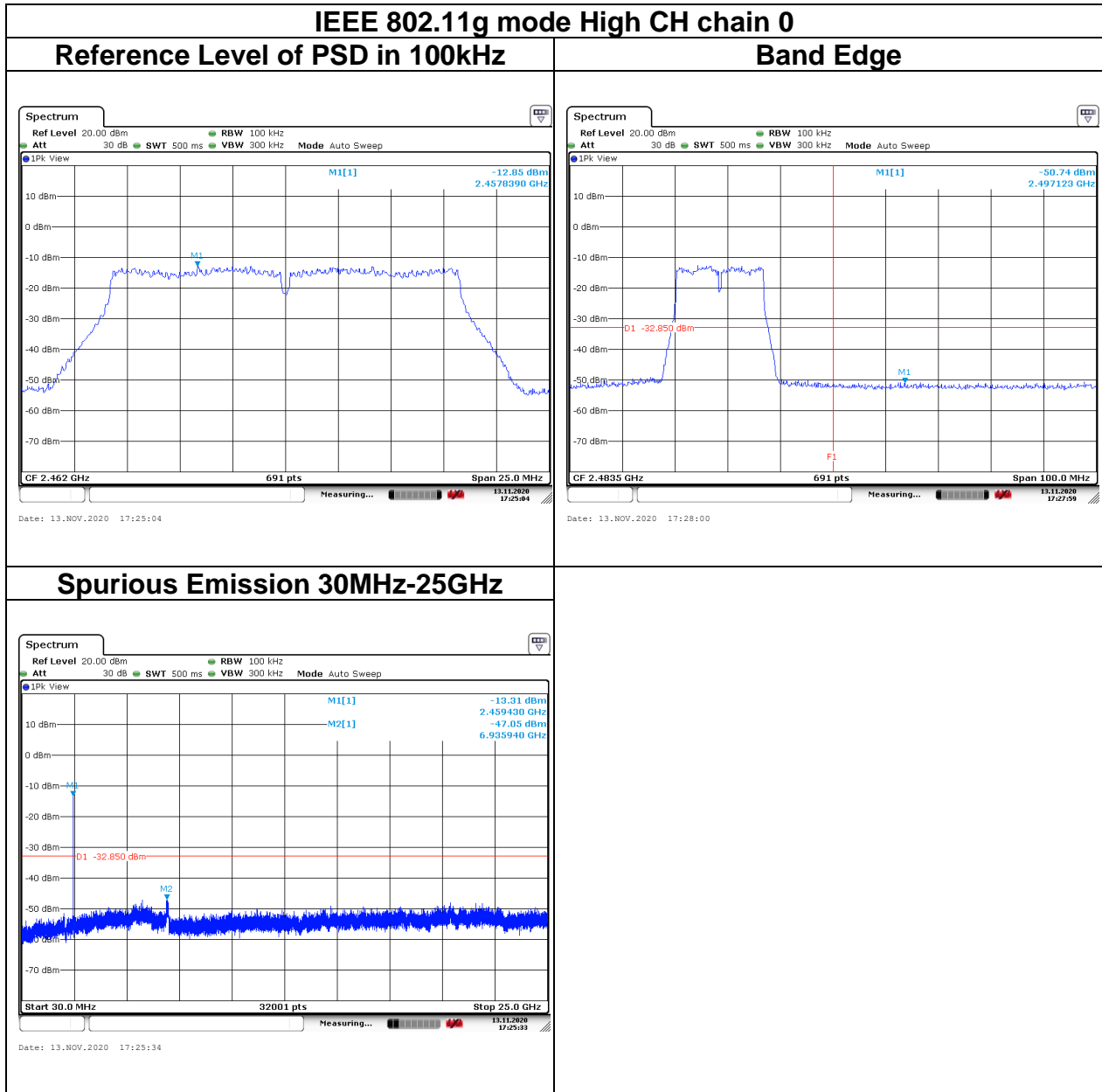

Report No.: T201104D06-RP3

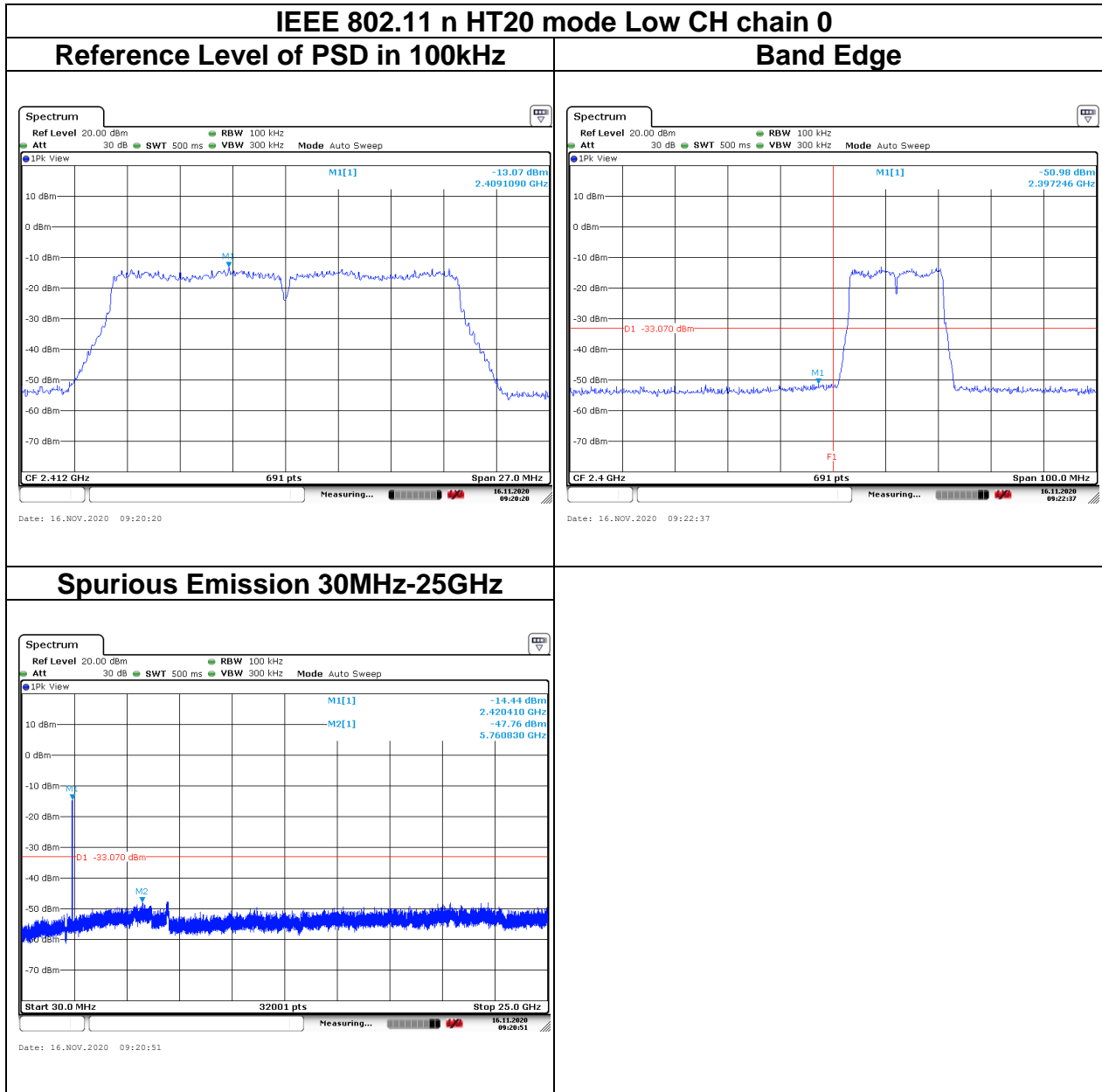

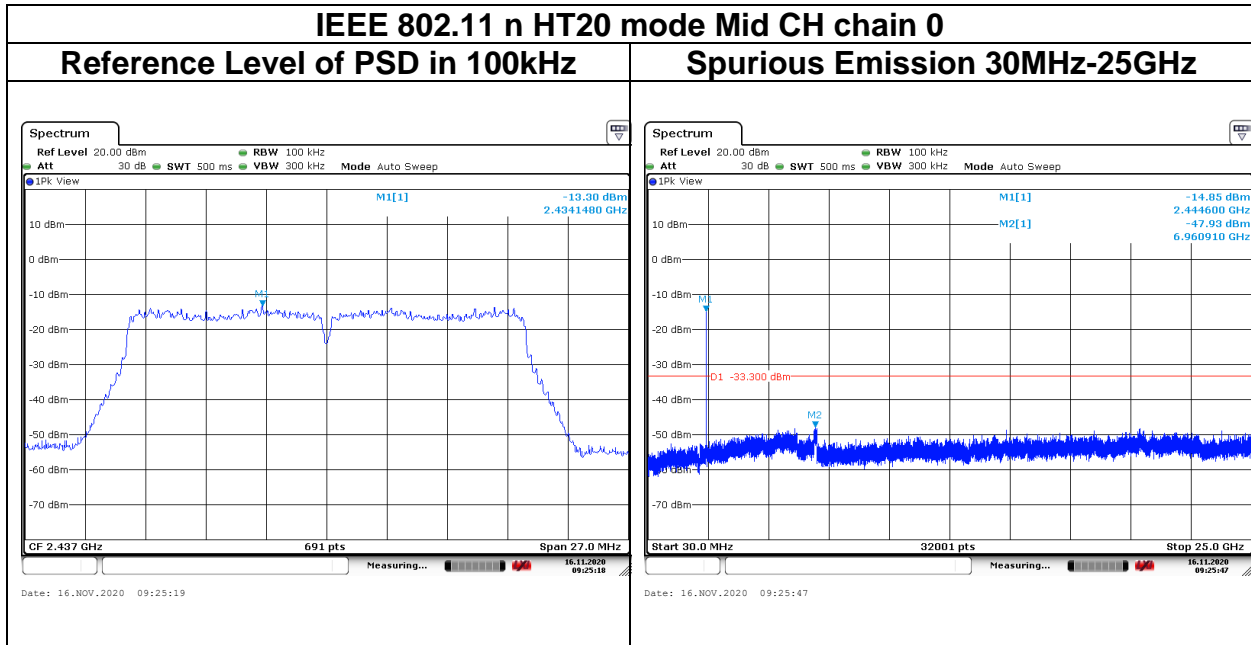

Report No.: T201104D06-RP3

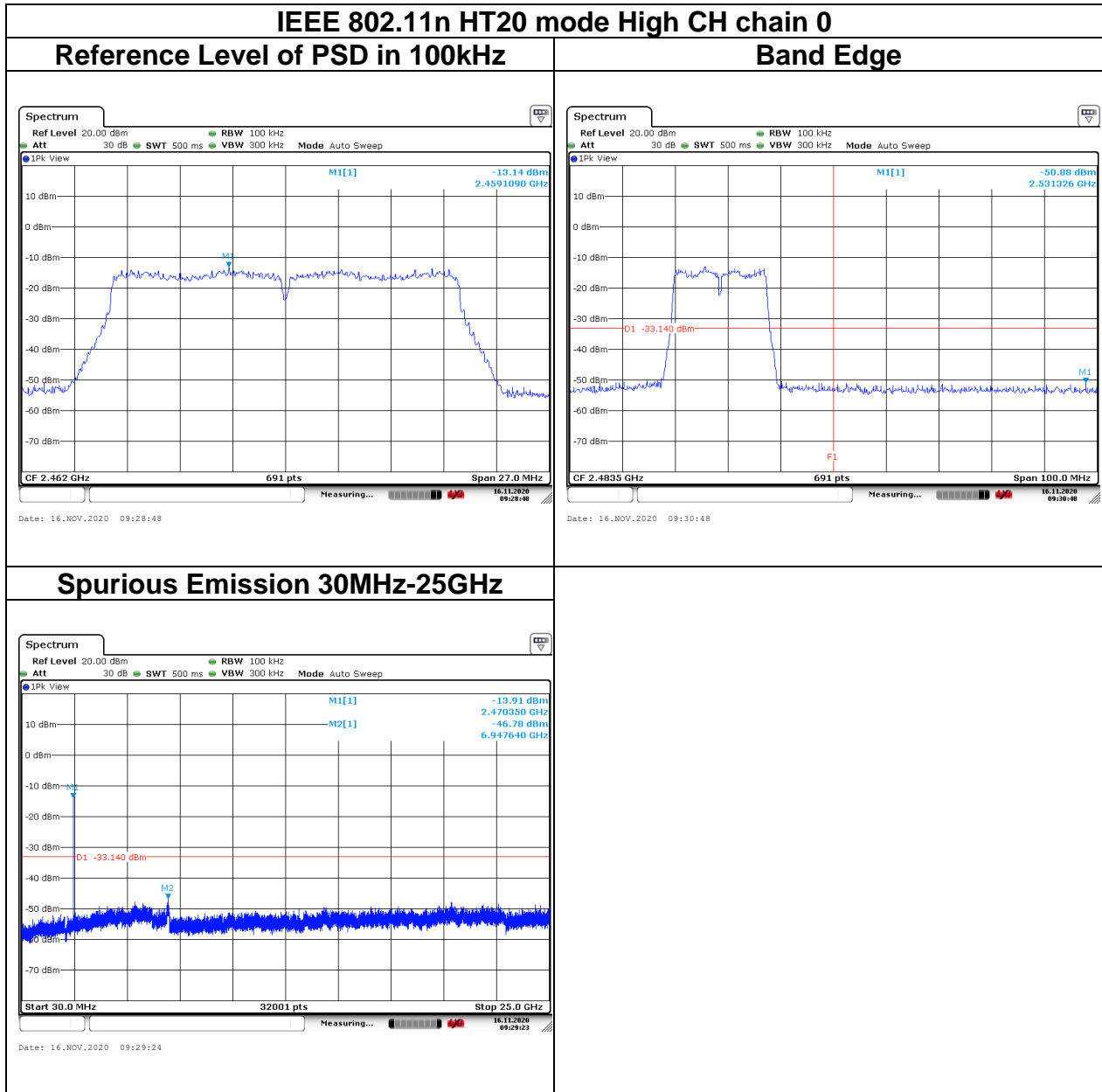

Report No.: T201104D06-RP3

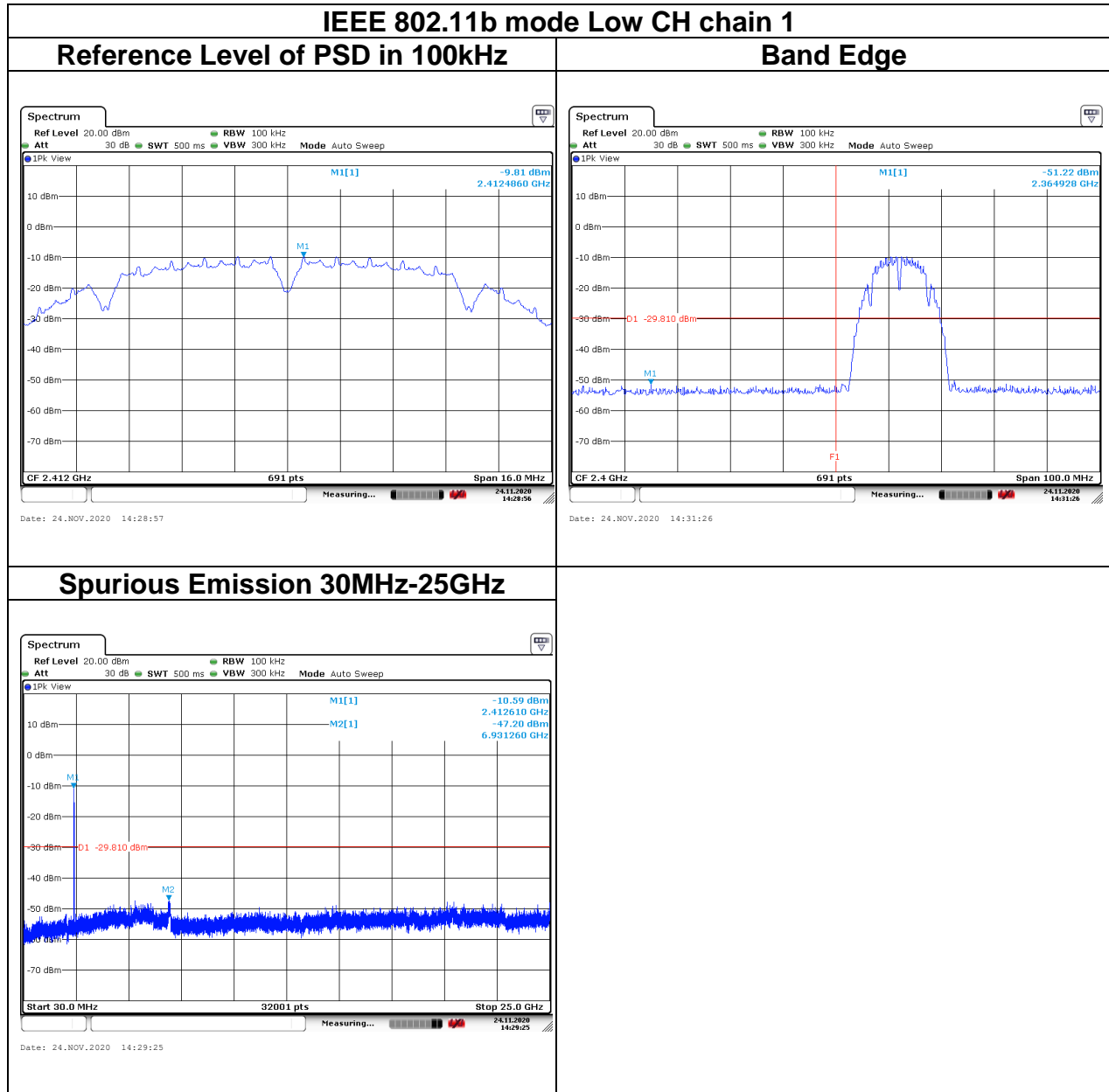

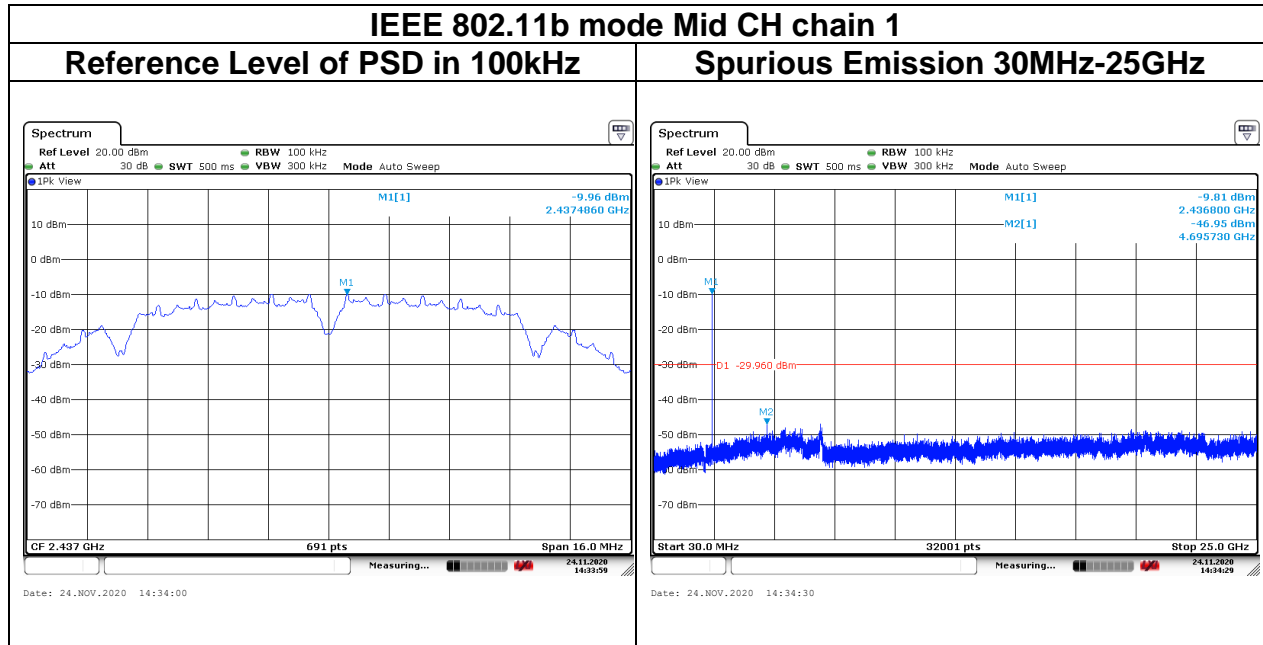

Report No.: T201104D06-RP3

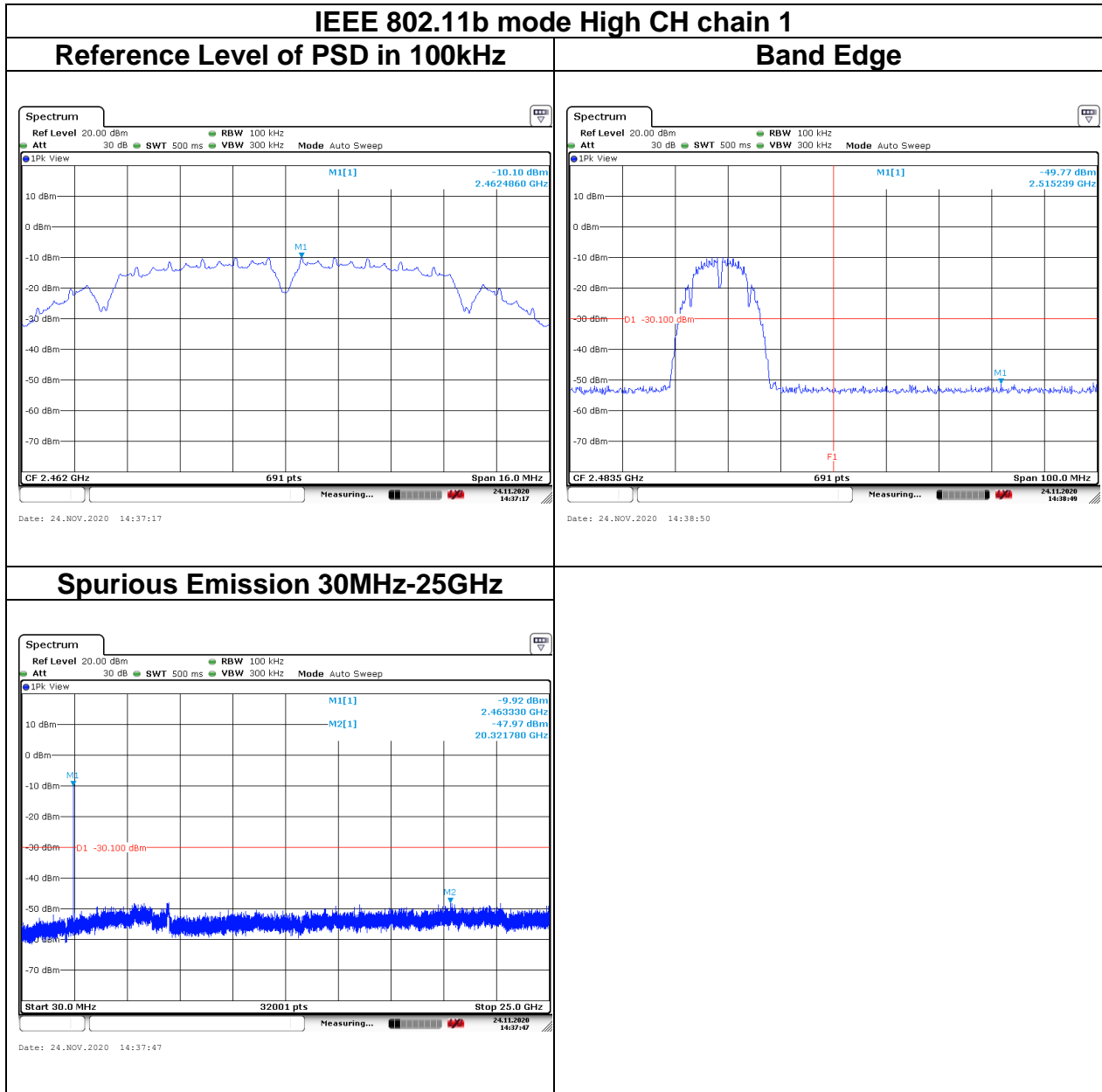

Report No.: T201104D06-RP3

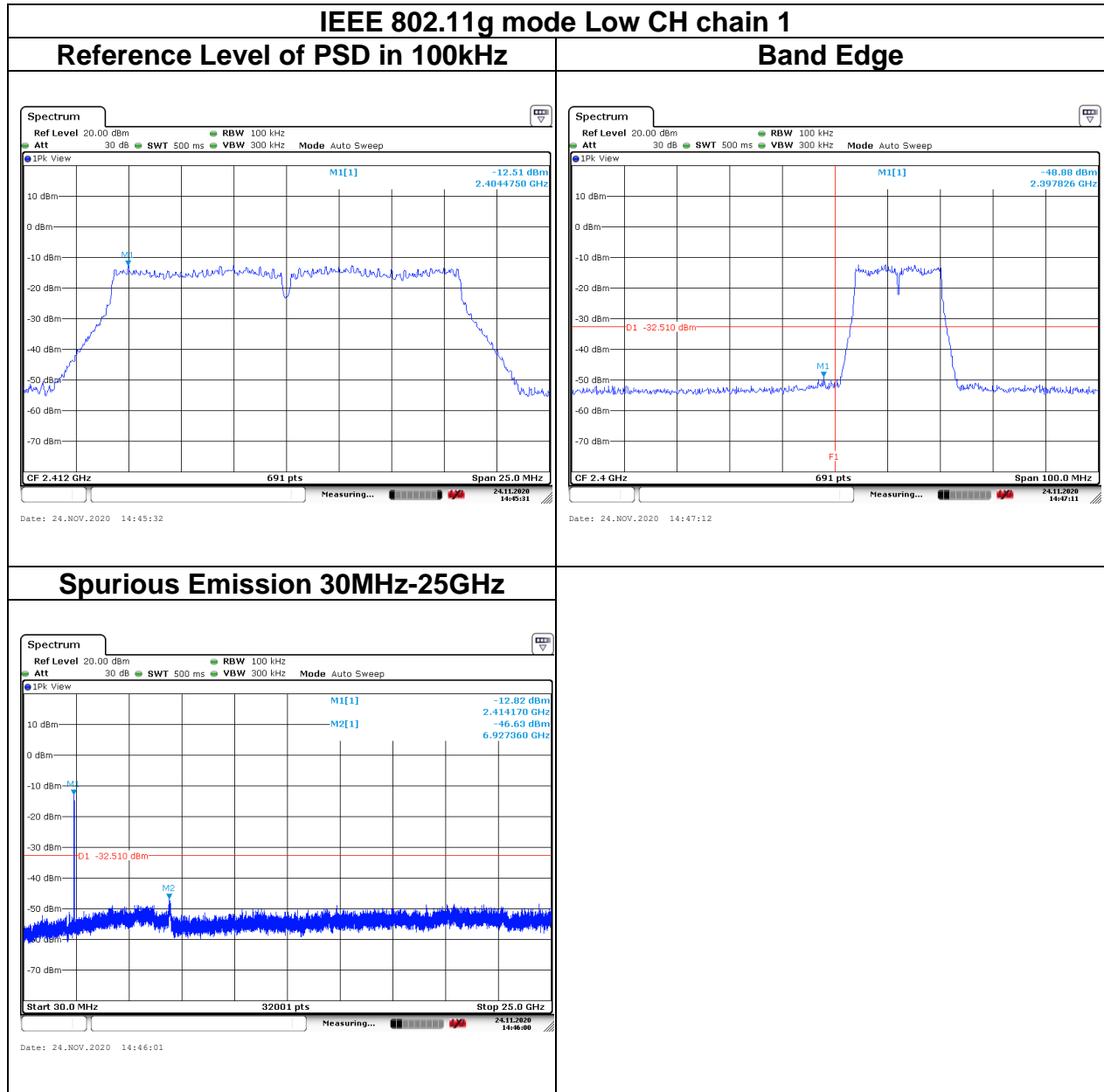

Report No.: T201104D06-RP3

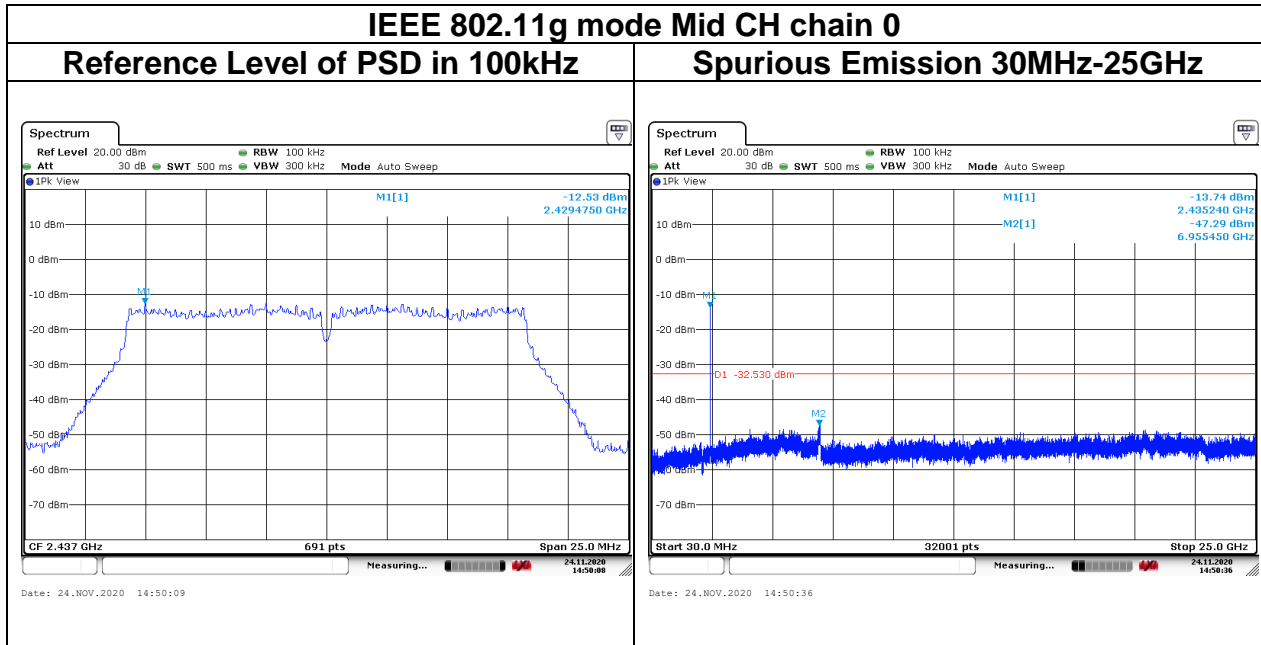

Report No.: T201104D06-RP3

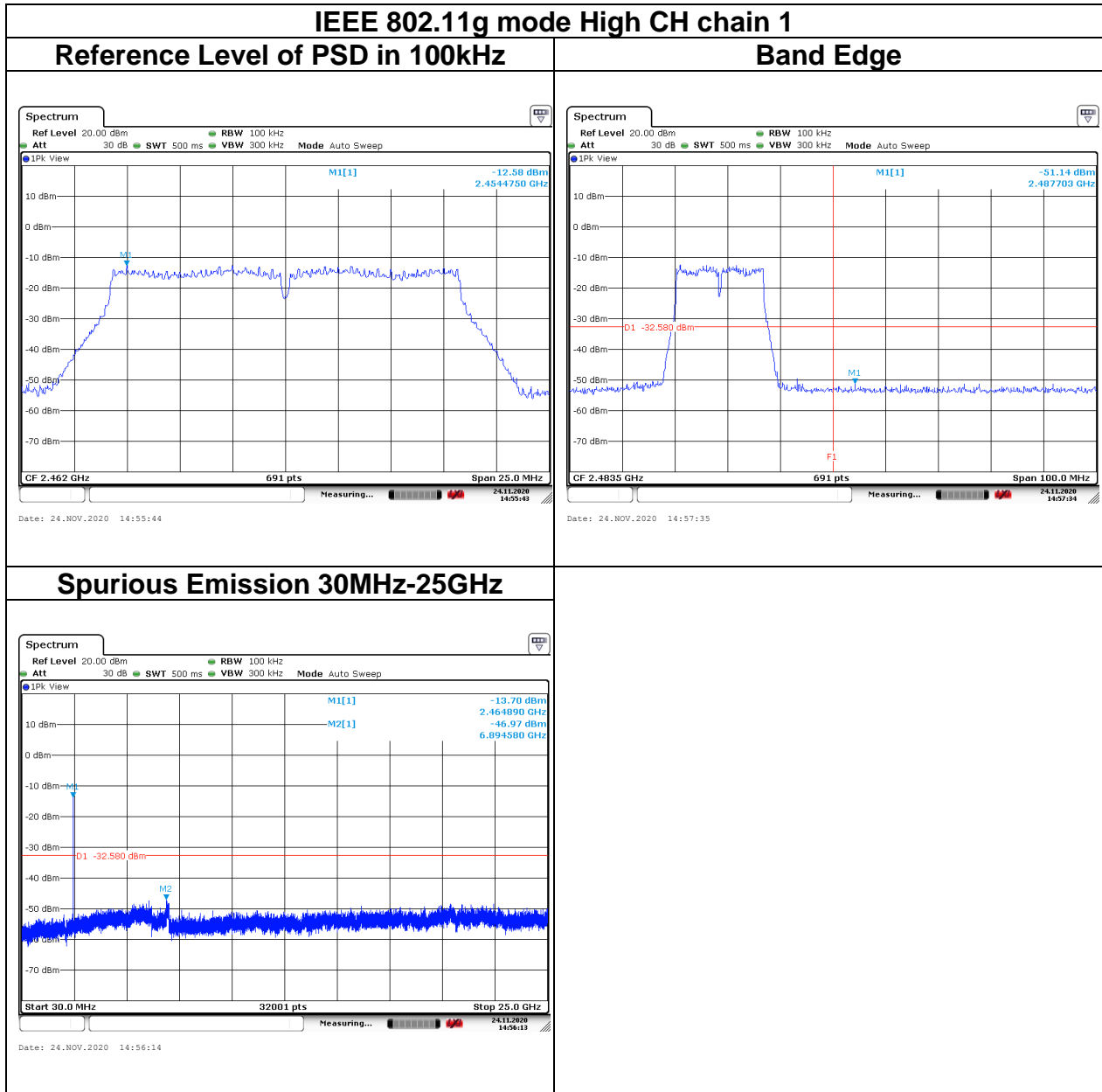

Report No.: T201104D06-RP3

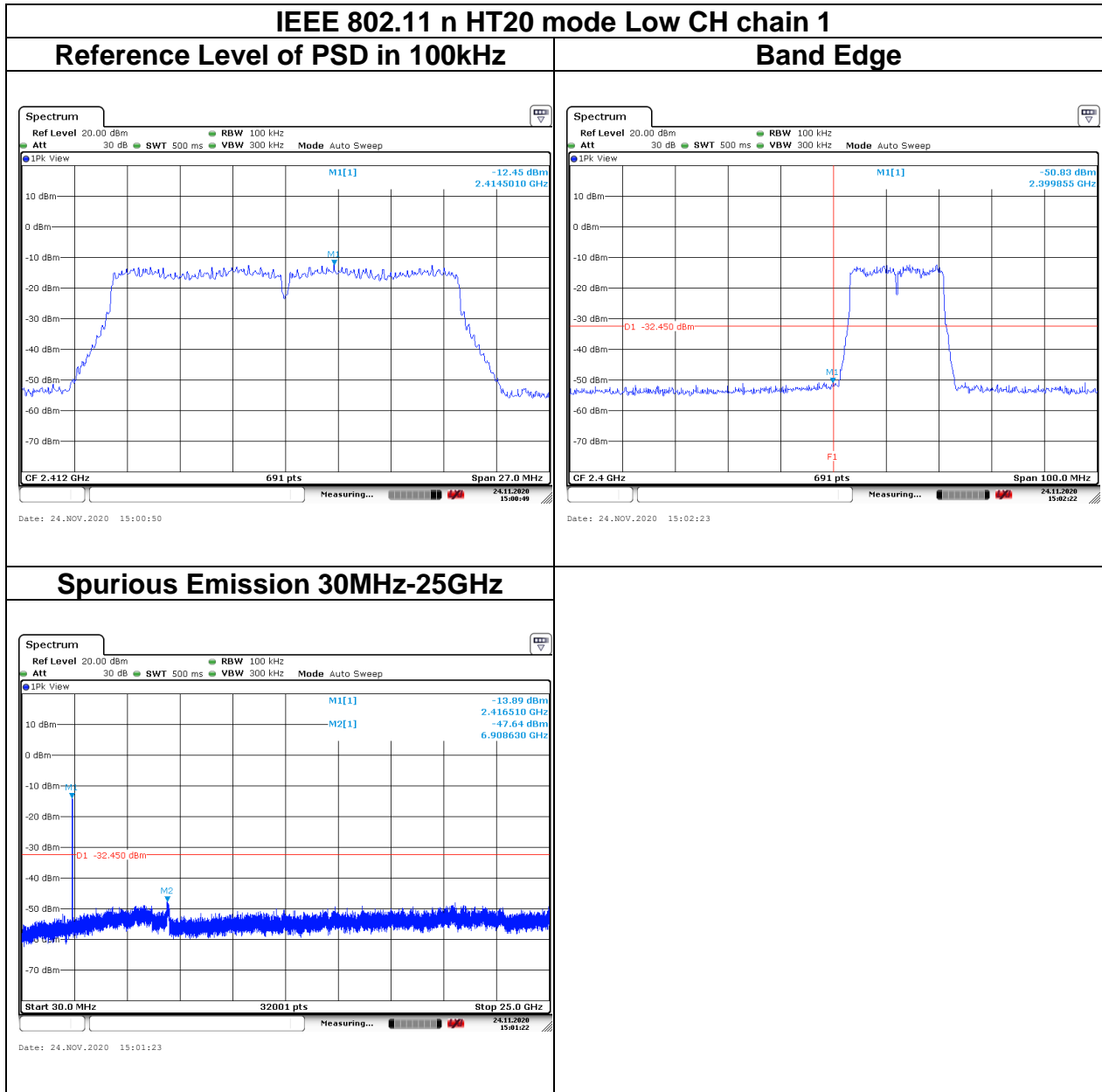

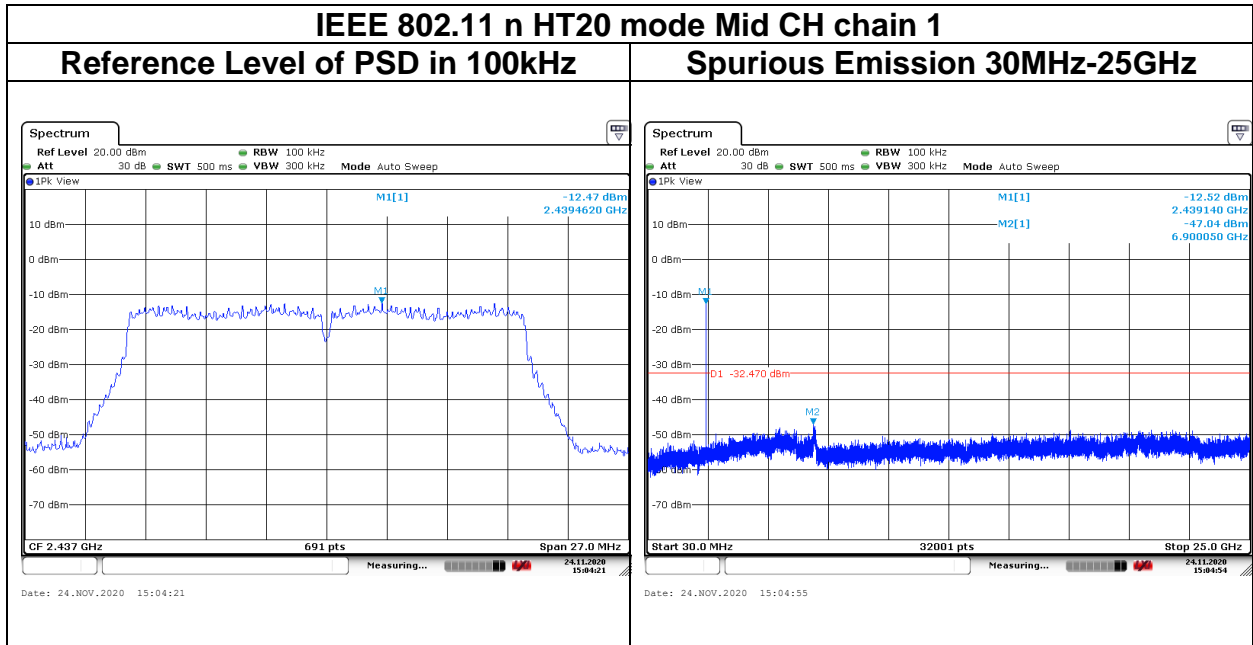

Report No.: T201104D06-RP3

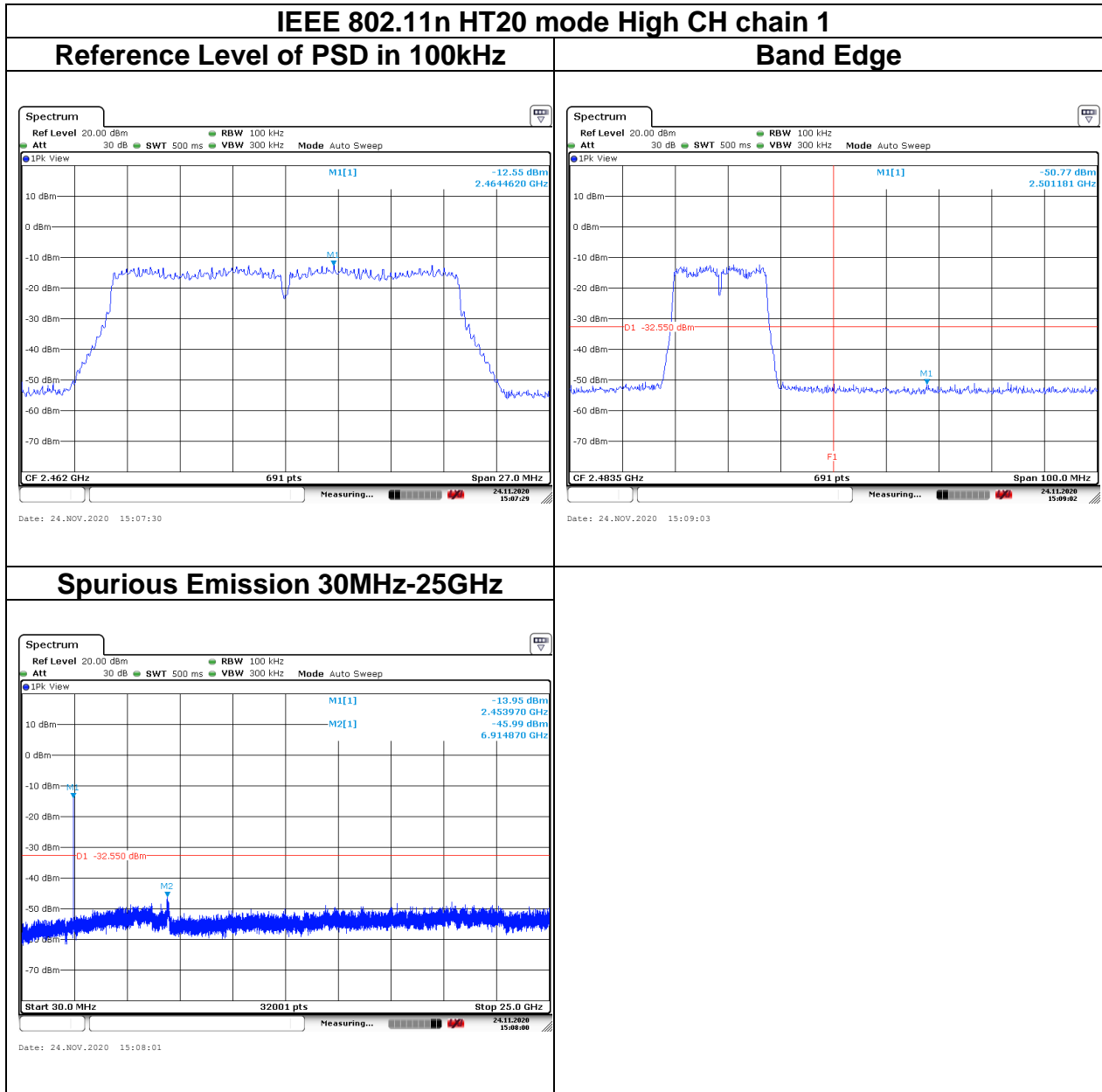

4.6 RADIATION BANDEDGE AND SPURIOUS EMISSION

4.6.1 Test Limit

FCC according to §15.247(d), §15.209 and §15.205,

In any 100 kHz bandwidth outside the authorized frequency band, all harmonic and spurious must be least 20 dB below the highest emission level with the authorized frequency band. Radiation emission which fall in the restricted bands must also follow the FCC section 15.209 as below limit in table.

Below 30 MHz

Frequency	Field Strength (microvolts/m)	Magnetic H-Field (microamperes/m)	Measurement Distance (metres)
9-490 kHz	2,400/F (F in kHz)	2,400/F (F in kHz)	300
490-1,705 kHz	24,000/F (F in kHz)	24,000/F (F in kHz)	30
1.705-30 MHz	30	N/A	30

Above 30 MHz

Frequency	Field Strength (microvolts/m)	Measurement Distance (metres)
30-88	100	3
88-216	150	3
216-960	200	3
Above 960	500	3

Report No.: T201104D06-RP3

4.6.2 Test Procedure

Test method Refer as KDB 662911 D01, ANSI C63.10:2013.

1. The EUT is placed on a turntable, Above 1 GHz is 1.5m and below 1 GHz is 0.8m above ground plane. The EUT Configured un accordance with ANSI C63.10: 2013, and the EUT set in a continuous mode.

2. The turntable shall be rotated for 360 degrees to determine the position of maximum emission level. And EUT is set 3m away from the receiving antenna, which is scanned from 1m to 4m above the ground plane to find out the highest emissions. Measurement are made polarized in both the vertical and the horizontal positions with antenna.

3. Span shall wide enough to full capture the emission measured. The SA from 9kHz to 26.5GHz set to the low, Mid and High channels with the EUT transmit.

Note: No emission found between lowest internal used/generated frequency to 30MHz (9KHz~30MHz)

Remark:

Although these tests were performed other than open area test site, adequate comparison measurements were confirmed against 30 m open are test site. Therefore sufficient tests were made to demonstrate that the alternative site produces results that correlate with the ones of tests made in an open field based on KDB 414788.

4. The SA setting following :

(1) Below 1G : RBW = 100kHz, VBW \geq 3 RBW, Sweep = Auto, Detector = Peak, Trace = Max hold.

(2) Above 1G :

(2.1) For Peak measurement : RBW = 1MHz, VBW \geq 3 RBW, Sweep = Auto, Detector = Peak, Trace = Max hold.

(2.2) For Average measurement : RBW = 1MHz, VBW

·If Duty Cycle \geq 98%, VBW=10Hz.

·If Duty Cycle < 98%, VBW=1/T.

4.6.3 Test Setup

9kHz ~ 30MHz

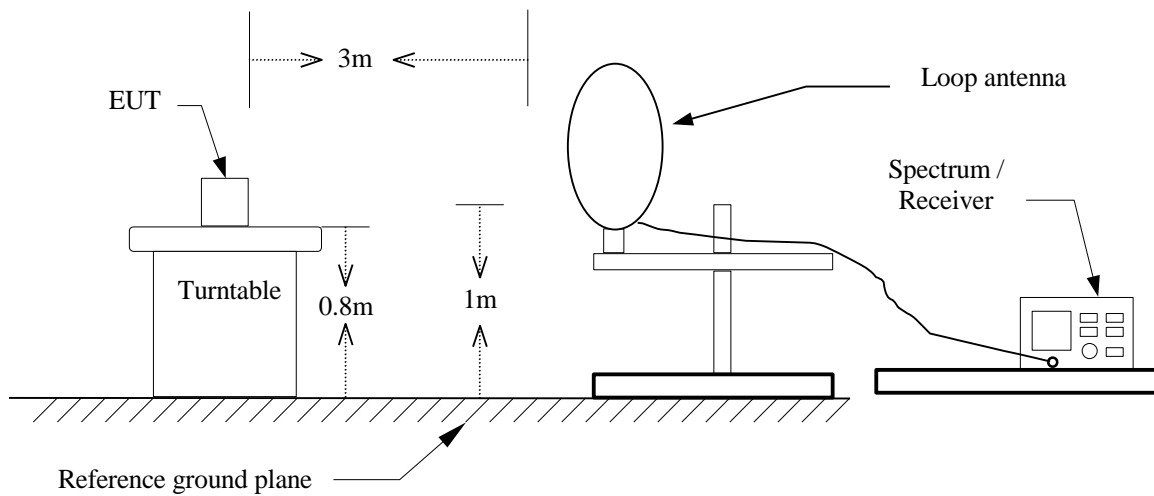

30MHz ~ 1GHz

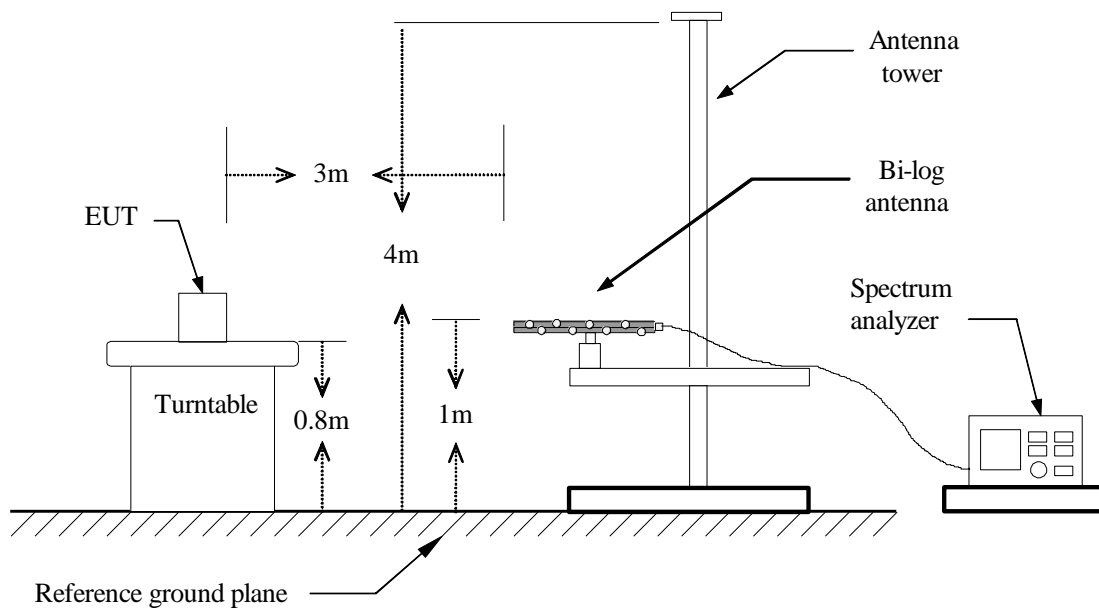

Above 1 GHz

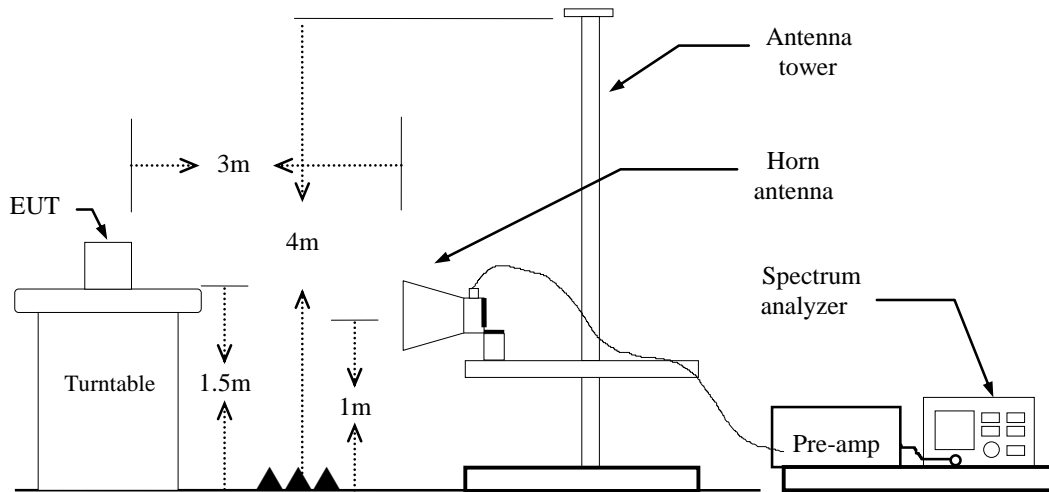

Report No.: T201104D06-RP3

4.6.4 Test Result

Band Edge Test Data

Test Mode	IEEE 802.11b Low CH 2412MHz	Temp/Hum	22.6(°C)/ 63%RH
Test Item	Band Edge	Test Date	November 12, 2020
Polarize	Vertical	Test Engineer	Ray Li
Detector	Peak / Average		

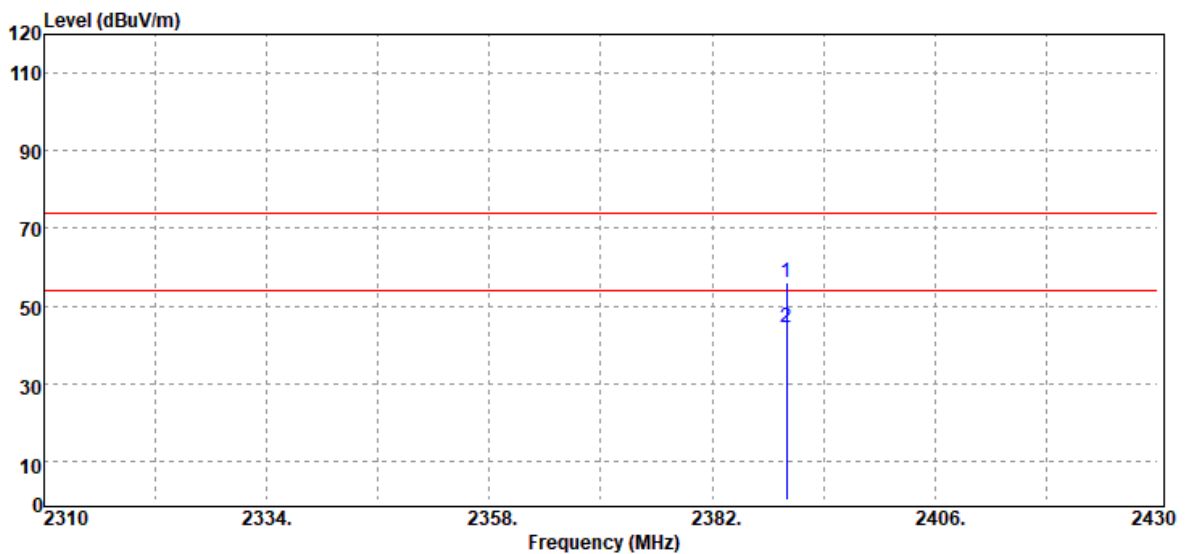

Frequency (MHz)	Detector Mode (PK/QP/AV)	Spectrum Reading Level (dBμV)	Factor (dB)	Actual FS (dBμV/m)	Limit @3m (dBμV/m)	Margin (dB)
2390.00	Peak	73.43	-17.18	56.25	74.00	-17.75
2390.00	Average	61.81	-17.18	44.63	54.00	-9.37

Report No.: T201104D06-RP3

Test Mode	IEEE 802.11b Low CH 2412MHz	Temp/Hum	22.6(°C)/ 63%RH
Test Item	Band Edge	Test Date	November 12, 2020
Polarize	Horizontal	Test Engineer	Ray Li
Detector	Peak & Average		

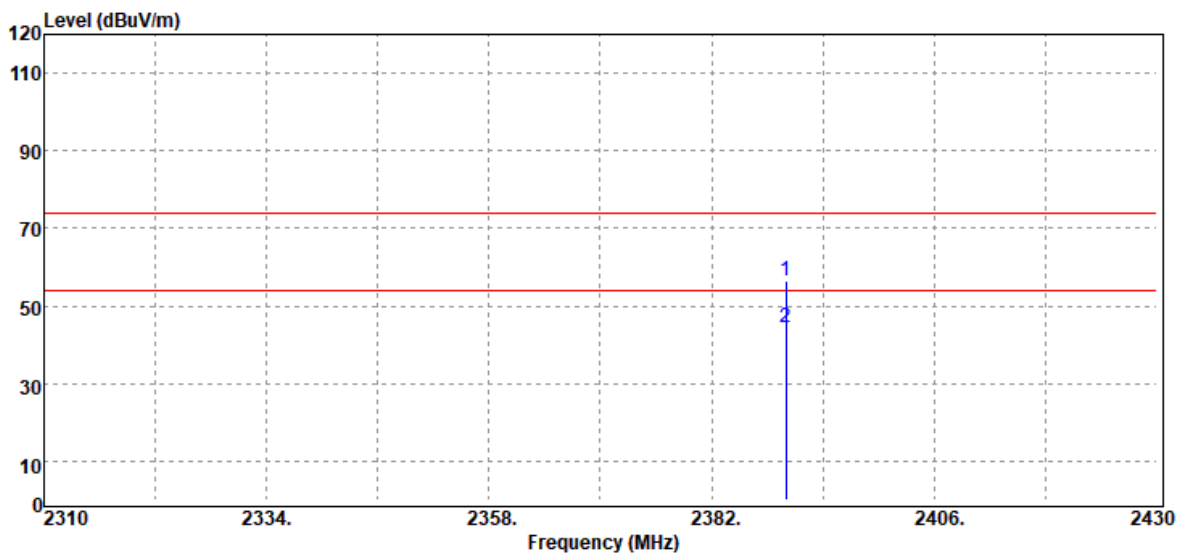

Frequency (MHz)	Detector Mode (PK/QP/AV)	Spectrum Reading Level (dBµV)	Factor (dB)	Actual FS (dBµV/m)	Limit @3m (dBµV/m)	Margin (dB)
2390.00	Peak	73.51	-17.18	56.33	74.00	-17.67
2390.00	Average	61.70	-17.18	44.52	54.00	-9.48

Report No.: T201104D06-RP3

Test Mode	IEEE 802.11b High CH 2462MHz	Temp/Hum	22.6(°C)/ 63%RH
Test Item	Band Edge	Test Date	November 12, 2020
Polarize	Vertical	Test Engineer	Ray Li
Detector	Peak / Average		

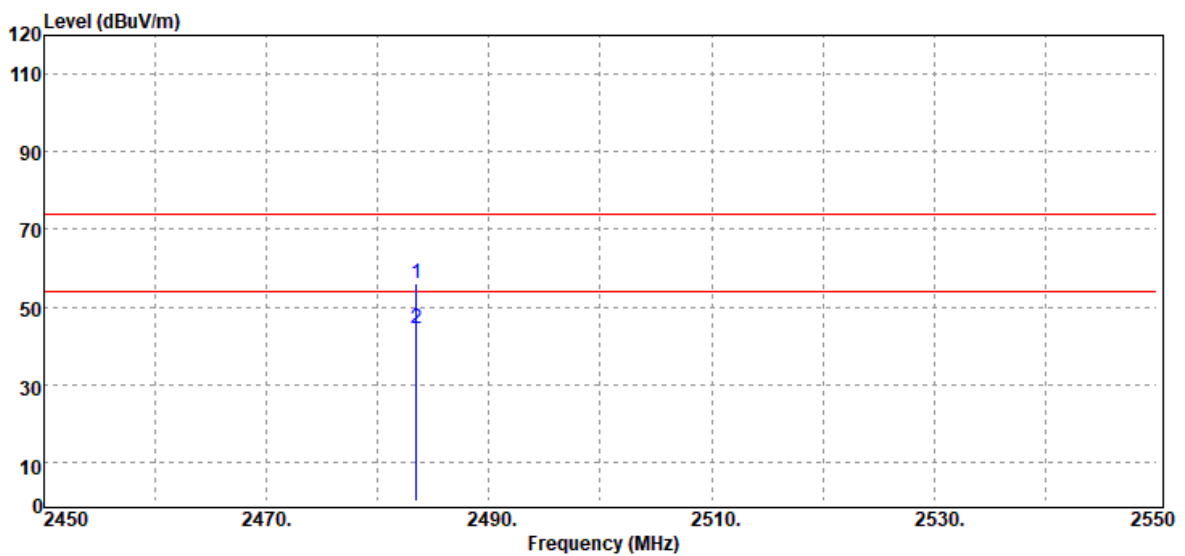

Frequency (MHz)	Detector Mode (PK/QP/AV)	Spectrum Reading Level (dBµV)	Factor (dB)	Actual FS (dBµV/m)	Limit @3m (dBµV/m)	Margin (dB)
2483.50	Peak	73.05	-16.98	56.07	74.00	-17.93
2483.50	Average	61.50	-16.98	44.52	54.00	-9.48

Report No.: T201104D06-RP3

Test Mode	IEEE 802.11b High CH 2462MHz	Temp/Hum	22.6(°C)/ 63%RH
Test Item	Band Edge	Test Date	November 12, 2020
Polarize	Horizontal	Test Engineer	Ray Li
Detector	Peak & Average		

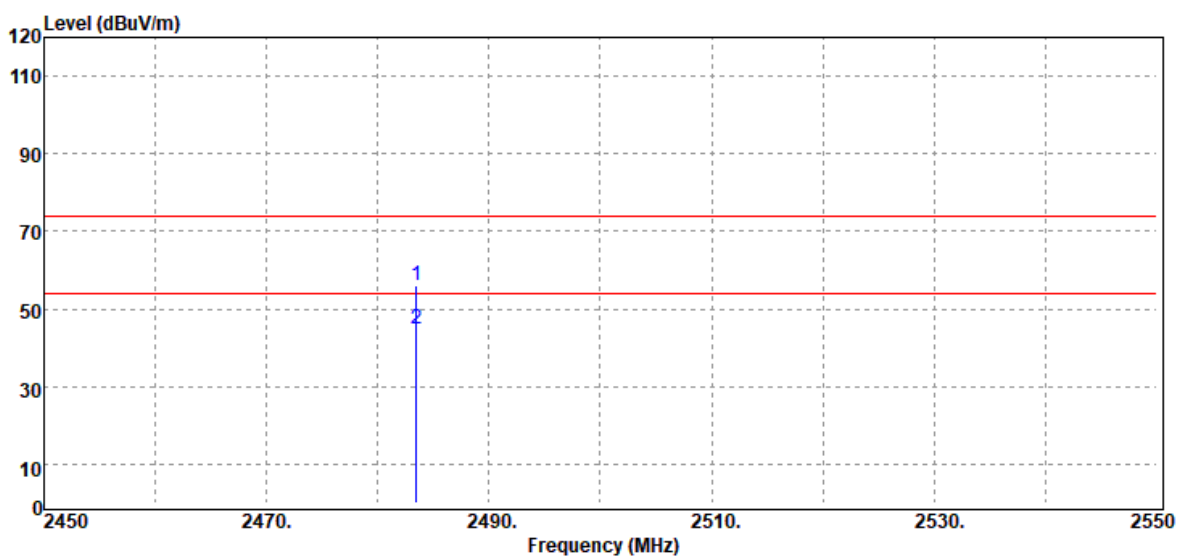

Frequency (MHz)	Detector Mode (PK/QP/AV)	Spectrum Reading Level (dBµV)	Factor (dB)	Actual FS (dBµV/m)	Limit @3m (dBµV/m)	Margin (dB)
2483.50	Peak	73.19	-16.98	56.21	74.00	-17.79
2483.50	Average	61.91	-16.98	44.93	54.00	-9.07

Report No.: T201104D06-RP3

Test Mode	IEEE 802.11g Low CH 2412MHz	Temp/Hum	22.6(°C)/ 63%RH
Test Item	Band Edge	Test Date	November 12, 2020
Polarize	Vertical	Test Engineer	Ray Li
Detector	Peak / Average		

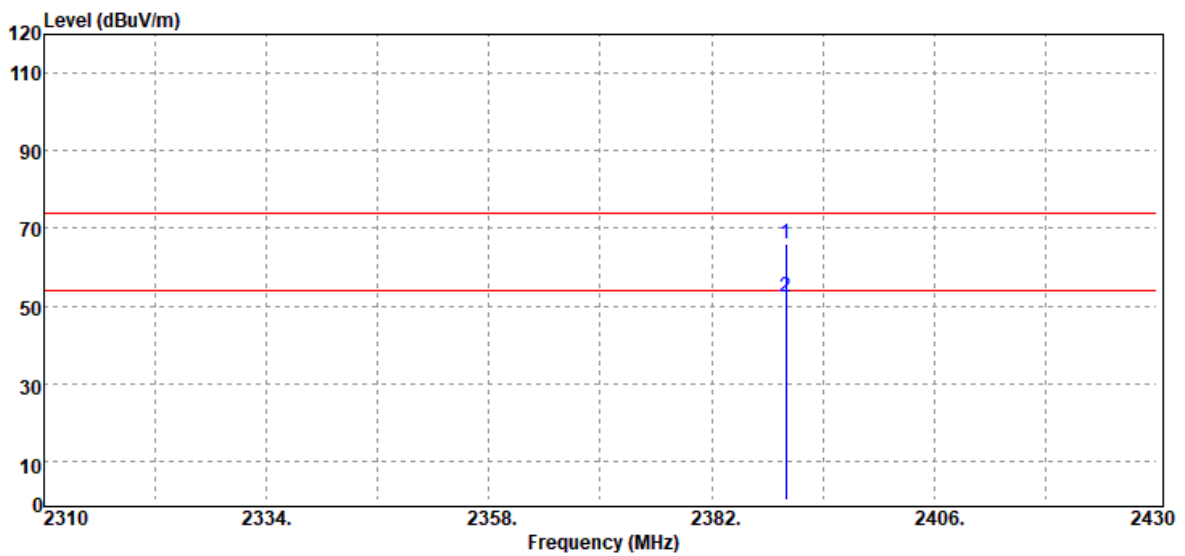

Frequency (MHz)	Detector Mode (PK/QP/AV)	Spectrum Reading Level (dBμV)	Factor (dB)	Actual FS (dBμV/m)	Limit @3m (dBμV/m)	Margin (dB)
2390.00	Peak	83.17	-17.18	65.99	74.00	-8.01
2390.00	Average	69.37	-17.18	52.19	54.00	-1.81

Report No.: T201104D06-RP3

Test Mode	IEEE 802.11g Low CH 2412MHz	Temp/Hum	22.6(°C)/ 63%RH
Test Item	Band Edge	Test Date	November 12, 2020
Polarize	Horizontal	Test Engineer	Ray Li
Detector	Peak & Average		

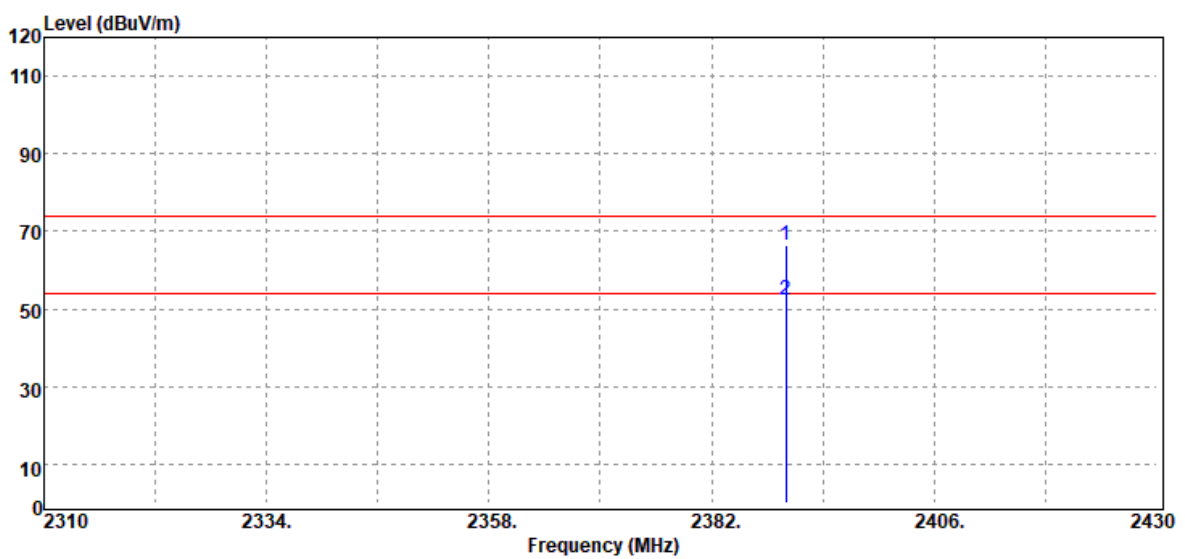

Frequency (MHz)	Detector Mode (PK/QP/AV)	Spectrum Reading Level (dBµV)	Factor (dB)	Actual FS (dBµV/m)	Limit @3m (dBµV/m)	Margin (dB)
2390.00	Peak	83.67	-17.18	66.49	74.00	-7.51
2390.00	Average	69.31	-17.18	52.13	54.00	-1.87

Report No.: T201104D06-RP3

Test Mode	IEEE 802.11g High CH 2462MHz	Temp/Hum	22.6(°C)/ 63%RH
Test Item	Band Edge	Test Date	November 12, 2020
Polarize	Vertical	Test Engineer	Ray Li
Detector	Peak / Average		

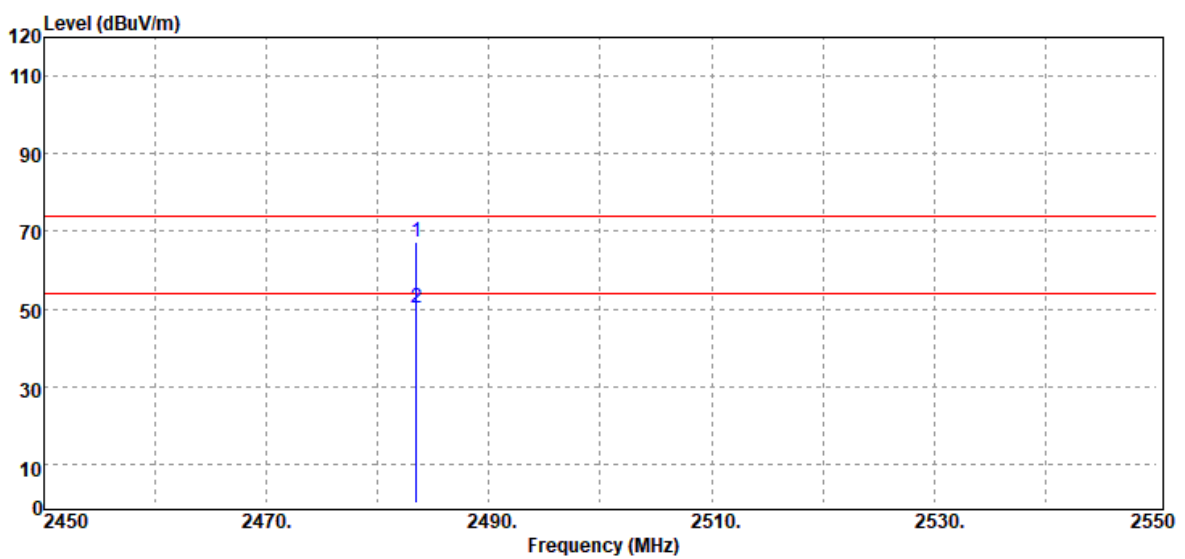

Frequency (MHz)	Detector Mode (PK/QP/AV)	Spectrum Reading Level (dBμV)	Factor (dB)	Actual FS (dBμV/m)	Limit @3m (dBμV/m)	Margin (dB)
2483.50	Peak	84.31	-16.98	67.33	74.00	-6.67
2483.50	Average	67.12	-16.98	50.14	54.00	-3.86

Report No.: T201104D06-RP3

Test Mode	IEEE 802.11g High CH 2462MHz	Temp/Hum	22.6(°C)/ 63%RH
Test Item	Band Edge	Test Date	November 12, 2020
Polarize	Horizontal	Test Engineer	Ray Li
Detector	Peak & Average		

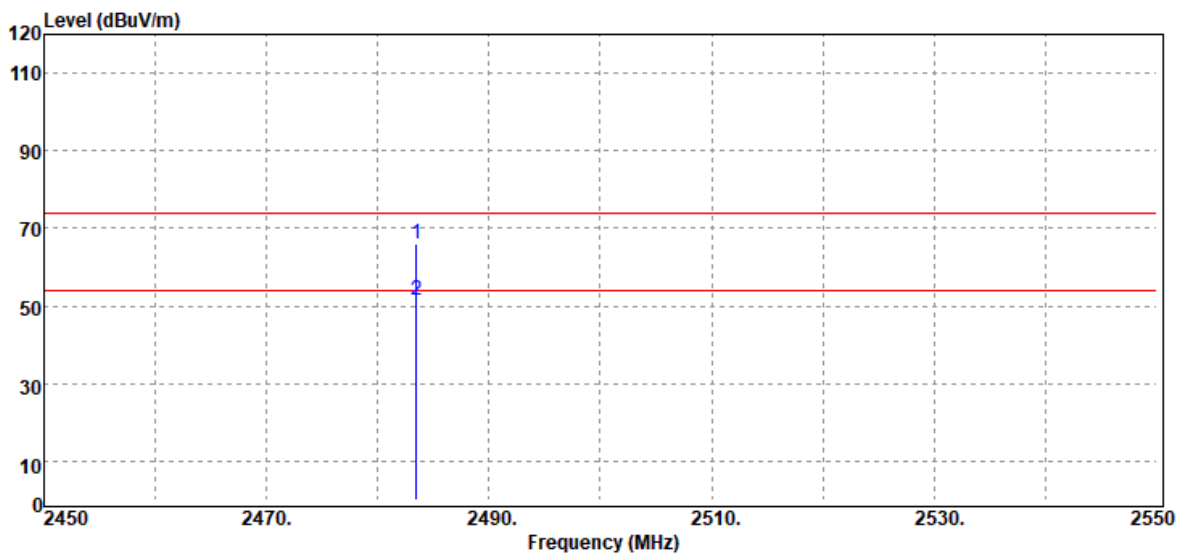

Frequency (MHz)	Detector Mode (PK/QP/AV)	Spectrum Reading Level (dBμV)	Factor (dB)	Actual FS (dBμV/m)	Limit @3m (dBμV/m)	Margin (dB)
2483.50	Peak	82.98	-16.98	66.00	74.00	-8.00
2483.50	Average	68.42	-16.98	51.44	54.00	-2.56

Report No.: T201104D06-RP3

Test Mode	IEEE 802.11n HT20 Low CH 2412MHz	Temp/Hum	22.6(°C)/ 63%RH
Test Item	Band Edge	Test Date	November 12, 2020
Polarize	Vertical	Test Engineer	Ray Li
Detector	Peak / Average		

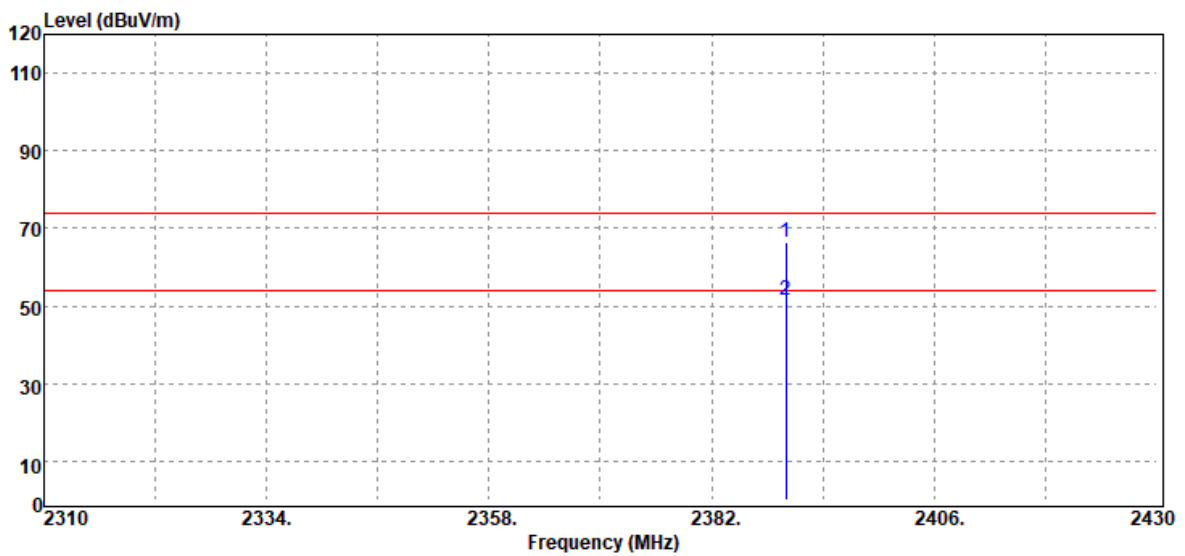

Frequency (MHz)	Detector Mode (PK/QP/AV)	Spectrum Reading Level (dB μ V)	Factor (dB)	Actual FS (dB μ V/m)	Limit @3m (dB μ V/m)	Margin (dB)
2390.00	Peak	83.45	-17.18	66.27	74.00	-7.73
2390.00	Average	68.69	-17.18	51.51	54.00	-2.49

Report No.: T201104D06-RP3

Test Mode	IEEE 802.11 n20 Low CH 2412MHz	Temp/Hum	22.6(°C)/ 63%RH
Test Item	Band Edge	Test Date	November 12, 2020
Polarize	Horizontal	Test Engineer	Ray Li
Detector	Peak & Average		

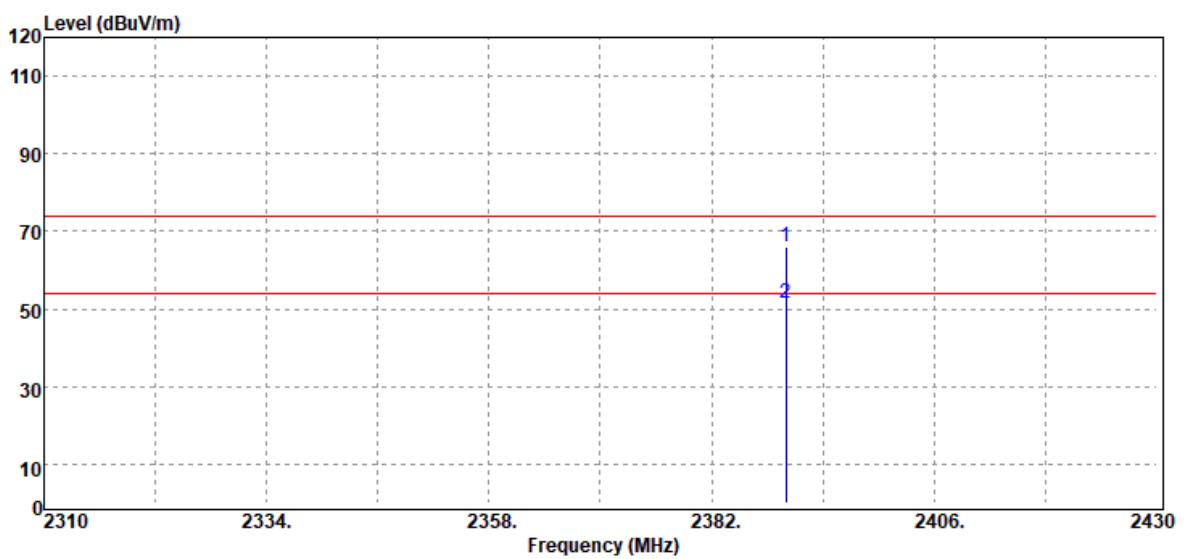

Frequency (MHz)	Detector Mode (PK/QP/AV)	Spectrum Reading Level (dB μ V)	Factor (dB)	Actual FS (dB μ V/m)	Limit @3m (dB μ V/m)	Margin (dB)
2390.00	Peak	83.02	-17.18	65.84	74.00	-8.16
2390.00	Average	68.79	-17.18	51.61	54.00	-2.39

Report No.: T201104D06-RP3

Test Mode	IEEE 802.11n HT20 High CH 2462MHz	Temp/Hum	22.6(°C)/ 63%RH
Test Item	Band Edge	Test Date	November 12, 2020
Polarize	Vertical	Test Engineer	Ray Li
Detector	Peak / Average		

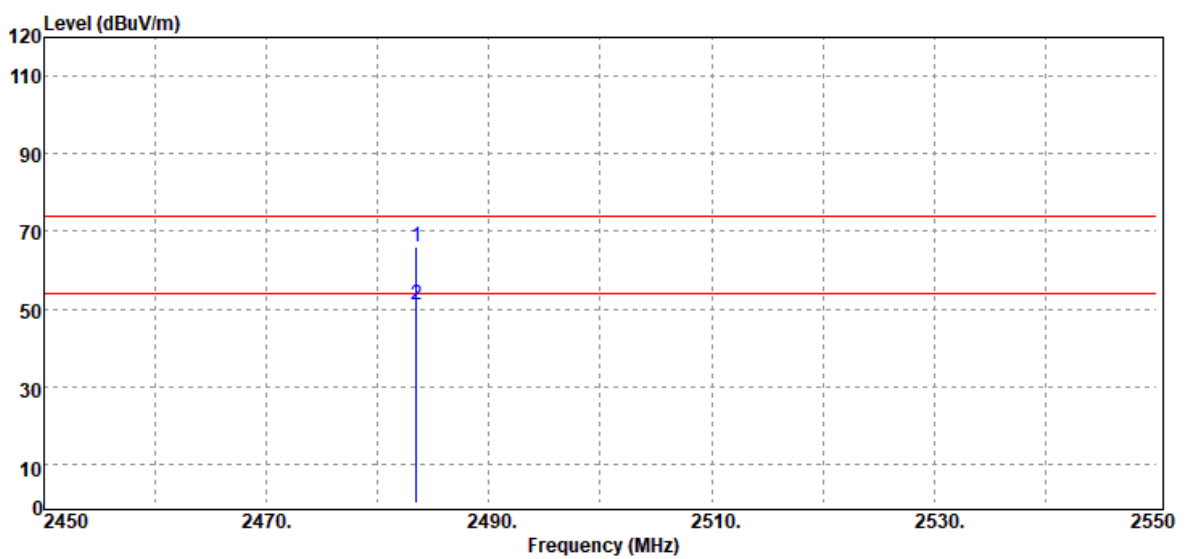

Frequency (MHz)	Detector Mode (PK/QP/AV)	Spectrum Reading Level (dBµV)	Factor (dB)	Actual FS (dBµV/m)	Limit @3m (dBµV/m)	Margin (dB)
2483.50	Peak	82.94	-16.98	65.96	74.00	-8.04
2483.50	Average	67.86	-16.98	50.88	54.00	-3.12

Report No.: T201104D06-RP3

Test Mode	IEEE 802.11n20 High CH 2462MHz	Temp/Hum	22.6(°C)/ 63%RH
Test Item	Band Edge	Test Date	November 12, 2020
Polarize	Horizontal	Test Engineer	Ray Li
Detector	Peak & Average		

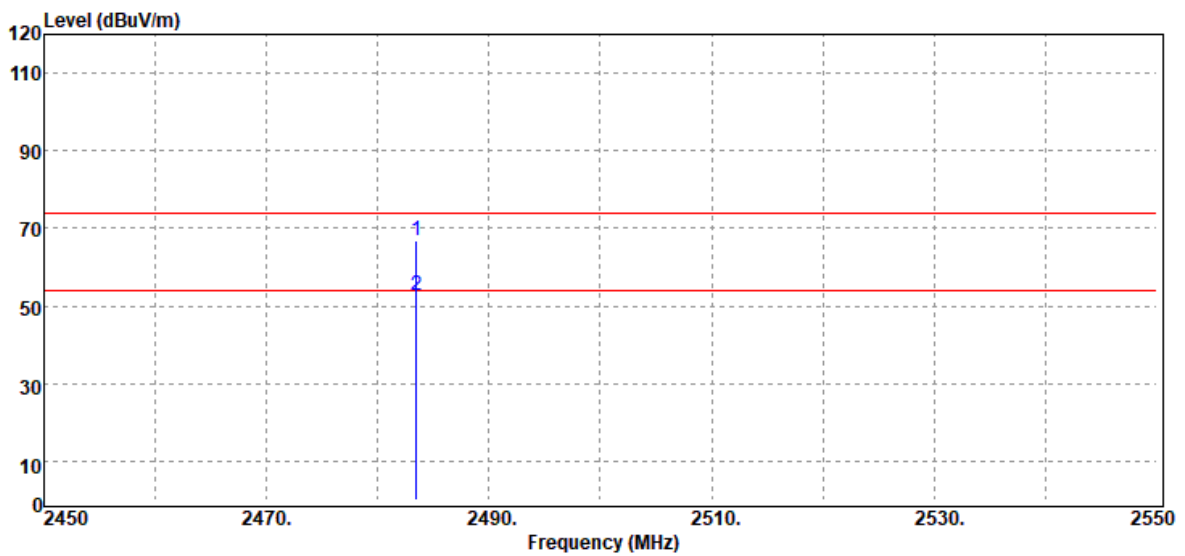

Frequency (MHz)	Detector Mode (PK/QP/AV)	Spectrum Reading Level (dBµV)	Factor (dB)	Actual FS (dBµV/m)	Limit @3m (dBµV/m)	Margin (dB)
2483.50	Peak	83.76	-16.98	66.78	74.00	-7.22
2483.50	Average	69.87	-16.98	52.89	54.00	-1.11

Below 1G Test Data

Test Mode	Mode 1	Temp/Hum	22.5(°C)/ 60%RH
Test Item	30MHz-1GHz	Test Date	November 11, 2020
Polarize	Vertical	Test Engineer	Jerry Chang
Detector	Peak	Test Voltage	

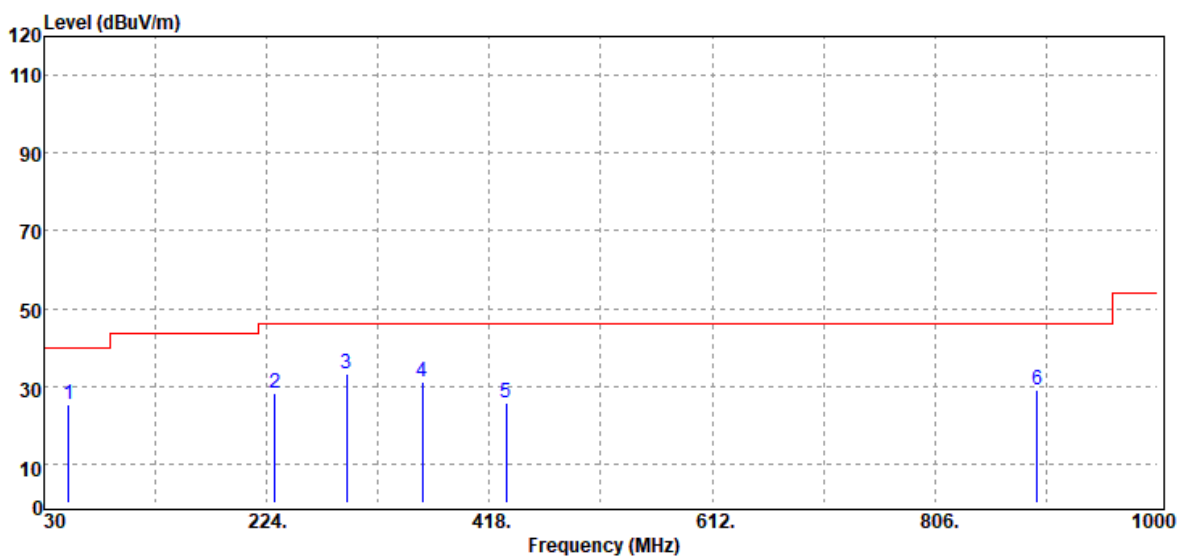

Freq. (MHz)	Detector Mode (PK/QP/AV)	Spectrum Reading Level (dBμV)	Factor (dB)	Actual FS (dBμV/m)	Limit @3m (dBμV/m)	Margin (dB)
51.34	Peak	-489.29	514.60	25.31	40.00	-14.69
230.79	Peak	-490.94	518.98	28.04	46.00	-17.96
293.84	Peak	-488.34	521.40	33.06	46.00	-12.94
359.80	Peak	-492.22	523.23	31.01	46.00	-14.99
432.55	Peak	-499.24	525.18	25.94	46.00	-20.06
895.24	Peak	-503.17	532.11	28.94	46.00	-17.06

Note: No emission found between lowest internal used/generated frequency to 30MHz(9KHz~30MHz)

Report No.: T201104D06-RP3

Test Mode	Mode 1	Temp/Hum	22.5(°C)/ 60%RH
Test Item	30MHz-1GHz	Test Date	November 11, 2020
Polarize	Horizontal	Test Engineer	Jerry Chang
Detector	Peak	Test Voltage	

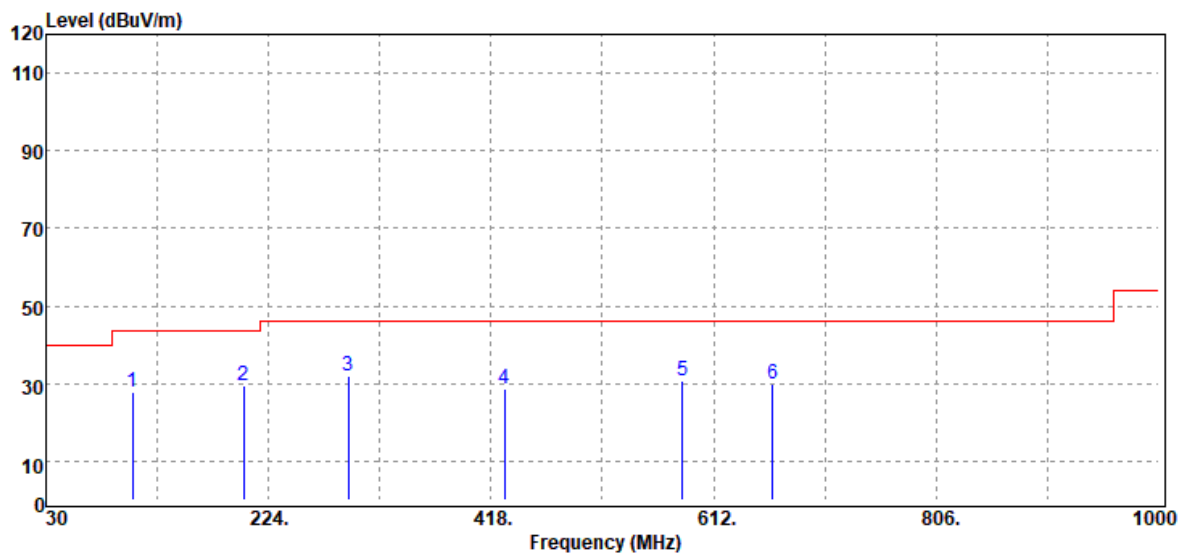

Freq. (MHz)	Detector Mode (PK/QP/AV)	Spectrum Reading Level (dBμV)	Factor (dB)	Actual FS (dBμV/m)	Limit @3m (dBμV/m)	Margin (dB)
105.66	Peak	-491.27	519.06	27.79	43.50	-15.71
202.66	Peak	-490.18	519.59	29.41	43.50	-14.09
293.84	Peak	-489.39	521.40	32.01	46.00	-13.99
429.64	Peak	-496.23	525.08	28.85	46.00	-17.15
584.84	Peak	-496.88	527.54	30.66	46.00	-15.34
663.41	Peak	-499.16	528.98	29.82	46.00	-16.18

Note: No emission found between lowest internal used/generated frequency to 30MHz(9KHz~30MHz)

Report No.: T201104D06-RP3

Above 1G Test Data

Test Mode	IEEE 802.11b Low CH	Temp/Hum	22.9(°C)/ 58%RH
Test Item	Harmonic	Test Date	November 11, 2020
Polarize	Vertical	Test Engineer	Ray Li
Detector	Peak		

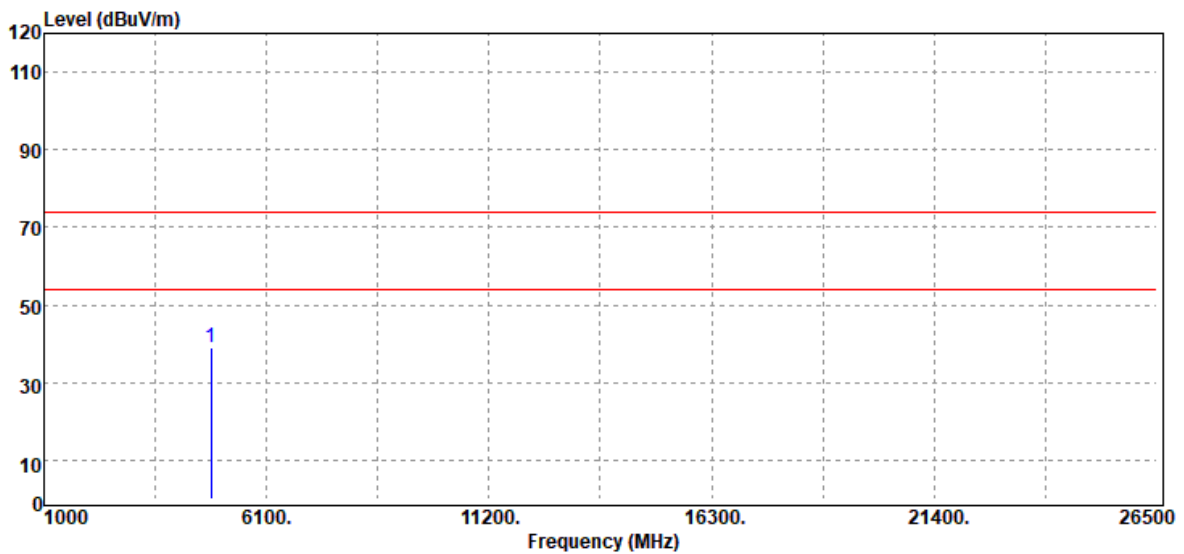

Freq. (MHz)	Detector Mode (PK/QP/AV)	Spectrum Reading Level (dBμV)	Factor (dB)	Actual FS (dBμV/m)	Limit @3m (dBμV/m)	Margin (dB)
4824.00	Peak	50.42	-11.39	39.03	74.00	-34.97
N/A						

Remark:

1. Measuring frequencies from 1 GHz to the 10th harmonic of highest fundamental frequency.
2. For above 1GHz, the EUT peak value was under average limit, therefore the Average value compliance with the average limit

Report No.: T201104D06-RP3

Test Mode	IEEE 802.11b Low CH	Temp/Hum	22.9(°C)/ 58%RH
Test Item	Harmonic	Test Date	November 11, 2020
Polarize	Horizontal	Test Engineer	Ray Li
Detector	Peak		

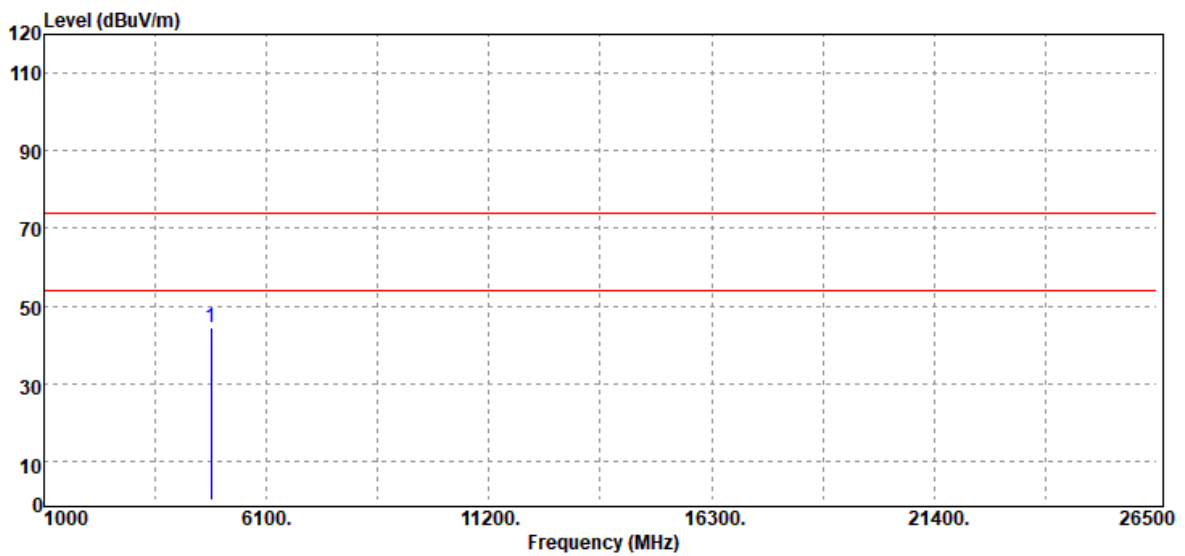

Freq. (MHz)	Detector Mode (PK/QP/AV)	Spectrum Reading Level (dBμV)	Factor (dB)	Actual FS (dBμV/m)	Limit @3m (dBμV/m)	Margin (dB)
4824.00	Peak	55.89	-11.39	44.50	74.00	-29.50
N/A						

Remark:

1. Measuring frequencies from 1 GHz to the 10th harmonic of highest fundamental frequency.
2. For above 1GHz, the EUT peak value was under average limit, therefore the Average value compliance with the average limit

Report No.: T201104D06-RP3

Test Mode	IEEE 802.11b Mid CH	Temp/Hum	22.9(°C)/ 58%RH
Test Item	Harmonic	Test Date	November 11, 2020
Polarize	Vertical	Test Engineer	Ray Li
Detector	Peak		

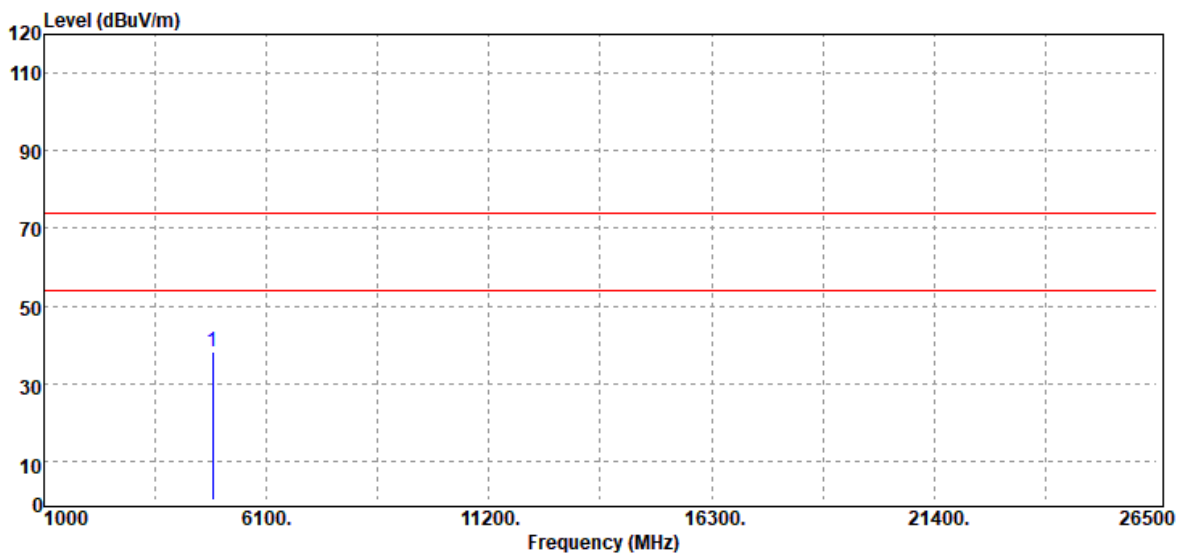

Freq. (MHz)	Detector Mode (PK/QP/AV)	Spectrum Reading Level (dBμV)	Factor (dB)	Actual FS (dBμV/m)	Limit @3m (dBμV/m)	Margin (dB)
4874.00	Peak	49.47	-11.12	38.35	74.00	-35.65
N/A						

Remark:

1. Measuring frequencies from 1 GHz to the 10th harmonic of highest fundamental frequency.
2. For above 1GHz, the EUT peak value was under average limit, therefore the Average value compliance with the average limit

Report No.: T201104D06-RP3

Test Mode	IEEE 802.11b Mid CH	Temp/Hum	22.9(°C)/ 58%RH
Test Item	Harmonic	Test Date	November 11, 2020
Polarize	Horizontal	Test Engineer	Ray Li
Detector	Peak		

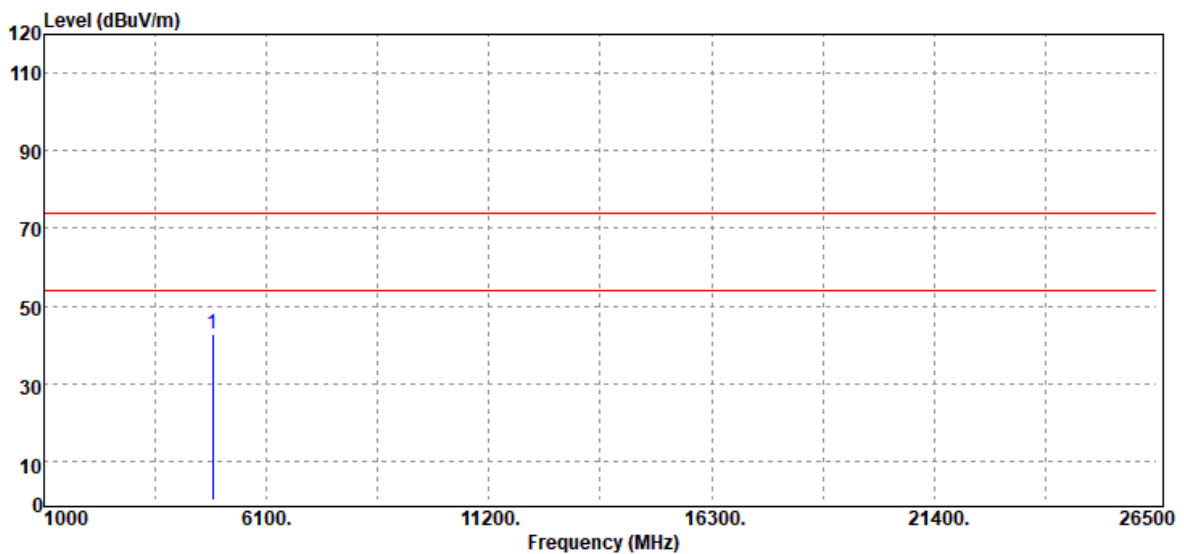

Freq. (MHz)	Detector Mode (PK/QP/AV)	Spectrum Reading Level (dB μ V)	Factor (dB)	Actual FS (dB μ V/m)	Limit @3m (dB μ V/m)	Margin (dB)
4874.00	Peak	53.95	-11.12	42.83	74.00	-31.17
N/A						

Remark:

1. Measuring frequencies from 1 GHz to the 10th harmonic of highest fundamental frequency.
2. For above 1GHz, the EUT peak value was under average limit, therefore the Average value compliance with the average limit

Report No.: T201104D06-RP3

Test Mode	IEEE 802.11b High CH	Temp/Hum	22.9(°C)/ 58%RH
Test Item	Harmonic	Test Date	November 11, 2020
Polarize	Vertical	Test Engineer	Ray Li
Detector	Peak		

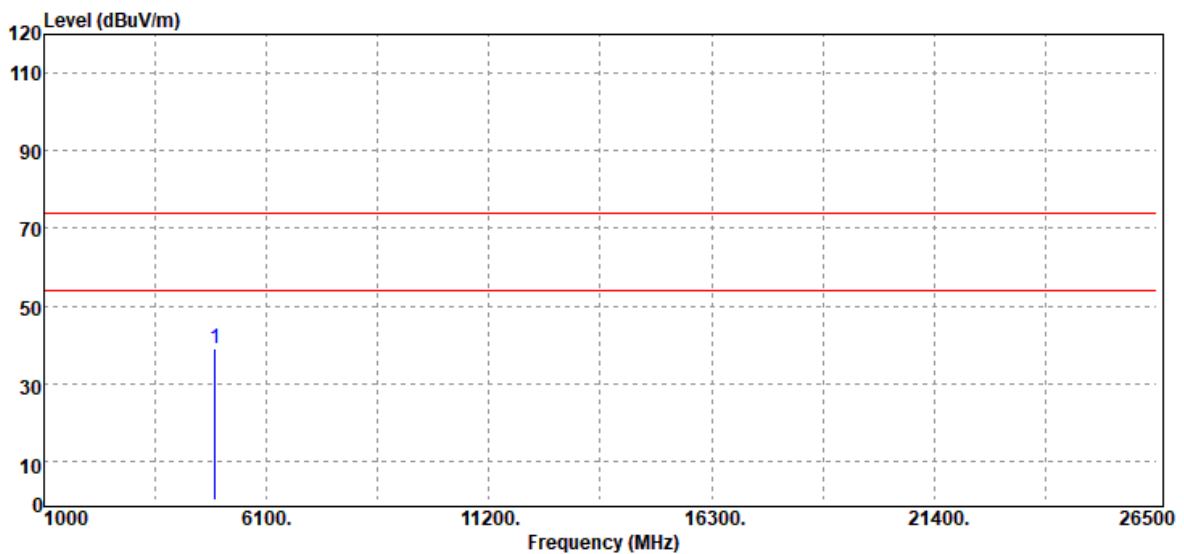

Freq. (MHz)	Detector Mode (PK/QP/AV)	Spectrum Reading Level (dBμV)	Factor (dB)	Actual FS (dBμV/m)	Limit @3m (dBμV/m)	Margin (dB)
4924.00	Peak	49.95	-10.77	39.18	74.00	-34.82
N/A						

Remark:

1. Measuring frequencies from 1 GHz to the 10th harmonic of highest fundamental frequency.
2. For above 1GHz, the EUT peak value was under average limit, therefore the Average value compliance with the average limit

Report No.: T201104D06-RP3

Test Mode	IEEE 802.11b High CH	Temp/Hum	22.9(°C)/ 58%RH
Test Item	Harmonic	Test Date	November 11, 2020
Polarize	Horizontal	Test Engineer	Ray Li
Detector	Peak		

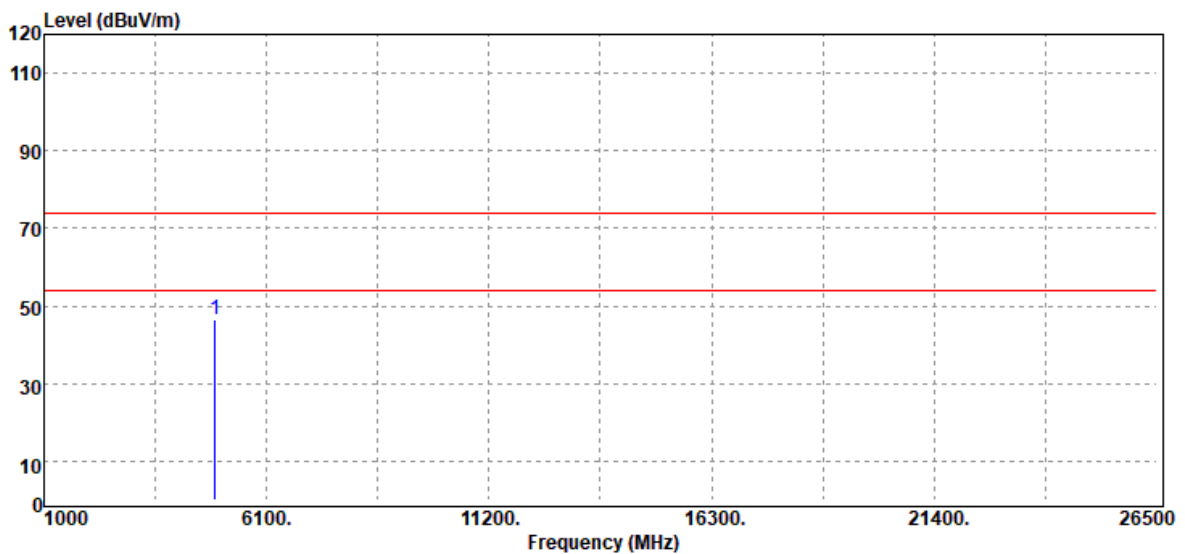

Freq. (MHz)	Detector Mode (PK/QP/AV)	Spectrum Reading Level (dB μ V)	Factor (dB)	Actual FS (dB μ V/m)	Limit @3m (dB μ V/m)	Margin (dB)
4924.00	Peak	57.36	-10.77	46.59	74.00	-27.41
N/A						

Remark:

1. Measuring frequencies from 1 GHz to the 10th harmonic of highest fundamental frequency.
2. For above 1GHz, the EUT peak value was under average limit, therefore the Average value compliance with the average limit

Test Mode	IEEE 802.11g Low CH	Temp/Hum	22.9(°C)/ 58%RH
Test Item	Harmonic	Test Date	November 11, 2020
Polarize	Vertical	Test Engineer	Ray Li
Detector	Peak		

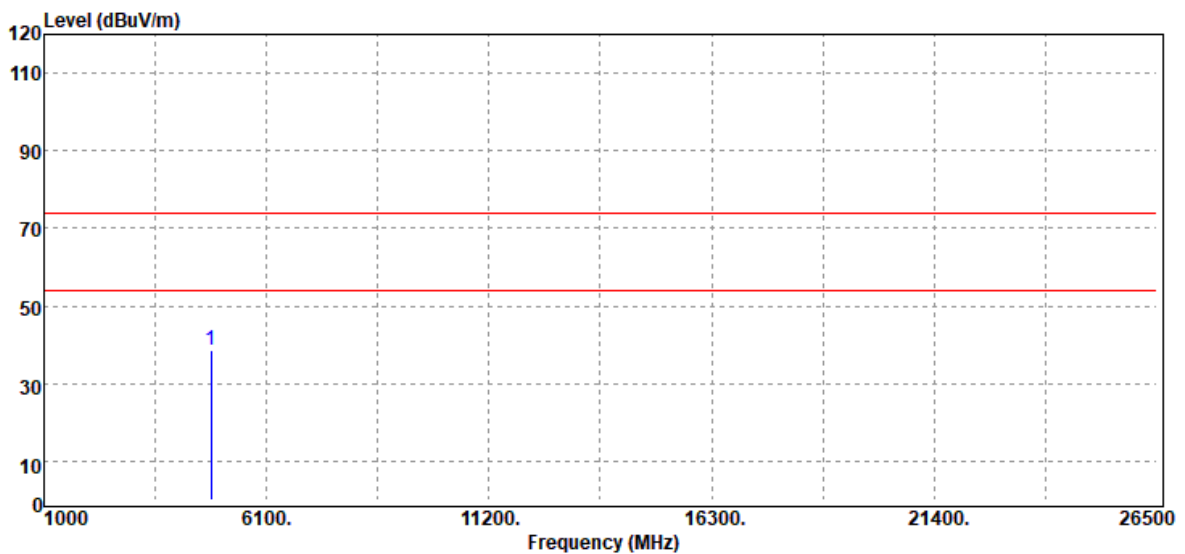

Freq. (MHz)	Detector Mode (PK/QP/AV)	Spectrum Reading Level (dBµV)	Factor (dB)	Actual FS (dBµV/m)	Limit @3m (dBµV/m)	Margin (dB)
4824.00	Peak	49.92	-11.39	38.53	74.00	-35.47
N/A						

Remark:

1. Measuring frequencies from 1 GHz to the 10th harmonic of highest fundamental frequency.
2. For above 1GHz, the EUT peak value was under average limit, therefore the Average value compliance with the average limit

Report No.: T201104D06-RP3

Test Mode	IEEE 802.11g Low CH	Temp/Hum	22.9(°C)/ 58%RH
Test Item	Harmonic	Test Date	November 11, 2020
Polarize	Horizontal	Test Engineer	Ray Li
Detector	Peak		

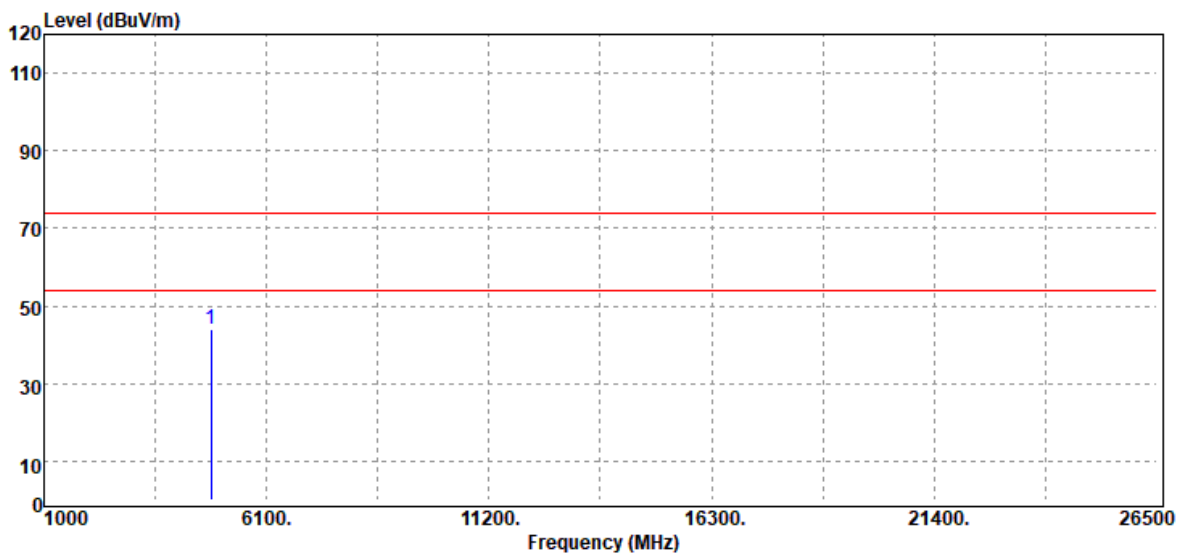

Freq. (MHz)	Detector Mode (PK/QP/AV)	Spectrum Reading Level (dBμV)	Factor (dB)	Actual FS (dBμV/m)	Limit @3m (dBμV/m)	Margin (dB)
4824.00	Peak	55.31	-11.39	43.92	74.00	-30.08
N/A						

Remark:

1. Measuring frequencies from 1 GHz to the 10th harmonic of highest fundamental frequency.
2. For above 1GHz, the EUT peak value was under average limit, therefore the Average value compliance with the average limit

Report No.: T201104D06-RP3

Test Mode	IEEE 802.11g Mid CH	Temp/Hum	22.9(°C)/ 58%RH
Test Item	Harmonic	Test Date	November 11, 2020
Polarize	Vertical	Test Engineer	Ray Li
Detector	Peak & Average		

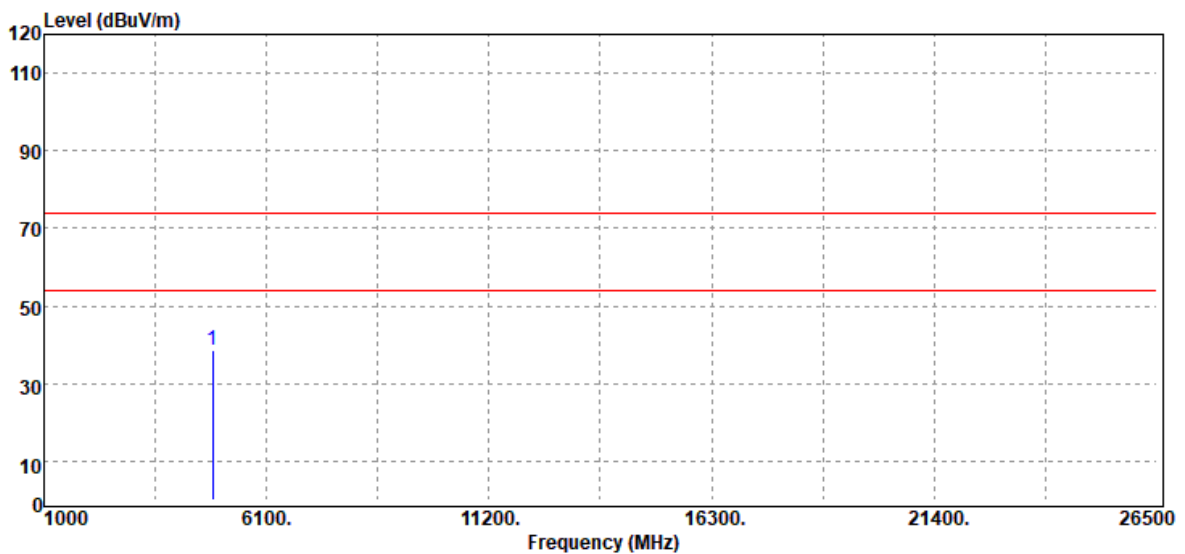

Freq. (MHz)	Detector Mode (PK/QP/AV)	Spectrum Reading Level (dBμV)	Factor (dB)	Actual FS (dBμV/m)	Limit @3m (dBμV/m)	Margin (dB)
4874.00	Peak	49.89	-11.12	38.77	74.00	-35.23
N/A						

Remark:

1. Measuring frequencies from 1 GHz to the 10th harmonic of highest fundamental frequency.
2. For above 1GHz, the EUT peak value was under average limit, therefore the Average value compliance with the average limit

Report No.: T201104D06-RP3

Test Mode	IEEE 802.11g Mid CH	Temp/Hum	22.9(°C)/ 58%RH
Test Item	Harmonic	Test Date	November 11, 2020
Polarize	Horizontal	Test Engineer	Ray Li
Detector	Peak		

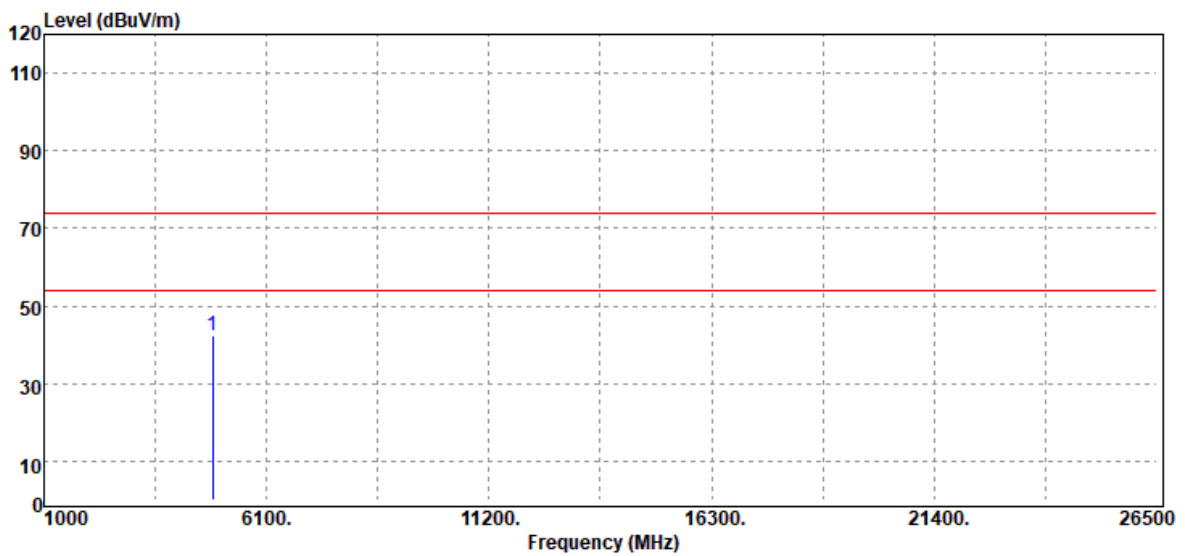

Freq. (MHz)	Detector Mode (PK/QP/AV)	Spectrum Reading Level (dB μ V)	Factor (dB)	Actual FS (dB μ V/m)	Limit @3m (dB μ V/m)	Margin (dB)
4874.00	Peak	53.66	-11.12	42.54	74.00	-31.46
N/A						

Remark:

1. Measuring frequencies from 1 GHz to the 10th harmonic of highest fundamental frequency.
2. For above 1GHz, the EUT peak value was under average limit, therefore the Average value compliance with the average limit

Report No.: T201104D06-RP3

Test Mode	IEEE 802.11g High CH	Temp/Hum	22.9(°C)/ 58%RH
Test Item	Harmonic	Test Date	November 11, 2020
Polarize	Vertical	Test Engineer	Ray Li
Detector	Peak		

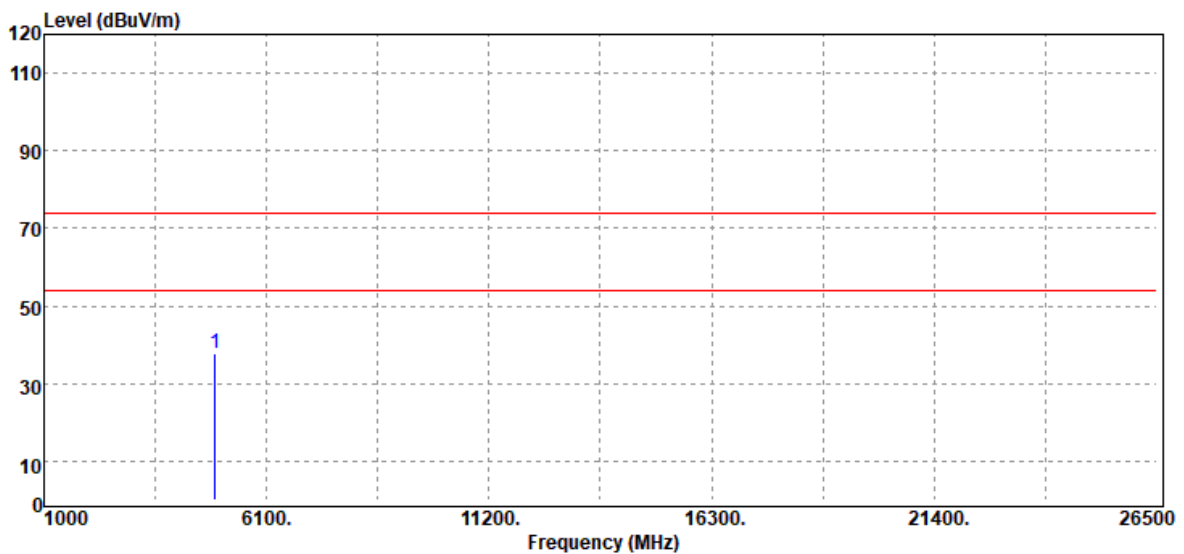

Freq. (MHz)	Detector Mode (PK/QP/AV)	Spectrum Reading Level (dBμV)	Factor (dB)	Actual FS (dBμV/m)	Limit @3m (dBμV/m)	Margin (dB)
4924.00	Peak	48.69	-10.77	37.92	74.00	-36.08
N/A						

Remark:

1. Measuring frequencies from 1 GHz to the 10th harmonic of highest fundamental frequency.
2. For above 1GHz, the EUT peak value was under average limit, therefore the Average value compliance with the average limit

Report No.: T201104D06-RP3

Test Mode	IEEE 802.11g High CH	Temp/Hum	22.9(°C)/ 58%RH
Test Item	Harmonic	Test Date	November 11, 2020
Polarize	Horizontal	Test Engineer	Ray Li
Detector	Peak		

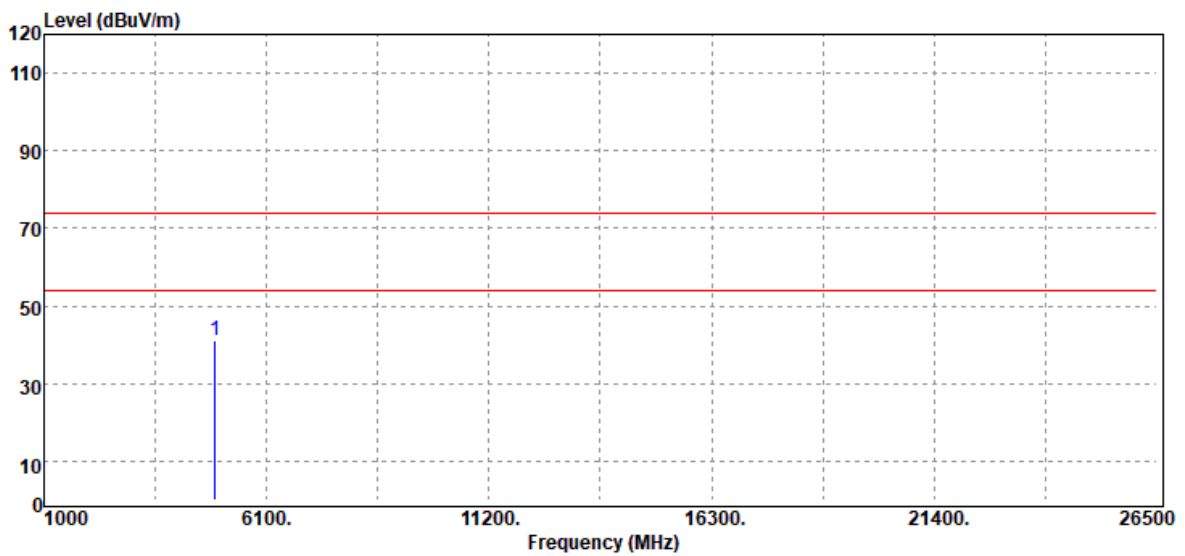

Freq. (MHz)	Detector Mode (PK/QP/AV)	Spectrum Reading Level (dB μ V)	Factor (dB)	Actual FS (dB μ V/m)	Limit @3m (dB μ V/m)	Margin (dB)
4924.00	Peak	51.74	-10.77	40.97	74.00	-33.03
N/A						

Remark:

1. Measuring frequencies from 1 GHz to the 10th harmonic of highest fundamental frequency.
2. For above 1GHz,the EUT peak value was under average limit, therefore the Average value compliance with the average limit

Report No.: T201104D06-RP3

Test Mode	IEEE 802.11n HT20 Low CH	Temp/Hum	22.9(°C)/ 58%RH
Test Item	Harmonic	Test Date	November 11, 2020
Polarize	Vertical	Test Engineer	Ray Li
Detector	Peak		

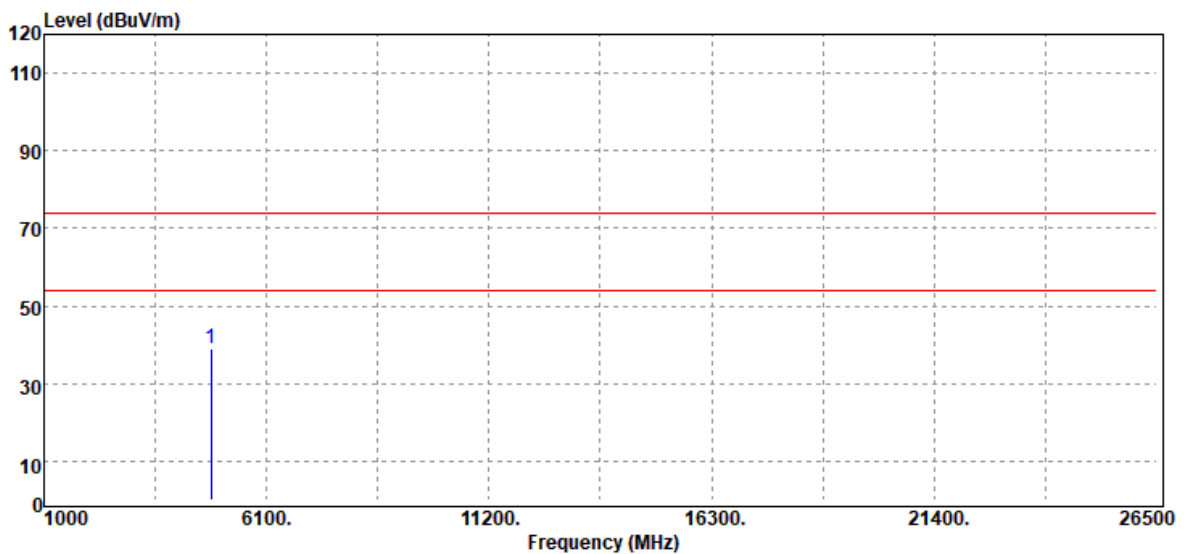

Freq. (MHz)	Detector Mode (PK/QP/AV)	Spectrum Reading Level (dB μ V)	Factor (dB)	Actual FS (dB μ V/m)	Limit @3m (dB μ V/m)	Margin (dB)
4824.00	Peak	50.62	-11.39	39.23	74.00	-34.77
N/A						

Remark:

1. Measuring frequencies from 1 GHz to the 10th harmonic of highest fundamental frequency.
2. For above 1GHz, the EUT peak value was under average limit, therefore the Average value compliance with the average limit

Report No.: T201104D06-RP3

Test Mode	IEEE 802.11n HT20 Low CH	Temp/Hum	22.9(°C)/ 58%RH
Test Item	Harmonic	Test Date	November 11, 2020
Polarize	Horizontal	Test Engineer	Ray Li
Detector	Peak		

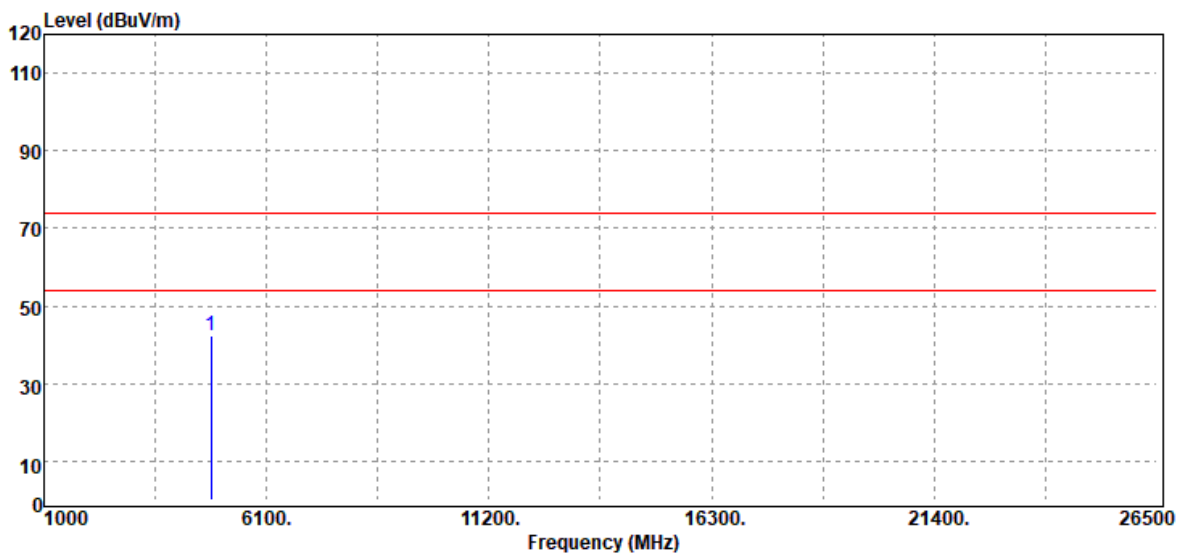

Freq. (MHz)	Detector Mode (PK/QP/AV)	Spectrum Reading Level (dBμV)	Factor (dB)	Actual FS (dBμV/m)	Limit @3m (dBμV/m)	Margin (dB)
4824.00	Peak	53.80	-11.39	42.41	74.00	-31.59
N/A						

Remark:

1. Measuring frequencies from 1 GHz to the 10th harmonic of highest fundamental frequency.
2. For above 1GHz,the EUT peak value was under average limit, therefore the Average value compliance with the average limit

Report No.: T201104D06-RP3

Test Mode	IEEE 802.11n HT20 Mid CH	Temp/Hum	22.9(°C)/ 58%RH
Test Item	Harmonic	Test Date	November 11, 2020
Polarize	Vertical	Test Engineer	Ray Li
Detector	Peak		

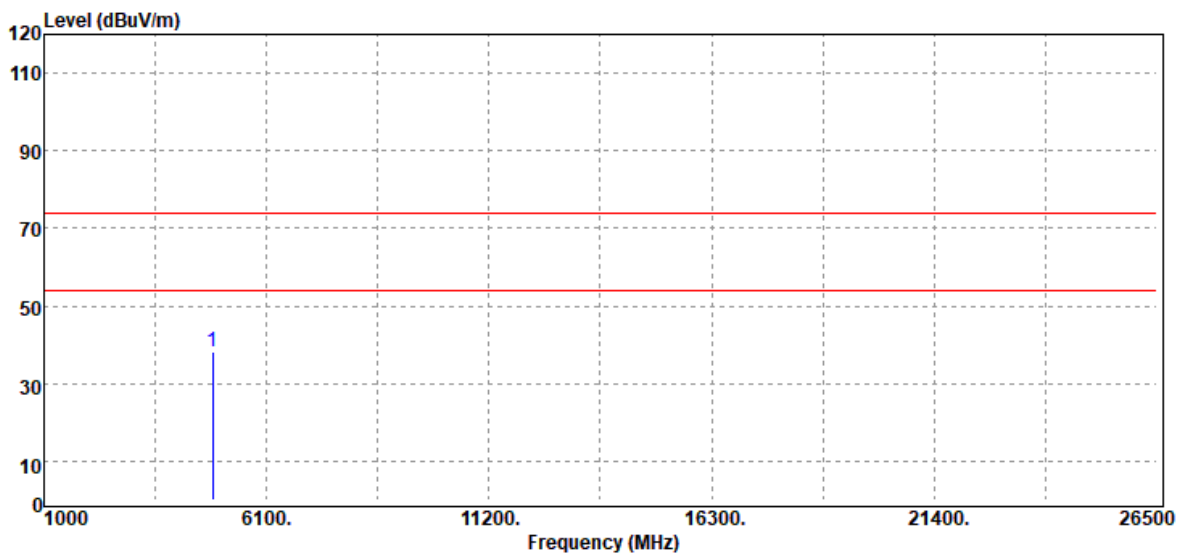

Freq. (MHz)	Detector Mode (PK/QP/AV)	Spectrum Reading Level (dBμV)	Factor (dB)	Actual FS (dBμV/m)	Limit @3m (dBμV/m)	Margin (dB)
4874.00	Peak	49.37	-11.12	38.25	74.00	-35.75
N/A						

Remark:

1. Measuring frequencies from 1 GHz to the 10th harmonic of highest fundamental frequency.
2. For above 1GHz, the EUT peak value was under average limit, therefore the Average value compliance with the average limit

Report No.: T201104D06-RP3

Test Mode	IEEE 802.11n HT20 Mid CH	Temp/Hum	22.9(°C)/ 58%RH
Test Item	Harmonic	Test Date	November 11, 2020
Polarize	Horizontal	Test Engineer	Ray Li
Detector	Peak		

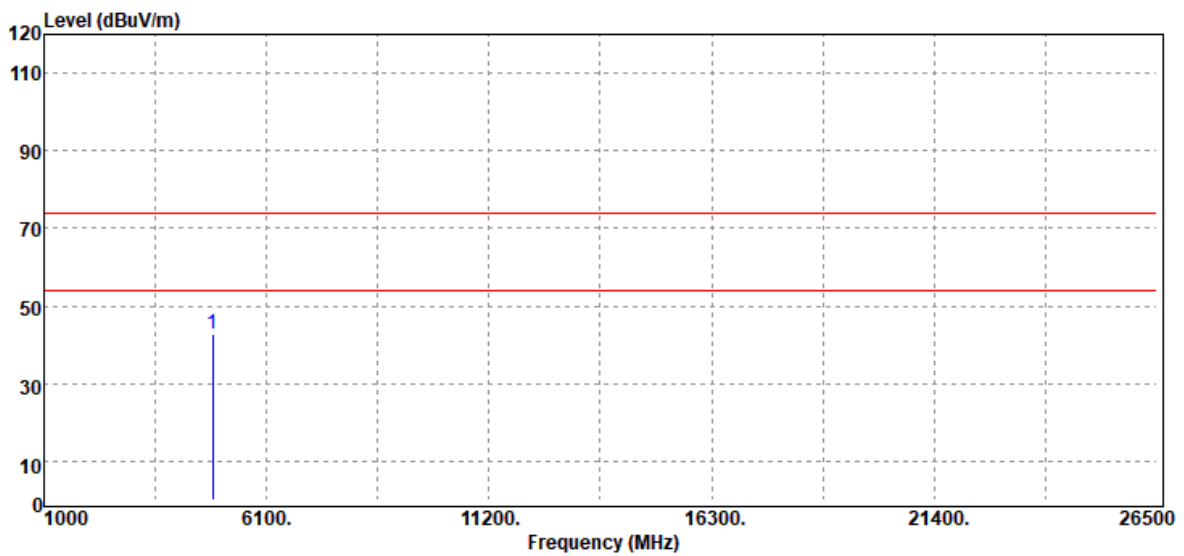

Freq. (MHz)	Detector Mode (PK/QP/AV)	Spectrum Reading Level (dB μ V)	Factor (dB)	Actual FS (dB μ V/m)	Limit @3m (dB μ V/m)	Margin (dB)
4874.00	Peak	53.92	-11.12	42.80	74.00	-31.20
N/A						

Remark:

1. Measuring frequencies from 1 GHz to the 10th harmonic of highest fundamental frequency.
2. For above 1GHz, the EUT peak value was under average limit, therefore the Average value compliance with the average limit

Report No.: T201104D06-RP3

Test Mode	IEEE 802.11n HT20 High CH	Temp/Hum	22.9(°C)/ 58%RH
Test Item	Harmonic	Test Date	November 11, 2020
Polarize	Vertical	Test Engineer	Ray Li
Detector	Peak		

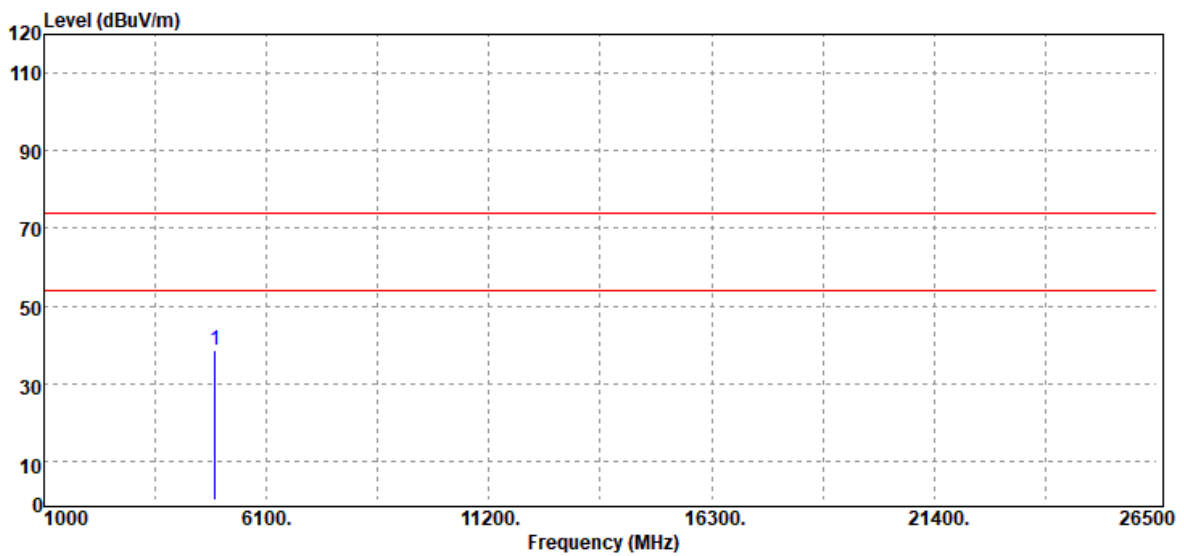

Freq. (MHz)	Detector Mode (PK/QP/AV)	Spectrum Reading Level (dBμV)	Factor (dB)	Actual FS (dBμV/m)	Limit @3m (dBμV/m)	Margin (dB)
4924.00	Peak	49.45	-10.77	38.68	74.00	-35.32
N/A						

Remark:

1. Measuring frequencies from 1 GHz to the 10th harmonic of highest fundamental frequency.
2. For above 1GHz, the EUT peak value was under average limit, therefore the Average value compliance with the average limit

Report No.: T201104D06-RP3

Test Mode	IEEE 802.11n HT20 High CH	Temp/Hum	22.9(°C)/ 58%RH
Test Item	Harmonic	Test Date	November 11, 2020
Polarize	Horizontal	Test Engineer	Ray Li
Detector	Peak		

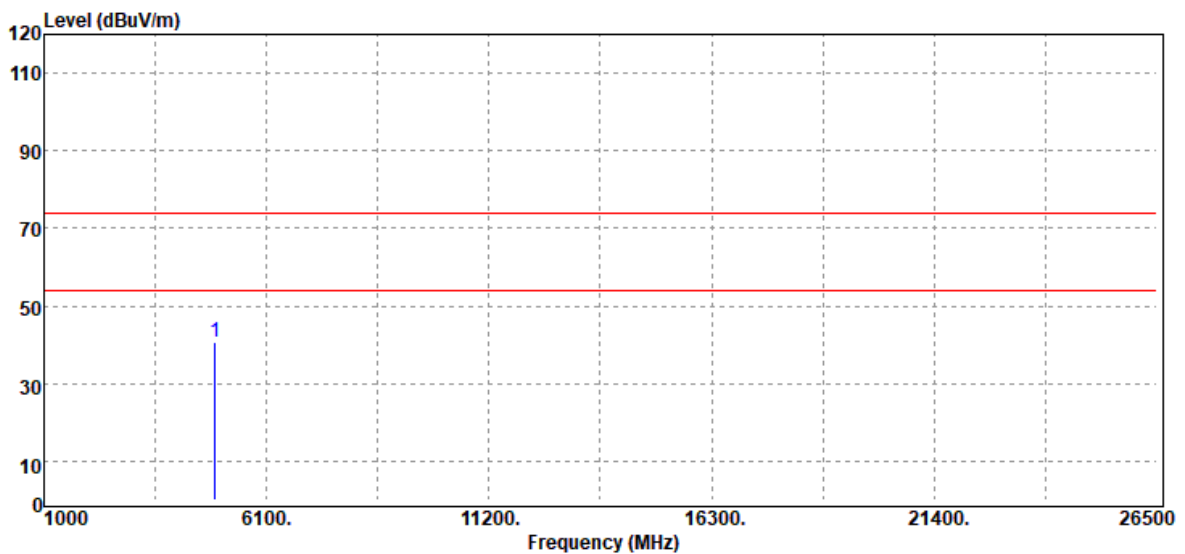

Freq. (MHz)	Detector Mode (PK/QP/AV)	Spectrum Reading Level (dBµV)	Factor (dB)	Actual FS (dBµV/m)	Limit @3m (dBµV/m)	Margin (dB)
4924.00	Peak	51.61	-10.77	40.84	74.00	-33.16
N/A						

Remark:

1. Measuring frequencies from 1 GHz to the 10th harmonic of highest fundamental frequency.
2. For above 1GHz,the EUT peak value was under average limit, therefore the Average value compliance with the average limit

- End of Test Report -