

FCC ID: 2AX7S-LN310A  
Report No.: T201104D06-RP1

Page: 1 / 70  
Rev.: 00

# RADIO TEST REPORT

## FCC 47 CFR PART 15 SUBPART C

<b>Test Standard</b>	<b>FCC Part 15.247</b>
<b>Product name</b>	<b>Digital Paper System</b>
<b>Brand Name</b>	<b>Avalue</b>
<b>Model No.</b>	<b>EL310XX (X= 0~9 or A~Z)</b>
<b>Test Result</b>	<b>Pass</b>
<b>Statements of Conformity</b>	<b>Determination of compliance is based on the results of the compliance measurement, not taking into account measurement instrumentation uncertainty.</b>

The test Result was tested by Compliance Certification Services Inc. The test data, data evaluation, test procedures, and equipment configurations shown in this report were given in ANSI C63.10: 2013 and compliance standards.

The test results of this report relate only to the tested sample (EUT) identified in this report.

The test Report of full or partial shall not copy. Without written approval of Compliance Certification Services Inc. (Wugu Laboratory)

Approved by:



---

Kevin Tsai  
Deputy Manager

Unless otherwise stated the results shown in this test report refer only to the sample(s) tested and such sample(s) are retained for 90 days only.  
除非另有說明，此報告結果僅對測試之樣品負責，同時此樣品僅保留90天。本報告未經本公司書面許可，不可部份複製。

This document is issued by the Company subject to its General Conditions of Service printed overleaf, available on request or accessible at <http://www.sgs.com.tw/Terms-and-Conditions> and, for electronic format documents, subject to Terms and Conditions for Electronic Documents at <http://www.sgs.com.tw/Terms-and-Conditions>. Attention is drawn to the limitation of liability, indemnification and jurisdiction issues defined therein. Any holder of this document is advised that information contained hereon reflects the Company's findings at the time of its intervention only and within the limits of client's instruction, if any. The Company's sole responsibility is to its Client and this document does not exonerate parties to a transaction from exercising all their rights and obligations under the transaction documents. This document cannot be reproduced, except in full, without prior written approval of the Company. Any unauthorized alteration, forgery or falsification of the content or appearance of this document is unlawful and offenders may be prosecuted to the fullest extent of the law.



Report No.: T201104D06-RP1

Page: 2 / 70

Rev.: 00

## Revision History

Rev.	Issue Date	Revisions	Effect Page	Revised By
00	January 11, 2021	Initial Issue	ALL	Mita Wu

## Table of contents

1. GENERAL INFORMATION .....	4
1.1 EUT INFORMATION .....	4
1.2 INFORMATION ABOUT THE FHSS CHARACTERISTICS.....	5
1.3 EUT CHANNEL INFORMATION .....	6
1.4 ANTENNA INFORMATION .....	6
1.5 MEASUREMENT UNCERTAINTY .....	7
1.6 FACILITIES AND TEST LOCATION.....	8
1.7 INSTRUMENT CALIBRATION.....	8
1.8 SUPPORT AND EUT ACCESSORIES EQUIPMENT.....	9
1.9 TEST METHODOLOGY AND APPLIED STANDARDS .....	9
2. TEST SUMMARY .....	10
3. DESCRIPTION OF TEST MODES .....	11
3.1 THE WORST MODE OF OPERATING CONDITION.....	11
3.2 THE WORST MODE OF MEASUREMENT .....	12
3.3 EUT DUTY CYCLE .....	13
4. TEST RESULT .....	14
4.1 AC POWER LINE CONDUCTED EMISSION.....	14
4.2 20DB BANDWIDTH AND OCCUPIED BANDWIDTH (99%).....	17
4.3 OUTPUT POWER MEASUREMENT.....	23
4.4 FREQUENCY SEPARATION.....	25
4.5 NUMBER OF HOPPING .....	28
4.6 CONDUCTED BANDEDGE AND SPURIOUS EMISSION .....	30
4.7 TIME OF OCCUPANCY (DWELL TIME).....	35
4.8 RADIATION BANDEDGE AND SPURIOUS EMISSION .....	37
APPENDIX 1 - PHOTOGRAPHS OF EUT	

Report No.: T201104D06-RP1

## 1. GENERAL INFORMATION

### 1.1 EUT INFORMATION

Applicant	AIMobile Co., Ltd. 6F., No166, Sec. 4, Chengde Rd., Shilin Dist., Taipei City 11167, Taiwan, R.O.C
Manufacturer	AIMobile Co., Ltd. 6F., No166, Sec. 4, Chengde Rd., Shilin Dist., Taipei City 11167, Taiwan, R.O.C
Equipment	Digital Paper System
Model No.	EL310XX (X= 0~9 or A~Z)
Model Discrepancy	All the above models are identical except for the designation of model numbers. The suffix of (X= 0~9 or A~Z) on model number is just for marketing purpose only
Trade Name	Avalue
Received Date	November 4, 2020
Date of Test	November 9 ~ December 7, 2020
Power Operation	1. Power from Host System. Rechargeable Li-Polymer Battery / LIS1633RDPCA Rating: 2000mAh, 7.4Wh 2. Power from Adapter.

**Remark:**

1. For more details, refer to the User's manual of the EUT.
2. Disclaimer: Antenna information is provided by the applicant, test results of this report are applicable to the sample EUT received.
3. Disclaimer: Variant information between/among model numbers / trademarks is provided by the applicant, test results of this report are applicable to the sample EUT received of main test model name.

## 1.2 INFORMATION ABOUT THE FHSS CHARACTERISTICS

### 1.2.1 Pseudorandom Frequency Hopping Sequence

The channel is represented by a pseudo-random hopping sequence hopping through the 79 RF channels. The hopping sequence is unique for the piconet and is determined by the Bluetooth device address of the master; the phase in the hopping sequence is determined by the Bluetooth clock of the master. The channel is divided into time slots where each slot corresponds to an RF hop frequency. Consecutive hops correspond to different RF hop frequencies. The nominal hop rate is 1 600 hops/s.

### 1.2.2 Equal Hopping Frequency Use

The channels of this system will be used equally over the long-term distribution of the hopsets.

### 1.2.3 Example of a 79 hopping sequence in data mode:

02, 05, 31, 24, 20, 10, 43, 36, 30, 23, 40, 06, 21, 50, 44, 09, 71, 78, 01, 13, 73, 07, 70, 72, 35, 62, 42, 11, 41, 08, 16, 29, 60, 15, 34, 61, 58, 04, 67, 12, 22, 53, 57, 18, 27, 76, 39, 32, 17, 77, 52, 33, 56, 46, 37, 47, 64, 49, 45, 38, 69, 14, 51, 26, 79, 19, 28, 65, 75, 54, 48, 03, 25, 66, 05, 16, 68, 74, 59, 63, 55

### 1.2.4 System Receiver Input Bandwidth

Each channel bandwidth is 1MHz.

The system receivers have input bandwidths that match the hopping channel bandwidths of their corresponding transmitters and shift frequencies in synchronization with the transmitted signals.

### 1.2.5 Equipment Description

RSS-247, 5.1 (a): The system shall hop to channel frequencies that are selected at the system hopping rate from a pseudo randomly ordered list of hopping frequencies. The system receivers shall have input bandwidths that match the hopping channel bandwidths of their corresponding transmitters and shall shift frequencies in synchronization with the transmitted signals.

Report No.: T201104D06-RP1

### 1.3 EUT CHANNEL INFORMATION

Frequency Range	2402MHz-2480MHz
Modulation Type	1. GFSK for BDR-1Mbps 2. $\pi/4$ -DQPSK for EDR-2Mbps 3. 8DPSK for EDR-3Mbps
Number of channel	79 Channels

**Remark:**

Refer as ANSI C63.10: 2013 clause 5.6.1 Table 4 and RSS-GEN Table 1 for test channels

Number of frequencies to be tested		
Frequency range in which device operates	Number of frequencies	Location in frequency range of operation
<input type="checkbox"/> 1 MHz or less	1	Middle
<input type="checkbox"/> 1 MHz to 10 MHz	2	1 near top and 1 near bottom
<input checked="" type="checkbox"/> More than 10 MHz	3	1 near top, 1 near middle, and 1 near bottom

### 1.4 ANTENNA INFORMATION

Antenna Type	<input checked="" type="checkbox"/> PIFA <input type="checkbox"/> PCB <input type="checkbox"/> Dipole <input type="checkbox"/> Coils
Antenna Gain	2.8 dBi
Antenna Connector	IPEX

## 1.5 MEASUREMENT UNCERTAINTY

PARAMETER	UNCERTAINTY
AC Powerline Conducted Emission	+/- 1.2575
Emission bandwidth, 20dB bandwidth	+/- 0.0014
RF output power, conducted	+/- 1.14
Power density, conducted	+/- 1.40
3M Semi Anechoic Chamber / 30M~200M	+/- 4.12
3M Semi Anechoic Chamber / 200M~1000M	+/- 4.68
3M Semi Anechoic Chamber / 1G~8G	+/- 5.18
3M Semi Anechoic Chamber / 8G~18G	+/- 5.47
3M Semi Anechoic Chamber / 18G~26G	+/- 3.81
3M Semi Anechoic Chamber / 26G~40G	+/- 3.87

**Remark:**

- 1.This uncertainty represents an expanded uncertainty expressed at approximately the 95% confidence level using a coverage factor of k=2
2. ISO/IEC 17025 requires that an estimate of the measurement uncertainties associated with the emissions test results be included in the report.

Report No.: T201104D06-RP1

## 1.6 FACILITIES AND TEST LOCATION

All measurement facilities used to collect the measurement data are located at No.11, Wugong 6th Rd., Wugu Dist., New Taipei City, Taiwan. (R.O.C.)

Test site	Test Engineer	Remark
AC Conduction Room	Lance Chen	-
Radiation	Ray Li, Jerry Chang	-
RF Conducted	Rick Lee	-

**Remark:** The sites are constructed in conformance with the requirements of ANSI C63.7, ANSI C63.4 and CISPR Publication 22.

## 1.7 INSTRUMENT CALIBRATION

3M 966 Chamber Test Site					
Equipment	Manufacturer	Model	S/N	Cal Date	Cal Due
Band Reject Filters	MICRO TRONICS	BRM 50702	120	02/25/2020	02/24/2021
Bilog Antenna	Sunol Sciences	JB3	A030105	07/24/2020	07/23/2021
Coaxial Cable	HUBER SUHNER	SUCOFLEX 104PEA	20995	02/25/2020	02/24/2021
Coaxial Cable	EMCI	EMC105	190914+327109/4	09/19/2020	09/18/2021
Digital Thermo-Hygro Meter	WISEWIND	1206	D07	01/15/2020	01/14/2021
double Ridged Guide Horn Antenna	ETC	MCTD 1209	DRH13M02003	09/30/2020	09/29/2021
Loop Ant	COM-POWER	AL-130	121051	03/27/2020	03/26/2021
Pre-Amplifier	EMEC	EM330	060609	02/25/2020	02/24/2021
Pre-Amplifier	EMEC	EM01G26G	060570	06/29/2020	06/28/2021
PSA Series Spectrum Analyzer	Agilent	E4446A	MY46180323	07/24/2020	07/23/2021
Antenna Tower	CCS	CC-A-1F	N/A	N.C.R	N.C.R
Controller	CCS	CC-C-1F	N/A	N.C.R	N.C.R
Turn Table	CCS	CC-T-1F	N/A	N.C.R	N.C.R
Software	e3 6.11-20180413				

Conducted Emission Room # B					
Name of Equipment	Manufacturer	Model	Serial Number	Calibration Date	Calibration Due
CABLE	EMCI	CFD300-NL	CERF	06/29/2020	06/28/2021
EMI Test Receiver	R&S	ESCI	100064	07/17/2020	07/16/2021
LISN	SCHAFFNER	NNB 41	03/10013	02/13/2020	02/12/2021
Software	EZ-EMC(CCS-3A1-CE)				

**Remark:** Each piece of equipment is scheduled for calibration once a year.



Report No.: T201104D06-RP1

RF Conducted Test Site					
Name of Equipment	Manufacturer	Model	Serial Number	Calibration Date	Calibration Due
Coaxial Cable	Woken	WC12	CC003	06/29/2020	06/28/2021
Coaxial Cable	Woken	WC12	CC001	06/29/2020	06/28/2021
Signal Analyzer	R&S	FSV 40	101073	09/17/2020	09/16/2021
Power Meter	Anritsu	ML2495A	1149001	N.C.R	N.C.R
Power Seneor	Anritsu	MA2491A	030982	N.C.R	N.C.R
Software	N/A				

Remark: Each piece of equipment is scheduled for calibration once a year.

## 1.8 SUPPORT AND EUT ACCESSORIES EQUIPMENT

EUT Accessories Equipment					
No.	Equipment	Brand	Model	Series No.	FCC ID
	N/A				

Support Equipment					
No.	Equipment	Brand	Model	Series No.	FCC ID
1	NB(J)	TOSHIBA	PT345T-00L002	N/A	N/A

## 1.9 TEST METHODOLOGY AND APPLIED STANDARDS

The test methodology, setups and results comply with all requirements in accordance with ANSI C63.10:2013, FCC Part 2, FCC Part 15.247.

Report No.: T201104D06-RP1

## 2. TEST SUMMARY

FCC Standard Section	Report Section	Test Item	Result
15.203	1.3	Antenna Requirement	Pass
15.207(a)	4.1	AC Conducted Emission	Pass
15.247(a)(1)	4.2	20 dB Bandwidth	Pass
-	4.2	Occupied Bandwidth (99%)	Pass
15.247(b)(1)	4.3	Output Power Measurement	Pass
15.247(a)(1)	4.4	Frequency Separation	Pass
15.247(a)(1)(iii)	4.5	Number of Hopping	Pass
15.247(d)	4.6	Conducted Band Edge	Pass
15.247(d)	4.6	Conducted Spurious Emission	Pass
15.247(a)(1)(iii)	4.7	Time of Occupancy	Pass
15.247(d)	4.8	Radiation Band Edge	Pass
15.247(d)	4.8	Radiation Spurious Emission	Pass

Report No.: T201104D06-RP1

### 3. DESCRIPTION OF TEST MODES

#### 3.1 THE WORST MODE OF OPERATING CONDITION

Operation mode	GFSK for BDR-1Mbps (DH5) 8DPSK for EDR-3Mbps (3DH5)
Test Channel Frequencies	<p><b>GFSK for BDR-1Mbps:</b></p> <p>1.Lowest Channel: 2402MHz 2.Middle Channel: 2441MHz 3.Highest Channel: 2480MHz</p> <p><b>8DPSK for EDR-3Mbps:</b></p> <p>1.Lowest Channel: 2402MHz 2.Middle Channel: 2441MHz 3.Highest Channel: 2480MHz</p>

Remark:

1. EUT pre-scanned data rate of output power for each mode, the worst data rate were recorded in this report.

Report No.: T201104D06-RP1

### 3.2 THE WORST MODE OF MEASUREMENT

AC Power Line Conducted Emission	
Test Condition	AC Power line conducted emission for line and neutral
Power supply Mode	Mode 1: EUT power by Adapter
Worst Mode	<input checked="" type="checkbox"/> Mode 1 <input type="checkbox"/> Mode 2 <input type="checkbox"/> Mode 3 <input type="checkbox"/> Mode 4

Radiated Emission Measurement Below 1G	
Test Condition	Radiated Emission Below 1G
Power supply Mode	Mode 1: EUT power by Host System
Worst Mode	<input checked="" type="checkbox"/> Mode 1 <input type="checkbox"/> Mode 2 <input type="checkbox"/> Mode 3 <input type="checkbox"/> Mode 4

Radiated Emission Measurement Above 1G	
Test Condition	Radiated Emission Above 1G
Power supply Mode	Mode 1: EUT power by Host System
Worst Mode	<input checked="" type="checkbox"/> Mode 1 <input type="checkbox"/> Mode 2 <input type="checkbox"/> Mode 3 <input type="checkbox"/> Mode 4
Worst Position	<input type="checkbox"/> Placed in fixed position. <input checked="" type="checkbox"/> Placed in fixed position at X-Plane (E2-Plane) <input type="checkbox"/> Placed in fixed position at Y-Plane (E1-Plane) <input type="checkbox"/> Placed in fixed position at Z-Plane (H-Plane)

Remark:

1. The worst mode was record in this test report.
2. EUT pre-scanned in three axis ,X,Y, Z and two polarity, for radiated measurement. The worst case(X-Plane) were recorded in this report
3. AC power line conducted emission and for below 1G radiation emission were performed the EUT transmit at the highest output power channel as worse case.

Report No.: T201104D06-RP1

### 3.3 EUT DUTY CYCLE

Temperature: 24.1°C      Test Date: November 17, 2020  
Humidity: 54.2% RH      Test by: Rick Lee

Duty Cycle				
Configuration	Duty Cycle (%)	Duty Factor (dB) =10*log (1/Duty Cycle)	1/T (kHz)	VBW setting (kHz)
BDR-1Mbps	76.80%	1.15	0.35	1.00
EDR-3Mbps	78.00%	1.15	0.35	1.00



Report No.: T201104D06-RP1

## 4. TEST RESULT

### 4.1 AC POWER LINE CONDUCTED EMISSION

#### 4.1.1 Test Limit

According to §15.207(a) and RSS-GEN section 8.8,

Frequency Range (MHz)	Limits(dBμV)	
	Quasi-peak	Average
0.15 to 0.50	66 to 56*	56 to 46*
0.50 to 5	56	46
5 to 30	60	50

\* Decreases with the logarithm of the frequency.

#### 4.1.2 Test Procedure

Test method Refer as ANSI C63.10: 2013 clause 6.2,

1. The EUT was placed on a non-conducted table, which is 0.8m above horizontal ground plane and 0.4m above vertical ground plane.
2. EUT connected to the line impedance stabilization network (LISN)
3. Receiver set RBW of 9kHz and Detector Peak, and note as quasi-peak and average.
4. Maximum procedure was performed on the six highest emissions to ensure EUT compliance.
5. Recorded Line for Neutral and Line.

#### 4.1.3 Test Setup

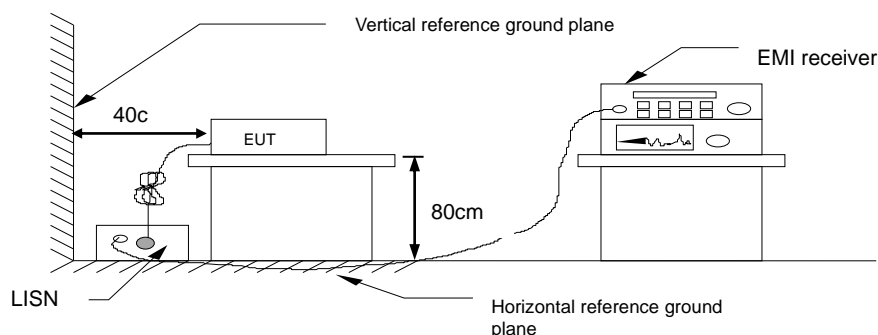

#### 4.1.4 Test Result

**PASS**

Report No.: T201104D06-RP1

## Test Data

Test Mode:	Mode 1	Temp/Hum	22.4(°C)/ 57%RH
Phase:	Line	Test Date	December 7, 2020
Voltage:	120Vac, 60Hz	Test Engineer	Rick Lee

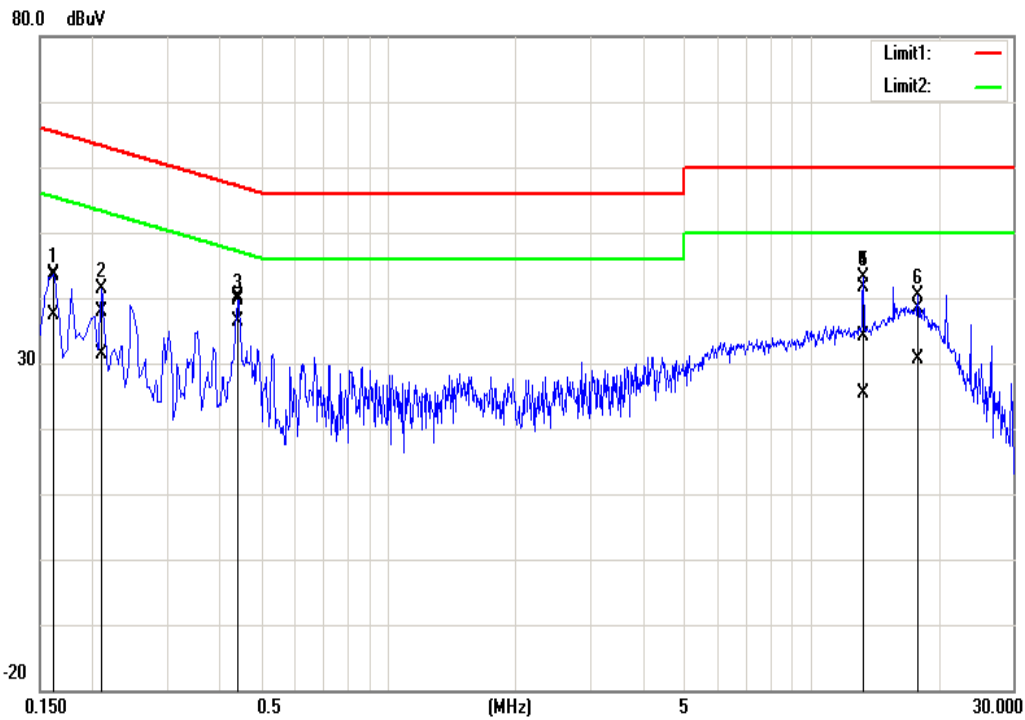

Frequency (MHz)	Quasi Peak reading (dBuV)	Average reading (dBuV)	Correction factor (dB)	Quasi Peak result (dBuV)	Average result (dBuV)	Quasi Peak limit (dBuV)	Average limit (dBuV)	Quasi Peak margin (dB)	Average margin (dB)	Remark
0.1620	33.20	27.28	10.21	43.41	37.49	65.36	55.36	-21.95	-17.87	Pass
0.2100	27.58	21.08	10.21	37.79	31.29	63.21	53.21	-25.42	-21.92	Pass
0.4420	29.99	26.21	10.22	40.21	36.43	57.02	47.02	-16.81	-10.59	Pass
13.2820	23.83	14.87	10.39	34.22	25.26	60.00	50.00	-25.78	-24.74	Pass
13.2820	31.16	31.16	10.39	41.55	41.55	60.00	50.00	-18.45	-8.45	Pass
17.8860	27.93	20.14	10.39	38.32	30.53	60.00	50.00	-21.68	-19.47	Pass

Report No.: T201104D06-RP1

Test Mode:	Mode 1	Temp/Hum	22.4(°C)/ 57%RH
Phase:	Neutral	Test Date	December 7, 2020
Voltage:	120Vac, 60Hz	Test Engineer	Rick Lee

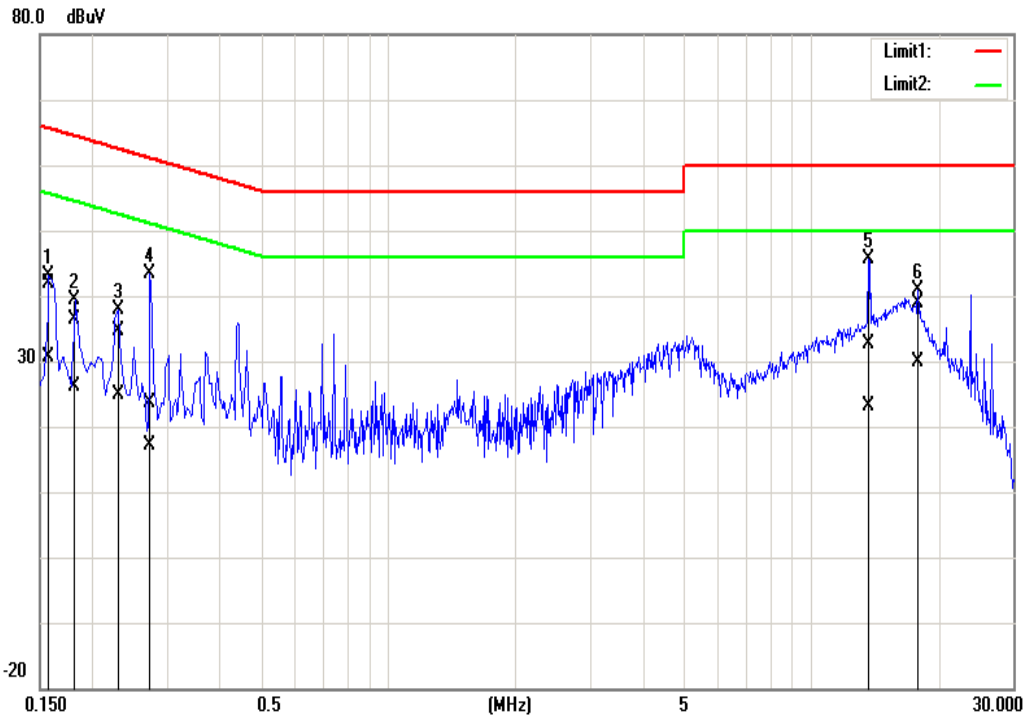

Frequency (MHz)	Quasi Peak reading (dBuV)	Average reading (dBuV)	Correction factor (dB)	Quasi Peak result (dBuV)	Average result (dBuV)	Quasi Peak limit (dBuV)	Average limit (dBuV)	Quasi Peak margin (dB)	Average margin (dB)	Remark
0.1580	31.63	20.54	10.18	41.81	30.72	65.57	55.57	-23.76	-24.85	Pass
0.1820	26.25	15.99	10.19	36.44	26.18	64.39	54.39	-27.95	-28.21	Pass
0.2300	24.33	14.81	10.19	34.52	25.00	62.45	52.45	-27.93	-27.45	Pass
0.2740	13.45	6.96	10.19	23.64	17.15	61.00	51.00	-37.36	-33.85	Pass
13.6780	22.35	12.72	10.37	32.72	23.09	60.00	50.00	-27.28	-26.91	Pass
17.8860	28.47	19.40	10.40	38.87	29.80	60.00	50.00	-21.13	-20.20	Pass



Report No.: T201104D06-RP1

## 4.2 20dB BANDWIDTH AND OCCUPIED BANDWIDTH (99%)

### 4.2.1 Test Limit

According to §15.247(a) (1),

**20 dB Bandwidth** : For reporting purposes only.

**Occupied Bandwidth(99%)** : For reporting purposes only.

### 4.2.2 Test Procedure

Test method Refer as ANSI C63.10: 2013 clause 7.8.7,

1. The EUT RF output connected to the spectrum analyzer by RF cable.
2. Setting maximum power transmit of EUT
3. SA set RBW = 30kHz, VBW = 100kHz and Detector = Peak, to measurement 20 dB Bandwidth.
4. SA set RBW = 1% ~ 5% OBW, VBW = three times the RBW and Detector = Peak, to measurement 99% Bandwidth
5. Measure and record the result of 20 dB Bandwidth and 99% Bandwidth. in the test report.

### 4.2.3 Test Setup

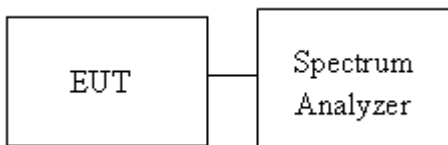

Report No.: T201104D06-RP1

#### 4.2.4 Test Result

Temperature: 24.7°C                      Test Date: November 13, 2020  
Humidity: 55% RH                      Test by: Rick Lee

Test mode: GFSK_BDR-1Mbps mode / 2402-2480 MHz			
Channel	Frequency (MHz)	OBW(99%) (MHz)	20dB BW (MHz)
Low	2402	0.8639	0.9478
Mid	2441	0.8683	0.9478
High	2480	0.8683	0.9522

Test mode: 8DPSK_EDR-3Mbps mode / 2402-2480 MHz			
Channel	Frequency (MHz)	OBW(99%) (MHz)	20dB BW (MHz)
Low	2402	1.1809	1.2913
Mid	2441	1.1809	1.2913
High	2480	1.1809	1.2957

Report No.: T201104D06-RP1

## Test Data

### 20dB BANDWIDTH

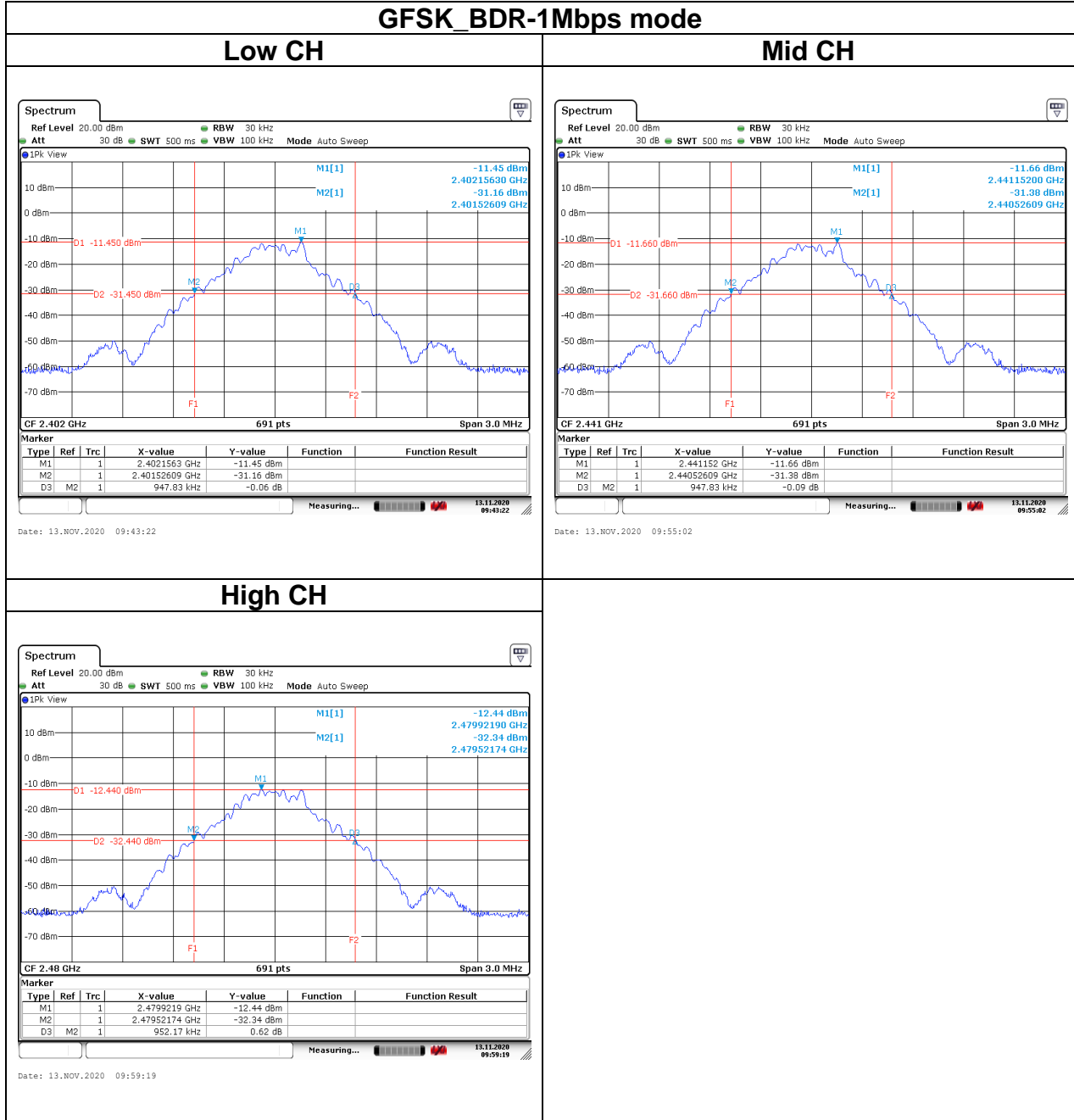

Report No.: T201104D06-RP1

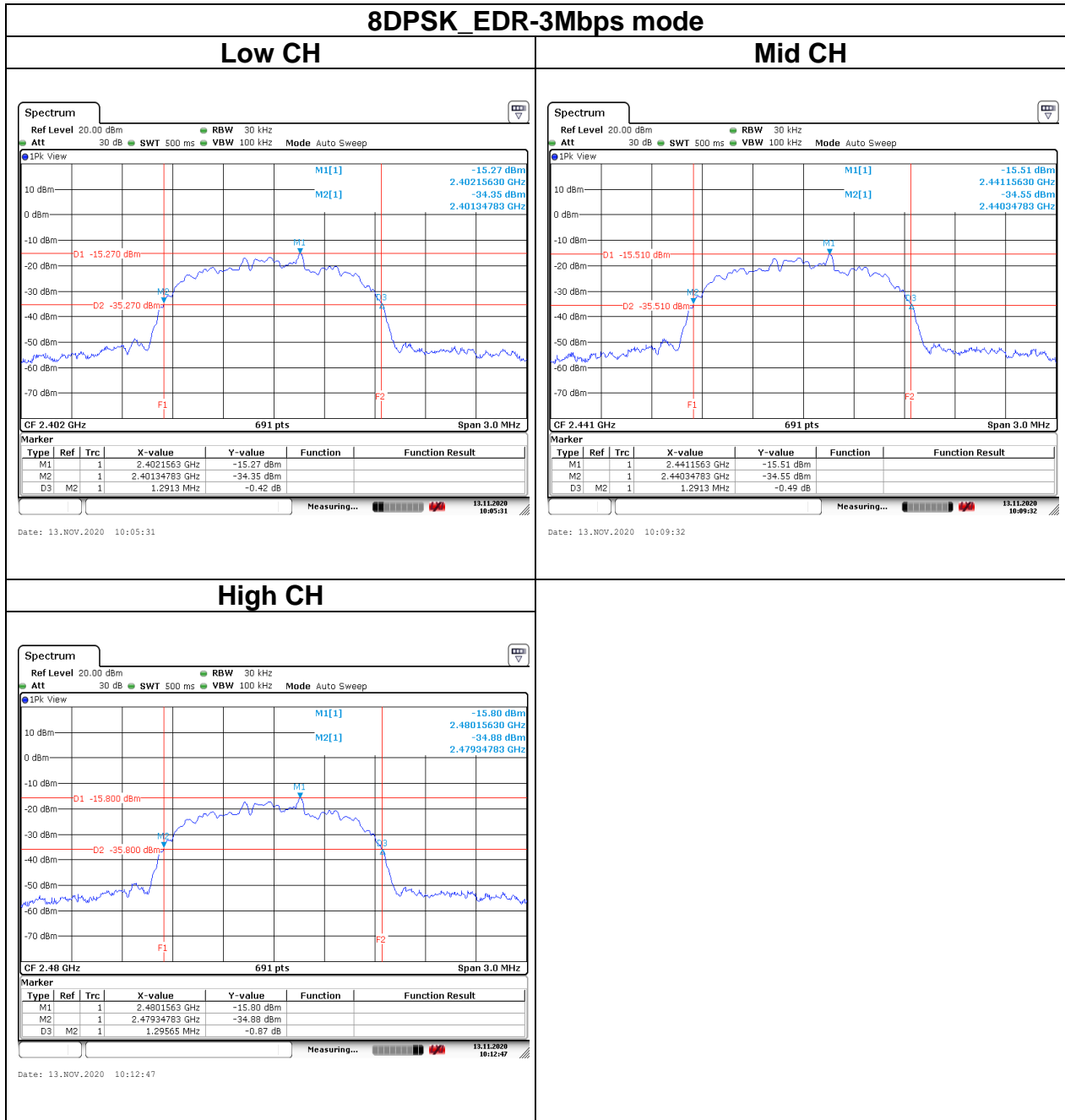

Report No.: T201104D06-RP1

## Test Data

### BANDWIDTH 99%

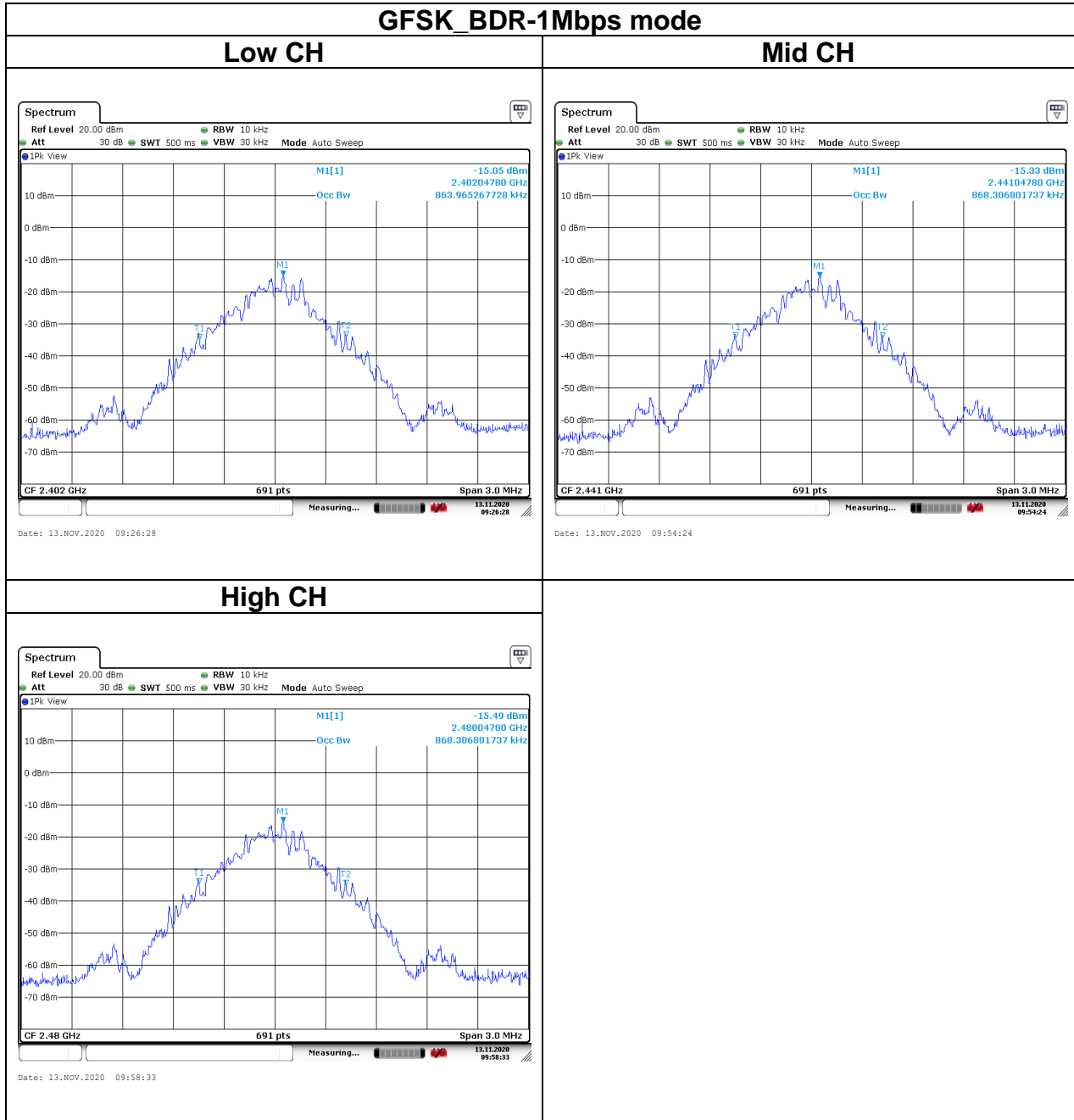

Report No.: T201104D06-RP1

## 8DPSK\_EDR-3Mbps mode

### Low CH

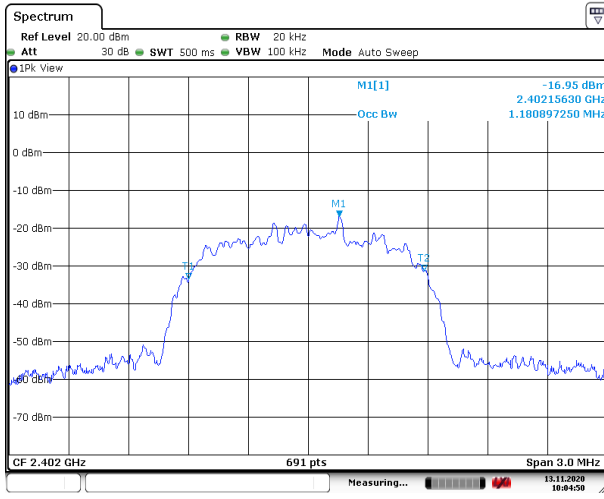

### Mid CH

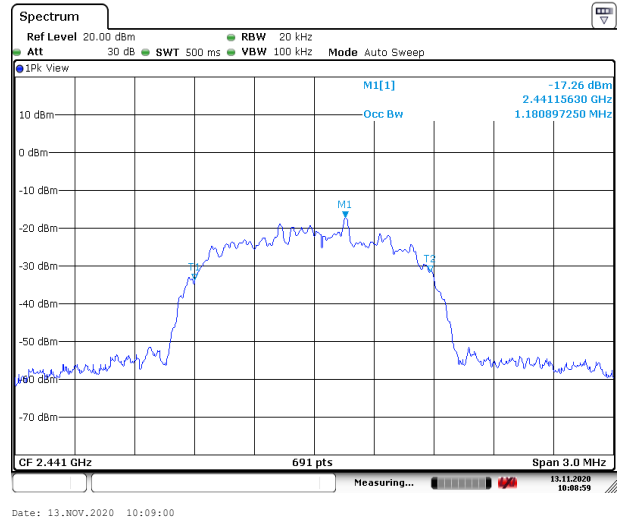

### High CH

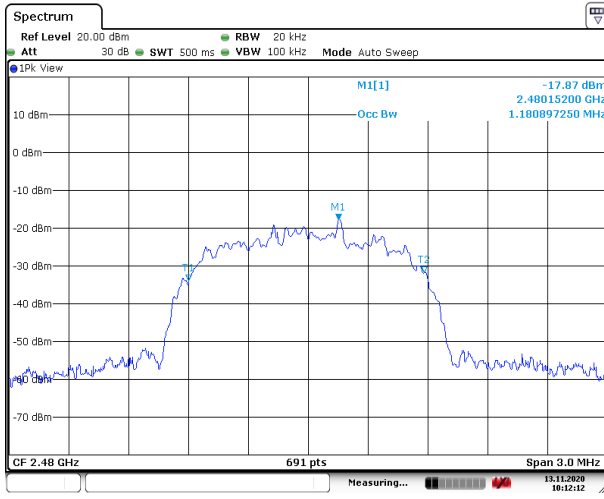

Report No.: T201104D06-RP1

### 4.3 OUTPUT POWER MEASUREMENT

#### 4.3.1 Test Limit

According to §15.247(a)(1)

**Peak output power** :

#### **FCC**

Alternatively, frequency hopping systems operating in the 2400-2483.5 MHz band may have hopping channel carrier frequencies that are separated by 25 kHz or two-thirds of the 20 dB bandwidth of the hopping channel, whichever is greater, provided the systems operate with an output power no greater than 125 mW.

Limit	<input checked="" type="checkbox"/> Antenna not exceed 6 dBi : 21dBm <input type="checkbox"/> Antenna with DG greater than 6 dBi : 21dBm [ Limit = 30 – (DG – 6)]
-------	--

**Average output power** : For reporting purposes only.

#### 4.3.2 Test Procedure

1. The EUT RF output connected to the power meter by RF cable.
2. Setting maximum power transmit of EUT.
3. The path loss was compensated to the results for each measurement.
4. Measure and record the result of Peak output power and Average output power. in the test report.

#### 4.3.3 Test Setup

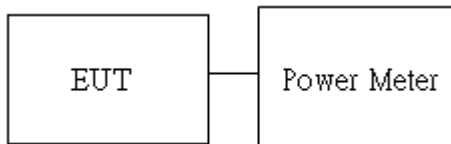

Report No.: T201104D06-RP1

### 4.3.4 Test Result

Temperature: 25°C                      Test Date: November 23, 2020  
Humidity: 57% RH                      Test by: Rick Lee

**Peak output power :**

BT							
Config.	CH	Freq. (MHz)	Power Setting	PK Power (dBm)	PK Power (W)	FCC/IC Limit (dBm)	Antenna Gain (dBi)
GFSK BR-1Mbps (DH5)	0	2402	3	<b>4.91</b>	0.0031	21	2.8
	39	2441	3	4.56	0.0029		
	78	2480	3	4.62	0.0029		
8DPSK EDR-3Mbps (3DH5)	0	2402	6	<b>6.89</b>	0.0049		
	39	2441	6	6.73	0.0047		
	78	2480	6	6.42	0.0044		

**Average output power :**

BT			
Config.	CH	Freq. (MHz)	AV Power (dBm)
GFSK BR-1Mbps (DH5)	0	2402	3.93
	39	2441	3.59
	78	2480	3.56
8DPSK EDR-3Mbps (3DH5)	0	2402	3.67
	39	2441	3.72
	78	2480	3.54



Report No.: T201104D06-RP1

## 4.4 FREQUENCY SEPARATION

### 4.4.1 Test Limit

According to §15.247(a)(1)

Alternatively, frequency hopping systems operating in the 2400-2483.5 MHz band may have hopping channel carrier frequencies that are separated by 25 kHz or two-thirds of the 20 dB bandwidth of the hopping channel, whichever is greater, provided the systems operate with an output power no greater than 125 mW.

Limit	> two-thirds of the 20 dB bandwidth
-------	-------------------------------------

### 4.4.2 Test Procedure

1. Place the EUT on the table and set it in transmitting mode.
2. EUT RF output port connected to the SA by RF cable.
3. Set the spectrum analyzer as RBW = 100kHz, VBW = 300kHz, Sweep = auto.  
Max hold, mark 3 peaks of hopping channel and record the 3 peaks frequency

### 4.4.3 Test Setup

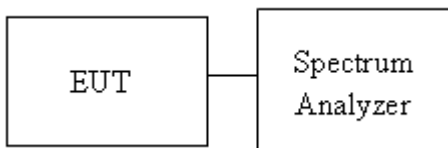

Report No.: T201104D06-RP1

#### 4.4.4 Test Result

Temperature: 24.7°C                      Test Date: November 13, 2020  
Humidity: 55% RH                         Test by: Rick Lee

Test mode: GFSK_BDR-1Mbps mode / 2402-2480 MHz				
Channel	Frequency (MHz)	Channel Separation (MHz)	Channel Separation Limits (MHz)	Result
Low	2402	0.9986	0.632	PASS
Mid	2441	0.9986	0.632	PASS
High	2480	0.9986	0.635	PASS

Test mode: 8DPSK_EDR-3Mbps mode / 2402-2480 MHz				
Channel	Frequency (MHz)	Channel Separation (MHz)	Channel Separation Limits (MHz)	Result
Low	2402	0.9942	0.861	PASS
Mid	2441	0.9942	0.861	PASS
High	2480	0.9942	0.864	PASS

Report No.: T201104D06-RP1

## Test Data

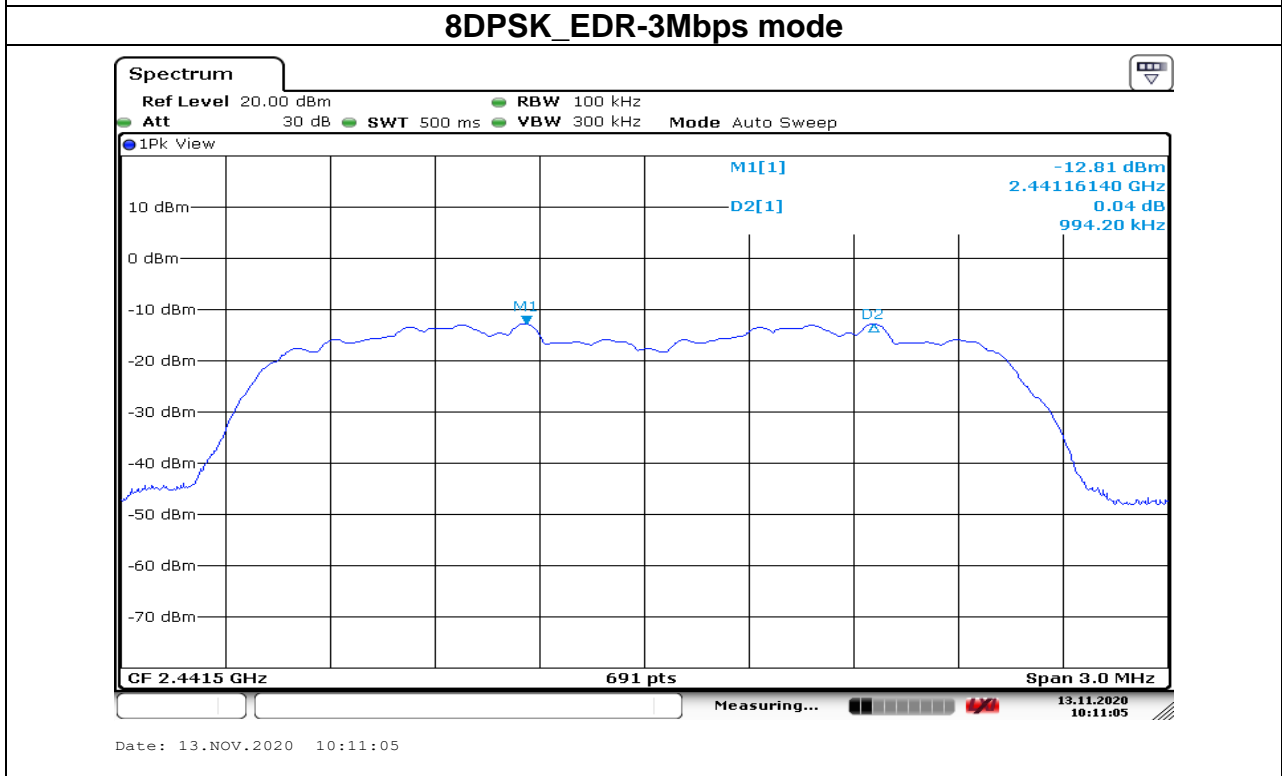
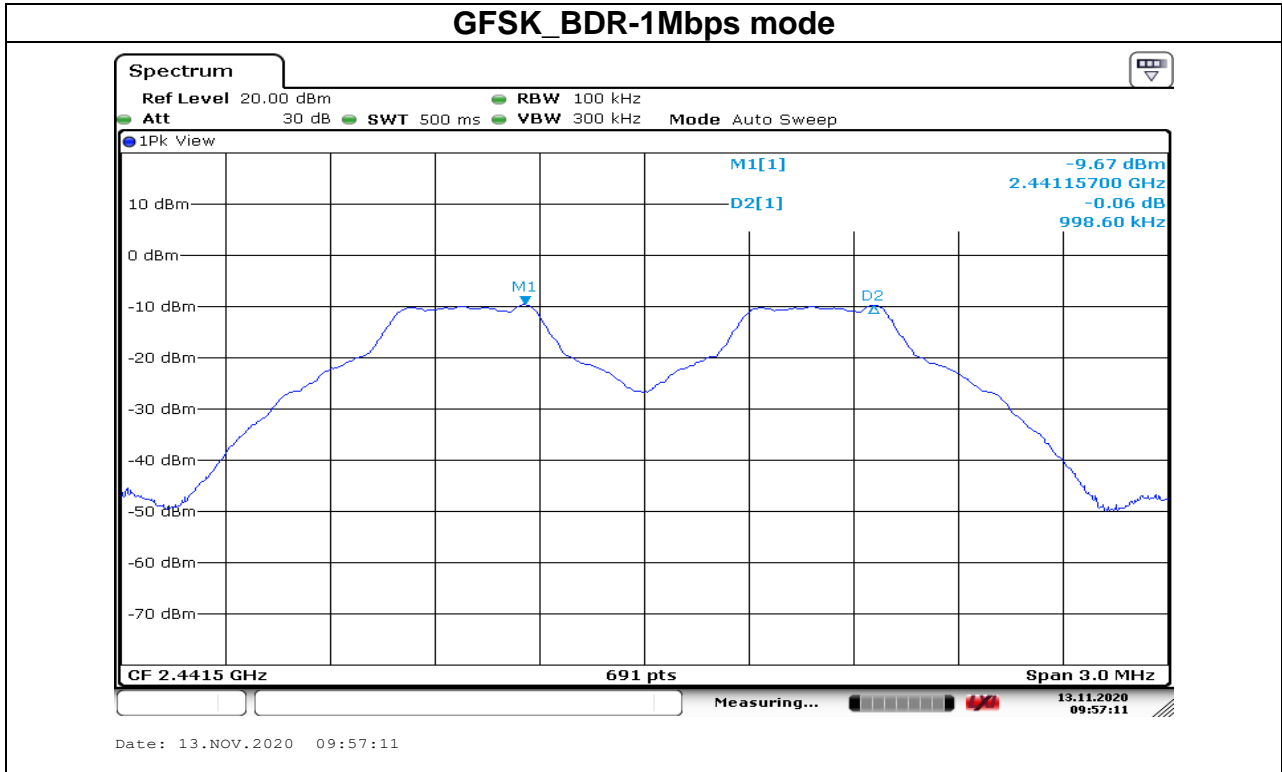

**Note:** We selected worst case to performed test in middle channel, The results can be meet other channel.

Report No.: T201104D06-RP1

## 4.5 NUMBER OF HOPPING

### 4.5.1 Test Limit

According to §15.247(a)(1)(iii)

Frequency hopping systems in the 2400-2483.5 MHz band shall use at least 15 channels.

### 4.5.2 Test Procedure

Test method Refer as ANSI C63.10: 2013 clause 7.8.3

1. Place the EUT on the table and set it in transmitting mode.
2. EUT RF output port connected to the SA by RF cable.
3. Set spectrum analyzer Start Freq. = 2400 MHz, Stop Freq. = 2483.5 MHz, RBW = 100KHz, VBW = 300KHz.
4. Max hold, view and count how many channel in the band.

### 4.5.3 Test Setup

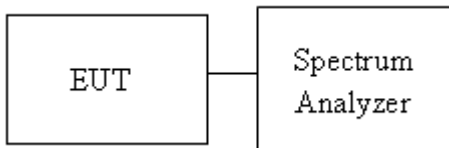

### 4.5.4 Test Result

**Temperature:** 24.7°C                      **Test Date:** November 13, 2020  
**Humidity:** 55% RH                         **Test by:** Rick Lee

Number of Hopping				
Mode	Frequency (MHz)	Hopping Channel Number	Hopping Channel Number Limits	Result
BDR-1Mbps	2402-2480	79	15	Pass
EDR-3Mbps	2402-2480	79	15	

Report No.: T201104D06-RP1

## Test Data

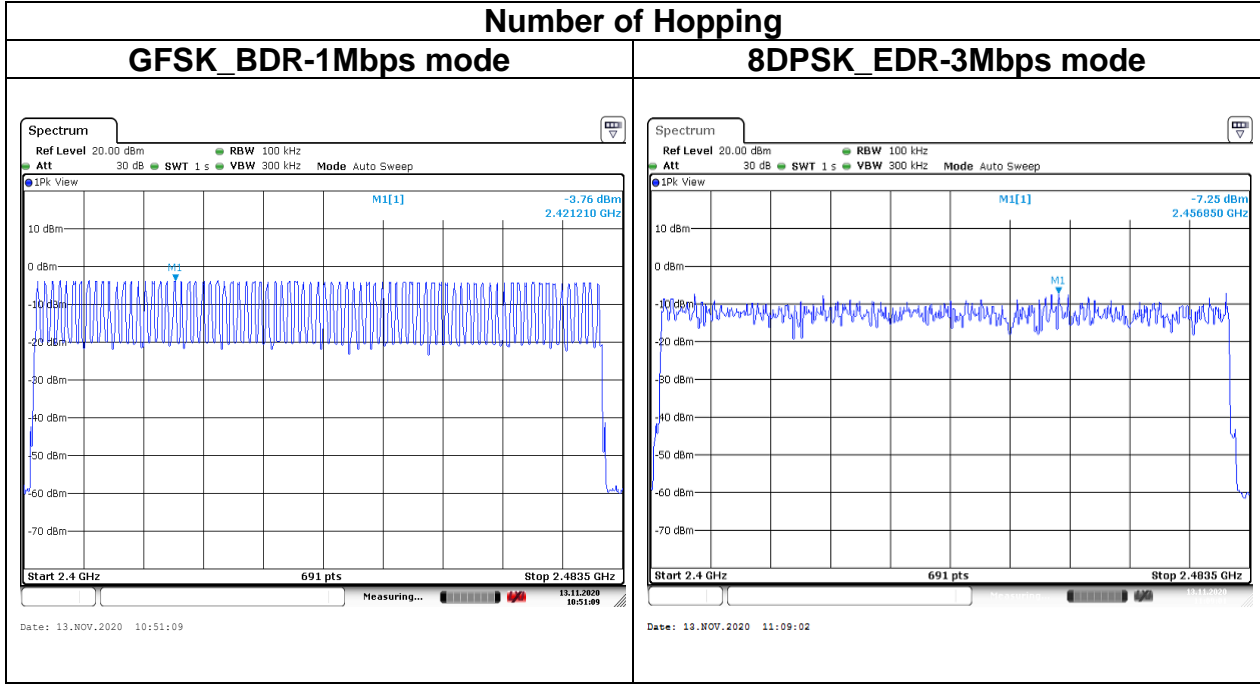

Report No.: T201104D06-RP1

## 4.6 CONDUCTED BANDEDGE AND SPURIOUS EMISSION

### 4.6.1 Test Limit

According to §15.247(d)

Limit	-20 dBc
-------	---------

### 4.6.2 Test Procedure

1. EUT RF output port connected to the SA by RF cable, and the path loss was compensated to result.
2. SA setting, RBW=100kHz, VBW=300kHz, Detector=Peak, Trace mode = max hold, SWT = Auto.
3. The Band Edge at 2.4GHz and 2.4835GHz are investigated with both hopping “ON” and “OFF” modes “.

### 4.6.3 Test Setup

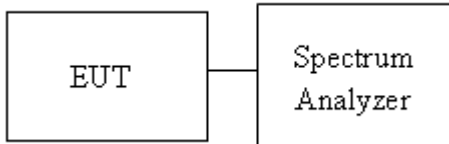

**Temperature:** 24.7°C  
**Humidity:** 55% RH

**Test Date:** November 13, 2020  
**Test by:** Rick Lee

Report No.: T201104D06-RP1

## 4.6.4 Test Result

### Test Data

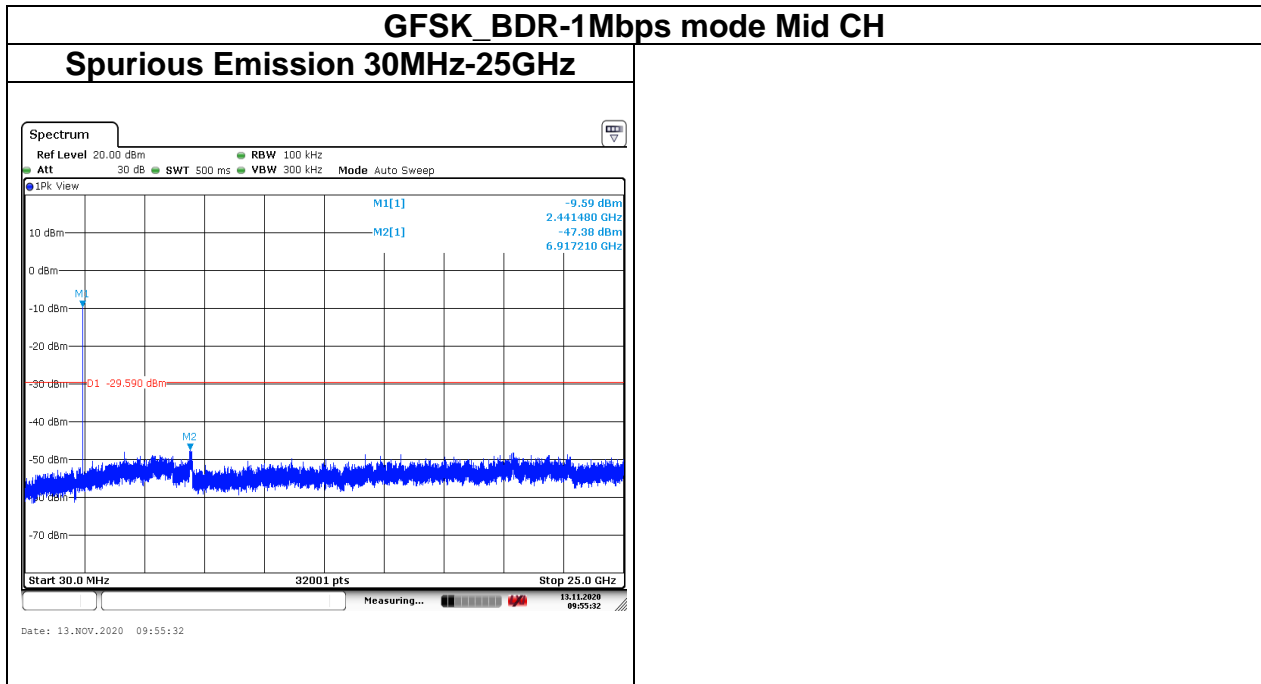
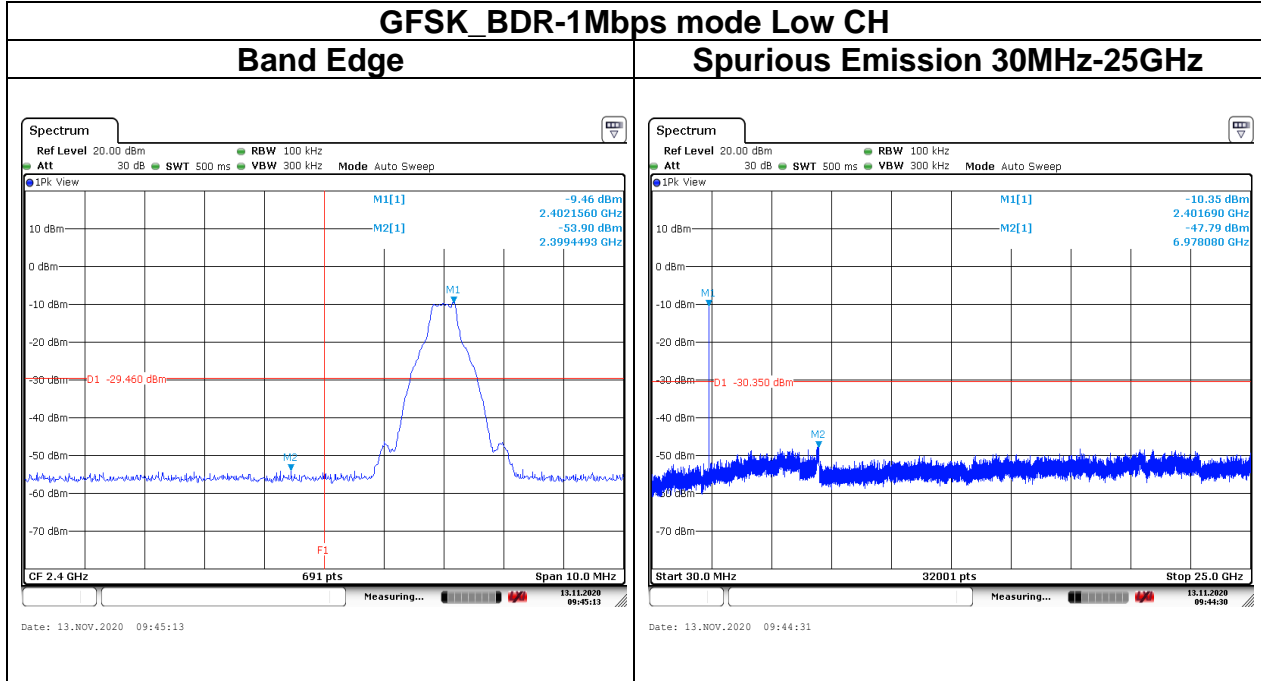

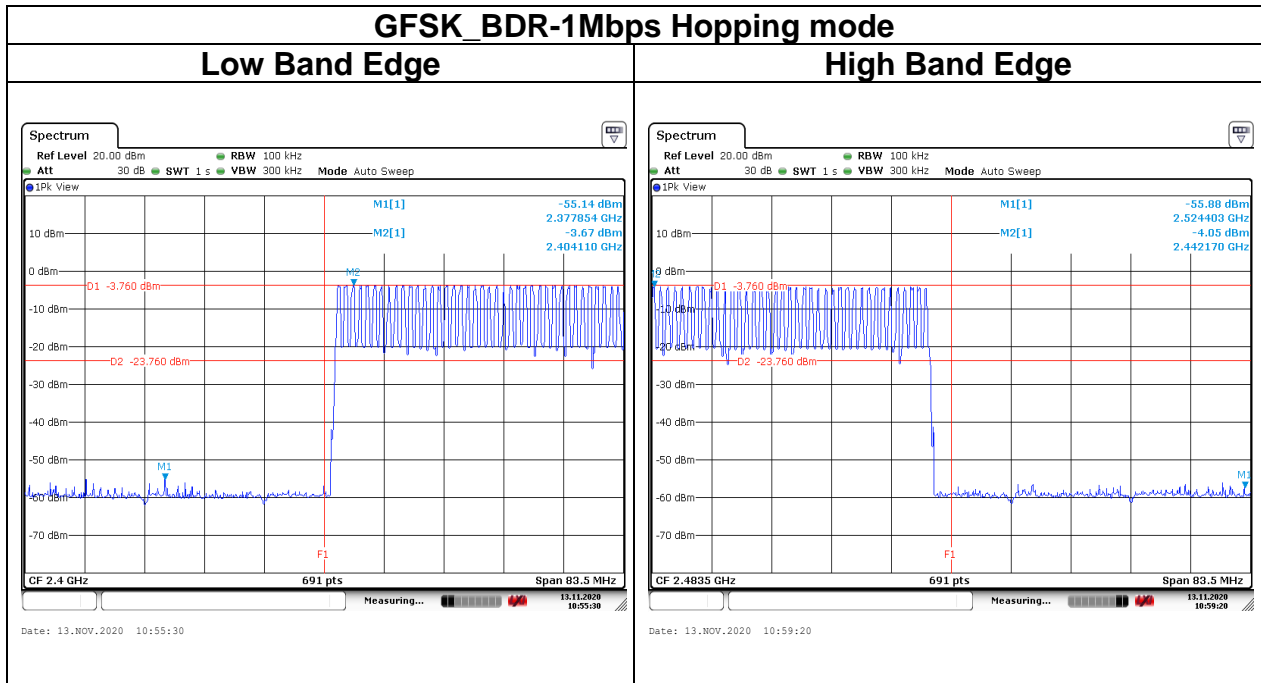
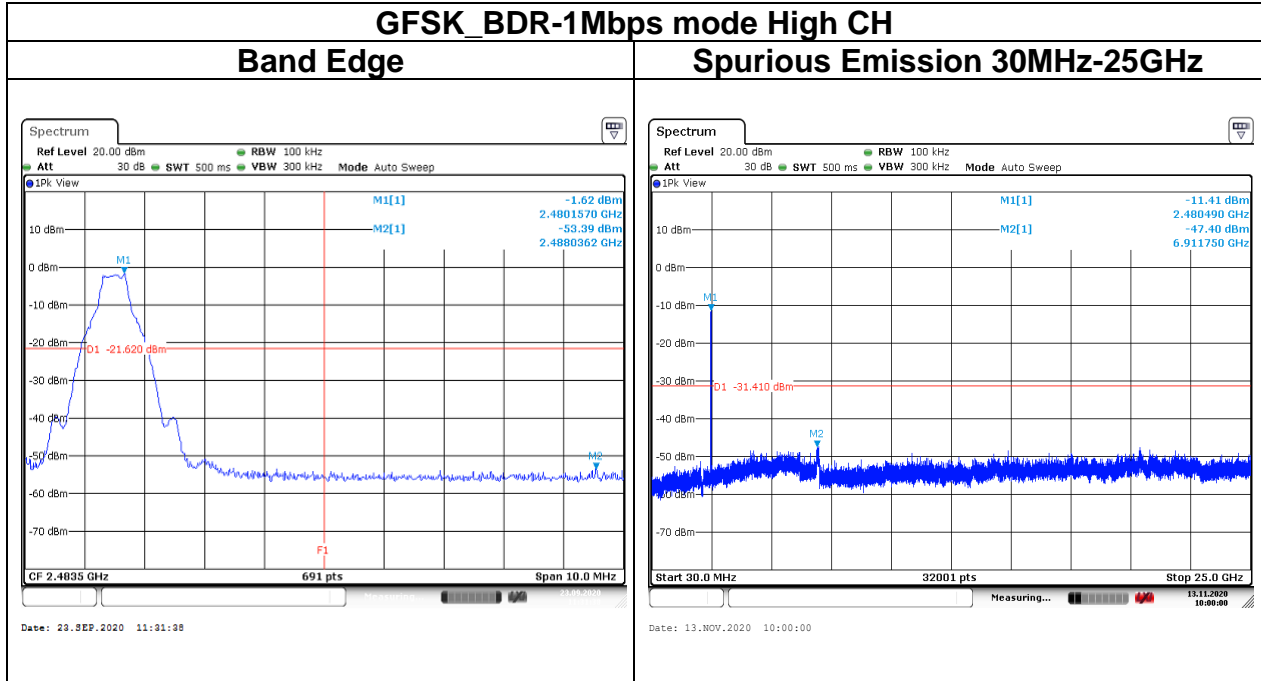



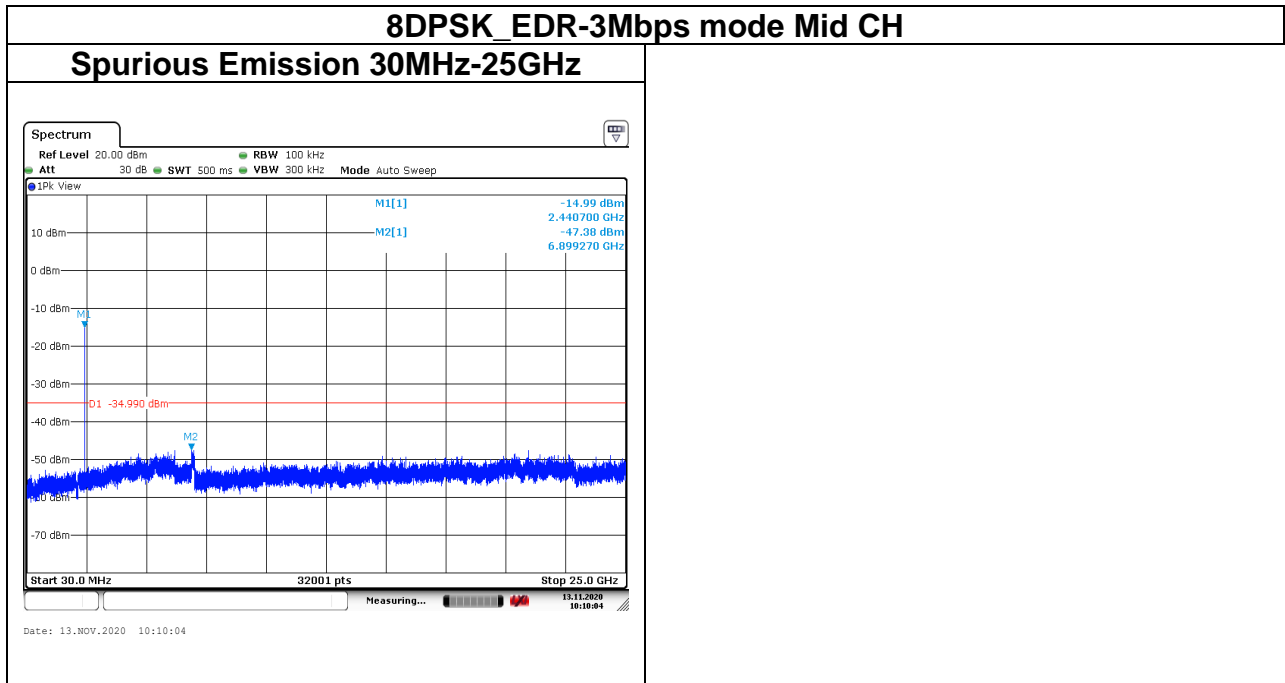
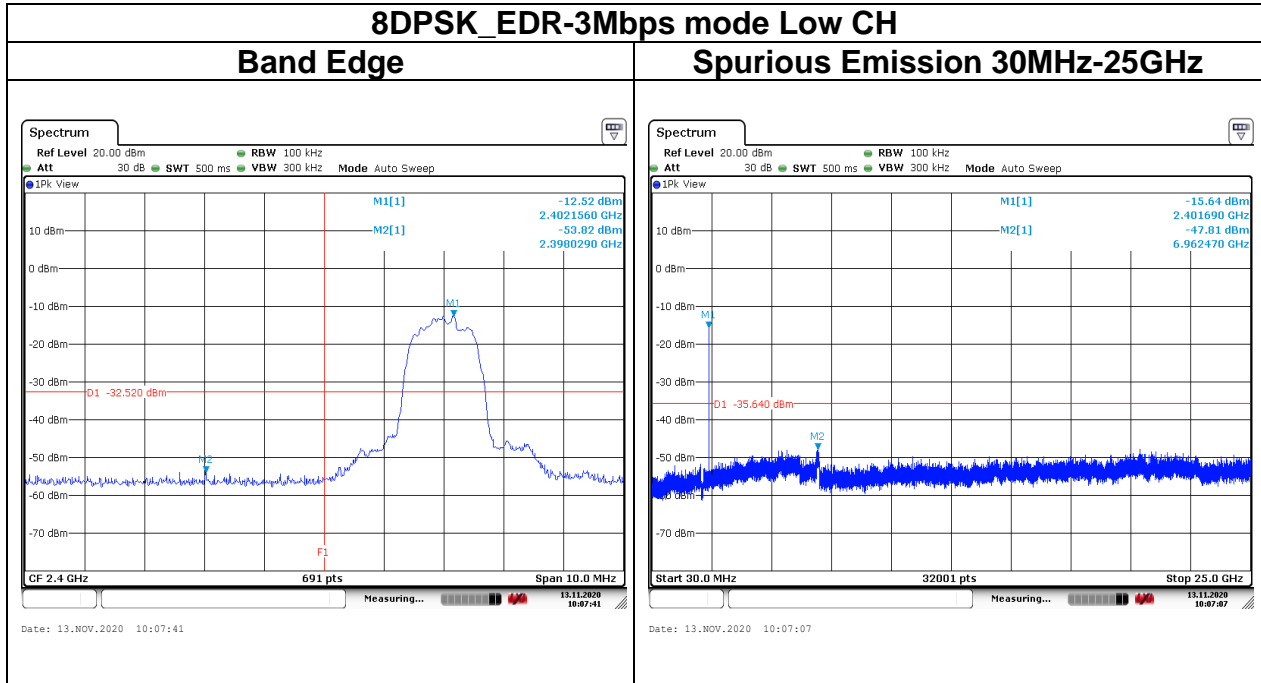

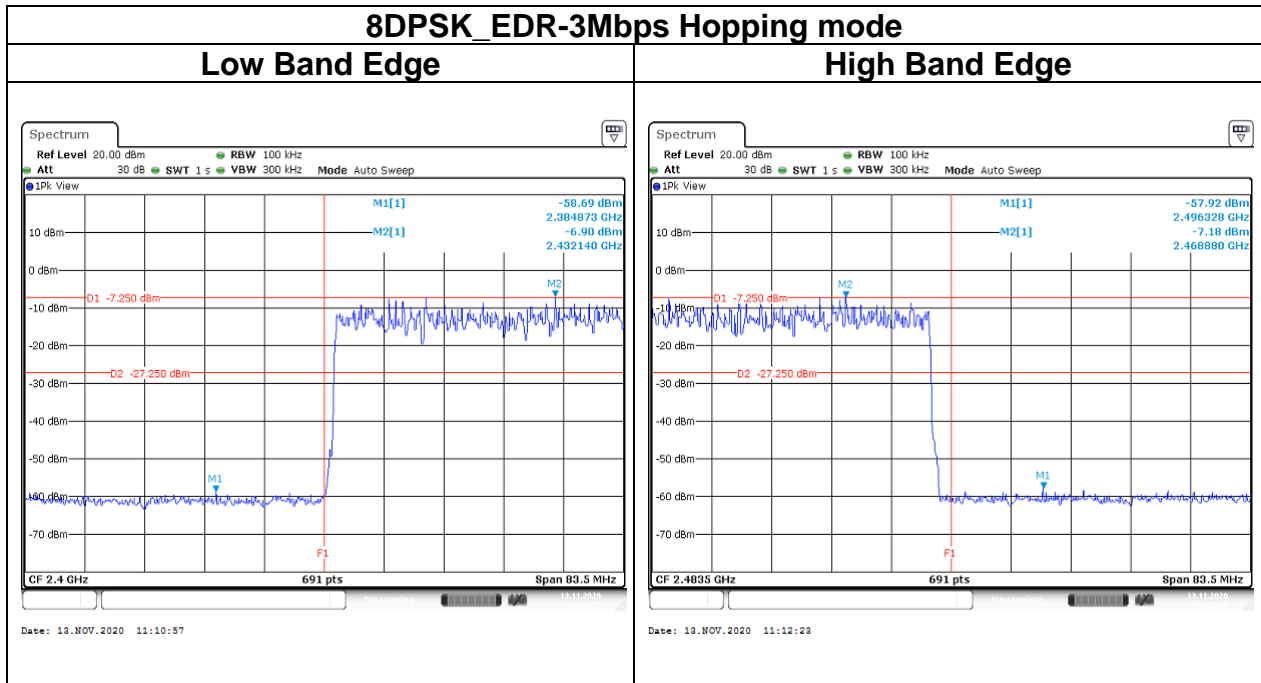
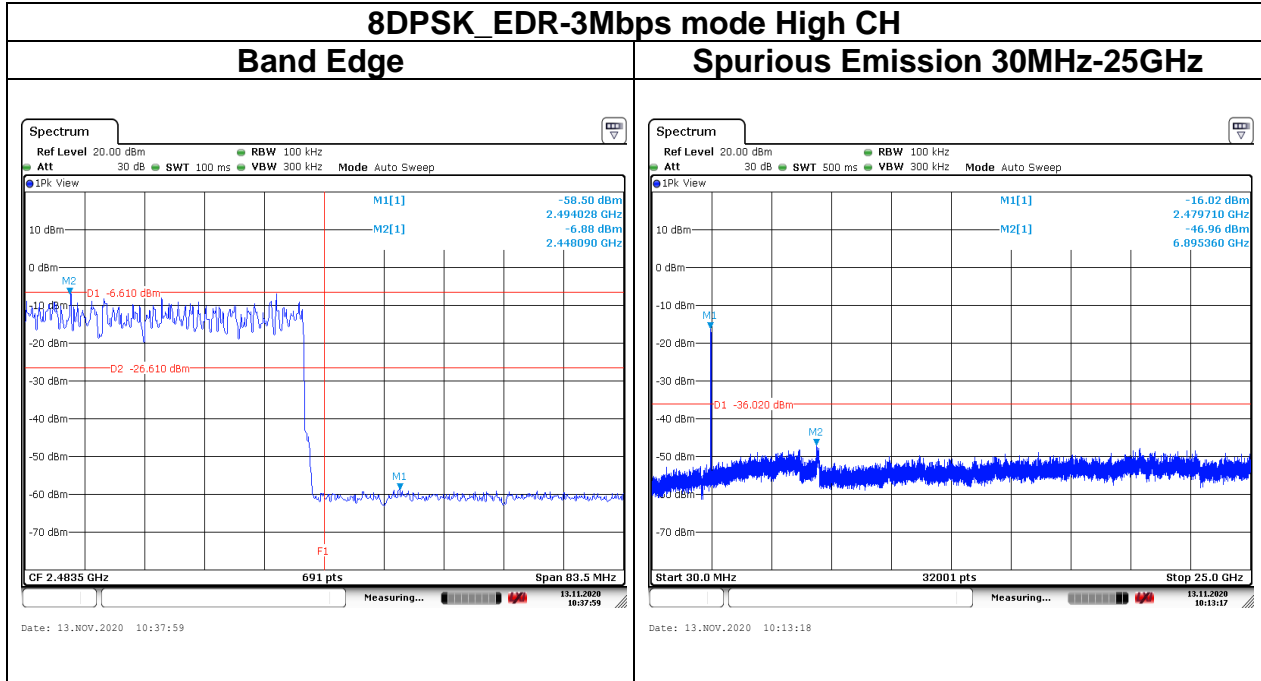

Report No.: T201104D06-RP1

## 4.7 TIME OF OCCUPANCY (DWELL TIME)

### 4.7.1 Test Limit

According to §15.247(a)(1)(iii)

The average time of occupancy on any channel shall not be greater than 0.4 seconds within a period of 0.4 seconds multiplied by the number of hopping channels employed.

### 4.7.2 Test Procedure

1. EUT RF output port connected to the SA by RF cable.
2. Set center frequency of spectrum analyzer = operating frequency.
3. Set the spectrum analyzer as RBW, VBW=1MHz, Sweep = 1 ms

### 4.7.3 Test Setup

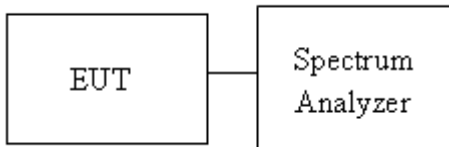

### 4.7.4 Test Result

Time of Occupancy (Dwell Time)							
Mode	Frequency (MHz)	Pulse Time Per Hopping (ms)	Minimum Number of Hopping Freq.	Number of pulse in	Dwell Time IN	Dwell Time Limits (s)	Result
				(0.4 * N sec)	(0.4 * N sec)		
BDR-1Mbps	2441	2.8800	79	106.67	0.3072	0.4	Pass
EDR-3Mbps	2441	2.8800	79	106.67	0.3072	0.4	

Non-AFH: DH5 Packet permit maximum  $1600 / 79 / 6 = 3.37$  hops per second in each channel (5 time slots RX, 1 time slot TX). So, the dwell time is the time duration of the pulse times  $3.37 * 0.4 * 79 = 106.6$

Report No.: T201104D06-RP1

## Test Data

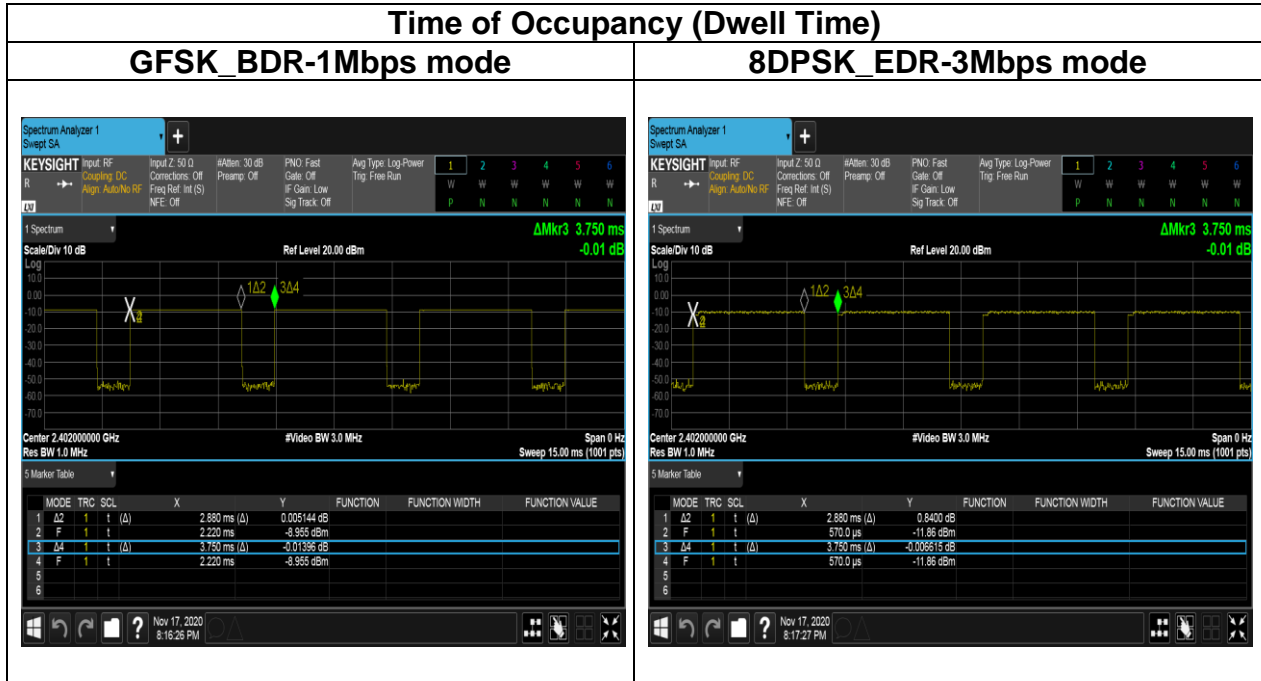

Report No.: T201104D06-RP1

## 4.8 RADIATION BANDEDGE AND SPURIOUS EMISSION

### 4.8.1 Test Limit

FCC according to §15.247(d), §15.209 and §15.205,

In any 100 kHz bandwidth outside the authorized frequency band, all harmonic and spurious must be least 20 dB below the highest emission level with the authorized frequency band. Radiation emission which fall in the restricted bands must also follow the FCC section 15.209 as below limit in table.

#### Below 30 MHz

Frequency	Field Strength (microvolts/m)	Magnetic H-Field (microamperes/m)	Measurement Distance (meters)
9-490 kHz	2,400/F (F in kHz)	2,400/F (F in kHz)	300
490-1,705 kHz	24,000/F (F in kHz)	24,000/F (F in kHz)	30
1.705-30 MHz	30	N/A	30

#### Above 30 MHz

Frequency (MHz)	Field Strength microvolts/m at 3 meters (watts, e.i.r.p.)	
	Transmitters	Receivers
30-88	100 (3 nW)	100 (3 nW)
88-216	150 (6.8 nW)	150 (6.8 nW)
216-960	200 (12 nW)	200 (12 nW)
Above 960	500 (75 nW)	500 (75 nW)

Remark:

Although these tests were performed other than open area test site, adequate comparison measurements were confirmed against 30 m open are test site. Therefore sufficient tests were made to demonstrate that the alternative site produces results that correlate with the ones of tests made in an open field based on KDB 414788.

Report No.: T201104D06-RP1

## 4.8.2 Test Procedure

1. The EUT is placed on a turntable, Above 1 GHz is 1.5m and below 1 GHz is 0.8m above ground plane. The EUT Configured un accordance with ANSI C63.10: 2013, and the EUT set in a continuous mode.

2. The turntable shall be rotated for 360 degrees to determine the position of maximum emission level. And EUT is set 3m away from the receiving antenna, which is scanned from 1m to 4m above the ground plane to find out the highest emissions. Measurement are made polarized in both the vertical and the horizontal positions with antenna.

3. Span shall wide enough to full capture the emission measured. The SA from 9kHz to 26.5GHz set to the low, Mid and High channels with the EUT transmit.

Note: No emission found between lowest internal used/generated frequency to 30MHz(9KHz~30MHz)

4. For harmonic, the worst case of output power was BDR-1Mbps. Therefore only BDR-1Mbps record in the report.

5. The SA setting following :

(1) Below 1G : RBW = 100kHz, VBW  $\geq$  3 RBW, Sweep = Auto, Detector = Peak, Trace = Max hold.

(2) Above 1G :

(2.1) For Peak measurement : RBW = 1MHz, VBW  $\geq$  3 RBW, Sweep = Auto, Detector = Peak, Trace = Max hold.

(2.2) For Average measurement : RBW = 1MHz, VBW

·If Duty Cycle  $\geq$  98%, VBW=10Hz.

·If Duty Cycle < 98%, VBW $\geq$ 1/T.

Report No.: T201104D06-RP1

## 4.8.3 Test Setup

### 9kHz ~ 30MHz

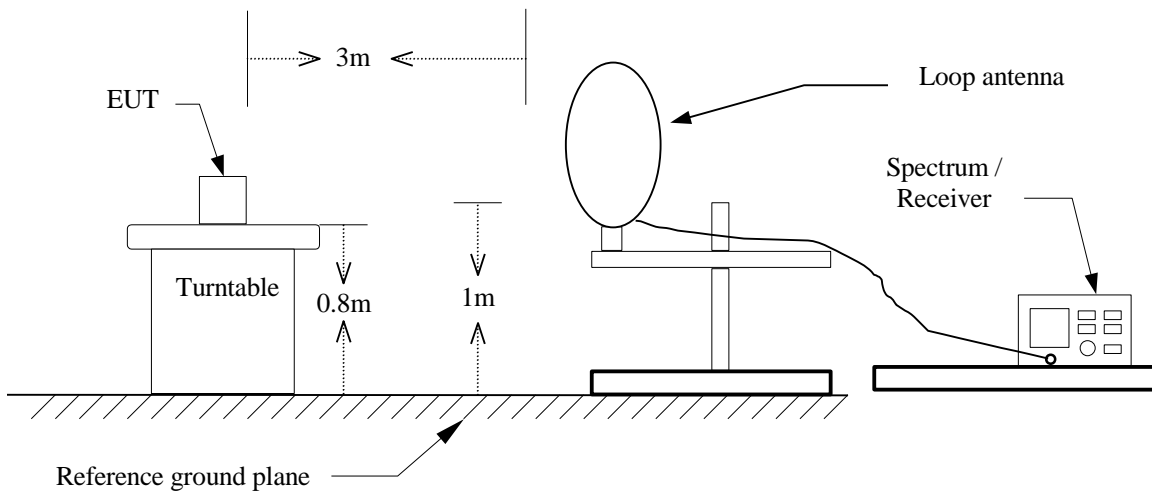

### 30MHz ~ 1GHz

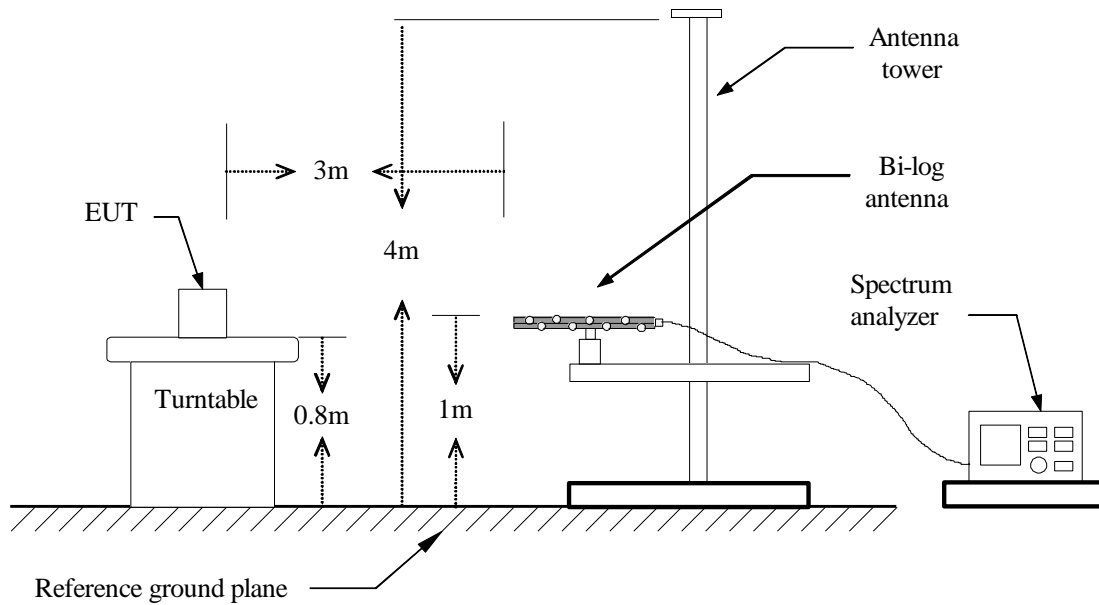

## Above 1 GHz

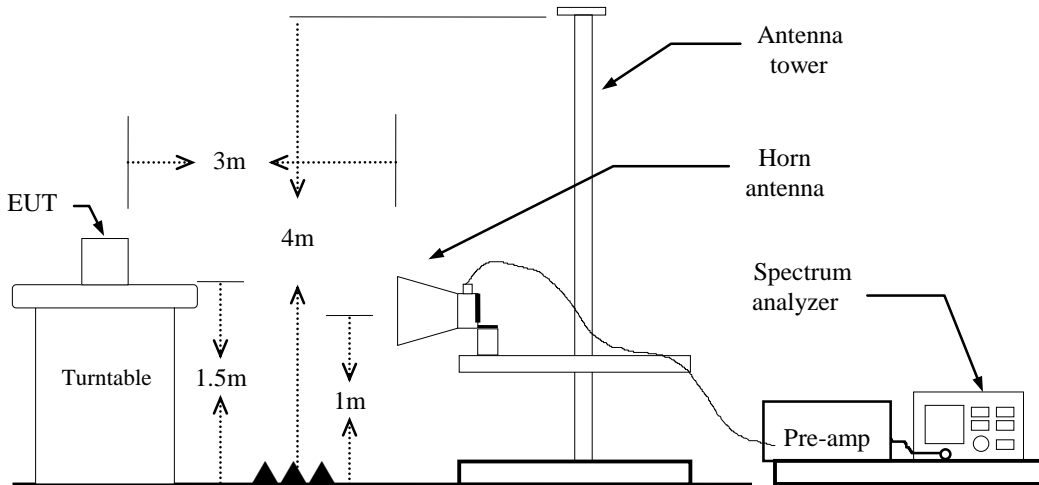



Report No.: T201104D06-RP1

## 4.8.4 Test Result

### Band Edge Test Data

Test Mode:	GFSK_BDR-1Mbps Low CH	Temp/Hum	22.4(°C)/ 55%RH
Test Item	Band Edge	Test Date	November 9, 2020
Polarize	Vertical	Test Engineer	Ray.Li
Detector	Peak / Average		

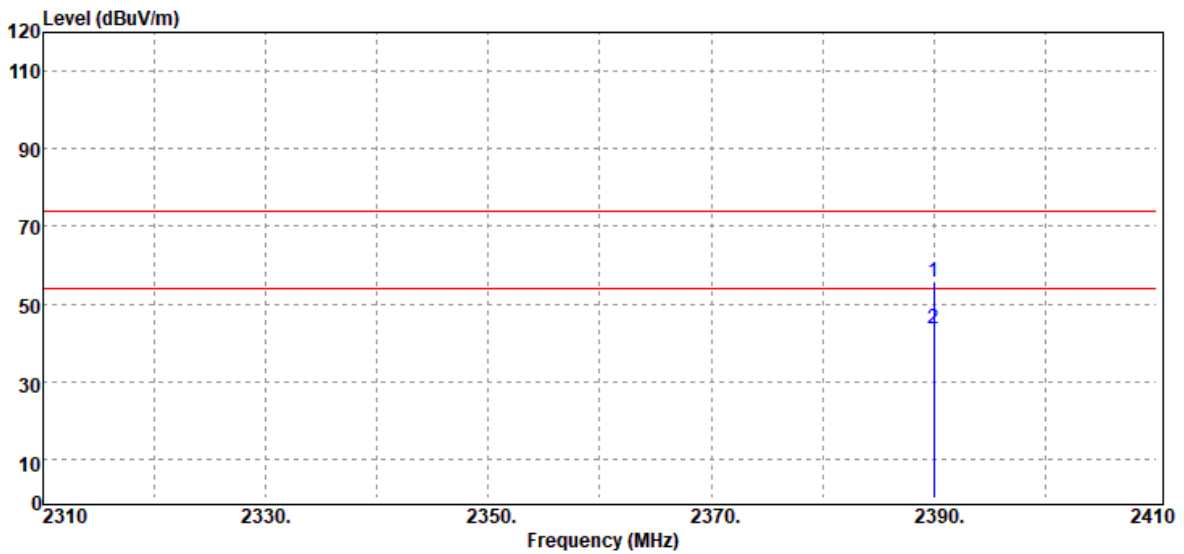

Freq. MHz	Detector Mode PK/QP/AV	Spectrum Reading Level dB $\mu$ V	Factor dB	Actual FS dB $\mu$ V/m	Limit @3m dB $\mu$ V/m	Margin dB
2390.00	Peak	72.64	-17.18	55.46	74.00	-18.54
2390.00	Average	60.80	-17.18	43.62	54.00	-10.38

Report No.: T201104D06-RP1

Test Mode:	GFSK_BDR-1Mbps Low CH	Temp/Hum	22.4(°C)/ 55%RH
Test Item	Band Edge	Test Date	November 9, 2020
Polarize	Horizontal	Test Engineer	Ray.Li
Detector	Peak / Average		

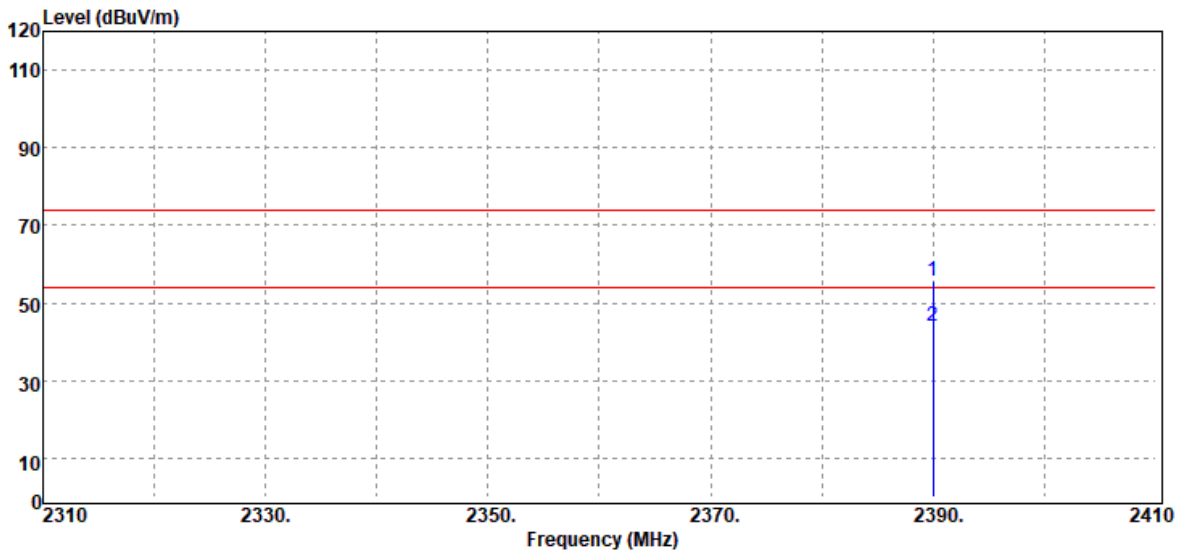

Freq. MHz	Detector Mode PK/QP/AV	Spectrum Reading Level dB $\mu$ V	Factor dB	Actual FS dB $\mu$ V/m	Limit @3m dB $\mu$ V/m	Margin dB
2390.00	Peak	72.93	-17.18	55.75	74.00	-18.25
2390.00	Average	61.14	-17.18	43.96	54.00	-10.04

Report No.: T201104D06-RP1

Test Mode:	GFSK_BDR-1Mbps High CH	Temp/Hum	22.4(°C)/ 55%RH
Test Item	Band Edge	Test Date	November 9, 2020
Polarize	Vertical	Test Engineer	Ray.Li
Detector	Peak / Average		

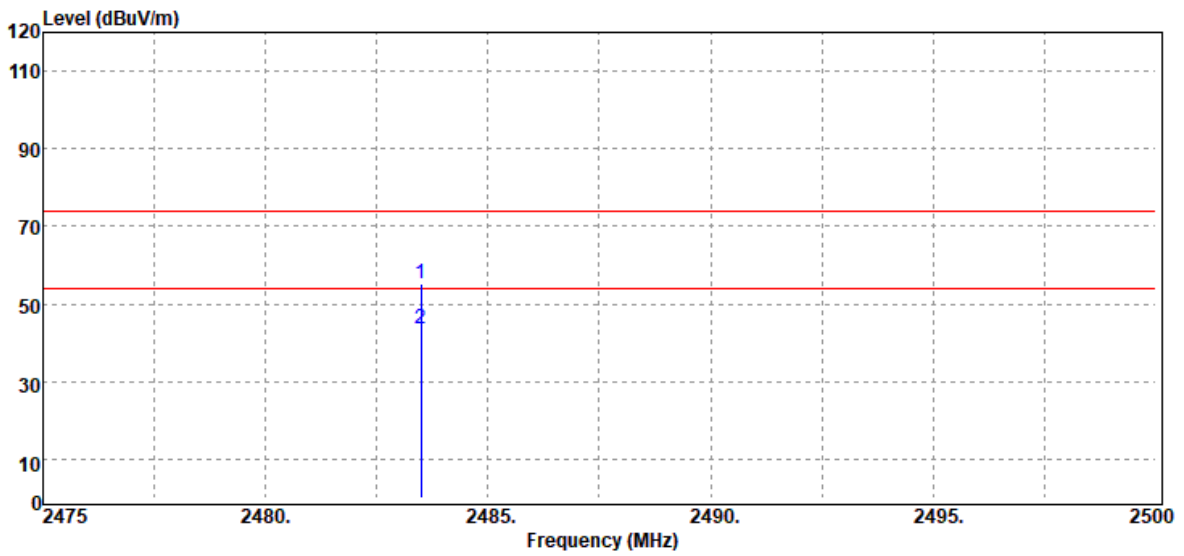

Freq. MHz	Detector Mode PK/QP/AV	Spectrum Reading Level dB $\mu$ V	Factor dB	Actual FS dB $\mu$ V/m	Limit @3m dB $\mu$ V/m	Margin dB
2483.50	Peak	72.34	-16.98	55.36	74.00	-18.64
2483.50	Average	60.50	-16.98	43.52	54.00	-10.48

Report No.: T201104D06-RP1

Test Mode:	GFSK_BDR-1Mbps High CH	Temp/Hum	22.4(°C)/ 55%RH
Test Item	Band Edge	Test Date	November 9, 2020
Polarize	Horizontal	Test Engineer	Ray.Li
Detector	Peak / Average		

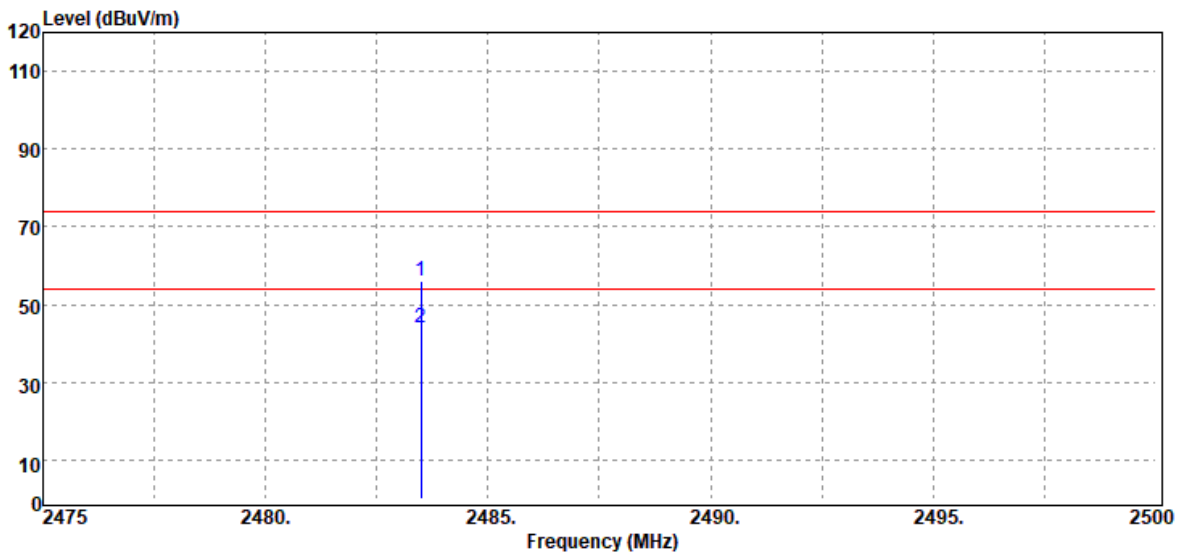

Freq. MHz	Detector Mode PK/QP/AV	Spectrum Reading Level dB $\mu$ V	Factor dB	Actual FS dB $\mu$ V/m	Limit @3m dB $\mu$ V/m	Margin dB
2483.50	Peak	72.84	-16.98	55.86	74.00	-18.14
2483.50	Average	61.00	-16.98	44.02	54.00	-9.98

Report No.: T201104D06-RP1

Test Mode:	GFSK_BDR-1Mbps Low CH Hopping	Temp/Hum	22.6(°C)/ 68%RH
Test Item	Band Edge	Test Date	November 20, 2020
Polarize	Vertical	Test Engineer	Ray.Li
Detector	Peak / Average		

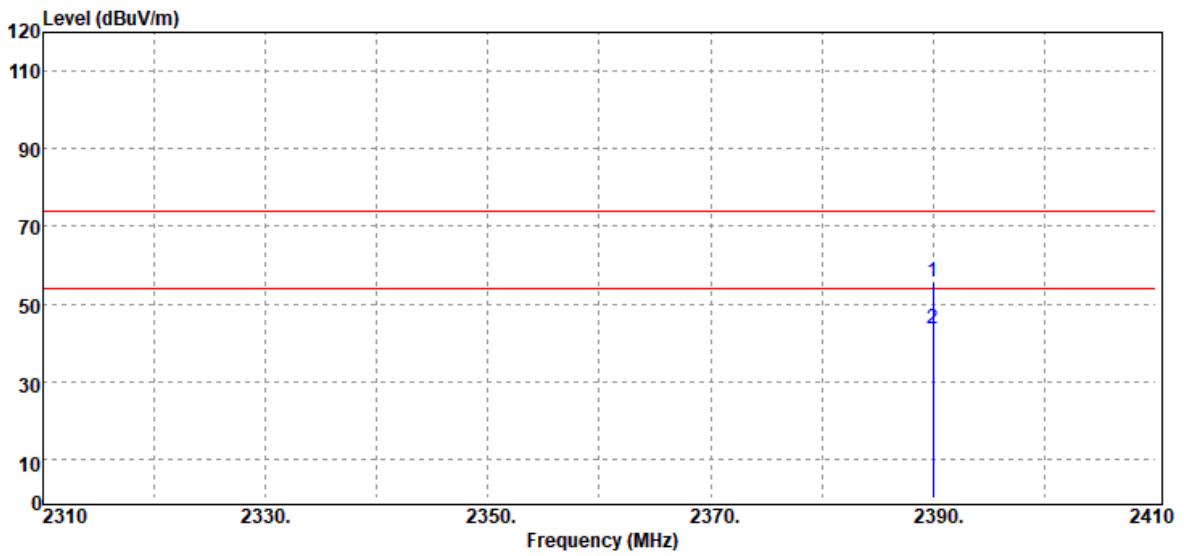

Freq. MHz	Detector Mode PK/QP/AV	Spectrum Reading Level dB $\mu$ V	Factor dB	Actual FS dB $\mu$ V/m	Limit @3m dB $\mu$ V/m	Margin dB
2390.00	Peak	72.81	-17.18	55.63	74.00	-18.37
2390.00	Average	60.86	-17.18	43.68	54.00	-10.32

Report No.: T201104D06-RP1

Test Mode:	GFSK_BDR-1Mbps Low CH Hopping	Temp/Hum	22.6(°C)/ 68%RH
Test Item	Band Edge	Test Date	November 20, 2020
Polarize	Horizontal	Test Engineer	Ray.Li
Detector	Peak / Average		

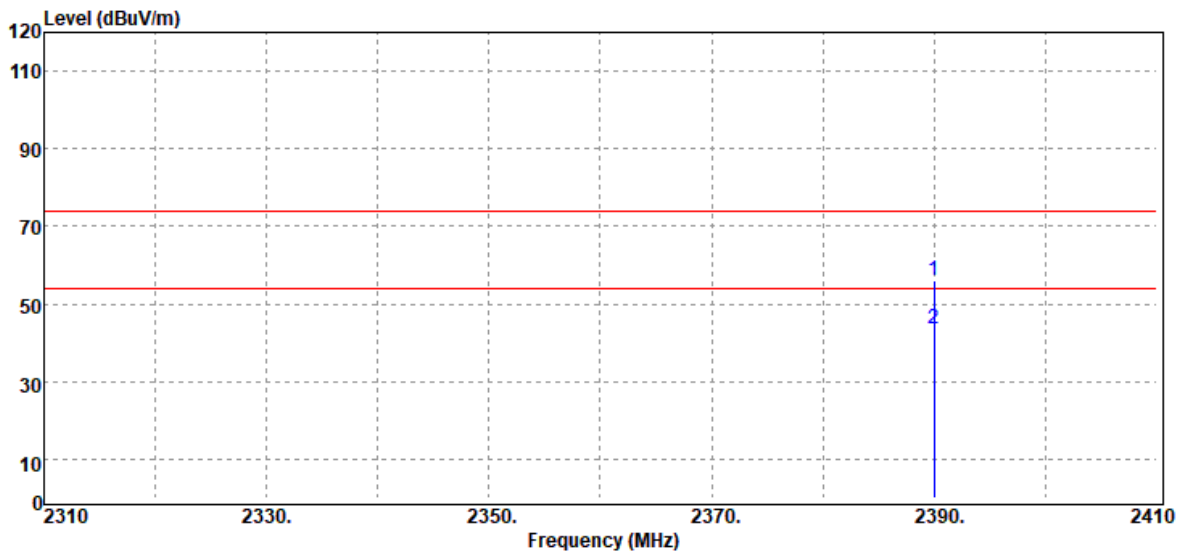

Freq. MHz	Detector Mode PK/QP/AV	Spectrum Reading Level dB $\mu$ V	Factor dB	Actual FS dB $\mu$ V/m	Limit @3m dB $\mu$ V/m	Margin dB
2390.00	Peak	73.21	-17.18	56.03	74.00	-17.97
2390.00	Average	60.96	-17.18	43.78	54.00	-10.22

Report No.: T201104D06-RP1

Test Mode:	GFSK_BDR-1Mbps High CH Hopping	Temp/Hum	22.6(°C)/ 68%RH
Test Item	Band Edge	Test Date	November 20, 2020
Polarize	Vertical	Test Engineer	Ray.Li
Detector	Peak / Average		

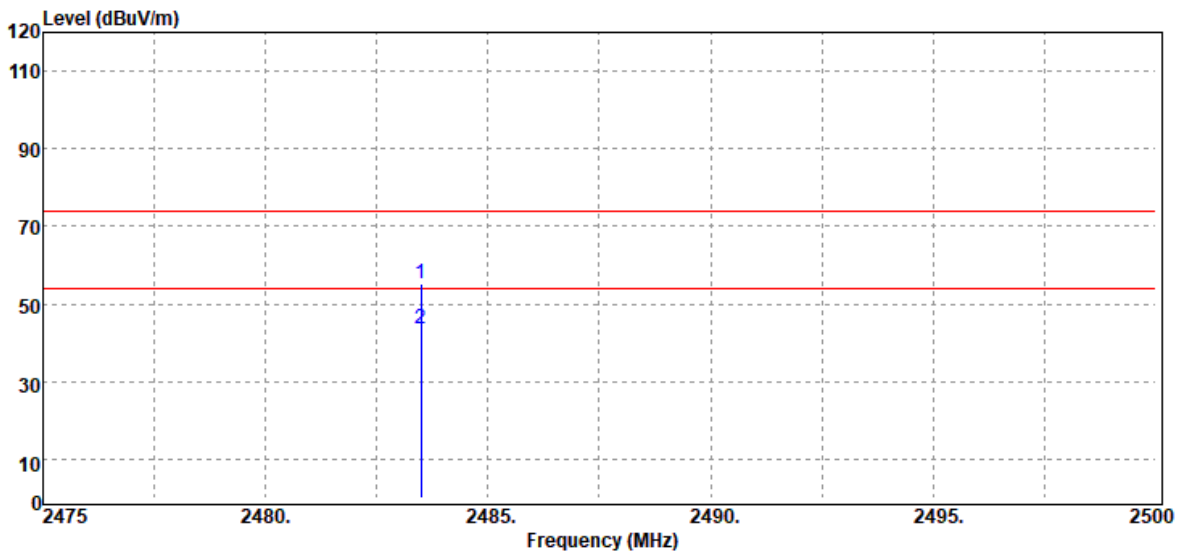

Freq. MHz	Detector Mode PK/QP/AV	Spectrum Reading Level dB $\mu$ V	Factor dB	Actual FS dB $\mu$ V/m	Limit @3m dB $\mu$ V/m	Margin dB
2483.50	Peak	72.25	-16.98	55.27	74.00	-18.73
2483.50	Average	60.57	-16.98	43.59	54.00	-10.41

Report No.: T201104D06-RP1

Test Mode:	GFSK_BDR-1Mbps High CH Hopping	Temp/Hum	22.6(°C)/ 68%RH
Test Item	Band Edge	Test Date	November 20, 2020
Polarize	Horizontal	Test Engineer	Ray.Li
Detector	Peak / Average		

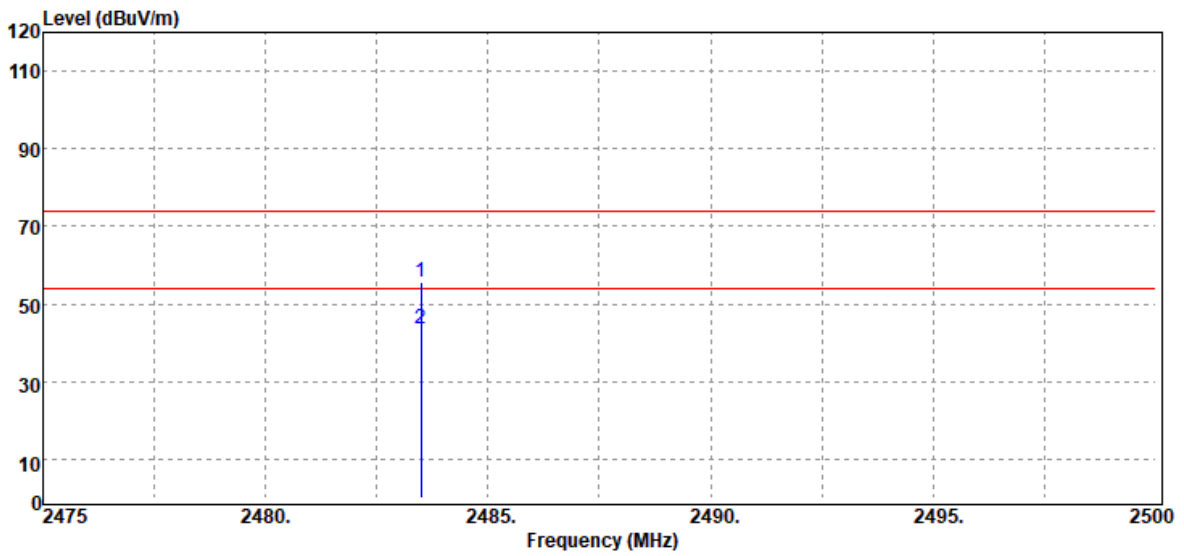

Freq. MHz	Detector Mode PK/QP/AV	Spectrum Reading Level dB $\mu$ V	Factor dB	Actual FS dB $\mu$ V/m	Limit @3m dB $\mu$ V/m	Margin dB
2483.50	Peak	72.44	-16.98	55.46	74.00	-18.54
2483.50	Average	60.73	-16.98	43.75	54.00	-10.25



Report No.: T201104D06-RP1

Test Mode:	8DPSK_EDR-3Mbps Low CH	Temp/Hum	22.4(°C)/ 55%RH
Test Item	Band Edge	Test Date	November 9, 2020
Polarize	Vertical	Test Engineer	Ray.Li
Detector	Peak / Average		

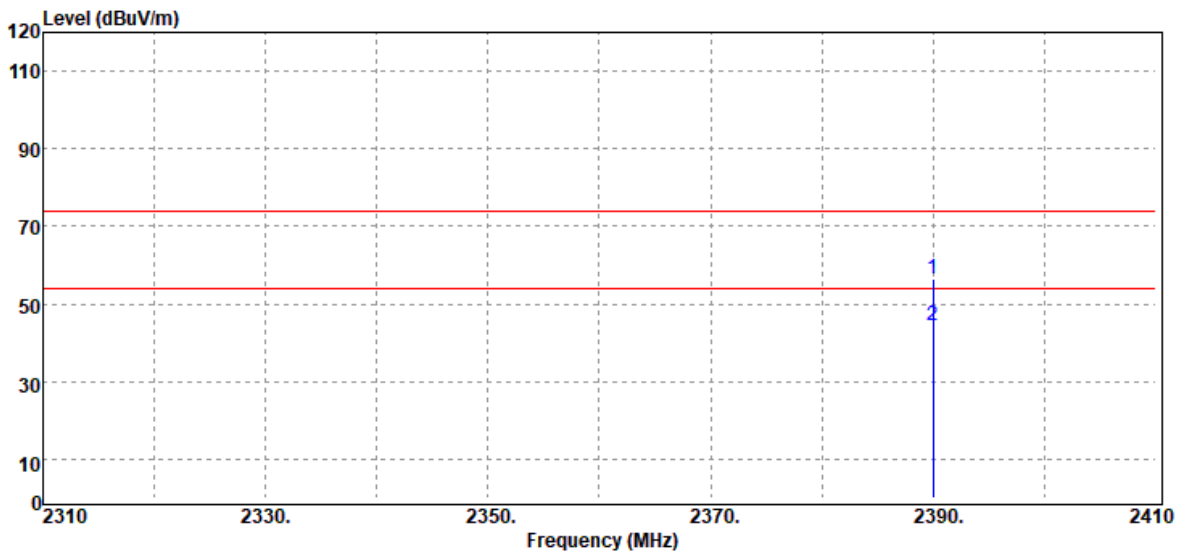

Freq. MHz	Detector Mode PK/QP/AV	Spectrum Reading Level dB $\mu$ V	Factor dB	Actual FS dB $\mu$ V/m	Limit @3m dB $\mu$ V/m	Margin dB
2390.00	Peak	73.54	-17.18	56.36	74.00	-17.64
2390.00	Average	61.70	-17.18	44.52	54.00	-9.48

Report No.: T201104D06-RP1

Test Mode:	8DPSK_EDR-3Mbps Low CH	Temp/Hum	22.4(°C)/ 55%RH
Test Item	Band Edge	Test Date	November 9, 2020
Polarize	Horizontal	Test Engineer	Ray.Li
Detector	Peak / Average		

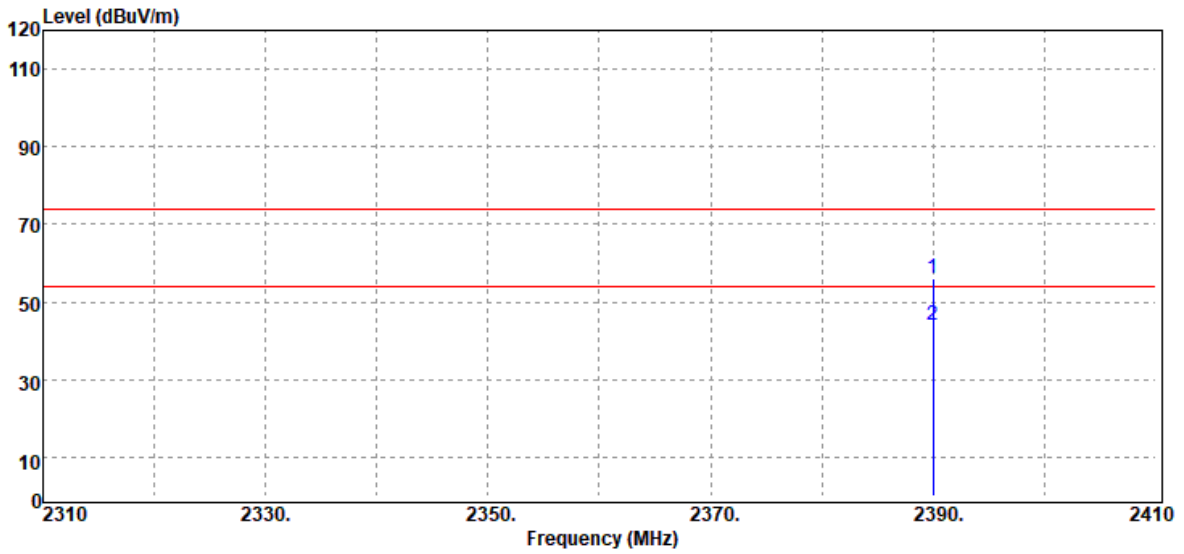

Freq. MHz	Detector Mode PK/QP/AV	Spectrum Reading Level dBµV	Factor dB	Actual FS dBµV/m	Limit @3m dBµV/m	Margin dB
2390.00	Peak	73.21	-17.18	56.03	74.00	-17.97
2390.00	Average	61.40	-17.18	44.22	54.00	-9.78

Report No.: T201104D06-RP1

Test Mode:	8DPSK_EDR-3Mbps High CH	Temp/Hum	22.4(°C)/ 55%RH
Test Item	Band Edge	Test Date	November 9, 2020
Polarize	Vertical	Test Engineer	Ray.Li
Detector	Peak / Average		

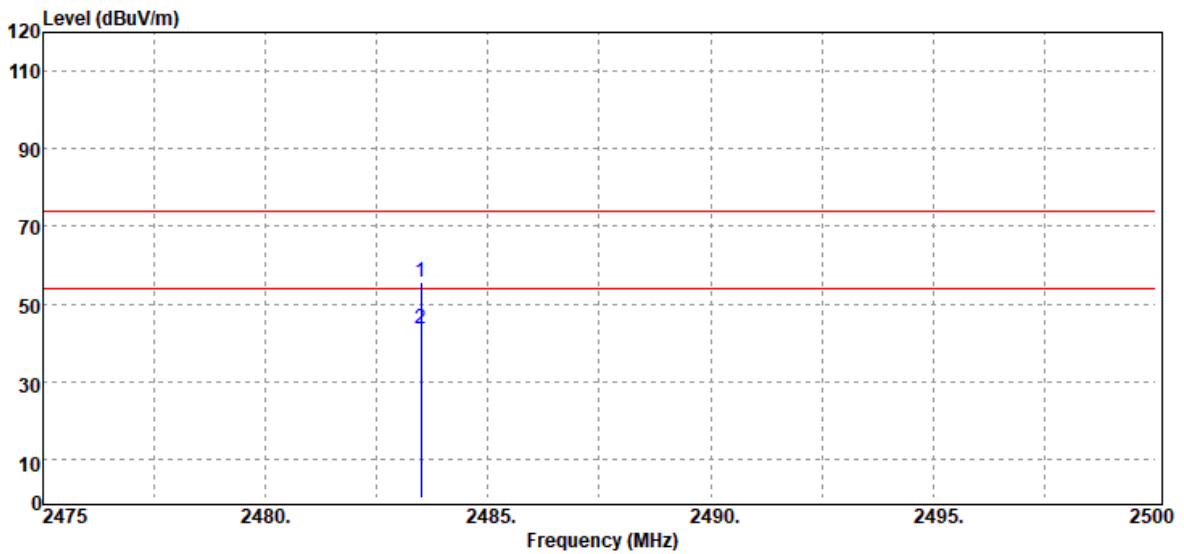

Freq. MHz	Detector Mode PK/QP/AV	Spectrum Reading Level dB $\mu$ V	Factor dB	Actual FS dB $\mu$ V/m	Limit @3m dB $\mu$ V/m	Margin dB
2483.50	Peak	72.56	-16.98	55.58	74.00	-18.42
2483.50	Average	60.70	-16.98	43.72	54.00	-10.28

Report No.: T201104D06-RP1

Test Mode:	8DPSK_EDR-3Mbps High CH	Temp/Hum	22.4(°C)/ 55%RH
Test Item	Band Edge	Test Date	November 9, 2020
Polarize	Horizontal	Test Engineer	Ray.Li
Detector	Peak / Average		

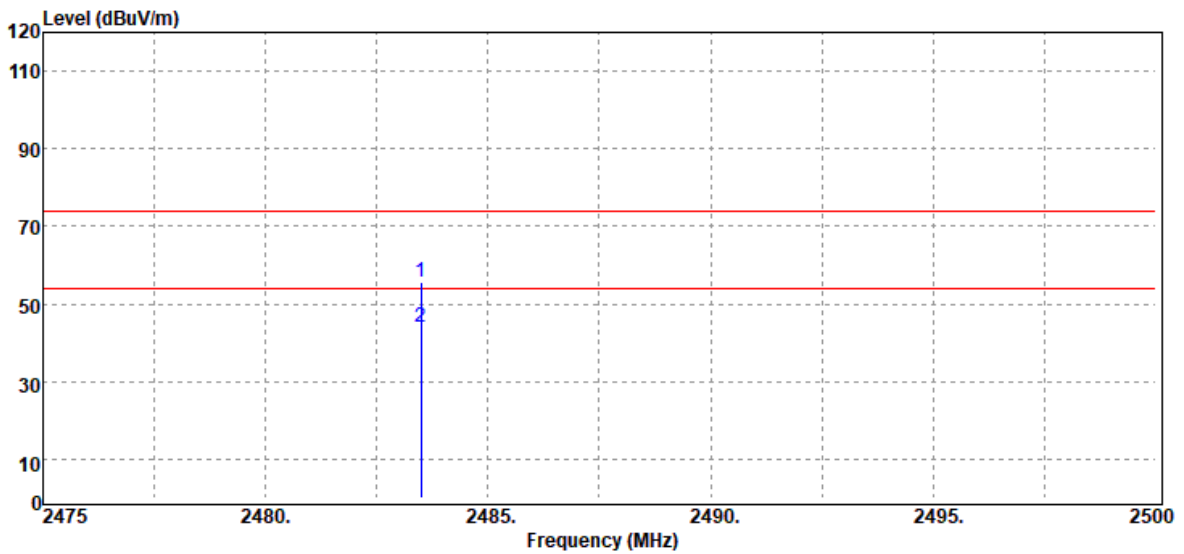

Freq. MHz	Detector Mode PK/QP/AV	Spectrum Reading Level dB $\mu$ V	Factor dB	Actual FS dB $\mu$ V/m	Limit @3m dB $\mu$ V/m	Margin dB
2483.50	Peak	72.72	-16.98	55.74	74.00	-18.26
2483.50	Average	60.90	-16.98	43.92	54.00	-10.08

Report No.: T201104D06-RP1

Test Mode:	8DPSK_EDR-3Mbps Low CH Hopping	Temp/Hum	22.6(°C)/ 68%RH
Test Item	Band Edge	Test Date	November 20, 2020
Polarize	Vertical	Test Engineer	Ray.Li
Detector	Peak / Average		

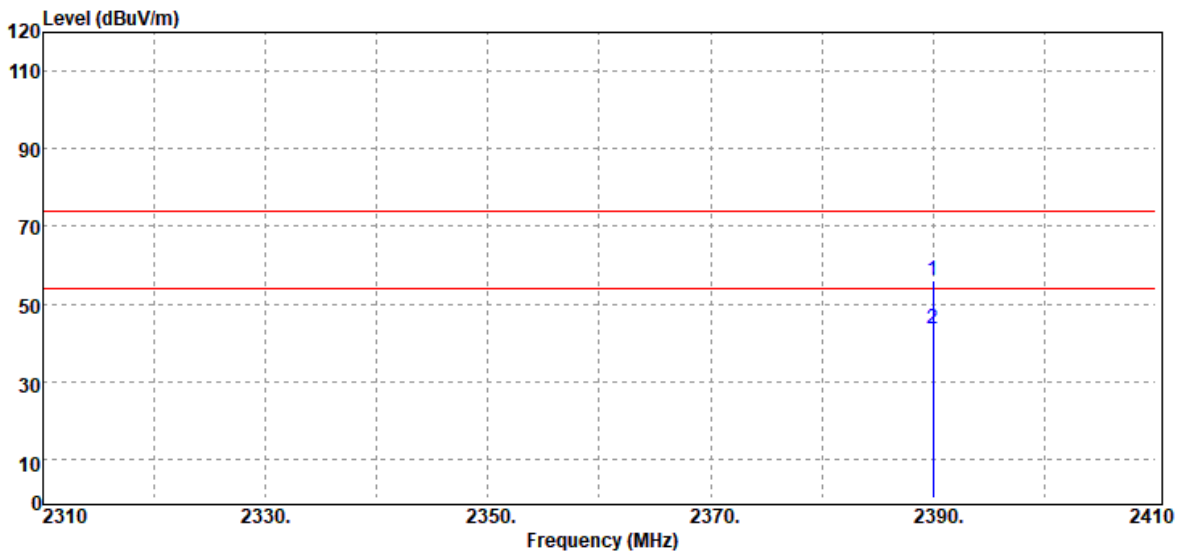

Freq. MHz	Detector Mode PK/QP/AV	Spectrum Reading Level dB $\mu$ V	Factor dB	Actual FS dB $\mu$ V/m	Limit @3m dB $\mu$ V/m	Margin dB
2390.00	Peak	73.12	-17.18	55.94	74.00	-18.06
2390.00	Average	60.71	-17.18	43.53	54.00	-10.47

Report No.: T201104D06-RP1

Test Mode:	8DPSK_EDR-3Mbps Low CH Hopping	Temp/Hum	22.6(°C)/ 68%RH
Test Item	Band Edge	Test Date	November 20, 2020
Polarize	Horizontal	Test Engineer	Ray.Li
Detector	Peak / Average		

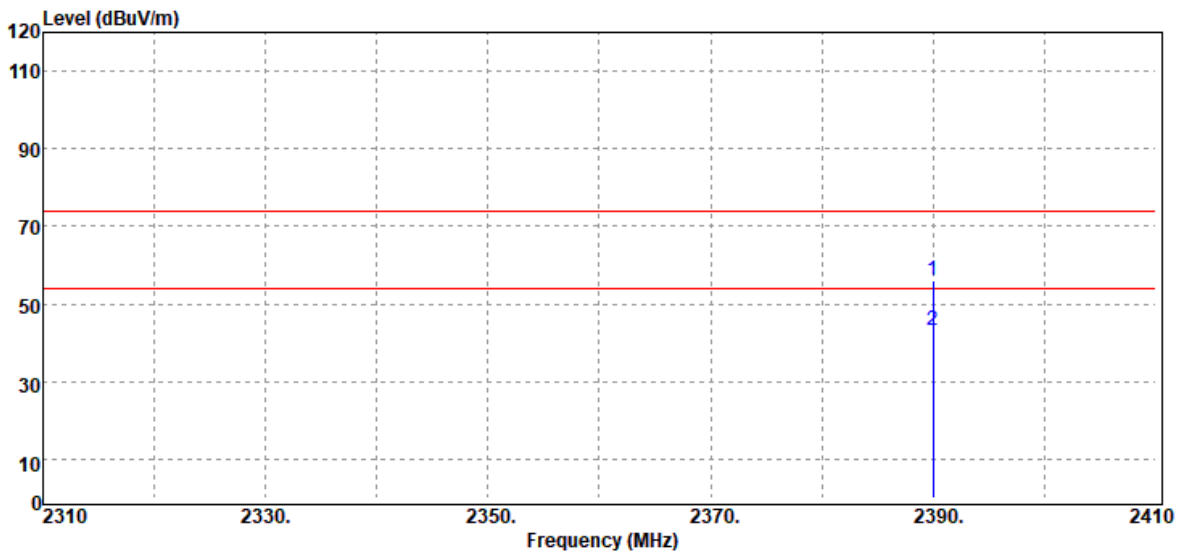

Freq. MHz	Detector Mode PK/QP/AV	Spectrum Reading Level dBuV	Factor dB	Actual FS dBuV/m	Limit @3m dBuV/m	Margin dB
2390.00	Peak	73.27	-17.18	56.09	74.00	-17.91
2390.00	Average	60.39	-17.18	43.21	54.00	-10.79

Report No.: T201104D06-RP1

Test Mode:	8DPSK_EDR-3Mbps High CH Hopping	Temp/Hum	22.6(°C)/ 68%RH
Test Item	Band Edge	Test Date	November 20, 2020
Polarize	Vertical	Test Engineer	Ray.Li
Detector	Peak / Average		

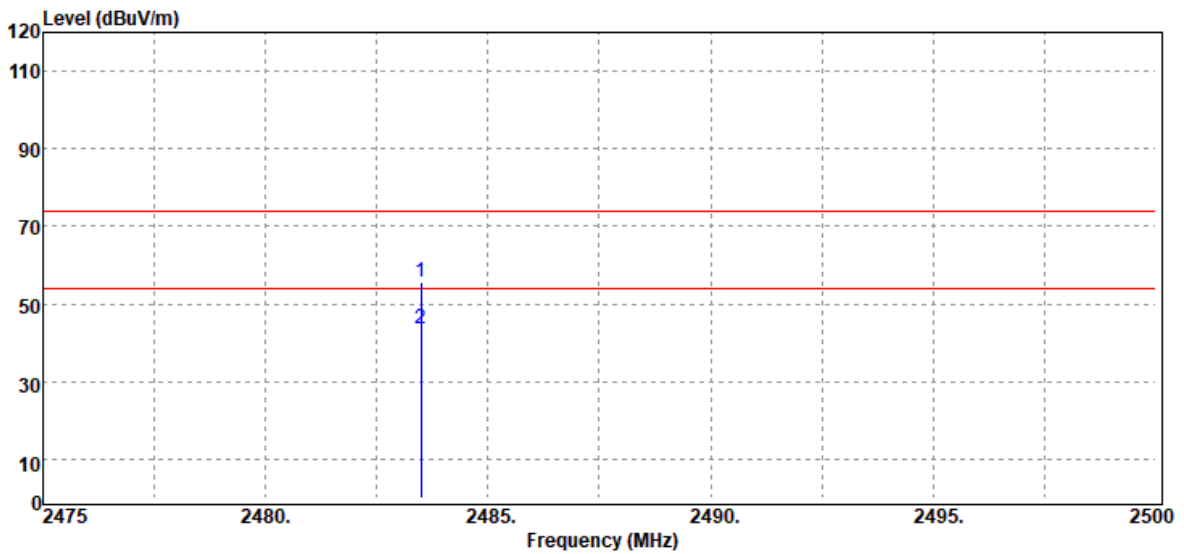

Freq. MHz	Detector Mode PK/QP/AV	Spectrum Reading Level dB $\mu$ V	Factor dB	Actual FS dB $\mu$ V/m	Limit @3m dB $\mu$ V/m	Margin dB
2483.50	Peak	72.57	-16.98	55.59	74.00	-18.41
2483.50	Average	60.57	-16.98	43.59	54.00	-10.41

Report No.: T201104D06-RP1

Test Mode:	8DPSK_EDR-3Mbps High CH Hopping	Temp/Hum	22.6(°C)/ 68%RH
Test Item	Band Edge	Test Date	November 20, 2020
Polarize	Horizontal	Test Engineer	Ray.Li
Detector	Peak / Average		

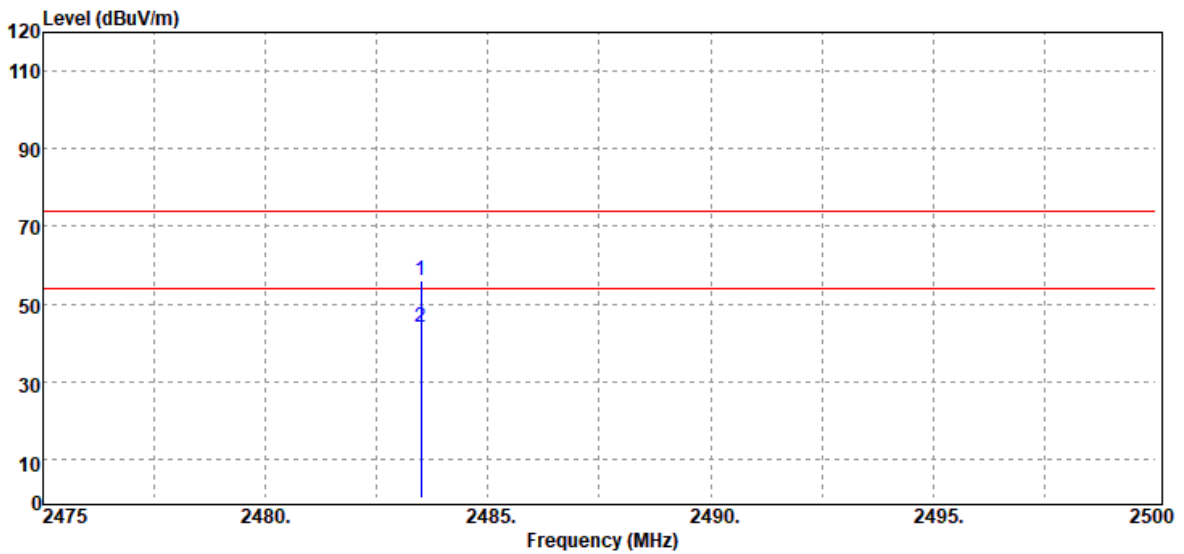

Freq. MHz	Detector Mode PK/QP/AV	Spectrum Reading Level dB $\mu$ V	Factor dB	Actual FS dB $\mu$ V/m	Limit @3m dB $\mu$ V/m	Margin dB
2483.50	Peak	73.03	-16.98	56.05	74.00	-17.95
2483.50	Average	60.87	-16.98	43.89	54.00	-10.11



Report No.: T201104D06-RP1

**Below 1G Test Data**

Test Mode:	BT Mode	Temp/Hum	22.6(°C)/ 59%RH
Test Item	30MHz-1GHz	Test Date	November 11, 2020
Polarize	Vertical	Test Engineer	Jerry Chang
Detector	Peak		

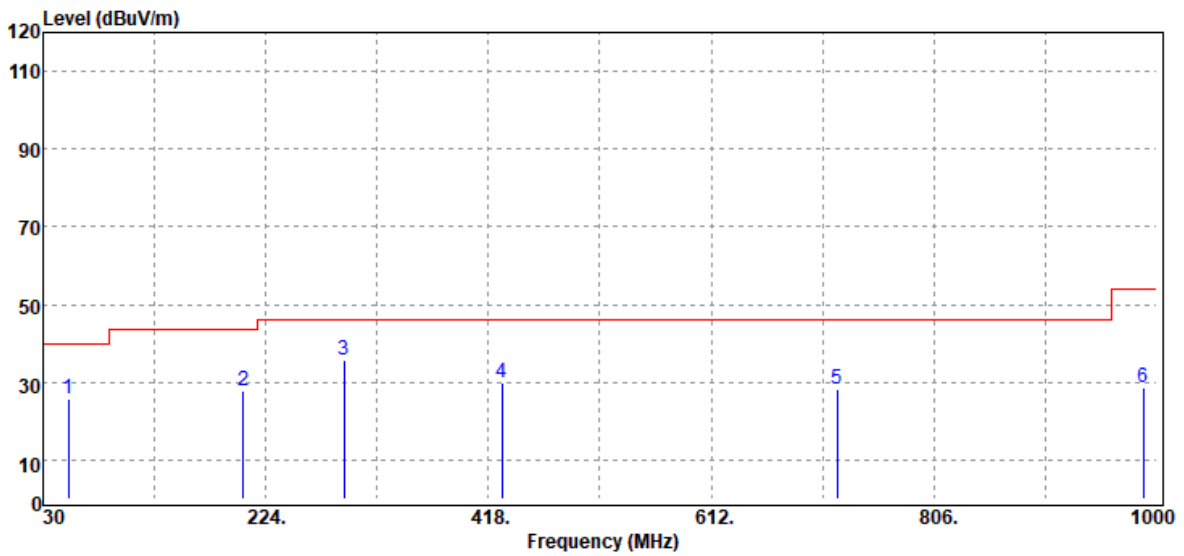

Freq. MHz	Detector Mode PK/QP/AV	Spectrum Reading Level dBμV	Factor dB	Actual FS dBμV/m	Limit @3m dBμV/m	Margin dB
52.31	Peak	-488.81	514.40	25.59	40.00	-14.41
204.60	Peak	-490.95	518.75	27.80	43.50	-15.70
291.90	Peak	-485.49	521.39	35.90	46.00	-10.10
429.64	Peak	-495.23	525.08	29.85	46.00	-16.15
721.61	Peak	-501.47	529.89	28.42	46.00	-17.58
988.36	Peak	-504.23	533.03	28.80	54.00	-25.20

Report No.: T201104D06-RP1

Test Mode:	BT Mode	Temp/Hum	22.6(°C)/ 59%RH
Test Item	30MHz-1GHz	Test Date	November 11, 2020
Polarize	Horizontal	Test Engineer	Jerry Chang
Detector	Peak		

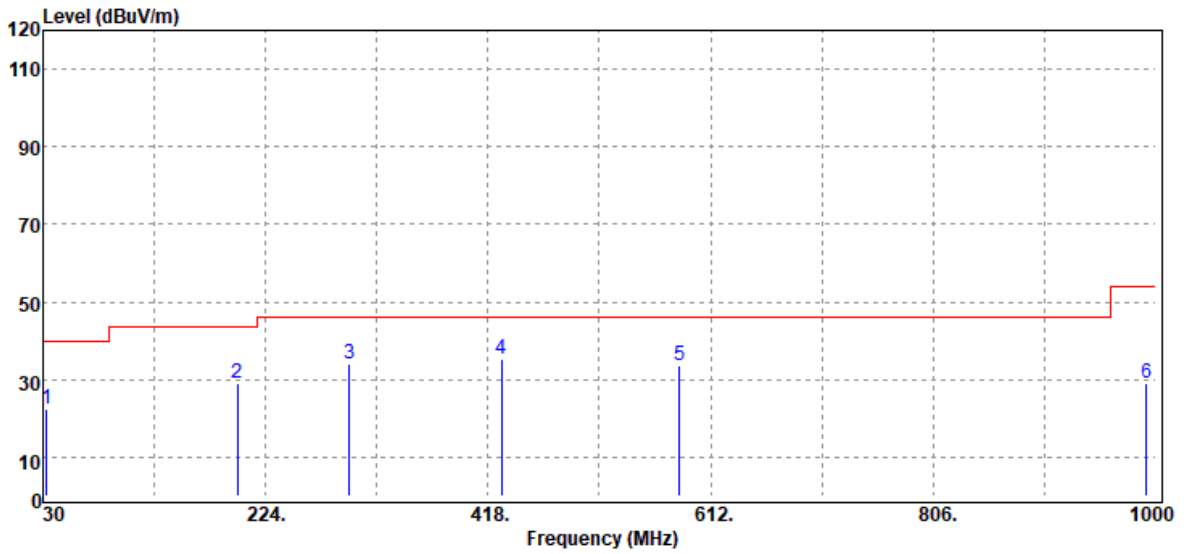

Freq. MHz	Detector Mode PK/QP/AV	Spectrum Reading Level dB $\mu$ V	Factor dB	Actual FS dB $\mu$ V/m	Limit @3m dB $\mu$ V/m	Margin dB
32.91	Peak	-503.31	525.84	22.53	40.00	-17.47
199.75	Peak	-491.59	520.76	29.17	43.50	-14.33
296.75	Peak	-487.46	521.45	33.99	46.00	-12.01
429.64	Peak	-489.64	525.08	35.44	46.00	-10.56
584.84	Peak	-494.06	527.54	33.48	46.00	-12.52
992.24	Peak	-504.25	533.34	29.09	54.00	-24.91

Report No.: T201104D06-RP1

**Above 1G Test Data**

Test Mode:	GFSK_BDR-1Mbps Low CH	Temp/Hum	22.4(°C)/ 55%RH
Test Item	Harmonic	Test Date	November 9, 2020
Polarize	Vertical	Test Engineer	Ray.Li
Detector	Peak		

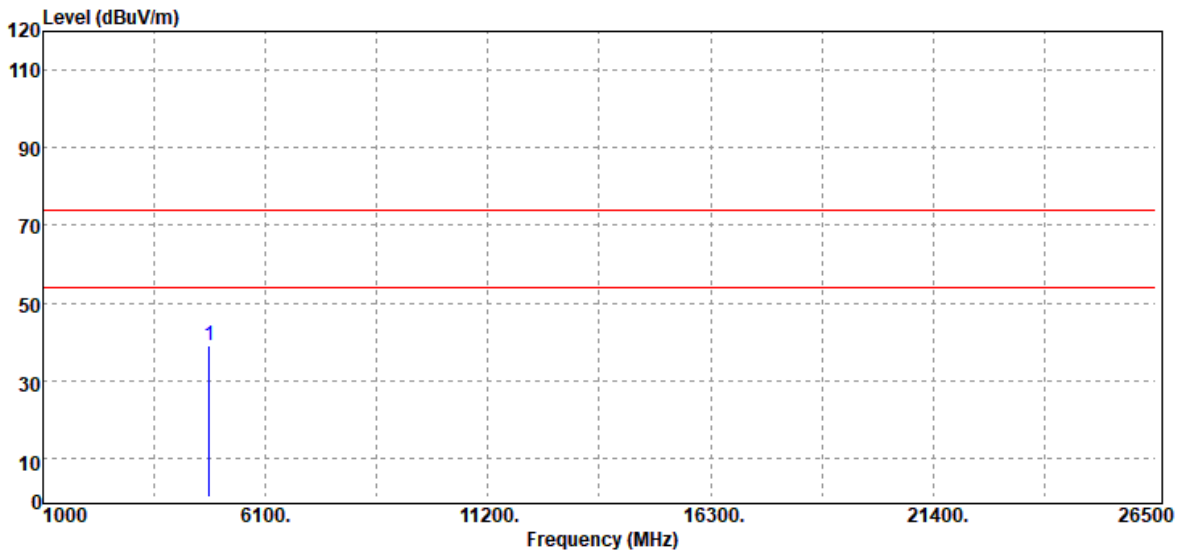

Freq. MHz	Detector Mode PK/QP/AV	Spectrum Reading Level dBμV	Factor dB	Actual FS dBμV/m	Limit @3m dBμV/m	Margin dB
4804.00	Peak	50.50	-11.45	39.05	74.00	-34.95
N/A						

**Remark:**

1. Measuring frequencies from 1 GHz to the 10th harmonic of highest fundamental frequency.
2. For above 1GHz, the EUT peak value was under average limit, therefore the Average value compliance with the average limit

Report No.: T201104D06-RP1

Test Mode:	GFSK_BDR-1Mbps Low CH	Temp/Hum	22.4(°C)/ 55%RH
Test Item	Harmonic	Test Date	November 9, 2020
Polarize	Horizontal	Test Engineer	Ray.Li
Detector	Peak		

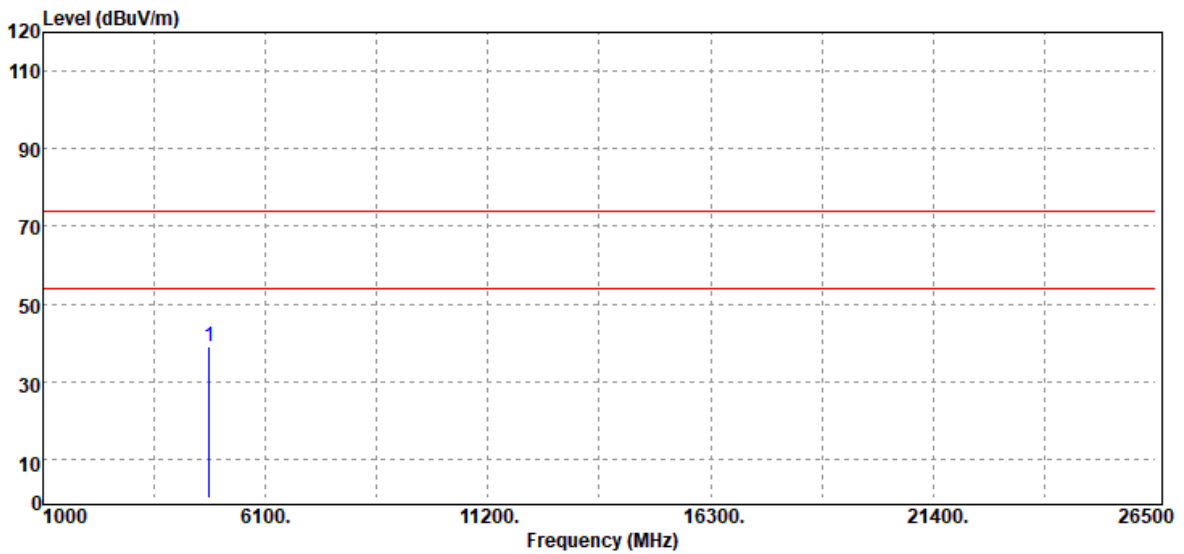

Freq. MHz	Detector Mode PK/QP/AV	Spectrum Reading Level dBuV	Factor dB	Actual FS dBuV/m	Limit @3m dBuV/m	Margin dB
4804.00	Peak	50.34	-11.45	38.89	74.00	-35.11
N/A						

**Remark:**

1. Measuring frequencies from 1 GHz to the 10<sup>th</sup> harmonic of highest fundamental frequency.
2. For above 1GHz, the EUT peak value was under average limit, therefore the Average value compliance with the average limit

Report No.: T201104D06-RP1

Test Mode:	GFSK_BDR-1Mbps Mid CH	Temp/Hum	22.4(°C)/ 55%RH
Test Item	Harmonic	Test Date	November 9, 2020
Polarize	Vertical	Test Engineer	Ray.Li
Detector	Peak		

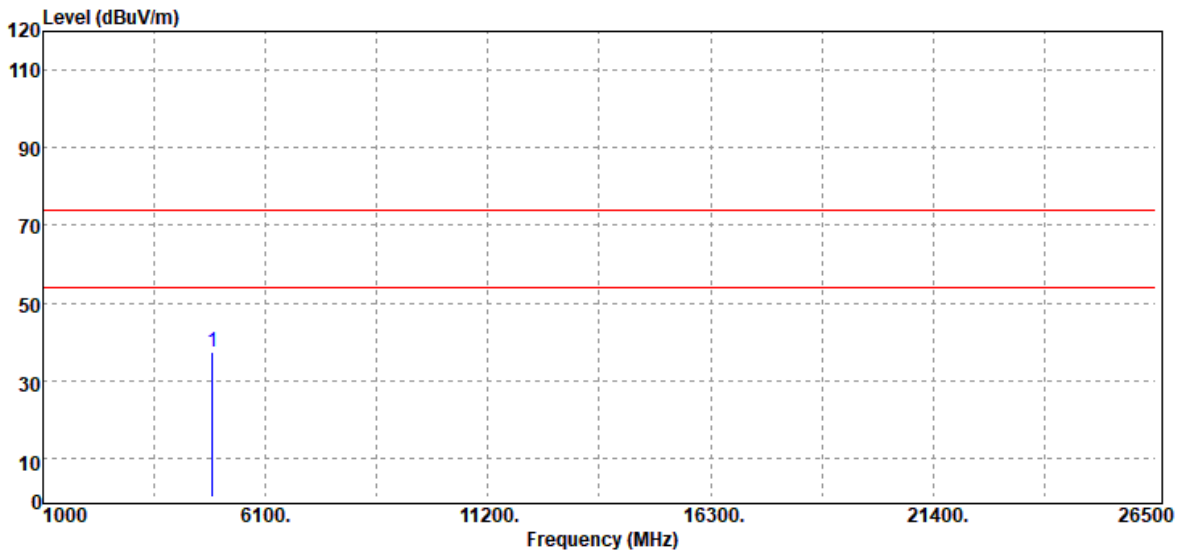

Freq. MHz	Detector Mode PK/QP/AV	Spectrum Reading Level dBuV	Factor dB	Actual FS dBuV/m	Limit @3m dBuV/m	Margin dB
4882.00	Peak	48.29	-11.05	37.24	74.00	-36.76
N/A						

**Remark:**

1. Measuring frequencies from 1 GHz to the 10<sup>th</sup> harmonic of highest fundamental frequency.
2. For above 1GHz, the EUT peak value was under average limit, therefore the Average value compliance with the average limit

Report No.: T201104D06-RP1

Test Mode:	GFSK_BDR-1Mbps Mid CH	Temp/Hum	22.4(°C)/ 55%RH
Test Item	Harmonic	Test Date	November 9, 2020
Polarize	Horizontal	Test Engineer	Ray.Li
Detector	Peak		

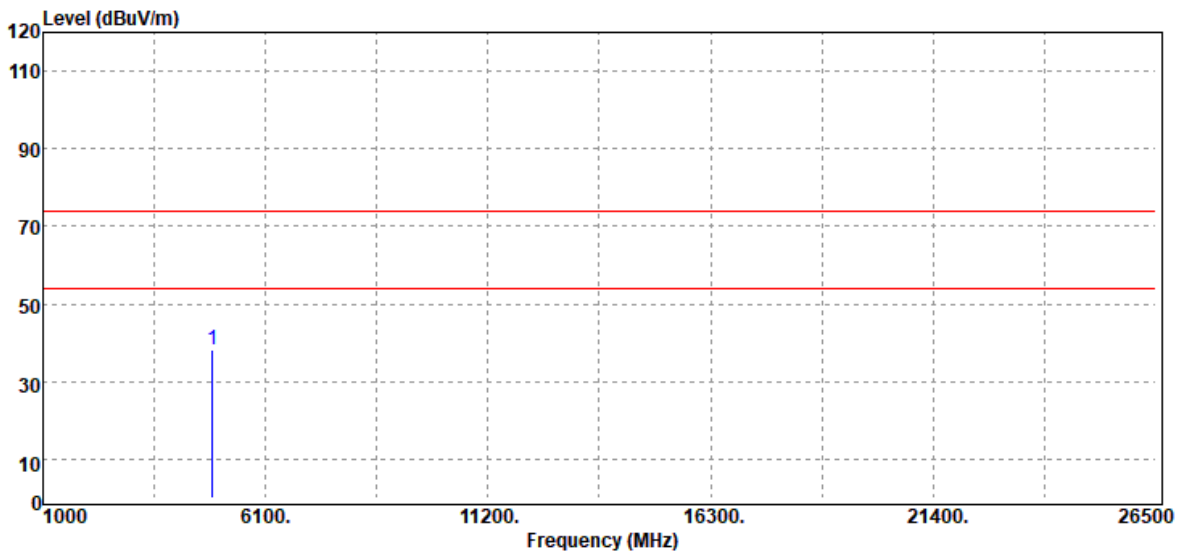

Freq. MHz	Detector Mode PK/QP/AV	Spectrum Reading Level dB $\mu$ V	Factor dB	Actual FS dB $\mu$ V/m	Limit @3m dB $\mu$ V/m	Margin dB
4882.00	Peak	49.46	-11.05	38.41	74.00	-35.59
N/A						

**Remark:**

1. Measuring frequencies from 1 GHz to the 10th harmonic of highest fundamental frequency.
2. For above 1GHz, the EUT peak value was under average limit, therefore the Average value compliance with the average limit

Report No.: T201104D06-RP1

Test Mode:	GFSK_BDR-1Mbps High CH	Temp/Hum	22.4(°C)/ 55%RH
Test Item	Harmonic	Test Date	November 9, 2020
Polarize	Vertical	Test Engineer	Ray.Li
Detector	Peak		

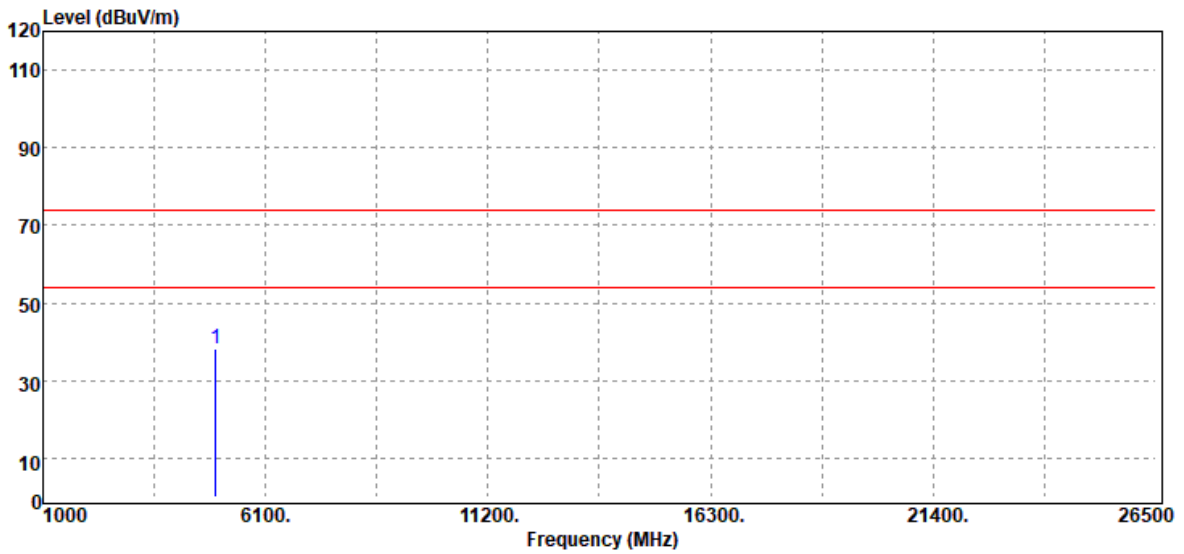

Freq. MHz	Detector Mode PK/QP/AV	Spectrum Reading Level dB $\mu$ V	Factor dB	Actual FS dB $\mu$ V/m	Limit @3m dB $\mu$ V/m	Margin dB
4960.00	Peak	48.64	-10.49	38.15	74.00	-35.85
N/A						

**Remark:**

1. Measuring frequencies from 1 GHz to the 10th harmonic of highest fundamental frequency.
2. For above 1GHz,the EUT peak value was under average limit, therefore the Average value compliance with the average limit

Report No.: T201104D06-RP1

Test Mode:	GFSK_BDR-1Mbps High CH	Temp/Hum	22.4(°C)/ 55%RH
Test Item	Harmonic	Test Date	November 9, 2020
Polarize	Horizontal	Test Engineer	Ray.Li
Detector	Peak		

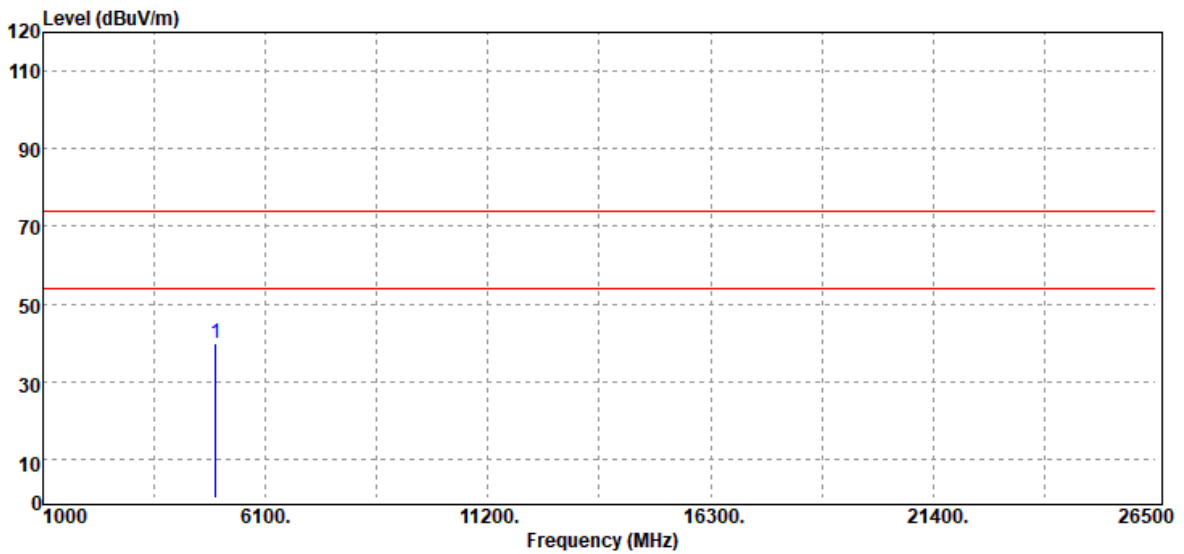

Freq. MHz	Detector Mode PK/QP/AV	Spectrum Reading Level dB $\mu$ V	Factor dB	Actual FS dB $\mu$ V/m	Limit @3m dB $\mu$ V/m	Margin dB
4960.00	Peak	50.41	-10.49	39.92	74.00	-34.08
N/A						

**Remark:**

1. Measuring frequencies from 1 GHz to the 10th harmonic of highest fundamental frequency.
2. For above 1GHz, the EUT peak value was under average limit, therefore the Average value compliance with the average limit



Report No.: T201104D06-RP1

Test Mode	8DPSK_EDR-3Mbps Low CH	Temp/Hum	22.4(°C)/ 55%RH
Test Item	Harmonic	Test Date	November 9, 2020
Polarize	Vertical	Test Engineer	Ray.Li
Detector	Peak		

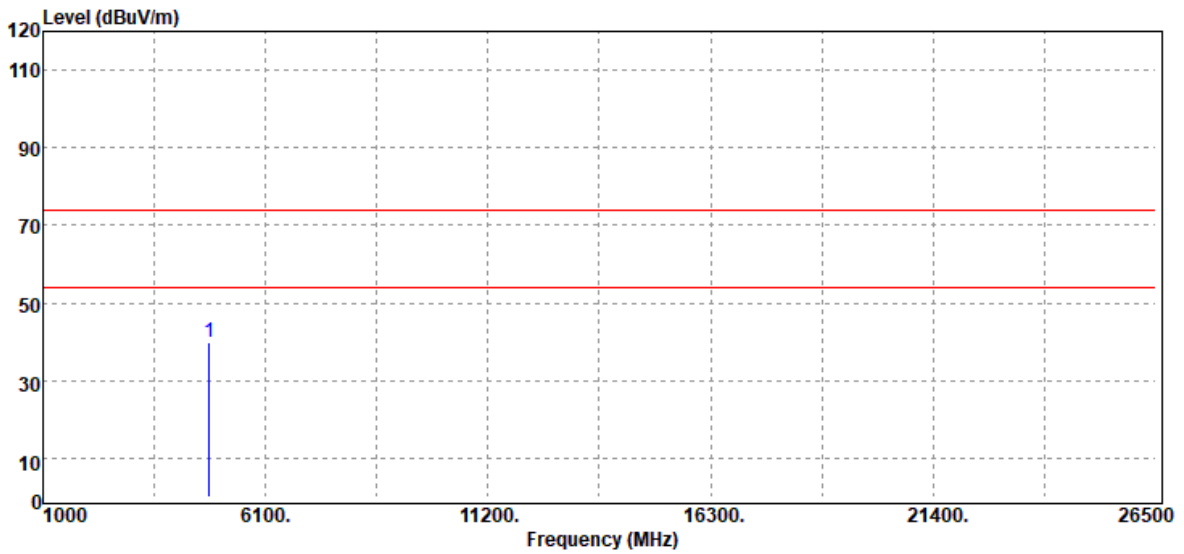

Freq. MHz	Detector Mode PK/QP/AV	Spectrum Reading Level dB $\mu$ V	Factor dB	Actual FS dB $\mu$ V/m	Limit @3m dB $\mu$ V/m	Margin dB
4804.00	Peak	51.33	-11.45	39.88	74.00	-34.12
N/A						

**Remark:**

1. Measuring frequencies from 1 GHz to the 10<sup>th</sup> harmonic of highest fundamental frequency.
2. For above 1GHz, the EUT peak value was under average limit, therefore the Average value compliance with the average limit

Report No.: T201104D06-RP1

Test Mode	8DPSK_EDR-3Mbps Low CH	Temp/Hum	22.4(°C)/ 55%RH
Test Item	Harmonic	Test Date	November 9, 2020
Polarize	Horizontal	Test Engineer	Ray.Li
Detector	Peak		

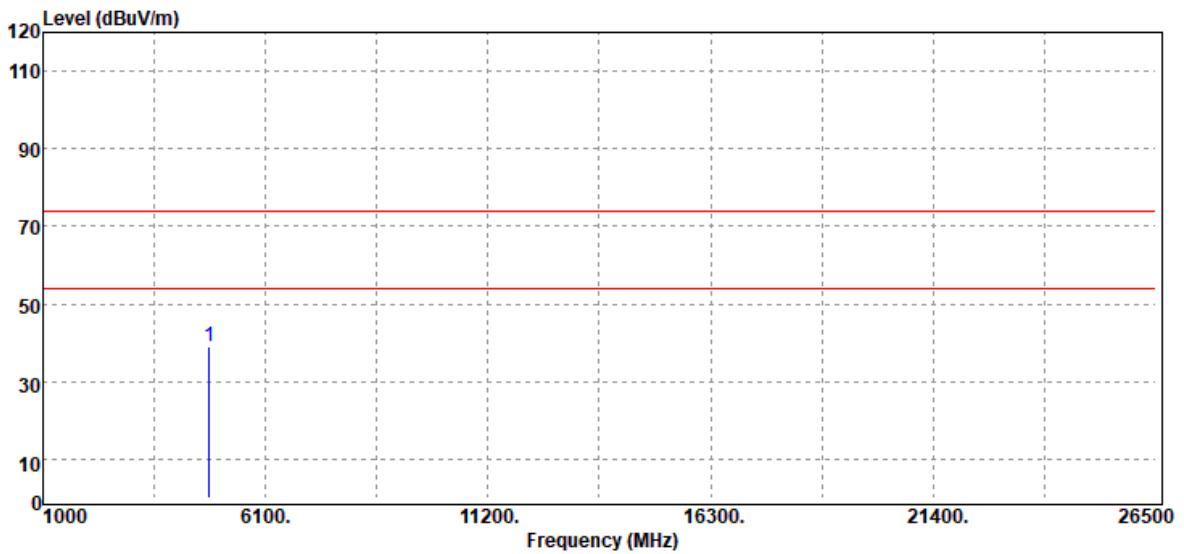

Freq. MHz	Detector Mode PK/QP/AV	Spectrum Reading Level dB $\mu$ V	Factor dB	Actual FS dB $\mu$ V/m	Limit @3m dB $\mu$ V/m	Margin dB
4804.00	Peak	50.60	-11.45	39.15	74.00	-34.85
N/A						

**Remark:**

1. Measuring frequencies from 1 GHz to the 10th harmonic of highest fundamental frequency.
2. For above 1GHz, the EUT peak value was under average limit, therefore the Average value compliance with the average limit

Report No.: T201104D06-RP1

Test Mode	8DPSK_EDR-3Mbps Mid CH	Temp/Hum	22.4(°C)/ 55%RH
Test Item	Harmonic	Test Date	November 9, 2020
Polarize	Vertical	Test Engineer	Ray.Li
Detector	Peak		

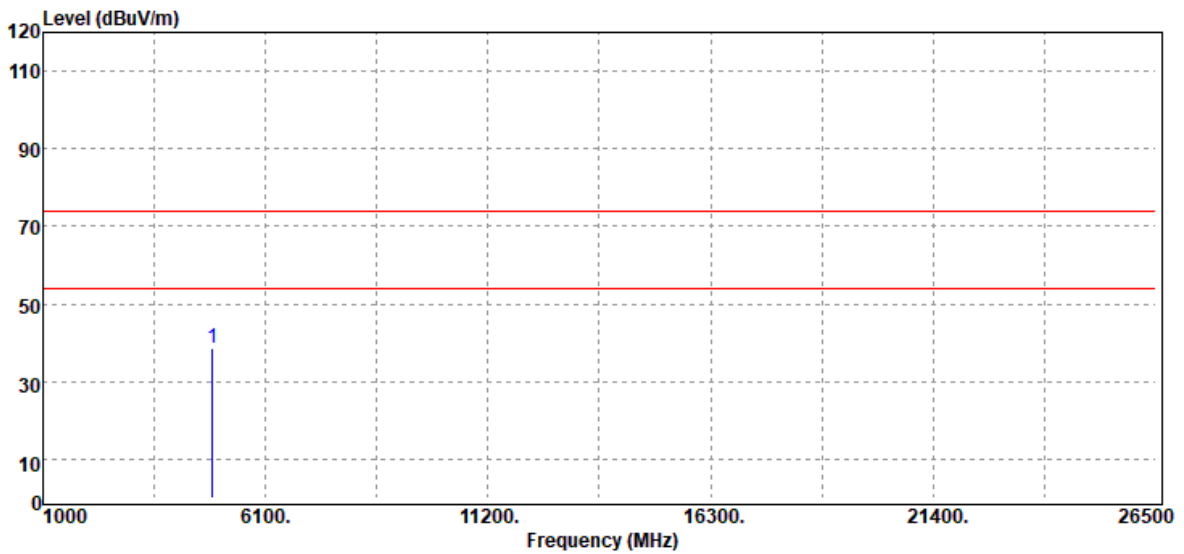

Freq. MHz	Detector Mode PK/QP/AV	Spectrum Reading Level dB $\mu$ V	Factor dB	Actual FS dB $\mu$ V/m	Limit @3m dB $\mu$ V/m	Margin dB
4882.00	Peak	49.64	-11.05	38.59	74.00	-35.41
N/A						

**Remark:**

1. Measuring frequencies from 1 GHz to the 10<sup>th</sup> harmonic of highest fundamental frequency.
2. For above 1GHz, the EUT peak value was under average limit, therefore the Average value compliance with the average limit

Report No.: T201104D06-RP1

Test Mode	8DPSK_EDR-3Mbps Mid CH	Temp/Hum	22.4(°C)/ 55%RH
Test Item	Harmonic	Test Date	November 9, 2020
Polarize	Horizontal	Test Engineer	Ray.Li
Detector	Peak		

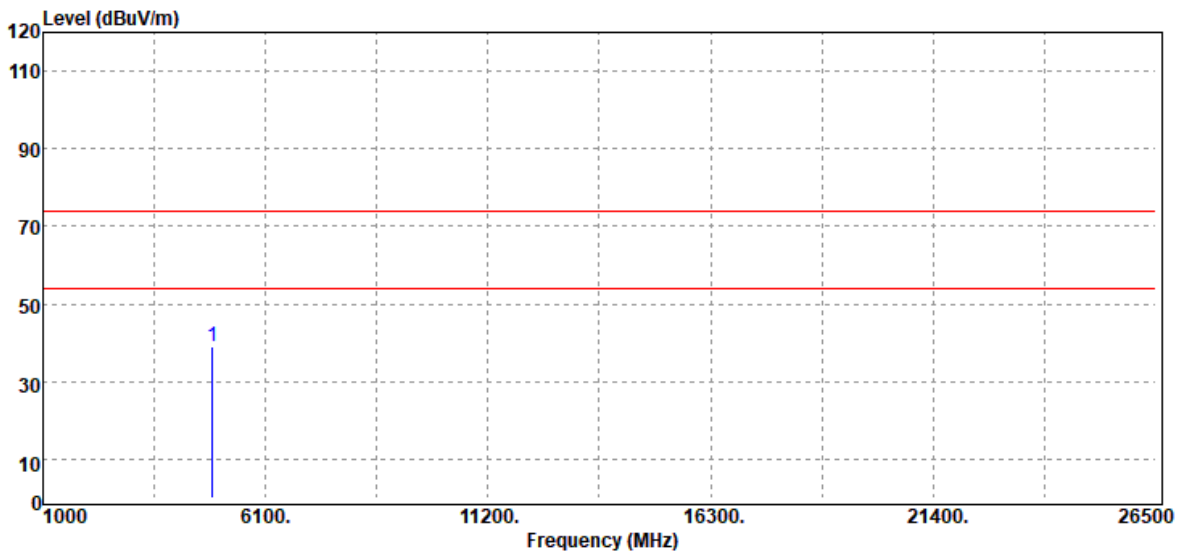

Freq. MHz	Detector Mode PK/QP/AV	Spectrum Reading Level dB $\mu$ V	Factor dB	Actual FS dB $\mu$ V/m	Limit @3m dB $\mu$ V/m	Margin dB
4882.00	Peak	50.00	-11.05	38.95	74.00	-35.05
N/A						

**Remark:**

1. Measuring frequencies from 1 GHz to the 10th harmonic of highest fundamental frequency.
2. For above 1GHz, the EUT peak value was under average limit, therefore the Average value compliance with the average limit

Report No.: T201104D06-RP1

Test Mode	8DPSK_EDR-3Mbps High CH	Temp/Hum	22.4(°C)/ 55%RH
Test Item	Harmonic	Test Date	November 9, 2020
Polarize	Vertical	Test Engineer	Ray.Li
Detector	Peak		

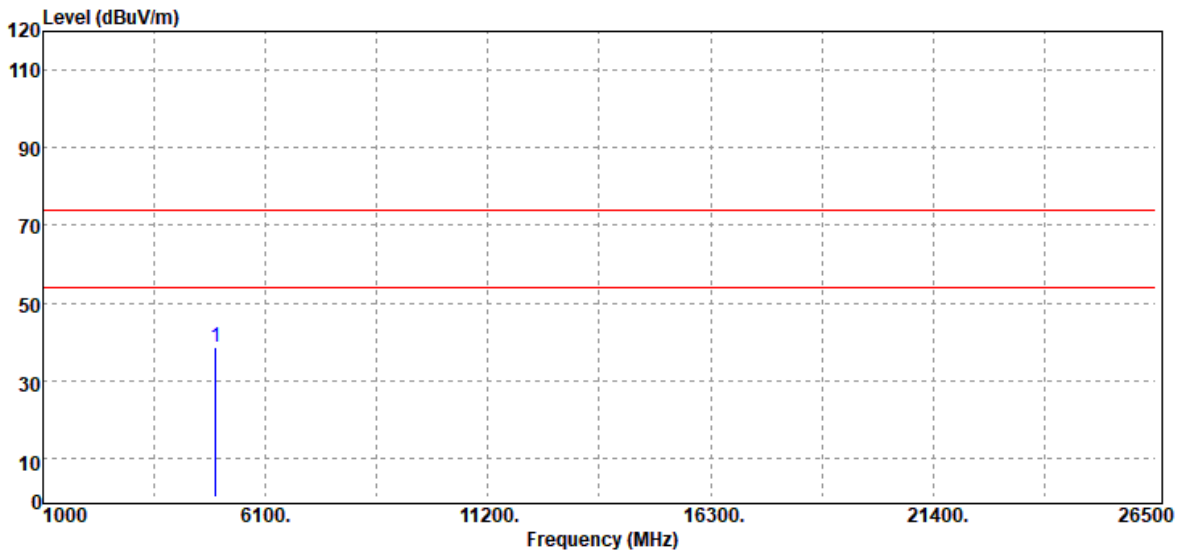

Freq. MHz	Detector Mode PK/QP/AV	Spectrum Reading Level dB $\mu$ V	Factor dB	Actual FS dB $\mu$ V/m	Limit @3m dB $\mu$ V/m	Margin dB
4960.00	Peak	49.18	-10.49	38.69	74.00	-35.31
N/A						

**Remark:**

1. Measuring frequencies from 1 GHz to the 10th harmonic of highest fundamental frequency.
2. For above 1GHz,the EUT peak value was under average limit, therefore the Average value compliance with the average limit

Report No.: T201104D06-RP1

Test Mode	8DPSK_EDR-3Mbps High CH	Temp/Hum	22.4(°C)/ 55%RH
Test Item	Harmonic	Test Date	November 9, 2020
Polarize	Horizontal	Test Engineer	Ray.Li
Detector	Peak		

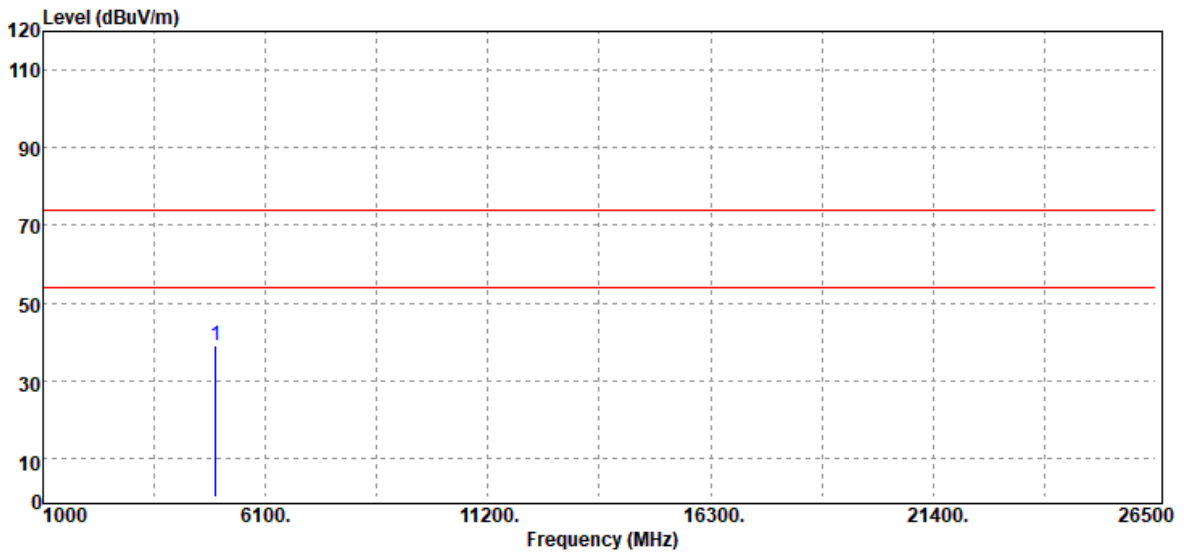

Freq. MHz	Detector Mode PK/QP/AV	Spectrum Reading Level dB $\mu$ V	Factor dB	Actual FS dB $\mu$ V/m	Limit @3m dB $\mu$ V/m	Margin dB
4960.00	Peak	49.33	-10.49	38.84	74.00	-35.16
N/A						

**Remark:**

1. Measuring frequencies from 1 GHz to the 10th harmonic of highest fundamental frequency.
2. For above 1GHz, the EUT peak value was under average limit, therefore the Average value compliance with the average limit

- End of Test Report -