



FCC TEST REPORT

Report No:STS2010197W01

Issued for

Zhizhen Audio Tech(Dongguan)Co.,Ltd

2F, No.45, Guanlong Rd, Baizhoubian Community, Dongcheng St, Dongguan, China

Product Name:	Wireless Microphone
Brand Name:	REALMIC
Model Name:	MC9T
Series Model:	MC9,MC9S,MC9F,MC8,MC8T,MC8S
FCC ID:	2AX60MC9T
Test Standard:	FCC Part 74 Rules

Any reproduction of this document must be done in full. No single part of this document may be reproduced without permission from STS, all test data presented in this report is only applicable to presented test sample.

Shenzhen STS Test Services Co., Ltd.
 A 1/F, Building B, Zhuoke Science Park, No.190 Chongqing Road, HepingShequ,
 Fuyong Sub-District, Bao'an District, Shenzhen, Guang Dong, China
 TEL: +86-755 3688 6288 FAX: +86-755 3688 6277 E-mail:sts@stsapp.com





TEST RESULT CERTIFICATION

Applicant's Name : Zhizhen Audio Tech(Dongguan)Co.,Ltd
Address : 2F, No.45, Guanlong Rd, Baizhoubian Community, Dongcheng St, Dongguan, China
Manufacturer's Name : Zhizhen Audio Tech(Dongguan)Co.,Ltd
Address : 2F, No.45, Guanlong Rd, Baizhoubian Community, Dongcheng St, Dongguan, China

Product Description

Product Name : Wireless Microphone
Brand Name : REALMIC
Model Name : MC9T
Series Model : MC9,MC9S,MC9F,MC8,MC8T,MC8S

Test Standards : FCC Part 74 Rules

Test Procedure : TIA-603-E

This device described above has been tested by STS, the test results show that the equipment under test (EUT) is in compliance with the FCC requirements. And it is applicable only to the tested sample identified in the report.

This report shall not be reproduced except in full, without the written approval of STS, this document only be altered or revised by STS, personal only, and shall be noted in the revision of the document.

Date of Test :
Date of receipt of test item : 31 Oct. 2020
Date of performance of tests : 31 Oct. 2020 ~ 26 Dec. 2020
Date of Issue : 26 Dec. 2020
Test Result : Pass

Testing Engineer :

(Chris Chen)

Technical Manager :

(Sean she)

Authorized Signatory :

(Vita Li)





Table of Contents	Page
1. SUMMARY OF TEST RESULTS	5
1.1 TEST FACTORY	6
1.2 MEASUREMENT UNCERTAINTY	6
2. GENERAL INFORMATION	7
2.1 GENERAL DESCRIPTION OF THE EUT	7
2.2 DESCRIPTION OF THE TEST MODES	9
2.3 BLOCK DIAGRAM SHOWING THE CONFIGURATION OF SYSTEM TESTED	10
2.4 DESCRIPTION OF NECESSARY ACCESSORIES AND SUPPORT UNITS	10
2.5 TEST EQUIPMENT	11
3. TEST METHODOLOGY	12
3.1 GENERAL TEST PROCEDURES	12
3.2 DESCRIPTION OF TEST MODES	12
3.3 FCC PART 15.205 RESTRICTED BANDS OF OPERATIONS	12
4. FCC PART 74 REQUIREMENTS	13
4.1 RADIATED SPURIOUS EMISSION	13
4.2 EMISSION MASK I	13
4.3 EMISSION MASK II	13
4.4 FREQUENCY STABILITY VS. TEMPERATURE & VOLTAGE	28
4.5 OCCUPIED BANDWIDTH	32
4.6 AUDIO FREQUENCY RESPONSE	35
4.7 MODULATION DEVIATION	37
4.8 RF OUTPUT POWER	39
PHOTOS OF TEST SETUP	42



Revision History

Rev.	Issue Date	Report NO.	Effect Page	Contents
00	26 Dec. 2020	STS2010197W01	ALL	Initial Issue





1. SUMMARY OF TEST RESULTS

Test procedures according to the technical standards:

The EUT has been tested according to FCC CFR 47:

Part 2: Frequency Allocations and Radio Treaty Matters: General Rules and Regulations (10-1-05 Edition)

Part 74: Experimental Radio, Auxiliary, Special Broadcast and other program distributional services

Emission			
Standard	Item	Limit	Result
FCC 2.1053; 74.861(e)(6)	Radiated Spurious Emission	Refer to 74.861e(6)	PASS
FCC 2.1046 (a), 74.861(e)(1)	RF Output Power	250 mW	PASS
FCC 2.1047 (b), 74.861(e)(3)	Modulation Deviation	Refer to 74.861e(2)	PASS
FCC 2.1047 (a)	Audio Frequency Response	Refer to 2.1047(a)	PASS
FCC 74.861 (e)(5)	Occupied Bandwidth	< 200 KHz	PASS
FCC 74.861 (e)(6)(i) (ii); FCC 2.1049	Emission Mask	Refer to 74.861e(6)	PASS
2.1055(b); 74.861 e(4)	Frequency Stability vs. Temperature	Refer to 74.861e(4)	PASS
2.1055(a)(1); 74.861 e(4)	Frequency Stability vs. Voltage	Refer to 74.861e(4)	PASS

NOTE:

(1) "N/A" denotes test is not applicable in this Test Report.



1.1 TEST FACTORY

SHENZHEN STS TEST SERVICES CO., LTD

Add. : A 1/F, Building B, Zhuoke Science Park, No.190 Chongqing Road, HepingShequ, Fuyong Sub-District, Bao'an District, Shenzhen, Guang Dong, China

FCC test Firm Registration Number: 625569

IC test Firm Registration Number: 12108A

A2LA Certificate No.: 4338.01

1.2 MEASUREMENT UNCERTAINTY

The reported uncertainty of measurement $y \pm U$, where expanded uncertainty U is based on a standard uncertainty multiplied by a coverage factor of $k=2$, providing a level of confidence of approximately 95 %.

No.	Item	Uncertainty
1	RF output power, conducted	$\pm 0.68\text{dB}$
2	Unwanted Emissions, conducted	$\pm 2.988\text{dB}$
3	All emissions, radiated 30-1GHz	$\pm 5.6\text{dB}$
4	All emissions, radiated 1G-6GHz	$\pm 5.5\text{dB}$
5	All emissions, radiated >6G	$\pm 5.8\text{dB}$
6	Conducted Emission (9KHz-150KHz)	$\pm 3.37\text{dB}$
7	Conducted Emission (150KHz-30MHz)	$\pm 3.83\text{dB}$



2. GENERAL INFORMATION

2.1 GENERAL DESCRIPTION OF THE EUT

Product Name:	Wireless Microphone
Brand Name:	REALMIC
Model Name:	MC9T
Series Model:	MC9,MC9S,MC9F,MC8,MC8T,MC8S
Model Difference description:	Only difference in model name
Emission Bandwidth:	173.12KHz
Battery:	Rated Voltage:3.7V Charge Limit Voltage:4.2V Capacity: 1000mAh
Operation Frequency Range:	487 MHz- 533 MHz
Maximum Transmitter Power:	4.344 mW(6.379dBm)
Modulation mode / type:	DQPSK
Frequency Tolerance:	0.003578%
Temperature Range:	-30°C-50°C
Test frequency list:	See Note 4.
Software version number:	N/A
Hardware version number:	N/A

Note:

- For a more detailed features description, please refer to the manufacturer's specifications or the User Manual.

- | Channel List | | | | | | | |
|--------------|-----------------|---------|-----------------|---------|-----------------|---------|-----------------|
| Channel | Frequency (MHz) | Channel | Frequency (MHz) | Channel | Frequency (MHz) | Channel | Frequency (MHz) |
| 01 | 487 | 02 | 489 | 03 | 491 | 04 | 493 |
| 05 | 499.1 | 06 | 502.1 | 07 | 506.1 | 08 | 508.1 |
| 09 | 513.6 | 10 | 515.6 | 11 | 519.6 | 12 | 520.6 |
| 13 | 521.6 | 14 | 522.6 | 15 | 523.0 | 16 | 523.6 |
| 17 | 524.0 | 18 | 524.6 | 19 | 525.0 | 20 | 525.6 |
| 21 | 526.0 | 22 | 526.6 | 23 | 527.0 | 24 | 527.6 |
| 25 | 528.0 | 26 | 528.6 | 27 | 529.0 | 28 | 529.6 |
| 29 | 530.0 | 30 | 530.6 | 31 | 531.0 | 32 | 532.0 |
| 33 | 533.0 | | | | | | |



3. Table for Filed Antenna

Ant	Brand	Model Name	Antenna Type	Connector	Gain (dBi)	NOTE
1	REALMIC	MC9T	1/4 Wave long whip antenna	NA	1	Antenna

The EUT antenna is Dipole Antenna. no antenna other than that furnished by the responsible party shall be used with the device.

4. Test frequency list

Test Channel List		
Test Channel	EUT Channel	Test Frequency (MHz)
lowest	CH01	487
middle	CH15	523
highest	CH33	533

Note:

In section 15.31(m), regards to the operating frequency range over 10 MHz, the Lowest frequency, the middle frequency, and the highest frequency of channel were selected to perform the test, please see the above listed frequency for testing.



2.2 DESCRIPTION OF THE TEST MODES

To investigate the maximum EMI emission characteristics generated from EUT, the test system was pre-scanning tested based on the consideration of following EUT operation mode or test configuration mode which possibly have effect on EMI emission level. Each of these EUT operation mode(s) or test configuration mode(s) mentioned above was evaluated respectively.

Pretest Mode	Description
Mode 1	Low Channel
Mode 2	Middle Channel
Mode 3	High Channel
Mode 4	Link Mode

For Radiated Emission	
Final Test Mode	Description
Mode 1	Low Channel
Mode 2	Middle Channel
Mode 3	High Channel

Note:

(1) Due to the different configuration and test, in this list only some worse mode. The worst test data of the worse mode is reported by this report.



2.3 BLOCK DIAGRAM SHOWING THE CONFIGURATION OF SYSTEM TESTED
Radiated Spurious Emission Test

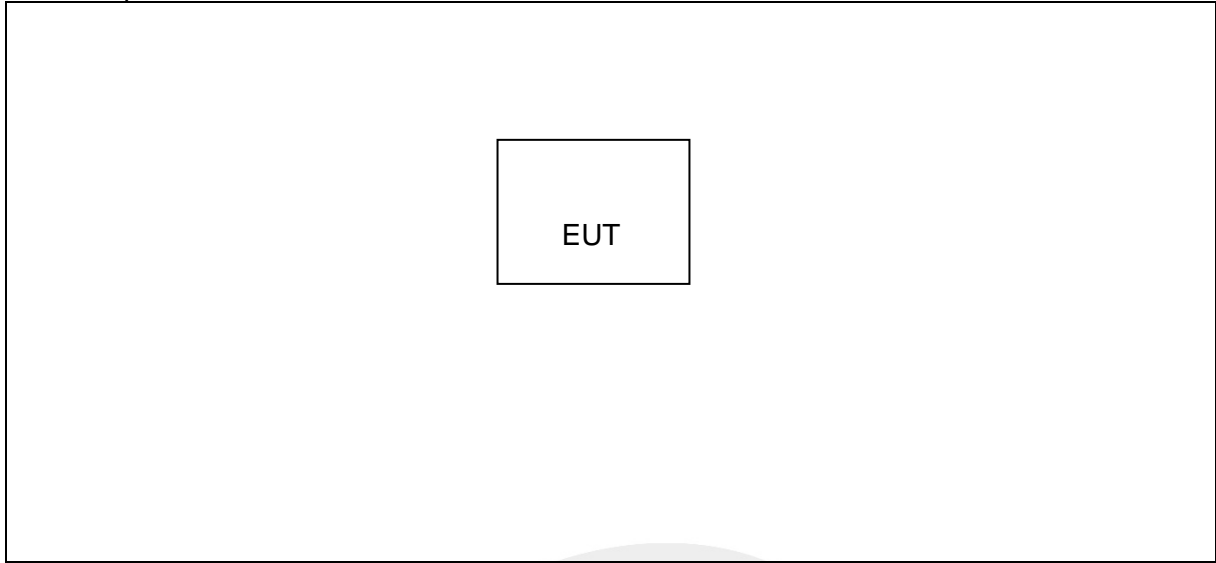

2.4 DESCRIPTION OF NECESSARY ACCESSORIES AND SUPPORT UNITS

The EUT has been tested as an independent unit together with other necessary accessories or support units. The following support units or accessories were used to form a representative test configuration during the tests.

Necessary accessories

Item	Equipment	Mfr/Brand	Model/Type No.	Serial No.	Note
N/A	N/A	N/A	N/A	N/A	N/A

Support units

Item	Equipment	Mfr/Brand	Model/Type No.	Serial No.	Note
N/A	N/A	N/A	N/A	N/A	N/A

Note:

- (1) For detachable type I/O cable should be specified the length in cm in 『Length』 column.
- (2) “YES” is means “shielded” “with core”; “NO” is means “unshielded” “without core”.



2.5 TEST EQUIPMENT

Radiation Test equipment

Kind of Equipment	Manufacturer	Type No.	Serial No.	Last calibration	Calibrated until
Bilog Antenna	TESEQ	CBL6111D	34678	2020.10.12	2021.10.11
Horn Antenna	SCHWARZBECK	BBHA 9120D	02014	2019.10.15	2021.10.14
Pre-Amplifier (0.1M-3GHz)	EM	EM330	060665	2020.10.12	2021.10.11
Pre-Amplifier (1G-18GHz)	SKET	LNPA-01018G-45	SK2018080901	2020.10.12	2021.10.11
Signal Analyzer	R&S	FSV 40-N	101823	2020.10.10	2021.10.09
Temperature & Humidity	HH660	Mieo	N/A	2020.10.13	2021.10.12
Turn table	EM	SC100_1	60531	N/A	N/A
Antenna mast	EM	SC100	N/A	N/A	N/A
AC Power Source	APC	KDF-11010G	F214050035	N.C.R	N.C.R
Test SW	FARAD	EZ-EMC(Ver.STSLAB-03A1 RE)			

RF Connected Test equipment

Kind of Equipment	Manufacturer	Type No.	Serial No.	Last calibration	Calibrated until
Signal Generator	Agilent	N5182A	MY46240556	2020.10.10	2021.10.09
Signal Analyzer	Agilent	N9020A	MY51110105	2020.03.05	2021.03.04
Universal Radio communication tester	R&S	CMU200	119907	2020.10.12	2021.10.11
Audio analyzer	R&S	UPL	N/A	2020.03.05	2021.03.04
Temperature & Humidity	HH660	Mieo	N/A	2020.10.13	2021.10.12
Temperature& Humidity test chamber	Safety test	AG80L	171200018	2020.03.05	2021.03.04
Programmable power supply	Agilent	E3642A	MY40002025	2020.10.12	2021.10.11
Attenuator	HP	8494B	DC-18G	2020.04.30	2021.04.29
AC Power Source	APC	KDF-11010G	F214050035	N.C.R	N.C.R
Test SW	FARAD	LZ-RF /LzRf-3A3			



3. TEST METHODOLOGY

3.1 GENERAL TEST PROCEDURES

Conducted Emissions

The EUT is placed on the turntable, which is 0.8 m above ground plane. According to the requirement in Section 13.1.4.1 of ANSI C63.4:2003. Conducted emissions from the EUT measured in the frequency range between 0.15 MHz and 30MHz using CISPR Quasi-peak and average detector modes.

Not Applicable (Since the EUT is powered by battery)

Radiated Emissions

The EUT is placed on a turn table, which is 0.8 m above ground plane. The turntable shall rotate 360 degrees to determine the position of maximum emission level. EUT is set 3m away from the receiving antenna, which varied from 1m to 4m to find out the highest emission. And also, each emission was to be maximized by changing the polarization of receiving antenna both horizontal and vertical. In order to find out the maximum emissions, exploratory radiated emission measurements were made according to the requirements in Section 13.1.4.1 of ANSI C63.4:2003.

3.2 DESCRIPTION OF TEST MODES

The EUT has been tested under engineering test mode condition and the EUT staying in continuous transmitting mode.

3.3 FCC PART 15.205 RESTRICTED BANDS OF OPERATIONS

(a) Except as shown in paragraph (d) of this section, only spurious emissions are permitted in any of the frequency bands listed below:

MHz	MHz	MHz	GHz
0.090 - 0.110	16.42 - 16.423	399.9 - 410	4.5 - 5.15
¹ 0.495 - 0.505	16.69475 - 16.69525	608 - 614	5.35 - 5.46
2.1735 - 2.1905	16.80425 - 16.80475	960 - 1240	7.25 - 7.75
4.125 - 4.128	25.5 - 25.67	1300 - 1427	8.025 - 8.5
4.17725 - 4.17775	37.5 - 38.25	1435 - 1626.5	9.0 - 9.2
4.20725 - 4.20775	73 - 74.6	1645.5 - 1646.5	9.3 - 9.5
6.215 - 6.218	74.8 - 75.2	1660 - 1710	10.6 - 12.7
6.26775 - 6.26825	108 - 121.94	1718.8 - 1722.2	13.25 - 13.4
6.31175 - 6.31225	123 - 138	2200 - 2300	14.47 - 14.5
8.291 - 8.294	149.9 - 150.05	2310 - 2390	15.35 - 16.2
8.362 - 8.366	156.52475 - 156.52525	2483.5 - 2500	17.7 - 21.4
8.37625 - 8.38675	156.7 - 156.9	2655 - 2900	22.01 - 23.12
8.41425 - 8.41475	162.0125 - 167.17	3260 - 3267	23.6 - 24.0
12.29 - 12.293	167.72 - 173.2	3332 - 3339	31.2 - 31.8
12.51975 - 12.52025	240 - 285	3345.8 - 3358	36.43 - 36.5
12.57675 - 12.57725	322 - 335.4	3600 - 4400	(²)
13.36 - 13.41			

¹ Until February 1, 1999, this restricted band shall be 0.490-0.510 MHz.

² Above 38.6

(b) Except as provided in paragraphs (d) and (e), the field strength of emissions appearing within these frequency bands shall not exceed the limits shown in Section 15.209. At frequencies equal to or less than 1000 MHz, compliance with the limits in Section 15.209 shall be demonstrated using measurement instrumentation employing a CISPR quasi-peak detector. Above 1000 MHz, compliance with the emission limits in Section 15.209 shall be demonstrated based on the average value of the measured emissions. The provisions in Section 15.35 apply to these measurements.



4. FCC PART 74 REQUIREMENTS

4.1 RADIATED SPURIOUS EMISSION

TEST LIMITS

According to CFR 47 section 74.861 e (6)(iii), the mean power of emissions shall be attenuated below the mean output power of the transmitter in accordance with the following schedule:

The power of any emission outside of the authorized operating frequency ranges must be lower than the transmitter power (P) by a factor of at least $43 + 10 \log (P)$ dB.

It is measured by means of a calibrated spectrum analyzer and scanned from 30 MHz up to a frequency including its 10th harmonic.

The limit line is derived from $43 + 10 \log (P)$ dB below the transmitter power P(Watts)

$$= P(\text{dBW}) - [43 + 10 \log (P)] (\text{dB})$$

$$= [30 + 10 \log (P)] (\text{dBm}) - [43 + 10 \log (P)] (\text{dB})$$

$$= -13 \text{dBm}.$$

According to CFR 47 section 74.861 e (7), Beyond one megahertz below and above the carrier frequency, emissions shall comply with the limits specified in section 8.4 of ETSI EN 300 422-1 v1.4.2 (2011-08).

4.2 EMISSION MASK I

TEST LIMITS

- According to CFR 47 section 74.861 e (6), the mean power of emissions shall be attenuated below the mean output power of the transmitter in accordance with the following schedule:

- (1) On any frequency removed from the operating frequency by more than 50 percent up to and including 100 percent of the authorized bandwidth: at least 25 dB;
- a. (2) On any frequency removed from the operating frequency by more than 100 percent up to and including 250 percent of the authorized bandwidth: at least 35 dB;
- (3) On any frequency removed from the operating frequency by more than 250 percent of the authorized bandwidth: at least $43 + 10 \log 10 * (\text{mean output power in watts})$ dB;

4.3 EMISSION MASK II

TEST LIMITS

- According to ETSI EN 300 422-1 Clause 8.3.1.2,

- a. The transmitter output spectrum shall be within the mask defined in figure 3 where B is the declared channel bandwidth

TEST PROCEDURE

- a. On a test site, the EUT shall be placed on a turntable and in the position closest to the normal use as declared by the user.
- b. The test antenna shall be oriented initially for vertical polarization located 3m from the EUT to correspond to the transmitter.
- c. The output of the antenna shall be connected to the measuring receiver and either a peak or quasi-peak detector was used for the measurement as indicated on the report. The detector selection is based on how close the emission level was approaching the limit.
- d. The transmitter shall be switched on; if possible, without the modulation and the measurement receiver shall be tuned to the frequency of the transmitter under test.
- e. The test antenna shall be raised and lowered through the specified range of height until the measuring receiver detects a maximum signal level.
- f. The transmitter shall then be rotated through 360° in the horizontal plane, until the maximum signal level is detected by the measuring receiver.
- g. The test antenna shall be raised and lowered again through the specified range of height until the measuring receiver detects a maximum signal level.
- h. The maximum signal level detected by the measuring receiver shall be noted.
- i. The measurement shall be repeated with the test antenna set to horizontal polarization.
- j. Replace the antenna with a proper Antenna (substitution antenna).
- k. The substitution antenna shall be oriented for vertical polarization and, if necessary, the length of the substitution antenna shall be adjusted to correspond to the frequency of transmitting.
- l. The substitution antenna shall be connected to a calibrated signal generator.
- m. If necessary, the input attenuator setting of the measuring receiver shall be adjusted in order to increase the sensitivity of the measuring receiver.
- n. The test antenna shall be raised and lowered through the specified range of the height to ensure that the maximum signal is received.
- o. The input signal to substitution antenna shall be adjusted to the level that produces a level detected by the measuring receiver, that is equal to the level noted while the transmitter radiated power was measured, corrected for the change of input attenuation setting of the measuring receiver.
- p. The input level to the substitution antenna shall be recorded as power level in dBm, corrected for any change of input attenuator setting of the measuring receiver.
- q. The measurement shall be repeated with the test antenna and the substitution antenna oriented for horizontal polarization.

TEST CONFIGURATION

(A) Radiated Emission Test-Up Frequency Above 30MHz

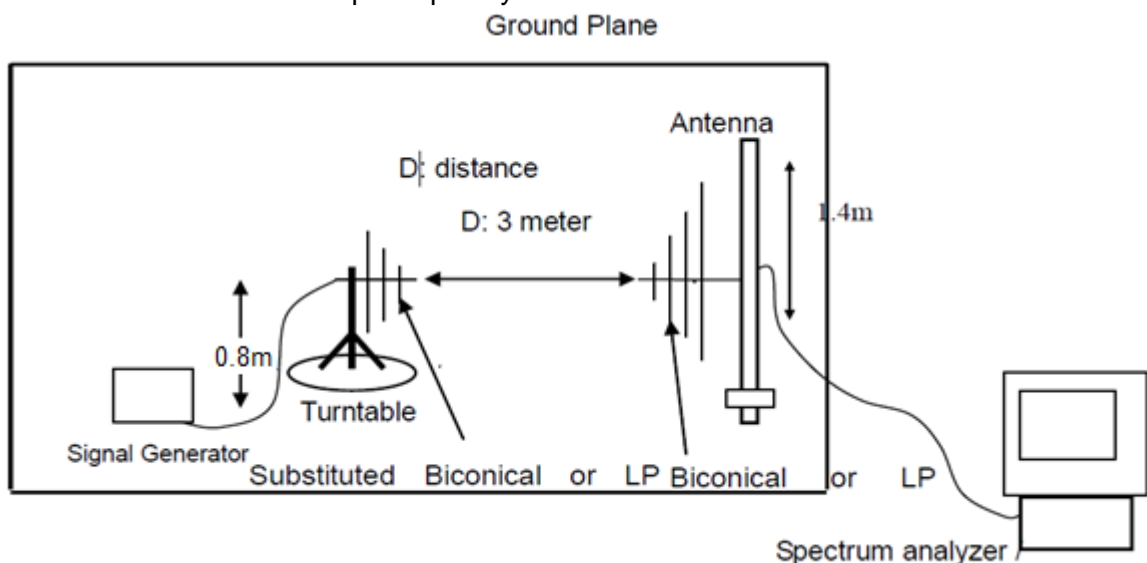

(B) Radiated Emission Test-Up Frequency Above 1GHz

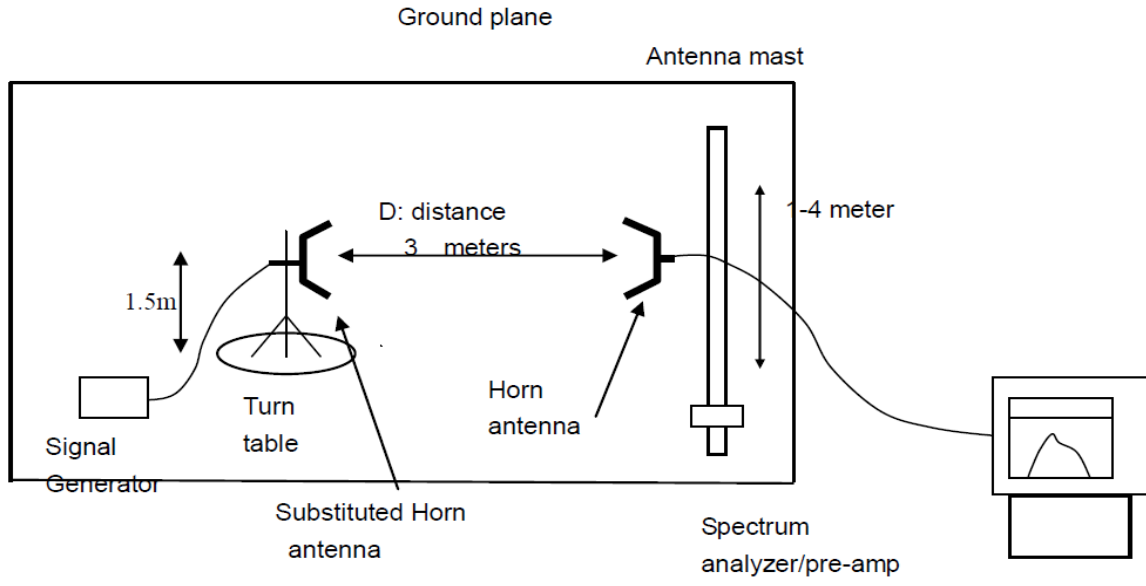



TEST RESULTS

(30-6000)MHz							
The Worst Test Results Low Channel 487 MHz							
Frequency(MHz)	S G.Lev (dBm)	Ant(dBi)	Loss	PMea	Limit	Margin	Polarity
				(dBm)	(dBm)	(dBm)	
1217.01	-39.90	6.12	4.27	-38.05	-13.00	-25.05	H
1460.75	-38.69	8.71	6.48	-36.46	-13.00	-23.46	H
1947.71	-30.37	10.41	10.78	-30.74	-13.00	-17.74	H
1208.25	-43.10	6.09	4.32	-41.33	-13.00	-28.33	V
1460.93	-43.90	8.74	6.52	-41.68	-13.00	-28.68	V
1947.98	-42.16	10.39	10.81	-42.58	-13.00	-29.58	V
The Worst Test Results Mid Channel 523 MHz							
Frequency(MHz)	S G.Lev (dBm)	Ant(dBi)	Loss	PMea	Limit	Margin	Polarity
				(dBm)	(dBm)	(dBm)	
1045.86	-36.30	6.88	4.72	-34.14	-13.00	-21.14	H
1568.80	-42.83	10.13	8.32	-41.02	-13.00	-28.02	H
2092.31	-37.63	9.65	11.72	-39.70	-13.00	-26.70	H
1045.86	-37.34	6.88	4.72	-35.18	-13.00	-22.18	V
1568.80	-31.39	10.13	8.32	-29.58	-13.00	-16.58	V
2092.31	-36.39	9.65	11.72	-38.46	-13.00	-25.46	V
The Worst Test Results High Channel 533 MHz							
Frequency(MHz)	S G.Lev (dBm)	Ant(dBi)	Loss	PMea	Limit	Margin	Polarity
				(dBm)	(dBm)	(dBm)	
1066.82	-36.16	6.88	4.72	-34.00	-13.00	-21.00	H
1598.86	-42.84	10.13	8.32	-41.03	-13.00	-28.03	H
2132.26	-38.13	9.65	11.72	-40.20	-13.00	-27.20	H
1066.82	-37.38	6.88	4.72	-35.22	-13.00	-22.22	V
1598.86	-31.42	10.13	8.32	-29.61	-13.00	-16.61	V
2132.26	-36.16	9.65	11.72	-38.23	-13.00	-25.23	V



ETSI EN 300 422-1 Clause 8.4 Spurious emissions:

Low channel
Horizontal

RSE-EN RX-TX TEST Case_EN300442_EN300 442-TX_25M-13G_H

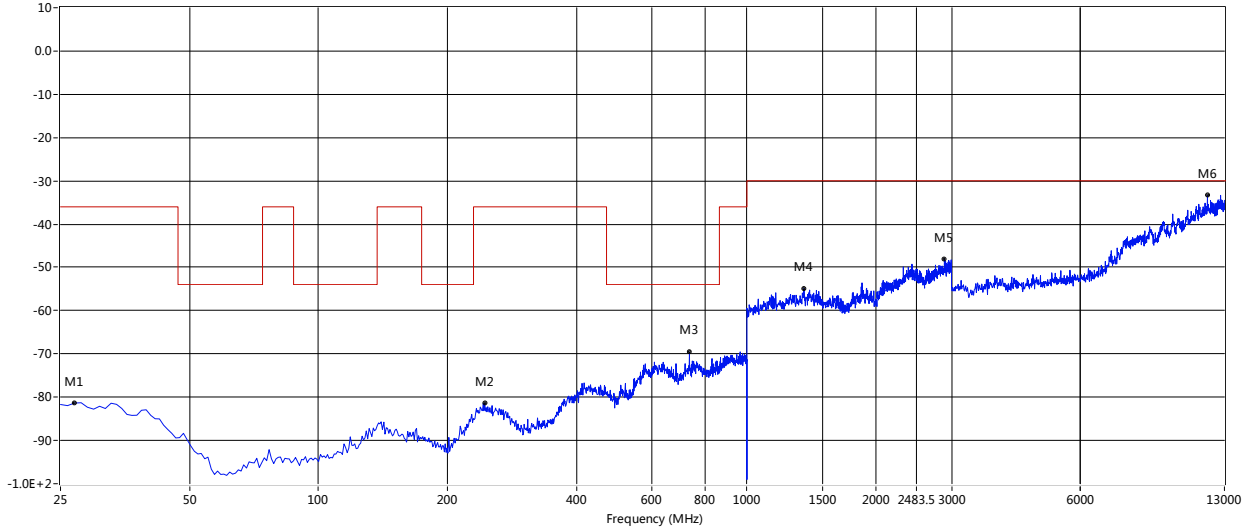

Frequency (MHz)	Result (dBm)	Factor (dB)	PK Limit (dBm)	Over Limit (dB)	Table (o)	ANT	EUT	Verdict
26.950	-81.36	-1.94	-36.0	-45.36	3.00	Horizontal	Vertical	Pass
244.375	-81.34	-0.94	-36.0	-45.34	10.00	Horizontal	Vertical	Pass
733.825	-69.58	6.81	-54.0	-15.58	4.00	Horizontal	Vertical	Pass
1358.000	-54.88	13.60	-30.0	-24.88	5.00	Horizontal	Vertical	Pass
2888.000	-47.97	20.66	-30.0	-17.97	5.00	Horizontal	Vertical	Pass
11870.000	-33.30	22.49	-30.0	-3.30	1.00	Horizontal	Vertical	Pass



Vertical

RSE-EN RX-TX TEST Case_EN300442_EN300 442-TX_25M-13G_V

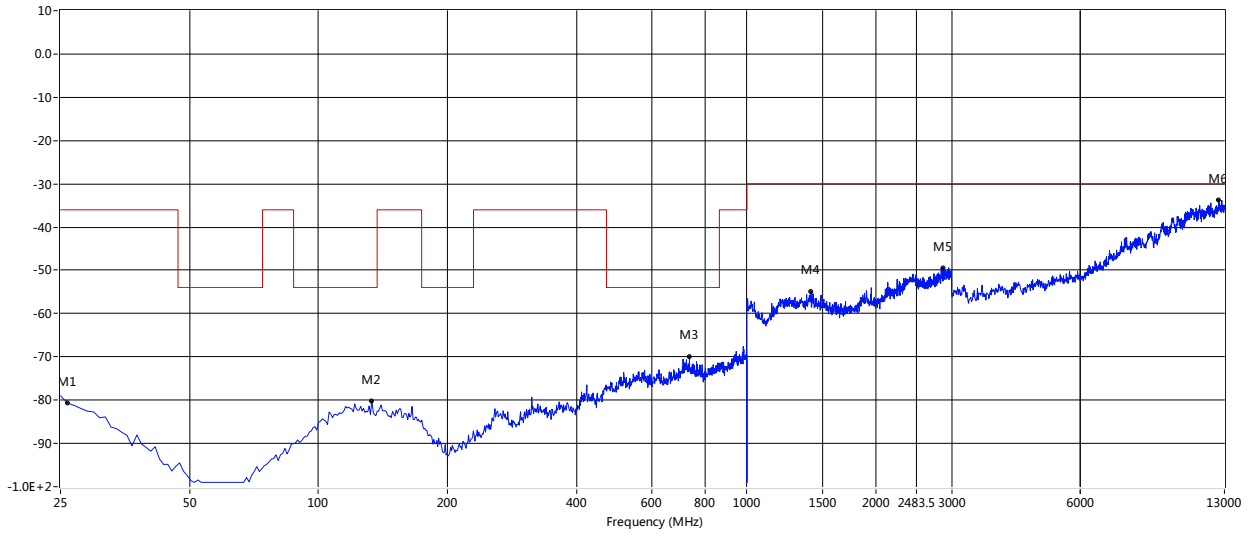

Frequency (MHz)	Result (dBm)	Factor (dB)	PK Limit (dBm)	Over Limit (dB)	Table (o)	ANT	EUT	Verdict
25.975	-80.63	-1.09	-36.0	-44.63	5.00	Vertical	Vertical	Pass
133.225	-80.16	-1.40	-54.0	-26.16	10.00	Vertical	Vertical	Pass
733.825	-69.98	7.87	-54.0	-15.98	8.00	Vertical	Vertical	Pass
1410.000	-54.84	13.75	-30.0	-24.84	5.00	Vertical	Vertical	Pass
2868.000	-49.34	20.11	-30.0	-19.34	6.00	Vertical	Vertical	Pass
12610.000	-33.63	23.36	-30.0	-3.63	10.00	Vertical	Vertical	Pass



Mid channel
Horizontal

RSE-EN RX-TX TEST Case_EN300442_EN300 442-TX_25M-13G_H

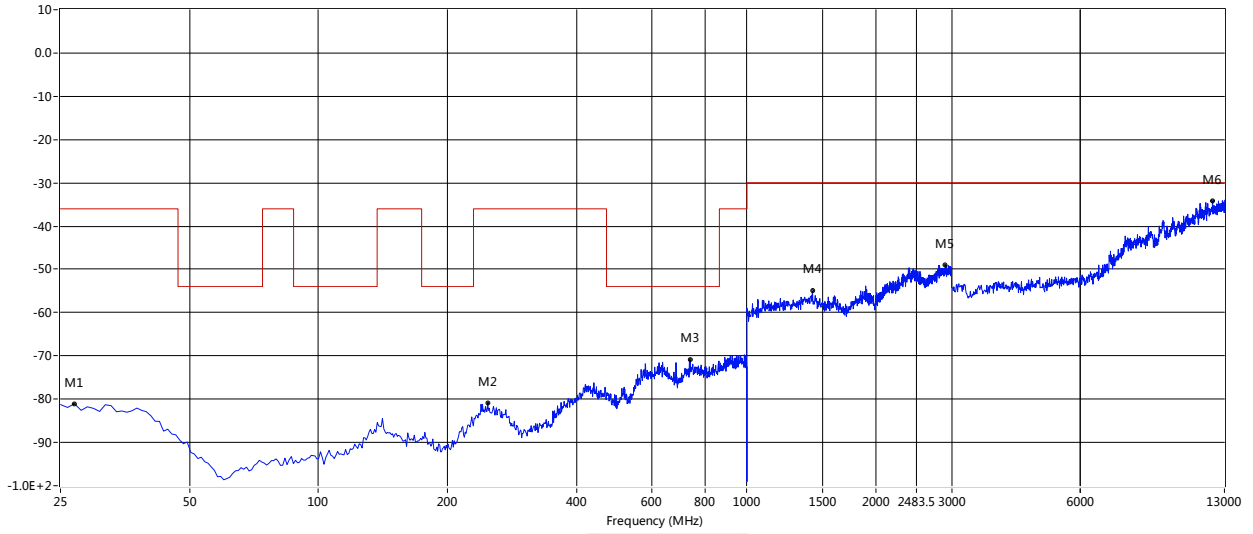

Frequency (MHz)	Result (dBm)	Factor (dB)	PK Limit (dBm)	Over Limit (dB)	Table (o)	ANT	EUT	Verdict
26.950	-81.08	-1.94	-36.0	-45.08	8.00	Horizontal	Vertical	Pass
248.275	-80.86	-1.08	-36.0	-44.86	5.00	Horizontal	Vertical	Pass
736.750	-70.86	6.93	-54.0	-16.86	8.00	Horizontal	Vertical	Pass
1420.000	-55.00	13.87	-30.0	-25.00	2.00	Horizontal	Vertical	Pass
2902.000	-49.03	20.66	-30.0	-19.03	8.00	Horizontal	Vertical	Pass
12199.999	-34.16	22.67	-30.0	-4.16	7.00	Horizontal	Vertical	Pass



Vertical

RSE-EN RX-TX TEST Case_EN300442_EN300 442-TX_25M-13G_V

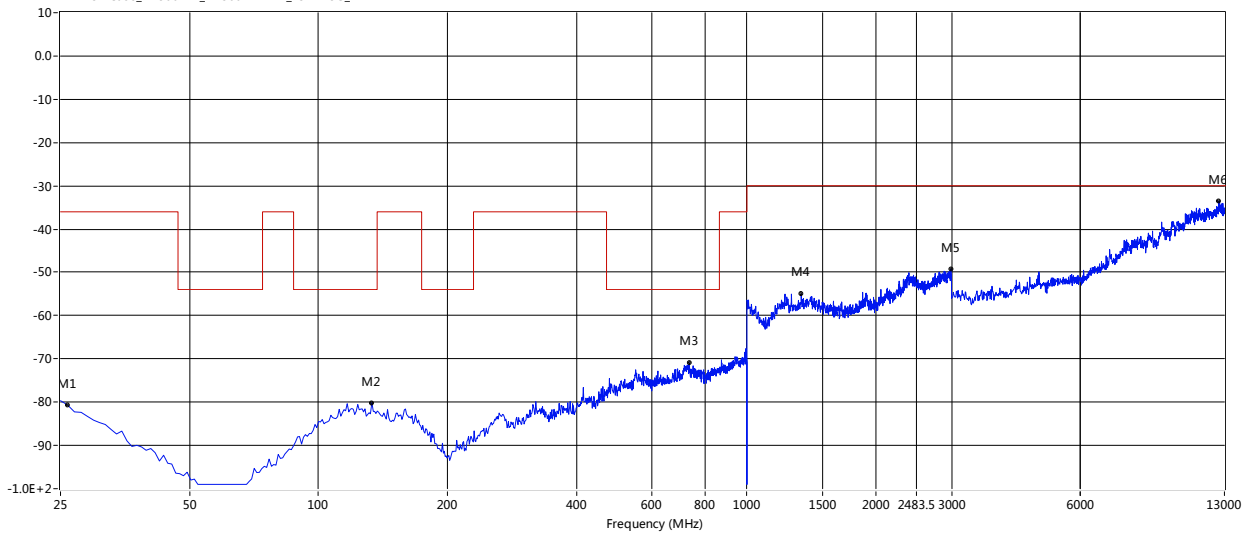

Frequency (MHz)	Result (dBm)	Factor (dB)	PK Limit (dBm)	Over Limit (dB)	Table (o)	ANT	EUT	Verdict
25.975	-80.63	-1.09	-36.0	-44.63	5.00	Vertical	Vertical	Pass
133.225	-80.08	-1.40	-54.0	-26.08	7.00	Vertical	Vertical	Pass
733.825	-70.91	7.87	-54.0	-16.91	2.00	Vertical	Vertical	Pass
1338.000	-54.98	13.30	-30.0	-24.98	8.00	Vertical	Vertical	Pass
2990.000	-49.23	20.37	-30.0	-19.23	10.00	Vertical	Vertical	Pass
12620.000	-33.52	23.37	-30.0	-3.52	8.00	Vertical	Vertical	Pass



High channel
Horizontal

RSE-EN RX-TX TEST Case_EN300442_EN300 442-TX_25M-13G_H

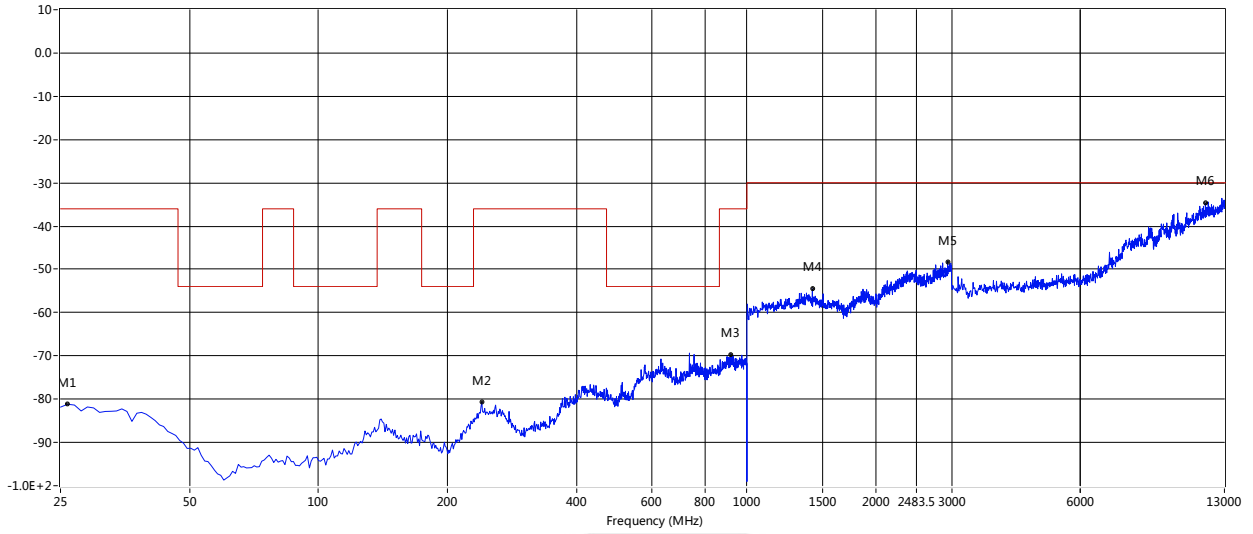

Frequency (MHz)	Result (dBm)	Factor (dB)	PK Limit (dBm)	Over Limit (dB)	Table (o)	ANT	EUT	Verdict
25.975	-81.17	-1.95	-36.0	-45.17	7.00	Horizontal	Vertical	Pass
240.475	-80.67	-0.79	-36.0	-44.67	4.00	Horizontal	Vertical	Pass
915.175	-69.70	9.41	-36.0	-33.70	9.00	Horizontal	Vertical	Pass
1420.000	-54.49	13.87	-30.0	-24.49	10.00	Horizontal	Vertical	Pass
2938.000	-48.20	20.90	-30.0	-18.20	0.00	Horizontal	Vertical	Pass
11740.000	-34.74	22.09	-30.0	-4.74	7.00	Horizontal	Vertical	Pass



Vertical

RSE-EN RX-TX TEST Case_EN300442_EN300 442-TX_25M-13G_V

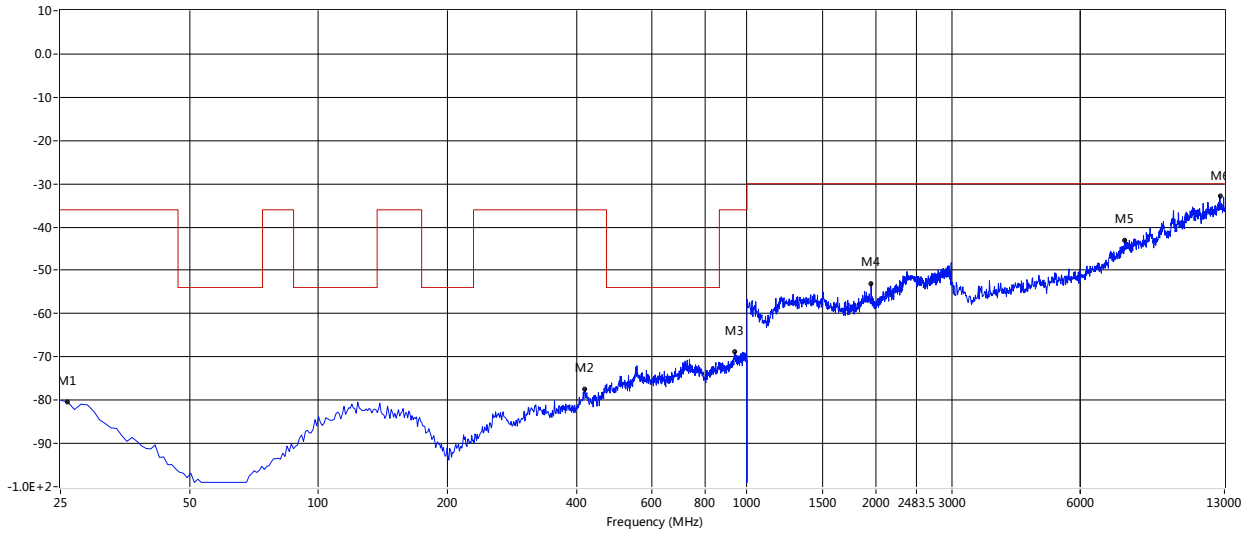

Frequency (MHz)	Result (dBm)	Factor (dB)	PK Limit (dBm)	Over Limit (dB)	Table (o)	ANT	EUT	Verdict
25.975	-80.40	-1.09	-36.0	-44.40	5.00	Vertical	Vertical	Pass
418.900	-77.47	1.68	-36.0	-41.47	4.00	Vertical	Vertical	Pass
934.675	-68.91	9.85	-36.0	-32.91	4.00	Vertical	Vertical	Pass
1946.000	-52.99	13.39	-30.0	-22.99	1.00	Vertical	Vertical	Pass
7610.000	-43.13	14.23	-30.0	-13.13	4.00	Vertical	Vertical	Pass
12700.000	-32.92	23.39	-30.0	-2.92	9.00	Vertical	Vertical	Pass



Emission Mask I

Emission Mask Low Channel

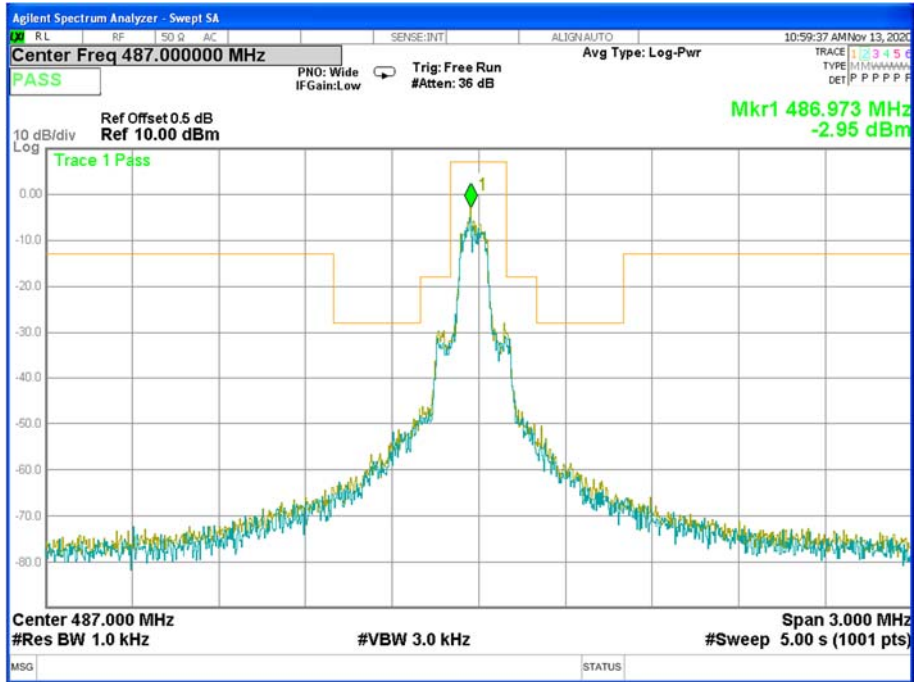

Emission Mask Mid Channel

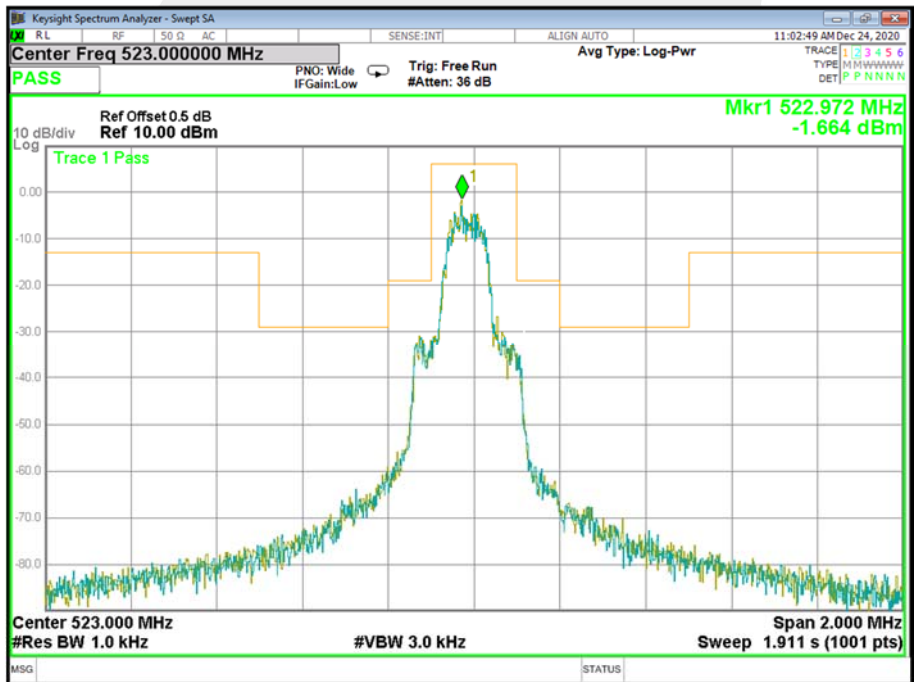



Emission Mask High Channel

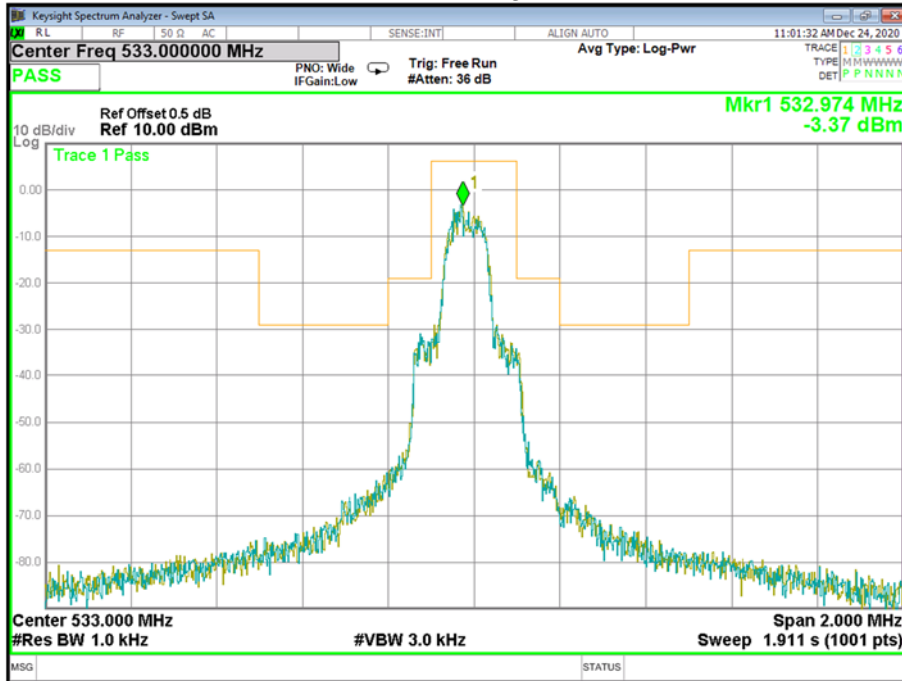



Emission Mask II

ETSI EN 300 422-1 Clause 8.3.1.2 The Maximum Measurement of Necessary Bandwidth Test Plot:

Frequency	Declared Bandwidth	B/2	0.35B
487 MHz	200K	100K	70K
523 MHz	200K	100K	70K
533 MHz	200K	100K	70K

Low CH

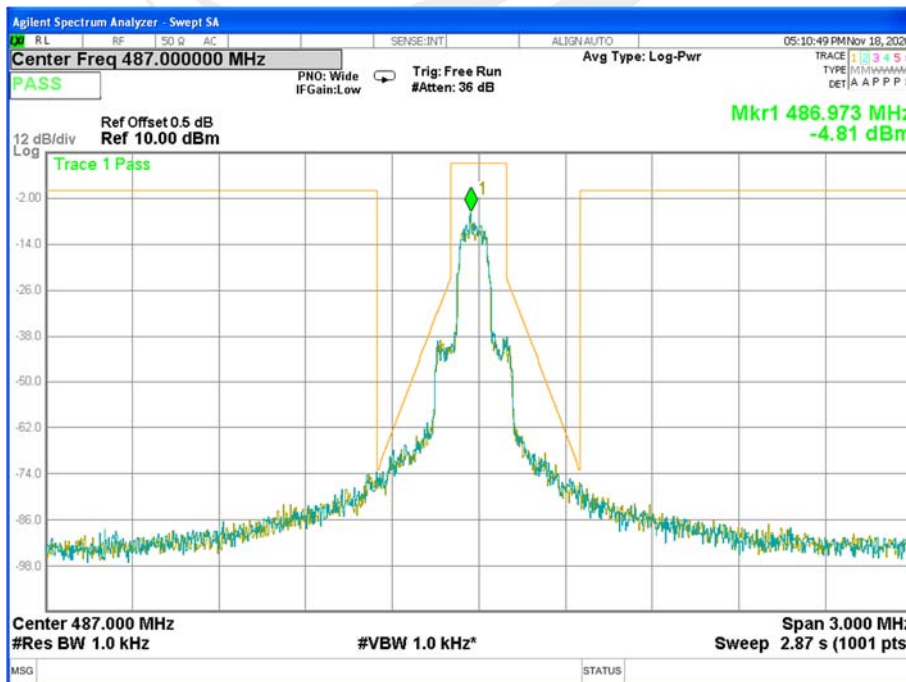
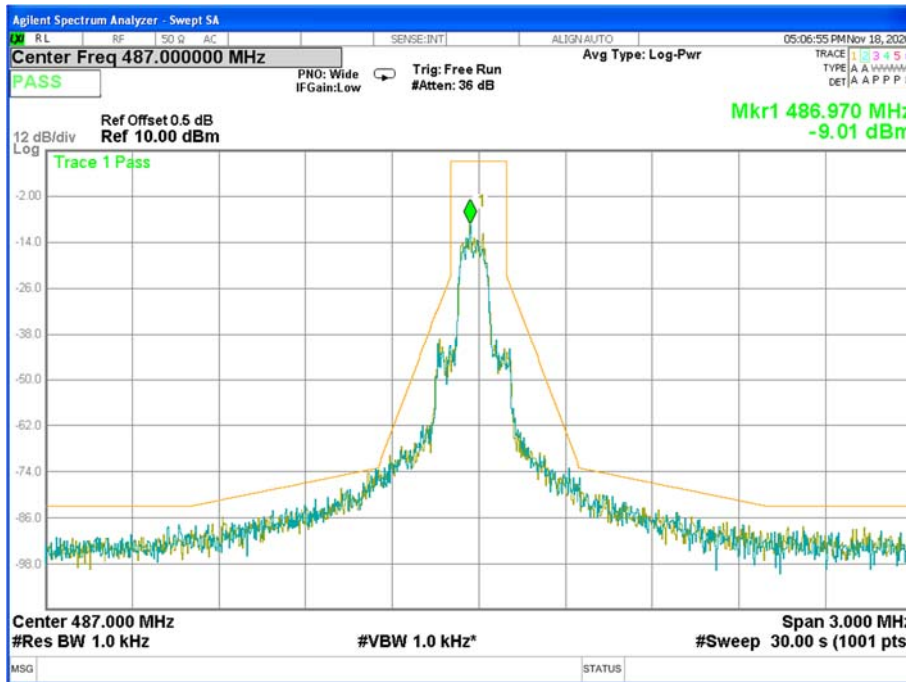



Mid CH

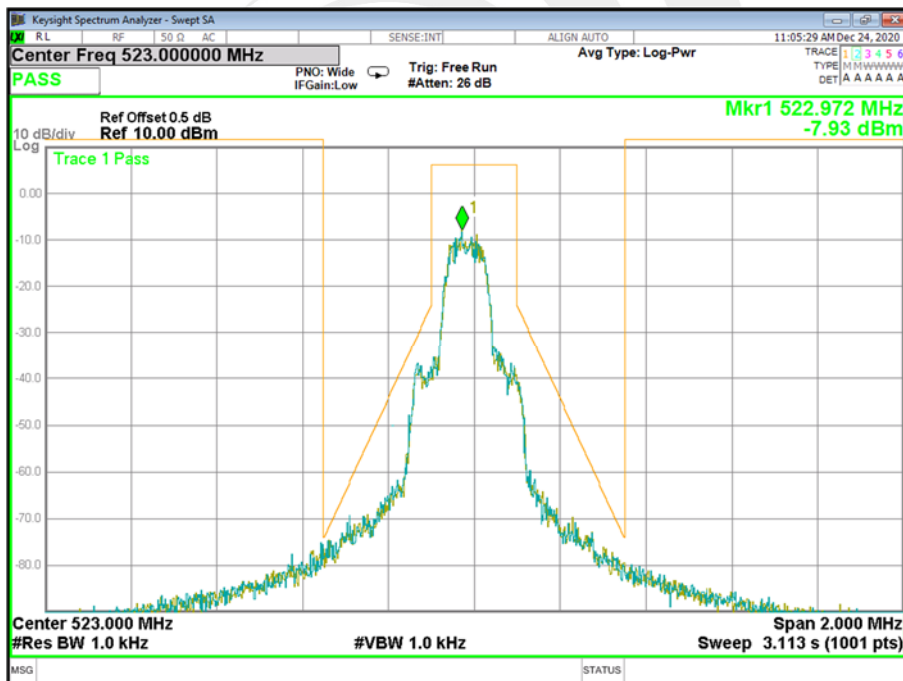
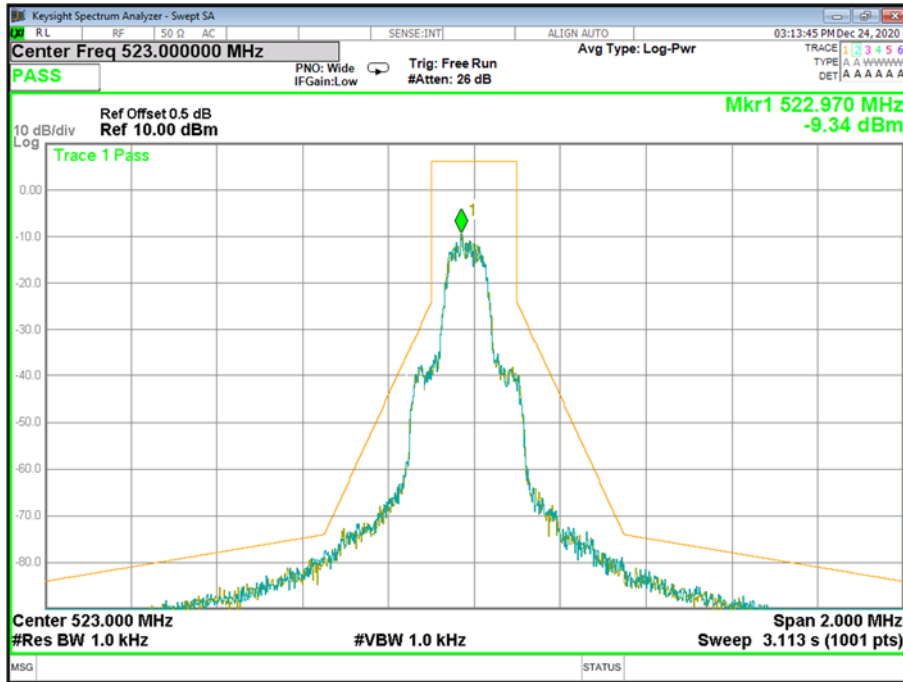



High CH

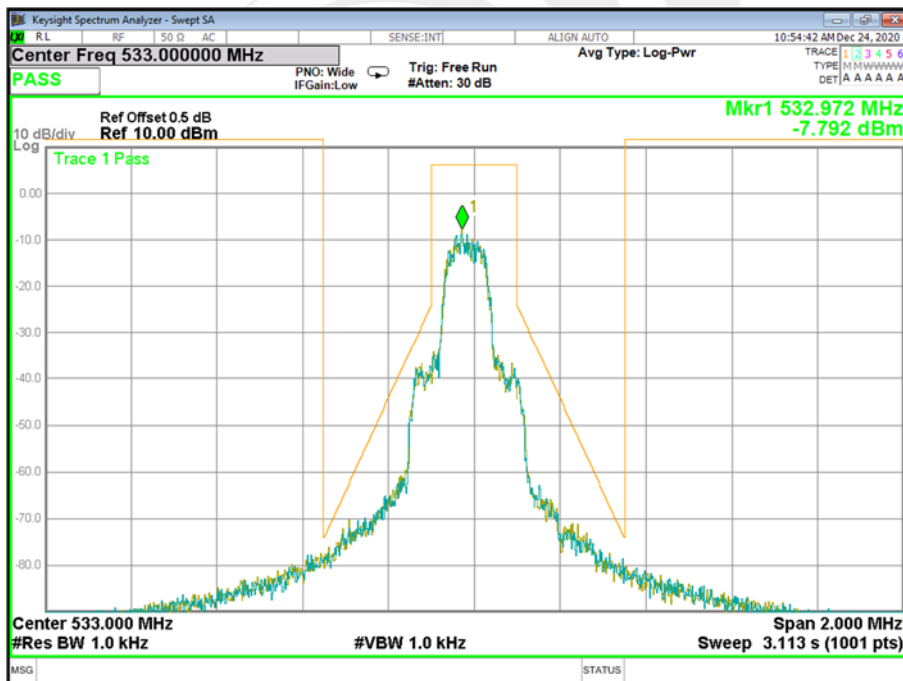
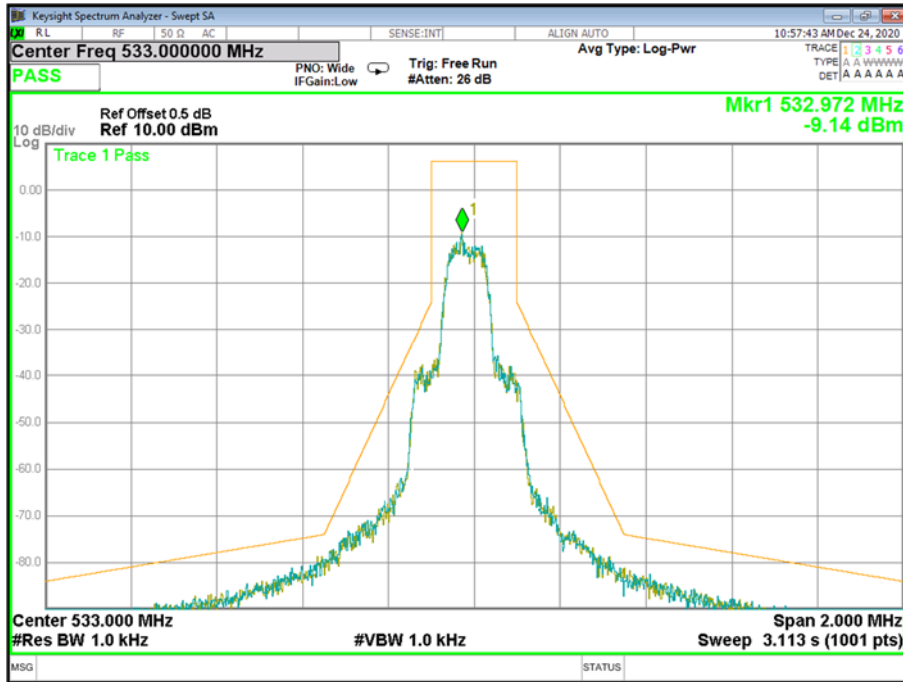

4.4 FREQUENCY STABILITY VS. TEMPERATURE & VOLTAGE

TEST LIMIT

According to CFR 47 section 74.861 e (4), the frequency tolerance of the transmitter shall be 0.005 percent.

TEST CONFIGURATION

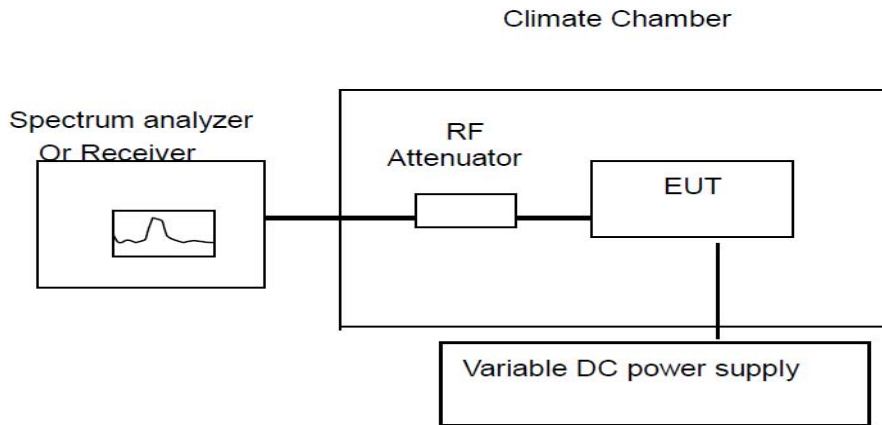

TEST PROCEDURE

The EUT was connected to an external DC power supply and the RF output was connected to a frequency counter via feed through attenuators. The EUT was placed inside the temperature chamber. The DC leads and the RF output cable, exited the chamber through an opening made for that purpose.

After the temperature stabilized the frequency output was recorded from the counter.

An external variable DC power supply was connected to the battery terminals of the equipment under test.

- b. For hand carried, battery powered equipment primary supply voltage was reduced to the battery operating end point as specified by the manufacturer. The output frequency was recorded for each battery voltage.



TEST RESULTS

- (1) Frequency stability versus input voltage (Supply Nominal voltage is DC 3.7V)
- (2) Frequency stability versus input voltage (Supply battery operating end point which shall be specified by the manufacturer DC 4.07V)

Reference Frequency: 487MHz			
Power Supply	Environment Temperature (°C)	Frequency Error (Hz)	Frequency Error (%)
3.33V, DC	20	17357	0.003564
3.70V, DC	20	17250	0.003542
4.07V, DC	20	17529	0.003599
BEP	20	17687	0.003632

Reference Frequency: 487MHz				
Environment Temperature(°C)	Frequency Deviation measured with time Elapse(30 minutes)			
	Frequency Error (Hz)	Frequency Error (%)	Limit (%)	Results
50	17358	0.003564	0.00500	PASS
40	17351	0.003563		
30	17357	0.003564		
20	17250	0.003542		
10	17152	0.003522		
0	17157	0.003523		
-10	17152	0.003522		
-20	17151	0.003522		
-30	17150	0.003522		



Reference Frequency: 523MHz			
Power Supply	Environment Temperature (°C)	Frequency Error (Hz)	Frequency Error (%)
3.33V, DC	20	1141	0.000218
3.70V, DC	20	1149	0.000220
4.07V, DC	20	1152	0.000220
BEP	20	1139	0.000218

Reference Frequency: 523MHz				
Environment Temperature(°C)	Frequency Deviation measured with time Elapse(30 minutes)			
	Frequency Error (Hz)	Frequency Error (%)	Limit (%)	Results
50	1137	0.000217	0.00500	PASS
40	1140	0.000218		
30	1142	0.000218		
20	1146	0.000219		
10	1142	0.000218		
0	1152	0.000220		
-10	1144	0.000219		
-20	1146	0.000219		
-30	1143	0.000219		



Reference Frequency: 533MHz			
Power Supply	Environment Temperature (°C)	Frequency Error (Hz)	Frequency Error (%)
3.33V, DC	20	2656	0.000498
3.70V, DC	20	2653	0.000498
4.07V, DC	20	2648	0.000497
BEP	20	2657	0.000498

Reference Frequency: 533MHz				
Environment Temperature(°C)	Frequency Deviation measured with time Elapse(30 minutes)			
	Frequency Error (Hz)	Frequency Error (%)	Limit (%)	Results
50	2665	0.000500	0.00500	PASS
40	2653	0.000498		
30	2652	0.000498		
20	2664	0.000500		
10	2654	0.000498		
0	2655	0.000498		
-10	2645	0.000496		
-20	2654	0.000498		
-30	2658	0.000499		

4.5 OCCUPIED BANDWIDTH

TEST LIMIT

According to CFR 47 section 74.861 e (5), the operating bandwidth shall no exceed 200 KHz.
Near the carrier an emission mask is defined by the standard.

TEST CONFIGURATION



TEST PROCEDURE

- a. The RF output of the transceiver was connected to the input of the spectrum analyzer through sufficient attenuation.
Set Occupied Bandwidth was measured with a occupied bandwidth function of the analyzer.
- b. The near the carrier emissions are measured by normal power measurement function of the analyzer.
- c. Set SPA Max hold. Mark peak, 99%.

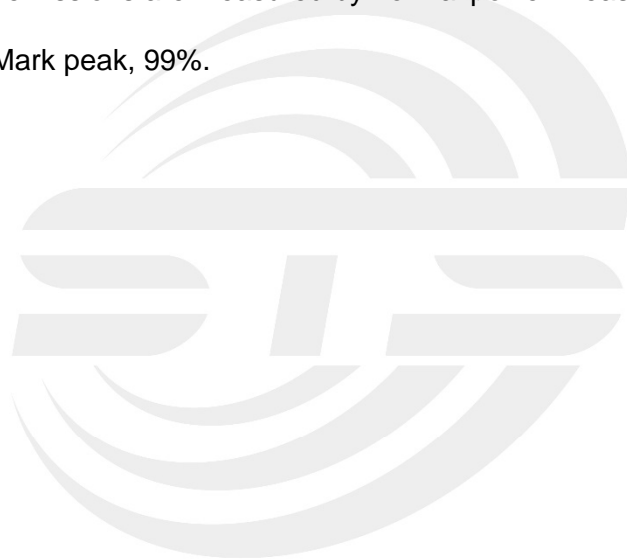



TEST RESULT

Frequency(MHz)	Occupied Bandwidth(KHz)	Limit(KHz)
487	173.12	200
523	110.24	200
533	109.82	200

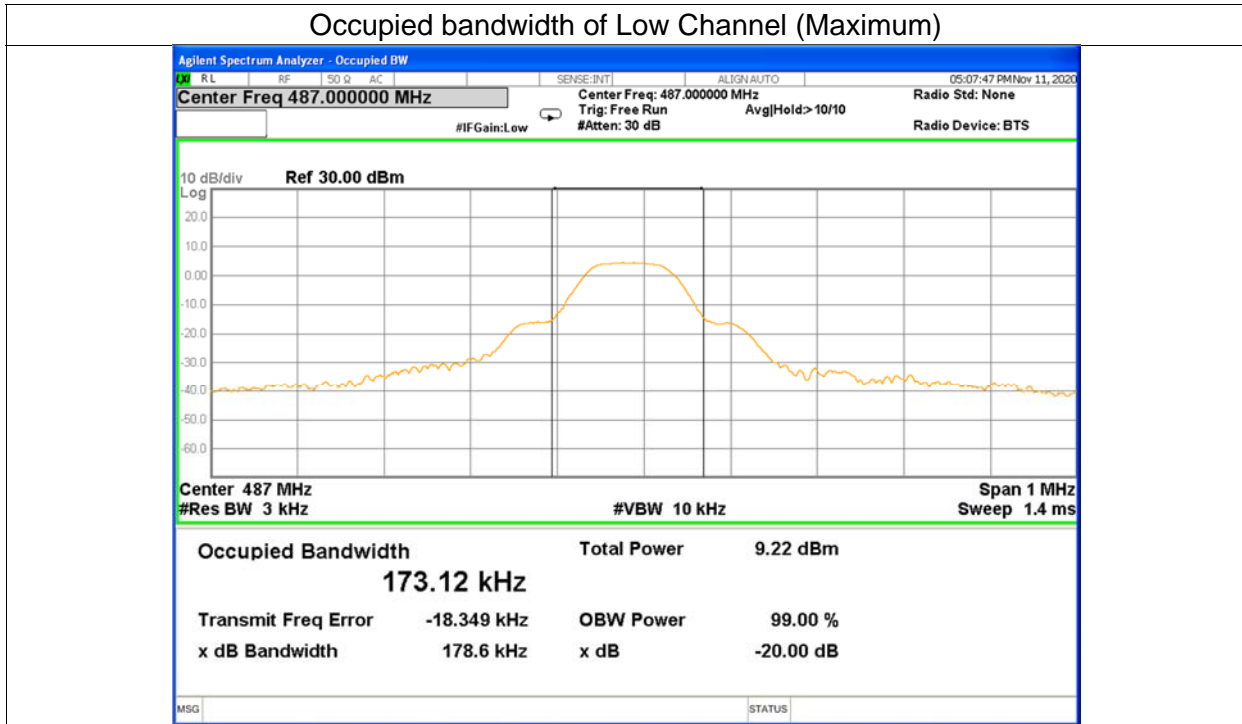



Occupied bandwidth of Mid Channel (Maximum)

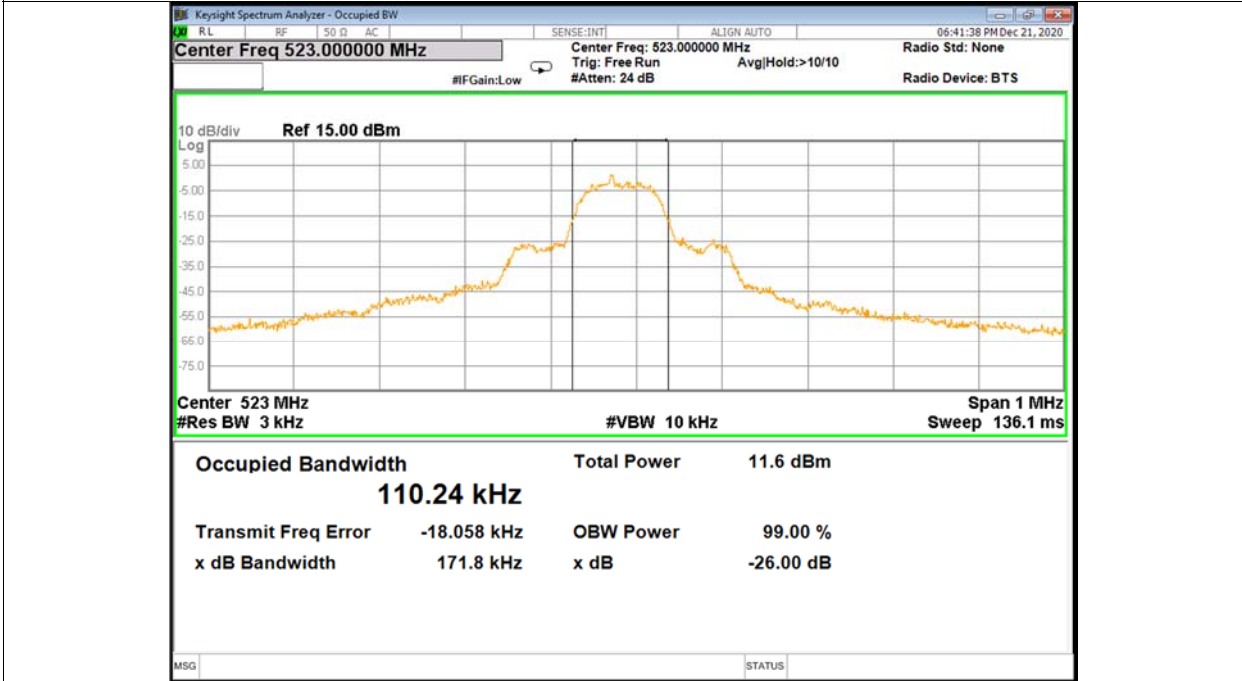

Occupied bandwidth of High Channel (Maximum)

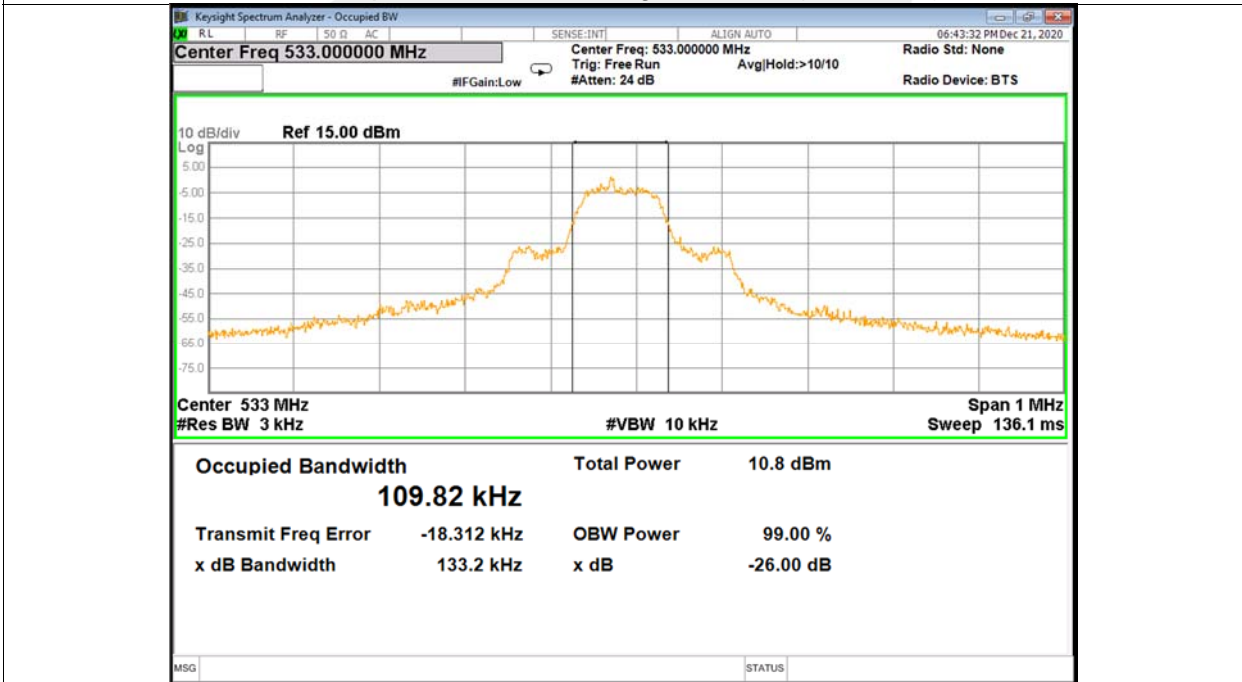

4.6 AUDIO FREQUENCY RESPONSE

TEST LIMIT

The audio frequency response is the degree of closeness to which the frequency deviation of the transmitter follows a prescribed characteristic. The frequency response of the audio modulation part is measured over a frequency range of 100 Hz to 5000 Hz.

According to CFR 47 section 74.861 e (1), any form of modulation may be used. A maximum deviation of ± 75 KHz is permitted when frequency modulation is employed.

TEST CONFIGURATION

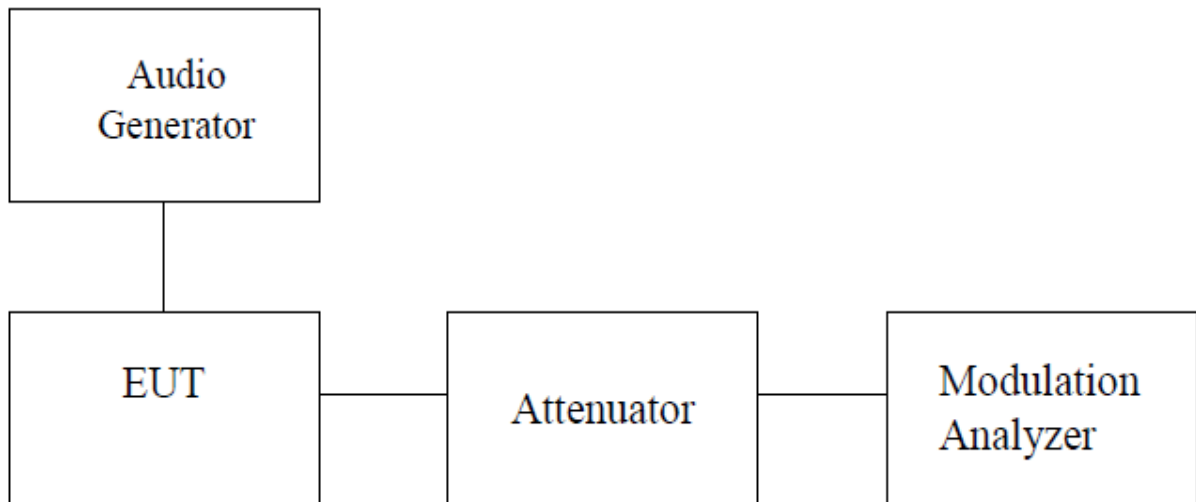

TEST PROCEDURE

- a. The audio frequency response is the degree of the closeness to which the frequency deviation of the transmitter follows prescribed characteristics.
- b. The frequency response of the audio modulation part is measured over a frequency range of 100Hz to 5000 Hz.
- c. For 1000 Hz tone reference signal the audio generator level is adjusted to get 20% of the rated system deviation.
The deviations obtained over the frequency range from 100 HZ to 5000 Hz are recorded and
- d. compared with the reference deviation as follows:
Audio Frequency Response= $20 \log (\text{DEV freq/ Dev ref})$



TEST RESULT

Audio Frequency Response:

Frequency(KHz)	Deviation(KHz)
0.01	14.89
1	16.05
2	17.00
3	18.05
4	19.61
5	20.80

Frequency Response of Mid Channel

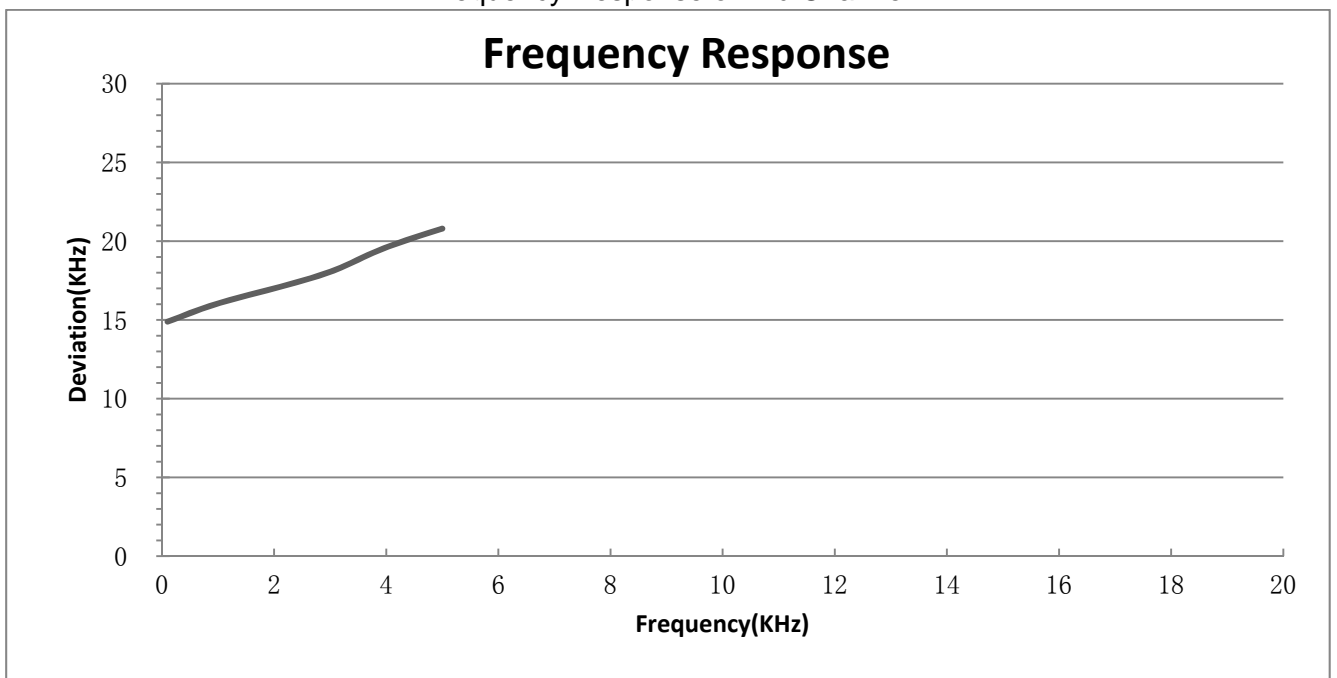

4.7 MODULATION DEVIATION

TEST LIMIT

According to CFR 47 section 2.1047 a, for Voice modulation communication equipment, the frequency response of the audio modulation circuit over a range of 100 to 5000 Hz shall be measured.

According to CFR 47 section 74.861 e (3), any form of modulation may be used. A maximum deviation of ± 75 KHz is permitted when frequency modulation is employed.

TEST CONFIGURATION

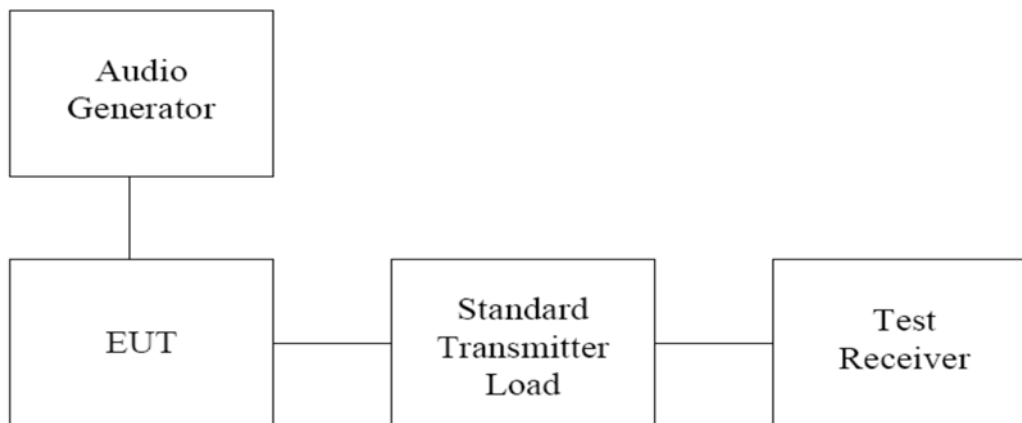

TEST PROCEDURE

- a. Modulation limits is the transmitter circuit's ability to limit the transmitter from producing deviations in excess of rated system deviation.
- b. The audio signal generator is connected to the audio input of the EUT with its full rating.
- c. The modulation response is measured at certain modulation frequencies, related to 1000 Hz reference signal.
- d. Tests are performed for positive and negative modulation.



TEST RESULT

Modulation Deviation

Level(mv)	100Hz	500Hz	1kHz	2.5kHz	5kHz
0	8.23	6.12	6.59	7.08	7.56
10	14.53	12.49	12.94	13.40	13.88
20	22.97	20.85	21.33	21.78	22.19
30	31.21	27.05	28.47	29.18	29.91
40	31.16	29.03	29.49	30.96	31.39
50	31.11	29.11	29.54	30.03	30.43
60	31.16	29.15	29.62	30.06	30.54
70	31.23	29.04	29.45	29.91	30.39
80	31.26	29.15	29.58	30.05	30.49
90	31.17	29.01	29.49	29.97	30.39
100	31.25	29.12	29.54	30.03	30.46
110	31.22	29.18	29.59	30.08	30.55

Modulation Deviation of Mid Channel

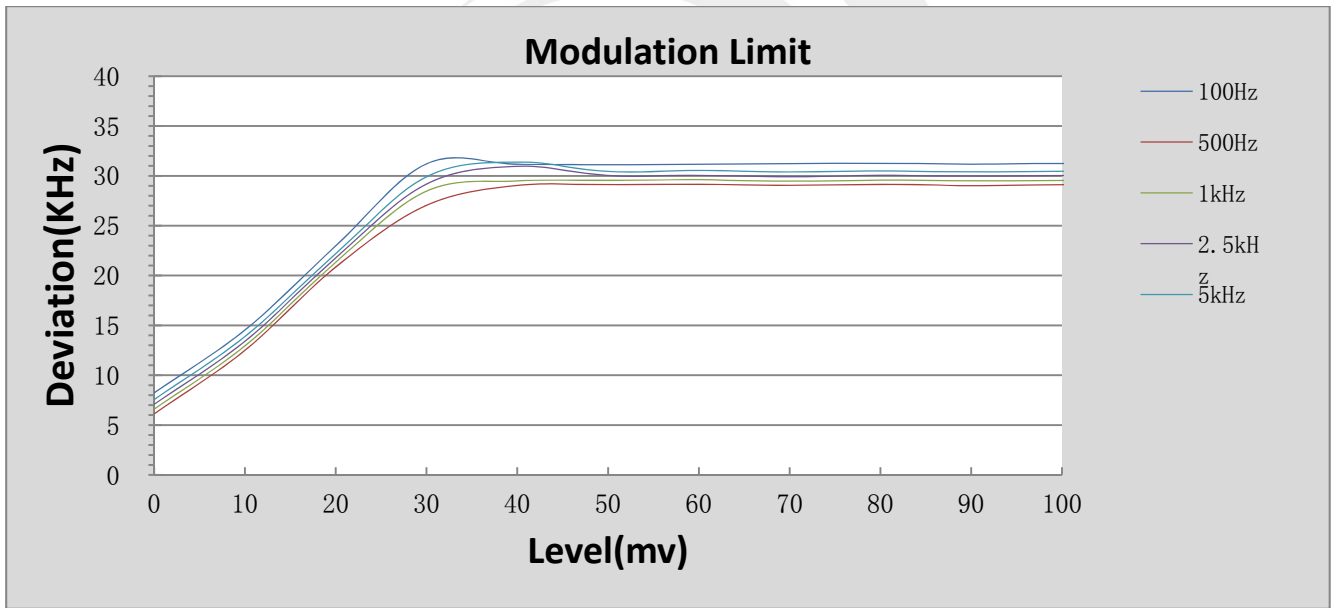

4.8 RF OUTPUT POWER

TEST LIMIT

According to CFR 47 section 74.861 e (1), the power of the measured unmodulated carrier power at the output of the transmitter power amplifier (antenna input power) may not exceed the following:

- (i) 54-72, 76-88, and 174-216 MHz bands: 50 mW EIRP
- (ii) 470-608 and 614-698: 250 mW conducted power
- (iii) 600 MHz duplex gap: 20 mW EIRP

TEST CONFIGURATION

Conduction



TEST PROCEDURE (Conduction)

- a. The RF output of the transceiver was connected to the input of the spectrum analyzer through sufficient attenuation.
- b. Set the RBW $>20BW$, VBW $>3xRBW$.
- c. Detector = peak.
- d. Sweep time = auto couple.
- e. Trace mode = max hold.
- f. Allow trace to fully stabilize.
- g. Use the peak marker function to determine the maximum amplitude level.



TEST RESULT

Frequency Channel (MHz)	Peak Output Power (dBm)	Transmitter Power (mW)	Limits (mW)
487	6.088	4.063	250
523	5.66	3.681	250
533	5.45	3.508	250

Low Channel





Mid Channel

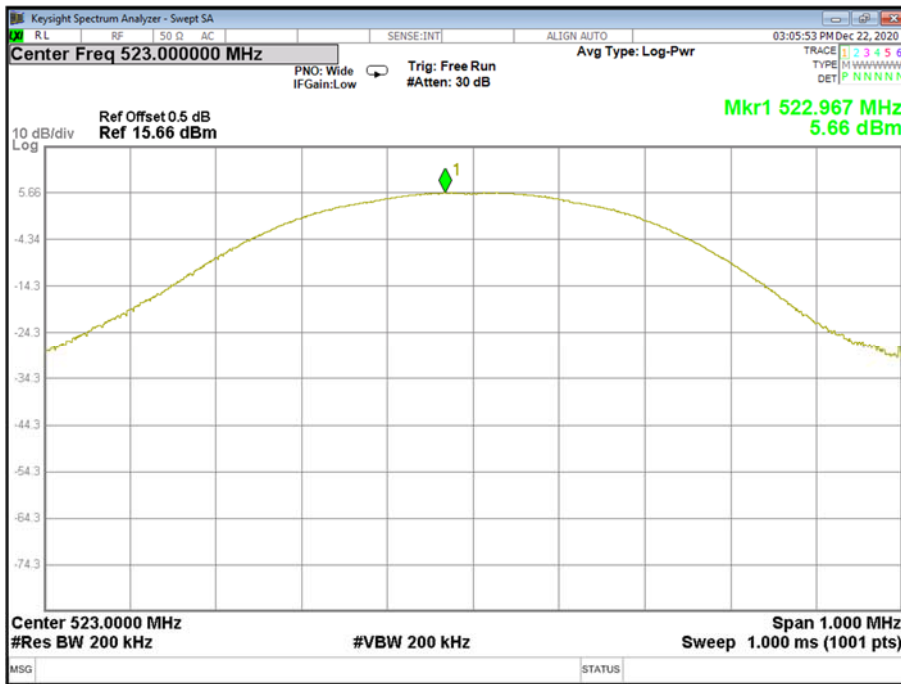

High Channel

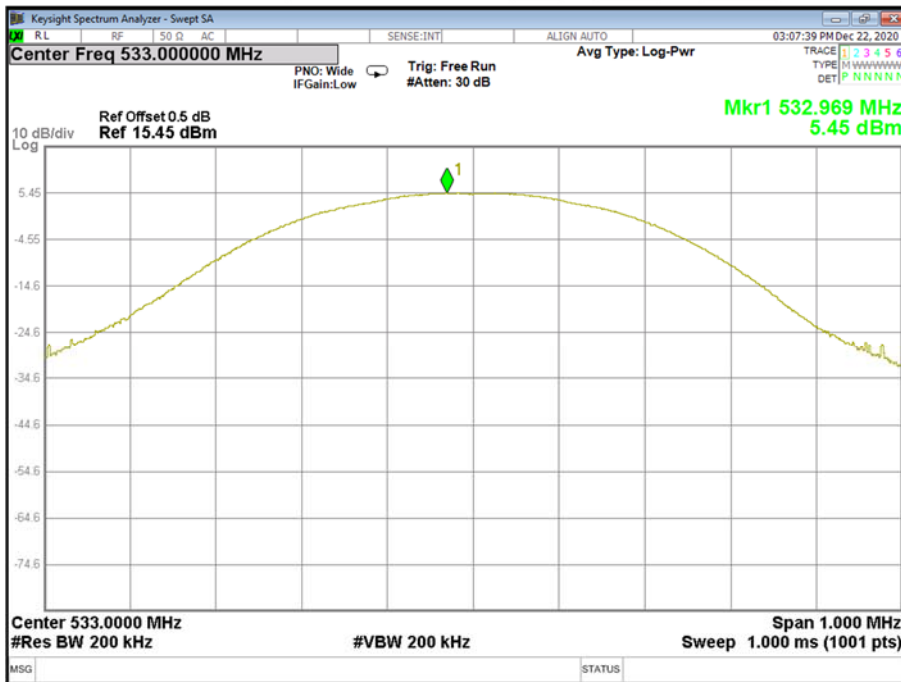



PHOTOS OF TEST SETUP

Note: See test photos in setup photo document for the actual connections between Product and support equipment.

※※※※※END OF THE REPORT※※※※※

