

RADIO TEST REPORT

FCC ID: 2AX5VMCPRNA1

Product: Manual call point
Trade Mark: AJAX
Model No.: MCP.R.J-000-NA
Family Model: N/A
Report No.: S23082102702001
Issue Date: Aug 31, 2023

Prepared for

AJAX SYSTEMS CYPRUS HOLDINGS LTD
Ifigeneias, 17, Strovolos, 2007, Nicosia, Cyprus

Prepared by

Shenzhen NTEK Testing Technology Co., Ltd.
1/F, Building E, Fenda Science Park, Sanwei Community,
Xixiang Street Bao'an District, Shenzhen 518126 P.R. China
Tel. 400-800-6106, 0755-2320 0050, 0755-2320 0090
Website: <http://www.ntek.org.cn>

TABLE OF CONTENTS

1	TEST RESULT CERTIFICATION	3
2	SUMMARY OF TEST RESULTS.....	4
3	FACILITIES AND ACCREDITATIONS	5
3.1	FACILITIES.....	5
3.2	LABORATORY ACCREDITATIONS AND LISTINGS	5
3.3	MEASUREMENT UNCERTAINTY	5
4	GENERAL DESCRIPTION OF EUT	6
5	DESCRIPTION OF TEST MODES	8
6	SETUP OF EQUIPMENT UNDER TEST	10
6.1	BLOCK DIAGRAM CONFIGURATION OF TEST SYSTEM.....	10
6.2	SUPPORT EQUIPMENT.....	11
6.3	EQUIPMENTS LIST FOR ALL TEST ITEMS.....	12
7	TEST REQUIREMENTS.....	13
7.1	CONDUCTED EMISSIONS TEST	13
7.2	RADIATED SPURIOUS EMISSION	15
7.3	NUMBER OF HOPPING CHANNEL.....	24
7.4	HOPPING CHANNEL SEPARATION MEASUREMENT	26
7.5	AVERAGE TIME OF OCCUPANCY (DWELL TIME)	29
7.6	20DB BANDWIDTH TEST	32
7.7	PEAK OUTPUT POWER.....	34
7.8	CONDUCTED BAND EDGE MEASUREMENT.....	36
7.9	SPURIOUS RF CONDUCTED EMISSION.....	38

1 TEST RESULT CERTIFICATION

Applicant's name	AJAX SYSTEMS CYPRUS HOLDINGS LTD
Address	Ifigeneias, 17, Strovolos, 2007, Nicosia, Cyprus
Manufacturer's Name	"AJAX SYSTEMS MANUFACTURING" LIMITED LIABILITY COMPANY
Address	Sklyarenka, 5, Kyiv, 04073, Ukraine
Factory (1)	"AJAX SYSTEMS MANUFACTURING" LIMITED LIABILITY COMPANY
Address	Sklyarenka, 5, Kyiv, 04073, Ukraine
Factory (2)	"AJAX TURKEY ELEKTRONİK TİCARET" ANONİM ŞİRKETİ
Address	Aydınlı Sb Mah. 4.Sk. Desbaş 6 Blok No: 4 İc Kapi No: Z01 Tuzla / Istanbul
Product description	
Product name	Manual call point
Model and/or type reference	MCP.R.J-000-NA
Family Model	N/A
Test Sample Number.....	S230821027002

Measurement Procedure Used:

APPLICABLE STANDARDS	
STANDARD/ TEST PROCEDURE	TEST RESULT
FCC 47 CFR Part 2, Subpart J FCC 47 CFR Part 15, Subpart C KDB558074 D01 15.247 Meas Guidance v05r02 ANSI C63.10-2013	Complied

This device described above has been tested by Shenzhen NTEK Testing Technology Co., Ltd., and the test results show that the equipment under test (EUT) is in compliance with the FCC requirements. And it is applicable only to the tested sample identified in the report.

This report shall not be reproduced except in full, without the written approval of Shenzhen NTEK Testing Technology Co., Ltd., this document may be altered or revised by Shenzhen NTEK Testing Technology Co., Ltd., personnel only, and shall be noted in the revision of the document.

The test results of this report relate only to the tested sample identified in this report.

Date of Test : Aug 21, 2023~ Aug 31, 2023

Testing Engineer : *Gavan Zhang*
(Gavan Zhang)

Authorized Signatory : *Alex*
(Alex Li)

2 SUMMARY OF TEST RESULTS

FCC Part15 (15.247), Subpart C			
Standard Section	Test Item	Verdict	Remark
15.207	Conducted Emission	N/A	
15.209 (a) 15.205 (a)	Radiated Spurious Emission	PASS	
15.247(a)(1)	Hopping Channel Separation	PASS	
15.247(b)(2)	Peak Output Power	PASS	
15.247(a)(i)	Number of Hopping Frequency	PASS	
15.247(a)(i)	Dwell Time	PASS	
15.247(a)(1)	Bandwidth	PASS	
15.247 (d)	Band Edge Emission	PASS	
15.247 (d)	Spurious RF Conducted Emission	PASS	
15.203	Antenna Requirement	PASS	

Remark:

1. "N/A" denotes test is not applicable in this Test Report.
2. All test items were verified and recorded according to the standards and without any deviation during the test.

3 FACILITIES AND ACCREDITATIONS

3.1 FACILITIES

All measurement facilities used to collect the measurement data are located at 1/F, Building E, Fenda Science Park, Sanwei Community, Xixiang Street, Bao'an District, Shenzhen 518126 P.R. China.

The sites are constructed in conformance with the requirements of ANSI C63.7, ANSI C63.10 and CISPR Publication 22.

3.2 LABORATORY ACCREDITATIONS AND LISTINGS

Site Description

CNAS-Lab. : The Certificate Registration Number is L5516.

IC-Registration : The Certificate Registration Number is 9270A.

CAB identifier:CN0074

FCC- Accredited : Test Firm Registration Number: 463705.

Designation Number: CN1184

A2LA-Lab. : The Certificate Registration Number is 4298.01

This laboratory is accredited in accordance with the recognized International Standard ISO/IEC 17025:2005 General requirements for the competence of testing and calibration laboratories.

This accreditation demonstrates technical competence for a defined scope and the operation of a laboratory quality management system (refer to joint ISO-ILAC-IAF Communiqué dated 8 January 2009).

Name of Firm : Shenzhen NTEK Testing Technology Co., Ltd.

Site Location : 1/F, Building E, Fenda Science Park, Sanwei Community, Xixiang Street, Bao'an District, Shenzhen 518126 P.R. China.

3.3 MEASUREMENT UNCERTAINTY

The reported uncertainty of measurement $y \pm U$, where expanded uncertainty U is based on a standard uncertainty multiplied by a coverage factor of $k=2$, providing a level of confidence of approximately 95 %.

No.	Item	Uncertainty
1	Conducted Emission Test	$\pm 2.80\text{dB}$
2	RF power, conducted	$\pm 0.16\text{dB}$
3	Spurious emissions, conducted	$\pm 0.21\text{dB}$
4	All emissions, radiated(30MHz~1GHz)	$\pm 2.64\text{dB}$
5	All emissions, radiated(1GHz~6GHz)	$\pm 2.40\text{dB}$
6	All emissions, radiated(>6GHz)	$\pm 2.52\text{dB}$
7	Temperature	$\pm 0.5^\circ\text{C}$
8	Humidity	$\pm 2\%$

4 GENERAL DESCRIPTION OF EUT

Product Feature and Specification	
Equipment	Manual call point
Trade Mark	
FCC ID	2AX5VMCPRNA1
Model No.	MCP.R.J-000-NA
Family Model	N/A
Model Difference	N/A
Operating Frequency	905 MHz~926.5MHz
Modulation	GFSK
Number of Channels	103 Channels
Antenna Type	F-type antenna
Antenna Gain	-1.2 dBi
Battery	DC 3V, 1600mAh
Power supply	DC 3V from battery * 2pcs
HW Version	EMP.001.MBR.001v7
FW Version	NA
SW Version	5.59

Note: Based on the application, features, or specification exhibited in User's Manual, the EUT is considered as an ITE/Computing Device. More details of EUT technical specification, please refer to the User's Manual.

5 DESCRIPTION OF TEST MODES

To investigate the maximum EMI emission characteristics generates from EUT, the test system was pre-scanning tested base on the consideration of following EUT operation mode or test configuration mode which possible have effect on EMI emission level. Each of these EUT operation mode(s) or test configuration mode(s) mentioned above was evaluated respectively.

The Transmitter was operated in the normal operating mode. The TX frequency was fixed which was for the purpose of the measurements.

Test of channel included the lowest and middle and highest frequency to perform the test, then record on this report.

The EUT was pretested with 3 orientations placed on the table for the radiated emission measurement –X, Y, and Z-plane. The X-plane results were found as the worst case and were shown in this report.

Carrier Frequency and Channel list:

Channel	Frequency (MHz)	Channel	Frequency (MHz)	Channel	Frequency (MHz)
1	905	36	912.65	71	919.65
2	905.85	37	912.85	72	919.85
3	906.05	38	913.05	73	920.05
4	906.25	39	913.25	74	920.25
5	906.45	40	913.45	75	920.45
6	906.65	41	913.65	76	920.65
7	906.85	42	913.85	77	920.85
8	907.05	43	914.05	78	921.05
9	907.25	44	914.25	79	921.25
10	907.45	45	914.45	80	921.45
11	907.65	46	914.65	81	921.65
12	907.85	47	914.85	82	921.85
13	908.05	48	915.05	83	922.05
14	908.25	49	915.25	84	922.25
15	908.45	50	915.45	85	922.45
16	908.65	51	915.65	86	922.65
17	908.85	52	915.85	87	922.85
18	909.05	53	916.05	88	923.05
19	909.25	54	916.25	89	923.25
20	909.45	55	916.45	90	923.45
21	909.65	56	916.65	91	923.65
22	909.85	57	916.85	92	923.85
23	910.05	58	917.05	93	924.05
24	910.25	59	917.25	94	924.25
25	910.45	60	917.45	95	924.45
26	910.65	61	917.65	96	924.65
27	910.85	62	917.85	97	924.85
28	911.05	63	918.05	98	925.05
29	911.25	64	918.25	99	925.25
30	911.45	65	918.45	100	925.45
31	911.65	66	918.65	101	925.65
32	911.85	67	918.85	102	925.85
33	912.05	68	919.05	103	926.50
34	912.25	69	919.25		
35	912.45	70	919.45		

The following summary table is showing all test modes to demonstrate in compliance with the standard.

For Radiated Test Cases	
Final Test Mode	Description
Mode 1	normal link mode
Mode 2	CH01(905MHz)
Mode 3	CH52(915.85MHz)
Mode 4	CH103(926.50MHz)

Note: For radiated test cases, the worst mode data rate 1Mbps was reported only, because this data rate has the highest RF output power at preliminary tests, and no other significantly frequencies found in conducted spurious emission.

For Conducted Test Cases	
Final Test Mode	Description
Mode 2	CH01(905MHz)
Mode 3	CH52(915.85MHz)
Mode 4	CH103(926.50MHz)
Mode 5	Hopping mode

Note: The engineering test program was provided and the EUT was programmed to be in continuously transmitting mode.

6 SETUP OF EQUIPMENT UNDER TEST

6.1 BLOCK DIAGRAM CONFIGURATION OF TEST SYSTEM

For Radiated Test Cases

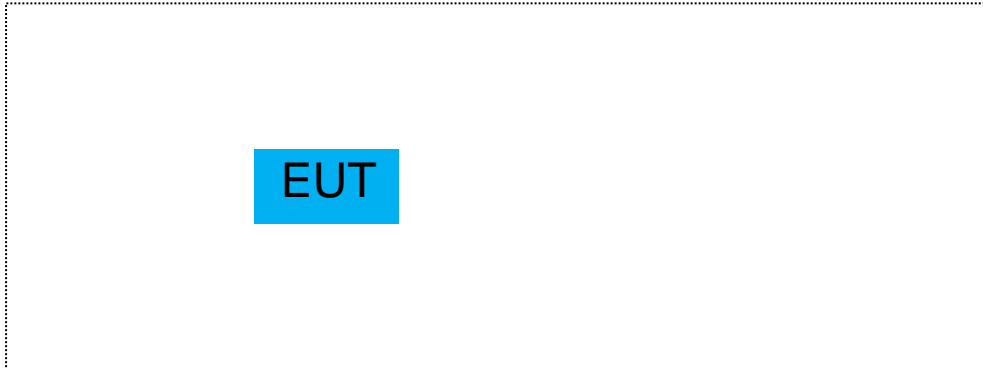

For Conducted Test Cases

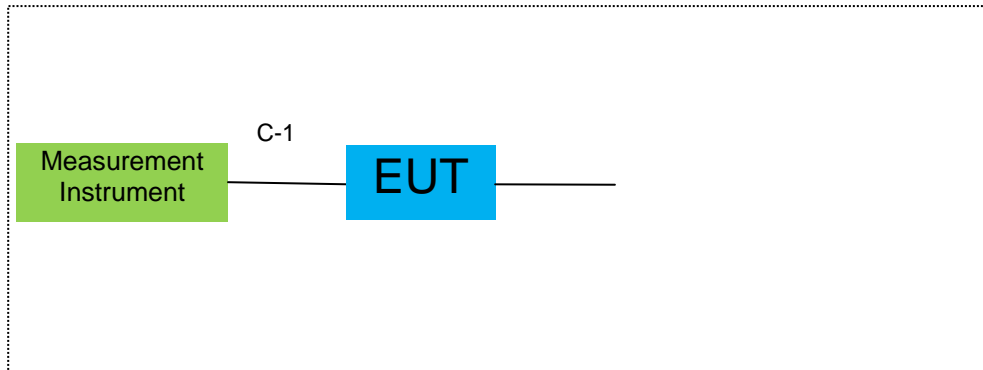

Note: 1. The temporary antenna connector is soldered on the PCB board in order to perform conducted tests and this temporary antenna connector is listed in the equipment list.

6.2 SUPPORT EQUIPMENT

The EUT has been tested as an independent unit together with other necessary accessories or support units. The following support units or accessories were used to form a representative test configuration during the tests.

Item	Equipment	Model/Type No.	Series No.	Note
EUT	Manual call point	MCP.R.J-000-NA	N/A	

Item	Cable Type	Shielded Type	Ferrite Core	Length
C-1	RF Cable	YES	NO	0.1m

Notes:

- (1) The support equipment was authorized by Declaration of Confirmation.
- (2) For detachable type I/O cable should be specified the length in cm in 『Length』 column.
- (3) “YES” is means “shielded” “with core”; “NO” is means “unshielded” “without core”.

6.3 EQUIPMENTS LIST FOR ALL TEST ITEMS

Radiation& Conducted Test equipment

Item	Kind of Equipment	Manufacturer	Type No.	Serial No.	Last calibration	Calibrated until	Calibration period
1	Spectrum Analyzer	Agilent	E4440A	MY41000130	2023.03.27	2024.03.26	1 year
2	Spectrum Analyzer	Agilent	N9020A	MY49100060	2023.05.29	2024.05.28	1 year
3	Spectrum Analyzer	R&S	FSV40	101417	2023.05.29	2024.05.28	1 year
4	Test Receiver	R&S	ESPI7	101318	2023.03.27	2024.03.26	1 year
5	Bilog Antenna	TESEQ	CBL6111D	31216	2023.03.16	2024.03.15	1 year
6	50Ω Coaxial Switch	Anritsu	MP59B	6200983705	2023.05.06	2026.05.05	3 year
7	Horn Antenna	SCHWARZBECK	BBHA 9120 D	2816	2023.01.12	2024.01.11	1 year
8	Broadband Horn Antenna	SCHWARZBECK	BBHA 9170	803	2022.11.07	2023.11.06	1 year
9	Amplifier	EMC	EMC051835 SE	980246	2023.05.29	2024.05.28	1 year
10	Active Loop Antenna	SCHWARZBECK	FMZB 1519 B	055	2023.05.29	2024.05.28	1 year
11	Power Meter	DARE	RPR3006W	15I00041SN O84	2023.05.29	2024.05.28	1 year
12	Test Cable (9KHz-30MHz)	N/A	R-01	N/A	2022.06.17	2025.06.16	3 year
13	Test Cable (30MHz-1GHz)	N/A	R-02	N/A	2022.06.17	2025.06.16	3 year
14	High Test Cable(1G-40GHz)	N/A	R-03	N/A	2022.06.17	2025.06.16	3 year
15	Filter	TRILTHIC	2400MHz	29	2023.03.26	2026.03.25	3 year
16	temporary antenna connector (Note)	NTS	R001	N/A	N/A	N/A	N/A

Note:

We will use the temporary antenna connector (soldered on the PCB board) When conducted test
And this temporary antenna connector is listed within the instrument list

7 TEST REQUIREMENTS

7.1 CONDUCTED EMISSIONS TEST

7.1.1 Applicable Standard

According to FCC Part 15.207(a)

7.1.2 Conformance Limit

Frequency(MHz)	Conducted Emission Limit	
	Quasi-peak	Average
0.15-0.5	66-56*	56-46*
0.5-5.0	56	46
5.0-30.0	60	50

Note: 1. *Decreases with the logarithm of the frequency
 2. The lower limit shall apply at the transition frequencies
 3. The limit decreases in line with the logarithm of the frequency in the range of 0.15 to 0.50MHz.

7.1.3 Measuring Instruments

The Measuring equipment is listed in the section 6.3 of this test report.

7.1.4 Test Configuration

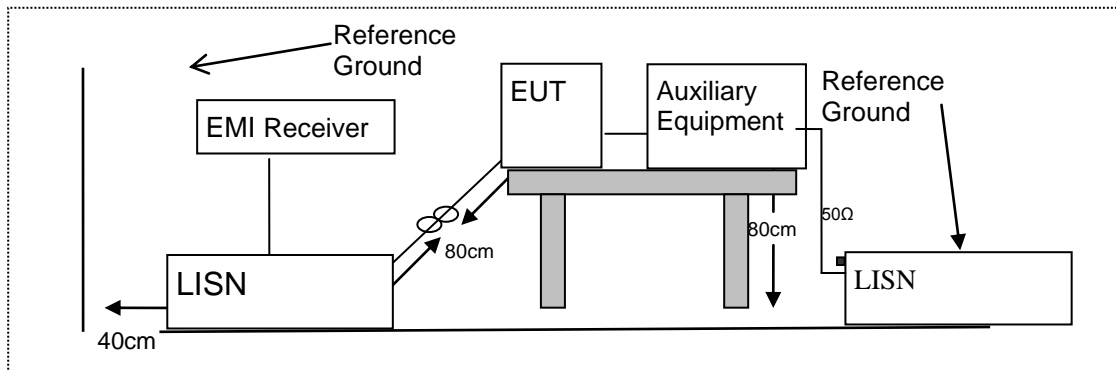

7.1.5 Test Procedure

According to the requirements in Section 13.1.4.1 of ANSI C63.10-2013 Conducted emissions the EUT measured in the frequency range between 0.15 MHz and 30 MHz using CISPR Quasi-Peak and average detector mode.

1. The EUT was placed 0.4 meter from the conducting wall of the shielding room.
2. The EUT was placed on a table which is 0.8m above ground plane.
3. Connect EUT to the power mains through a line impedance stabilization network (LISN). All other support equipments powered from additional LISN(s). The LISN provide 50 Ohm/ 50uH of coupling impedance for the measuring instrument.
4. Interconnecting cables that hang closer than 40 cm to the ground plane shall be folded back and forth in the center forming a bundle 30 to 40cm long.
5. I/O cables that are not connected to a peripheral shall be bundled in the center. The end of the cable may be terminated, if required, using the correct terminating impedance. The overall length shall not exceed 1 m.
6. LISN at least 80 cm from nearest part of EUT chassis.
7. The frequency range from 150KHz to 30MHz was searched.
8. Set the test-receiver system to Peak Detect Function and specified bandwidth(IF bandwidth=9KHz) with Maximum Hold Mode
9. For the actual test configuration, please refer to the related Item –EUT Test Photos.

7.1.6 Test Results

EUT:	Manual call point	Model Name :	MCP.R.J-000-NA
Temperature:	26 °C	Relative Humidity:	54%
Pressure:	1010hPa	Phase :	N/A
Test Voltage :	N/A	Test Mode:	N/A

Note: The EUT is powered by battery, so this item is not applicable

7.2 RADIATED SPURIOUS EMISSION

7.2.1 Applicable Standard

According to FCC Part 15.247(d) and 15.209 and ANSI C63.10-2013

7.2.2 Conformance Limit

According to FCC Part 15.247(d): radiated emissions which fall in the restricted bands, as defined in §15.205(a), must also comply with the radiated emission limits specified in §15.209(a) (see §15.205(c)).
According to FCC Part 15.205, Restricted bands

MHz	MHz	MHz	GHz
0.090-0.110	16.42-16.423	399.9-410	4.5-5.15
0.495-0.505	16.69475-16.69525	608-614	5.35-5.46
2.1735-2.1905	16.80425-16.80475	960-1240	7.25-7.75
4.125-4.128	25.5-25.67	1300-1427	8.025-8.5
4.17725-4.17775	37.5-38.25	1435-1626.5	9.0-9.2
4.20725-4.20775	73-74.6	1645.5-1646.5	9.3-9.5
6.215-6.218	74.8-75.2	1660-1710	10.6-12.7
6.26775-6.26825	123-138	2200-2300	14.47-14.5
8.291-8.294	149.9-150.05	2310-2390	15.35-16.2
8.362-8.366	156.52475-156.52525	2483.5-2500	17.7-21.4
8.37625-8.38675	156.7-156.9	2690-2900	22.01-23.12
8.41425-8.41475	162.0125-167.17	3260-3267	23.6-24.0
12.29-12.293	167.72-173.2	3332-3339	31.2-31.8
12.51975-12.52025	240-285	3345.8-3358	36.43-36.5
12.57675-12.57725	322-335.4	3600-4400	(2)
13.36-13.41			

20dBc in any 100 kHz bandwidth outside the operating frequency band. In case the emission fall within the restricted band specified on 15.205(a), then the 15.209(a) limit in the table below has to be followed.

Restricted Frequency(MHz)	Field Strength (μV/m)	Field Strength (dBμV/m)	Measurement Distance
0.009~0.490	2400/F(KHz)	20 log (uV/m)	300
0.490~1.705	24000/F(KHz)	20 log (uV/m)	30
1.705~30.0	30	29.5	30
30-88	100	40	3
88-216	150	43.5	3
216-960	200	46	3
Above 960	500	54	3

Limits of Radiated Emission Measurement(Above 1000MHz)

Frequency(MHz)	Class B (dBuV/m) (at 3M)	
	PEAK	AVERAGE
Above 1000	74	54

Remark : 1. Emission level in dBuV/m=20 log (uV/m)
 2. Measurement was performed at an antenna to the closed point of EUT distance of meters.
 3. For Frequency 9kHz~30MHz:
 Distance extrapolation factor =40log(Specific distance/ test distance)(dB);
 Limit line=Specific limits(dBuV) + distance extrapolation factor.
 For Frequency above 30MHz:
 Distance extrapolation factor =20log(Specific distance/ test distance)(dB);
 Limit line=Specific limits(dBuV) + distance extrapolation factor.

7.2.3 Measuring Instruments

The Measuring equipment is listed in the section 6.3 of this test report.

7.2.4 Test Configuration

(a) For radiated emissions below 30MHz

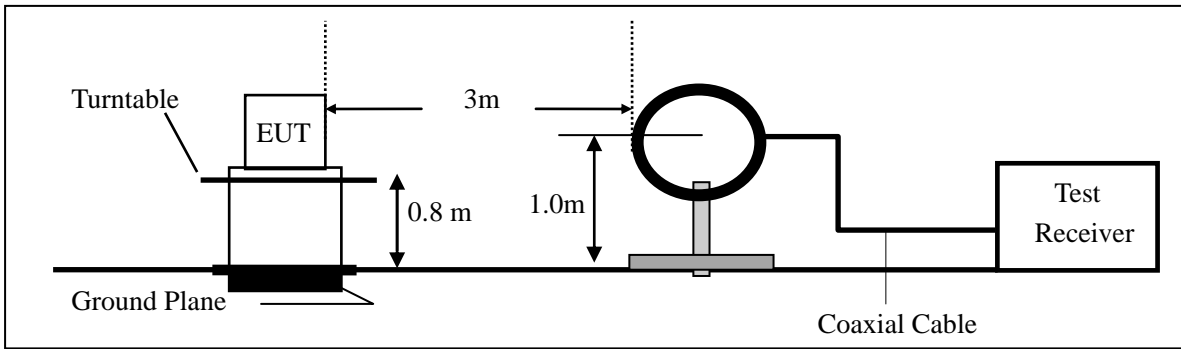

(b) For radiated emissions from 30MHz to 1000MHz

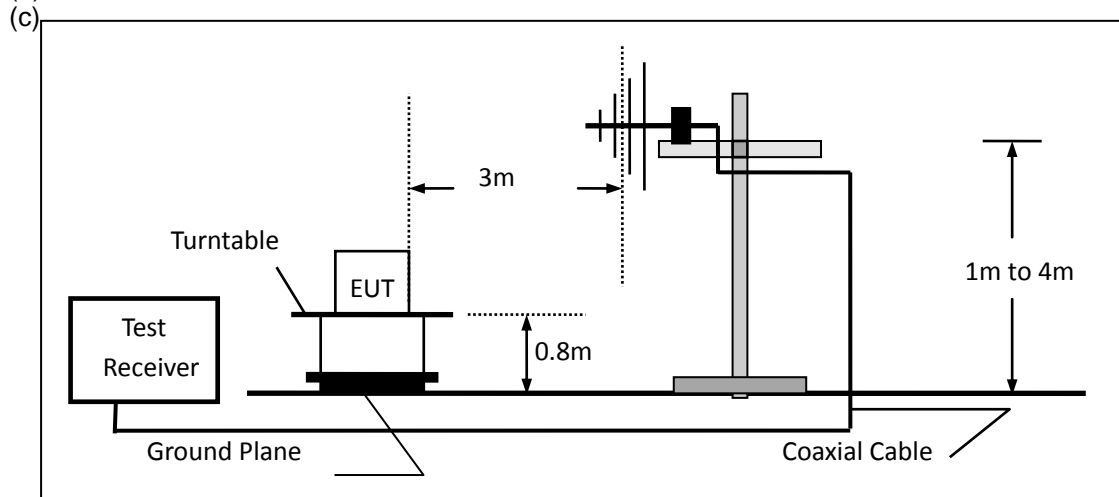

(c) For radiated emissions above 1000MHz

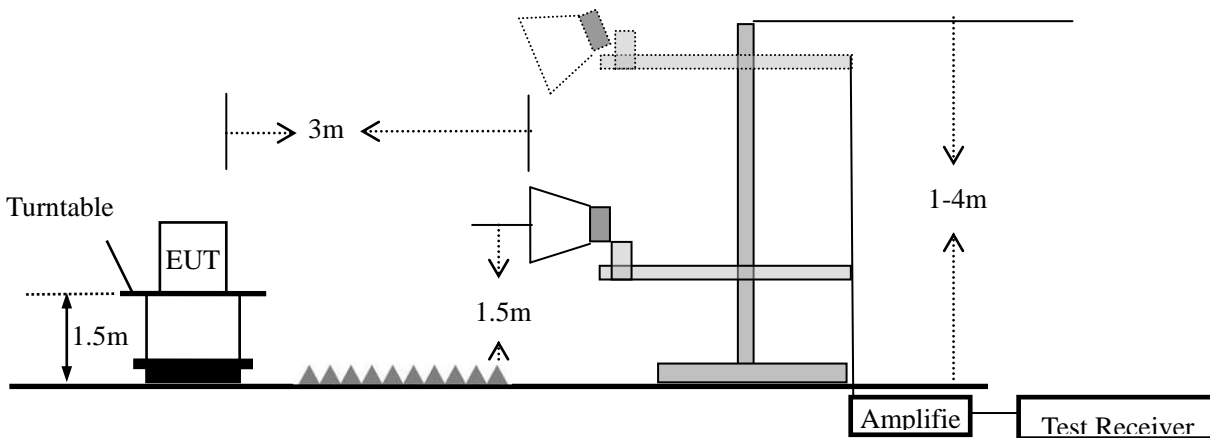

7.2.5 Test Procedure

The test site semi-anechoic chamber has met the requirement of NSA tolerance 4 dB according to the standards: ANSI C63.10-2013. The test distance is 3m. The setup is according to the requirements in Section 13.1.4.1 of ANSI C63.10-2013 and CAN/CSA-CEI/IEC CISPR 22.

This test is required for any spurious emission that falls in a Restricted Band, as defined in Section 15.205. It must be performed with the highest gain of each type of antenna proposed for use with the EUT.

Use the following spectrum analyzer settings:

Spectrum Parameter	Setting
Attenuation	Auto
Start Frequency	1000 MHz
Stop Frequency	10th carrier harmonic
RB / VB (emission in restricted band)	1 MHz / 1 MHz for Peak, 1 MHz / 10Hz for Average

Receiver Parameter	Setting
Attenuation	Auto
Start ~ Stop Frequency	9kHz~150kHz / RB 200Hz for QP
Start ~ Stop Frequency	150kHz~30MHz / RB 9kHz for QP
Start ~ Stop Frequency	30MHz~1000MHz / RB 120kHz for QP

- a. The measuring distance of at 3 m shall be used for measurements at frequency up to 1GHz. For frequencies above 1GHz, any suitable measuring distance may be used.
- b. The EUT was placed on the top of a rotating table 0.8 m for below 1GHz and 1.5m for above 1GHz the ground at a 3 meter. The table was rotated 360 degrees to determine the position of the highest radiation.
- c. The height of the equipment or of the substitution antenna shall be 0.8 m for below 1GHz and 1.5m for above 1GHz; the height of the test antenna shall vary between 1 m to 4 m. Both horizontal and vertical polarizations of the antenna are set to make the measurement.
- d. For the radiated emission test above 1GHz:
Place the measurement antenna away from each area of the EUT determined to be a source of emissions at the specified measurement distance, while keeping the measurement antenna aimed at the source of emissions at each frequency of significant emissions, with polarization oriented for maximum response. The measurement antenna may have to be higher or lower than the EUT, depending on the radiation pattern of the emission and staying aimed at the emission source for receiving the maximum signal. The final measurement antenna elevation shall be that which maximizes the emissions. The measurement antenna elevation for maximum emissions shall be restricted to a range of heights of from 1 m to 4 m above the ground or reference ground plane.
- e. The initial step in collecting conducted emission data is a spectrum analyzer peak detector mode pre-scanning the measurement frequency range. Significant peaks are then marked and then Quasi Peak detector mode re-measured.
- f. If the Peak Mode measured value compliance with and lower than Quasi Peak Mode Limit, the EUT shall be deemed to meet QP Limits and then no additional QP Mode measurement performed.
- g. For the actual test configuration, please refer to the related Item –EUT Test Photos.

Note:

Both horizontal and vertical antenna polarities were tested and performed pretest to three orthogonal axis. The worst case emissions were reported

During the radiated emission test, the Spectrum Analyzer was set with the following configurations:

Frequency Band (MHz)	Function	Resolution bandwidth	Video Bandwidth
30 to 1000	QP	120 kHz	300 kHz
Above 1000	Peak	1 MHz	1 MHz
	Average	1 MHz	10 Hz

Note: for the frequency ranges below 30 MHz, a narrower RBW is used for these ranges but the measured value should add a RBW correction factor (RBWCF) where $RBWCF [dB] = 10 \cdot \lg(100 [kHz] / \text{narrower RBW [kHz]})$. , the narrower RBW is 1 kHz and RBWCF is 20 dB for the frequency 9 kHz to 150 kHz, and the narrower RBW is 10 kHz and RBWCF is 10 dB for the frequency 150 kHz to 30 MHz.

7.2.6 Test Results

■ Spurious Emission below 30MHz (9KHz to 30MHz)

EUT:	Manual call point	Model No.:	MCP.R.J-000-NA
Temperature:	20 °C	Relative Humidity:	48%
Test Mode:	Mode2/Mode3/Mode4	Test By:	Gavan Zhang

Freq. (MHz)	Ant.Pol. H/V	Emission Level(dBuV/m)		Limit 3m(dBuV/m)		Over(dB)	
		PK	AV	PK	AV	PK	AV
--	--	--	--	--	--	--	--

Note: the amplitude of spurious emission that is attenuated by more than 20dB below the permissible limit has no need to be reported.

■ Spurious Emission below 1GHz (30MHz to 1GHz)

All the modulation modes have been tested, and the worst result was report as below:

EUT:	Manual call point	Model Name :	MCP.R.J-000-NA
Temperature:	23 °C	Relative Humidity:	54%
Pressure:	1010hPa	Test Mode:	Mode 2 GFSK OCW=120KHz
Test Voltage :	DC 3V		

All the modulation modes have been tested, and the worst result was report as below:

Polar (H/V)	Frequency	Meter Reading	Factor	Emission Level	Limits	Margin	Remark
	(MHz)	(dBuV)	(dB)	(dBuV/m)	(dBuV/m)	(dB)	
V	30.0000	4.79	26.47	31.26	40.00	-8.74	QP
V	35.1276	5.21	23.63	28.84	40.00	-11.16	QP
V	435.5898	6.47	23.92	30.39	46.00	-15.61	QP
V	564.6386	6.52	25.92	32.44	46.00	-13.56	QP
V	696.8567	7.66	27.90	35.56	46.00	-10.44	QP
V	875.2470	6.72	30.50	37.22	46.00	-8.78	QP

Remark:

Emission Level = Meter Reading + Factor, Margin= Emission Level - Limit

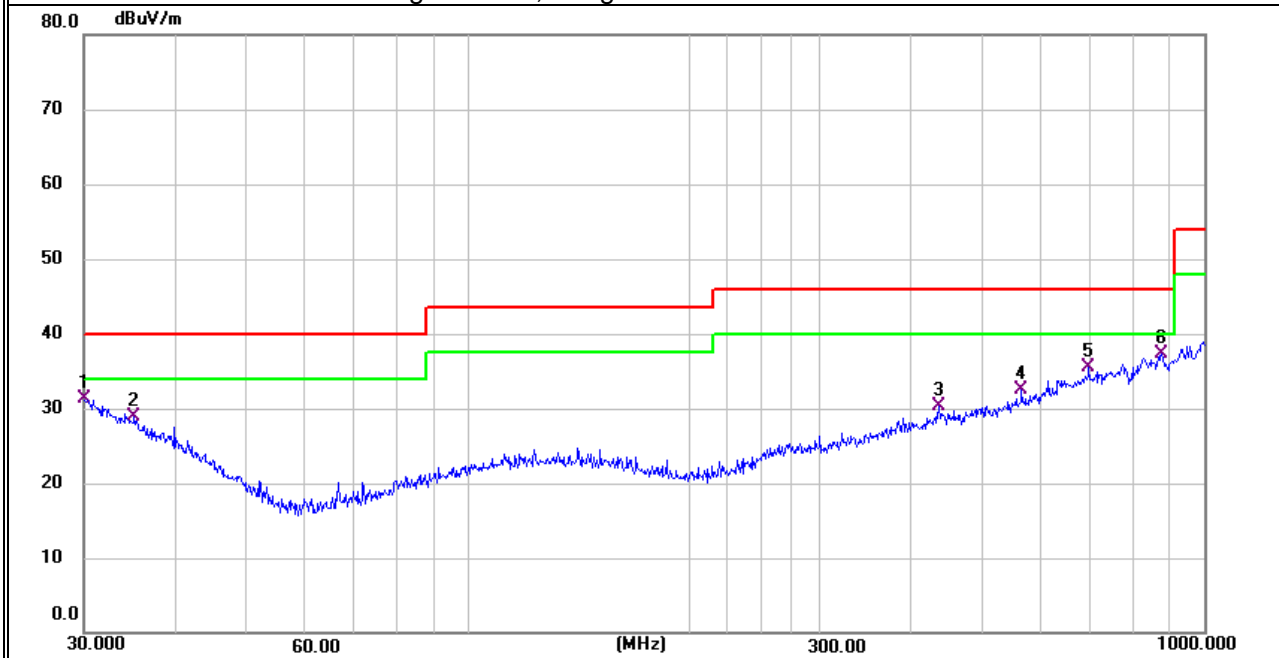

Polar (H/V)	Frequency	Meter Reading	Factor	Emission Level	Limits	Margin	Remark
	(MHz)	(dBuV)	(dB)	(dBuV/m)	(dBuV/m)	(dB)	
H	30.6376	5.68	26.11	31.79	40.00	-8.21	QP
H	324.4560	10.66	20.61	31.27	46.00	-14.73	QP
H	605.6592	6.66	26.54	33.20	46.00	-12.80	QP
H	691.9864	6.91	27.84	34.75	46.00	-11.25	QP
H	752.7431	6.64	28.84	35.48	46.00	-10.52	QP
H	872.1832	6.18	30.47	36.65	46.00	-9.35	QP

Remark:

Emission Level = Meter Reading + Factor, Margin= Emission Level - Limit

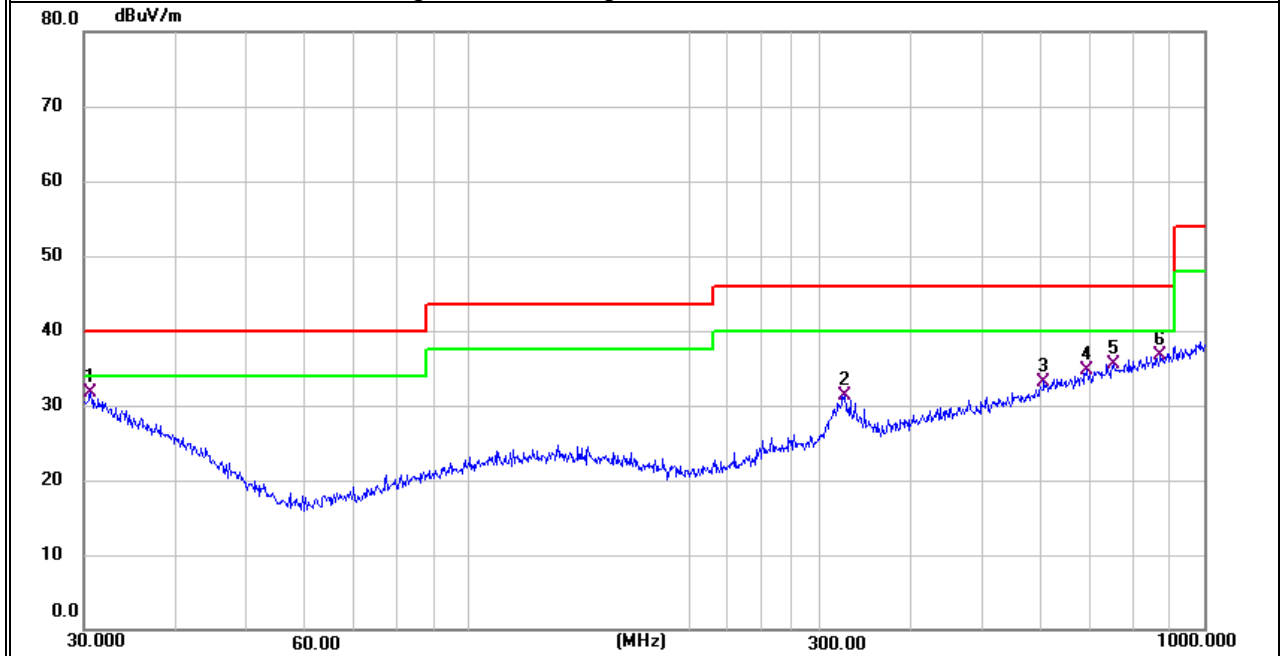

■ Spurious Emission Above 1GHz (1GHz to 25GHz)

EUT:	Manual call point	Model No.:	MCP.R.J-000-NA
Temperature:	20 °C	Relative Humidity:	48%
Test Mode:	Mode2/Mode3/Mode4 OCW=120KHz	Test By:	Gavan Zhang

All the modulation modes have been tested, and the worst result was report as below:

Frequency (MHz)	Read Level (dBμV)	Cable loss (dB)	Antenna Factor dB/m	Preamp Factor (dB)	Emission Level (dBμV/m)	Limits (dBμV/m)	Margin (dB)	Remark	Comment
Low Channel (905 MHz)(GFSK)--Above 1G									
1810	80.31	5.21	26.5	55.35	56.67	74.00	-17.33	Pk	Vertical
1810	59.46	5.21	26.5	55.35	35.82	54.00	-18.18	AV	Vertical
2715	75.35	6.48	28.49	55.11	55.21	74.00	-18.79	Pk	Vertical
2715	62.66	6.48	28.49	55.11	42.52	54.00	-11.48	AV	Vertical
1810	79.58	5.21	26.5	55.35	55.94	74.00	-18.06	Pk	Horizontal
1810	60.82	5.21	26.5	55.35	37.18	54.00	-16.82	AV	Horizontal
2715	77.75	6.48	28.49	55.11	57.61	74.00	-16.39	Pk	Horizontal
2715	58.26	6.48	28.49	55.11	38.12	54.00	-15.88	AV	Horizontal
Mid Channel (915.85 MHz)(GFSK)--Above 1G									
1831.7	78.64	5.21	26.5	55.35	55.00	74.00	-19.00	Pk	Vertical
1831.7	60.98	5.21	26.5	55.35	37.34	54.00	-16.66	AV	Vertical
2747.55	77.43	7.10	28.49	55.11	57.91	74.00	-16.09	Pk	Vertical
2747.55	59.21	7.10	28.49	55.11	39.69	54.00	-14.31	AV	Vertical
1829.5	79.12	5.21	26.5	55.35	55.48	74.00	-18.52	Pk	Horizontal
1829.5	60.15	5.21	26.5	55.35	36.51	54.00	-17.49	AV	Horizontal
2744.25	74.80	7.10	28.49	55.11	55.28	74.00	-18.72	Pk	Horizontal
2744.25	61.87	7.10	28.49	55.11	42.35	54.00	-11.65	AV	Horizontal
High Channel (926.5 MHz)(GFSK)-- Above 1G									
1855.5	78.63	5.21	26.5	55.35	54.99	74.00	-19.01	Pk	Vertical
1855.5	59.46	5.21	26.5	55.35	35.82	54.00	-18.18	AV	Vertical
2783.25	78.72	7.10	28.49	55.11	59.20	74.00	-14.80	Pk	Vertical
2783.25	59.47	7.10	28.49	55.11	39.95	54.00	-14.05	AV	Vertical
1855.5	81.97	5.21	35.52	55.35	67.35	74.00	-6.65	Pk	Horizontal
1855.5	59.94	5.21	35.52	55.35	45.32	54.00	-8.68	AV	Horizontal
2783.25	78.28	7.10	36.53	55.11	66.80	74.00	-7.20	Pk	Horizontal
2783.25	60.06	7.10	36.53	55.11	48.58	54.00	-5.42	AV	Horizontal

■ Spurious Emission in Restricted Band

EUT:	Manual call point	Model No.:	MCP.R.J-000-NA
Temperature:	20 °C	Relative Humidity:	48%
Test Mode:	Mode2/ Mode4 OCW=120KHz	Test By:	Gavan Zhang

All the modulation modes have been tested, and the worst result was report as below:

Frequency (MHz)	Reading Level (dBμV)	Cable Loss (dB)	Antenna Factor dB/m	Preamp Factor (dB)	Emission Level (dBμV/m)	Limits (dBμV/m)	Margin (dB)	Detector Type	Comment
1240	58.99	4.04	29.57	44.70	47.90	74	-26.10	Pk	Vertical
1240	55.02	4.04	29.57	44.70	43.93	54	-10.07	AV	Vertical
1240	60.72	4.04	29.57	44.70	49.63	74	-24.37	Pk	Horizontal
1240	55.01	4.04	29.57	44.70	43.92	54	-10.08	AV	Horizontal
1804.6	63.27	4.26	29.87	44.40	53.00	74	-21.00	Pk	Vertical
1804.6	52.83	4.26	29.87	44.40	42.56	54	-11.44	AV	Vertical
1804.6	62.27	4.26	29.87	44.40	52.00	74	-22.00	Pk	Horizontal
1804.6	52.45	4.26	29.87	44.40	42.18	54	-11.82	AV	Horizontal

7.3 NUMBER OF HOPPING CHANNEL

7.3.1 Applicable Standard

According to FCC Part 15.247(a)(1) (i) and ANSI C63.10-2013

7.3.2 Conformance Limit

For frequency hopping systems operating in the 902-928 MHz band: if the 20 dB bandwidth of the hopping channel is less than 250 kHz, the system shall use at least 50 hopping frequencies and the average time of occupancy on any frequency shall not be greater than 0.4 seconds within a 20 second period; if the 20 dB bandwidth of the hopping channel is 250 kHz or greater, the system shall use at least 25 hopping frequencies and the average time of occupancy on any frequency shall not be greater than 0.4 seconds within a 10 second period.

7.3.3 Measuring Instruments

The Measuring equipment is listed in the section 6.3 of this test report.

7.3.4 Test Setup

Please refer to Section 6.1 of this test report.

7.3.5 Test Procedure

The testing follows ANSI C63.10-2013 clause 7.8.3

The RF output of EUT was connected to the spectrum analyzer by RF cable and attenuator.

The path loss was compensated to the results for each measurement.

Set to the maximum power setting and enable the EUT transmit continuously.

The EUT must have its hopping function enabled.

Use the following spectrum analyzer settings:

Span = the frequency band of operation

RBW : To identify clearly the individual channels, set the RBW to less than 30% of the channel spacing or the 20 dB bandwidth, whichever is smaller.

VBW \geq RBW

Sweep = auto

Detector function = peak

Trace = max hold

7.3.6 Test Results

EUT:	Manual call point	Model No.:	MCP.R.J-000-NA
Temperature:	20 °C	Relative Humidity:	48%
Test Mode:	Mode 5(1Mbps)	Test By:	Gavan Zhang

OCW=120KHz

Number of Hopping (Channel)	Limit	Verdict
103	≥ 50	Pass



7.4 HOPPING CHANNEL SEPARATION MEASUREMENT

7.4.1 Applicable Standard

According to FCC Part 15.247(a) (1) and ANSI C63.10-2013

7.4.2 Conformance Limit

Frequency hopping systems shall have hopping channel carrier frequencies separated by a minimum of 25 kHz or the 20 dB bandwidth of the hopping channel, whichever is greater.

7.4.3 Measuring Instruments

The Measuring equipment is listed in the section 6.3 of this test report.

7.4.4 Test Setup

Please refer to Section 6.1 of this test report.

7.4.5 Test Procedure

The testing follows ANSI C63.10-2013 clause 7.8.2

The RF output of EUT was connected to the spectrum analyzer by RF cable and attenuator.

The path loss was compensated to the results for each measurement.

Set to the maximum power setting and enable the EUT transmit continuously.

The EUT was operating in controlled its channel.

Use the following spectrum analyzer settings:

Span = Measurement Bandwidth or Channel Separation

RBW: Start with the RBW set to approximately 3% of the channel spacing; adjust as necessary to best identify the center of each individual channel.

VBW \geq RBW

Sweep = auto

Detector function = peak

Trace = max hold

7.4.6 Test Results

EUT:	Manual call point	Model No.:	MCP.R.J-000-NA
Temperature:	20 °C	Relative Humidity:	48%
Test Mode:	Mode2/Mode3/Mode4	Test By:	Gavan Zhang

OCW=120KHz

Modulation Mode	Channel Number	Channel Frequency (MHz)	Measured Channel Separation (kHz)	Limit (kHz)		Verdict
GFSK	01-02	905	775.5	>98.36	20dB BW	PASS
	52-53	915.85	199.0	>98.03	20dB BW	PASS
	102-103	926.5	576.0	>98.36	20dB BW	PASS

Test Plot

(1Mbps) Channel Separation plot on channel 01-02



(1Mbps) Channel Separation plot on channel 52-53



(1Mbps) Channel Separation plot on channel 102-103



7.5 AVERAGE TIME OF OCCUPANCY (DWELL TIME)

7.5.1 Applicable Standard

According to FCC Part 15.247(a)(1)(i) and ANSI C63.10-2013

7.5.2 Conformance Limit

For frequency hopping systems operating in the 902-928 MHz band: if the 20 dB bandwidth of the hopping channel is less than 250 kHz, the system shall use at least 50 hopping frequencies and the average time of occupancy on any frequency shall not be greater than 0.4 seconds within a 20 second period; if the 20 dB bandwidth of the hopping channel is 250 kHz or greater, the system shall use at least 25 hopping frequencies and the average time of occupancy on any frequency shall not be greater than 0.4 seconds within a 10 second period. The maximum allowed 20 dB bandwidth of the hopping channel is 500 kHz.

7.5.3 Measuring Instruments

The Measuring equipment is listed in the section 6.3 of this test report.

7.5.4 Test Setup

Please refer to Section 6.1 of this test report.

7.5.5 Test Procedure

The testing follows ANSI C63.10-2013 clause 7.8.4

The RF output of EUT was connected to the spectrum analyzer by RF cable and attenuator.

The path loss was compensated to the results for each measurement.

Set to the maximum power setting and enable the EUT transmit continuously.

The EUT must have its hopping function enabled.

Use the following spectrum analyzer settings:

Span = zero span, centered on a hopping channel

RBW < 200kHz

VBW ≥ RBW

Sweep = as necessary to capture the entire dwell time per hopping channel

Detector function = peak

Trace = max hold

Measure the maximum time duration of one single pulse.

Set the EUT packet transmitting.

Measure the maximum time duration of one single pulse.

7.5.6 Test Results

EUT:	Manual call point	Model No.:	MCP.R.J-000-NA
Temperature:	20 °C	Relative Humidity:	48%
Test Mode:	Mode2/Mode3/Mode4	Test By:	Gavan Zhang

Center Frequency (MHz)	Transmit Time per Hop (ms)	The Number of Hop Within a limited time (N)	Dwell Time (s)	Limits (s)	Result
915.85	25 / 17	4	0.092	0.4	Pass

Note:

1. Ton1=25ms, Ton2=17ms
2. Sweep time=20s;
3. Dwell Time(s) = Transmit Timeper Hopx N= Ton1*3+ Ton2=25*3+17=92ms

Test Plot

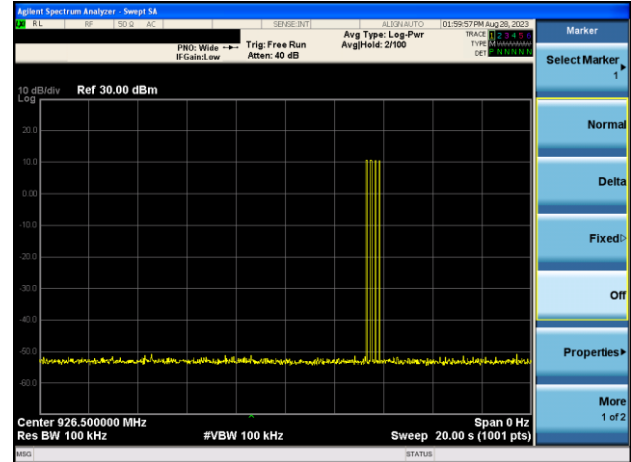
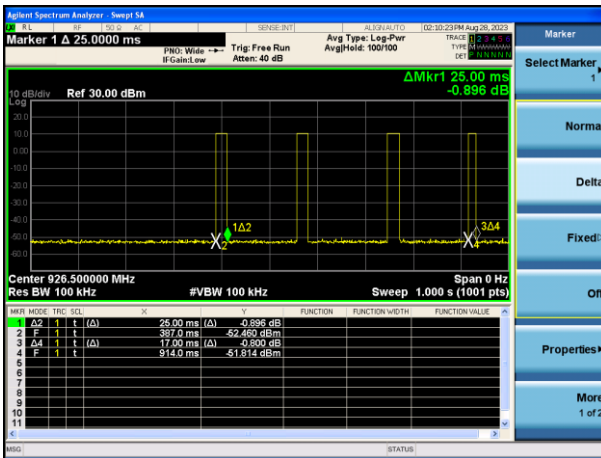

7.5.7 Pseudorandom Frequency Hopping Sequence

Each frequency used equally on the average by each transmitter.
The channel order is determined by the Channel mapping Table, system receivers have input bandwidths that match the hopping channel bandwidths of their corresponding transmitters and shift frequencies in synchronization with the transmitted signals

Pseudo-random sequence Table

Channel	Frequency (MHz)	Channel	Frequency (MHz)	Channel	Frequency (MHz)
1	905	36	912.65	71	919.65
55	916.45	37	912.85	81	921.65
56	916.65	38	913.05	77	920.85
46	914.65	2	905.85	74	920.25
47	914.85	51	915.65	26	910.65
24	910.25	9	907.25	27	910.85
25	910.45	10	907.45	72	919.85
75	920.45	54	916.25	73	920.05
76	920.65	22	909.85	78	921.05
28	911.05	23	910.05	82	921.85
29	911.25	7	906.85	79	921.25
52	915.85	8	907.05	84	922.25
53	916.05	48	915.05	83	922.05
57	916.85	49	915.25	80	921.45
58	917.05	50	915.45	85	922.45
59	917.25	18	909.05	3	906.05
60	917.45	19	909.25	4	906.25
61	917.65	20	909.45	5	906.45
62	917.85	21	909.65	11	907.65
63	918.05	31	911.65	12	907.85
64	918.25	32	911.85	13	908.05
65	918.45	33	912.05	6	906.65
69	919.25	66	918.65	39	913.25
70	919.45	67	918.85	40	913.45
30	911.45	68	919.05	41	913.65
34	912.25	90	923.45	97	924.85
35	912.45	91	923.65	98	925.05
86	922.65	92	923.85	15	908.45
87	922.85	100	925.45	42	913.85
88	923.05	95	924.45	14	908.25
89	923.25	102	925.85	99	925.25
16	908.65	43	914.05	94	924.25
17	908.85	44	914.25	96	924.65
93	924.05	45	914.45		
101	925.65	103	926.5		

7.6 20DB BANDWIDTH TEST

7.6.1 Applicable Standard

According to FCC Part 15.247(a)(1) and ANSI C63.10-2013

7.6.2 Conformance Limit

For frequency hopping systems operating in the 902-928 MHz band: if the 20 dB bandwidth of the hopping channel is less than 250 kHz, the system shall use at least 50 hopping frequencies and the average time of occupancy on any frequency shall not be greater than 0.4 seconds within a 20 second period; if the 20 dB bandwidth of the hopping channel is 250 kHz or greater, the system shall use at least 25 hopping frequencies and the average time of occupancy on any frequency shall not be greater than 0.4 seconds within a 10 second period. The maximum allowed 20 dB bandwidth of the hopping channel is 500 kHz.

7.6.3 Measuring Instruments

The Measuring equipment is listed in the section 6.3 of this test report.

7.6.4 Test Setup

Please refer to Section 6.1 of this test report.

7.6.5 Test Procedure

The testing follows ANSI C63.10-2013 clause 6.9.2

The RF output of EUT was connected to the spectrum analyzer by RF cable and attenuator.

The path loss was compensated to the results for each measurement.

Set to the maximum power setting and enable the EUT transmit continuously.

The EUT was operating in controlled its channel.

Use the following spectrum analyzer settings:

Span = approximately 2 to 3 times the 20 dB bandwidth, centered on a hopping channel

RBW \geq 1% of the 20 dB bandwidth

VBW \geq RBW

Sweep = auto

Detector function = peak

Trace = max hold

7.6.6 Test Results

EUT:	Manual call point	Model No.:	MCP.R.J-000-NA
Temperature:	20 °C	Relative Humidity:	48%
Test Mode:	Mode2/Mode3/Mode4	Test By:	Gavan Zhang

OCW=120KHZ

Test Channel	Frequency	Measured Bandwidth (KHz)	Limit	Verdict
	(MHz)			
1	905	98.36	250	PASS
52	915.85	98.03	250	PASS
103	926.5	98.36	250	PASS

Test Plot

20dB Bandwidth plot on channel 01 (1Mbps)

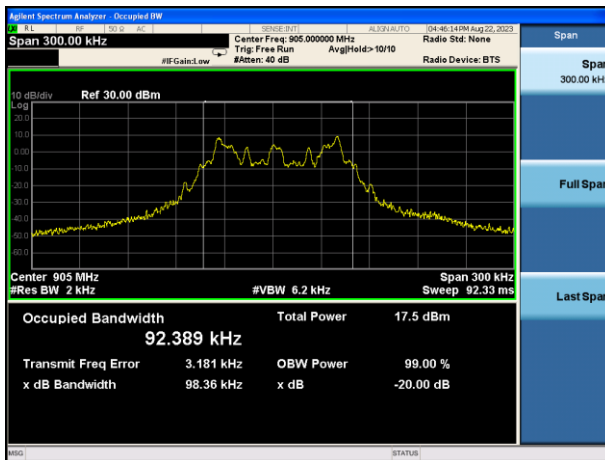

20dB Bandwidth plot on channel 52 (1Mbps)

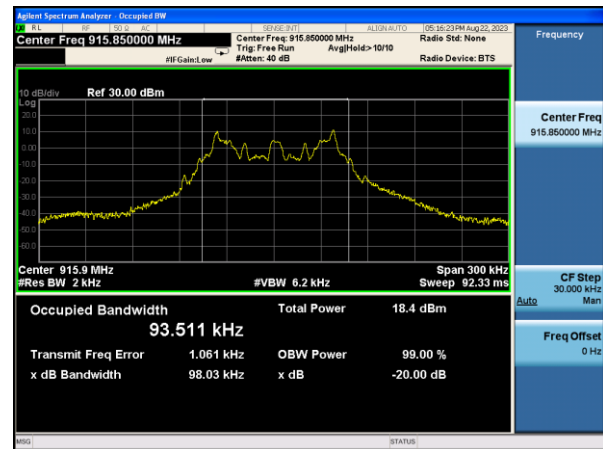

20dB Bandwidth plot on channel 103 (1Mbps)

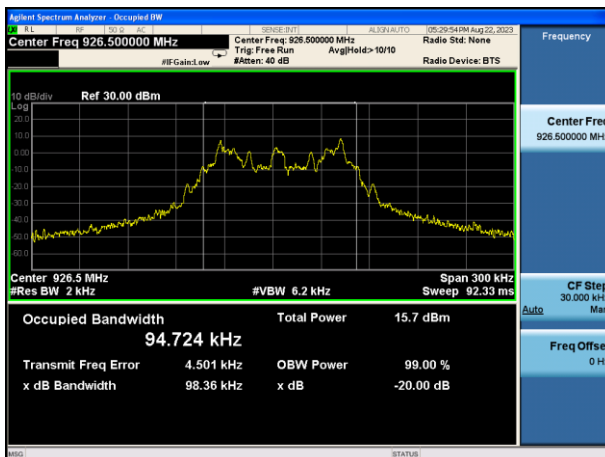

7.7 PEAK OUTPUT POWER

7.7.1 Applicable Standard

According to FCC Part 15.247(b)(1) and ANSI C63.10-2013

7.7.2 Conformance Limit

For frequency hopping systems operating in the 902-928 MHz band: 1 watt for systems employing at least 50 hopping channels; and, 0.25 watts for systems employing less than 50 hopping channels, but at least 25 hopping channels, as permitted under paragraph (a)(1)(i) of this section.

7.7.3 Measuring Instruments

The Measuring equipment is listed in the section 6.3 of this test report.

7.7.4 Test Setup

Please refer to Section 6.1 of this test report.

7.7.5 Test Procedure

The testing follows ANSI C63.10-2013 clause 7.8.5.

The RF output of EUT was connected to the spectrum analyzer by RF cable and attenuator.

The path loss was compensated to the results for each measurement.

Set to the maximum power setting and enable the EUT transmit continuously.

The EUT was operating in controlled its channel.

Use the following spectrum analyzer settings:

Span = approximately 5 times the 20 dB bandwidth, centered on a hopping channel

RBW \geq the 20 dB bandwidth of the emission being measured

VBW \geq RBW

Sweep = auto

Detector function = peak

Trace = max hold

7.7.6 Test Results

EUT:	Manual call point	Model No.:	MCP.R.J-000-NA
Temperature:	20 °C	Relative Humidity:	48%
Test Mode:	Mode2/Mode3/Mode4	Test By:	Gavan Zhang

OCW=120KHZ

Test Channel	Frequency	Power Setting	Peak Output Power	LIMIT	Verdict
	(MHz)		(dBm)		
1Mbps					
1	905.00	Default	11.282	30	PASS
52	915.85	Default	11.709	30	PASS
103	926.50	Default	9.821	30	PASS

Test Plot

Peak output Power plot on channel 01 (1Mbps)

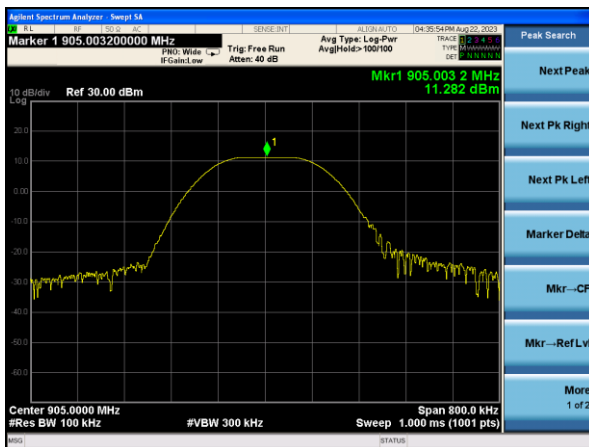

Peak output Power plot on channel 52 (1Mbps)

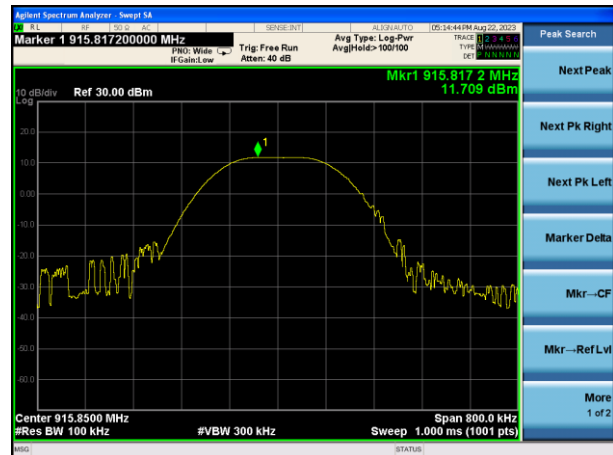

Peak output Power plot on channel 103 (1Mbps)



7.8 CONDUCTED BAND EDGE MEASUREMENT

7.8.1 Applicable Standard

According to FCC Part 15.247(d) and ANSI C63.10-2013

7.8.2 Conformance Limit

In any 100 kHz bandwidth outside the frequency band in which the spread spectrum or digitally modulated intentional radiator is operating, the radio frequency power that is produced by the intentional radiator shall be at least 20 dB below that in the 100 kHz bandwidth within the band that contains the highest level of the desired power, based on either an RF conducted or a radiated measurement, provided the transmitter demonstrates compliance with the peak conducted power limits. If the transmitter complies with the conducted power limits based on the use of RMS averaging over a time interval, as permitted under paragraph (b)(3) of this section, the attenuation required under this paragraph shall be 30 dB instead of 20 dB. Attenuation below the general limits specified in §15.209(a) is not required. In addition, radiated emissions which fall in the restricted bands, as defined in §15.205(a), must also comply with the radiated emission limits specified in §15.209(a) (see §15.205(c)).

7.8.3 Measuring Instruments

The Measuring equipment is listed in the section 6.3 of this test report.

7.8.4 Test Setup

Please refer to Section 6.1 of this test report.

7.8.5 Test Procedure

The testing follows ANSI C63.10-2013 clause 7.8.6.

The RF output of EUT was connected to the spectrum analyzer by RF cable and attenuator.

The path loss was compensated to the results for each measurement.

Set to the maximum power setting and enable the EUT transmit continuously.

The EUT must have its hopping function enabled.

Use the following spectrum analyzer settings:

Span = approximately 5 times the 20 dB bandwidth, centered on a hopping channel

RBW = 100KHz

VBW = 300KHz

Band edge emissions must be at least 20 dB down from the highest emission level within the authorized band as measured with a 100kHz RBW. The attenuation shall be 30 dB instead of 20 dB when RMS conducted output power procedure is used.

Measure the highest amplitude appearing on spectral display and set it as a reference level. Plot the graph with marking the highest point and edge frequency.

Repeat above procedures until all measured frequencies were complete.

7.8.6 Test Results

EUT:	Manual call point	Model No.:	MCP.R.J-000-NA
Temperature:	20 °C	Relative Humidity:	48%
Test Mode:	Mode2 /Mode4/ Mode5	Test By:	Gavan Zhang

OCW=120KHz

Test Plot

GFSK: Band Edge-Low Channel

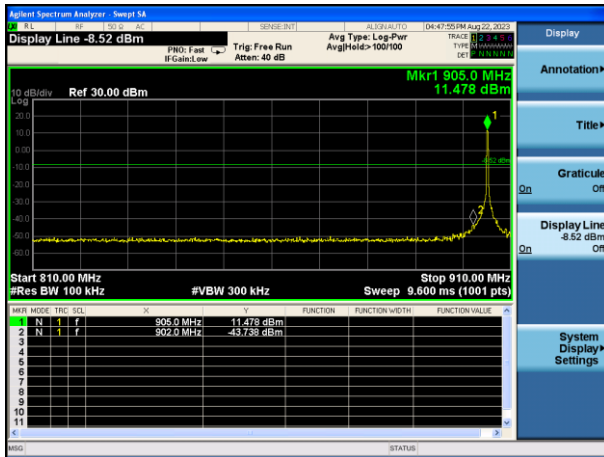

GFSK: Band Edge-High Channel

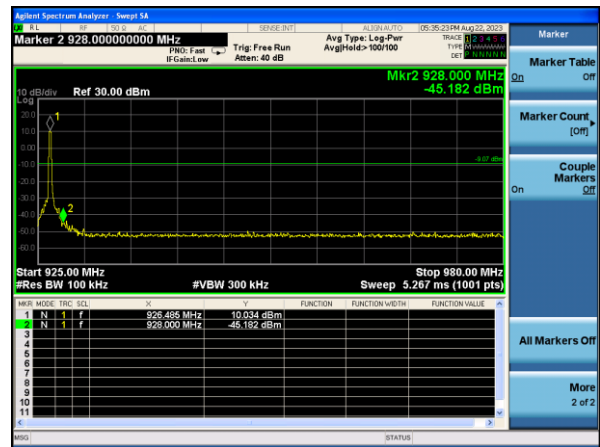

GFSK: Band Edge-Low Channel (Hopping Mode)

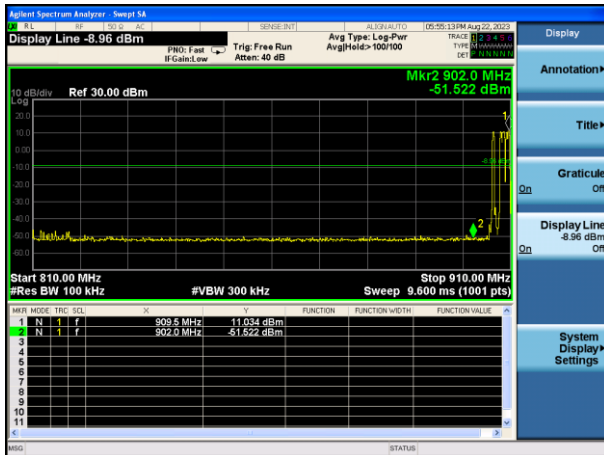

GFSK: Band Edge-High Channel (Hopping Mode)

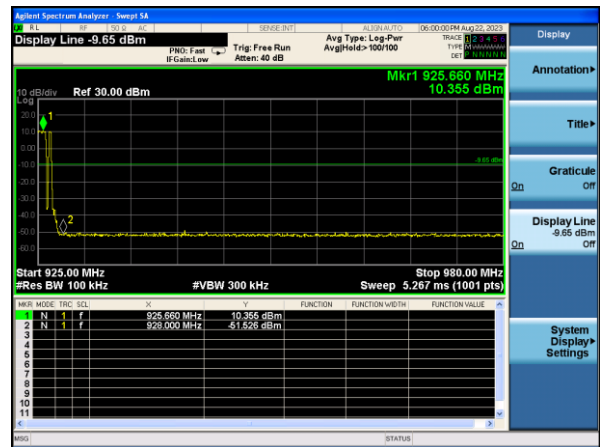

7.9 SPURIOUS RF CONDUCTED EMISSION

7.9.1 Applicable Standard

According to FCC Part 15.247(d) and ANSI C63.10-2013.

7.9.2 Conformance Limit

In any 100 kHz bandwidth outside the frequency band in which the spread spectrum or digitally modulated intentional radiator is operating, the radio frequency power that is produced by the intentional radiator shall be at least 20 dB below that in the 100 kHz bandwidth within the band that contains the highest level of the desired power, based on either an RF conducted or a radiated measurement, provided the transmitter demonstrates compliance with the peak conducted power limits. If the transmitter complies with the conducted power limits based on the use of RMS averaging over a time interval, as permitted under paragraph (b)(3) of this section, the attenuation required under this paragraph shall be 30 dB instead of 20 dB. Attenuation below the general limits specified in §15.209(a) is not required. In addition, radiated emissions which fall in the restricted bands, as defined in §15.205(a), must also comply with the radiated emission limits specified in §15.209(a) (see §15.205(c)).

7.9.3 Measuring Instruments

The Measuring equipment is listed in the section 6.3 of this test report.

7.9.4 Test Setup

Please refer to Section 6.1 of this test report.

7.9.5 Test Procedure

Establish an emission level by using the following procedure:

- a) Set the center frequency and span to encompass frequency range to be measured.
- b) Set the RBW = 100 kHz.
- c) Set the VBW \geq [3 × RBW].
- d) Detector = peak.
- e) Sweep time = auto couple.
- f) Trace mode = max hold.
- g) Allow trace to fully stabilize.
- h) Use the peak marker function to determine the maximum amplitude level.

Then the limit shall be attenuated by at least 20 dB relative to the maximum amplitude level in 100 kHz.

7.9.6 Test Results

Remark: The measurement frequency range is from 9KHz to the 10th harmonic of the fundamental frequency. The lowest, middle and highest channels are tested to verify the spurious emissions and bandege measurement data.

OCW=120KHz

Test Plot

GFSK on channel 01



GFSK on channel 01

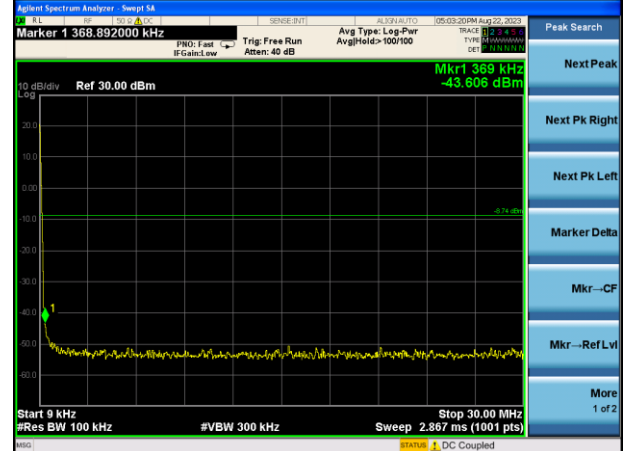

GFSK on channel 01

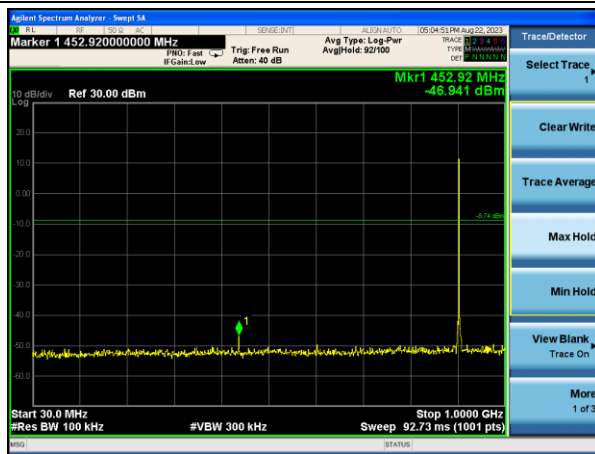

GFSK on channel 01



Test Plot

GFSK on channel 52

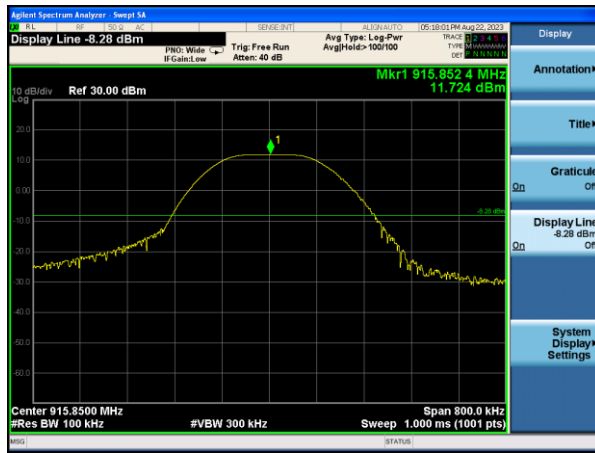

GFSK on channel 52

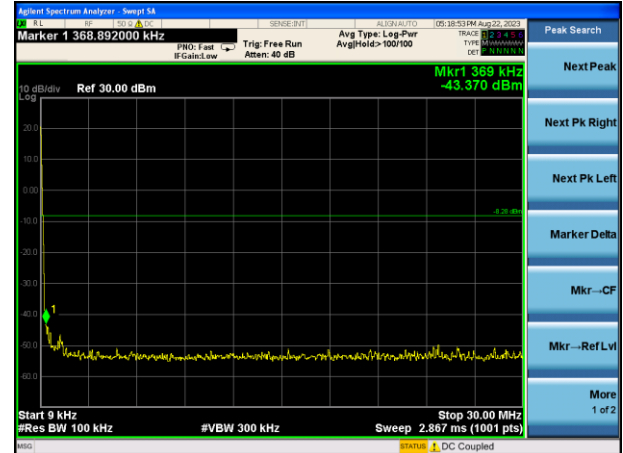

GFSK on channel 52

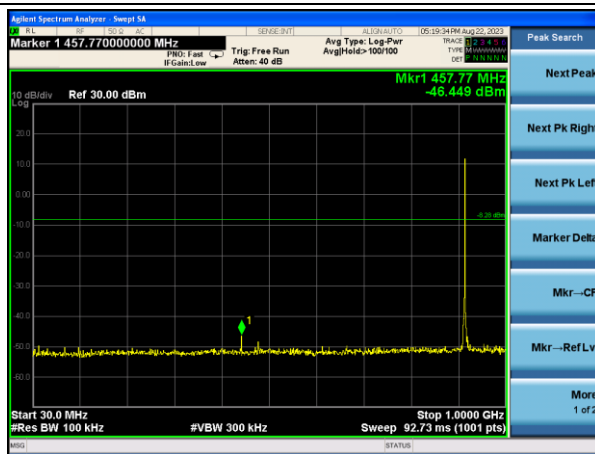

GFSK on channel 52

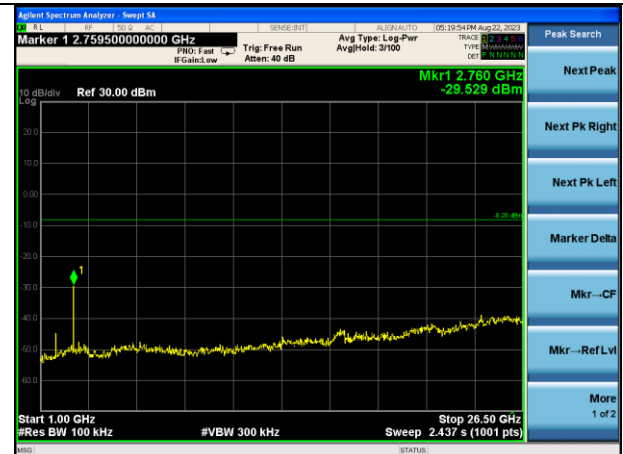

Test Plot

GFSK on channel 103

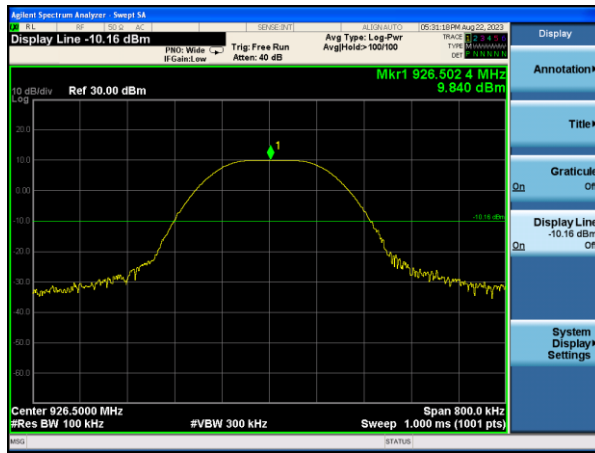

GFSK on channel 103

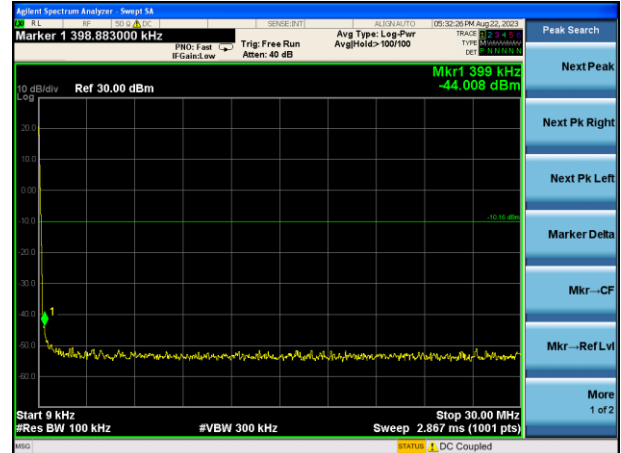

GFSK on channel 103

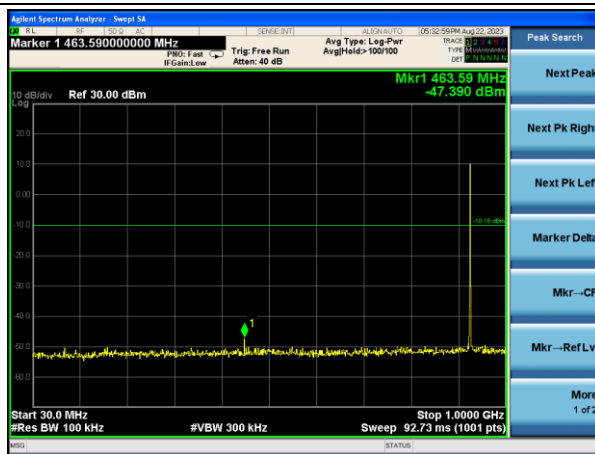

GFSK on channel 103



ANTENNA APPLICATION**7.9.7 Antenna Requirement**

15.203 requirement: For intentional device, according to 15.203: an intentional radiator shall be designed to ensure that no antenna other than that furnished by the responsible party shall be used with the device.

7.9.8 Result

The EUT has four antenna connector and use only the AntennaType: F-type antenna (Gain: -1.2 dB).
It comply with the standard of 15.203 requirement.

END OF REPORT