



# Compliance Certification Services (Kunshan) Inc. Shenzhen Branch

SZCCS-TRF-01 Rev. A/0 Aug01,2022

Report No.: FYCR221200049005

Page: 1 of 115

## DFS TEST REPORT

**Application No.:** FYCR2212000490AT  
**Applicant:** Ruijie Networks Co., Ltd.  
**Address of Applicant:** Building 19, Juyuanzhou Industrial Park, No. 618 Jinshan Road, Cangshan District, Fuzhou, Fujian 350002 China  
**Manufacturer:** Ruijie Networks Co., Ltd.  
**Address of Manufacturer:** Building 19, Juyuanzhou Industrial Park, No. 618 Jinshan Road, Cangshan District, Fuzhou, Fujian 350002 China

**Equipment Under Test (EUT):**  
**Product Name:** Wireless Access Point  
**Model No.:** RG-RAP2260(H)  
**Trade mark:** 

**FCC ID:** 2AX5J-RAP2260H  
**Standard(s) :** 47 CFR Part 15, Subpart E 15.407  
 KDB 905462 D02 UNII DFS Compliance Procedures New Rules v02  
 KDB 905462 D04 Operational Modes for DFS Testing New Rules v01

**Date of Receipt:** 2022-12-06  
**Date of Test:** 2022-12-08 to 2023-01-13  
**Date of Issue:** 2023-01-13

<b>Test Result:</b>	<b>Pass*</b>
---------------------	--------------

\* In the configuration tested, the EUT complied with the standards specified above.

Winkey Wang  
EMC Technical Manager



Unless otherwise agreed in writing, this document is issued by the Company subject to its General Conditions of Service printed overleaf, available on request or accessible at <http://www.sgs.com/en/Terms-and-Conditions.aspx> and, for electronic format documents, subject to Terms and Conditions for Electronic Documents at <http://www.sgs.com/en/Terms-and-Conditions/Terms-e-Documents.aspx>. Attention is drawn to the limitation of liability, indemnification and jurisdiction issues defined therein. Any holder of this document is advised that information contained hereon reflects the Company's findings at the time of its intervention only and within the limits of Client's instructions, if any. The Company's sole responsibility is to its Client and this document does not exonerate parties to a transaction from exercising all their rights and obligations under the transaction documents. This document cannot be reproduced except in full, without prior written approval of the Company. Any unauthorized alteration, forgery or falsification of the content or appearance of this document is unlawful and offenders may be prosecuted to the fullest extent of the law. Unless otherwise stated the results shown in this test report refer only to the sample(s) tested and such sample(s) are retained for 30 days only.  
 Attention: To check the authenticity of testing / inspection report & certificate, please contact us at telephone: (86-755) 8307 1443, or email: [CN.Doccheck@sgs.com](mailto:CN.Doccheck@sgs.com)

Fuyong lab, Xinlong TechnoPark, Fengtang Road, Fuyong Subdistrict, Bao'an, Shenzhen, China 518103 t (86-755) 88663988 f (86-755) 26710594 www.sgsgroup.com.cn  
 中国·深圳·宝安区福永街道凤塘大道鑫龙科技园福永实验室 邮编: 518103 t (86-755) 88663988 f (86-755) 26710594 sgs.china@sgs.com

## Compliance Certification Services (Kunshan) Inc. Shenzhen Branch

SZCCS-TRF-01 Rev. A/0 Aug01,2022

Report No.: FYCR221200049005

Page: 2 of 115

Revision Record				
Version	Chapter	Date	Modifier	Remark
01		2023-01-13		Original

Authorized for issue by:			
		Tree Zhan	
		_____	
		Tree Zhan/Project Engineer	
		Winkey Wang	
		_____	
		Winkey Wang/Reviewer	



Unless otherwise agreed in writing, this document is issued by the Company subject to its General Conditions of Service printed overleaf, available on request or accessible at <http://www.sgs.com/en/Terms-and-Conditions.aspx> and, for electronic format documents, subject to Terms and Conditions for Electronic Documents at <http://www.sgs.com/en/Terms-and-Conditions/Terms-e-Document.aspx>. Attention is drawn to the limitation of liability, indemnification and jurisdiction issues defined therein. Any holder of this document is advised that information contained hereon reflects the Company's findings at the time of its intervention only and within the limits of Client's instructions, if any. The Company's sole responsibility is to its Client and this document does not exonerate parties to a transaction from exercising all their rights and obligations under the transaction documents. This document cannot be reproduced except in full, without prior written approval of the Company. Any unauthorized alteration, forgery or falsification of the content or appearance of this document is unlawful and offenders may be prosecuted to the fullest extent of the law. Unless otherwise stated the results shown in this test report refer only to the sample(s) tested and such sample(s) are retained for 30 days only. **Attention: To check the authenticity of testing /inspection report & certificate, please contact us at telephone: (86-755) 8307 1443, or email: CN.Doccheck@sgs.com**

Compliance Certification Services (Kunshan) Inc. Shenzhen Branch

Fuyong lab, Xinlong TechnoPark, Fengtang Road, Fuyong Subdistrict, Bao'an, Shenzhen, China 518103 t (86-755) 88663988 f (86-755) 26710594 www.sgs.com.cn  
 中国·深圳·宝安区福永街道凤塘大道鑫龙科技园福永实验室 邮编: 518103 t (86-755) 88663988 f (86-755) 26710594 sgs.china@sgs.com

## 2 Test Summary

Item	Tested Bandwidth and Channel		Limit	Result
	Bandwidth (MHz) / mode	Frequency (MHz) / Channel No.		
Channel Availability Check Time	20/ 802.11ax 160 / 802.11ax	5320 / 64 5570 / 114	≥ 60sec	Pass
U-NII Detection Bandwidth	20 / 802.11ax	5320 / 64	> 100% of the U-NII 99% transmission power bandwidth	Pass
	40 / 802.11ax	5310 / 62		
	80 / 802.11ax 160 / 802.11ax	5290 / 58 5570 / 114		
Statistical Performance Check	20 / 802.11ax	5320 / 64	Type 1 ~ 4 ≥ 60% Type 1 ~ 4 and 5 ≥ 80% Type 6 ≥ 70%	Pass
	40 / 802.11ax	5310 / 62		
	80 / 802.11ax 160 / 802.11ax	5290 / 58 5570 / 114		
Channel Move Time	80/ 802.11ax 160 / 802.11ax	5290 / 58 5570 / 114	≤ 10sec	Pass
Channel Closing Transmission Time	80/ 802.11ax 160 / 802.11ax	5290 / 58 5570 / 114	≤ 200ms + aggregate of 60ms over remaining 10sec period	Pass
Non-Occupancy Period Test	80/ 802.11ax	5290 / 58	≥ 30 minutes	Pass
	160 / 802.11ax	5570 / 114		



Unless otherwise agreed in writing, this document is issued by the Company subject to its General Conditions of Service printed overleaf, available on request or accessible at <http://www.sgs.com/en/Terms-and-Conditions.aspx> and, for electronic format documents, subject to Terms and Conditions for Electronic Documents at <http://www.sgs.com/en/Terms-and-Conditions/Terms-e-Documents.aspx>. Attention is drawn to the limitation of liability, indemnification and jurisdiction issues defined therein. Any holder of this document is advised that information contained hereon reflects the Company's findings at the time of its intervention only and within the limits of Client's instructions, if any. The Company's sole responsibility is to its Client and this document does not exonerate parties to a transaction from exercising all their rights and obligations under the transaction documents. This document cannot be reproduced except in full, without prior written approval of the Company. Any unauthorized alteration, forgery or falsification of the content or appearance of this document is unlawful and offenders may be prosecuted to the fullest extent of the law. Unless otherwise stated the results shown in this test report refer only to the sample(s) tested and such sample(s) are retained for 30 days only.  
**Attention: To check the authenticity of testing/inspection report & certificate, please contact us at telephone: (86-755) 8307 1443, or email: CN.Doccheck@sgs.com**

Compliance Certification Services (Kunshan) Inc.  
Shenzhen Branch

Fuyong lab, Xinlong TechnoPark, Fengtang Road, Fuyong Subdistrict, Bao'an, Shenzhen, China 518103 t (86-755) 88663988 f (86-755) 26710594 www.sgs.com.cn  
 中国·深圳·宝安区福永街道凤塘大道鑫龙科技园福永实验室 邮编: 518103 t (86-755) 88663988 f (86-755) 26710594 sgs.china@sgs.com

### 3 Contents

	Page
1 COVER PAGE .....	1
2 Test Summary.....	3
3 Contents .....	4
4 General Information.....	6
4.1 Details of E.U.T.....	6
4.2 Description of Support Units.....	7
4.3 Measurement Uncertainty .....	8
4.4 Test Location .....	9
4.5 Test Facility.....	9
4.6 Deviation from Standards.....	9
4.7 Abnormalities from Standard Conditions.....	9
5 Equipment List .....	10
6 Requirements and Parameters for DFS test.....	11
6.1 Applicability of DFS requirements.....	11
6.2 DFS Detection Thresholds .....	12
6.3 DFS Response Requirements.....	12
6.4 RADAR TEST WAVEFORMS .....	13
6.4.1 Short Pulse Radar Test Waveforms .....	13
6.4.2 Long Pulse Radar Test Waveforms.....	15
6.4.3 Frequency Hopping Radar Test Waveforms.....	16
7 Calibration of Radar Waveform.....	17
7.1 Radar Waveform Calibration Procedure .....	17
7.2 Conducted Calibration Setup.....	17
7.3 Radar Waveform Calibration Result.....	18
8 DFS Test Results.....	22
8.1 Conducted Test Setup Configuration .....	22
8.2 U-NII Detection Bandwidth (7.8.1) .....	23
8.2.1 Limit of U-NII Detection Bandwidth.....	23
8.2.2 Test Procedure .....	23
8.2.3 Measurement Data.....	23
8.3 Channel Availability Check (7.8.2).....	31
8.3.1 Limit of Channel Availability Check.....	31
8.3.2 Test Procedure .....	31
8.3.3 Measurement Data.....	34
8.4 In-Service Monitoring for Channel Move Time, Channel Closing Transmission Time and Non-Occupancy Period (7.8.3) .....	38
8.4.1 Limit of In-Service Monitoring.....	38
8.4.2 Test Procedure .....	39



Unless otherwise agreed in writing, this document is issued by the Company subject to its General Conditions of Service printed overleaf, available on request or accessible at <http://www.sgs.com/en/Terms-and-Conditions.aspx> and, for electronic format documents, subject to Terms and Conditions for Electronic Documents at <http://www.sgs.com/en/Terms-and-Conditions/Terms-e-Documents.aspx>. Attention is drawn to the limitation of liability, indemnification and jurisdiction issues defined therein. Any holder of this document is advised that information contained hereon reflects the Company's findings at the time of its intervention only and within the limits of Client's instructions, if any. The Company's sole responsibility is to its Client and this document does not exonerate parties to a transaction from exercising all their rights and obligations under the transaction documents. This document cannot be reproduced except in full, without prior written approval of the Company. Any unauthorized alteration, forgery or falsification of the content or appearance of this document is unlawful and offenders may be prosecuted to the fullest extent of the law. Unless otherwise stated the results shown in this test report refer only to the sample(s) tested and such sample(s) are retained for 30 days only.  
**Attention: To check the authenticity of testing /inspection report & certificate, please contact us at telephone: (86-755) 8307 1443, or email: CN.Doccheck@sgs.com**

# Compliance Certification Services (Kunshan) Inc. Shenzhen Branch

SZCCS-TRF-01 Rev. A/0 Aug01,2022

Report No.: FYCR221200049005

Page: 5 of 115

- 8.4.3 Measurement Data.....40
- 8.5 Statistical Performance Check (7.8.4).....44
  - 8.5.1 Limit of Statistical Performance Check .....44
  - 8.5.2 Test Procedure .....44
  - 8.5.3 Measurement Data.....45
- 9 Photographs.....49**
  - 9.1 Test Setup .....49
- Appendix Radar Test Waveforms .....50**



Unless otherwise agreed in writing, this document is issued by the Company subject to its General Conditions of Service printed overleaf, available on request or accessible at <http://www.sgs.com/en/Terms-and-Conditions.aspx> and, for electronic format documents, subject to Terms and Conditions for Electronic Documents at <http://www.sgs.com/en/Terms-and-Conditions/Terms-e-Documents.aspx>. Attention is drawn to the limitation of liability, indemnification and jurisdiction issues defined therein. Any holder of this document is advised that information contained hereon reflects the Company's findings at the time of its intervention only and within the limits of Client's instructions, if any. The Company's sole responsibility is to its Client and this document does not exonerate parties to a transaction from exercising all their rights and obligations under the transaction documents. This document cannot be reproduced except in full, without prior written approval of the Company. Any unauthorized alteration, forgery or falsification of the content or appearance of this document is unlawful and offenders may be prosecuted to the fullest extent of the law. Unless otherwise stated the results shown in this test report refer only to the sample(s) tested and such sample(s) are retained for 30 days only.  
**Attention: To check the authenticity of testing /inspection report & certificate, please contact us at telephone: (86-755) 8307 1443, or email: CN.Doccheck@sgs.com**

Compliance Certification Services (Kunshan) Inc.  
 Shenzhen Branch

Fuyong lab, Xinlong TechnoPark, Fengtang Road, Fuyong Subdistrict, Bao'an, Shenzhen, China 518103 t (86-755) 88663988 f (86-755) 26710594 www.sgs.com.cn  
 中国·深圳·宝安区福永街道凤塘大道鑫龙科技园福永实验室 邮编: 518103 t (86-755) 88663988 f (86-755) 26710594 sgs.china@sgs.com

## 4 General Information

### 4.1 Details of E.U.T.

Power supply:	48V  1A, PoE			
Operation Frequency:	Band	Mode	Frequency Range(MHz)	Number of channels
	UNII Band I	802.11a/n(HT20)/ac(HT20)/ax(HEW20):	5180-5240	4
		802.11n(HT40)/ac(HT40)/ax(HEW40)	5190-5230	2
		802.11ac(HT80)/ax(HEW80)	5210	1
		802.11ac(HT160)/ax(HEW160)	5250	1
	UNII Band II-A	802.11a/n(HT20)/ac(HT20)/ax(HEW20):	5260-5320	4
		802.11n(HT40)/ac(HT40)/ax(HEW40)	5270-5310	2
		802.11ac(HT80)/ax(HEW80)	5290	1
	UNII Band II-C	802.11a/n(HT20)/ac(HT20)/ax(HEW20):	5500-5700	11
		802.11n(HT40)/ac(HT40)/ax(HEW40)	5510-5670	5
		802.11ac(HT80)/ax(HEW80)	5530,5610	2
		802.11ac(HT160)/ax(HEW160)	5570	1
	UNII Band III	802.11a/n(HT20)/ac(HT20)/ax(HEW20):	5745-5825	5
802.11n(HT40)/ac(HT40)/ax(HEW40)		5755-5795	2	
802.11ac(HT80)/ax(HEW80)		5775	1	
Modulation Type:	802.11a: OFDM(16QAM, 64QAM, QPSK, BPSK) 802.11n: OFDM(16QAM, 64QAM, QPSK, BPSK) 802.11ac: OFDM(16QAM, 64QAM, 256QAM, QPSK, BPSK) 802.11ax: OFDMA(16QAM, 64QAM, 256QAM, 1024QAM, QPSK, BPSK)			
DFS Function:	Master			
TPC Function:	Support			
Sample Type:	Fixed device			
Antenna Type:	PIFA Antenna			
Antenna Gain:	U-NII-1: Antenna1:4.01dBi, Antenna2: 5.36dBi, Antenna3: 4.93dBi, Antenna4: 4.26dBi U-NII-2A: Antenna1:3.69dBi, Antenna2: 4.86dBi, Antenna3: 4.50dBi, Antenna4: 4.59dBi U-NII-2C: Antenna1:5.67dBi, Antenna2: 6.30dBi, Antenna3: 4.82dBi, Antenna4: 5.88dBi U-NII-III: Antenna1:4.42dBi, Antenna2: 4.85dBi, Antenna3: 4.68dBi, Antenna4: 5.70dBi			

Remark: The information in this section is provided by the applicant or manufacturer, CCS is not liable to the accuracy, suitability, reliability or/and integrity of the information.



Unless otherwise agreed in writing, this document is issued by the Company subject to its General Conditions of Service printed overleaf, available on request or accessible at <http://www.sgs.com/en/Terms-and-Conditions.aspx> and, for electronic format documents, subject to Terms and Conditions for Electronic Documents at <http://www.sgs.com/en/Terms-and-Conditions/Terms-e-Documents.aspx>. Attention is drawn to the limitation of liability, indemnification and jurisdiction issues defined therein. Any holder of this document is advised that information contained hereon reflects the Company's findings at the time of its intervention only and within the limits of Client's instructions, if any. The Company's sole responsibility is to its Client and this document does not exonerate parties to a transaction from exercising all their rights and obligations under the transaction documents. This document cannot be reproduced except in full, without prior written approval of the Company. Any unauthorized alteration, forgery or falsification of the content or appearance of this document is unlawful and offenders may be prosecuted to the fullest extent of the law. Unless otherwise stated the results shown in this test report refer only to the sample(s) tested and such sample(s) are retained for 30 days only.  
**Attention: To check the authenticity of testing/inspection report & certificate, please contact us at telephone: (86-755) 8307 1443, or email: CN.Doccheck@sgs.com**

Fuyong lab, Xinlong TechnoPark, Fengtang Road, Fuyong Subdistrict, Bao'an, Shenzhen, China 518103 t (86-755) 88663988 f (86-755) 26710594 www.sgs.com.cn  
中国·深圳·宝安区福永街道凤塘大道鑫龙科技园福永实验室 邮编: 518103 t (86-755) 88663988 f (86-755) 26710594 sgs.china@sgs.com

**4.2 Description of Support Units**

Description	Manufacturer	Model No.	Serial No.
Network Cable	Supplied by lab	N/A	REF. No.SEA1100 FCC ID:N/A
Laptop	Lenovo	T430u	REF. No.SEA1800 FCC ID:N/A
iPhone	Apple	MG472ZP/A	C34NHTMFG5MN FCC ID:BCG-E2816A



Unless otherwise agreed in writing, this document is issued by the Company subject to its General Conditions of Service printed overleaf, available on request or accessible at <http://www.sgs.com/en/Terms-and-Conditions.aspx> and, for electronic format documents, subject to Terms and Conditions for Electronic Documents at <http://www.sgs.com/en/Terms-and-Conditions/Terms-e-Documents.aspx>. Attention is drawn to the limitation of liability, indemnification and jurisdiction issues defined therein. Any holder of this document is advised that information contained hereon reflects the Company's findings at the time of its intervention only and within the limits of Client's instructions, if any. The Company's sole responsibility is to its Client and this document does not exonerate parties to a transaction from exercising all their rights and obligations under the transaction documents. This document cannot be reproduced except in full, without prior written approval of the Company. Any unauthorized alteration, forgery or falsification of the content or appearance of this document is unlawful and offenders may be prosecuted to the fullest extent of the law. Unless otherwise stated the results shown in this test report refer only to the sample(s) tested and such sample(s) are retained for 30 days only.  
**Attention: To check the authenticity of testing /inspection report & certificate, please contact us at telephone: (86-755) 8307 1443, or email: CN.Doccheck@sgs.com**

**4.3 Measurement Uncertainty**

Test Item	Measurement Uncertainty
Channel Availability Check Time	$\pm 5.4 \times 10^{-8}$
Detection threshold	$\pm 5.4 \times 10^{-8}$
Non-occupancy period	$\pm 5.4 \times 10^{-8}$
Channel Move Time	$\pm 5.4 \times 10^{-8}$
Detection bandwidth	$\pm 5.4 \times 10^{-8}$
Channel Closing Transmission Time	$\pm 5.4 \times 10^{-8}$

**Remark:**

The  $U_{lab}$  (lab Uncertainty) is less than  $U_{CISPR/ETSI}$  (CISPR/ETSI Uncertainty), so the test results  
 – compliance is deemed to occur if no measured disturbance level exceeds the disturbance limit;  
 – non-compliance is deemed to occur if any measured disturbance level exceeds the disturbance limit.



Unless otherwise agreed in writing, this document is issued by the Company subject to its General Conditions of Service printed overleaf, available on request or accessible at <http://www.sgs.com/en/Terms-and-Conditions.aspx> and, for electronic format documents, subject to Terms and Conditions for Electronic Documents at <http://www.sgs.com/en/Terms-and-Conditions/Terms-e-Documents.aspx>. Attention is drawn to the limitation of liability, indemnification and jurisdiction issues defined therein. Any holder of this document is advised that information contained hereon reflects the Company's findings at the time of its intervention only and within the limits of Client's instructions, if any. The Company's sole responsibility is to its Client and this document does not exonerate parties to a transaction from exercising all their rights and obligations under the transaction documents. This document cannot be reproduced except in full, without prior written approval of the Company. Any unauthorized alteration, forgery or falsification of the content or appearance of this document is unlawful and offenders may be prosecuted to the fullest extent of the law. Unless otherwise stated the results shown in this test report refer only to the sample(s) tested and such sample(s) are retained for 30 days only.  
**Attention: To check the authenticity of testing /inspection report & certificate, please contact us at telephone: (86-755) 8307 1443, or email: CN.Doccheck@sgs.com**



## Compliance Certification Services (Kunshan) Inc. Shenzhen Branch

SZCCS-TRF-01 Rev. A/0 Aug01,2022

Report No.: FYCR221200049005

Page: 9 of 115

### 4.4 Test Location

All tests were performed at:

Compliance Certification Services (Kunshan) Inc. Shenzhen branch.

Fuyong lab. Xinlong TechnoPark, Fengtang Road, Fuyong Subdistrict, Bao'an, Shenzhen, China

Tel: +86 755 8866 3988 Fax: +86 755 2671 0594

No tests were sub-contracted.

### 4.5 Test Facility

The test facility is recognized, certified, or accredited by the following organizations:

#### • A2LA (Certificate No. 6606.01)

Compliance Certification Services (Kunshan) Inc. Shenzhen branch is accredited by the American Association for Laboratory Accreditation(A2LA). Certificate No. 6606.01.

#### • FCC –Designation Number: CN1322

Compliance Certification Services (Kunshan) Inc. Shenzhen branch has been recognized as an accredited testing laboratory.

Designation Number: CN1322. Test Firm Registration Number: 718073

#### • Innovation, Science and Economic Development Canada

Compliance Certification Services (Kunshan) Inc. Shenzhen branch has been recognized by ISED as an accredited testing laboratory.

CAB identifier: CN0129.

IC#: 28189.

### 4.6 Deviation from Standards

None

### 4.7 Abnormalities from Standard Conditions

None



Unless otherwise agreed in writing, this document is issued by the Company subject to its General Conditions of Service printed overleaf, available on request or accessible at <http://www.sgs.com/en/Terms-and-Conditions.aspx> and, for electronic format documents, subject to Terms and Conditions for Electronic Documents at <http://www.sgs.com/en/Terms-and-Conditions/Terms-e-Documents.aspx>. Attention is drawn to the limitation of liability, indemnification and jurisdiction issues defined therein. Any holder of this document is advised that information contained hereon reflects the Company's findings at the time of its intervention only and within the limits of Client's instructions, if any. The Company's sole responsibility is to its Client and this document does not exonerate parties to a transaction from exercising all their rights and obligations under the transaction documents. This document cannot be reproduced except in full, without prior written approval of the Company. Any unauthorized alteration, forgery or falsification of the content or appearance of this document is unlawful and offenders may be prosecuted to the fullest extent of the law. Unless otherwise stated the results shown in this test report refer only to the sample(s) tested and such sample(s) are retained for 30 days only. Attention: To check the authenticity of testing /inspection report & certificate, please contact us at telephone: (86-755) 8307 1443, or email: CN.Doccheck@sgs.com

Fuyong lab. Xinlong TechnoPark, Fengtang Road, Fuyong Subdistrict, Bao'an, Shenzhen, China 518103 t (86-755) 88663988 f (86-755) 26710594 www.sgs.com.cn  
中国·深圳·宝安区福永街道凤塘大道鑫龙科技园福永实验室 邮编: 518103 t (86-755) 88663988 f (86-755) 26710594 sgs.china@sgs.com

## 5 Equipment List

Equipment	Manufacturer	Model No.	Inventory No.	Cal Date	Cal Due Date
Programmable Temperature & Humidity Chamber	Votsch Industrietechnik GmbH	VT 4002	SEM002-15	2022/7/12	2023/7/11
MXA Signal Analyzer	KEYSIGHT	N9020A	SEM004-25	2022/5/30	2023/5/29
Signal Generator	Agilent	N5173B	SEM006-05	2022/7/12	2023/7/11
ESG Vector Signal Generator	Agilent	E4438C	SEM006-15	2022/7/12	2023/7/11
Power Sensor	Erika Fiedler	U2021XA	SEM009-15	2022/7/12	2023/7/11
Power Sensor	Erika Fiedler	U2021XA	SEM009-16	2022/7/12	2023/7/11
Wideband Radio Communication Tester	Rohde & Schwarz	CMW 500	SEM010-08	2022/7/12	2023/7/11
Programmable DC Source	Chroma	62024P-80-60	SEM011-09	2022/7/12	2023/7/11
Attenuator	Huber+Suhner	6620_SMA-50-1	SEM021-09	2022/7/12	2023/7/11
Measurement Software	TST PASS	TST PASS V2.0	N/A	N/A	N/A



Unless otherwise agreed in writing, this document is issued by the Company subject to its General Conditions of Service printed overleaf, available on request or accessible at <http://www.sgs.com/en/Terms-and-Conditions.aspx> and, for electronic format documents, subject to Terms and Conditions for Electronic Documents at <http://www.sgs.com/en/Terms-and-Conditions/Terms-e-Documents.aspx>. Attention is drawn to the limitation of liability, indemnification and jurisdiction issues defined therein. Any holder of this document is advised that information contained hereon reflects the Company's findings at the time of its intervention only and within the limits of Client's instructions, if any. The Company's sole responsibility is to its Client and this document does not exonerate parties to a transaction from exercising all their rights and obligations under the transaction documents. This document cannot be reproduced except in full, without prior written approval of the Company. Any unauthorized alteration, forgery or falsification of the content or appearance of this document is unlawful and offenders may be prosecuted to the fullest extent of the law. Unless otherwise stated the results shown in this test report refer only to the sample(s) tested and such sample(s) are retained for 30 days only.  
**Attention: To check the authenticity of testing /inspection report & certificate, please contact us at telephone: (86-755) 8307 1443, or email: CN.Doccheck@sgs.com**

Compliance Certification Services (Kunshan) Inc. Shenzhen Branch

Fuyong lab, Xinlong TechnoPark, Fengtang Road, Fuyong Subdistrict, Bao'an, Shenzhen, China 518103 t (86-755) 88663988 f (86-755) 26710594 www.sgs.com.cn  
 中国·深圳·宝安区福永街道凤塘大道鑫龙科技园福永实验室 邮编: 518103 t (86-755) 88663988 f (86-755) 26710594 sgs.china@sgs.com

## 6 Requirements and Parameters for DFS test

### 6.1 Applicability of DFS requirements

**Table 1: Applicability of DFS Requirements Prior to Use of a Channel**

Requirement	Operational Mode		
	<input checked="" type="checkbox"/> Master	<input type="checkbox"/> Client Without Radar Detection	<input type="checkbox"/> Client with Radar Detection
Non-Occupancy Period	Yes	Not required	Yes
DFS Detection Threshold	Yes	Not required	Yes
Channel Availability Check Time	Yes	Not required	Not required
U-NII Detection Bandwidth	Yes	Not required	Yes

**Table 2: Applicability of DFS requirements during normal operation**

Requirement	Operational Mode	
	<input checked="" type="checkbox"/> Master Device or Client with Radar Detection	<input type="checkbox"/> Client Without Radar Detection
DFS Detection Threshold	Yes	Not required
Channel Closing Transmission Time	Yes	Yes
Channel Move Time	Yes	Yes
U-NII Detection Bandwidth	Yes	Not required

Additional requirements for devices with multiple bandwidth modes	<input checked="" type="checkbox"/> Master Device or Client with Radar Detection	<input type="checkbox"/> Client Without Radar Detection
U-NII Detection Bandwidth and Statistical Performance Check	All BW modes must be tested	Not required
Channel Move Time and Channel Closing Transmission Time	Test using widest BW mode available	Test using the widest BW mode available for the link
All other tests	Any single BW mode	Not required

Note: Frequencies selected for statistical performance check (Section 7.8.4) should include several frequencies within the radar detection bandwidth and frequencies near the edge of the radar detection bandwidth. For 802.11 devices, it is suggested to select frequencies in each of the bonded 20 MHz channels and the channel center frequency.



Unless otherwise agreed in writing, this document is issued by the Company subject to its General Conditions of Service printed overleaf, available on request or accessible at <http://www.sgs.com/en/Terms-and-Conditions.aspx> and, for electronic format documents, subject to Terms and Conditions for Electronic Documents at <http://www.sgs.com/en/Terms-and-Conditions/Terms-e-Document.aspx>. Attention is drawn to the limitation of liability, indemnification and jurisdiction issues defined therein. Any holder of this document is advised that information contained hereon reflects the Company's findings at the time of its intervention only and within the limits of Client's instructions, if any. The Company's sole responsibility is to its Client and this document does not exonerate parties to a transaction from exercising all their rights and obligations under the transaction documents. This document cannot be reproduced except in full, without prior written approval of the Company. Any unauthorized alteration, forgery or falsification of the content or appearance of this document is unlawful and offenders may be prosecuted to the fullest extent of the law. Unless otherwise stated the results shown in this test report refer only to the sample(s) tested and such sample(s) are retained for 30 days only.  
**Attention: To check the authenticity of testing /inspection report & certificate, please contact us at telephone: (86-755) 8307 1443, or email: CN.Doccheck@sgs.com**

Fuyong lab, Xinlong TechnoPark, Fengtang Road, Fuyong Subdistrict, Bao'an, Shenzhen, China 518103 t (86-755) 88663988 f (86-755) 26710594 www.sgs.com.cn  
 中国·深圳·宝安区福永街道凤塘大道鑫龙科技园福永实验室 邮编: 518103 t (86-755) 88663988 f (86-755) 26710594 sgs.china@sgs.com

### 6.2 DFS Detection Thresholds

Table 3 below provides the DFS Detection Thresholds for Master Devices as well as Client Devices incorporating In-Service Monitoring.

**Table 3: DFS Detection Thresholds for Master Devices and Client Devices with Radar Detection**

Maximum Transmit Power	Value (See Notes 1, 2, and 3)
EIRP ≥ 200 milliwatt	-64 dBm
EIRP < 200 milliwatt and power spectral density < 10 dBm/MHz	-62 dBm
EIRP < 200 milliwatt that do not meet the power spectral density requirement	-64 dBm
<p>Note 1: This is the level at the input of the receiver assuming a 0 dBi receive antenna.</p> <p>Note 2: Throughout these test procedures an additional 1 dB has been added to the amplitude of the test transmission waveforms to account for variations in measurement equipment. This will ensure that the test signal is at or above the detection threshold level to trigger a DFS response.</p> <p>Note 3: EIRP is based on the highest antenna gain. For MIMO devices refer to KDB Publication 662911 D01.</p>	

### 6.3 DFS Response Requirements

**Table 4: DFS Response Requirement Values**

Parameter	Value
Non-occupancy period	Minimum 30 minutes
Channel Availability Check Time	60 seconds
Channel Move Time	10 seconds See Note 1.
Channel Closing Transmission Time	200 milliseconds + an aggregate of 60 milliseconds over remaining 10 second period. See Notes 1 and 2.
U-NII Detection Bandwidth	Minimum 100% of the U-NII 99% transmission power bandwidth. See Note 3.
<p>Note 1: <i>Channel Move Time</i> and the <i>Channel Closing Transmission Time</i> should be performed with Radar Type 0. The measurement timing begins at the end of the Radar Type 0 burst.</p> <p>Note 2: The <i>Channel Closing Transmission Time</i> is comprised of 200 milliseconds starting at the beginning of the <i>Channel Move Time</i> plus any additional intermittent control signals required facilitating a <i>Channel move</i> (an aggregate of 60 milliseconds) during the remainder of the 10 second period. The aggregate duration of control signals will not count quiet periods in between transmissions.</p> <p>Note 3: During the <i>U-NII Detection Bandwidth</i> detection test, radar type 0 should be used. For each frequency step, the minimum percentage of detection is 90 percent. Measurements are performed with no data traffic.</p>	



Unless otherwise agreed in writing, this document is issued by the Company subject to its General Conditions of Service printed overleaf, available on request or accessible at <http://www.sgs.com/en/Terms-and-Conditions.aspx> and, for electronic format documents, subject to Terms and Conditions for Electronic Documents at <http://www.sgs.com/en/Terms-and-Conditions/Terms-e-Documents.aspx>. Attention is drawn to the limitation of liability, indemnification and jurisdiction issues defined therein. Any holder of this document is advised that information contained hereon reflects the Company's findings at the time of its intervention only and within the limits of Client's instructions, if any. The Company's sole responsibility is to its Client and this document does not exonerate parties to a transaction from exercising all their rights and obligations under the transaction documents. This document cannot be reproduced except in full, without prior written approval of the Company. Any unauthorized alteration, forgery or falsification of the content or appearance of this document is unlawful and offenders may be prosecuted to the fullest extent of the law. Unless otherwise stated the results shown in this test report refer only to the sample(s) tested and such sample(s) are retained for 30 days only.  
**Attention: To check the authenticity of testing /inspection report & certificate, please contact us at telephone: (86-755) 8307 1443, or email: CN.Doccheck@sgs.com**

Fuyong Lab, Xinlong TechnoPark, Fengtang Road, Fuyong Subdistrict, Bao'an, Shenzhen, China 518103 t (86-755) 88663988 f (86-755) 26710594 www.sgs.com.cn  
 中国·深圳·宝安区福永街道凤塘大道鑫龙科技园福永实验室 邮编: 518103 t (86-755) 88663988 f (86-755) 26710594 sgs.china@sgs.com

**6.4 RADAR TEST WAVEFORMS**

This section provides the parameters for required test waveforms, minimum percentage of successful detections, and the minimum number of trials that must be used for determining DFS conformance. Step intervals of 0.1 microsecond for Pulse Width, 1 microsecond for PRI, 1 MHz for chirp width and 1 for the number of pulses will be utilized for the random determination of specific test waveforms.

**6.4.1 Short Pulse Radar Test Waveforms**

**Table 5 Short Pulse Radar Test Waveforms**

Radar Type	Pulse Width (μsec)	PRI (μsec)	Number of Pulses	Minimum Percentage of Successful Detection	Minimum Number of Trials
0	1	1428	18	See Note 1	See Note 1
1	1	<b>Test A</b>	Roundup $\left\{ \begin{matrix} \left( \frac{1}{360} \right) \cdot \\ \left( \frac{19 \cdot 10^6}{PRI_{\mu sec}} \right) \end{matrix} \right\}$	60%	30
		<b>Test B</b>			
2	1-5	150-230	23-29	60%	30
3	6-10	200-500	16-18	60%	30
4	11-20	200-500	12-16	60%	30
Aggregate (Radar Types 1-4)				80%	120
Note 1:	Short Pulse Radar Type 0 should be used for the detection bandwidth test, channel move time, and channel closing time tests.				
Test A:	15 unique PRI values randomly selected from the list of 23 PRI values in Table 5a				
Test B:	15 unique PRI values randomly selected within the range of 518-3066 μsec, with a minimum increment of 1 μsec, excluding PRI values selected in Test A				

A minimum of 30 unique waveforms are required for each of the Short Pulse Radar Types 2 through 4. If more than 30 waveforms are used for Short Pulse Radar Types 2 through 4, then each additional waveform must also be unique and not repeated from the previous waveforms. If more than 30 waveforms are used for Short Pulse Radar Type 1, then each additional waveform is generated with Test B and must also be unique and not repeated from the previous waveforms in Tests A or B.

The aggregate is the average of the percentage of successful detections of Short Pulse Radar Types 1-4.



Unless otherwise agreed in writing, this document is issued by the Company subject to its General Conditions of Service printed overleaf, available on request or accessible at <http://www.sgs.com/en/Terms-and-Conditions.aspx> and, for electronic format documents, subject to Terms and Conditions for Electronic Documents at <http://www.sgs.com/en/Terms-and-Conditions/Terms-e-Documents.aspx>. Attention is drawn to the limitation of liability, indemnification and jurisdiction issues defined therein. Any holder of this document is advised that information contained hereon reflects the Company's findings at the time of its intervention only and within the limits of Client's instructions, if any. The Company's sole responsibility is to its Client and this document does not exonerate parties to a transaction from exercising all their rights and obligations under the transaction documents. This document cannot be reproduced except in full, without prior written approval of the Company. Any unauthorized alteration, forgery or falsification of the content or appearance of this document is unlawful and offenders may be prosecuted to the fullest extent of the law. Unless otherwise stated the results shown in this test report refer only to the sample(s) tested and such sample(s) are retained for 30 days only. Attention: To check the authenticity of testing/inspection report & certificate, please contact us at telephone: (86-755) 8307 1443, or email: CN.Doccheck@sgs.com

Fuyong Lab, Xinlong TechnoPark, Fengtang Road, Fuyong Subdistrict, Bao'an, Shenzhen, China 518103 t (86-755) 88663988 f (86-755) 26710594 www.sgs.com.cn  
 中国·深圳·宝安区福永街道凤塘大道鑫龙科技园福永实验室 邮编: 518103 t (86-755) 88663988 f (86-755) 26710594 sgs.china@sgs.com

**Table 5a - Pulse Repetition Intervals Values for Test A**

Pulse Repetition Frequency Number	Pulse Repetition Frequency (Pulses Per Second)	Pulse Repetition Interval (Microseconds)
1	1930.5	518
2	1858.7	538
3	1792.1	558
4	1730.1	578
5	1672.2	598
6	1618.1	618
7	1567.4	638
8	1519.8	658
9	1474.9	678
10	1432.7	698
11	1392.8	718
12	1355	738
13	1319.3	758
14	1285.3	778
15	1253.1	798
16	1222.5	818
17	1193.3	838
18	1165.6	858
19	1139	878
20	1113.6	898
21	1089.3	918
22	1066.1	938
23	326.2	3066



Unless otherwise agreed in writing, this document is issued by the Company subject to its General Conditions of Service printed overleaf, available on request or accessible at <http://www.sgs.com/en/Terms-and-Conditions.aspx> and, for electronic format documents, subject to Terms and Conditions for Electronic Documents at <http://www.sgs.com/en/Terms-and-Conditions/Terms-e-Documents.aspx>. Attention is drawn to the limitation of liability, indemnification and jurisdiction issues defined therein. Any holder of this document is advised that information contained hereon reflects the Company's findings at the time of its intervention only and within the limits of Client's instructions, if any. The Company's sole responsibility is to its Client and this document does not exonerate parties to a transaction from exercising all their rights and obligations under the transaction documents. This document cannot be reproduced except in full, without prior written approval of the Company. Any unauthorized alteration, forgery or falsification of the content or appearance of this document is unlawful and offenders may be prosecuted to the fullest extent of the law. Unless otherwise stated the results shown in this test report refer only to the sample(s) tested and such sample(s) are retained for 30 days only. Attention: To check the authenticity of testing /inspection report & certificate, please contact us at telephone: (86-755) 8307 1443, or email: CN.Doccheck@sgs.com

Compliance Certification Services (Kunshan) Inc. Shenzhen Branch

Fuyong lab, Xinlong TechnoPark, Fengtang Road, Fuyong Subdistrict, Bao'an, Shenzhen, China 518103 t (86-755) 88663988 f (86-755) 26710594 www.sgs.com.cn  
 中国·深圳·宝安区福永街道凤塘大道鑫龙科技园福永实验室 邮编: 518103 t (86-755) 88663988 f (86-755) 26710594 sgs.china@sgs.com

**6.4.2 Long Pulse Radar Test Waveforms**

**Table 6 – Long Pulse Radar Test Waveform**

Radar Type	Pulse Width (µsec)	Chirp Width (MHz)	PRI (µsec)	Number of Pulses per Burst	Number of Bursts	Minimum Percentage of Successful Detection	Minimum Number of Trials
5	50-100	5-20	1000-2000	1-3	8-20	80%	30

The parameters for this waveform are randomly chosen. Thirty unique waveforms are required for the Long Pulse Radar Type waveforms. If more than 30 waveforms are used for the Long Pulse Radar Type waveforms, then each additional waveform must also be unique and not repeated from the previous waveforms.

Each waveform is defined as follows:

- 1) The transmission period for the Long Pulse Radar test signal is 12 seconds.
- 2) There are a total of 8 to 20 *Bursts* in the 12 second period, with the number of *Bursts* being randomly chosen. This number is *Burst Count*.
- 3) Each *Burst* consists of 1 to 3 pulses, with the number of pulses being randomly chosen. Each *Burst* within the 12 second sequence may have a different number of pulses.
- 4) The pulse width is between 50 and 100 microseconds, with the pulse width being randomly chosen. Each pulse within a *Burst* will have the same pulse width. Pulses in different *Bursts* may have different pulse widths.
- 5) Each pulse has a linear frequency modulated chirp between 5 and 20 MHz, with the chirp width being randomly chosen. Each pulse within a *transmission period* will have the same chirp width. The chirp is centered on the pulse. For example, with a radar frequency of 5300 MHz and a 20 MHz chirped signal, the chirp starts at 5290 MHz and ends at 5310 MHz.
- 6) If more than one pulse is present in a *Burst*, the time between the pulses will be between 1000 and 2000 microseconds, with the time being randomly chosen. If three pulses are present in a *Burst*, the random time interval between the first and second pulses is chosen independently of the random time interval between the second and third pulses.
- 7) The 12 second transmission period is divided into even intervals. The number of intervals is equal to *Burst Count*. Each interval is of length  $(12,000,000 / \text{Burst Count})$  microseconds. Each interval contains one *Burst*. The start time for the *Burst*, relative to the beginning of the interval, is between 1 and  $[(12,000,000 / \text{Burst Count}) - (\text{Total Burst Length}) + (\text{One Random PRI Interval})]$  microseconds, with the start time being randomly chosen. The step interval for the start time is 1 microsecond. The start time for each *Burst* is chosen randomly.

**A representative example of a Long Pulse Radar Type waveform:**

- 1) The total test waveform length is 12 seconds.
- 2) Eight (8) *Bursts* are randomly generated for the *Burst Count*.
- 3) *Burst* 1 has 2 randomly generated pulses.
- 4) The pulse width (for both pulses) is randomly selected to be 75 microseconds.
- 5) The PRI is randomly selected to be at 1213 microseconds.
- 6) *Bursts* 2 through 8 are generated using steps 3 – 5.
- 7) Each *Burst* is contained in even intervals of 1,500,000 microseconds. The starting location for Pulse 1, *Burst* 1 is randomly generated (1 to 1,500,000 minus the total *Burst* 1 length + 1 random PRI interval) at the 325,001 microsecond step. *Bursts* 2 through 8 randomly fall in successive 1,500,000 microsecond intervals (i.e. *Burst* 2 falls



Unless otherwise agreed in writing, this document is issued by the Company subject to its General Conditions of Service printed overleaf, available on request or accessible at <http://www.sgs.com/en/Terms-and-Conditions.aspx> and, for electronic format documents, subject to Terms and Conditions for Electronic Documents at <http://www.sgs.com/en/Terms-and-Conditions/Terms-e-Documents.aspx>. Attention is drawn to the limitation of liability, indemnification and jurisdiction issues defined therein. Any holder of this document is advised that information contained herein reflects the Company's findings at the time of its intervention only and within the limits of Client's instructions, if any. The Company's sole responsibility is to its Client and this document does not exonerate parties to a transaction from exercising all their rights and obligations under the transaction documents. This document cannot be reproduced except in full, without prior written approval of the Company. Any unauthorized alteration, forgery or falsification of the content or appearance of this document is unlawful and offenders may be prosecuted to the fullest extent of the law. Unless otherwise stated the results shown in this test report refer only to the sample(s) tested and such sample(s) are retained for 30 days only.  
**Attention: To check the authenticity of testing /inspection report & certificate, please contact us at telephone: (86-755) 8307 1443, or email: CN.Doccheck@sgs.com**

in the 1,500,001 – 3,000,000 microsecond range).

**6.4.3 Frequency Hopping Radar Test Waveforms**

**Table 7 – Frequency Hopping Radar Test Waveform**

Radar Type	Pulse Width (µsec)	Chirp Width (MHz)	PRI (µsec)	Number of Pulses per Burst	Number of Bursts	Minimum Percentage of Successful Detection	Minimum Number of Trials
6	1	333	9	0.333	300	70%	30

For the Frequency Hopping Radar Type, the same Burst parameters are used for each waveform. The hopping sequence is different for each waveform and a 100-length segment is selected from the hopping sequence defined by the following algorithm:

The first frequency in a hopping sequence is selected randomly from the group of 475 integer frequencies from 5250 – 5724 MHz. Next, the frequency that was just chosen is removed from the group and a frequency is randomly selected from the remaining 474 frequencies in the group. This process continues until all 475 frequencies are chosen for the set. For selection of a random frequency, the frequencies remaining within the group are always treated as equally likely.



Unless otherwise agreed in writing, this document is issued by the Company subject to its General Conditions of Service printed overleaf, available on request or accessible at <http://www.sgs.com/en/Terms-and-Conditions.aspx> and, for electronic format documents, subject to Terms and Conditions for Electronic Documents at <http://www.sgs.com/en/Terms-and-Conditions/Terms-e-Documents.aspx>. Attention is drawn to the limitation of liability, indemnification and jurisdiction issues defined therein. Any holder of this document is advised that information contained hereon reflects the Company's findings at the time of its intervention only and within the limits of Client's instructions, if any. The Company's sole responsibility is to its Client and this document does not exonerate parties to a transaction from exercising all their rights and obligations under the transaction documents. This document cannot be reproduced except in full, without prior written approval of the Company. Any unauthorized alteration, forgery or falsification of the content or appearance of this document is unlawful and offenders may be prosecuted to the fullest extent of the law. Unless otherwise stated the results shown in this test report refer only to the sample(s) tested and such sample(s) are retained for 30 days only. Attention: To check the authenticity of testing /inspection report & certificate, please contact us at telephone: (86-755) 8307 1443, or email: CN.Doccheck@sgs.com



## 7 Calibration of Radar Waveform

### 7.1 Radar Waveform Calibration Procedure

- 1) A 50 ohm load is connected in place of the spectrum analyzer, and the spectrum analyzer is connected to place of the master
- 2) The interference Radar Detection Threshold Level is  $-64\text{dBm} + 3.69\text{dBi} + 1\text{dB} = -59.31\text{dBm}$  that had been taken into account the output power range and antenna gain.
- 3) The following equipment setup was used to calibrate the conducted radar waveform. A vector signal generator was utilized to establish the test signal level for radar type 0. During this process, there were no transmissions by either the master or client device. The spectrum analyzer was switched to the zero spans (time domain) at the frequency of the radar waveform generator. Peak detection was used. The spectrum analyzer resolution bandwidth (RBW) and video bandwidth (VBW) were set to 3 MHz. The spectrum analyzer had offset  $-1.0\text{dB}$  to compensate RF cable loss 1.0dB.
- 4) The vector signal generator amplitude was set so that the power level measured at the spectrum analyzer was  $-64\text{dBm} + 3.69\text{dBi} + 1\text{dB} = -59.31\text{dBm}$ . Capture the spectrum analyzer plots on short pulse radar waveform.

### 7.2 Conducted Calibration Setup

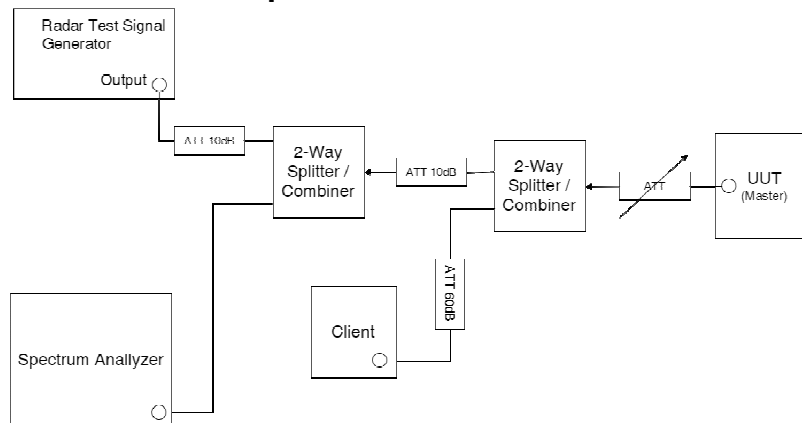

Unless otherwise agreed in writing, this document is issued by the Company subject to its General Conditions of Service printed overleaf, available on request or accessible at <http://www.sgs.com/en/Terms-and-Conditions.aspx> and, for electronic format documents, subject to Terms and Conditions for Electronic Documents at <http://www.sgs.com/en/Terms-and-Conditions/Terms-e-Documents.aspx>. Attention is drawn to the limitation of liability, indemnification and jurisdiction issues defined therein. Any holder of this document is advised that information contained hereon reflects the Company's findings at the time of its intervention only and within the limits of Client's instructions, if any. The Company's sole responsibility is to its Client and this document does not exonerate parties to a transaction from exercising all their rights and obligations under the transaction documents. This document cannot be reproduced except in full, without prior written approval of the Company. Any unauthorized alteration, forgery or falsification of the content or appearance of this document is unlawful and offenders may be prosecuted to the fullest extent of the law. Unless otherwise stated the results shown in this test report refer only to the sample(s) tested and such sample(s) are retained for 30 days only.  
**Attention: To check the authenticity of testing/inspection report & certificate, please contact us at telephone: (86-755) 8307 1443, or email: CN.Doccheck@sgs.com**

### 7.3 Radar Waveform Calibration Result

#### Radar Type 0

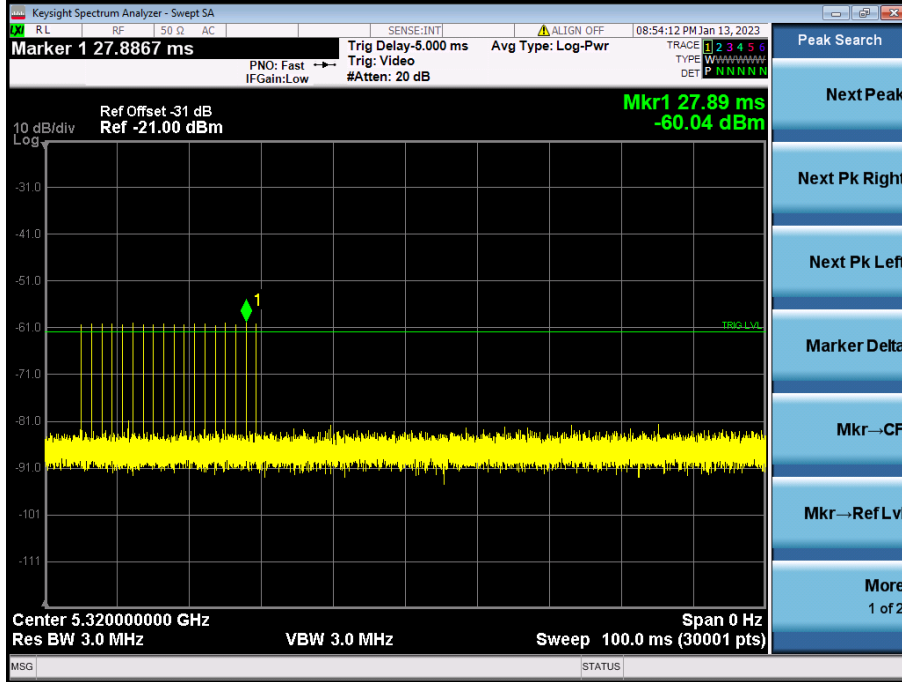

#### Radar Type 1

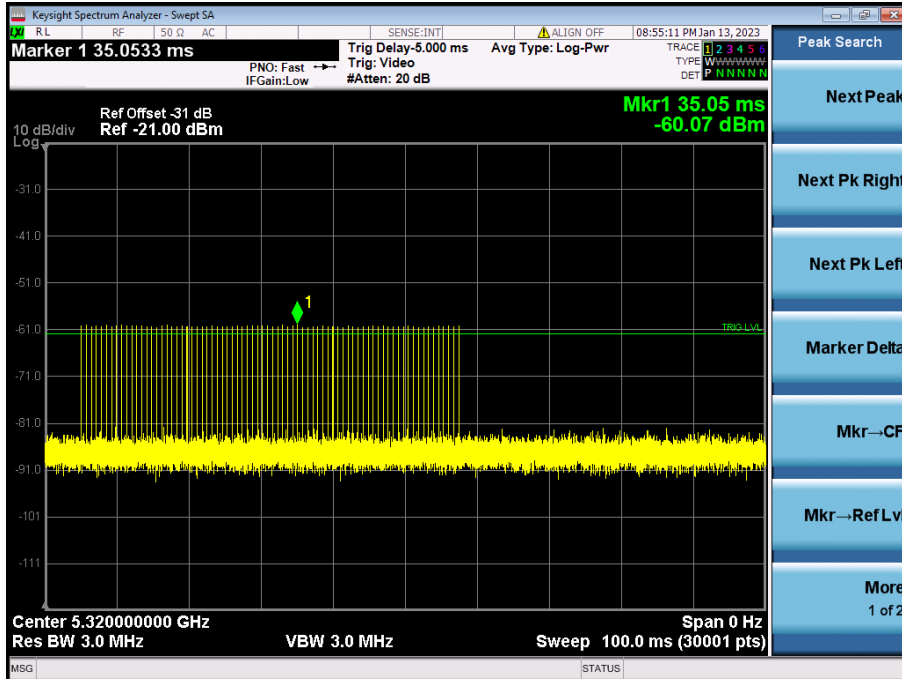

Unless otherwise agreed in writing, this document is issued by the Company subject to its General Conditions of Service printed overleaf, available on request or accessible at <http://www.sgs.com/en/Terms-and-Conditions.aspx> and, for electronic format documents, subject to Terms and Conditions for Electronic Documents at <http://www.sgs.com/en/Terms-and-Conditions/Terms-e-Documents.aspx>. Attention is drawn to the limitation of liability, indemnification and jurisdiction issues defined therein. Any holder of this document is advised that information contained hereon reflects the Company's findings at the time of its intervention only and within the limits of Client's instructions, if any. The Company's sole responsibility is to its Client and this document does not exonerate parties to a transaction from exercising all their rights and obligations under the transaction documents. This document cannot be reproduced except in full, without prior written approval of the Company. Any unauthorized alteration, forgery or falsification of the content or appearance of this document is unlawful and offenders may be prosecuted to the fullest extent of the law. Unless otherwise stated the results shown in this test report refer only to the sample(s) tested and such sample(s) are retained for 30 days only.

Attention: To check the authenticity of testing/inspection report & certificate, please contact us at telephone: (86-755) 8307 1443, or email: CN.Doccheck@sgs.com

Fuyong lab, Xinlong TechnoPark, Fengtang Road, Fuyong Subdistrict, Bao'an, Shenzhen, China 518103 t (86-755) 88663988 f (86-755) 26710594 www.sgs.com.cn  
 中国·深圳·宝安区福永街道凤塘大道鑫龙科技园福永实验室 邮编: 518103 t (86-755) 88663988 f (86-755) 26710594 sgs.china@sgs.com

## Compliance Certification Services (Kunshan) Inc. Shenzhen Branch

SZCCS-TRF-01 Rev. A/0 Aug01,2022

Report No.: FYCR221200049005

Page: 19 of 115

### Radar Type 2

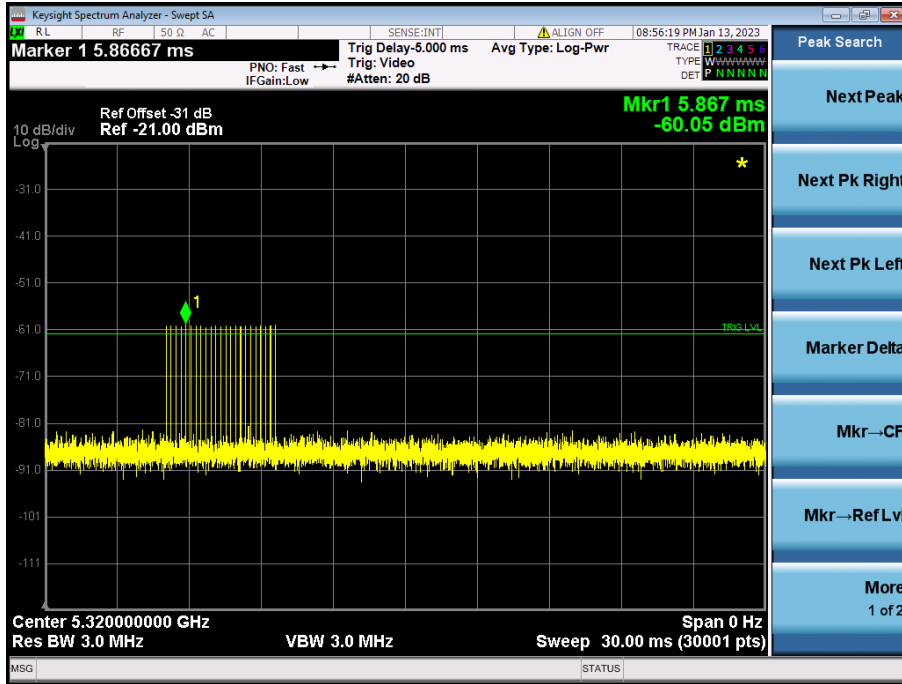

### Radar Type 3

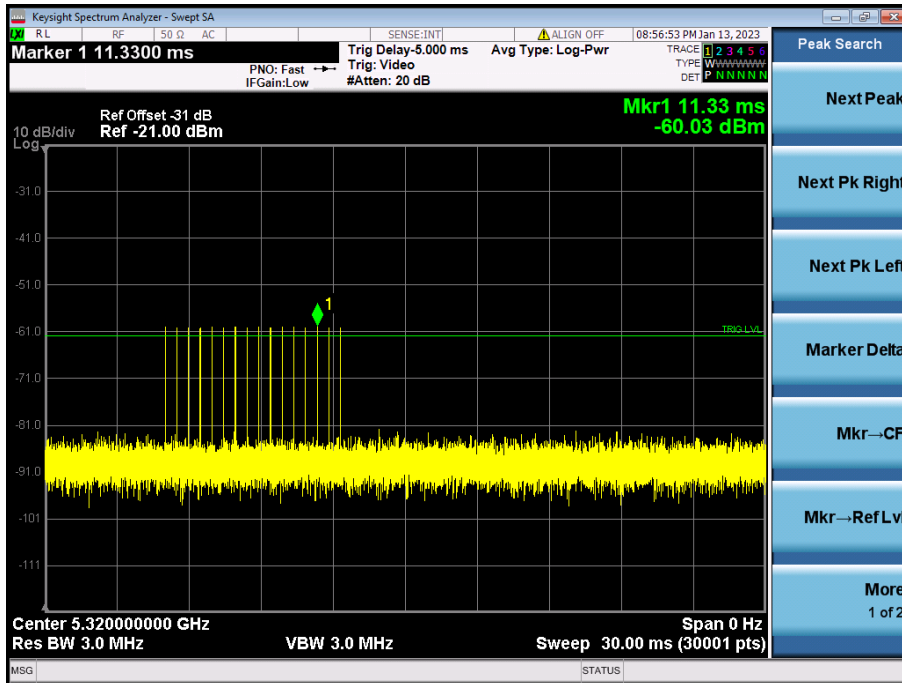

Unless otherwise agreed in writing, this document is issued by the Company subject to its General Conditions of Service printed overleaf, available on request or accessible at <http://www.sgs.com/en/Terms-and-Conditions.aspx> and, for electronic format documents, subject to Terms and Conditions for Electronic Documents at <http://www.sgs.com/en/Terms-and-Conditions/Terms-e-Documents.aspx>. Attention is drawn to the limitation of liability, indemnification and jurisdiction issues defined therein. Any holder of this document is advised that information contained hereon reflects the Company's findings at the time of its intervention only and within the limits of Client's instructions, if any. The Company's sole responsibility is to its Client and this document does not exonerate parties to a transaction from exercising all their rights and obligations under the transaction documents. This document cannot be reproduced except in full, without prior written approval of the Company. Any unauthorized alteration, forgery or falsification of the content or appearance of this document is unlawful and offenders may be prosecuted to the fullest extent of the law. Unless otherwise stated the results shown in this test report refer only to the sample(s) tested and such sample(s) are retained for 30 days only.  
**Attention: To check the authenticity of testing/inspection report & certificate, please contact us at telephone: (86-755) 8307 1443, or email: CN.Doccheck@sgs.com**

Fuyong lab, Xinlong TechnoPark, Fengtang Road, Fuyong Subdistrict, Bao'an, Shenzhen, China 518103 t (86-755) 88663988 f (86-755) 26710594 www.sgs.com.cn  
 中国·深圳·宝安区福永街道凤塘大道鑫龙科技园福永实验室 邮编: 518103 t (86-755) 88663988 f (86-755) 26710594 sgs.china@sgs.com

## Compliance Certification Services (Kunshan) Inc. Shenzhen Branch

SZCCS-TRF-01 Rev. A/0 Aug01,2022

Report No.: FYCR221200049005

Page: 20 of 115

### Radar Type 4

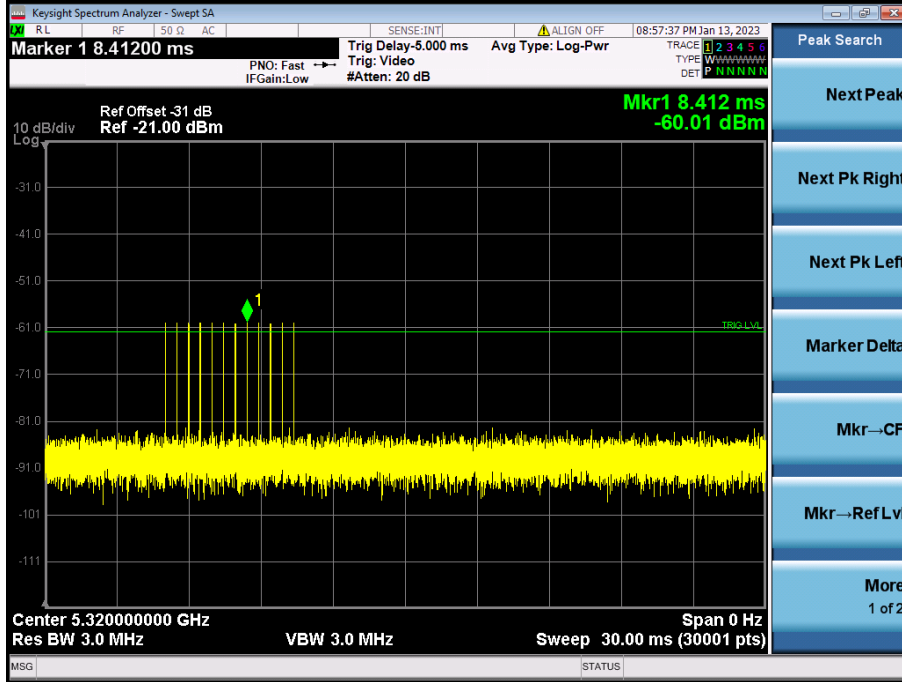

### Radar Type 5

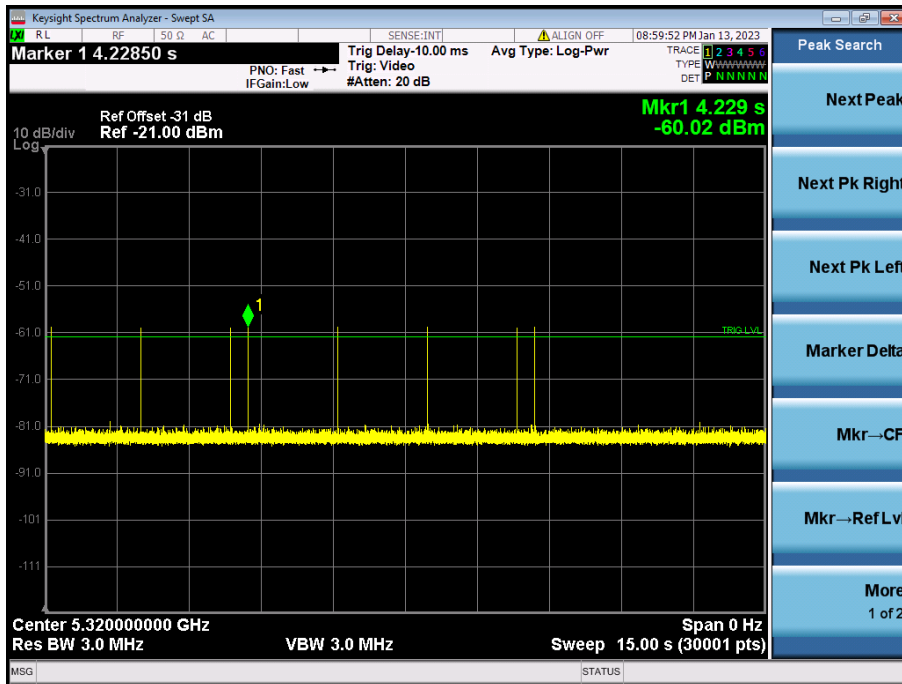

Unless otherwise agreed in writing, this document is issued by the Company subject to its General Conditions of Service printed overleaf, available on request or accessible at <http://www.sgs.com/en/Terms-and-Conditions.aspx> and, for electronic format documents, subject to Terms and Conditions for Electronic Documents at <http://www.sgs.com/en/Terms-and-Conditions/Terms-e-Documents.aspx>. Attention is drawn to the limitation of liability, indemnification and jurisdiction issues defined therein. Any holder of this document is advised that information contained hereon reflects the Company's findings at the time of its intervention only and within the limits of Client's instructions, if any. The Company's sole responsibility is to its Client and this document does not exonerate parties to a transaction from exercising all their rights and obligations under the transaction documents. This document cannot be reproduced except in full, without prior written approval of the Company. Any unauthorized alteration, forgery or falsification of the content or appearance of this document is unlawful and offenders may be prosecuted to the fullest extent of the law. Unless otherwise stated the results shown in this test report refer only to the sample(s) tested and such sample(s) are retained for 30 days only.  
**Attention: To check the authenticity of testing /inspection report & certificate, please contact us at telephone: (86-755) 8307 1443, or email: CN.Doccheck@sgs.com**

Fuyong lab, Xinlong TechnoPark, Fengtang Road, Fuyong Subdistrict, Bao'an, Shenzhen, China 518103 t (86-755) 88663988 f (86-755) 26710594 www.sgs.com.cn  
 中国·深圳·宝安区福永街道凤塘大道鑫龙科技园福永实验室 邮编: 518103 t (86-755) 88663988 f (86-755) 26710594 sgs.china@sgs.com

## Compliance Certification Services (Kunshan) Inc. Shenzhen Branch

SZCCS-TRF-01 Rev. A/0 Aug01,2022

Report No.: FYCR221200049005

Page: 21 of 115

### Radar Type 6

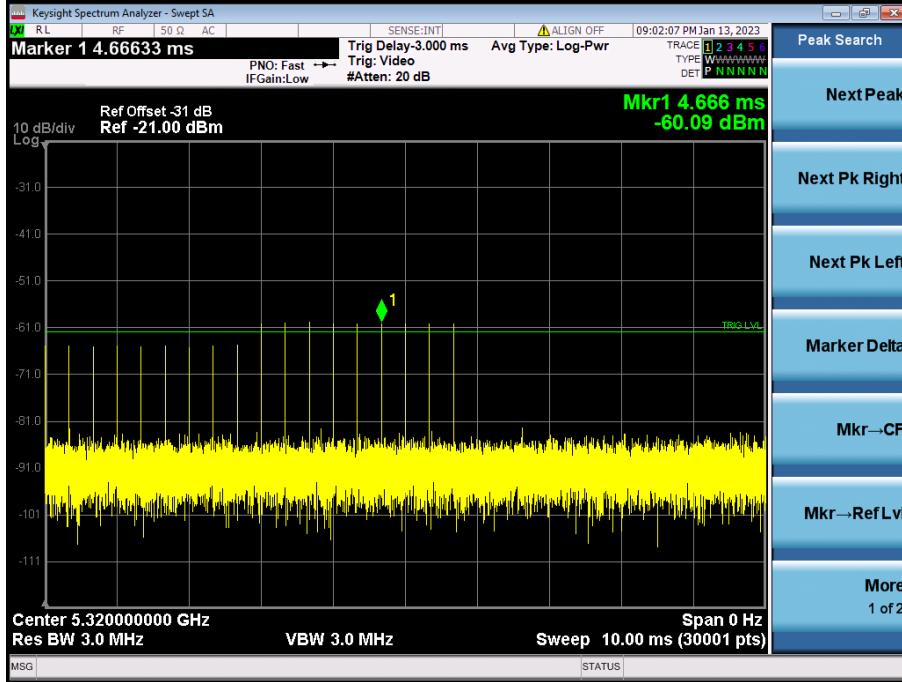

Unless otherwise agreed in writing, this document is issued by the Company subject to its General Conditions of Service printed overleaf, available on request or accessible at <http://www.sgs.com/en/Terms-and-Conditions.aspx> and, for electronic format documents, subject to Terms and Conditions for Electronic Documents at <http://www.sgs.com/en/Terms-and-Conditions/Terms-e-Documents.aspx>. Attention is drawn to the limitation of liability, indemnification and jurisdiction issues defined therein. Any holder of this document is advised that information contained hereon reflects the Company's findings at the time of its intervention only and within the limits of Client's instructions, if any. The Company's sole responsibility is to its Client and this document does not exonerate parties to a transaction from exercising all their rights and obligations under the transaction documents. This document cannot be reproduced except in full, without prior written approval of the Company. Any unauthorized alteration, forgery or falsification of the content or appearance of this document is unlawful and offenders may be prosecuted to the fullest extent of the law. Unless otherwise stated the results shown in this test report refer only to the sample(s) tested and such sample(s) are retained for 30 days only. Attention: To check the authenticity of testing /inspection report & certificate, please contact us at telephone: (86-755) 8307 1443, or email: CN.Doccheck@sgs.com

Fuyong lab, Xinlong TechnoPark, Fengtang Road, Fuyong Subdistrict, Bao'an, Shenzhen, China 518103 t (86-755) 88663988 f (86-755) 26710594 www.sgs.com.cn  
 中国·深圳·宝安区福永街道凤塘大道鑫龙科技园福永实验室 邮编: 518103 t (86-755) 88663988 f (86-755) 26710594 sgs.china@sgs.com

### 8 DFS Test Results

#### 8.1 Conducted Test Setup Configuration

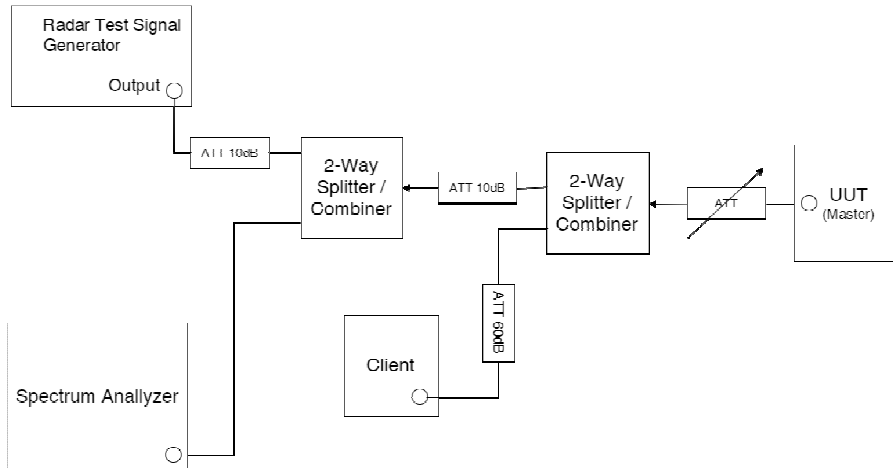

#### Channel Loading

System testing will be performed with channel-loading using means appropriate to the data types that are used by the unlicensed device. The following requirements apply:

<input checked="" type="checkbox"/>	a) The data file must be of a type that is typical for the device (i.e., MPEG-2, MPEG-4, WAV, MP3, MP4, AVI, etc.) and must generally be transmitting in a streaming mode.
<input checked="" type="checkbox"/>	b) Software to ping the client is permitted to simulate data transfer but must have random ping intervals.
<input checked="" type="checkbox"/>	c) Timing plots are required with calculations demonstrating a minimum channel loading of approximately 17% or greater. For example, channel loading can be estimated by setting the spectrum analyzer for zero span and approximate the Time On/ (Time On + Off Time). This can be done with any appropriate channel BW and modulation type.
<input checked="" type="checkbox"/>	d) Unicast or Multicast protocols are preferable but other protocols may be used. The appropriate protocol used must be described in the test procedures.



Unless otherwise agreed in writing, this document is issued by the Company subject to its General Conditions of Service printed overleaf, available on request or accessible at <http://www.sgs.com/en/Terms-and-Conditions.aspx> and, for electronic format documents, subject to Terms and Conditions for Electronic Documents at <http://www.sgs.com/en/Terms-and-Conditions/Terms-e-Document.aspx>. Attention is drawn to the limitation of liability, indemnification and jurisdiction issues defined therein. Any holder of this document is advised that information contained hereon reflects the Company's findings at the time of its intervention only and within the limits of Client's instructions, if any. The Company's sole responsibility is to its Client and this document does not exonerate parties to a transaction from exercising all their rights and obligations under the transaction documents. This document cannot be reproduced except in full, without prior written approval of the Company. Any unauthorized alteration, forgery or falsification of the content or appearance of this document is unlawful and offenders may be prosecuted to the fullest extent of the law. Unless otherwise stated the results shown in this test report refer only to the sample(s) tested and such sample(s) are retained for 30 days only.  
**Attention: To check the authenticity of testing/inspection report & certificate, please contact us at telephone: (86-755) 8307 1443, or email: CN.Doccheck@sgs.com**

**8.2 U-NII Detection Bandwidth (7.8.1)**

**8.2.1 Limit of U-NII Detection Bandwidth**

The U-NII Detection Bandwidth shall contain minimum 100% of the 99% power bandwidth.

**8.2.2 Test Procedure**

1. Adjust the equipment to produce a single *Burst* of any one of the Short Pulse Radar Types 0 – 4 in **Table 5** at the center frequency of the UUT *Operating Channel* at the specified *DFS Detection Threshold* level found in **Table 3**.
2. Set the UUT up as a standalone device (no associated Client or Master, as appropriate) and no traffic. Frame based systems will be set to a talk/listen ratio reflecting the worst case (maximum) that is user configurable during this test.
3. Generate a single radar *Burst*, and note the response of the UUT. Repeat for a minimum of 10 trials. The UUT must detect the *Radar Waveform* within the DFS band using the specified *U-NII Detection Bandwidth* criterion shown in **Table 4**. In cases where the channel bandwidth may exceed past the DFS band edge on specific channels (i.e., 802.11ac or wideband frame based systems) select a channel that has the entire emission bandwidth within the DFS band. If this is not possible, test the detection BW to the DFS band edge.
4. Starting at the center frequency of the UUT operating *Channel*, increase the radar frequency in 5 MHz steps, repeating the above test sequence, until the detection rate falls below the *U-NII Detection Bandwidth* criterion specified in **Table 4**. Repeat this measurement in 1MHz steps at frequencies 5 MHz below where the detection rate begins to fall. Record the highest frequency (denote as  $F_H$ ) at which detection is greater than or equal to the *U-NII Detection Bandwidth* criterion. Recording the detection rate at frequencies above  $F_H$  is not required to demonstrate compliance.
5. Starting at the center frequency of the UUT operating *Channel*, decrease the radar frequency in 5 MHz steps, repeating the above test sequence, until the detection rate falls below the *U-NII Detection Bandwidth* criterion specified in **Table 4**. Repeat this measurement in 1MHz steps at frequencies 5 MHz above where the detection rate begins to fall. Record the lowest frequency (denote as  $F_L$ ) at which detection is greater than or equal to the *U-NII Detection Bandwidth* criterion. Recording the detection rate at frequencies below  $F_L$  is not required to demonstrate compliance.

The *U-NII Detection Bandwidth* is calculated as follows:

$$U-NII\ Detection\ Bandwidth = F_H - F_L$$

**8.2.3 Measurement Data**

During the test, radar type 0 is used and for each frequency step the minimum percentage of detection is 90%.



Unless otherwise agreed in writing, this document is issued by the Company subject to its General Conditions of Service printed overleaf, available on request or accessible at <http://www.sgs.com/en/Terms-and-Conditions.aspx> and, for electronic format documents, subject to Terms and Conditions for Electronic Documents at <http://www.sgs.com/en/Terms-and-Conditions/Terms-e-Documents.aspx>. Attention is drawn to the limitation of liability, indemnification and jurisdiction issues defined therein. Any holder of this document is advised that information contained hereon reflects the Company's findings at the time of its intervention only and within the limits of Client's instructions, if any. The Company's sole responsibility is to its Client and this document does not exonerate parties to a transaction from exercising all their rights and obligations under the transaction documents. This document cannot be reproduced except in full, without prior written approval of the Company. Any unauthorized alteration, forgery or falsification of the content or appearance of this document is unlawful and offenders may be prosecuted to the fullest extent of the law. Unless otherwise stated the results shown in this test report refer only to the sample(s) tested and such sample(s) are retained for 30 days only. Attention: To check the authenticity of testing /inspection report & certificate, please contact us at telephone: (86-755) 8307 1443, or email: CN.Doccheck@sgs.com

Fuyong lab, Xinlong TechnoPark, Fengtang Road, Fuyong Subdistrict, Bao'an, Shenzhen, China 518103 t (86-755) 88663988 f (86-755) 26710594 www.sgs.com.cn  
 中国·深圳·宝安区福永街道凤塘大道鑫龙科技园福永实验室 邮编: 518103 t (86-755) 88663988 f (86-755) 26710594 sgs.china@sgs.com

99% Bandwidth

5320MHz

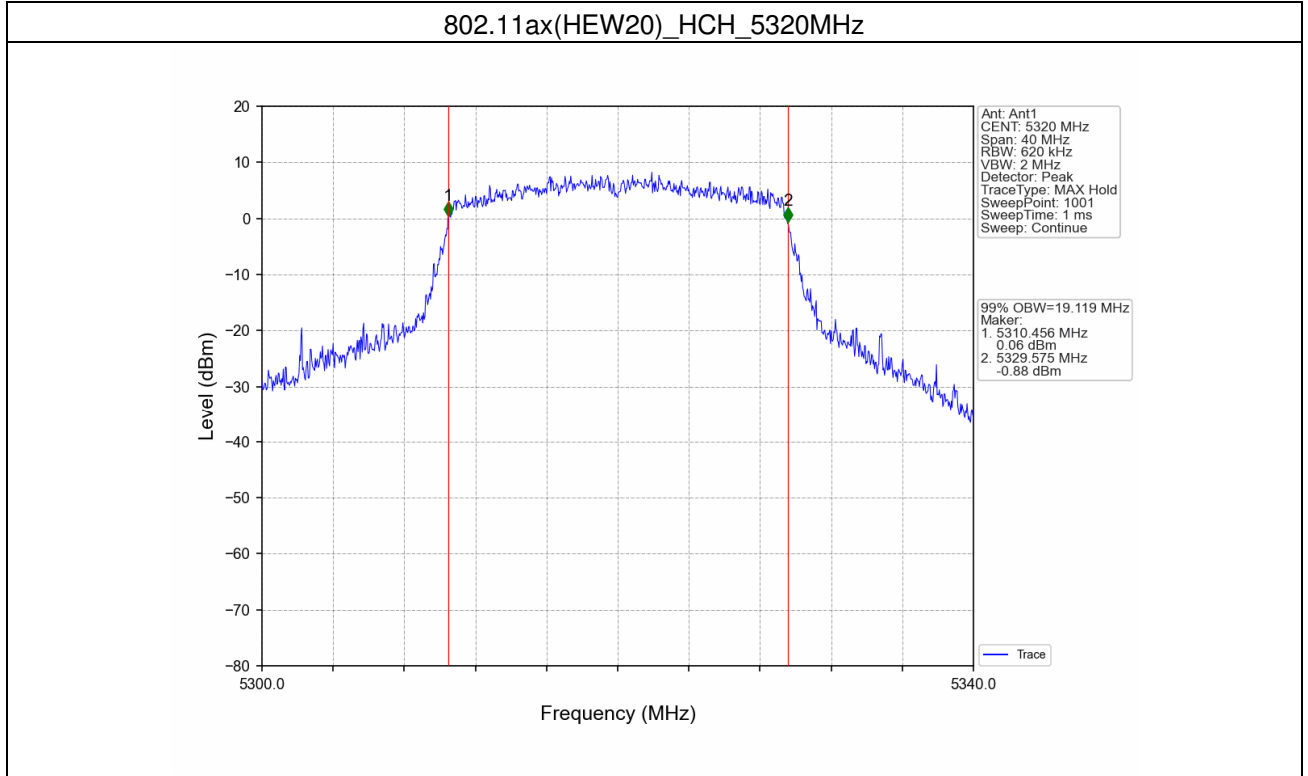

Unless otherwise agreed in writing, this document is issued by the Company subject to its General Conditions of Service printed overleaf, available on request or accessible at <http://www.sgs.com/en/Terms-and-Conditions.aspx> and, for electronic format documents, subject to Terms and Conditions for Electronic Documents at <http://www.sgs.com/en/Terms-and-Conditions/Terms-e-Document.aspx>. Attention is drawn to the limitation of liability, indemnification and jurisdiction issues defined therein. Any holder of this document is advised that information contained hereon reflects the Company's findings at the time of its intervention only and within the limits of Client's instructions, if any. The Company's sole responsibility is to its Client and this document does not exonerate parties to a transaction from exercising all their rights and obligations under the transaction documents. This document cannot be reproduced except in full, without prior written approval of the Company. Any unauthorized alteration, forgery or falsification of the content or appearance of this document is unlawful and offenders may be prosecuted to the fullest extent of the law. Unless otherwise stated the results shown in this test report refer only to the sample(s) tested and such sample(s) are retained for 30 days only.  
**Attention: To check the authenticity of testing /inspection report & certificate, please contact us at telephone: (86-755) 8307 1443, or email: CN.Doccheck@sgs.com**

Compliance Certification Services (Kunshan) Inc.  
 Shenzhen Branch

Fuyong lab, Xinlong TechnoPark, Fengtang Road, Fuyong Subdistrict, Bao'an, Shenzhen, China 518103 t (86-755) 88663988 f (86-755) 26710594 www.sgs.com.cn  
 中国·深圳·宝安区福永街道凤塘大道鑫龙科技园福永实验室 邮编: 518103 t (86-755) 88663988 f (86-755) 26710594 sgs.china@sgs.com



5310MHz

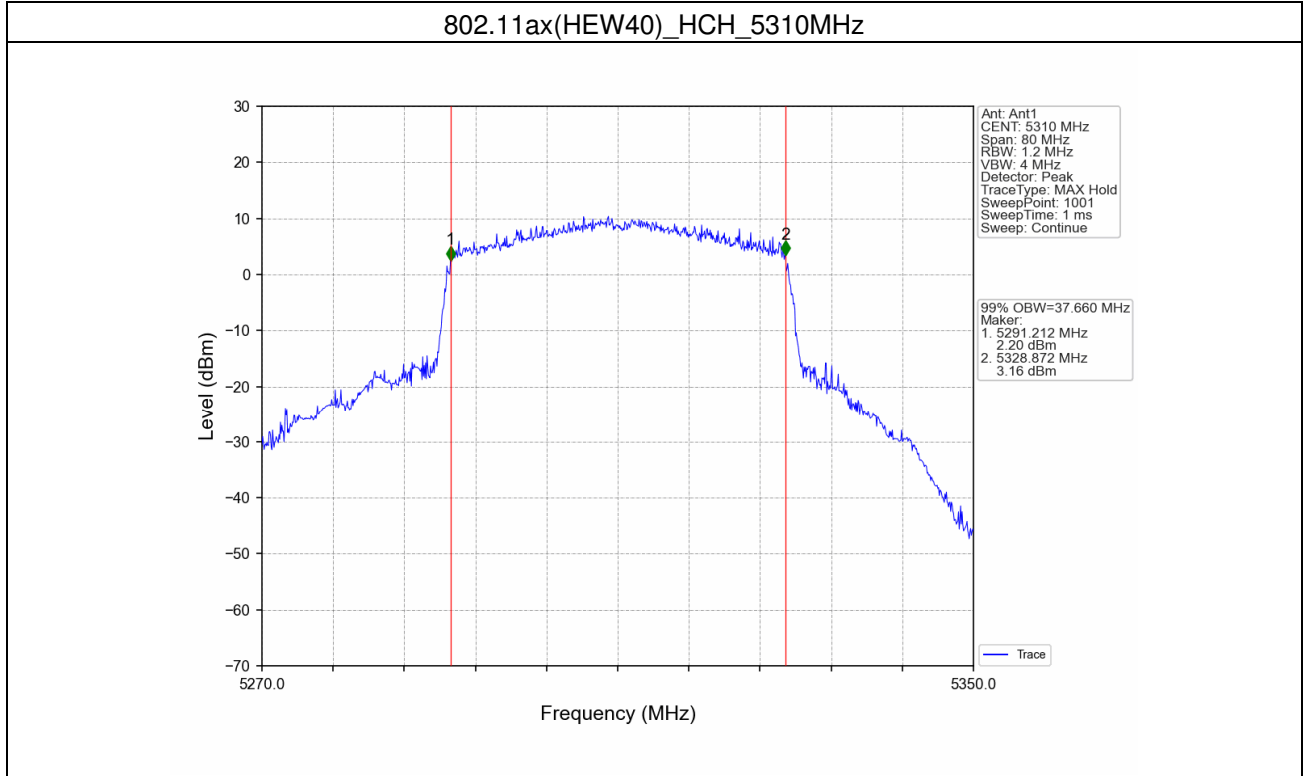

Unless otherwise agreed in writing, this document is issued by the Company subject to its General Conditions of Service printed overleaf, available on request or accessible at <http://www.sgs.com/en/Terms-and-Conditions.aspx> and, for electronic format documents, subject to Terms and Conditions for Electronic Documents at <http://www.sgs.com/en/Terms-and-Conditions/Terms-e-Document.aspx>. Attention is drawn to the limitation of liability, indemnification and jurisdiction issues defined therein. Any holder of this document is advised that information contained hereon reflects the Company's findings at the time of its intervention only and within the limits of Client's instructions, if any. The Company's sole responsibility is to its Client and this document does not exonerate parties to a transaction from exercising all their rights and obligations under the transaction documents. This document cannot be reproduced except in full, without prior written approval of the Company. Any unauthorized alteration, forgery or falsification of the content or appearance of this document is unlawful and offenders may be prosecuted to the fullest extent of the law. Unless otherwise stated the results shown in this test report refer only to the sample(s) tested and such sample(s) are retained for 30 days only.  
**Attention: To check the authenticity of testing /inspection report & certificate, please contact us at telephone: (86-755) 8307 1443, or email: CN.Doccheck@sgs.com**

Compliance Certification Services (Kunshan) Inc.  
 Shenzhen Branch

Fuyong Lab, Xinlong TechnoPark, Fengtang Road, Fuyong Subdistrict, Bao'an, Shenzhen, China 518103 t (86-755) 88663988 f (86-755) 26710594 www.sgs.com.cn  
 中国·深圳·宝安区福永街道凤塘大道鑫龙科技园福永实验室 邮编: 518103 t (86-755) 88663988 f (86-755) 26710594 sgs.china@sgs.com

5290MHz

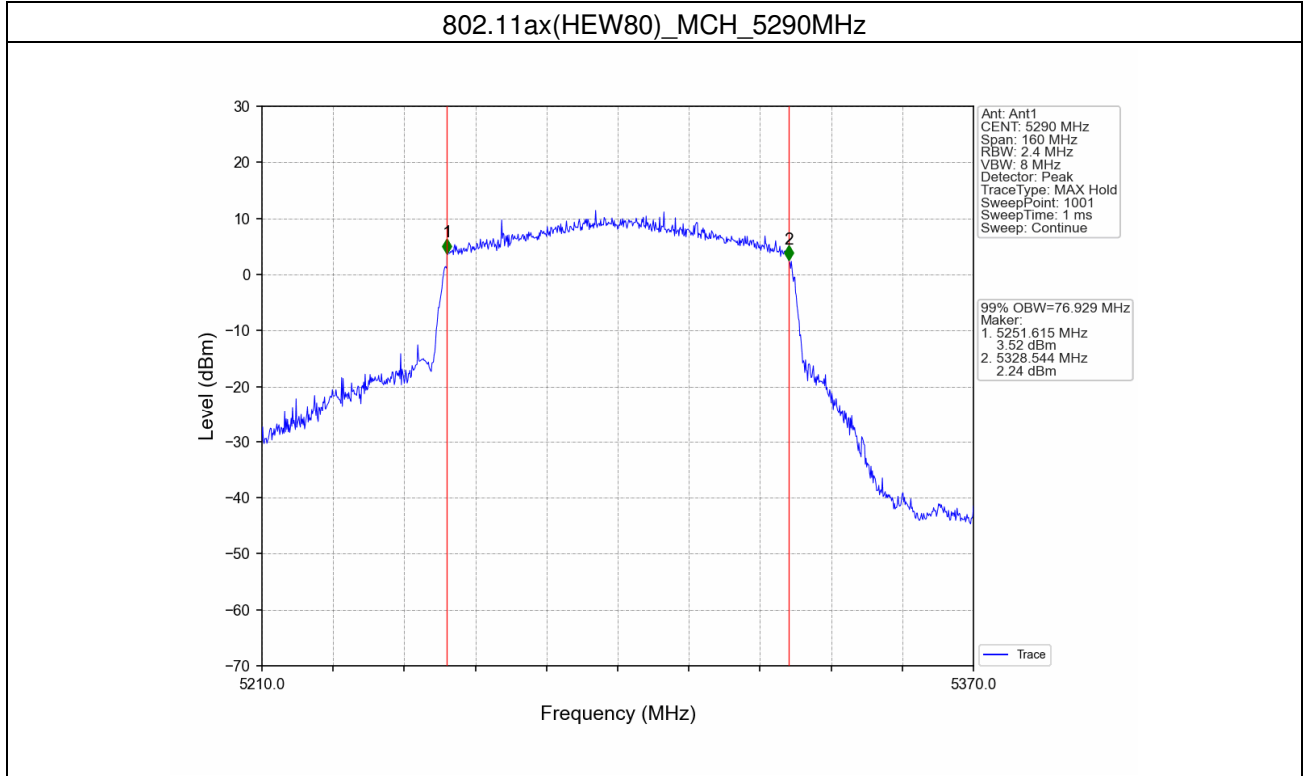

Unless otherwise agreed in writing, this document is issued by the Company subject to its General Conditions of Service printed overleaf, available on request or accessible at <http://www.sgs.com/en/Terms-and-Conditions.aspx> and, for electronic format documents, subject to Terms and Conditions for Electronic Documents at <http://www.sgs.com/en/Terms-and-Conditions/Terms-e-Document.aspx>. Attention is drawn to the limitation of liability, indemnification and jurisdiction issues defined therein. Any holder of this document is advised that information contained hereon reflects the Company's findings at the time of its intervention only and within the limits of Client's instructions, if any. The Company's sole responsibility is to its Client and this document does not exonerate parties to a transaction from exercising all their rights and obligations under the transaction documents. This document cannot be reproduced except in full, without prior written approval of the Company. Any unauthorized alteration, forgery or falsification of the content or appearance of this document is unlawful and offenders may be prosecuted to the fullest extent of the law. Unless otherwise stated the results shown in this test report refer only to the sample(s) tested and such sample(s) are retained for 30 days only.  
**Attention: To check the authenticity of testing /inspection report & certificate, please contact us at telephone: (86-755) 8307 1443, or email: CN.Doccheck@sgs.com**

Compliance Certification Services (Kunshan) Inc. Shenzhen Branch

Fuyong lab, Xinlong TechnoPark, Fengtang Road, Fuyong Subdistrict, Bao'an, Shenzhen, China 518103 t (86-755) 88663988 f (86-755) 26710594 www.sgs.com.cn  
 中国·深圳·宝安区福永街道凤塘大道鑫龙科技园福永实验室 邮编: 518103 t (86-755) 88663988 f (86-755) 26710594 sgs.china@sgs.com

5570MHz

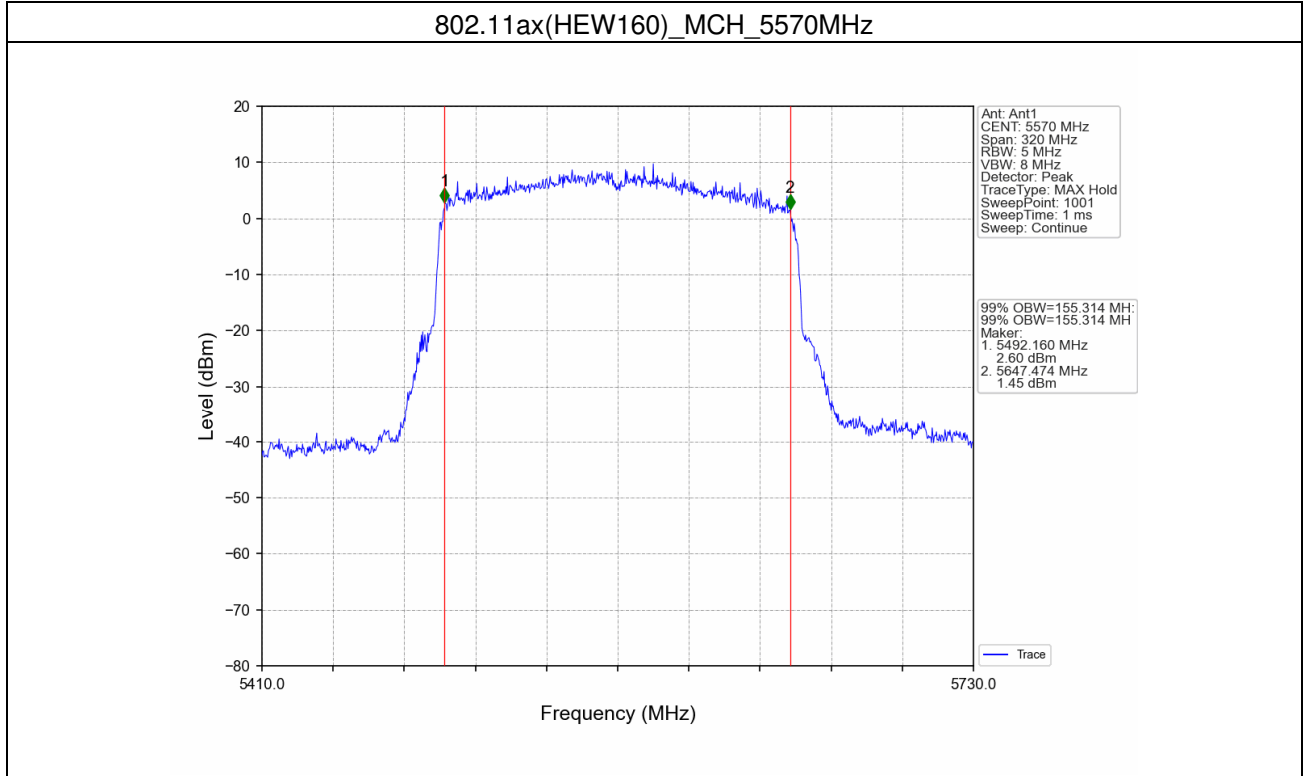

Unless otherwise agreed in writing, this document is issued by the Company subject to its General Conditions of Service printed overleaf, available on request or accessible at <http://www.sgs.com/en/Terms-and-Conditions.aspx> and, for electronic format documents, subject to Terms and Conditions for Electronic Documents at <http://www.sgs.com/en/Terms-and-Conditions/Terms-e-Document.aspx>. Attention is drawn to the limitation of liability, indemnification and jurisdiction issues defined therein. Any holder of this document is advised that information contained hereon reflects the Company's findings at the time of its intervention only and within the limits of Client's instructions, if any. The Company's sole responsibility is to its Client and this document does not exonerate parties to a transaction from exercising all their rights and obligations under the transaction documents. This document cannot be reproduced except in full, without prior written approval of the Company. Any unauthorized alteration, forgery or falsification of the content or appearance of this document is unlawful and offenders may be prosecuted to the fullest extent of the law. Unless otherwise stated the results shown in this test report refer only to the sample(s) tested and such sample(s) are retained for 30 days only.  
**Attention: To check the authenticity of testing /inspection report & certificate, please contact us at telephone: (86-755) 8307 1443, or email: CN.Doccheck@sgs.com**

Compliance Certification Services (Kunshan) Inc.  
 Shenzhen Branch

Fuyong Lab, Xinlong TechnoPark, Fengtang Road, Fuyong Subdistrict, Bao'an, Shenzhen, China 518103 t (86-755) 88663988 f (86-755) 26710594 www.sgs.com.cn  
 中国·深圳·宝安区福永街道凤塘大道鑫龙科技园福永实验室 邮编: 518103 t (86-755) 88663988 f (86-755) 26710594 sgs.china@sgs.com

# Compliance Certification Services (Kunshan) Inc. Shenzhen Branch

SZCCS-TRF-01 Rev. A/0 Aug01,2022

Report No.: FYCR221200049005

Page: 28 of 115

## U-NII Detection Bandwidth

Test Channel: 5320MHz		Channel Bandwidth: 20MHz										Detection Rate (%)	F <sub>L</sub> /F <sub>H</sub>
Freq. (MHz)	F <sub>c</sub>	Trial Number and Detection result (Y: Detected; N: Non-detected)											
		0	1	2	3	4	5	6	7	8	9		
5309	-11	N	N	N	N	N	N	N	N	N	N	0	
5310	-10	Y	Y	Y	Y	Y	Y	Y	Y	Y	Y	100	F <sub>L</sub>
5315	-5	Y	Y	Y	Y	Y	Y	Y	Y	Y	Y	100	
5320	0	Y	Y	Y	Y	Y	Y	Y	Y	Y	Y	100	
5325	+5	Y	Y	Y	Y	Y	Y	Y	Y	Y	Y	100	
5330	+10	Y	Y	Y	Y	Y	Y	Y	Y	Y	Y	100	F <sub>H</sub>
5331	+11	N	N	N	N	N	N	N	N	N	N	0	

Detection Bandwidth = F<sub>H</sub> - F<sub>L</sub> = 5330MHz - 5310MHz = 20MHz  
 EUT 99% Bandwidth = 19.119MHz

Test Channel: 5310MHz		Channel Bandwidth: 40MHz										Detection Rate (%)	F <sub>L</sub> /F <sub>H</sub>
Freq. (MHz)	F <sub>c</sub>	Trial Number and Detection result (Y: Detected; N: Non-detected)											
		0	1	2	3	4	5	6	7	8	9		
5289	-21	N	N	N	N	N	N	N	N	N	N	0	
5290	-20	Y	Y	Y	Y	Y	Y	Y	Y	Y	Y	100	F <sub>L</sub>
5295	-15	Y	Y	Y	Y	Y	Y	Y	Y	Y	Y	100	
5300	-10	Y	Y	Y	Y	Y	Y	Y	Y	Y	Y	100	
5305	-5	Y	Y	Y	Y	Y	Y	Y	Y	Y	Y	100	
5310	0	Y	Y	Y	Y	Y	Y	Y	Y	Y	Y	100	
5315	+5	Y	Y	Y	Y	Y	Y	Y	Y	Y	Y	100	
5320	+10	Y	Y	Y	Y	Y	Y	Y	Y	Y	Y	100	
5325	+15	Y	Y	Y	Y	Y	Y	Y	Y	Y	Y	100	
5330	+20	Y	Y	Y	Y	N	Y	Y	Y	Y	Y	90	F <sub>H</sub>

Detection Bandwidth = F<sub>H</sub> - F<sub>L</sub> = 5330MHz - 5290MHz = 40MHz  
 EUT 99% Bandwidth = 37.660MHz



Unless otherwise agreed in writing, this document is issued by the Company subject to its General Conditions of Service printed overleaf, available on request or accessible at <http://www.sgs.com/en/Terms-and-Conditions.aspx> and, for electronic format documents, subject to Terms and Conditions for Electronic Documents at <http://www.sgs.com/en/Terms-and-Conditions/Terms-e-Documents.aspx>. Attention is drawn to the limitation of liability, indemnification and jurisdiction issues defined therein. Any holder of this document is advised that information contained hereon reflects the Company's findings at the time of its intervention only and within the limits of Client's instructions, if any. The Company's sole responsibility is to its Client and this document does not exonerate parties to a transaction from exercising all their rights and obligations under the transaction documents. This document cannot be reproduced except in full, without prior written approval of the Company. Any unauthorized alteration, forgery or falsification of the content or appearance of this document is unlawful and offenders may be prosecuted to the fullest extent of the law. Unless otherwise stated the results shown in this test report refer only to the sample(s) tested and such sample(s) are retained for 30 days only.  
**Attention: To check the authenticity of testing /inspection report & certificate, please contact us at telephone: (86-755) 8307 1443, or email: CN.Doccheck@sgs.com**

Compliance Certification Services (Kunshan) Inc. Shenzhen Branch

Fuyong Lab, Xinlong TechnoPark, Fengtang Road, Fuyong Subdistrict, Bao'an, Shenzhen, China 518103 t (86-755) 88663988 f (86-755) 26710594 www.sgs.com.cn  
 中国·深圳·宝安区福永街道凤塘大道鑫龙科技园福永实验室 邮编: 518103 t (86-755) 88663988 f (86-755) 26710594 sgs.china@sgs.com

# Compliance Certification Services (Kunshan) Inc. Shenzhen Branch

SZCCS-TRF-01 Rev. A/0 Aug01,2022

Report No.: FYCR221200049005

Page: 29 of 115

Test Channel: 5290MHz		Channel Bandwidth: 80MHz										Detection Rate (%)	F <sub>L</sub> /F <sub>H</sub>
Freq. (MHz)	Fc	Trial Number and Detection result (Y: Detected; N: Non-detected)											
		0	1	2	3	4	5	6	7	8	9		
5250	-40	Y	Y	Y	Y	Y	Y	N	Y	Y	Y	90	F <sub>L</sub>
5255	-35	Y	Y	Y	Y	Y	Y	Y	Y	Y	Y	100	
5260	-30	Y	Y	Y	Y	Y	Y	Y	Y	Y	Y	100	
5265	-25	Y	Y	Y	Y	Y	Y	Y	Y	Y	Y	100	
5270	-20	Y	Y	Y	Y	Y	Y	Y	Y	Y	Y	100	
5275	-15	Y	Y	Y	Y	Y	Y	Y	Y	Y	Y	100	
5280	-10	Y	Y	Y	Y	Y	Y	Y	Y	Y	Y	100	
5285	-5	Y	Y	Y	Y	Y	Y	Y	Y	Y	Y	100	
5290	0	Y	Y	Y	Y	Y	Y	Y	Y	Y	Y	100	
5295	+5	Y	Y	Y	Y	Y	Y	Y	Y	Y	Y	100	
5300	+10	Y	Y	Y	Y	Y	Y	Y	Y	Y	Y	100	
5305	+15	Y	Y	Y	Y	Y	Y	Y	Y	Y	Y	100	
5310	+20	Y	Y	Y	Y	Y	Y	Y	Y	Y	Y	100	
5315	+25	Y	Y	Y	Y	Y	Y	Y	Y	Y	Y	100	
5320	+30	Y	Y	Y	Y	Y	Y	Y	Y	Y	Y	100	
5325	+35	Y	Y	Y	Y	Y	Y	Y	Y	Y	Y	100	
5330	+40	Y	N	Y	Y	Y	Y	Y	Y	Y	Y	90	F <sub>H</sub>

Detection Bandwidth = F<sub>H</sub> - F<sub>L</sub> = 5330MHz - 5250MHz = 80MHz

EUT 99% Bandwidth = 76.929MHz



Unless otherwise agreed in writing, this document is issued by the Company subject to its General Conditions of Service printed overleaf, available on request or accessible at <http://www.sgs.com/en/Terms-and-Conditions.aspx> and, for electronic format documents, subject to Terms and Conditions for Electronic Documents at <http://www.sgs.com/en/Terms-and-Conditions/Terms-e-Documents.aspx>. Attention is drawn to the limitation of liability, indemnification and jurisdiction issues defined therein. Any holder of this document is advised that information contained hereon reflects the Company's findings at the time of its intervention only and within the limits of Client's instructions, if any. The Company's sole responsibility is to its Client and this document does not exonerate parties to a transaction from exercising all their rights and obligations under the transaction documents. This document cannot be reproduced except in full, without prior written approval of the Company. Any unauthorized alteration, forgery or falsification of the content or appearance of this document is unlawful and offenders may be prosecuted to the fullest extent of the law. Unless otherwise stated the results shown in this test report refer only to the sample(s) tested and such sample(s) are retained for 30 days only. Attention: To check the authenticity of testing /inspection report & certificate, please contact us at telephone: (86-755) 8307 1443, or email: CN.Doccheck@sgs.com

Fuyong lab, Xinlong TechnoPark, Fengtang Road, Fuyong Subdistrict, Bao'an, Shenzhen, China 518103 t (86-755) 88663988 f (86-755) 26710594 www.sgs.com.cn  
 中国·深圳·宝安区福永街道凤塘大道鑫龙科技园福永实验室 邮编: 518103 t (86-755) 88663988 f (86-755) 26710594 sgs.china@sgs.com

# Compliance Certification Services (Kunshan) Inc. Shenzhen Branch

SZCCS-TRF-01 Rev. A/0 Aug01,2022

Report No.: FYCR221200049005

Page: 30 of 115

Test Channel: 5570MHz		Channel Bandwidth: 160MHz										Detection Rate (%)	F <sub>L</sub> /F <sub>H</sub>
Freq. (MHz)	Fc	Trial Number and Detection result (Y: Detected; N: Non-detected)											
		0	1	2	3	4	5	6	7	8	9		
5490	-80	Y	Y	Y	Y	Y	Y	N	Y	Y	Y	90	F <sub>L</sub>
5500	-70	Y	Y	Y	Y	Y	Y	Y	Y	Y	Y	100	
5510	-60	Y	Y	Y	Y	Y	Y	Y	Y	Y	Y	100	
5520	-50	Y	Y	Y	Y	Y	Y	Y	Y	Y	Y	100	
5530	-40	Y	Y	Y	Y	Y	Y	Y	Y	Y	Y	100	
5540	-30	Y	Y	Y	Y	Y	Y	Y	Y	Y	Y	100	
5550	-20	Y	Y	Y	Y	Y	Y	Y	Y	Y	Y	100	
5560	-10	Y	Y	Y	Y	Y	Y	Y	Y	Y	Y	100	
5570	0	Y	Y	Y	Y	Y	Y	Y	Y	Y	Y	100	
5580	+10	Y	Y	Y	Y	Y	Y	Y	Y	Y	Y	100	
5590	+20	Y	Y	Y	Y	Y	Y	Y	Y	Y	Y	100	
5600	+30	Y	Y	Y	Y	Y	Y	Y	Y	Y	Y	100	
5610	+40	Y	Y	Y	Y	Y	Y	Y	Y	Y	Y	100	
5620	+50	Y	Y	Y	Y	Y	Y	Y	Y	Y	Y	100	
5630	+60	Y	Y	Y	Y	Y	Y	Y	Y	Y	Y	100	
5640	+70	Y	Y	Y	Y	Y	Y	Y	Y	Y	Y	100	
5650	+80	Y	N	Y	Y	Y	Y	Y	Y	Y	Y	90	F <sub>H</sub>

Detection Bandwidth = F<sub>H</sub> - F<sub>L</sub> = 5650MHz - 5490MHz = 160MHz

EUT 99% Bandwidth = 155.314 MHz



Unless otherwise agreed in writing, this document is issued by the Company subject to its General Conditions of Service printed overleaf, available on request or accessible at <http://www.sgs.com/en/Terms-and-Conditions.aspx> and, for electronic format documents, subject to Terms and Conditions for Electronic Documents at <http://www.sgs.com/en/Terms-and-Conditions/Terms-e-Documents.aspx>. Attention is drawn to the limitation of liability, indemnification and jurisdiction issues defined therein. Any holder of this document is advised that information contained hereon reflects the Company's findings at the time of its intervention only and within the limits of Client's instructions, if any. The Company's sole responsibility is to its Client and this document does not exonerate parties to a transaction from exercising all their rights and obligations under the transaction documents. This document cannot be reproduced except in full, without prior written approval of the Company. Any unauthorized alteration, forgery or falsification of the content or appearance of this document is unlawful and offenders may be prosecuted to the fullest extent of the law. Unless otherwise stated the results shown in this test report refer only to the sample(s) tested and such sample(s) are retained for 30 days only. Attention: To check the authenticity of testing /inspection report & certificate, please contact us at telephone: (86-755) 8307 1443, or email: CN.Doccheck@sgs.com

Fuyong lab, Xinlong TechnoPark, Fengtang Road, Fuyong Subdistrict, Bao'an, Shenzhen, China 518103 t (86-755) 88663988 f (86-755) 26710594 www.sgs.com.cn  
 中国·深圳·宝安区福永街道凤塘大道鑫龙科技园福永实验室 邮编: 518103 t (86-755) 88663988 f (86-755) 26710594 sgs.china@sgs.com

**8.3 Channel Availability Check (7.8.2)**

**8.3.1 Limit of Channel Availability Check**

The Initial *Channel Availability Check Time* tests that the UUT does not emit beacon, control, or data signals on the test *Channel* until the power-up sequence has been completed and the U-NII device checks for *Radar Waveforms* for one minute on the test *Channel*.

**8.3.2 Test Procedure**

This test does not use any *Radar Waveforms* and only needs to be performed one time.

1. The U-NII devices will be powered on and be instructed to operate on the appropriate U-NII *Channel* that must incorporate DFS functions. At the same time the UUT is powered on, the spectrum analyzer will be set to zero span mode with a 3 MHz RBW and 3 MHz VBW on the *Channel* occupied by the radar (Chr) with a 2.5 minute sweep time. The spectrum analyzer's sweep will be started at the same time power is applied to the U-NII device.
2. The UUT should not transmit any beacon or data transmissions until at least 1 minute after the completion of the power-on cycle.
3. Confirm that the UUT initiates transmission on the channel

**A) Radar Burst at the Beginning of the Channel Availability Check Time**

The steps below define the procedure to verify successful radar detection on the test *Channel* during a period equal to the *Channel Availability Check Time* and avoidance of operation on that *Channel* when a radar *Burst* with a level equal to the *DFS Detection Threshold* + 1 dB occurs at the beginning of the *Channel Availability Check Time*. This is illustrated in **Figure 15**.

1. The *Radar Waveform* generator and UUT are connected using the applicable test setup described in the sections on configuration for Conducted Tests (7.2) or Radiated Tests (7.3) and the power of the UUT is switched off.
2. The UUT is powered on at T0. T1 denotes the instant when the UUT has completed its power-up sequence (T<sub>power\_up</sub>). The *Channel Availability Check Time* commences on Chr at instant T1 and will end no sooner than T1 + Tch<sub>avail\_check</sub>.
3. A single *Burst* of one of the Short Pulse Radar Types 0-4 will commence within a 6 second window starting at T1. An additional 1 dB is added to the radar test signal to ensure it is at or above the *DFS Detection Threshold*, accounting for equipment variations/errors.
4. Visual indication or measured results on the UUT of successful detection of the radar *Burst* will be recorded and reported. Observation of Chr for UUT emissions will continue for 2.5 minutes after the radar *Burst* has been generated.
5. Verify that during the 2.5 minute measurement window no UUT transmissions occurred on Chr. The *Channel Availability Check* results will be recorded.



Unless otherwise agreed in writing, this document is issued by the Company subject to its General Conditions of Service printed overleaf, available on request or accessible at <http://www.sgs.com/en/Terms-and-Conditions.aspx> and, for electronic format documents, subject to Terms and Conditions for Electronic Documents at <http://www.sgs.com/en/Terms-and-Conditions/Terms-e-Documents.aspx>. Attention is drawn to the limitation of liability, indemnification and jurisdiction issues defined therein. Any holder of this document is advised that information contained hereon reflects the Company's findings at the time of its intervention only and within the limits of Client's instructions, if any. The Company's sole responsibility is to its Client and this document does not exonerate parties to a transaction from exercising all their rights and obligations under the transaction documents. This document cannot be reproduced except in full, without prior written approval of the Company. Any unauthorized alteration, forgery or falsification of the content or appearance of this document is unlawful and offenders may be prosecuted to the fullest extent of the law. Unless otherwise stated the results shown in this test report refer only to the sample(s) tested and such sample(s) are retained for 30 days only. Attention: To check the authenticity of testing /inspection report & certificate, please contact us at telephone: (86-755) 8307 1443, or email: CN.Doccheck@sgs.com

Fuyong Lab, Xinlong TechnoPark, Fengtang Road, Fuyong Subdistrict, Bao'an, Shenzhen, China 518103 t (86-755) 88663988 f (86-755) 26710594 www.sgs.com.cn  
 中国·深圳·宝安区福永街道凤塘大道鑫龙科技园福永实验室 邮编: 518103 t (86-755) 88663988 f (86-755) 26710594 sgs.china@sgs.com

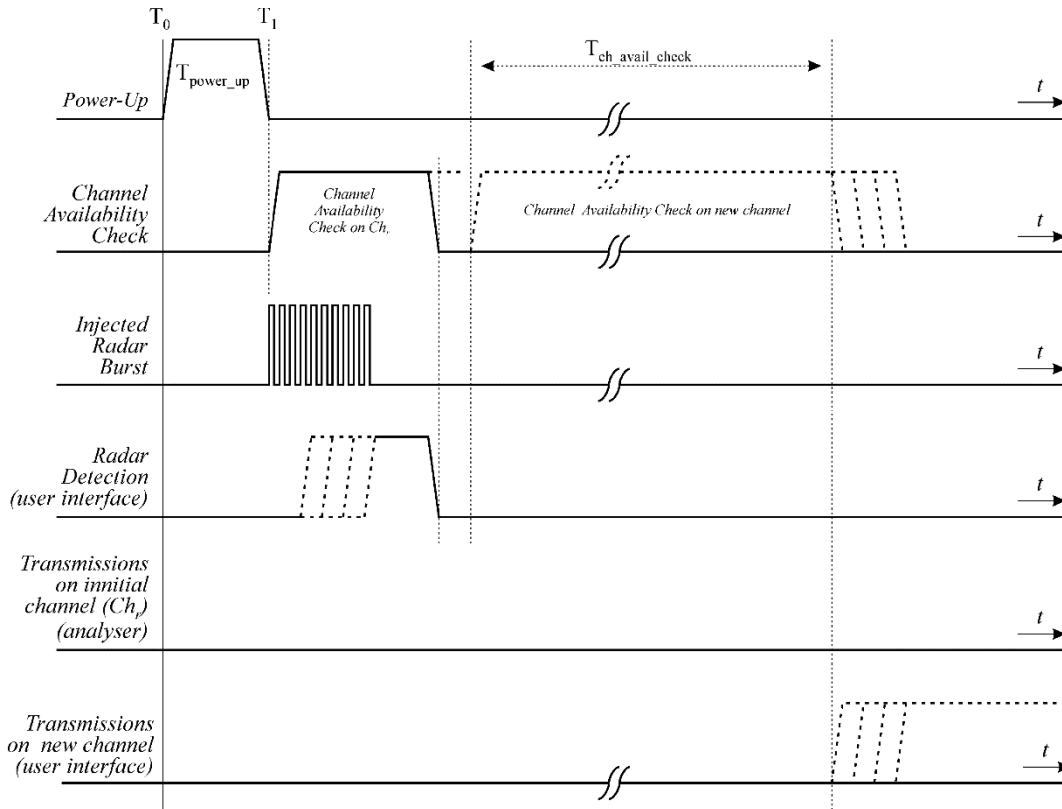

Figure 15: Example of timing for radar testing at the beginning of the Channel Availability Check Time

**B) Radar Burst at the End of the Channel Availability Check Time**

The steps below define the procedure to verify successful radar detection on the test Channel during a period equal to the Channel Availability Check Time and avoidance of operation on that Channel when a radar *Burst* with a level equal to the *DFS Detection Threshold* + 1dB occurs at the end of the Channel Availability Check Time. This is illustrated in **Figure 16**.

1. The *Radar Waveform* generator and UUT are connected using the applicable test setup described in the sections for Conducted Tests (7.2) or Radiated Tests (7.3) and the power of the UUT is switched off.
2. The UUT is powered on at T0. T1 denotes the instant when the UUT has completed its power-up sequence (T<sub>power\_up</sub>). The *Channel Availability Check Time* commences on Chr at instant T1 and will end no sooner than T1 + Tch<sub>avail\_check</sub>.
3. A single *Burst* of one of the Short Pulse Radar Types 0-4 will commence within a 6 second window starting at T1 + 54 seconds. An additional 1 dB is added to the radar test signal to ensure it is at or above the *DFS Detection Threshold*, accounting for equipment variations/errors.
4. Visual indication or measured results on the UUT of successful detection of the radar *Burst* will be recorded and reported. Observation of Chr for UUT emissions will continue for 2.5 minutes after the radar *Burst* has been generated.
5. Verify that during the 2.5 minute measurement window no UUT transmissions occurred on Chr. The *Channel Availability Check* results will be recorded.



Unless otherwise agreed in writing, this document is issued by the Company subject to its General Conditions of Service printed overleaf, available on request or accessible at <http://www.sgs.com/en/Terms-and-Conditions.aspx> and, for electronic format documents, subject to Terms and Conditions for Electronic Documents at <http://www.sgs.com/en/Terms-and-Conditions/Terms-e-Documents.aspx>. Attention is drawn to the limitation of liability, indemnification and jurisdiction issues defined therein. Any holder of this document is advised that information contained hereon reflects the Company's findings at the time of its intervention only and within the limits of Client's instructions, if any. The Company's sole responsibility is to its Client and this document does not exonerate parties to a transaction from exercising all their rights and obligations under the transaction documents. This document cannot be reproduced except in full, without prior written approval of the Company. Any unauthorized alteration, forgery or falsification of the content or appearance of this document is unlawful and offenders may be prosecuted to the fullest extent of the law. Unless otherwise stated the results shown in this test report refer only to the sample(s) tested and such sample(s) are retained for 30 days only. Attention: To check the authenticity of testing/inspection report & certificate, please contact us at telephone: (86-755) 8307 1443, or email: CN.Doccheck@sgs.com



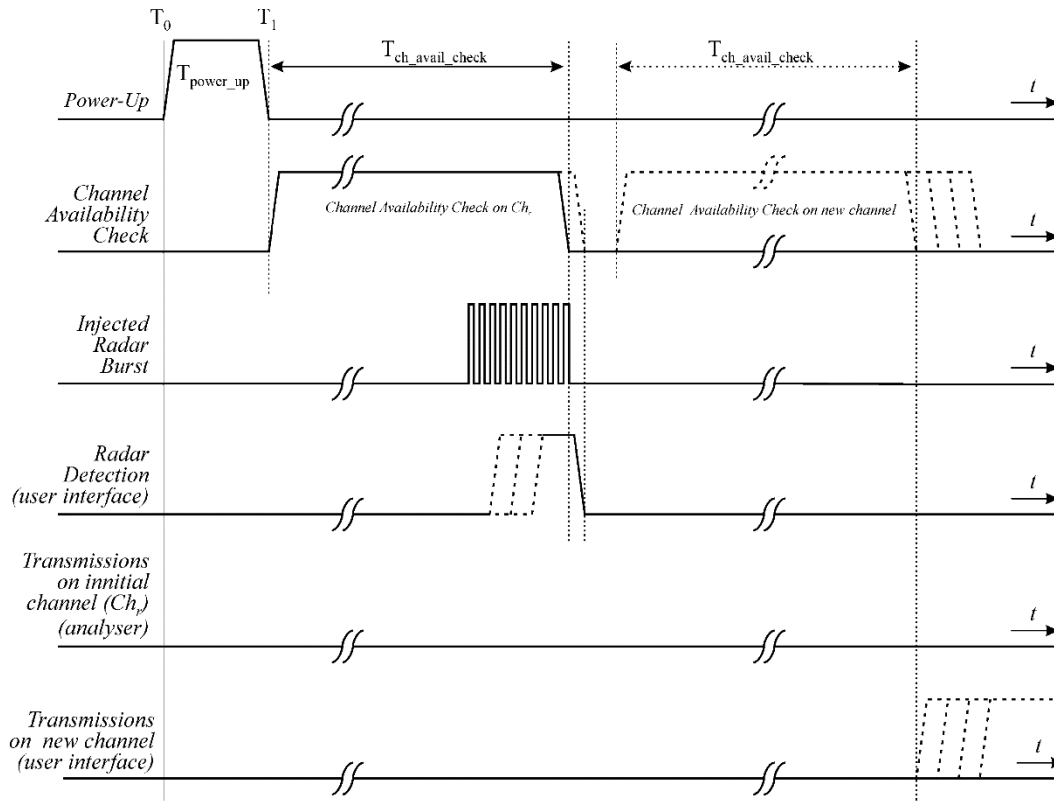

Figure 16: Example of timing for radar testing towards the end of the Channel Availability Check Time



Unless otherwise agreed in writing, this document is issued by the Company subject to its General Conditions of Service printed overleaf, available on request or accessible at <http://www.sgs.com/en/Terms-and-Conditions.aspx> and, for electronic format documents, subject to Terms and Conditions for Electronic Documents at <http://www.sgs.com/en/Terms-and-Conditions/Terms-e-Documents.aspx>. Attention is drawn to the limitation of liability, indemnification and jurisdiction issues defined therein. Any holder of this document is advised that information contained hereon reflects the Company's findings at the time of its intervention only and within the limits of Client's instructions, if any. The Company's sole responsibility is to its Client and this document does not exonerate parties to a transaction from exercising all their rights and obligations under the transaction documents. This document cannot be reproduced except in full, without prior written approval of the Company. Any unauthorized alteration, forgery or falsification of the content or appearance of this document is unlawful and offenders may be prosecuted to the fullest extent of the law. Unless otherwise stated the results shown in this test report refer only to the sample(s) tested and such sample(s) are retained for 30 days only.  
**Attention: To check the authenticity of testing /inspection report & certificate, please contact us at telephone: (86-755) 8307 1443, or email: CN.Doccheck@sgs.com**

Fuyong Lab, Xinlong TechnoPark, Fengtang Road, Fuyong Subdistrict, Bao'an, Shenzhen, China 518103 t (86-755) 88663988 f (86-755) 26710594 www.sgs.com.cn  
 中国·深圳·宝安区福永街道凤塘大道鑫科技园福永实验室 邮编: 518103 t (86-755) 88663988 f (86-755) 26710594 sgs.china@sgs.com

### 8.3.3 Measurement Data

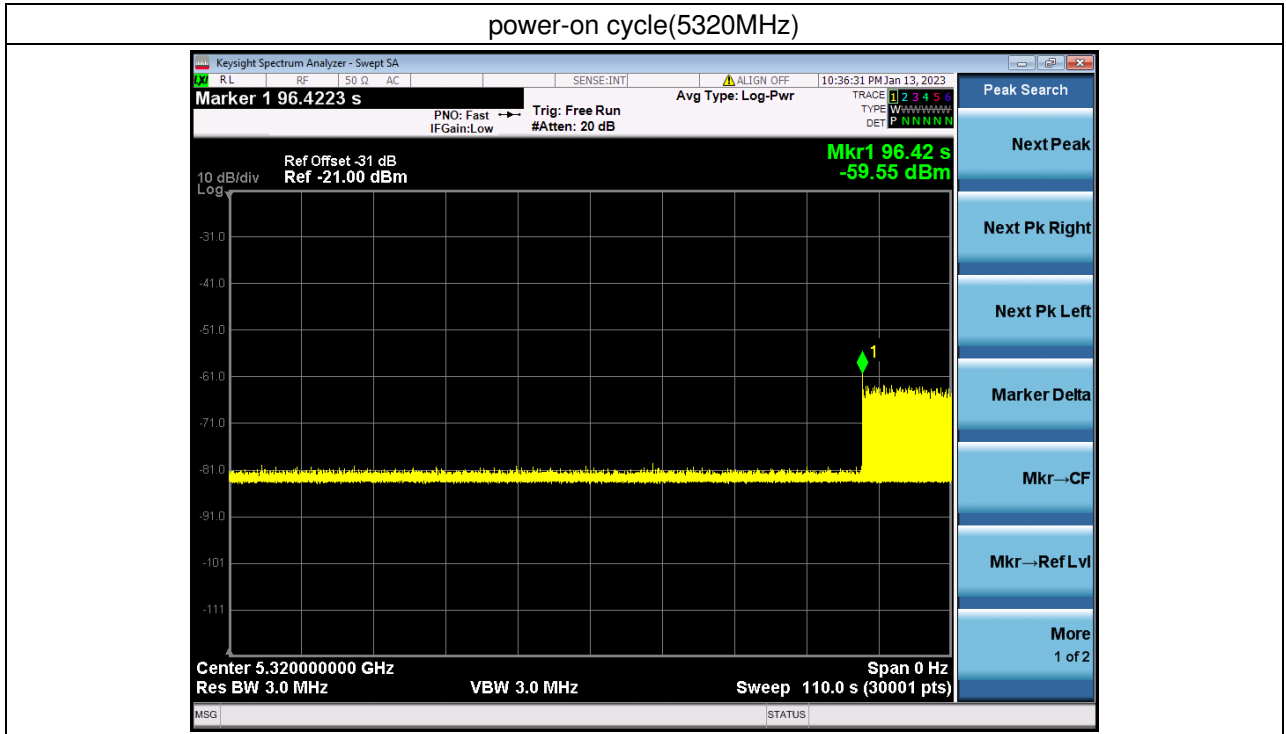

Unless otherwise agreed in writing, this document is issued by the Company subject to its General Conditions of Service printed overleaf, available on request or accessible at <http://www.sgs.com/en/Terms-and-Conditions.aspx> and, for electronic format documents, subject to Terms and Conditions for Electronic Documents at <http://www.sgs.com/en/Terms-and-Conditions/Terms-e-Document.aspx>. Attention is drawn to the limitation of liability, indemnification and jurisdiction issues defined therein. Any holder of this document is advised that information contained hereon reflects the Company's findings at the time of its intervention only and within the limits of Client's instructions, if any. The Company's sole responsibility is to its Client and this document does not exonerate parties to a transaction from exercising all their rights and obligations under the transaction documents. This document cannot be reproduced except in full, without prior written approval of the Company. Any unauthorized alteration, forgery or falsification of the content or appearance of this document is unlawful and offenders may be prosecuted to the fullest extent of the law. Unless otherwise stated the results shown in this test report refer only to the sample(s) tested and such sample(s) are retained for 30 days only.  
**Attention: To check the authenticity of testing /inspection report & certificate, please contact us at telephone: (86-755) 8307 1443, or email: CN.Doccheck@sgs.com**

## Compliance Certification Services (Kunshan) Inc. Shenzhen Branch

SZCCS-TRF-01 Rev. A/0 Aug01,2022

Report No.: FYCR221200049005

Page: 35 of 115

Beginning of the CAC(5320MHz)

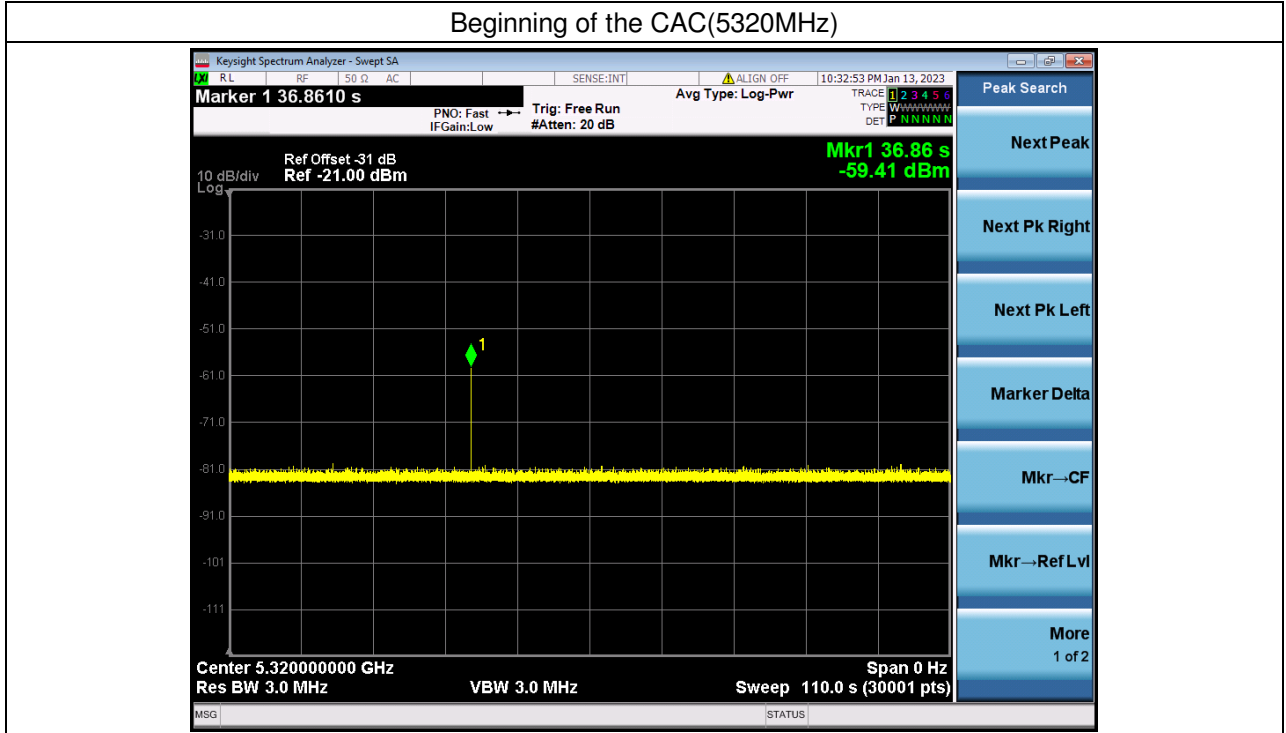

Unless otherwise agreed in writing, this document is issued by the Company subject to its General Conditions of Service printed overleaf, available on request or accessible at <http://www.sgs.com/en/Terms-and-Conditions.aspx> and, for electronic format documents, subject to Terms and Conditions for Electronic Documents at <http://www.sgs.com/en/Terms-and-Conditions/Terms-e-Documents.aspx>. Attention is drawn to the limitation of liability, indemnification and jurisdiction issues defined therein. Any holder of this document is advised that information contained hereon reflects the Company's findings at the time of its intervention only and within the limits of Client's instructions, if any. The Company's sole responsibility is to its Client and this document does not exonerate parties to a transaction from exercising all their rights and obligations under the transaction documents. This document cannot be reproduced except in full, without prior written approval of the Company. Any unauthorized alteration, forgery or falsification of the content or appearance of this document is unlawful and offenders may be prosecuted to the fullest extent of the law. Unless otherwise stated the results shown in this test report refer only to the sample(s) tested and such sample(s) are retained for 30 days only. Attention: To check the authenticity of testing /inspection report & certificate, please contact us at telephone: (86-755) 8307 1443, or email: CN.Doccheck@sgs.com

Fuyong lab, Xinlong TechnoPark, Fengtang Road, Fuyong Subdistrict, Bao'an, Shenzhen, China 518103 t (86-755) 88663988 f (86-755) 26710594 www.sgs.com.cn  
 中国·深圳·宝安区福永街道凤塘大道鑫龙科技园福永实验室 邮编: 518103 t (86-755) 88663988 f (86-755) 26710594 sgs.china@sgs.com

End of the CAC(5320MHz)

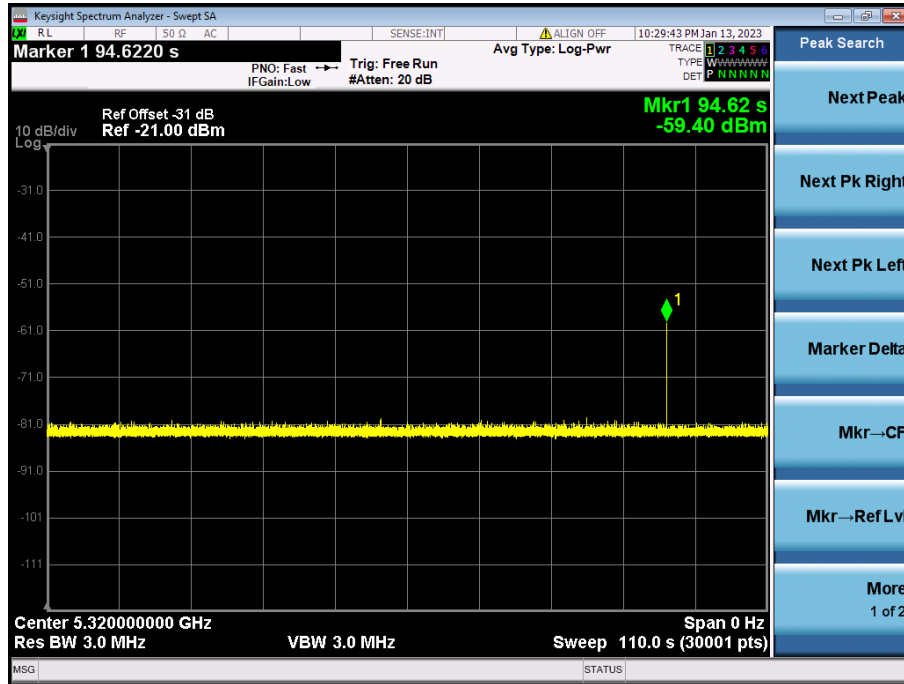

power-on cycle(5570MHz)

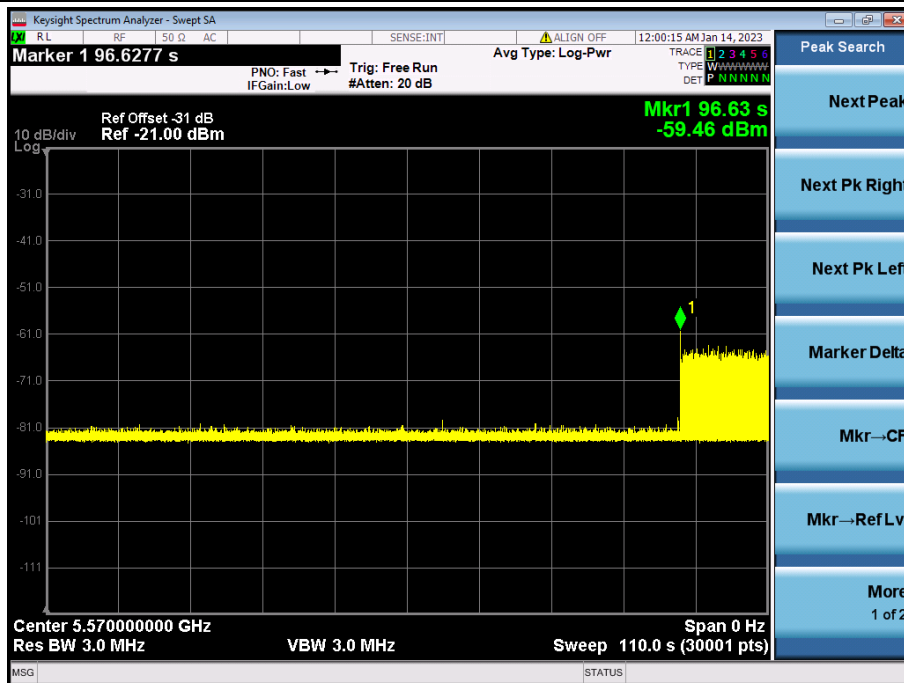

Unless otherwise agreed in writing, this document is issued by the Company subject to its General Conditions of Service printed overleaf, available on request or accessible at <http://www.sgs.com/en/Terms-and-Conditions.aspx> and, for electronic format documents, subject to Terms and Conditions for Electronic Documents at <http://www.sgs.com/en/Terms-and-Conditions/Terms-e-Documents.aspx>. Attention is drawn to the limitation of liability, indemnification and jurisdiction issues defined therein. Any holder of this document is advised that information contained hereon reflects the Company's findings at the time of its intervention only and within the limits of Client's instructions, if any. The Company's sole responsibility is to its Client and this document does not exonerate parties to a transaction from exercising all their rights and obligations under the transaction documents. This document cannot be reproduced except in full, without prior written approval of the Company. Any unauthorized alteration, forgery or falsification of the content or appearance of this document is unlawful and offenders may be prosecuted to the fullest extent of the law. Unless otherwise stated the results shown in this test report refer only to the sample(s) tested and such sample(s) are retained for 30 days only.  
**Attention: To check the authenticity of testing/inspection report & certificate, please contact us at telephone: (86-755) 8307 1443, or email: CN.Doccheck@sgs.com**

Fuyong Lab, Xinlong TechnoPark, Fengtang Road, Fuyong Subdistrict, Bao'an, Shenzhen, China 518103 t (86-755) 88663988 f (86-755) 26710594 www.sgs.com.cn  
 中国·深圳·宝安区福永街道凤塘大道鑫龙科技园福永实验室 邮编: 518103 t (86-755) 88663988 f (86-755) 26710594 sgs.china@sgs.com

### Beginning of the CAC(5570MHz)

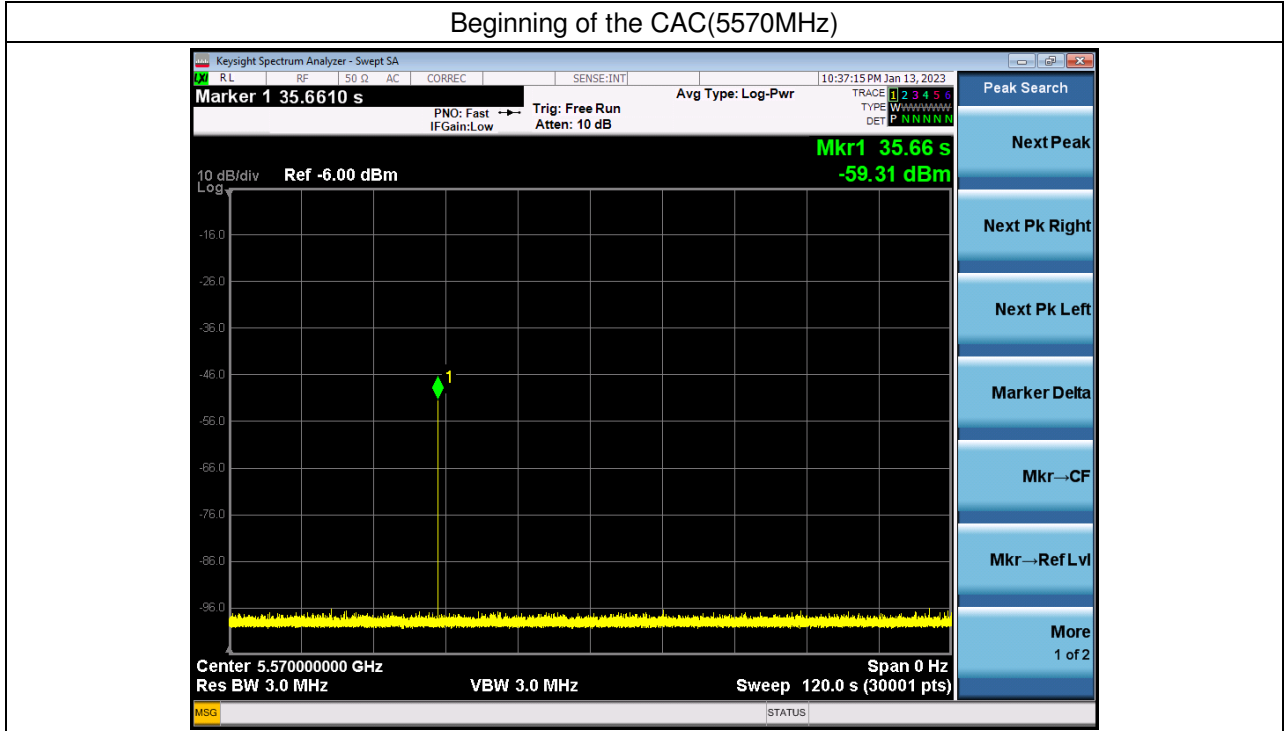

### End of the CAC(5570MHz)

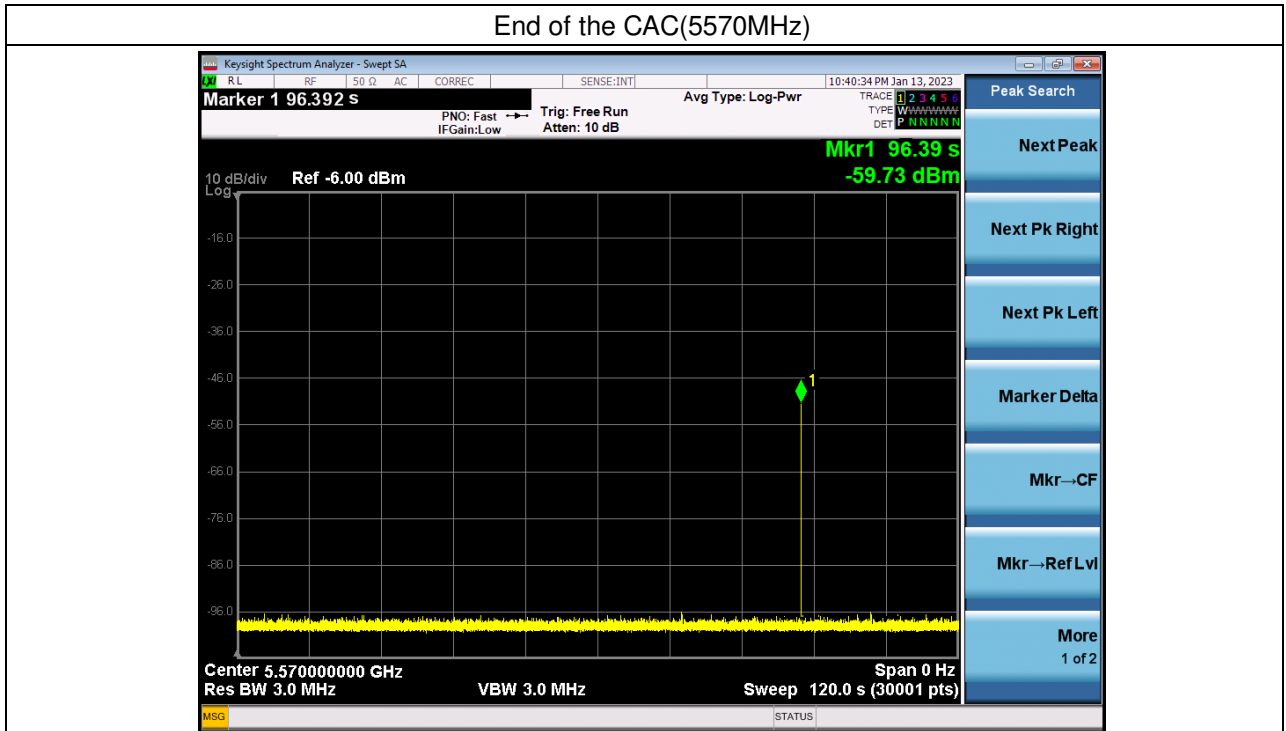

Unless otherwise agreed in writing, this document is issued by the Company subject to its General Conditions of Service printed overleaf, available on request or accessible at <http://www.sgs.com/en/Terms-and-Conditions.aspx> and, for electronic format documents, subject to Terms and Conditions for Electronic Documents at <http://www.sgs.com/en/Terms-and-Conditions/Terms-e-Documents.aspx>. Attention is drawn to the limitation of liability, indemnification and jurisdiction issues defined therein. Any holder of this document is advised that information contained hereon reflects the Company's findings at the time of its intervention only and within the limits of Client's instructions, if any. The Company's sole responsibility is to its Client and this document does not exonerate parties to a transaction from exercising all their rights and obligations under the transaction documents. This document cannot be reproduced except in full, without prior written approval of the Company. Any unauthorized alteration, forgery or falsification of the content or appearance of this document is unlawful and offenders may be prosecuted to the fullest extent of the law. Unless otherwise stated the results shown in this test report refer only to the sample(s) tested and such sample(s) are retained for 30 days only.  
**Attention: To check the authenticity of testing /inspection report & certificate, please contact us at telephone: (86-755) 8307 1443, or email: CN.Doccheck@sgs.com**

Fuyong lab, Xinlong TechnoPark, Fengtang Road, Fuyong Subdistrict, Bao'an, Shenzhen, China 518103 t (86-755) 88663988 f (86-755) 26710594 www.sgsgroup.com.cn  
 中国·深圳·宝安区福永街道凤塘大道鑫龙科技园福永实验室 邮编: 518103 t (86-755) 88663988 f (86-755) 26710594 sgs.china@sgs.com

### 8.4 In-Service Monitoring for Channel Move Time, Channel Closing Transmission Time and Non-Occupancy Period (7.8.3)

#### 8.4.1 Limit of In-Service Monitoring

The EUT has In-Service Monitoring function to continuously monitor the radar signals. If radar is detected, it must leave the channel (Shutdown). The Channel Move Time to cease all transmissions on the current Channel upon detection of a Radar Waveform above the DFS Detection Threshold within 10 sec.

The total duration of Channel Closing Transmission Time is comprised of 200 milliseconds starting at the beginning of the Channel Move Time plus any additional intermittent control signals required facilitating Channel changes (an aggregate of 60 milliseconds) during the remainder of the 10 second period. The aggregate duration of control signals will not count quiet periods in between transmissions.

Non-Occupancy Period time is 30 minutes during which a Channel will not be utilized after a Radar Waveform is detected on that Channel.



Unless otherwise agreed in writing, this document is issued by the Company subject to its General Conditions of Service printed overleaf, available on request or accessible at <http://www.sgs.com/en/Terms-and-Conditions.aspx> and, for electronic format documents, subject to Terms and Conditions for Electronic Documents at <http://www.sgs.com/en/Terms-and-Conditions/Terms-e-Documents.aspx>. Attention is drawn to the limitation of liability, indemnification and jurisdiction issues defined therein. Any holder of this document is advised that information contained hereon reflects the Company's findings at the time of its intervention only and within the limits of Client's instructions, if any. The Company's sole responsibility is to its Client and this document does not exonerate parties to a transaction from exercising all their rights and obligations under the transaction documents. This document cannot be reproduced except in full, without prior written approval of the Company. Any unauthorized alteration, forgery or falsification of the content or appearance of this document is unlawful and offenders may be prosecuted to the fullest extent of the law. Unless otherwise stated the results shown in this test report refer only to the sample(s) tested and such sample(s) are retained for 30 days only. Attention: To check the authenticity of testing /inspection report & certificate, please contact us at telephone: (86-755) 8307 1443, or email: [CN.Doccheck@sgs.com](mailto:CN.Doccheck@sgs.com)

**8.4.2 Test Procedure**

The steps below define the procedure to determine the above-mentioned parameters when a radar *Burst* with a level equal to the *DFS Detection Threshold* + 1dB is generated on the *Operating Channel* of the U-NII device (*In-Service Monitoring*).

1. One frequency will be chosen from the *Operating Channels* of the UUT within the 5250-5350 MHz or 5470-5725 MHz bands. For 802.11 devices, the test frequency must contain control signals. This can be verified by disabling channel loading and monitoring the spectrum analyzer. If no control signals are detected, another frequency must be selected within the emission bandwidth where control signals are detected.
2. In case the UUT is a U-NII device operating as a *Client Device* (with or without DFS), a U-NII device operating as a *Master Device* will be used to allow the UUT (Client device) to *Associate* with the *Master Device*. In case the UUT is a *Master Device*, a U-NII device operating as a *Client Device* will be used and it is assumed that the Client will *Associate* with the UUT (Master). In both cases for conducted tests, the *Radar Waveform* generator will be connected to the *Master Device*. For radiated tests, the emissions of the *Radar Waveform* generator will be directed towards the *Master Device*. If the *Master Device* has antenna gain, the main beam of the antenna will be directed toward the radar emitter. Vertical polarization is used for testing.
3. Stream the channel loading test file from the *Master Device* to the *Client Device* on the test *Channel* for the entire period of the test.
4. At time  $T_0$  the *Radar Waveform* generator sends a *Burst* of pulses for one of the Radar Type 0 in **Table 5** at levels defined in **Table 3**, on the *Operating Channel*. An additional 1 dB is added to the radar test signal to ensure it is at or above the *DFS Detection Threshold*, accounting for equipment variations/errors.
5. Observe the transmissions of the UUT at the end of the radar *Burst* on the *Operating Channel* for duration greater than 10 seconds. Measure and record the transmissions from the UUT during the observation time (*Channel Move Time*). Measure and record the *Channel Closing Transmission Time* if radar detection occurs. **Figure 17** illustrates *Channel Closing Transmission Time*.
6. When operating as a *Master Device*, monitor the UUT for more than 30 minutes following instant  $T_2$  to verify that the UUT does not resume any transmissions on this *Channel*. Perform this test once and record the measurement result.
7. In case the UUT is a U-NII device operating as a *Client Device* with *In-Service Monitoring*, perform steps 1 to 6.

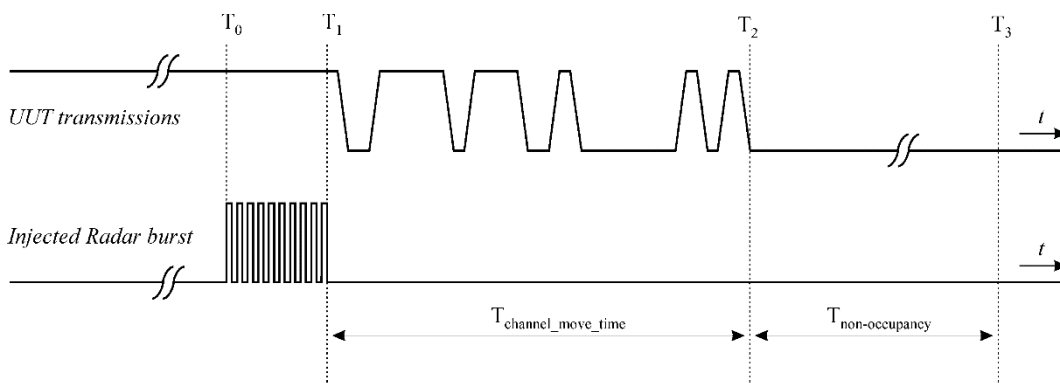

Figure 17: Example of Channel Closing Transmission Time & Channel Closing Time



Unless otherwise agreed in writing, this document is issued by the Company subject to its General Conditions of Service printed overleaf, available on request or accessible at <http://www.sgs.com/en/Terms-and-Conditions.aspx> and, for electronic format documents, subject to Terms and Conditions for Electronic Documents at <http://www.sgs.com/en/Terms-and-Conditions/Terms-e-Document.aspx>. Attention is drawn to the limitation of liability, indemnification and jurisdiction issues defined therein. Any holder of this document is advised that information contained herein reflects the Company's findings at the time of its intervention only and within the limits of Client's instructions, if any. The Company's sole responsibility is to its Client and this document does not exonerate parties to a transaction from exercising all their rights and obligations under the transaction documents. This document cannot be reproduced except in full, without prior written approval of the Company. Any unauthorized alteration, forgery or falsification of the content or appearance of this document is unlawful and offenders may be prosecuted to the fullest extent of the law. Unless otherwise stated the results shown in this test report refer only to the sample(s) tested and such sample(s) are retained for 30 days only. Attention: To check the authenticity of testing/inspection report & certificate, please contact us at telephone: (86-755) 8307 1443, or email: CN.Doccheck@sgs.com

Fuyong lab, Xinlong TechnoPark, Fengtang Road, Fuyong Subdistrict, Bao'an, Shenzhen, China 518103 t (86-755) 88663988 f (86-755) 26710594 www.sgs.com.cn  
 中国·深圳·宝安区福永街道凤塘大道鑫龙科技园福永实验室 邮编: 518103 t (86-755) 88663988 f (86-755) 26710594 sgs.china@sgs.com

### 8.4.3 Measurement Data

#### Channel Move Time, Channel Closing Transmission Time 5290MHz:

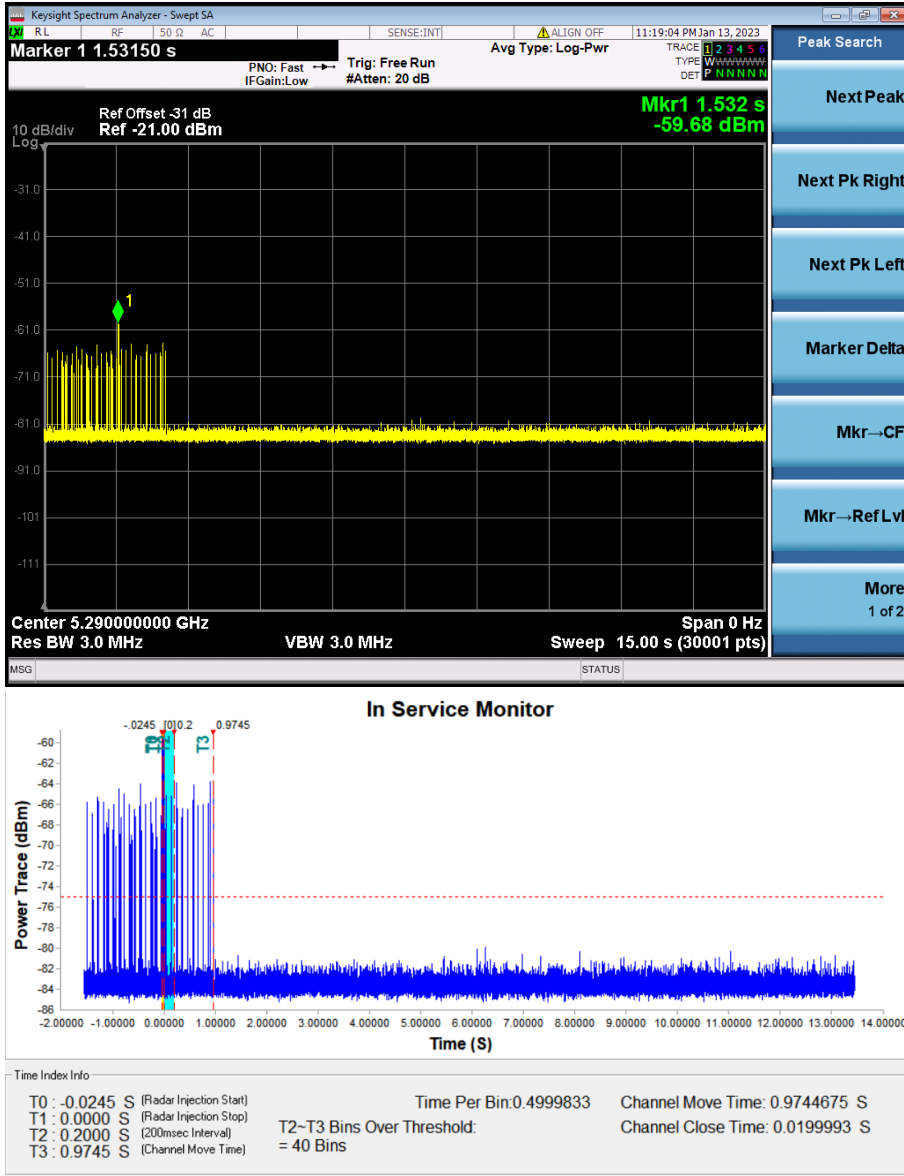

Unless otherwise agreed in writing, this document is issued by the Company subject to its General Conditions of Service printed overleaf, available on request or accessible at <http://www.sgs.com/en/Terms-and-Conditions.aspx> and, for electronic format documents, subject to Terms and Conditions for Electronic Documents at <http://www.sgs.com/en/Terms-and-Conditions/Terms-e-Documents.aspx>. Attention is drawn to the limitation of liability, indemnification and jurisdiction issues defined therein. Any holder of this document is advised that information contained hereon reflects the Company's findings at the time of its intervention only and within the limits of Client's instructions, if any. The Company's sole responsibility is to its Client and this document does not exonerate parties to a transaction from exercising all their rights and obligations under the transaction documents. This document cannot be reproduced except in full, without prior written approval of the Company. Any unauthorized alteration, forgery or falsification of the content or appearance of this document is unlawful and offenders may be prosecuted to the fullest extent of the law. Unless otherwise stated the results shown in this test report refer only to the sample(s) tested and such sample(s) are retained for 30 days only.  
**Attention: To check the authenticity of testing /inspection report & certificate, please contact us at telephone: (86-755) 8307 1443, or email: CN.Doccheck@sgs.com**

Fuyong Lab, Xinlong TechnoPark, Fengtang Road, Fuyong Subdistrict, Bao'an, Shenzhen, China 518103 t (86-755) 88663988 f (86-755) 26710594 www.sgs.com.cn  
 中国·深圳·宝安区福永街道凤塘大道鑫龙科技园福永实验室 邮编: 518103 t (86-755) 88663988 f (86-755) 26710594 sgs.china@sgs.com



**5570MHz:**

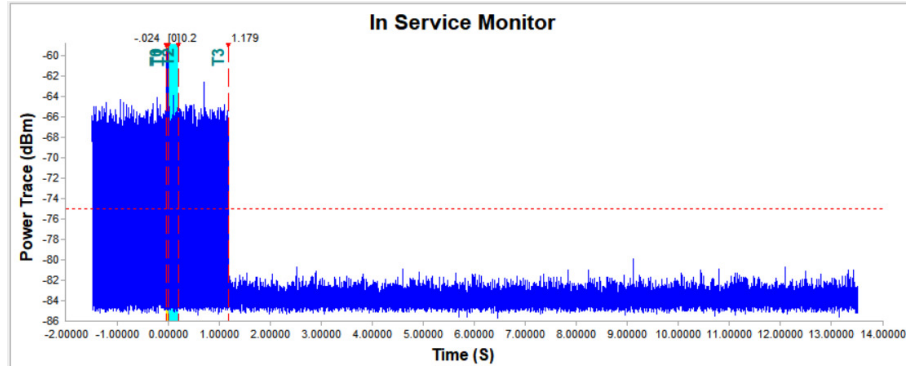
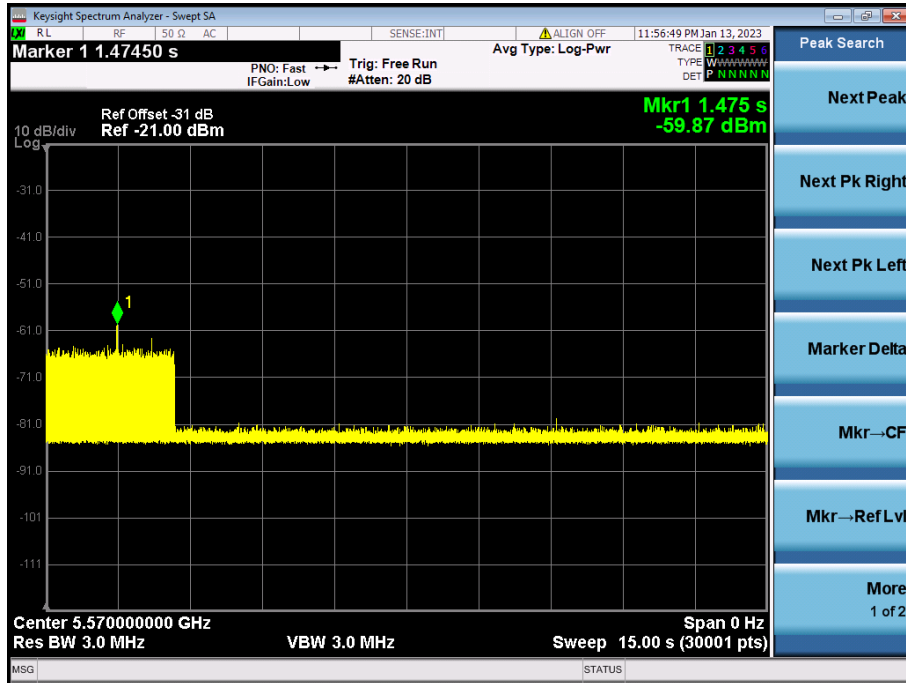

Time Index Info		Time Per Bin: 0.4999833	Channel Move Time: 1.1789607 S
T0 : -0.0240 S	(Radar Injection Start)	T2-T3 Bins Over Threshold: = 563 Bins	Channel Close Time: 0.2814906 S
T1 : 0.0000 S	(Radar Injection Stop)		
T2 : 0.2000 S	(200msec Interval)		
T3 : 1.1790 S	(Channel Move Time)		



Unless otherwise agreed in writing, this document is issued by the Company subject to its General Conditions of Service printed overleaf, available on request or accessible at <http://www.sgs.com/en/Terms-and-Conditions.aspx> and, for electronic format documents, subject to Terms and Conditions for Electronic Documents at <http://www.sgs.com/en/Terms-and-Conditions/Terms-e-Documents.aspx>. Attention is drawn to the limitation of liability, indemnification and jurisdiction issues defined therein. Any holder of this document is advised that information contained hereon reflects the Company's findings at the time of its intervention only and within the limits of Client's instructions, if any. The Company's sole responsibility is to its Client and this document does not exonerate parties to a transaction from exercising all their rights and obligations under the transaction documents. This document cannot be reproduced except in full, without prior written approval of the Company. Any unauthorized alteration, forgery or falsification of the content or appearance of this document is unlawful and offenders may be prosecuted to the fullest extent of the law. Unless otherwise stated the results shown in this test report refer only to the sample(s) tested and such sample(s) are retained for 30 days only.  
**Attention: To check the authenticity of testing /inspection report & certificate, please contact us at telephone: (86-755) 8307 1443, or email: CN.Doccheck@sgs.com**

Fuyong lab, Xinlong TechnoPark, Fengtang Road, Fuyong Subdistrict, Bao'an, Shenzhen, China 518103 t (86-755) 88663988 f (86-755) 26710594 www.sgs.com.cn  
 中国·深圳·宝安区福永街道凤塘大道鑫龙科技园福永实验室 邮编: 518103 t (86-755) 88663988 f (86-755) 26710594 sgs.china@sgs.com

## Compliance Certification Services (Kunshan) Inc. Shenzhen Branch

SZCCS-TRF-01 Rev. A/0 Aug01,2022

Report No.: FYCR221200049005

Page: 42 of 115

### Non occupation period

#### 5290MHz:

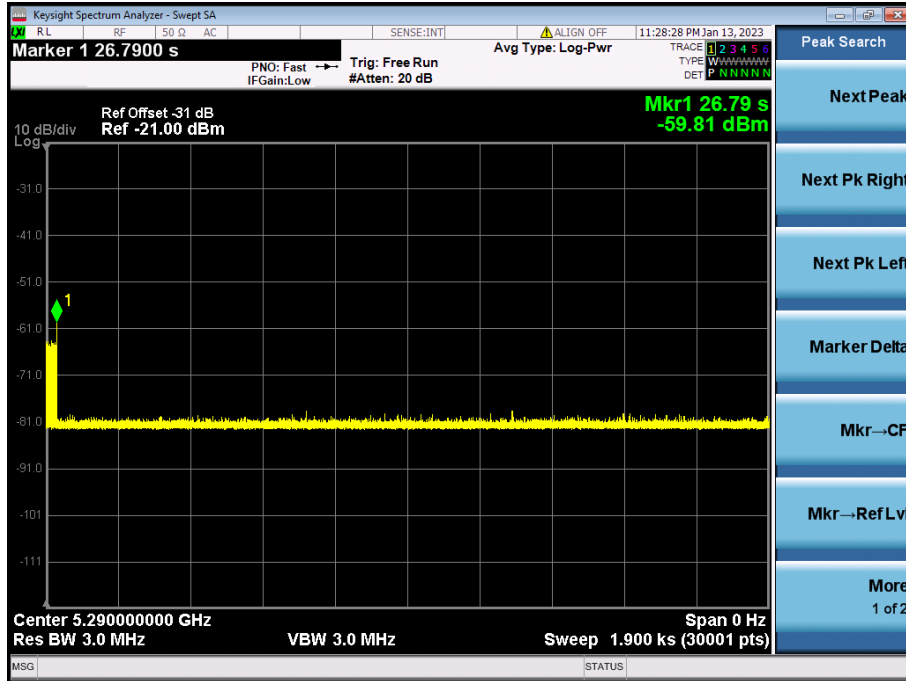

#### 5570MHz:

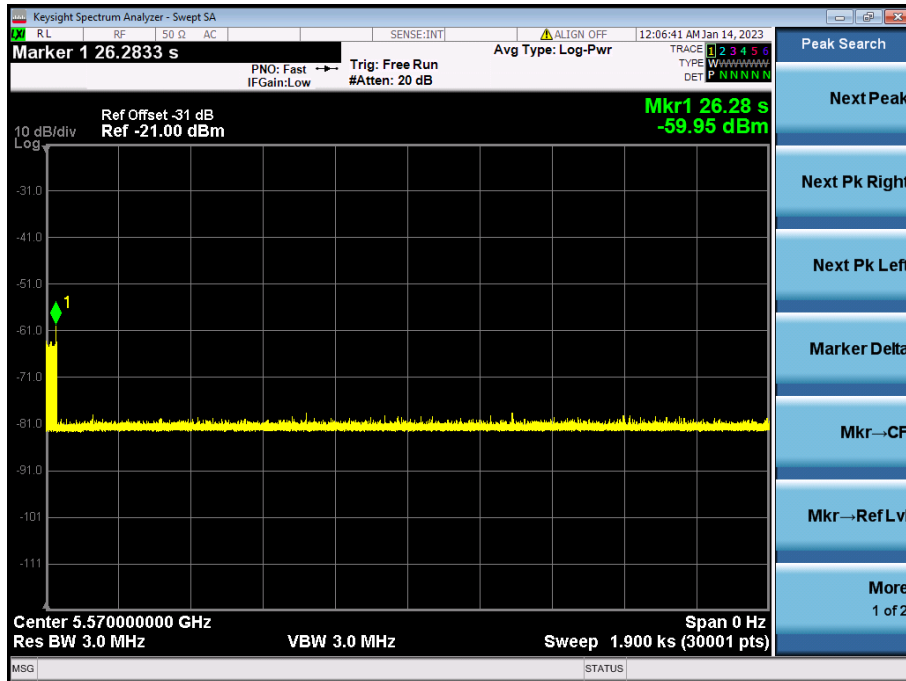

Unless otherwise agreed in writing, this document is issued by the Company subject to its General Conditions of Service printed overleaf, available on request or accessible at <http://www.sgs.com/en/Terms-and-Conditions.aspx> and, for electronic format documents, subject to Terms and Conditions for Electronic Documents at <http://www.sgs.com/en/Terms-and-Conditions/Terms-e-Document.aspx>. Attention is drawn to the limitation of liability, indemnification and jurisdiction issues defined therein. Any holder of this document is advised that information contained hereon reflects the Company's findings at the time of its intervention only and within the limits of Client's instructions, if any. The Company's sole responsibility is to its Client and this document does not exonerate parties to a transaction from exercising all their rights and obligations under the transaction documents. This document cannot be reproduced except in full, without prior written approval of the Company. Any unauthorized alteration, forgery or falsification of the content or appearance of this document is unlawful and offenders may be prosecuted to the fullest extent of the law. Unless otherwise stated the results shown in this test report refer only to the sample(s) tested and such sample(s) are retained for 30 days only.  
**Attention: To check the authenticity of testing /inspection report & certificate, please contact us at telephone: (86-755) 8307 1443, or email: CN.Doccheck@sgs.com**

Compliance Certification Services (Kunshan) Inc.  
 Shenzhen Branch

Fuyong lab, Xinlong TechnoPark, Fengtang Road, Fuyong Subdistrict, Bao'an, Shenzhen, China 518103 t (86-755) 88663988 f (86-755) 26710594 www.sgs.com.cn  
 中国·深圳·宝安区福永街道凤塘大道鑫龙科技园福永实验室 邮编: 518103 t (86-755) 88663988 f (86-755) 26710594 sgs.china@sgs.com

### Throughput:

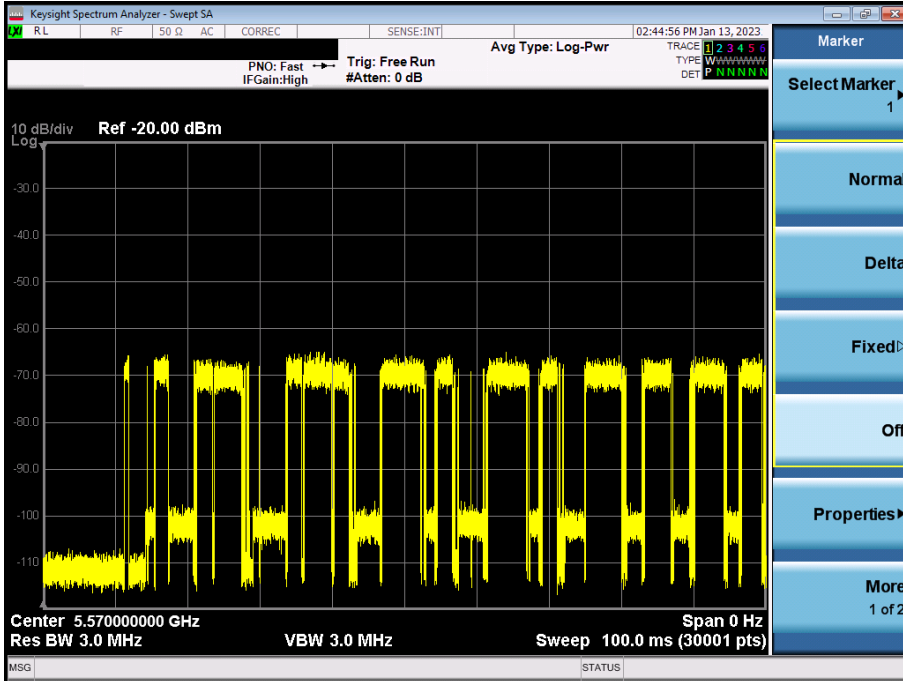

Duty cycle:49.9%



Unless otherwise agreed in writing, this document is issued by the Company subject to its General Conditions of Service printed overleaf, available on request or accessible at <http://www.sgs.com/en/Terms-and-Conditions.aspx> and, for electronic format documents, subject to Terms and Conditions for Electronic Documents at <http://www.sgs.com/en/Terms-and-Conditions/Terms-e-Documents.aspx>. Attention is drawn to the limitation of liability, indemnification and jurisdiction issues defined therein. Any holder of this document is advised that information contained hereon reflects the Company's findings at the time of its intervention only and within the limits of Client's instructions, if any. The Company's sole responsibility is to its Client and this document does not exonerate parties to a transaction from exercising all their rights and obligations under the transaction documents. This document cannot be reproduced except in full, without prior written approval of the Company. Any unauthorized alteration, forgery or falsification of the content or appearance of this document is unlawful and offenders may be prosecuted to the fullest extent of the law. Unless otherwise stated the results shown in this test report refer only to the sample(s) tested and such sample(s) are retained for 30 days only. **Attention: To check the authenticity of testing /inspection report & certificate, please contact us at telephone: (86-755) 8307 1443, or email: CN.Doccheck@sgs.com**

Fuyong lab, Xinlong TechnoPark, Fengtang Road, Fuyong Subdistrict, Bao'an, Shenzhen, China 518103 t (86-755) 88663988 f (86-755) 26710594 www.sgs.com.cn  
 中国·深圳·宝安区福永街道凤塘大道鑫龙科技园福永实验室 邮编: 518103 t (86-755) 88663988 f (86-755) 26710594 sgs.china@sgs.com

**8.5 Statistical Performance Check (7.8.4)**

**8.5.1 Limit of Statistical Performance Check**

Refer to Table 5, 5a, 6, 7

**8.5.2 Test Procedure**

The steps below define the procedure to determine the minimum percentage of successful detection requirements found in **Tables 5-7** when a radar burst with a level equal to the *DFS Detection Threshold + 1dB* is generated on the *Operating Channel* of the U-NII device (*In-Service Monitoring*).

1. One frequency will be chosen from the *Operating Channels* of the UUT within the 5250-5350 MHz or 5470-5725 MHz bands.
2. In case the UUT is a U-NII device operating as a *Client Device* (with or without Radar Detection), a U-NII device operating as a *Master Device* will be used to allow the UUT (Client device) to *Associate* with the *Master Device*. In case the UUT is a *Master Device*, a U-NII device operating as a *Client Device* will be used and it is assumed that the Client will *Associate* with the UUT (Master). In both cases for conducted tests, the *Radar Waveform* generator will be connected to the *Master Device*. For radiated tests, the emissions of the *Radar Waveform* generator will be directed towards the *Master Device*. If the *Master Device* has antenna gain, the main beam of the antenna will be directed toward the radar emitter. Vertical polarization is used for testing.
3. Stream the channel loading test file from the *Master Device* to the Client Device on the test *Channel* for the entire period of the test.
4. At time  $T_0$  the *Radar Waveform* generator sends the individual waveform for each of the Radar Types 1- 6 in **Tables 5-7**, at levels defined in **Table 3**, on the *Operating Channel*. An additional 1 dB is added to the radar test signal to ensure it is at or above the *DFS Detection Threshold*, accounting for equipment variations/errors.
5. Observe the transmissions of the UUT at the end of the Burst on the *Operating Channel* for duration greater than 10 seconds for Radar Type 0 to ensure detection occurs.
6. Observe the transmissions of the UUT at the end of the Burst on the *Operating Channel* for duration greater than 22 seconds for Long Pulse Radar Type 5 to ensure detection occurs.
7. In case the UUT is a U-NII device operating as a *Client Device* with *In-Service Monitoring*, perform steps 1 to 6.

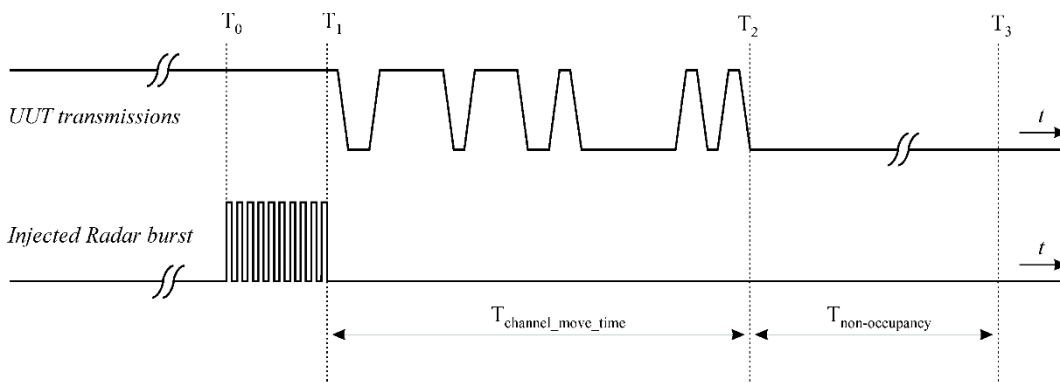

Figure 17: Example of Channel Closing Transmission Time & Channel Closing Time



Unless otherwise agreed in writing, this document is issued by the Company subject to its General Conditions of Service printed overleaf, available on request or accessible at <http://www.sgs.com/en/Terms-and-Conditions.aspx> and, for electronic format documents, subject to Terms and Conditions for Electronic Documents at <http://www.sgs.com/en/Terms-and-Conditions/Terms-e-Document.aspx>. Attention is drawn to the limitation of liability, indemnification and jurisdiction issues defined therein. Any holder of this document is advised that information contained hereon reflects the Company's findings at the time of its intervention only and within the limits of Client's instructions, if any. The Company's sole responsibility is to its Client and this document does not exonerate parties to a transaction from exercising all their rights and obligations under the transaction documents. This document cannot be reproduced except in full, without prior written approval of the Company. Any unauthorized alteration, forgery or falsification of the content or appearance of this document is unlawful and offenders may be prosecuted to the fullest extent of the law. Unless otherwise stated the results shown in this test report refer only to the sample(s) tested and such sample(s) are retained for 30 days only.  
**Attention: To check the authenticity of testing /inspection report & certificate, please contact us at telephone: (86-755) 8307 1443, or email: CN.Doccheck@sgs.com**

Fuyong Lab, Xinlong TechnoPark, Fengtang Road, Fuyong Subdistrict, Bao'an, Shenzhen, China 518103 t (86-755) 88663988 f (86-755) 26710594 www.sgs.com.cn  
 中国·深圳·宝安区福永街道凤塘大道鑫龙科技园福永实验室 邮编: 518103 t (86-755) 88663988 f (86-755) 26710594 sgs.china@sgs.com

# Compliance Certification Services (Kunshan) Inc. Shenzhen Branch

SZCCS-TRF-01 Rev. A/0 Aug01,2022

Report No.: FYCR221200049005

Page: 45 of 115

## 8.5.3 Measurement Data

### Statistical Performance Check: 20MHz

Trial No.	Radar Signal Type					
	1	2	3	4	5	6
0	Y	Y	Y	Y	Y	Y
1	Y	Y	Y	Y	Y	Y
2	Y	Y	Y	Y	Y	Y
3	Y	Y	Y	Y	Y	Y
4	Y	Y	Y	Y	Y	Y
5	Y	Y	Y	Y	Y	Y
6	Y	Y	Y	Y	Y	Y
7	Y	Y	Y	Y	Y	Y
8	Y	Y	Y	Y	Y	Y
9	Y	Y	Y	Y	Y	Y
10	Y	Y	Y	Y	Y	Y
11	Y	Y	Y	Y	Y	Y
12	Y	Y	Y	Y	Y	Y
13	Y	Y	Y	Y	Y	Y
14	Y	Y	Y	Y	Y	Y
15	Y	Y	Y	Y	Y	Y
16	Y	Y	Y	Y	Y	Y
17	Y	Y	Y	Y	Y	Y
18	Y	Y	Y	Y	Y	Y
19	Y	Y	Y	Y	Y	Y
20	Y	Y	Y	Y	Y	Y
21	Y	Y	Y	Y	Y	Y
22	Y	Y	Y	Y	Y	Y
23	Y	Y	Y	Y	Y	Y
24	Y	Y	Y	Y	Y	Y
25	Y	Y	Y	Y	Y	Y
26	Y	Y	Y	Y	Y	Y
27	Y	Y	Y	Y	Y	Y
28	Y	Y	Y	Y	Y	Y
29	Y	Y	Y	Y	Y	Y
Detection Probability (%)	100.00	100.00	100.00	100.00	100.00	100.00
Aggregate Detection Probability of Type 1 ~ Type 4 (%)	100.00					
Result	Pass	Pass	Pass	Pass	Pass	Pass



Unless otherwise agreed in writing, this document is issued by the Company subject to its General Conditions of Service printed overleaf, available on request or accessible at <http://www.sgs.com/en/Terms-and-Conditions.aspx> and, for electronic format documents, subject to Terms and Conditions for Electronic Documents at <http://www.sgs.com/en/Terms-and-Conditions/Terms-e-Documents.aspx>. Attention is drawn to the limitation of liability, indemnification and jurisdiction issues defined therein. Any holder of this document is advised that information contained hereon reflects the Company's findings at the time of its intervention only and within the limits of Client's instructions, if any. The Company's sole responsibility is to its Client and this document does not exonerate parties to a transaction from exercising all their rights and obligations under the transaction documents. This document cannot be reproduced except in full, without prior written approval of the Company. Any unauthorized alteration, forgery or falsification of the content or appearance of this document is unlawful and offenders may be prosecuted to the fullest extent of the law. Unless otherwise stated the results shown in this test report refer only to the sample(s) tested and such sample(s) are retained for 30 days only.  
**Attention: To check the authenticity of testing /inspection report & certificate, please contact us at telephone: (86-755) 8307 1443, or email: CN.Doccheck@sgs.com**

Compliance Certification Services (Kunshan) Inc. Shenzhen Branch

Fuyong lab, Xinlong TechnoPark, Fengtang Road, Fuyong Subdistrict, Bao'an, Shenzhen, China 518103 t (86-755) 88663988 f (86-755) 26710594 www.sgs.com.cn  
 中国·深圳·宝安区福永街道凤塘大道鑫龙科技园福永实验室 邮编: 518103 t (86-755) 88663988 f (86-755) 26710594 sgs.china@sgs.com

# Compliance Certification Services (Kunshan) Inc. Shenzhen Branch

SZCCS-TRF-01 Rev. A/0 Aug01,2022

Report No.: FYCR221200049005

Page: 46 of 115

## 40MHz

Trial No.	Radar Signal Type					
	1	2	3	4	5	6
0	Y	Y	Y	Y	Y	Y
1	Y	Y	Y	Y	Y	Y
2	Y	Y	Y	Y	Y	Y
3	Y	Y	Y	Y	Y	Y
4	Y	Y	Y	Y	Y	Y
5	Y	Y	Y	Y	Y	Y
6	Y	Y	Y	Y	Y	Y
7	Y	Y	Y	Y	Y	Y
8	Y	Y	Y	Y	Y	Y
9	Y	Y	Y	Y	Y	N
10	Y	Y	Y	Y	Y	Y
11	Y	Y	Y	Y	Y	Y
12	Y	Y	Y	Y	Y	Y
13	Y	Y	Y	Y	Y	Y
14	Y	Y	Y	Y	Y	Y
15	Y	Y	Y	Y	Y	Y
16	Y	Y	Y	Y	Y	Y
17	Y	Y	Y	Y	Y	Y
18	Y	Y	Y	Y	Y	Y
19	Y	Y	Y	Y	Y	Y
20	Y	Y	Y	Y	Y	Y
21	Y	Y	Y	Y	Y	Y
22	Y	Y	Y	Y	Y	Y
23	Y	Y	Y	Y	Y	Y
24	N	Y	Y	Y	Y	Y
25	Y	Y	Y	Y	Y	Y
26	Y	Y	Y	N	Y	Y
27	Y	Y	Y	Y	Y	Y
28	Y	Y	Y	Y	N	Y
29	Y	Y	Y	Y	Y	Y
Detection Probability (%)	96.67	100.00	100.00	96.67	96.67	96.67
Aggregate Detection Probability of Type 1 ~ Type 4 (%)	98.33					
Result	Pass	Pass	Pass	Pass	Pass	Pass



Unless otherwise agreed in writing, this document is issued by the Company subject to its General Conditions of Service printed overleaf, available on request or accessible at <http://www.sgs.com/en/Terms-and-Conditions.aspx> and, for electronic format documents, subject to Terms and Conditions for Electronic Documents at <http://www.sgs.com/en/Terms-and-Conditions/Terms-e-Document.aspx>. Attention is drawn to the limitation of liability, indemnification and jurisdiction issues defined therein. Any holder of this document is advised that information contained hereon reflects the Company's findings at the time of its intervention only and within the limits of Client's instructions, if any. The Company's sole responsibility is to its Client and this document does not exonerate parties to a transaction from exercising all their rights and obligations under the transaction documents. This document cannot be reproduced except in full, without prior written approval of the Company. Any unauthorized alteration, forgery or falsification of the content or appearance of this document is unlawful and offenders may be prosecuted to the fullest extent of the law. Unless otherwise stated the results shown in this test report refer only to the sample(s) tested and such sample(s) are retained for 30 days only.  
**Attention: To check the authenticity of testing /inspection report & certificate, please contact us at telephone: (86-755) 8307 1443, or email: CN.Doccheck@sgs.com**

Fuyong lab, Xinlong TechnoPark, Fengtang Road, Fuyong Subdistrict, Bao'an, Shenzhen, China 518103 t (86-755) 88663988 f (86-755) 26710594 www.sgs.com.cn  
 中国·深圳·宝安区福永街道凤塘大道鑫龙科技园福永实验室 邮编: 518103 t (86-755) 88663988 f (86-755) 26710594 sgs.china@sgs.com

# Compliance Certification Services (Kunshan) Inc. Shenzhen Branch

SZCCS-TRF-01 Rev. A/0 Aug01,2022

Report No.: FYCR221200049005

Page: 47 of 115

## 80MHz

Trial No.	Radar Signal Type					
	1	2	3	4	5	6
0	Y	Y	Y	Y	Y	Y
1	Y	Y	Y	Y	Y	Y
2	Y	Y	Y	Y	Y	Y
3	Y	Y	Y	Y	Y	Y
4	Y	Y	Y	Y	Y	Y
5	Y	Y	Y	Y	Y	Y
6	Y	Y	Y	Y	Y	Y
7	Y	Y	Y	Y	Y	Y
8	Y	Y	Y	Y	Y	Y
9	Y	Y	Y	Y	Y	Y
10	Y	Y	Y	Y	Y	Y
11	Y	Y	Y	Y	Y	Y
12	Y	Y	Y	Y	Y	Y
13	Y	Y	Y	Y	Y	Y
14	Y	Y	Y	Y	Y	Y
15	Y	Y	Y	Y	Y	Y
16	Y	Y	Y	Y	Y	Y
17	Y	Y	Y	Y	Y	Y
18	Y	Y	Y	Y	Y	Y
19	Y	Y	Y	Y	Y	Y
20	Y	Y	Y	Y	Y	Y
21	Y	Y	Y	Y	Y	Y
22	Y	Y	N	Y	Y	N
23	Y	Y	Y	Y	Y	Y
24	Y	Y	Y	Y	Y	Y
25	N	Y	Y	Y	Y	Y
26	Y	Y	Y	Y	Y	Y
27	Y	Y	Y	Y	Y	Y
28	Y	Y	Y	Y	Y	Y
29	Y	Y	Y	Y	Y	Y
Detection Probability (%)	96.67	100.00	96.67	100.00	100.00	96.67
Aggregate Detection Probability of Type 1 ~ Type 4 (%)	98.33					
Result	Pass	Pass	Pass	Pass	Pass	Pass



Unless otherwise agreed in writing, this document is issued by the Company subject to its General Conditions of Service printed overleaf, available on request or accessible at <http://www.sgs.com/en/Terms-and-Conditions.aspx> and, for electronic format documents, subject to Terms and Conditions for Electronic Documents at <http://www.sgs.com/en/Terms-and-Conditions/Terms-e-Documents.aspx>. Attention is drawn to the limitation of liability, indemnification and jurisdiction issues defined therein. Any holder of this document is advised that information contained hereon reflects the Company's findings at the time of its intervention only and within the limits of Client's instructions, if any. The Company's sole responsibility is to its Client and this document does not exonerate parties to a transaction from exercising all their rights and obligations under the transaction documents. This document cannot be reproduced except in full, without prior written approval of the Company. Any unauthorized alteration, forgery or falsification of the content or appearance of this document is unlawful and offenders may be prosecuted to the fullest extent of the law. Unless otherwise stated the results shown in this test report refer only to the sample(s) tested and such sample(s) are retained for 30 days only. Attention: To check the authenticity of testing /inspection report & certificate, please contact us at telephone: (86-755) 8307 1443, or email: CN.Doccheck@sgs.com

Fuyong lab, Xinlong TechnoPark, Fengtang Road, Fuyong Subdistrict, Bao'an, Shenzhen, China 518103 t (86-755) 88663988 f (86-755) 26710594 www.sgs.com.cn  
 中国·深圳·宝安区福永街道凤塘大道鑫龙科技园福永实验室 邮编: 518103 t (86-755) 88663988 f (86-755) 26710594 sgs.china@sgs.com

# Compliance Certification Services (Kunshan) Inc. Shenzhen Branch

SZCCS-TRF-01 Rev. A/0 Aug01,2022

Report No.: FYCR221200049005

Page: 48 of 115

## 160MHz

Trial No.	Radar Signal Type					
	1	2	3	4	5	6
0	Y	Y	Y	Y	Y	Y
1	Y	Y	Y	Y	Y	Y
2	Y	Y	Y	Y	Y	Y
3	Y	Y	Y	Y	Y	Y
4	Y	Y	Y	Y	Y	Y
5	Y	Y	Y	Y	Y	Y
6	Y	Y	Y	Y	Y	Y
7	Y	Y	Y	Y	Y	Y
8	Y	Y	Y	N	Y	Y
9	Y	Y	Y	Y	Y	Y
10	Y	Y	Y	Y	Y	Y
11	Y	Y	Y	Y	Y	Y
12	Y	Y	Y	Y	Y	Y
13	Y	Y	Y	Y	Y	Y
14	Y	Y	Y	Y	Y	Y
15	Y	Y	Y	Y	Y	Y
16	Y	Y	Y	Y	Y	Y
17	Y	Y	Y	Y	Y	Y
18	Y	Y	Y	Y	Y	Y
19	Y	Y	Y	Y	Y	Y
20	Y	Y	Y	Y	Y	Y
21	Y	Y	N	Y	Y	Y
22	Y	Y	Y	Y	Y	Y
23	Y	Y	Y	Y	Y	Y
24	Y	Y	Y	Y	N	Y
25	N	Y	Y	Y	Y	Y
26	Y	Y	Y	Y	Y	Y
27	Y	Y	Y	Y	Y	Y
28	Y	Y	Y	Y	Y	Y
29	Y	Y	Y	Y	Y	Y
Detection Probability (%)	96.67	100.00	96.67	96.67	96.67	100.00
Aggregate Detection Probability of Type 1 ~ Type 4 (%)	97.50					
Result	Pass	Pass	Pass	Pass	Pass	Pass



Unless otherwise agreed in writing, this document is issued by the Company subject to its General Conditions of Service printed overleaf, available on request or accessible at <http://www.sgs.com/en/Terms-and-Conditions.aspx> and, for electronic format documents, subject to Terms and Conditions for Electronic Documents at <http://www.sgs.com/en/Terms-and-Conditions/Terms-e-Document.aspx>. Attention is drawn to the limitation of liability, indemnification and jurisdiction issues defined therein. Any holder of this document is advised that information contained hereon reflects the Company's findings at the time of its intervention only and within the limits of Client's instructions, if any. The Company's sole responsibility is to its Client and this document does not exonerate parties to a transaction from exercising all their rights and obligations under the transaction documents. This document cannot be reproduced except in full, without prior written approval of the Company. Any unauthorized alteration, forgery or falsification of the content or appearance of this document is unlawful and offenders may be prosecuted to the fullest extent of the law. Unless otherwise stated the results shown in this test report refer only to the sample(s) tested and such sample(s) are retained for 30 days only. Attention: To check the authenticity of testing /inspection report & certificate, please contact us at telephone: (86-755) 8307 1443, or email: CN.Doccheck@sgs.com

Fuyong lab, Xinlong TechnoPark, Fengtang Road, Fuyong Subdistrict, Bao'an, Shenzhen, China 518103 t (86-755) 88663988 f (86-755) 26710594 www.sgs.com.cn  
 中国·深圳·宝安区福永街道凤塘大道鑫龙科技园福永实验室 邮编: 518103 t (86-755) 88663988 f (86-755) 26710594 sgs.china@sgs.com



## 9 Photographs

### 9.1 Test Setup



Unless otherwise agreed in writing, this document is issued by the Company subject to its General Conditions of Service printed overleaf, available on request or accessible at <http://www.sgs.com/en/Terms-and-Conditions.aspx> and, for electronic format documents, subject to Terms and Conditions for Electronic Documents at <http://www.sgs.com/en/Terms-and-Conditions/Terms-e-Documents.aspx>. Attention is drawn to the limitation of liability, indemnification and jurisdiction issues defined therein. Any holder of this document is advised that information contained hereon reflects the Company's findings at the time of its intervention only and within the limits of Client's instructions, if any. The Company's sole responsibility is to its Client and this document does not exonerate parties to a transaction from exercising all their rights and obligations under the transaction documents. This document cannot be reproduced except in full, without prior written approval of the Company. Any unauthorized alteration, forgery or falsification of the content or appearance of this document is unlawful and offenders may be prosecuted to the fullest extent of the law. Unless otherwise stated the results shown in this test report refer only to the sample(s) tested and such sample(s) are retained for 30 days only.  
**Attention: To check the authenticity of testing /inspection report & certificate, please contact us at telephone: (86-755) 8307 1443, or email: CN.Doccheck@sgs.com**

Fuyong lab, Xinlong TechnoPark, Fengtang Road, Fuyong Subdistrict, Bao'an, Shenzhen, China 518103 t (86-755) 88663988 f (86-755) 26710594 www.sgsgroup.com.cn  
 中国·深圳·宝安区福永街道凤塘大道鑫龙科技园福永实验室 邮编: 518103 t (86-755) 88663988 f (86-755) 26710594 sgs.china@sgs.com

## Appendix Radar Test Waveforms

### Radar Type 0

Trial List						
	Trial Id	Radar Type	Pulse Width (us)	PRI (us)	Number of Pulses	Waveform Length (us)
Download	0	Type 0	1.0	1428.0	18	25704.0
Download	1	Type 0	1.0	1428.0	18	25704.0
Download	2	Type 0	1.0	1428.0	18	25704.0
Download	3	Type 0	1.0	1428.0	18	25704.0
Download	4	Type 0	1.0	1428.0	18	25704.0
Download	5	Type 0	1.0	1428.0	18	25704.0
Download	6	Type 0	1.0	1428.0	18	25704.0
Download	7	Type 0	1.0	1428.0	18	25704.0
Download	8	Type 0	1.0	1428.0	18	25704.0
Download	9	Type 0	1.0	1428.0	18	25704.0
Download	10	Type 0	1.0	1428.0	18	25704.0
Download	11	Type 0	1.0	1428.0	18	25704.0
Download	12	Type 0	1.0	1428.0	18	25704.0
Download	13	Type 0	1.0	1428.0	18	25704.0
Download	14	Type 0	1.0	1428.0	18	25704.0
Download	15	Type 0	1.0	1428.0	18	25704.0
Download	16	Type 0	1.0	1428.0	18	25704.0
Download	17	Type 0	1.0	1428.0	18	25704.0
Download	18	Type 0	1.0	1428.0	18	25704.0
Download	19	Type 0	1.0	1428.0	18	25704.0
Download	20	Type 0	1.0	1428.0	18	25704.0
Download	21	Type 0	1.0	1428.0	18	25704.0
Download	22	Type 0	1.0	1428.0	18	25704.0
Download	23	Type 0	1.0	1428.0	18	25704.0
Download	24	Type 0	1.0	1428.0	18	25704.0
Download	25	Type 0	1.0	1428.0	18	25704.0
Download	26	Type 0	1.0	1428.0	18	25704.0
Download	27	Type 0	1.0	1428.0	18	25704.0
Download	28	Type 0	1.0	1428.0	18	25704.0
Download	29	Type 0	1.0	1428.0	18	25704.0



Unless otherwise agreed in writing, this document is issued by the Company subject to its General Conditions of Service printed overleaf, available on request or accessible at <http://www.sgs.com/en/Terms-and-Conditions.aspx> and, for electronic format documents, subject to Terms and Conditions for Electronic Documents at <http://www.sgs.com/en/Terms-and-Conditions/Terms-e-Documents.aspx>. Attention is drawn to the limitation of liability, indemnification and jurisdiction issues defined therein. Any holder of this document is advised that information contained hereon reflects the Company's findings at the time of its intervention only and within the limits of Client's instructions, if any. The Company's sole responsibility is to its Client and this document does not exonerate parties to a transaction from exercising all their rights and obligations under the transaction documents. This document cannot be reproduced except in full, without prior written approval of the Company. Any unauthorized alteration, forgery or falsification of the content or appearance of this document is unlawful and offenders may be prosecuted to the fullest extent of the law. Unless otherwise stated the results shown in this test report refer only to the sample(s) tested and such sample(s) are retained for 30 days only.  
**Attention: To check the authenticity of testing/inspection report & certificate, please contact us at telephone: (86-755) 8307 1443, or email: CN.Doccheck@sgs.com**

## Compliance Certification Services (Kunshan) Inc. Shenzhen Branch

SZCCS-TRF-01 Rev. A/0 Aug01,2022

Report No.: FYCR221200049005

Page: 51 of 115

### Radar Type 1

Trial List						
	Trial Id	Radar Type	Pulse Width (us)	PRI (us)	Number of Pulses	Waveform Length (us)
Download	0	Type 1	1.0	938.0	57	53466.0
Download	1	Type 1	1.0	698.0	76	53048.0
Download	2	Type 1	1.0	618.0	86	53148.0
Download	3	Type 1	1.0	538.0	99	53262.0
Download	4	Type 1	1.0	878.0	61	53558.0
Download	5	Type 1	1.0	3066.0	18	55188.0
Download	6	Type 1	1.0	638.0	83	52954.0
Download	7	Type 1	1.0	918.0	58	53244.0
Download	8	Type 1	1.0	838.0	63	52794.0
Download	9	Type 1	1.0	858.0	62	53196.0
Download	10	Type 1	1.0	798.0	67	53466.0
Download	11	Type 1	1.0	718.0	74	53132.0
Download	12	Type 1	1.0	578.0	92	53176.0
Download	13	Type 1	1.0	598.0	89	53222.0
Download	14	Type 1	1.0	558.0	95	53010.0
Download	15	Type 1	1.0	2536.0	21	53256.0
Download	16	Type 1	1.0	966.0	55	53130.0
Download	17	Type 1	1.0	827.0	64	52928.0
Download	18	Type 1	1.0	2501.0	22	55022.0
Download	19	Type 1	1.0	2595.0	21	54495.0
Download	20	Type 1	1.0	1114.0	48	53472.0
Download	21	Type 1	1.0	1302.0	41	53382.0
Download	22	Type 1	1.0	3045.0	18	54810.0
Download	23	Type 1	1.0	1624.0	33	53592.0
Download	24	Type 1	1.0	2878.0	19	54682.0
Download	25	Type 1	1.0	1027.0	52	53404.0
Download	26	Type 1	1.0	2485.0	22	54670.0
Download	27	Type 1	1.0	1600.0	33	52800.0
Download	28	Type 1	1.0	1172.0	46	53912.0
Download	29	Type 1	1.0	1177.0	45	52965.0



Unless otherwise agreed in writing, this document is issued by the Company subject to its General Conditions of Service printed overleaf, available on request or accessible at <http://www.sgs.com/en/Terms-and-Conditions.aspx> and, for electronic format documents, subject to Terms and Conditions for Electronic Documents at <http://www.sgs.com/en/Terms-and-Conditions/Terms-e-Documents.aspx>. Attention is drawn to the limitation of liability, indemnification and jurisdiction issues defined therein. Any holder of this document is advised that information contained hereon reflects the Company's findings only at the time of its intervention only and within the limits of Client's instructions, if any. The Company's sole responsibility is to its Client and this document does not exonerate parties to a transaction from exercising all their rights and obligations under the transaction documents. This document cannot be reproduced except in full, without prior written approval of the Company. Any unauthorized alteration, forgery or falsification of the content or appearance of this document is unlawful and offenders may be prosecuted to the fullest extent of the law. Unless otherwise stated the results shown in this test report refer only to the sample(s) tested and such sample(s) are retained for 30 days only.  
**Attention: To check the authenticity of testing /inspection report & certificate, please contact us at telephone: (86-755) 8307 1443, or email: CN.Doccheck@sgs.com**

Compliance Certification Services (Kunshan) Inc.  
 Shenzhen Branch

Fuyong lab, Xinlong TechnoPark, Fengtang Road, Fuyong Subdistrict, Bao'an, Shenzhen, China 518103 t (86-755) 88663988 f (86-755) 26710594 www.sgs.com.cn  
 中国·深圳·宝安区福永街道凤塘大道鑫龙科技园福永实验室 邮编: 518103 t (86-755) 88663988 f (86-755) 26710594 sgs.china@sgs.com

### Radar Type 2

Trial List						
	Trial Id	Radar Type	Pulse Width (us)	PRI (us)	Number of Pulses	Waveform Length (us)
Download	0	Type 2	3.2	179.0	26	4654.0
Download	1	Type 2	1.1	207.0	23	4761.0
Download	2	Type 2	2.1	230.0	24	5520.0
Download	3	Type 2	4.8	200.0	29	5800.0
Download	4	Type 2	3.9	214.0	28	5992.0
Download	5	Type 2	2.9	222.0	26	5772.0
Download	6	Type 2	3.2	204.0	26	5304.0
Download	7	Type 2	2.5	192.0	25	4800.0
Download	8	Type 2	3.1	164.0	26	4264.0
Download	9	Type 2	1.2	156.0	23	3588.0
Download	10	Type 2	3.9	210.0	27	5670.0
Download	11	Type 2	4.6	201.0	29	5829.0
Download	12	Type 2	3.2	162.0	26	4212.0
Download	13	Type 2	2.2	197.0	25	4925.0
Download	14	Type 2	4.5	163.0	29	4727.0
Download	15	Type 2	3.0	203.0	26	5278.0
Download	16	Type 2	5.0	168.0	29	4872.0
Download	17	Type 2	2.4	217.0	25	5425.0
Download	18	Type 2	2.9	191.0	26	4966.0
Download	19	Type 2	2.3	166.0	25	4150.0
Download	20	Type 2	3.7	150.0	27	4050.0
Download	21	Type 2	2.2	176.0	25	4400.0
Download	22	Type 2	4.9	195.0	29	5655.0
Download	23	Type 2	2.9	202.0	26	5252.0
Download	24	Type 2	2.5	178.0	25	4450.0
Download	25	Type 2	1.1	206.0	23	4738.0
Download	26	Type 2	3.8	155.0	27	4185.0
Download	27	Type 2	4.7	157.0	29	4553.0
Download	28	Type 2	2.4	224.0	25	5600.0
Download	29	Type 2	4.2	159.0	28	4452.0



Unless otherwise agreed in writing, this document is issued by the Company subject to its General Conditions of Service printed overleaf, available on request or accessible at <http://www.sgs.com/en/Terms-and-Conditions.aspx> and, for electronic format documents, subject to Terms and Conditions for Electronic Documents at <http://www.sgs.com/en/Terms-and-Conditions/Terms-e-Documents.aspx>. Attention is drawn to the limitation of liability, indemnification and jurisdiction issues defined therein. Any holder of this document is advised that information contained hereon reflects the Company's findings at the time of its intervention only and within the limits of Client's instructions, if any. The Company's sole responsibility is to its Client and this document does not exonerate parties to a transaction from exercising all their rights and obligations under the transaction documents. This document cannot be reproduced except in full, without prior written approval of the Company. Any unauthorized alteration, forgery or falsification of the content or appearance of this document is unlawful and offenders may be prosecuted to the fullest extent of the law. Unless otherwise stated the results shown in this test report refer only to the sample(s) tested and such sample(s) are retained for 30 days only.  
**Attention: To check the authenticity of testing /inspection report & certificate, please contact us at telephone: (86-755) 8307 1443, or email: CN.Doccheck@sgs.com**

Compliance Certification Services (Kunshan) Inc.  
 Shenzhen Branch

Fuyong lab, Xinlong TechnoPark, Fengtang Road, Fuyong Subdistrict, Bao'an, Shenzhen, China 518103 t (86-755) 88663988 f (86-755) 26710594 www.sgs.com.cn  
 中国·深圳·宝安区福永街道凤塘大道鑫龙科技园福永实验室 邮编: 518103 t (86-755) 88663988 f (86-755) 26710594 sgs.china@sgs.com

### Radar Type 3

Trial List						
	Trial Id	Radar Type	Pulse Width (us)	PRI (us)	Number of Pulses	Waveform Length (us)
Download	0	Type 3	8.2	355.0	17	6035.0
Download	1	Type 3	6.1	487.0	16	7792.0
Download	2	Type 3	7.1	344.0	16	5504.0
Download	3	Type 3	9.8	288.0	18	5184.0
Download	4	Type 3	8.9	230.0	18	4140.0
Download	5	Type 3	7.9	432.0	17	7344.0
Download	6	Type 3	8.2	207.0	17	3519.0
Download	7	Type 3	7.5	443.0	17	7531.0
Download	8	Type 3	8.1	439.0	17	7463.0
Download	9	Type 3	6.2	223.0	16	3568.0
Download	10	Type 3	8.9	208.0	18	3744.0
Download	11	Type 3	9.6	463.0	18	8334.0
Download	12	Type 3	8.2	441.0	17	7497.0
Download	13	Type 3	7.2	323.0	16	5168.0
Download	14	Type 3	9.5	297.0	18	5346.0
Download	15	Type 3	8.0	412.0	17	7004.0
Download	16	Type 3	10.0	324.0	18	5832.0
Download	17	Type 3	7.4	271.0	17	4607.0
Download	18	Type 3	7.9	349.0	17	5933.0
Download	19	Type 3	7.3	409.0	16	6544.0
Download	20	Type 3	8.7	373.0	18	6714.0
Download	21	Type 3	7.2	254.0	16	4064.0
Download	22	Type 3	9.9	274.0	18	4932.0
Download	23	Type 3	7.9	278.0	17	4726.0
Download	24	Type 3	7.5	317.0	17	5389.0
Download	25	Type 3	6.1	260.0	16	4160.0
Download	26	Type 3	8.8	211.0	18	3798.0
Download	27	Type 3	9.7	272.0	18	4896.0
Download	28	Type 3	7.4	264.0	17	4488.0
Download	29	Type 3	9.2	284.0	18	5112.0



Unless otherwise agreed in writing, this document is issued by the Company subject to its General Conditions of Service printed overleaf, available on request or accessible at <http://www.sgs.com/en/Terms-and-Conditions.aspx> and, for electronic format documents, subject to Terms and Conditions for Electronic Documents at <http://www.sgs.com/en/Terms-and-Conditions/Terms-e-Documents.aspx>. Attention is drawn to the limitation of liability, indemnification and jurisdiction issues defined therein. Any holder of this document is advised that information contained hereon reflects the Company's findings at the time of its intervention only and within the limits of Client's instructions, if any. The Company's sole responsibility is to its Client and this document does not exonerate parties to a transaction from exercising all their rights and obligations under the transaction documents. This document cannot be reproduced except in full, without prior written approval of the Company. Any unauthorized alteration, forgery or falsification of the content or appearance of this document is unlawful and offenders may be prosecuted to the fullest extent of the law. Unless otherwise stated the results shown in this test report refer only to the sample(s) tested and such sample(s) are retained for 30 days only.  
**Attention: To check the authenticity of testing /inspection report & certificate, please contact us at telephone: (86-755) 8307 1443, or email: CN.Doccheck@sgs.com**

## Compliance Certification Services (Kunshan) Inc. Shenzhen Branch

SZCCS-TRF-01 Rev. A/0 Aug01,2022

Report No.: FYCR221200049005

Page: 54 of 115

### Radar Type 4

Trial List						
	Trial Id	Radar Type	Pulse Width (us)	PRI (us)	Number of Pulses	Waveform Length (us)
Download	0	Type 4	16.0	355.0	14	4970.0
Download	1	Type 4	11.3	487.0	12	5844.0
Download	2	Type 4	13.5	344.0	13	4472.0
Download	3	Type 4	19.4	288.0	16	4608.0
Download	4	Type 4	17.5	230.0	15	3450.0
Download	5	Type 4	15.3	432.0	14	6048.0
Download	6	Type 4	15.9	207.0	14	2898.0
Download	7	Type 4	14.3	443.0	13	5759.0
Download	8	Type 4	15.8	439.0	14	6146.0
Download	9	Type 4	11.5	223.0	12	2676.0
Download	10	Type 4	17.4	208.0	15	3120.0
Download	11	Type 4	19.0	463.0	16	7408.0
Download	12	Type 4	16.0	441.0	14	6174.0
Download	13	Type 4	13.8	323.0	13	4199.0
Download	14	Type 4	18.9	297.0	16	4752.0
Download	15	Type 4	15.5	412.0	14	5768.0
Download	16	Type 4	19.9	324.0	16	5184.0
Download	17	Type 4	14.1	271.0	13	3523.0
Download	18	Type 4	15.2	349.0	14	4886.0
Download	19	Type 4	13.8	409.0	13	5317.0
Download	20	Type 4	17.1	373.0	15	5595.0
Download	21	Type 4	13.8	254.0	13	3302.0
Download	22	Type 4	19.8	274.0	16	4384.0
Download	23	Type 4	15.3	278.0	14	3892.0
Download	24	Type 4	14.5	317.0	13	4121.0
Download	25	Type 4	11.3	260.0	12	3120.0
Download	26	Type 4	17.3	211.0	15	3165.0
Download	27	Type 4	19.2	272.0	16	4352.0
Download	28	Type 4	14.2	264.0	13	3432.0
Download	29	Type 4	18.2	284.0	15	4260.0



Unless otherwise agreed in writing, this document is issued by the Company subject to its General Conditions of Service printed overleaf, available on request or accessible at <http://www.sgs.com/en/Terms-and-Conditions.aspx> and, for electronic format documents, subject to Terms and Conditions for Electronic Documents at <http://www.sgs.com/en/Terms-and-Conditions/Terms-e-Documents.aspx>. Attention is drawn to the limitation of liability, indemnification and jurisdiction issues defined therein. Any holder of this document is advised that information contained hereon reflects the Company's findings at the time of its intervention only and within the limits of Client's instructions, if any. The Company's sole responsibility is to its Client and this document does not exonerate parties to a transaction from exercising all their rights and obligations under the transaction documents. This document cannot be reproduced except in full, without prior written approval of the Company. Any unauthorized alteration, forgery or falsification of the content or appearance of this document is unlawful and offenders may be prosecuted to the fullest extent of the law. Unless otherwise stated the results shown in this test report refer only to the sample(s) tested and such sample(s) are retained for 30 days only.  
**Attention: To check the authenticity of testing /inspection report & certificate, please contact us at telephone: (86-755) 8307 1443, or email: CN.Doccheck@sgs.com**

Compliance Certification Services (Kunshan) Inc.  
 Shenzhen Branch

Fuyong lab, Xinlong TechnoPark, Fengtang Road, Fuyong Subdistrict, Bao'an, Shenzhen, China 518103 t (86-755) 88663988 f (86-755) 26710594 www.sgsgroup.com.cn  
 中国·深圳·宝安区福永街道凤塘大道鑫龙科技园福永实验室 邮编: 518103 t (86-755) 88663988 f (86-755) 26710594 sgs.china@sgs.com

## Compliance Certification Services (Kunshan) Inc. Shenzhen Branch

SZCCS-TRF-01 Rev. A/0 Aug01,2022

Report No.: FYCR221200049005

Page: 55 of 115

### Radar Type 5 - All

Trial List										
	Trial Id	Radar Type	Number of Bursts	Burst Period (s)	Waveform Length (s)	Center Frequency (GHz)				
Download	0	Type 5	15	0.8000000	12.0000000	5.500000000				
Download	1	Type 5	8	1.5000000	12.0000000	5.500000000				
Download	2	Type 5	11	1.0909091	12.0000000	5.500000000				
Download	3	Type 5	20	0.6000000	12.0000000	5.500000000				
Download	4	Type 5	17	0.7058824	12.0000000	5.500000000				
Download	5	Type 5	14	0.8571429	12.0000000	5.500000000				
Download	6	Type 5	15	0.8000000	12.0000000	5.500000000				
Download	7	Type 5	12	1.0000000	12.0000000	5.500000000				
Download	8	Type 5	14	0.8571429	12.0000000	5.500000000				
Download	9	Type 5	8	1.5000000	12.0000000	5.500000000				
Download	10	Type 5	17	0.7058824	12.0000000	5.503900000				
Download	11	Type 5	19	0.6315789	12.0000000	5.505100000				
Download	12	Type 5	15	0.8000000	12.0000000	5.502700000				
Download	13	Type 5	12	1.0000000	12.0000000	5.501500000				
Download	14	Type 5	19	0.6315789	12.0000000	5.504700000				
Download	15	Type 5	14	0.8571429	12.0000000	5.502300000				
Download	16	Type 5	20	0.6000000	12.0000000	5.505500000				
Download	17	Type 5	12	1.0000000	12.0000000	5.501500000				
Download	18	Type 5	14	0.8571429	12.0000000	5.502300000				
Download	19	Type 5	12	1.0000000	12.0000000	5.501500000				
Download	20	Type 5	16	0.7500000	12.0000000	5.496500000				
Download	21	Type 5	12	1.0000000	12.0000000	5.498900000				
Download	22	Type 5	20	0.6000000	12.0000000	5.494500000				
Download	23	Type 5	14	0.8571429	12.0000000	5.497700000				
Download	24	Type 5	13	0.9230769	12.0000000	5.498100000				
Download	25	Type 5	8	1.5000000	12.0000000	5.500500000				
Download	26	Type 5	17	0.7058824	12.0000000	5.496100000				
Download	27	Type 5	19	0.6315789	12.0000000	5.494900000				
Download	28	Type 5	12	1.0000000	12.0000000	5.498500000				
Download	29	Type 5	18	0.6666667	12.0000000	5.495700000				



Unless otherwise agreed in writing, this document is issued by the Company subject to its General Conditions of Service printed overleaf, available on request or accessible at <http://www.sgs.com/en/Terms-and-Conditions.aspx> and, for electronic format documents, subject to Terms and Conditions for Electronic Documents at <http://www.sgs.com/en/Terms-and-Conditions/Terms-e-Document.aspx>. Attention is drawn to the limitation of liability, indemnification and jurisdiction issues defined therein. Any holder of this document is advised that information contained hereon reflects the Company's findings at the time of its intervention only and within the limits of Client's instructions, if any. The Company's sole responsibility is to its Client and this document does not exonerate parties to a transaction from exercising all their rights and obligations under the transaction documents. This document cannot be reproduced except in full, without prior written approval of the Company. Any unauthorized alteration, forgery or falsification of the content or appearance of this document is unlawful and offenders may be prosecuted to the fullest extent of the law. Unless otherwise stated the results shown in this test report refer only to the sample(s) tested and such sample(s) are retained for 30 days only. Attention: To check the authenticity of testing/inspection report & certificate, please contact us at telephone: (86-755) 8307 1443, or email: CN.Doccheck@sgs.com

Compliance Certification Services (Kunshan) Inc. Shenzhen Branch

Fuyong lab, Xinlong TechnoPark, Fengtang Road, Fuyong Subdistrict, Bao'an, Shenzhen, China 518103 t (86-755) 88663988 f (86-755) 26710594 www.sgs.com.cn  
 中国·深圳·宝安区福永街道凤塘大道鑫龙科技园福永实验室 邮编: 518103 t (86-755) 88663988 f (86-755) 26710594 sgs.china@sgs.com

## Compliance Certification Services (Kunshan) Inc. Shenzhen Branch

SZCCS-TRF-01 Rev. A/0 Aug01,2022

Report No.: FYCR221200049005

Page: 56 of 115

### Radar Type 5 - Trial 0

Trial List											
	Trial Id	Radar Type	Number of Bursts	Burst Period (s)	Waveform Length (s)	Center Frequency (GHz)					
<input checked="" type="checkbox"/>	Download	0	Type 5	15	0.8000000	12.0000000	5.500000000				
			Burst ID	Burst Offset (us)	Pulse Width (us)	Chirp Width (MHz)	Number of Pulses per Burst	PRI-1 (us)	PRI-2 (us)	PRI-3 (us)	
			0	636185.0	77.8	13	2	1665.0	1477.0	-	
			1	32674.0	51.9	13	1	1074.0	-	-	
			2	226294.0	63.8	13	1	1584.0	-	-	
			3	417976.0	96.6	13	3	1682.0	1786.0	1843.0	
			4	611152.0	85.9	13	3	1795.0	1215.0	1729.0	
			5	8789.0	73.7	13	2	1198.0	1549.0	-	
			6	201917.0	77.2	13	2	1837.0	1819.0	-	
			7	395530.0	68.4	13	2	1587.0	1114.0	-	
			8	588564.0	76.7	13	2	2000.0	1155.0	-	
			9	783794.0	53.2	13	1	1147.0	-	-	
			10	177933.0	85.7	13	3	1433.0	1695.0	1394.0	
			11	370624.0	94.3	13	3	1670.0	1426.0	1935.0	
			12	564893.0	77.6	13	2	1294.0	1671.0	-	
			13	759583.0	65.7	13	1	1512.0	-	-	
			14	154262.0	93.5	13	3	1444.0	1130.0	1468.0	
<input checked="" type="checkbox"/>	Download	1	Type 5	8	1.5000000	12.0000000	5.500000000				
<input checked="" type="checkbox"/>	Download	2	Type 5	11	1.0909091	12.0000000	5.500000000				
<input checked="" type="checkbox"/>	Download	3	Type 5	20	0.6000000	12.0000000	5.500000000				
<input checked="" type="checkbox"/>	Download	4	Type 5	17	0.7058824	12.0000000	5.500000000				
<input checked="" type="checkbox"/>	Download	5	Type 5	14	0.8571429	12.0000000	5.500000000				
<input checked="" type="checkbox"/>	Download	6	Type 5	15	0.8000000	12.0000000	5.500000000				
<input checked="" type="checkbox"/>	Download	7	Type 5	12	1.0000000	12.0000000	5.500000000				
<input checked="" type="checkbox"/>	Download	8	Type 5	14	0.8571429	12.0000000	5.500000000				
<input checked="" type="checkbox"/>	Download	9	Type 5	8	1.5000000	12.0000000	5.500000000				
<input checked="" type="checkbox"/>	Download	10	Type 5	17	0.7058824	12.0000000	5.503900000				
<input checked="" type="checkbox"/>	Download	11	Type 5	19	0.6315789	12.0000000	5.505100000				
<input checked="" type="checkbox"/>	Download	12	Type 5	15	0.8000000	12.0000000	5.502700000				
<input checked="" type="checkbox"/>	Download	13	Type 5	12	1.0000000	12.0000000	5.501500000				
<input checked="" type="checkbox"/>	Download	14	Type 5	19	0.6315789	12.0000000	5.504700000				



Unless otherwise agreed in writing, this document is issued by the Company subject to its General Conditions of Service printed overleaf, available on request or accessible at <http://www.sgs.com/en/Terms-and-Conditions.aspx> and, for electronic format documents, subject to Terms and Conditions for Electronic Documents at <http://www.sgs.com/en/Terms-and-Conditions/Terms-e-Documents.aspx>. Attention is drawn to the limitation of liability, indemnification and jurisdiction issues defined therein. Any holder of this document is advised that information contained hereon reflects the Company's findings at the time of its intervention only and within the limits of Client's instructions, if any. The Company's sole responsibility is to its Client and this document does not exonerate parties to a transaction from exercising all their rights and obligations under the transaction documents. This document cannot be reproduced except in full, without prior written approval of the Company. Any unauthorized alteration, forgery or falsification of the content or appearance of this document is unlawful and offenders may be prosecuted to the fullest extent of the law. Unless otherwise stated the results shown in this test report refer only to the sample(s) tested and such sample(s) are retained for 30 days only. Attention: To check the authenticity of testing/inspection report & certificate, please contact us at telephone: (86-755) 8307 1443, or email: CN.Doccheck@sgs.com

Compliance Certification Services (Kunshan) Inc. Shenzhen Branch

Fuyong Lab, Xinlong TechnoPark, Fengtang Road, Fuyong Subdistrict, Bao'an, Shenzhen, China 518103 t (86-755) 88663988 f (86-755) 26710594 www.sgs.com.cn  
 中国·深圳·宝安区福永街道凤塘大道鑫龙科技园福永实验室 邮编: 518103 t (86-755) 88663988 f (86-755) 26710594 sgs.china@sgs.com



## Compliance Certification Services (Kunshan) Inc. Shenzhen Branch

SZCCS-TRF-01 Rev. A/0 Aug01,2022

Report No.: FYCR221200049005

Page: 57 of 115

### Radar Type 5 - Trial 1

Trial List										
	Trial Id	Radar Type	Number of Bursts	Burst Period (s)	Waveform Length (s)	Center Frequency (GHz)				
<input checked="" type="checkbox"/>	Download	0	Type 5	15	0.8000000	12.0000000	5.500000000			
<input type="checkbox"/>	Download	1	Type 5	8	1.5000000	12.0000000	5.500000000			
			<b>Burst ID</b>	<b>Burst Offset (us)</b>	<b>Pulse Width (us)</b>	<b>Chirp Width (MHz)</b>	<b>Number of Pulses per Burst</b>	<b>PRI-1 (us)</b>	<b>PRI-2 (us)</b>	<b>PRI-3 (us)</b>
			0	653020.0	75.0	5	2	1880.0	1527.0	-
			1	1015643.0	99.4	5	3	1401.0	1262.0	1257.0
			2	1379398.0	67.4	5	2	1531.0	1403.0	-
			3	245489.0	73.6	5	2	1449.0	1041.0	-
			4	609113.0	65.9	5	1	1432.0	-	-
			5	970852.0	83.8	5	3	1356.0	1292.0	1419.0
			6	1335913.0	65.5	5	1	1543.0	-	-
			7	200406.0	98.6	5	3	1548.0	1796.0	1728.0
<input checked="" type="checkbox"/>	Download	2	Type 5	11	1.0909091	12.0000000	5.500000000			
<input checked="" type="checkbox"/>	Download	3	Type 5	20	0.6000000	12.0000000	5.500000000			
<input checked="" type="checkbox"/>	Download	4	Type 5	17	0.7058824	12.0000000	5.500000000			
<input checked="" type="checkbox"/>	Download	5	Type 5	14	0.8571429	12.0000000	5.500000000			
<input checked="" type="checkbox"/>	Download	6	Type 5	15	0.8000000	12.0000000	5.500000000			
<input checked="" type="checkbox"/>	Download	7	Type 5	12	1.0000000	12.0000000	5.500000000			
<input checked="" type="checkbox"/>	Download	8	Type 5	14	0.8571429	12.0000000	5.500000000			
<input checked="" type="checkbox"/>	Download	9	Type 5	8	1.5000000	12.0000000	5.500000000			
<input checked="" type="checkbox"/>	Download	10	Type 5	17	0.7058824	12.0000000	5.503900000			
<input checked="" type="checkbox"/>	Download	11	Type 5	19	0.6315789	12.0000000	5.505100000			
<input checked="" type="checkbox"/>	Download	12	Type 5	15	0.8000000	12.0000000	5.502700000			
<input checked="" type="checkbox"/>	Download	13	Type 5	12	1.0000000	12.0000000	5.501500000			
<input checked="" type="checkbox"/>	Download	14	Type 5	19	0.6315789	12.0000000	5.504700000			
<input checked="" type="checkbox"/>	Download	15	Type 5	14	0.8571429	12.0000000	5.502300000			
<input checked="" type="checkbox"/>	Download	16	Type 5	20	0.6000000	12.0000000	5.505500000			
<input checked="" type="checkbox"/>	Download	17	Type 5	12	1.0000000	12.0000000	5.501500000			
<input checked="" type="checkbox"/>	Download	18	Type 5	14	0.8571429	12.0000000	5.502300000			
<input checked="" type="checkbox"/>	Download	19	Type 5	12	1.0000000	12.0000000	5.501500000			
<input checked="" type="checkbox"/>	Download	20	Type 5	16	0.7500000	12.0000000	5.496500000			



Unless otherwise agreed in writing, this document is issued by the Company subject to its General Conditions of Service printed overleaf, available on request or accessible at <http://www.sgs.com/en/Terms-and-Conditions.aspx> and, for electronic format documents, subject to Terms and Conditions for Electronic Documents at <http://www.sgs.com/en/Terms-and-Conditions/Terms-e-Documents.aspx>. Attention is drawn to the limitation of liability, indemnification and jurisdiction issues defined therein. Any holder of this document is advised that information contained hereon reflects the Company's findings at the time of its intervention only and within the limits of Client's instructions, if any. The Company's sole responsibility is to its Client and this document does not exonerate parties to a transaction from exercising all their rights and obligations under the transaction documents. This document cannot be reproduced except in full, without prior written approval of the Company. Any unauthorized alteration, forgery or falsification of the content or appearance of this document is unlawful and offenders may be prosecuted to the fullest extent of the law. Unless otherwise stated the results shown in this test report refer only to the sample(s) tested and such sample(s) are retained for 30 days only. Attention: To check the authenticity of testing /inspection report & certificate, please contact us at telephone: (86-755) 8307 1443, or email: CN.Doccheck@sgs.com

Compliance Certification Services (Kunshan) Inc. Shenzhen Branch

Fuyong Lab, Xinlong TechnoPark, Fengtang Road, Fuyong Subdistrict, Bao'an, Shenzhen, China 518103 t (86-755) 88663988 f (86-755) 26710594 www.sgs.com.cn  
 中国·深圳·宝安区福永街道凤塘大道鑫龙科技园福永实验室 邮编: 518103 t (86-755) 88663988 f (86-755) 26710594 sgs.china@sgs.com

## Compliance Certification Services (Kunshan) Inc. Shenzhen Branch

SZCCS-TRF-01 Rev. A/0 Aug01,2022

Report No.: FYCR221200049005

Page: 58 of 115

### Radar Type 5 - Trial 2

Trial List										
	Trial Id	Radar Type	Number of Bursts	Burst Period (s)	Waveform Length (s)	Center Frequency (GHz)				
Download	0	Type 5	15	0.8000000	12.0000000	5.500000000				
Download	1	Type 5	8	1.5000000	12.0000000	5.500000000				
Download	2	Type 5	11	1.0909091	12.0000000	5.500000000				
		<b>Burst ID</b>	<b>Burst Offset (us)</b>	<b>Pulse Width (us)</b>	<b>Chirp Width (MHz)</b>	<b>Number of Pulses per Burst</b>	<b>PRI-1 (us)</b>	<b>PRI-2 (us)</b>	<b>PRI-3 (us)</b>	
		0	409565.0	73.8	9	2	1806.0	1538.0	-	
		1	673692.0	69.5	9	2	1117.0	1649.0	-	
		2	938562.0	51.9	9	1	1651.0	-	-	
		3	113209.0	84.6	9	3	1976.0	1032.0	1271.0	
		4	376726.0	95.4	9	3	1060.0	1903.0	1388.0	
		5	641212.0	68.0	9	2	1368.0	1351.0	-	
		6	903714.0	89.6	9	3	1338.0	1514.0	1573.0	
		7	80863.0	81.9	9	2	1022.0	1689.0	-	
		8	344067.0	88.3	9	3	1810.0	1330.0	1838.0	
		9	609331.0	53.7	9	1	1597.0	-	-	
		10	871542.0	91.3	9	3	1961.0	1106.0	1001.0	
Download	3	Type 5	20	0.6000000	12.0000000	5.500000000				
Download	4	Type 5	17	0.7058824	12.0000000	5.500000000				
Download	5	Type 5	14	0.8571429	12.0000000	5.500000000				
Download	6	Type 5	15	0.8000000	12.0000000	5.500000000				
Download	7	Type 5	12	1.0000000	12.0000000	5.500000000				
Download	8	Type 5	14	0.8571429	12.0000000	5.500000000				
Download	9	Type 5	8	1.5000000	12.0000000	5.500000000				
Download	10	Type 5	17	0.7058824	12.0000000	5.503900000				
Download	11	Type 5	19	0.6315789	12.0000000	5.505100000				
Download	12	Type 5	15	0.8000000	12.0000000	5.502700000				
Download	13	Type 5	12	1.0000000	12.0000000	5.501500000				
Download	14	Type 5	19	0.6315789	12.0000000	5.504700000				
Download	15	Type 5	14	0.8571429	12.0000000	5.502300000				
Download	16	Type 5	20	0.6000000	12.0000000	5.505500000				
Download	17	Type 5	12	1.0000000	12.0000000	5.501500000				
Download	18	Type 5	14	0.8571429	12.0000000	5.502300000				



Unless otherwise agreed in writing, this document is issued by the Company subject to its General Conditions of Service printed overleaf, available on request or accessible at <http://www.sgs.com/en/Terms-and-Conditions.aspx> and, for electronic format documents, subject to Terms and Conditions for Electronic Documents at <http://www.sgs.com/en/Terms-and-Conditions/Terms-e-Documents.aspx>. Attention is drawn to the limitation of liability, indemnification and jurisdiction issues defined therein. Any holder of this document is advised that information contained hereon reflects the Company's findings at the time of its intervention only and within the limits of Client's instructions, if any. The Company's sole responsibility is to its Client and this document does not exonerate parties to a transaction from exercising all their rights and obligations under the transaction documents. This document cannot be reproduced except in full, without prior written approval of the Company. Any unauthorized alteration, forgery or falsification of the content or appearance of this document is unlawful and offenders may be prosecuted to the fullest extent of the law. Unless otherwise stated the results shown in this test report refer only to the sample(s) tested and such sample(s) are retained for 30 days only. Attention: To check the authenticity of testing/inspection report & certificate, please contact us at telephone: (86-755) 8307 1443, or email: CN.Doccheck@sgs.com

Compliance Certification Services (Kunshan) Inc. Shenzhen Branch

Fuyong lab, Xinlong TechnoPark, Fengtang Road, Fuyong Subdistrict, Bao'an, Shenzhen, China 518103 t (86-755) 88663988 f (86-755) 26710594 www.sgs.com.cn  
 中国·深圳·宝安区福永街道凤塘大道鑫龙科技园福永实验室 邮编: 518103 t (86-755) 88663988 f (86-755) 26710594 sgs.china@sgs.com

## Compliance Certification Services (Kunshan) Inc. Shenzhen Branch

SZCCS-TRF-01 Rev. A/0 Aug01,2022

Report No.: FYCR221200049005

Page: 59 of 115

### Radar Type 5 - Trial 3

Trial List										
	Trial Id	Radar Type	Number of Bursts	Burst Period (s)	Waveform Length (s)	Center Frequency (GHz)				
Download	0	Type 5	15	0.8000000	12.0000000	5.500000000				
Download	1	Type 5	8	1.5000000	12.0000000	5.500000000				
Download	2	Type 5	11	1.0909091	12.0000000	5.500000000				
Download	3	Type 5	20	0.6000000	12.0000000	5.500000000				
		<b>Burst ID</b>	<b>Burst Offset (us)</b>	<b>Pulse Width (us)</b>	<b>Chirp Width (MHz)</b>	<b>Number of Pulses per Burst</b>	<b>PRI-1 (us)</b>	<b>PRI-2 (us)</b>	<b>PRI-3 (us)</b>	
		0	26541.0	68.1	19	2	1339.0	1355.0	-	
		1	171821.0	58.7	19	1	1251.0	-	-	
		2	316229.0	75.3	19	2	1136.0	1640.0	-	
		3	461864.0	56.4	19	1	1753.0	-	-	
		4	8677.0	99.7	19	3	1196.0	1708.0	1159.0	
		5	153995.0	57.7	19	1	1013.0	-	-	
		6	299238.0	59.5	19	1	1072.0	-	-	
		7	443177.0	80.0	19	2	1482.0	1369.0	-	
		8	587671.0	82.0	19	2	1993.0	1197.0	-	
		9	135674.0	82.8	19	2	1883.0	1005.0	-	
		10	279928.0	88.0	19	3	1061.0	1928.0	1101.0	
		11	424279.0	93.2	19	3	1207.0	1907.0	1223.0	
		12	570132.0	70.4	19	2	1526.0	1360.0	-	
		13	117439.0	95.3	19	3	1171.0	1955.0	1775.0	
		14	262502.0	81.9	19	2	1690.0	1545.0	-	
		15	406573.0	98.5	19	3	1975.0	1169.0	1062.0	
		16	553328.0	65.0	19	1	1767.0	-	-	
		17	99799.0	85.4	19	3	1011.0	1637.0	1425.0	
		18	244095.0	91.6	19	3	1878.0	1445.0	1325.0	
		19	390012.0	67.3	19	2	1091.0	1218.0	-	
Download	4	Type 5	17	0.7058824	12.0000000	5.500000000				
Download	5	Type 5	14	0.8571429	12.0000000	5.500000000				
Download	6	Type 5	15	0.8000000	12.0000000	5.500000000				
Download	7	Type 5	12	1.0000000	12.0000000	5.500000000				
Download	8	Type 5	14	0.8571429	12.0000000	5.500000000				
Download	9	Type 5	8	1.5000000	12.0000000	5.500000000				
Download	10	Type 5	17	0.7058824	12.0000000	5.503900000				



Unless otherwise agreed in writing, this document is issued by the Company subject to its General Conditions of Service printed overleaf, available on request or accessible at <http://www.sgs.com/en/Terms-and-Conditions.aspx> and, for electronic format documents, subject to Terms and Conditions for Electronic Documents at <http://www.sgs.com/en/Terms-and-Conditions/Terms-e-Documents.aspx>. Attention is drawn to the limitation of liability, indemnification and jurisdiction issues defined therein. Any holder of this document is advised that information contained hereon reflects the Company's findings at the time of its intervention only and within the limits of Client's instructions, if any. The Company's sole responsibility is to its Client and this document does not exonerate parties to a transaction from exercising all their rights and obligations under the transaction documents. This document cannot be reproduced except in full, without prior written approval of the Company. Any unauthorized alteration, forgery or falsification of the content or appearance of this document is unlawful and offenders may be prosecuted to the fullest extent of the law. Unless otherwise stated the results shown in this test report refer only to the sample(s) tested and such sample(s) are retained for 30 days only. **Attention: To check the authenticity of testing/inspection report & certificate, please contact us at telephone: (86-755) 8307 1443, or email: CN.Doccheck@sgs.com**

Compliance Certification Services (Kunshan) Inc. Shenzhen Branch

Fuyong Lab, Xinlong TechnoPark, Fengtang Road, Fuyong Subdistrict, Bao'an, Shenzhen, China 518103 t (86-755) 88663988 f (86-755) 26710594 www.sgs.com.cn  
 中国·深圳·宝安区福永街道凤塘大道鑫龙科技园福永实验室 邮编: 518103 t (86-755) 88663988 f (86-755) 26710594 sgs.china@sgs.com

## Compliance Certification Services (Kunshan) Inc. Shenzhen Branch

SZCCS-TRF-01 Rev. A/0 Aug01,2022

Report No.: FYCR221200049005

Page: 60 of 115

### Radar Type 5 - Trial 4

Trial List										
	Trial Id	Radar Type	Number of Bursts	Burst Period (s)	Waveform Length (s)	Center Frequency (GHz)				
Download	0	Type 5	15	0.8000000	12.0000000	5.500000000				
Download	1	Type 5	8	1.5000000	12.0000000	5.500000000				
Download	2	Type 5	11	1.0909091	12.0000000	5.500000000				
Download	3	Type 5	20	0.6000000	12.0000000	5.500000000				
Download	4	Type 5	17	0.7058824	12.0000000	5.500000000				
		Burst ID	Burst Offset (us)	Pulse Width (us)	Chirp Width (MHz)	Number of Pulses per Burst	PRI-1 (us)	PRI-2 (us)	PRI-3 (us)	
		0	629614.0	67.9	16	2	1320.0	1133.0	-	
		1	96856.0	62.3	16	1	1957.0	-	-	
		2	267719.0	53.3	16	1	1592.0	-	-	
		3	436784.0	90.0	16	3	1900.0	1153.0	1346.0	
		4	608289.0	77.1	16	2	1166.0	1646.0	-	
		5	75610.0	83.9	16	3	1278.0	1232.0	1459.0	
		6	245638.0	89.1	16	3	1240.0	1384.0	1939.0	
		7	416355.0	81.8	16	2	1833.0	1676.0	-	
		8	588736.0	50.3	16	1	1075.0	-	-	
		9	54571.0	87.1	16	3	1116.0	1996.0	1756.0	
		10	225175.0	71.3	16	2	1225.0	1815.0	-	
		11	394825.0	97.5	16	3	1884.0	1465.0	1132.0	
		12	565361.0	90.6	16	3	1561.0	1040.0	1354.0	
		13	33643.0	86.3	16	3	1596.0	1183.0	1792.0	
		14	203957.0	97.6	16	3	1365.0	1073.0	1361.0	
		15	373812.0	84.7	16	3	1021.0	1718.0	1854.0	
		16	544060.0	99.7	16	3	1150.0	1244.0	1988.0	
Download	5	Type 5	14	0.8571429	12.0000000	5.500000000				
Download	6	Type 5	15	0.8000000	12.0000000	5.500000000				
Download	7	Type 5	12	1.0000000	12.0000000	5.500000000				
Download	8	Type 5	14	0.8571429	12.0000000	5.500000000				
Download	9	Type 5	8	1.5000000	12.0000000	5.500000000				
Download	10	Type 5	17	0.7058824	12.0000000	5.503900000				
Download	11	Type 5	19	0.6315789	12.0000000	5.505100000				
Download	12	Type 5	15	0.8000000	12.0000000	5.502700000				
Download	13	Type 5	12	1.0000000	12.0000000	5.501500000				



Unless otherwise agreed in writing, this document is issued by the Company subject to its General Conditions of Service printed overleaf, available on request or accessible at <http://www.sgs.com/en/Terms-and-Conditions.aspx> and, for electronic format documents, subject to Terms and Conditions for Electronic Documents at <http://www.sgs.com/en/Terms-and-Conditions/Terms-e-Documents.aspx>. Attention is drawn to the limitation of liability, indemnification and jurisdiction issues defined therein. Any holder of this document is advised that information contained hereon reflects the Company's findings at the time of its intervention only and within the limits of Client's instructions, if any. The Company's sole responsibility is to its Client and this document does not exonerate parties to a transaction from exercising all their rights and obligations under the transaction documents. This document cannot be reproduced except in full, without prior written approval of the Company. Any unauthorized alteration, forgery or falsification of the content or appearance of this document is unlawful and offenders may be prosecuted to the fullest extent of the law. Unless otherwise stated the results shown in this test report refer only to the sample(s) tested and such sample(s) are retained for 30 days only. Attention: To check the authenticity of testing/inspection report & certificate, please contact us at telephone: (86-755) 8307 1443, or email: CN.Doccheck@sgs.com

Fuyong lab, Xinlong TechnoPark, Fengtang Road, Fuyong Subdistrict, Bao'an, Shenzhen, China 518103 t (86-755) 88663988 f (86-755) 26710594 www.sgs.com.cn  
 中国·深圳·宝安区福永街道凤塘大道鑫龙科技园福永实验室 邮编: 518103 t (86-755) 88663988 f (86-755) 26710594 sgs.china@sgs.com

## Compliance Certification Services (Kunshan) Inc. Shenzhen Branch

SZCCS-TRF-01 Rev. A/0 Aug01,2022

Report No.: FYCR221200049005

Page: 61 of 115

### Radar Type 5 - Trial 5

Trial List										
	Trial Id	Radar Type	Number of Bursts	Burst Period (s)	Waveform Length (s)	Center Frequency (GHz)				
Download	0	Type 5	15	0.8000000	12.0000000	5.500000000				
Download	1	Type 5	8	1.5000000	12.0000000	5.500000000				
Download	2	Type 5	11	1.0909091	12.0000000	5.500000000				
Download	3	Type 5	20	0.6000000	12.0000000	5.500000000				
Download	4	Type 5	17	0.7058824	12.0000000	5.500000000				
Download	5	Type 5	14	0.8571429	12.0000000	5.500000000				
		<b>Burst ID</b>	<b>Burst Offset (us)</b>	<b>Pulse Width (us)</b>	<b>Chirp Width (MHz)</b>	<b>Number of Pulses per Burst</b>	<b>PRI-1 (us)</b>	<b>PRI-2 (us)</b>	<b>PRI-3 (us)</b>	
		0	15438.0	92.9	12	3	1085.0	1564.0	1407.0	
		1	222486.0	67.7	12	2	1744.0	1747.0	-	
		2	430731.0	65.8	12	1	1092.0	-	-	
		3	637784.0	56.3	12	1	1851.0	-	-	
		4	845342.0	53.7	12	1	1727.0	-	-	
		5	196720.0	83.5	12	3	1679.0	1930.0	1025.0	
		6	404955.0	65.8	12	1	1519.0	-	-	
		7	610711.0	85.9	12	3	1134.0	1034.0	1808.0	
		8	818057.0	76.3	12	2	1606.0	1926.0	-	
		9	171459.0	81.5	12	2	1891.0	1714.0	-	
		10	377969.0	89.4	12	3	1310.0	1594.0	1827.0	
		11	586875.0	63.4	12	1	1568.0	-	-	
		12	792834.0	69.6	12	2	1307.0	1925.0	-	
		13	146044.0	74.5	12	2	1264.0	1846.0	-	
Download	6	Type 5	15	0.8000000	12.0000000	5.500000000				
Download	7	Type 5	12	1.0000000	12.0000000	5.500000000				
Download	8	Type 5	14	0.8571429	12.0000000	5.500000000				
Download	9	Type 5	8	1.5000000	12.0000000	5.500000000				
Download	10	Type 5	17	0.7058824	12.0000000	5.503900000				
Download	11	Type 5	19	0.6315789	12.0000000	5.505100000				
Download	12	Type 5	15	0.8000000	12.0000000	5.502700000				
Download	13	Type 5	12	1.0000000	12.0000000	5.501500000				
Download	14	Type 5	19	0.6315789	12.0000000	5.504700000				
Download	15	Type 5	14	0.8571429	12.0000000	5.502300000				



Unless otherwise agreed in writing, this document is issued by the Company subject to its General Conditions of Service printed overleaf, available on request or accessible at <http://www.sgs.com/en/Terms-and-Conditions.aspx> and, for electronic format documents, subject to Terms and Conditions for Electronic Documents at <http://www.sgs.com/en/Terms-and-Conditions/Terms-e-Documents.aspx>. Attention is drawn to the limitation of liability, indemnification and jurisdiction issues defined therein. Any holder of this document is advised that information contained hereon reflects the Company's findings at the time of its intervention only and within the limits of Client's instructions, if any. The Company's sole responsibility is to its Client and this document does not exonerate parties to a transaction from exercising all their rights and obligations under the transaction documents. This document cannot be reproduced except in full, without prior written approval of the Company. Any unauthorized alteration, forgery or falsification of the content or appearance of this document is unlawful and offenders may be prosecuted to the fullest extent of the law. Unless otherwise stated the results shown in this test report refer only to the sample(s) tested and such sample(s) are retained for 30 days only. Attention: To check the authenticity of testing/inspection report & certificate, please contact us at telephone: (86-755) 8307 1443, or email: CN.Doccheck@sgs.com

Compliance Certification Services (Kunshan) Inc. Shenzhen Branch

Fuyong Lab, Xinlong TechnoPark, Fengtang Road, Fuyong Subdistrict, Bao'an, Shenzhen, China 518103 t (86-755) 88663988 f (86-755) 26710594 www.sgs.com.cn  
 中国·深圳·宝安区福永街道凤塘大道鑫龙科技园福永实验室 邮编: 518103 t (86-755) 88663988 f (86-755) 26710594 sgs.china@sgs.com

## Compliance Certification Services (Kunshan) Inc. Shenzhen Branch

SZCCS-TRF-01 Rev. A/0 Aug01,2022

Report No.: FYCR221200049005

Page: 62 of 115

### Radar Type 5 - Trial 6

Trial List										
	Trial Id	Radar Type	Number of Bursts	Burst Period (s)	Waveform Length (s)	Center Frequency (GHz)				
<input type="checkbox"/>	Download	0	Type 5	15	0.8000000	12.0000000	5.500000000			
<input type="checkbox"/>	Download	1	Type 5	8	1.5000000	12.0000000	5.500000000			
<input type="checkbox"/>	Download	2	Type 5	11	1.0909091	12.0000000	5.500000000			
<input type="checkbox"/>	Download	3	Type 5	20	0.6000000	12.0000000	5.500000000			
<input type="checkbox"/>	Download	4	Type 5	17	0.7058824	12.0000000	5.500000000			
<input type="checkbox"/>	Download	5	Type 5	14	0.8571429	12.0000000	5.500000000			
<input type="checkbox"/>	Download	6	Type 5	15	0.8000000	12.0000000	5.500000000			
		Burst ID	Burst Offset (us)	Pulse Width (us)	Chirp Width (MHz)	Number of Pulses per Burst	PRI-1 (us)	PRI-2 (us)	PRI-3 (us)	
		0	329022.0	96.6	13	3	1182.0	1609.0	1581.0	
		1	521718.0	96.7	13	3	1829.0	1799.0	1154.0	
		2	714222.0	86.5	13	3	1923.0	1396.0	1865.0	
		3	112450.0	73.3	13	2	1908.0	1318.0	-	
		4	306283.0	55.8	13	1	1688.0	-	-	
		5	500239.0	55.4	13	1	1145.0	-	-	
		6	690932.0	85.3	13	3	1336.0	1504.0	1820.0	
		7	88645.0	79.4	13	2	1344.0	1893.0	-	
		8	282508.0	65.7	13	1	1476.0	-	-	
		9	475842.0	68.6	13	2	1008.0	1028.0	-	
		10	667887.0	77.7	13	2	1972.0	1835.0	-	
		11	64845.0	79.6	13	2	1882.0	1331.0	-	
		12	257755.0	94.9	13	3	1830.0	1070.0	1349.0	
		13	452335.0	61.4	13	1	1451.0	-	-	
		14	643395.0	90.6	13	3	1233.0	1562.0	1887.0	
<input type="checkbox"/>	Download	7	Type 5	12	1.0000000	12.0000000	5.500000000			
<input type="checkbox"/>	Download	8	Type 5	14	0.8571429	12.0000000	5.500000000			
<input type="checkbox"/>	Download	9	Type 5	8	1.5000000	12.0000000	5.500000000			
<input type="checkbox"/>	Download	10	Type 5	17	0.7058824	12.0000000	5.503900000			
<input type="checkbox"/>	Download	11	Type 5	19	0.6315789	12.0000000	5.505100000			
<input type="checkbox"/>	Download	12	Type 5	15	0.8000000	12.0000000	5.502700000			
<input type="checkbox"/>	Download	13	Type 5	12	1.0000000	12.0000000	5.501500000			
<input type="checkbox"/>	Download	14	Type 5	19	0.6315789	12.0000000	5.504700000			



Unless otherwise agreed in writing, this document is issued by the Company subject to its General Conditions of Service printed overleaf, available on request or accessible at <http://www.sgs.com/en/Terms-and-Conditions.aspx> and, for electronic format documents, subject to Terms and Conditions for Electronic Documents at <http://www.sgs.com/en/Terms-and-Conditions/Terms-e-Documents.aspx>. Attention is drawn to the limitation of liability, indemnification and jurisdiction issues defined therein. Any holder of this document is advised that information contained hereon reflects the Company's findings at the time of its intervention only and within the limits of Client's instructions, if any. The Company's sole responsibility is to its Client and this document does not exonerate parties to a transaction from exercising all their rights and obligations under the transaction documents. This document cannot be reproduced except in full, without prior written approval of the Company. Any unauthorized alteration, forgery or falsification of the content or appearance of this document is unlawful and offenders may be prosecuted to the fullest extent of the law. Unless otherwise stated the results shown in this test report refer only to the sample(s) tested and such sample(s) are retained for 30 days only.  
**Attention: To check the authenticity of testing/inspection report & certificate, please contact us at telephone: (86-755) 8307 1443, or email: CN.Doccheck@sgs.com**

Fuyong lab, Xinlong TechnoPark, Fengtang Road, Fuyong Subdistrict, Bao'an, Shenzhen, China 518103 t (86-755) 88663988 f (86-755) 26710594 www.sgs.com.cn  
 中国·深圳·宝安区福永街道凤塘大道鑫龙科技园福永实验室 邮编: 518103 t (86-755) 88663988 f (86-755) 26710594 sgs.china@sgs.com

## Compliance Certification Services (Kunshan) Inc. Shenzhen Branch

SZCCS-TRF-01 Rev. A/0 Aug01,2022

Report No.: FYCR221200049005

Page: 63 of 115

### Radar Type 5 - Trial 7

Trial List										
	Trial Id	Radar Type	Number of Bursts	Burst Period (s)	Waveform Length (s)	Center Frequency (GHz)				
Download	0	Type 5	15	0.8000000	12.0000000	5.500000000				
Download	1	Type 5	8	1.5000000	12.0000000	5.500000000				
Download	2	Type 5	11	1.0909091	12.0000000	5.500000000				
Download	3	Type 5	20	0.6000000	12.0000000	5.500000000				
Download	4	Type 5	17	0.7058824	12.0000000	5.500000000				
Download	5	Type 5	14	0.8571429	12.0000000	5.500000000				
Download	6	Type 5	15	0.8000000	12.0000000	5.500000000				
Download	7	Type 5	12	1.0000000	12.0000000	5.500000000				
		Burst ID	Burst Offset (us)	Pulse Width (us)	Chirp Width (MHz)	Number of Pulses per Burst	PRI-1 (us)	PRI-2 (us)	PRI-3 (us)	
		0	51446.0	52.6	10	1	1210.0	-	-	
		1	292696.0	84.1	10	3	1314.0	1725.0	1529.0	
		2	533989.0	97.7	10	3	1139.0	1868.0	1805.0	
		3	775564.0	97.3	10	3	1341.0	1446.0	1755.0	
		4	21542.0	98.8	10	3	1544.0	1386.0	1302.0	
		5	263385.0	72.2	10	2	1771.0	1184.0	-	
		6	505581.0	67.6	10	2	1175.0	1027.0	-	
		7	747058.0	75.7	10	2	1026.0	1871.0	-	
		8	989976.0	60.9	10	1	1798.0	-	-	
		9	234024.0	64.2	10	1	1138.0	-	-	
		10	475207.0	78.8	10	2	1784.0	1604.0	-	
		11	715825.0	87.5	10	3	1511.0	1712.0	1683.0	
Download	8	Type 5	14	0.8571429	12.0000000	5.500000000				
Download	9	Type 5	8	1.5000000	12.0000000	5.500000000				
Download	10	Type 5	17	0.7058824	12.0000000	5.503900000				
Download	11	Type 5	19	0.6315789	12.0000000	5.505100000				
Download	12	Type 5	15	0.8000000	12.0000000	5.502700000				
Download	13	Type 5	12	1.0000000	12.0000000	5.501500000				
Download	14	Type 5	19	0.6315789	12.0000000	5.504700000				
Download	15	Type 5	14	0.8571429	12.0000000	5.502300000				
Download	16	Type 5	20	0.6000000	12.0000000	5.505500000				
Download	17	Type 5	12	1.0000000	12.0000000	5.501500000				



Unless otherwise agreed in writing, this document is issued by the Company subject to its General Conditions of Service printed overleaf, available on request or accessible at <http://www.sgs.com/en/Terms-and-Conditions.aspx> and, for electronic format documents, subject to Terms and Conditions for Electronic Documents at <http://www.sgs.com/en/Terms-and-Conditions/Terms-e-Documents.aspx>. Attention is drawn to the limitation of liability, indemnification and jurisdiction issues defined therein. Any holder of this document is advised that information contained hereon reflects the Company's findings at the time of its intervention only and within the limits of Client's instructions, if any. The Company's sole responsibility is to its Client and this document does not exonerate parties to a transaction from exercising all their rights and obligations under the transaction documents. This document cannot be reproduced except in full, without prior written approval of the Company. Any unauthorized alteration, forgery or falsification of the content or appearance of this document is unlawful and offenders may be prosecuted to the fullest extent of the law. Unless otherwise stated the results shown in this test report refer only to the sample(s) tested and such sample(s) are retained for 30 days only. Attention: To check the authenticity of testing/inspection report & certificate, please contact us at telephone: (86-755) 8307 1443, or email: CN.Doccheck@sgs.com

Fuyong lab, Xinlong TechnoPark, Fengtang Road, Fuyong Subdistrict, Bao'an, Shenzhen, China 518103 t (86-755) 88663988 f (86-755) 26710594 www.sgs.com.cn  
 中国·深圳·宝安区福永街道凤塘大道鑫龙科技园福永实验室 邮编: 518103 t (86-755) 88663988 f (86-755) 26710594 sgs.china@sgs.com

## Compliance Certification Services (Kunshan) Inc. Shenzhen Branch

SZCCS-TRF-01 Rev. A/0 Aug01,2022

Report No.: FYCR221200049005

Page: 64 of 115

### Radar Type 5 - Trial 8

Trial List										
	Trial Id	Radar Type	Number of Bursts	Burst Period (s)	Waveform Length (s)	Center Frequency (GHz)				
Download	0	Type 5	15	0.8000000	12.0000000	5.500000000				
Download	1	Type 5	8	1.5000000	12.0000000	5.500000000				
Download	2	Type 5	11	1.0909091	12.0000000	5.500000000				
Download	3	Type 5	20	0.6000000	12.0000000	5.500000000				
Download	4	Type 5	17	0.7058824	12.0000000	5.500000000				
Download	5	Type 5	14	0.8571429	12.0000000	5.500000000				
Download	6	Type 5	15	0.8000000	12.0000000	5.500000000				
Download	7	Type 5	12	1.0000000	12.0000000	5.500000000				
Download	8	Type 5	14	0.8571429	12.0000000	5.500000000				
		Burst ID	Burst Offset (us)	Pulse Width (us)	Chirp Width (MHz)	Number of Pulses per Burst	PRI-1 (us)	PRI-2 (us)	PRI-3 (us)	
		0	823112.0	54.1	13	1	1415.0	-	-	
		1	174965.0	50.7	13	1	1221.0	-	-	
		2	382216.0	52.3	13	1	1974.0	-	-	
		3	587395.0	99.8	13	3	1558.0	1696.0	1949.0	
		4	796897.0	68.4	13	2	1014.0	1099.0	-	
		5	149042.0	80.8	13	2	1736.0	1505.0	-	
		6	356750.0	62.5	13	1	1778.0	-	-	
		7	563824.0	74.8	13	2	1149.0	1204.0	-	
		8	772314.0	50.8	13	1	1049.0	-	-	
		9	123796.0	54.0	13	1	1417.0	-	-	
		10	331215.0	63.0	13	1	1730.0	-	-	
		11	537402.0	91.8	13	3	1143.0	1270.0	1347.0	
		12	744805.0	79.3	13	2	1274.0	1992.0	-	
		13	98172.0	64.3	13	1	1937.0	-	-	
Download	9	Type 5	8	1.5000000	12.0000000	5.500000000				
Download	10	Type 5	17	0.7058824	12.0000000	5.503900000				
Download	11	Type 5	19	0.6315789	12.0000000	5.505100000				
Download	12	Type 5	15	0.8000000	12.0000000	5.502700000				
Download	13	Type 5	12	1.0000000	12.0000000	5.501500000				
Download	14	Type 5	19	0.6315789	12.0000000	5.504700000				
Download	15	Type 5	14	0.8571429	12.0000000	5.502300000				



Unless otherwise agreed in writing, this document is issued by the Company subject to its General Conditions of Service printed overleaf, available on request or accessible at <http://www.sgs.com/en/Terms-and-Conditions.aspx> and, for electronic format documents, subject to Terms and Conditions for Electronic Documents at <http://www.sgs.com/en/Terms-and-Conditions/Terms-e-Documents.aspx>. Attention is drawn to the limitation of liability, indemnification and jurisdiction issues defined therein. Any holder of this document is advised that information contained hereon reflects the Company's findings at the time of its intervention only and within the limits of Client's instructions, if any. The Company's sole responsibility is to its Client and this document does not exonerate parties to a transaction from exercising all their rights and obligations under the transaction documents. This document cannot be reproduced except in full, without prior written approval of the Company. Any unauthorized alteration, forgery or falsification of the content or appearance of this document is unlawful and offenders may be prosecuted to the fullest extent of the law. Unless otherwise stated the results shown in this test report refer only to the sample(s) tested and such sample(s) are retained for 30 days only. Attention: To check the authenticity of testing/inspection report & certificate, please contact us at telephone: (86-755) 8307 1443, or email: CN.Doccheck@sgs.com

Compliance Certification Services (Kunshan) Inc. Shenzhen Branch

Fuyong lab, Xinlong TechnoPark, Fengtang Road, Fuyong Subdistrict, Bao'an, Shenzhen, China 518103 t (86-755) 88663988 f (86-755) 26710594 www.sgs.com.cn  
 中国·深圳·宝安区福永街道凤塘大道鑫龙科技园福永实验室 邮编: 518103 t (86-755) 88663988 f (86-755) 26710594 sgs.china@sgs.com



## Compliance Certification Services (Kunshan) Inc. Shenzhen Branch

SZCCS-TRF-01 Rev. A/0 Aug01,2022

Report No.: FYCR221200049005

Page: 65 of 115

### Radar Type 5 - Trial 9

Trial List										
	Trial Id	Radar Type	Number of Bursts	Burst Period (s)	Waveform Length (s)	Center Frequency (GHz)				
Download	0	Type 5	15	0.8000000	12.0000000	5.500000000				
Download	1	Type 5	8	1.5000000	12.0000000	5.500000000				
Download	2	Type 5	11	1.0909091	12.0000000	5.500000000				
Download	3	Type 5	20	0.6000000	12.0000000	5.500000000				
Download	4	Type 5	17	0.7058824	12.0000000	5.500000000				
Download	5	Type 5	14	0.8571429	12.0000000	5.500000000				
Download	6	Type 5	15	0.8000000	12.0000000	5.500000000				
Download	7	Type 5	12	1.0000000	12.0000000	5.500000000				
Download	8	Type 5	14	0.8571429	12.0000000	5.500000000				
Download	9	Type 5	8	1.5000000	12.0000000	5.500000000				
		Burst ID	Burst Offset (us)	Pulse Width (us)	Chirp Width (MHz)	Number of Pulses per Burst	PRI-1 (us)	PRI-2 (us)	PRI-3 (us)	
		0	535615.0	63.4	6	1	1043.0	-	-	
		1	898668.0	52.0	6	1	1863.0	-	-	
		2	1259235.0	97.2	6	3	1973.0	1605.0	1583.0	
		3	127106.0	78.7	6	2	1466.0	1743.0	-	
		4	490358.0	74.2	6	2	1280.0	1219.0	-	
		5	852409.0	88.7	6	3	1293.0	1934.0	1273.0	
		6	1217152.0	54.3	6	1	1991.0	-	-	
		7	82296.0	95.4	6	3	1580.0	1555.0	1791.0	
Download	10	Type 5	17	0.7058824	12.0000000	5.503900000				
Download	11	Type 5	19	0.6315789	12.0000000	5.505100000				
Download	12	Type 5	15	0.8000000	12.0000000	5.502700000				
Download	13	Type 5	12	1.0000000	12.0000000	5.501500000				
Download	14	Type 5	19	0.6315789	12.0000000	5.504700000				
Download	15	Type 5	14	0.8571429	12.0000000	5.502300000				
Download	16	Type 5	20	0.6000000	12.0000000	5.505500000				
Download	17	Type 5	12	1.0000000	12.0000000	5.501500000				
Download	18	Type 5	14	0.8571429	12.0000000	5.502300000				
Download	19	Type 5	12	1.0000000	12.0000000	5.501500000				
Download	20	Type 5	16	0.7500000	12.0000000	5.496500000				



Unless otherwise agreed in writing, this document is issued by the Company subject to its General Conditions of Service printed overleaf, available on request or accessible at <http://www.sgs.com/en/Terms-and-Conditions.aspx> and, for electronic format documents, subject to Terms and Conditions for Electronic Documents at <http://www.sgs.com/en/Terms-and-Conditions/Terms-e-Documents.aspx>. Attention is drawn to the limitation of liability, indemnification and jurisdiction issues defined therein. Any holder of this document is advised that information contained hereon reflects the Company's findings at the time of its intervention only and within the limits of Client's instructions, if any. The Company's sole responsibility is to its Client and this document does not exonerate parties to a transaction from exercising all their rights and obligations under the transaction documents. This document cannot be reproduced except in full, without prior written approval of the Company. Any unauthorized alteration, forgery or falsification of the content or appearance of this document is unlawful and offenders may be prosecuted to the fullest extent of the law. Unless otherwise stated the results shown in this test report refer only to the sample(s) tested and such sample(s) are retained for 30 days only.  
**Attention: To check the authenticity of testing/inspection report & certificate, please contact us at telephone: (86-755) 8307 1443, or email: CN.Doccheck@sgs.com**

Compliance Certification Services (Kunshan) Inc. Shenzhen Branch

Fuyong lab, Xinlong TechnoPark, Fengtang Road, Fuyong Subdistrict, Bao'an, Shenzhen, China 518103 t (86-755) 88663988 f (86-755) 26710594 www.sgs.com.cn  
 中国·深圳·宝安区福永街道凤塘大道鑫龙科技园福永实验室 邮编: 518103 t (86-755) 88663988 f (86-755) 26710594 sgs.china@sgs.com

## Compliance Certification Services (Kunshan) Inc. Shenzhen Branch

SZCCS-TRF-01 Rev. A/0 Aug01,2022

Report No.: FYCR221200049005

Page: 66 of 115

### Radar Type 5 - Trial 10

Trial List										
	Trial Id	Radar Type	Number of Bursts	Burst Period (s)	Waveform Length (s)	Center Frequency (GHz)				
Download	0	Type 5	15	0.8000000	12.0000000	5.500000000				
Download	1	Type 5	8	1.5000000	12.0000000	5.500000000				
Download	2	Type 5	11	1.0909091	12.0000000	5.500000000				
Download	3	Type 5	20	0.6000000	12.0000000	5.500000000				
Download	4	Type 5	17	0.7058824	12.0000000	5.500000000				
Download	5	Type 5	14	0.8571429	12.0000000	5.500000000				
Download	6	Type 5	15	0.8000000	12.0000000	5.500000000				
Download	7	Type 5	12	1.0000000	12.0000000	5.500000000				
Download	8	Type 5	14	0.8571429	12.0000000	5.500000000				
Download	9	Type 5	8	1.5000000	12.0000000	5.500000000				
Download	10	Type 5	17	0.7058824	12.0000000	5.503900000				
		Burst ID	Burst Offset (us)	Pulse Width (us)	Chirp Width (MHz)	Number of Pulses per Burst	PRI-1 (us)	PRI-2 (us)	PRI-3 (us)	
		0	209249.0	73.7	16	2	1208.0	1497.0	-	
		1	378386.0	97.4	16	3	1942.0	1754.0	1613.0	
		2	548411.0	91.7	16	3	1999.0	1702.0	1462.0	
		3	17733.0	66.2	16	1	1393.0	-	-	
		4	187952.0	70.8	16	2	1968.0	1821.0	-	
		5	359277.0	52.3	16	1	1740.0	-	-	
		6	528886.0	78.9	16	2	1308.0	1984.0	-	
		7	700166.0	70.9	16	2	1050.0	1358.0	-	
		8	167197.0	75.6	16	2	1437.0	1430.0	-	
		9	338262.0	59.1	16	1	1697.0	-	-	
		10	508324.0	77.0	16	2	1397.0	1304.0	-	
		11	678689.0	67.9	16	2	1803.0	1083.0	-	
		12	146031.0	81.2	16	2	1720.0	1932.0	-	
		13	316923.0	78.7	16	2	1247.0	1121.0	-	
		14	488056.0	63.3	16	1	1634.0	-	-	
		15	657326.0	68.9	16	2	1849.0	1423.0	-	
		16	125509.0	59.3	16	1	1093.0	-	-	
Download	11	Type 5	19	0.6315789	12.0000000	5.505100000				
Download	12	Type 5	15	0.8000000	12.0000000	5.502700000				
Download	13	Type 5	12	1.0000000	12.0000000	5.501500000				



Unless otherwise agreed in writing, this document is issued by the Company subject to its General Conditions of Service printed overleaf, available on request or accessible at <http://www.sgs.com/en/Terms-and-Conditions.aspx> and, for electronic format documents, subject to Terms and Conditions for Electronic Documents at <http://www.sgs.com/en/Terms-and-Conditions/Terms-e-Documents.aspx>. Attention is drawn to the limitation of liability, indemnification and jurisdiction issues defined therein. Any holder of this document is advised that information contained hereon reflects the Company's findings at the time of its intervention only and within the limits of Client's instructions, if any. The Company's sole responsibility is to its Client and this document does not exonerate parties to a transaction from exercising all their rights and obligations under the transaction documents. This document cannot be reproduced except in full, without prior written approval of the Company. Any unauthorized alteration, forgery or falsification of the content or appearance of this document is unlawful and offenders may be prosecuted to the fullest extent of the law. Unless otherwise stated the results shown in this test report refer only to the sample(s) tested and such sample(s) are retained for 30 days only. Attention: To check the authenticity of testing/inspection report & certificate, please contact us at telephone: (86-755) 8307 1443, or email: CN.Doccheck@sgs.com

Fuyong lab, Xinlong TechnoPark, Fengtang Road, Fuyong Subdistrict, Bao'an, Shenzhen, China 518103 t (86-755) 88663988 f (86-755) 26710594 www.sgs.com.cn  
 中国·深圳·宝安区福永街道凤塘大道鑫龙科技园福永实验室 邮编: 518103 t (86-755) 88663988 f (86-755) 26710594 sgs.china@sgs.com

## Compliance Certification Services (Kunshan) Inc. Shenzhen Branch

SZCCS-TRF-01 Rev. A/0 Aug01,2022

Report No.: FYCR221200049005

Page: 67 of 115

### Radar Type 5 - Trial 11

Trial List										
	Trial Id	Radar Type	Number of Bursts	Burst Period (s)	Waveform Length (s)	Center Frequency (GHz)				
Download	11	Type 5	19	0.6315789	12.00000000	5.505100000				
		Burst ID	Burst Offset (us)	Pulse Width (us)	Chirp Width (MHz)	Number of Pulses per Burst	PRI-1 (us)	PRI-2 (us)	PRI-3 (us)	
		0	263736.0	98.9	19	3	1381.0	1680.0	1488.0	
		1	416459.0	82.3	19	2	1716.0	1855.0	-	
		2	567902.0	86.7	19	3	1211.0	1400.0	1919.0	
		3	92979.0	89.7	19	3	1861.0	1068.0	1282.0	
		4	245155.0	98.6	19	3	1507.0	1194.0	1461.0	
		5	397609.0	71.1	19	2	1921.0	1789.0	-	
		6	551431.0	55.9	19	1	1947.0	-	-	
		7	74413.0	67.9	19	2	1350.0	1372.0	-	
		8	226559.0	84.4	19	3	1203.0	1107.0	1443.0	
		9	380056.0	58.8	19	1	1715.0	-	-	
		10	533408.0	65.6	19	1	1017.0	-	-	
		11	55547.0	78.5	19	2	1911.0	1704.0	-	
		12	207876.0	82.3	19	2	1845.0	1686.0	-	
		13	359771.0	90.1	19	3	1938.0	1071.0	1266.0	
		14	511297.0	90.2	19	3	1989.0	1089.0	1950.0	
		15	36803.0	83.1	19	2	1943.0	1406.0	-	
		16	189652.0	58.8	19	1	1742.0	-	-	
		17	341809.0	77.0	19	2	1187.0	1657.0	-	
		18	495737.0	55.0	19	1	1012.0	-	-	
Download	12	Type 5	15	0.8000000	12.00000000	5.502700000				
Download	13	Type 5	12	1.0000000	12.00000000	5.501500000				
Download	14	Type 5	19	0.6315789	12.00000000	5.504700000				
Download	15	Type 5	14	0.8571429	12.00000000	5.502300000				
Download	16	Type 5	20	0.6000000	12.00000000	5.505500000				
Download	17	Type 5	12	1.0000000	12.00000000	5.501500000				
Download	18	Type 5	14	0.8571429	12.00000000	5.502300000				
Download	19	Type 5	12	1.0000000	12.00000000	5.501500000				
Download	20	Type 5	16	0.7500000	12.00000000	5.496500000				
Download	21	Type 5	12	1.0000000	12.00000000	5.498900000				



Unless otherwise agreed in writing, this document is issued by the Company subject to its General Conditions of Service printed overleaf, available on request or accessible at <http://www.sgs.com/en/Terms-and-Conditions.aspx> and, for electronic format documents, subject to Terms and Conditions for Electronic Documents at <http://www.sgs.com/en/Terms-and-Conditions/Terms-e-Documents.aspx>. Attention is drawn to the limitation of liability, indemnification and jurisdiction issues defined therein. Any holder of this document is advised that information contained hereon reflects the Company's findings at the time of its intervention only and within the limits of Client's instructions, if any. The Company's sole responsibility is to its Client and this document does not exonerate parties to a transaction from exercising all their rights and obligations under the transaction documents. This document cannot be reproduced except in full, without prior written approval of the Company. Any unauthorized alteration, forgery or falsification of the content or appearance of this document is unlawful and offenders may be prosecuted to the fullest extent of the law. Unless otherwise stated the results shown in this test report refer only to the sample(s) tested and such sample(s) are retained for 30 days only. Attention: To check the authenticity of testing/inspection report & certificate, please contact us at telephone: (86-755) 8307 1443, or email: CN.Doccheck@sgs.com

Fuyong Lab, Xinlong TechnoPark, Fengtang Road, Fuyong Subdistrict, Bao'an, Shenzhen, China 518103 t (86-755) 88663988 f (86-755) 26710594 www.sgs.com.cn  
 中国·深圳·宝安区福永街道凤塘大道鑫龙科技园福永实验室 邮编: 518103 t (86-755) 88663988 f (86-755) 26710594 sgs.china@sgs.com

## Compliance Certification Services (Kunshan) Inc. Shenzhen Branch

SZCCS-TRF-01 Rev. A/0 Aug01,2022

Report No.: FYCR221200049005

Page: 68 of 115

### Radar Type 5 - Trial 12

Trial List										
	Trial Id	Radar Type	Number of Bursts	Burst Period (s)	Waveform Length (s)	Center Frequency (GHz)				
Download	12	Type 5	15	0.8000000	12.0000000	5.502700000				
		Burst ID	Burst Offset (us)	Pulse Width (us)	Chirp Width (MHz)	Number of Pulses per Burst	PRI-1 (us)	PRI-2 (us)	PRI-3 (us)	
		0	22911.0	58.1	13	1	1929.0	-	-	
		1	216473.0	52.1	13	1	1910.0	-	-	
		2	410004.0	59.9	13	1	1971.0	-	-	
		3	603671.0	60.2	13	1	1812.0	-	-	
		4	794160.0	95.9	13	3	1399.0	1906.0	1608.0	
		5	192251.0	79.9	13	2	1626.0	1859.0	-	
		6	385590.0	78.5	13	2	1238.0	1917.0	-	
		7	579862.0	53.8	13	1	1763.0	-	-	
		8	773423.0	64.7	13	1	1800.0	-	-	
		9	168898.0	61.4	13	1	1390.0	-	-	
		10	361606.0	83.2	13	2	1692.0	1858.0	-	
		11	553866.0	84.7	13	3	1533.0	1677.0	1638.0	
		12	747241.0	88.7	13	3	1703.0	1528.0	1058.0	
		13	144710.0	78.3	13	2	1258.0	1951.0	-	
		14	337856.0	69.3	13	2	1731.0	1717.0	-	
Download	13	Type 5	12	1.0000000	12.0000000	5.501500000				
Download	14	Type 5	19	0.6315789	12.0000000	5.504700000				
Download	15	Type 5	14	0.8571429	12.0000000	5.502300000				
Download	16	Type 5	20	0.6000000	12.0000000	5.505500000				
Download	17	Type 5	12	1.0000000	12.0000000	5.501500000				
Download	18	Type 5	14	0.8571429	12.0000000	5.502300000				
Download	19	Type 5	12	1.0000000	12.0000000	5.501500000				
Download	20	Type 5	16	0.7500000	12.0000000	5.496500000				
Download	21	Type 5	12	1.0000000	12.0000000	5.498900000				
Download	22	Type 5	20	0.6000000	12.0000000	5.494500000				
Download	23	Type 5	14	0.8571429	12.0000000	5.497700000				
Download	24	Type 5	13	0.9230769	12.0000000	5.498100000				
Download	25	Type 5	8	1.5000000	12.0000000	5.500500000				
Download	26	Type 5	17	0.7058824	12.0000000	5.496100000				



Unless otherwise agreed in writing, this document is issued by the Company subject to its General Conditions of Service printed overleaf, available on request or accessible at <http://www.sgs.com/en/Terms-and-Conditions.aspx> and, for electronic format documents, subject to Terms and Conditions for Electronic Documents at <http://www.sgs.com/en/Terms-and-Conditions/Terms-e-Document.aspx>. Attention is drawn to the limitation of liability, indemnification and jurisdiction issues defined therein. Any holder of this document is advised that information contained hereon reflects the Company's findings at the time of its intervention only and within the limits of Client's instructions, if any. The Company's sole responsibility is to its Client and this document does not exonerate parties to a transaction from exercising all their rights and obligations under the transaction documents. This document cannot be reproduced except in full, without prior written approval of the Company. Any unauthorized alteration, forgery or falsification of the content or appearance of this document is unlawful and offenders may be prosecuted to the fullest extent of the law. Unless otherwise stated the results shown in this test report refer only to the sample(s) tested and such sample(s) are retained for 30 days only. Attention: To check the authenticity of testing /inspection report & certificate, please contact us at telephone: (86-755) 8307 1443, or email: CN.Doccheck@sgs.com

Compliance Certification Services (Kunshan) Inc. Shenzhen Branch

Fuyong lab, Xinlong TechnoPark, Fengtang Road, Fuyong Subdistrict, Bao'an, Shenzhen, China 518103 t (86-755) 88663988 f (86-755) 26710594 www.sgs.com.cn  
 中国·深圳·宝安区福永街道凤塘大道鑫龙科技园福永实验室 邮编: 518103 t (86-755) 88663988 f (86-755) 26710594 sgs.china@sgs.com

## Compliance Certification Services (Kunshan) Inc. Shenzhen Branch

SZCCS-TRF-01 Rev. A/0 Aug01,2022

Report No.: FYCR221200049005

Page: 69 of 115

### Radar Type 5 - Trial 13

Trial List										
	Trial Id	Radar Type	Number of Bursts	Burst Period (s)	Waveform Length (s)	Center Frequency (GHz)				
<input type="checkbox"/>	Download	13	Type 5	12	1.0000000	12.0000000	5.501500000			
			Burst ID	Burst Offset (us)	Pulse Width (us)	Chirp Width (MHz)	Number of Pulses per Burst	PRI-1 (us)	PRI-2 (us)	PRI-3 (us)
			0	664275.0	75.3	10	2	1994.0	1612.0	-
			1	907886.0	56.3	10	1	1456.0	-	-
			2	151316.0	67.7	10	2	1617.0	1185.0	-
			3	393746.0	55.6	10	1	1337.0	-	-
			4	635093.0	75.2	10	2	1421.0	1267.0	-
			5	876993.0	76.3	10	2	1359.0	1305.0	-
			6	121278.0	85.7	10	3	1547.0	1362.0	1924.0
			7	362696.0	98.4	10	3	1873.0	1550.0	1249.0
			8	604342.0	86.4	10	3	1779.0	1439.0	1046.0
			9	846453.0	93.6	10	3	1059.0	1031.0	1452.0
			10	91871.0	63.3	10	1	1328.0	-	-
			11	333050.0	92.4	10	3	1412.0	1673.0	1322.0
<input type="checkbox"/>	Download	14	Type 5	19	0.6315789	12.0000000	5.504700000			
<input type="checkbox"/>	Download	15	Type 5	14	0.8571429	12.0000000	5.502300000			
<input type="checkbox"/>	Download	16	Type 5	20	0.6000000	12.0000000	5.505500000			
<input type="checkbox"/>	Download	17	Type 5	12	1.0000000	12.0000000	5.501500000			
<input type="checkbox"/>	Download	18	Type 5	14	0.8571429	12.0000000	5.502300000			
<input type="checkbox"/>	Download	19	Type 5	12	1.0000000	12.0000000	5.501500000			
<input type="checkbox"/>	Download	20	Type 5	16	0.7500000	12.0000000	5.496500000			
<input type="checkbox"/>	Download	21	Type 5	12	1.0000000	12.0000000	5.498900000			
<input type="checkbox"/>	Download	22	Type 5	20	0.6000000	12.0000000	5.494500000			
<input type="checkbox"/>	Download	23	Type 5	14	0.8571429	12.0000000	5.497700000			
<input type="checkbox"/>	Download	24	Type 5	13	0.9230769	12.0000000	5.498100000			
<input type="checkbox"/>	Download	25	Type 5	8	1.5000000	12.0000000	5.500500000			
<input type="checkbox"/>	Download	26	Type 5	17	0.7058824	12.0000000	5.496100000			
<input type="checkbox"/>	Download	27	Type 5	19	0.6315789	12.0000000	5.494900000			
<input type="checkbox"/>	Download	28	Type 5	12	1.0000000	12.0000000	5.498500000			
<input type="checkbox"/>	Download	29	Type 5	18	0.6666667	12.0000000	5.495700000			



Unless otherwise agreed in writing, this document is issued by the Company subject to its General Conditions of Service printed overleaf, available on request or accessible at <http://www.sgs.com/en/Terms-and-Conditions.aspx> and, for electronic format documents, subject to Terms and Conditions for Electronic Documents at <http://www.sgs.com/en/Terms-and-Conditions/Terms-e-Documents.aspx>. Attention is drawn to the limitation of liability, indemnification and jurisdiction issues defined therein. Any holder of this document is advised that information contained hereon reflects the Company's findings at the time of its intervention only and within the limits of Client's instructions, if any. The Company's sole responsibility is to its Client and this document does not exonerate parties to a transaction from exercising all their rights and obligations under the transaction documents. This document cannot be reproduced except in full, without prior written approval of the Company. Any unauthorized alteration, forgery or falsification of the content or appearance of this document is unlawful and offenders may be prosecuted to the fullest extent of the law. Unless otherwise stated the results shown in this test report refer only to the sample(s) tested and such sample(s) are retained for 30 days only. Attention: To check the authenticity of testing/inspection report & certificate, please contact us at telephone: (86-755) 8307 1443, or email: CN.Doccheck@sgs.com

Compliance Certification Services (Kunshan) Inc. Shenzhen Branch

Fuyong Lab, Xinlong TechnoPark, Fengtang Road, Fuyong Subdistrict, Bao'an, Shenzhen, China 518103 t (86-755) 88663988 f (86-755) 26710594 www.sgs.com.cn  
 中国·深圳·宝安区福永街道凤塘大道鑫龙科技园福永实验室 邮编: 518103 t (86-755) 88663988 f (86-755) 26710594 sgs.china@sgs.com

## Compliance Certification Services (Kunshan) Inc. Shenzhen Branch

SZCCS-TRF-01 Rev. A/0 Aug01,2022

Report No.: FYCR221200049005

Page: 70 of 115

### Radar Type 5 - Trial 14

Trial List										
	Trial Id	Radar Type	Number of Bursts	Burst Period (s)	Waveform Length (s)	Center Frequency (GHz)				
<input type="checkbox"/>	Download	14	Type 5	19	0.6315789	12.00000000	5.504700000			
			Burst ID	Burst Offset (us)	Pulse Width (us)	Chirp Width (MHz)	Number of Pulses per Burst	PRI-1 (us)	PRI-2 (us)	PRI-3 (us)
			0	361323.0	93.3	18	3	1983.0	1912.0	1535.0
			1	515261.0	69.1	18	2	1102.0	1794.0	-
			2	39025.0	86.9	18	3	1044.0	1152.0	1148.0
			3	190900.0	84.9	18	3	1894.0	1948.0	1118.0
			4	343941.0	72.3	18	2	1094.0	1916.0	-
			5	497624.0	51.7	18	1	1447.0	-	-
			6	20319.0	58.3	18	1	1429.0	-	-
			7	172999.0	60.8	18	1	1979.0	-	-
			8	325872.0	57.1	18	1	1641.0	-	-
			9	475841.0	88.9	18	3	1886.0	1964.0	1489.0
			10	1489.0	72.0	18	2	1909.0	1297.0	-
			11	153647.0	90.9	18	3	1261.0	1566.0	1370.0
			12	307096.0	59.8	18	1	1552.0	-	-
			13	458804.0	70.0	18	2	1759.0	1291.0	-
			14	610798.0	67.2	18	2	1625.0	1861.0	-
			15	134759.0	91.2	18	3	1382.0	1832.0	1661.0
			16	288306.0	56.5	18	1	1483.0	-	-
			17	441296.0	51.2	18	1	1237.0	-	-
			18	592780.0	74.1	18	2	1471.0	1245.0	-
<input type="checkbox"/>	Download	15	Type 5	14	0.8571429	12.00000000	5.502300000			
<input type="checkbox"/>	Download	16	Type 5	20	0.60000000	12.00000000	5.505500000			
<input type="checkbox"/>	Download	17	Type 5	12	1.00000000	12.00000000	5.501500000			
<input type="checkbox"/>	Download	18	Type 5	14	0.8571429	12.00000000	5.502300000			
<input type="checkbox"/>	Download	19	Type 5	12	1.00000000	12.00000000	5.501500000			
<input type="checkbox"/>	Download	20	Type 5	16	0.75000000	12.00000000	5.496500000			
<input type="checkbox"/>	Download	21	Type 5	12	1.00000000	12.00000000	5.498900000			
<input type="checkbox"/>	Download	22	Type 5	20	0.60000000	12.00000000	5.494500000			
<input type="checkbox"/>	Download	23	Type 5	14	0.8571429	12.00000000	5.497700000			
<input type="checkbox"/>	Download	24	Type 5	13	0.9230769	12.00000000	5.498100000			



Unless otherwise agreed in writing, this document is issued by the Company subject to its General Conditions of Service printed overleaf, available on request or accessible at <http://www.sgs.com/en/Terms-and-Conditions.aspx> and, for electronic format documents, subject to Terms and Conditions for Electronic Documents at <http://www.sgs.com/en/Terms-and-Conditions/Terms-e-Documents.aspx>. Attention is drawn to the limitation of liability, indemnification and jurisdiction issues defined therein. Any holder of this document is advised that information contained hereon reflects the Company's findings at the time of its intervention only and within the limits of Client's instructions, if any. The Company's sole responsibility is to its Client and this document does not exonerate parties to a transaction from exercising all their rights and obligations under the transaction documents. This document cannot be reproduced except in full, without prior written approval of the Company. Any unauthorized alteration, forgery or falsification of the content or appearance of this document is unlawful and offenders may be prosecuted to the fullest extent of the law. Unless otherwise stated the results shown in this test report refer only to the sample(s) tested and such sample(s) are retained for 30 days only. Attention: To check the authenticity of testing /inspection report & certificate, please contact us at telephone: (86-755) 8307 1443, or email: CN.Doccheck@sgs.com

Compliance Certification Services (Kunshan) Inc. Shenzhen Branch

Fuyong lab, Xinlong TechnoPark, Fengtang Road, Fuyong Subdistrict, Bao'an, Shenzhen, China 518103 t (86-755) 88663988 f (86-755) 26710594 www.sgs.com.cn  
 中国·深圳·宝安区福永街道凤塘大道鑫龙科技园福永实验室 邮编: 518103 t (86-755) 88663988 f (86-755) 26710594 sgs.china@sgs.com

## Compliance Certification Services (Kunshan) Inc. Shenzhen Branch

SZCCS-TRF-01 Rev. A/0 Aug01,2022

Report No.: FYCR221200049005

Page: 71 of 115

### Radar Type 5 - Trial 15

Trial List										
	Trial Id	Radar Type	Number of Bursts	Burst Period (s)	Waveform Length (s)	Center Frequency (GHz)				
<input type="checkbox"/>	Download	15	Type 5	14	0.8571429	12.0000000	5.502300000			
			Burst ID	Burst Offset (us)	Pulse Width (us)	Chirp Width (MHz)	Number of Pulses per Burst	PRI-1 (us)	PRI-2 (us)	PRI-3 (us)
			0	158286.0	76.9	12	2	1110.0	1140.0	-
			1	366024.0	50.2	12	1	1316.0	-	-
			2	573452.0	62.9	12	1	1520.0	-	-
			3	780619.0	64.7	12	1	1902.0	-	-
			4	132455.0	83.8	12	3	1410.0	1097.0	1621.0
			5	340207.0	65.4	12	1	1944.0	-	-
			6	548208.0	53.2	12	1	1024.0	-	-
			7	755333.0	51.7	12	1	1603.0	-	-
			8	107117.0	78.7	12	2	1804.0	1168.0	-
			9	314500.0	72.4	12	2	1030.0	1343.0	-
			10	522447.0	53.8	12	1	1327.0	-	-
			11	728517.0	73.6	12	2	1524.0	1553.0	-
			12	81611.0	66.7	12	2	1722.0	1122.0	-
			13	288948.0	82.5	12	2	1404.0	1019.0	-
<input type="checkbox"/>	Download	16	Type 5	20	0.6000000	12.0000000	5.505500000			
<input type="checkbox"/>	Download	17	Type 5	12	1.0000000	12.0000000	5.501500000			
<input type="checkbox"/>	Download	18	Type 5	14	0.8571429	12.0000000	5.502300000			
<input type="checkbox"/>	Download	19	Type 5	12	1.0000000	12.0000000	5.501500000			
<input type="checkbox"/>	Download	20	Type 5	16	0.7500000	12.0000000	5.496500000			
<input type="checkbox"/>	Download	21	Type 5	12	1.0000000	12.0000000	5.498900000			
<input type="checkbox"/>	Download	22	Type 5	20	0.6000000	12.0000000	5.494500000			
<input type="checkbox"/>	Download	23	Type 5	14	0.8571429	12.0000000	5.497700000			
<input type="checkbox"/>	Download	24	Type 5	13	0.9230769	12.0000000	5.498100000			
<input type="checkbox"/>	Download	25	Type 5	8	1.5000000	12.0000000	5.500500000			
<input type="checkbox"/>	Download	26	Type 5	17	0.7058824	12.0000000	5.496100000			
<input type="checkbox"/>	Download	27	Type 5	19	0.6315789	12.0000000	5.494900000			
<input type="checkbox"/>	Download	28	Type 5	12	1.0000000	12.0000000	5.498500000			
<input type="checkbox"/>	Download	29	Type 5	18	0.6666667	12.0000000	5.495700000			



Unless otherwise agreed in writing, this document is issued by the Company subject to its General Conditions of Service printed overleaf, available on request or accessible at <http://www.sgs.com/en/Terms-and-Conditions.aspx> and, for electronic format documents, subject to Terms and Conditions for Electronic Documents at <http://www.sgs.com/en/Terms-and-Conditions/Terms-e-Documents.aspx>. Attention is drawn to the limitation of liability, indemnification and jurisdiction issues defined therein. Any holder of this document is advised that information contained hereon reflects the Company's findings at the time of its intervention only and within the limits of Client's instructions, if any. The Company's sole responsibility is to its Client and this document does not exonerate parties to a transaction from exercising all their rights and obligations under the transaction documents. This document cannot be reproduced except in full, without prior written approval of the Company. Any unauthorized alteration, forgery or falsification of the content or appearance of this document is unlawful and offenders may be prosecuted to the fullest extent of the law. Unless otherwise stated the results shown in this test report refer only to the sample(s) tested and such sample(s) are retained for 30 days only. Attention: To check the authenticity of testing/inspection report & certificate, please contact us at telephone: (86-755) 8307 1443, or email: CN.Doccheck@sgs.com

Compliance Certification Services (Kunshan) Inc. Shenzhen Branch

Fuyong Lab, Xinlong TechnoPark, Fengtang Road, Fuyong Subdistrict, Bao'an, Shenzhen, China 518103 t (86-755) 88663988 f (86-755) 26710594 www.sgs.com.cn  
 中国·深圳·宝安区福永街道凤塘大道鑫龙科技园福永实验室 邮编: 518103 t (86-755) 88663988 f (86-755) 26710594 sgs.china@sgs.com

## Compliance Certification Services (Kunshan) Inc. Shenzhen Branch

SZCCS-TRF-01 Rev. A/0 Aug01,2022

Report No.: FYCR221200049005

Page: 72 of 115

### Radar Type 5 - Trial 16

Trial List										
	Trial Id	Radar Type	Number of Bursts	Burst Period (s)	Waveform Length (s)	Center Frequency (GHz)				
Download	16	Type 5	20	0.60000000	12.00000000	5.5055000000				
		Burst ID	Burst Offset (us)	Pulse Width (us)	Chirp Width (MHz)	Number of Pulses per Burst	PRI-1 (us)	PRI-2 (us)	PRI-3 (us)	
		0	345766.0	87.6	20	3	1565.0	1055.0	1840.0	
		1	490019.0	85.2	20	3	1735.0	1541.0	1408.0	
		2	39073.0	84.8	20	3	1534.0	1889.0	1463.0	
		3	183923.0	77.9	20	2	1749.0	1460.0	-	
		4	328777.0	76.5	20	2	1518.0	1485.0	-	
		5	474728.0	60.9	20	1	1540.0	-	-	
		6	21394.0	83.0	20	2	1080.0	1010.0	-	
		7	165992.0	80.4	20	2	1824.0	1752.0	-	
		8	310973.0	67.5	20	2	1764.0	1181.0	-	
		9	456884.0	62.1	20	1	1495.0	-	-	
		10	3515.0	86.4	20	3	1773.0	1966.0	1263.0	
		11	147928.0	84.3	20	3	1593.0	1188.0	1788.0	
		12	293225.0	76.9	20	2	1226.0	1537.0	-	
		13	436922.0	95.8	20	3	1192.0	1298.0	1844.0	
		14	584015.0	55.2	20	1	1644.0	-	-	
		15	130832.0	59.0	20	1	1402.0	-	-	
		16	274684.0	94.5	20	3	1296.0	1700.0	1283.0	
		17	418579.0	91.9	20	3	1970.0	1978.0	1165.0	
		18	563464.0	85.2	20	3	1732.0	1551.0	1189.0	
		19	112787.0	69.5	20	2	1038.0	1224.0	-	
Download	17	Type 5	12	1.00000000	12.00000000	5.5015000000				
Download	18	Type 5	14	0.8571429	12.00000000	5.5023000000				
Download	19	Type 5	12	1.00000000	12.00000000	5.5015000000				
Download	20	Type 5	16	0.75000000	12.00000000	5.4965000000				
Download	21	Type 5	12	1.00000000	12.00000000	5.4989000000				
Download	22	Type 5	20	0.60000000	12.00000000	5.4945000000				



Unless otherwise agreed in writing, this document is issued by the Company subject to its General Conditions of Service printed overleaf, available on request or accessible at <http://www.sgs.com/en/Terms-and-Conditions.aspx> and, for electronic format documents, subject to Terms and Conditions for Electronic Documents at <http://www.sgs.com/en/Terms-and-Conditions/Terms-e-Documents.aspx>. Attention is drawn to the limitation of liability, indemnification and jurisdiction issues defined therein. Any holder of this document is advised that information contained hereon reflects the Company's findings at the time of its intervention only and within the limits of Client's instructions, if any. The Company's sole responsibility is to its Client and this document does not exonerate parties to a transaction from exercising all their rights and obligations under the transaction documents. This document cannot be reproduced except in full, without prior written approval of the Company. Any unauthorized alteration, forgery or falsification of the content or appearance of this document is unlawful and offenders may be prosecuted to the fullest extent of the law. Unless otherwise stated the results shown in this test report refer only to the sample(s) tested and such sample(s) are retained for 30 days only.  
**Attention: To check the authenticity of testing/inspection report & certificate, please contact us at telephone: (86-755) 8307 1443, or email: CN.Doccheck@sgs.com**

Compliance Certification Services (Kunshan) Inc. Shenzhen Branch

Fuyong Lab, Xinlong TechnoPark, Fengtang Road, Fuyong Subdistrict, Bao'an, Shenzhen, China 518103 t (86-755) 88663988 f (86-755) 26710594 www.sgs.com.cn  
 中国·深圳·宝安区福永街道凤塘大道鑫龙科技园福永实验室 邮编: 518103 t (86-755) 88663988 f (86-755) 26710594 sgs.china@sgs.com



## Compliance Certification Services (Kunshan) Inc. Shenzhen Branch

SZCCS-TRF-01 Rev. A/0 Aug01,2022

Report No.: FYCR221200049005

Page: 73 of 115

### Radar Type 5 - Trial 17

Trial List										
	Trial Id	Radar Type	Number of Bursts	Burst Period (s)	Waveform Length (s)	Center Frequency (GHz)				
Download	17	Type 5	12	1.0000000	12.0000000	5.501500000				
		Burst ID	Burst Offset (us)	Pulse Width (us)	Chirp Width (MHz)	Number of Pulses per Burst	PRI-1 (us)	PRI-2 (us)	PRI-3 (us)	
		0	429224.0	86.4	10	3	1259.0	1918.0	1455.0	
		1	670241.0	92.2	10	3	1598.0	1719.0	1895.0	
		2	912880.0	80.4	10	2	1816.0	1899.0	-	
		3	158603.0	54.3	10	1	1335.0	-	-	
		4	400824.0	53.1	10	1	1303.0	-	-	
		5	641915.0	69.4	10	2	1503.0	1546.0	-	
		6	883823.0	69.1	10	2	1279.0	1639.0	-	
		7	128373.0	100.0	10	3	1375.0	1438.0	1595.0	
		8	370379.0	79.6	10	2	1239.0	1705.0	-	
		9	611194.0	88.4	10	3	1374.0	1579.0	1623.0	
		10	855665.0	53.3	10	1	1016.0	-	-	
		11	98897.0	65.3	10	1	1709.0	-	-	
Download	18	Type 5	14	0.8571429	12.0000000	5.502300000				
Download	19	Type 5	12	1.0000000	12.0000000	5.501500000				
Download	20	Type 5	16	0.7500000	12.0000000	5.496500000				
Download	21	Type 5	12	1.0000000	12.0000000	5.498900000				
Download	22	Type 5	20	0.6000000	12.0000000	5.494500000				
Download	23	Type 5	14	0.8571429	12.0000000	5.497700000				
Download	24	Type 5	13	0.9230769	12.0000000	5.498100000				
Download	25	Type 5	8	1.5000000	12.0000000	5.500500000				
Download	26	Type 5	17	0.7058824	12.0000000	5.496100000				
Download	27	Type 5	19	0.6315789	12.0000000	5.494900000				
Download	28	Type 5	12	1.0000000	12.0000000	5.498500000				
Download	29	Type 5	18	0.6666667	12.0000000	5.495700000				



Unless otherwise agreed in writing, this document is issued by the Company subject to its General Conditions of Service printed overleaf, available on request or accessible at <http://www.sgs.com/en/Terms-and-Conditions.aspx> and, for electronic format documents, subject to Terms and Conditions for Electronic Documents at <http://www.sgs.com/en/Terms-and-Conditions/Terms-e-Documents.aspx>. Attention is drawn to the limitation of liability, indemnification and jurisdiction issues defined therein. Any holder of this document is advised that information contained hereon reflects the Company's findings at the time of its intervention only and within the limits of Client's instructions, if any. The Company's sole responsibility is to its Client and this document does not exonerate parties to a transaction from exercising all their rights and obligations under the transaction documents. This document cannot be reproduced except in full, without prior written approval of the Company. Any unauthorized alteration, forgery or falsification of the content or appearance of this document is unlawful and offenders may be prosecuted to the fullest extent of the law. Unless otherwise stated the results shown in this test report refer only to the sample(s) tested and such sample(s) are retained for 30 days only. Attention: To check the authenticity of testing/inspection report & certificate, please contact us at telephone: (86-755) 8307 1443, or email: CN.Doccheck@sgs.com

Compliance Certification Services (Kunshan) Inc. Shenzhen Branch

Fuyong Lab, Xinlong TechnoPark, Fengtang Road, Fuyong Subdistrict, Bao'an, Shenzhen, China 518103 t (86-755) 88663988 f (86-755) 26710594 www.sgs.com.cn  
 中国·深圳·宝安区福永街道凤塘大道鑫龙科技园福永实验室 邮编: 518103 t (86-755) 88663988 f (86-755) 26710594 sgs.china@sgs.com

## Compliance Certification Services (Kunshan) Inc. Shenzhen Branch

SZCCS-TRF-01 Rev. A/0 Aug01,2022

Report No.: FYCR221200049005

Page: 74 of 115

### Radar Type 5 - Trial 18

Trial List										
	Trial Id	Radar Type	Number of Bursts	Burst Period (s)	Waveform Length (s)	Center Frequency (GHz)				
Download	18	Type 5	14	0.8571429	12.00000000	5.502300000				
		Burst ID	Burst Offset (us)	Pulse Width (us)	Chirp Width (MHz)	Number of Pulses per Burst	PRI-1 (us)	PRI-2 (us)	PRI-3 (us)	
		0	292143.0	55.3	12	1	1920.0	-	-	
		1	499633.0	58.3	12	1	1797.0	-	-	
		2	706377.0	72.3	12	2	1610.0	1039.0	-	
		3	58989.0	84.8	12	3	1131.0	1761.0	1721.0	
		4	266161.0	82.5	12	2	1875.0	1431.0	-	
		5	474469.0	63.3	12	1	1095.0	-	-	
		6	680544.0	80.0	12	2	1119.0	1913.0	-	
		7	33519.0	90.3	12	3	1660.0	1853.0	1123.0	
		8	240319.0	91.1	12	3	1539.0	1783.0	1172.0	
		9	447400.0	96.6	12	3	1525.0	1036.0	1385.0	
		10	654516.0	82.7	12	2	1710.0	1990.0	-	
		11	8083.0	50.7	12	1	1234.0	-	-	
		12	215435.0	78.4	12	2	1047.0	1109.0	-	
		13	421325.0	99.5	12	3	1299.0	1965.0	1869.0	
Download	19	Type 5	12	1.0000000	12.00000000	5.501500000				
Download	20	Type 5	16	0.7500000	12.00000000	5.496500000				
Download	21	Type 5	12	1.0000000	12.00000000	5.498900000				
Download	22	Type 5	20	0.6000000	12.00000000	5.494500000				
Download	23	Type 5	14	0.8571429	12.00000000	5.497700000				
Download	24	Type 5	13	0.9230769	12.00000000	5.498100000				
Download	25	Type 5	8	1.5000000	12.00000000	5.500500000				
Download	26	Type 5	17	0.7058824	12.00000000	5.496100000				
Download	27	Type 5	19	0.6315789	12.00000000	5.494900000				
Download	28	Type 5	12	1.0000000	12.00000000	5.498500000				
Download	29	Type 5	18	0.6666667	12.00000000	5.495700000				



Unless otherwise agreed in writing, this document is issued by the Company subject to its General Conditions of Service printed overleaf, available on request or accessible at <http://www.sgs.com/en/Terms-and-Conditions.aspx> and, for electronic format documents, subject to Terms and Conditions for Electronic Documents at <http://www.sgs.com/en/Terms-and-Conditions/Terms-e-Documents.aspx>. Attention is drawn to the limitation of liability, indemnification and jurisdiction issues defined therein. Any holder of this document is advised that information contained hereon reflects the Company's findings at the time of its intervention only and within the limits of Client's instructions, if any. The Company's sole responsibility is to its Client and this document does not exonerate parties to a transaction from exercising all their rights and obligations under the transaction documents. This document cannot be reproduced except in full, without prior written approval of the Company. Any unauthorized alteration, forgery or falsification of the content or appearance of this document is unlawful and offenders may be prosecuted to the fullest extent of the law. Unless otherwise stated the results shown in this test report refer only to the sample(s) tested and such sample(s) are retained for 30 days only.  
**Attention: To check the authenticity of testing/inspection report & certificate, please contact us at telephone: (86-755) 8307 1443, or email: CN.Doccheck@sgs.com**

Compliance Certification Services (Kunshan) Inc. Shenzhen Branch

Fuyong Lab, Xinlong TechnoPark, Fengtang Road, Fuyong Subdistrict, Bao'an, Shenzhen, China 518103 t (86-755) 88663988 f (86-755) 26710594 www.sgs.com.cn  
 中国·深圳·宝安区福永街道凤塘大道鑫龙科技园福永实验室 邮编: 518103 t (86-755) 88663988 f (86-755) 26710594 sgs.china@sgs.com

## Compliance Certification Services (Kunshan) Inc. Shenzhen Branch

SZCCS-TRF-01 Rev. A/0 Aug01,2022

Report No.: FYCR221200049005

Page: 75 of 115

### Radar Type 5 - Trial 19

Trial List										
	Trial Id	Radar Type	Number of Bursts	Burst Period (s)	Waveform Length (s)	Center Frequency (GHz)				
Download	19	Type 5	12	1.0000000	12.0000000	5.501500000				
		<b>Burst ID</b>	<b>Burst Offset (us)</b>	<b>Pulse Width (us)</b>	<b>Chirp Width (MHz)</b>	<b>Number of Pulses per Burst</b>	<b>PRI-1 (us)</b>	<b>PRI-2 (us)</b>	<b>PRI-3 (us)</b>	
		0	733725.0	88.6	10	3	1501.0	1067.0	1927.0	
		1	977882.0	57.4	10	1	1723.0	-	-	
		2	221197.0	96.6	10	3	1086.0	1658.0	1324.0	
		3	462915.0	69.7	10	2	1751.0	1945.0	-	
		4	705071.0	77.9	10	2	1642.0	1317.0	-	
		5	947923.0	62.0	10	1	1866.0	-	-	
		6	191373.0	88.4	10	3	1997.0	1077.0	1366.0	
		7	432561.0	97.3	10	3	1790.0	1896.0	1367.0	
		8	674004.0	96.2	10	3	1391.0	1787.0	1672.0	
		9	915842.0	95.4	10	3	1020.0	1892.0	1414.0	
		10	162176.0	54.8	10	1	1084.0	-	-	
		11	403553.0	80.4	10	2	1850.0	1436.0	-	
Download	20	Type 5	16	0.7500000	12.0000000	5.496500000				
		<b>Burst ID</b>	<b>Burst Offset (us)</b>	<b>Pulse Width (us)</b>	<b>Chirp Width (MHz)</b>	<b>Number of Pulses per Burst</b>	<b>PRI-1 (us)</b>	<b>PRI-2 (us)</b>	<b>PRI-3 (us)</b>	
		0	483470.0	74.7	15	2	1619.0	1611.0	-	
		1	666072.0	57.1	15	1	1560.0	-	-	
		2	98810.0	91.9	15	3	1392.0	1475.0	1276.0	
		3	279914.0	83.1	15	2	1809.0	1772.0	-	
		4	462536.0	50.7	15	1	1003.0	-	-	
		5	642324.0	79.2	15	2	1574.0	1600.0	-	
		6	76831.0	58.7	15	1	1186.0	-	-	
		7	257785.0	71.0	15	2	1521.0	1567.0	-	
		8	438554.0	79.0	15	2	1777.0	1960.0	-	
		9	620397.0	68.5	15	2	1284.0	1428.0	-	
		10	54310.0	73.5	15	2	1904.0	1352.0	-	



Unless otherwise agreed in writing, this document is issued by the Company subject to its General Conditions of Service printed overleaf, available on request or accessible at <http://www.sgs.com/en/Terms-and-Conditions.aspx> and, for electronic format documents, subject to Terms and Conditions for Electronic Documents at <http://www.sgs.com/en/Terms-and-Conditions/Terms-e-Documents.aspx>. Attention is drawn to the limitation of liability, indemnification and jurisdiction issues defined therein. Any holder of this document is advised that information contained hereon reflects the Company's findings at the time of its intervention only and within the limits of Client's instructions, if any. The Company's sole responsibility is to its Client and this document does not exonerate parties to a transaction from exercising all their rights and obligations under the transaction documents. This document cannot be reproduced except in full, without prior written approval of the Company. Any unauthorized alteration, forgery or falsification of the content or appearance of this document is unlawful and offenders may be prosecuted to the fullest extent of the law. Unless otherwise stated the results shown in this test report refer only to the sample(s) tested and such sample(s) are retained for 30 days only. **Attention: To check the authenticity of testing/inspection report & certificate, please contact us at telephone: (86-755) 8307 1443, or email: CN.Doccheck@sgs.com**

Compliance Certification Services (Kunshan) Inc. Shenzhen Branch

Fuyong lab, Xinlong TechnoPark, Fengtang Road, Fuyong Subdistrict, Bao'an, Shenzhen, China 518103 t (86-755) 88663988 f (86-755) 26710594 www.sgs.com.cn  
 中国·深圳·宝安区福永街道凤塘大道鑫龙科技园福永实验室 邮编: 518103 t (86-755) 88663988 f (86-755) 26710594 sgs.china@sgs.com

## Compliance Certification Services (Kunshan) Inc. Shenzhen Branch

SZCCS-TRF-01 Rev. A/0 Aug01,2022

Report No.: FYCR221200049005

Page: 76 of 115

### Radar Type 5 - Trial 20

Trial List										
	Download	Trial Id	Radar Type	Number of Bursts	Burst Period (s)	Waveform Length (s)	Center Frequency (GHz)			
			Burst ID	Burst Offset (us)	Pulse Width (us)	Chirp Width (MHz)	Number of Pulses per Burst	PRI-1 (us)	PRI-2 (us)	PRI-3 (us)
		20	Type 5	16	0.7500000	12.0000000	5.496500000			
			0	483470.0	74.7	15	2	1619.0	1611.0	-
			1	666072.0	57.1	15	1	1560.0	-	-
			2	98810.0	91.9	15	3	1392.0	1475.0	1276.0
			3	279914.0	83.1	15	2	1809.0	1772.0	-
			4	462536.0	50.7	15	1	1003.0	-	-
			5	642324.0	79.2	15	2	1574.0	1600.0	-
			6	76831.0	58.7	15	1	1186.0	-	-
			7	257785.0	71.0	15	2	1521.0	1567.0	-
			8	438554.0	79.0	15	2	1777.0	1960.0	-
			9	620397.0	68.5	15	2	1284.0	1428.0	-
			10	54310.0	73.5	15	2	1904.0	1352.0	-
			11	235506.0	70.5	15	2	1864.0	1115.0	-
			12	417036.0	76.6	15	2	1045.0	1300.0	-
			13	597974.0	81.2	15	2	1160.0	1675.0	-
			14	32086.0	61.8	15	1	1277.0	-	-
			15	212751.0	94.9	15	3	1450.0	1206.0	1860.0
	Download	21	Type 5	12	1.0000000	12.0000000	5.498900000			
			Burst ID	Burst Offset (us)	Pulse Width (us)	Chirp Width (MHz)	Number of Pulses per Burst	PRI-1 (us)	PRI-2 (us)	PRI-3 (us)
			0	526149.0	78.5	9	2	1653.0	1698.0	-
			1	767135.0	89.8	9	3	1174.0	1962.0	1167.0
			2	12955.0	59.4	9	1	1982.0	-	-
			3	254612.0	79.6	9	2	1633.0	1890.0	-
			4	496588.0	76.0	9	2	1112.0	1811.0	-
			5	739728.0	53.6	9	1	1144.0	-	-



Unless otherwise agreed in writing, this document is issued by the Company subject to its General Conditions of Service printed overleaf, available on request or accessible at <http://www.sgs.com/en/Terms-and-Conditions.aspx> and, for electronic format documents, subject to Terms and Conditions for Electronic Documents at <http://www.sgs.com/en/Terms-and-Conditions/Terms-e-Documents.aspx>. Attention is drawn to the limitation of liability, indemnification and jurisdiction issues defined therein. Any holder of this document is advised that information contained hereon reflects the Company's findings at the time of its intervention only and within the limits of Client's instructions, if any. The Company's sole responsibility is to its Client and this document does not exonerate parties to a transaction from exercising all their rights and obligations under the transaction documents. This document cannot be reproduced except in full, without prior written approval of the Company. Any unauthorized alteration, forgery or falsification of the content or appearance of this document is unlawful and offenders may be prosecuted to the fullest extent of the law. Unless otherwise stated the results shown in this test report refer only to the sample(s) tested and such sample(s) are retained for 30 days only. Attention: To check the authenticity of testing/inspection report & certificate, please contact us at telephone: (86-755) 8307 1443, or email: CN.Doccheck@sgs.com

Compliance Certification Services (Kunshan) Inc. Shenzhen Branch

Fuyong Lab, Xinlong TechnoPark, Fengtang Road, Fuyong Subdistrict, Bao'an, Shenzhen, China 518103 t (86-755) 88663988 f (86-755) 26710594 www.sgs.com.cn  
 中国·深圳·宝安区福永街道凤塘大道鑫龙科技园福永实验室 邮编: 518103 t (86-755) 88663988 f (86-755) 26710594 sgs.china@sgs.com

## Compliance Certification Services (Kunshan) Inc. Shenzhen Branch

SZCCS-TRF-01 Rev. A/0 Aug01,2022

Report No.: FYCR221200049005

Page: 77 of 115

### Radar Type 5 - Trial 21

Trial List										
	Download	Trial Id	Radar Type	Number of Bursts	Burst Period (s)	Waveform Length (s)	Center Frequency (GHz)			
<input type="checkbox"/>	Download	21	Type 5	12	1.00000000	12.00000000	5.4989000000			
			<b>Burst ID</b>	<b>Burst Offset (us)</b>	<b>Pulse Width (us)</b>	<b>Chirp Width (MHz)</b>	<b>Number of Pulses per Burst</b>	<b>PRI-1 (us)</b>	<b>PRI-2 (us)</b>	<b>PRI-3 (us)</b>
			0	526149.0	78.5	9	2	1653.0	1698.0	-
			1	767135.0	89.8	9	3	1174.0	1962.0	1167.0
			2	12955.0	59.4	9	1	1982.0	-	-
			3	254612.0	79.6	9	2	1633.0	1890.0	-
			4	496588.0	76.0	9	2	1112.0	1811.0	-
			5	739728.0	53.6	9	1	1144.0	-	-
			6	980872.0	80.9	9	2	1220.0	1053.0	-
			7	225249.0	61.6	9	1	1724.0	-	-
			8	467279.0	53.4	9	1	1901.0	-	-
			9	709720.0	59.9	9	1	1379.0	-	-
			10	951847.0	60.4	9	1	1453.0	-	-
			11	194839.0	91.4	9	3	1768.0	1726.0	1227.0
<input type="checkbox"/>	Download	22	Type 5	20	0.60000000	12.00000000	5.4945000000			
			<b>Burst ID</b>	<b>Burst Offset (us)</b>	<b>Pulse Width (us)</b>	<b>Chirp Width (MHz)</b>	<b>Number of Pulses per Burst</b>	<b>PRI-1 (us)</b>	<b>PRI-2 (us)</b>	<b>PRI-3 (us)</b>
			0	261858.0	77.0	20	2	1191.0	1363.0	-
			1	407646.0	58.1	20	1	1248.0	-	-
			2	552319.0	62.1	20	1	1636.0	-	-
			3	99107.0	76.9	20	2	1334.0	1236.0	-
			4	243514.0	80.0	20	2	1914.0	1852.0	-
			5	389464.0	52.0	20	1	1701.0	-	-
			6	531093.0	88.6	20	3	1693.0	1995.0	1905.0
			7	61159.0	72.9	20	2	1922.0	1387.0	-
			8	225245.0	98.5	20	3	1839.0	1746.0	1389.0
			9	371906.0	57.9	20	1	1193.0	-	-



Unless otherwise agreed in writing, this document is issued by the Company subject to its General Conditions of Service printed overleaf, available on request or accessible at <http://www.sgs.com/en/Terms-and-Conditions.aspx> and, for electronic format documents, subject to Terms and Conditions for Electronic Documents at <http://www.sgs.com/en/Terms-and-Conditions/Terms-e-Documents.aspx>. Attention is drawn to the limitation of liability, indemnification and jurisdiction issues defined therein. Any holder of this document is advised that information contained hereon reflects the Company's findings at the time of its intervention only and within the limits of Client's instructions, if any. The Company's sole responsibility is to its Client and this document does not exonerate parties to a transaction from exercising all their rights and obligations under the transaction documents. This document cannot be reproduced except in full, without prior written approval of the Company. Any unauthorized alteration, forgery or falsification of the content or appearance of this document is unlawful and offenders may be prosecuted to the fullest extent of the law. Unless otherwise stated the results shown in this test report refer only to the sample(s) tested and such sample(s) are retained for 30 days only. **Attention: To check the authenticity of testing/inspection report & certificate, please contact us at telephone: (86-755) 8307 1443, or email: CN.Doccheck@sgs.com**

Compliance Certification Services (Kunshan) Inc. Shenzhen Branch

Fuyong lab, Xinlong TechnoPark, Fengtang Road, Fuyong Subdistrict, Bao'an, Shenzhen, China 518103 t (86-755) 88663988 f (86-755) 26710594 www.sgs.com.cn  
 中国·深圳·宝安区福永街道凤塘大道鑫龙科技园福永实验室 邮编: 518103 t (86-755) 88663988 f (86-755) 26710594 sgs.china@sgs.com

## Compliance Certification Services (Kunshan) Inc. Shenzhen Branch

SZCCS-TRF-01 Rev. A/0 Aug01,2022

Report No.: FYCR221200049005

Page: 78 of 115

### Radar Type 5 - Trial 22

Trial List										
	Trial Id	Radar Type	Number of Bursts	Burst Period (s)	Waveform Length (s)	Center Frequency (GHz)				
Download	22	Type 5	20	0.60000000	12.00000000	5.494500000				
		<b>Burst ID</b>	<b>Burst Offset (us)</b>	<b>Pulse Width (us)</b>	<b>Chirp Width (MHz)</b>	<b>Number of Pulses per Burst</b>	<b>PRI-1 (us)</b>	<b>PRI-2 (us)</b>	<b>PRI-3 (us)</b>	
		0	261858.0	77.0	20	2	1191.0	1363.0	-	
		1	407646.0	58.1	20	1	1248.0	-	-	
		2	552319.0	62.1	20	1	1836.0	-	-	
		3	99107.0	76.9	20	2	1334.0	1236.0	-	
		4	243514.0	80.0	20	2	1914.0	1852.0	-	
		5	389464.0	52.0	20	1	1701.0	-	-	
		6	531093.0	88.6	20	3	1693.0	1995.0	1905.0	
		7	81159.0	72.9	20	2	1922.0	1387.0	-	
		8	225245.0	98.5	20	3	1839.0	1746.0	1389.0	
		9	371906.0	57.9	20	1	1193.0	-	-	
		10	514197.0	95.9	20	3	1659.0	1870.0	1066.0	
		11	63561.0	53.5	20	1	1162.0	-	-	
		12	207510.0	92.0	20	3	1745.0	1654.0	1458.0	
		13	353638.0	57.3	20	1	1834.0	-	-	
		14	497515.0	70.5	20	2	1684.0	1586.0	-	
		15	45553.0	70.0	20	2	1042.0	1664.0	-	
		16	189821.0	84.0	20	3	1765.0	1630.0	1176.0	
		17	335330.0	76.1	20	2	1557.0	1057.0	-	
		18	478825.0	93.2	20	3	1985.0	1018.0	1340.0	
		19	27594.0	96.8	20	3	1760.0	1614.0	1817.0	
Download	23	Type 5	14	0.8571429	12.00000000	5.497700000				
		<b>Burst ID</b>	<b>Burst Offset (us)</b>	<b>Pulse Width (us)</b>	<b>Chirp Width (MHz)</b>	<b>Number of Pulses per Burst</b>	<b>PRI-1 (us)</b>	<b>PRI-2 (us)</b>	<b>PRI-3 (us)</b>	
		0	247117.0	50.1	12	1	1841.0	-	-	
		1	453362.0	93.5	12	3	1590.0	1081.0	1413.0	



Unless otherwise agreed in writing, this document is issued by the Company subject to its General Conditions of Service printed overleaf, available on request or accessible at <http://www.sgs.com/en/Terms-and-Conditions.aspx> and, for electronic format documents, subject to Terms and Conditions for Electronic Documents at <http://www.sgs.com/en/Terms-and-Conditions/Terms-e-Documents.aspx>. Attention is drawn to the limitation of liability, indemnification and jurisdiction issues defined therein. Any holder of this document is advised that information contained hereon reflects the Company's findings at the time of its intervention only and within the limits of Client's instructions, if any. The Company's sole responsibility is to its Client and this document does not exonerate parties to a transaction from exercising all their rights and obligations under the transaction documents. This document cannot be reproduced except in full, without prior written approval of the Company. Any unauthorized alteration, forgery or falsification of the content or appearance of this document is unlawful and offenders may be prosecuted to the fullest extent of the law. Unless otherwise stated the results shown in this test report refer only to the sample(s) tested and such sample(s) are retained for 30 days only. Attention: To check the authenticity of testing/inspection report & certificate, please contact us at telephone: (86-755) 8307 1443, or email: CN.Doccheck@sgs.com

Compliance Certification Services (Kunshan) Inc. Shenzhen Branch

Fuyong lab, Xinlong TechnoPark, Fengtang Road, Fuyong Subdistrict, Bao'an, Shenzhen, China 518103 t (86-755) 88663988 f (86-755) 26710594 www.sgs.com.cn  
 中国·深圳·宝安区福永街道凤塘大道鑫龙科技园福永实验室 邮编: 518103 t (86-755) 88663988 f (86-755) 26710594 sgs.china@sgs.com

## Compliance Certification Services (Kunshan) Inc. Shenzhen Branch

SZCCS-TRF-01 Rev. A/0 Aug01,2022

Report No.: FYCR221200049005

Page: 79 of 115

### Radar Type 5 - Trial 23

Trial List										
	Download	Trial Id	Radar Type	Number of Bursts	Burst Period (s)	Waveform Length (s)	Center Frequency (GHz)			
<input type="checkbox"/>	Download	23	Type 5	14	0.8571429	12.00000000	5.497700000			
			<b>Burst ID</b>	<b>Burst Offset (us)</b>	<b>Pulse Width (us)</b>	<b>Chirp Width (MHz)</b>	<b>Number of Pulses per Burst</b>	<b>PRI-1 (us)</b>	<b>PRI-2 (us)</b>	<b>PRI-3 (us)</b>
			0	247117.0	50.1	12	1	1841.0	-	-
			1	453362.0	93.5	12	3	1590.0	1081.0	1413.0
			2	660875.0	68.8	12	2	1707.0	1577.0	-
			3	14140.0	56.3	12	1	1056.0	-	-
			4	220734.0	86.0	12	3	1953.0	1108.0	1987.0
			5	428367.0	75.2	12	2	1572.0	1536.0	-
			6	636681.0	54.4	12	1	1517.0	-	-
			7	843157.0	71.1	12	2	1329.0	1243.0	-
			8	195585.0	76.2	12	2	1940.0	1770.0	-
			9	403231.0	80.2	12	2	1098.0	1209.0	-
			10	610202.0	79.7	12	2	1588.0	1214.0	-
			11	815229.0	90.9	12	3	1615.0	1862.0	1601.0
			12	170267.0	68.7	12	2	1377.0	1441.0	-
			13	377306.0	67.4	12	2	1872.0	1313.0	-
<input type="checkbox"/>	Download	24	Type 5	13	0.9230769	12.00000000	5.498100000			
			<b>Burst ID</b>	<b>Burst Offset (us)</b>	<b>Pulse Width (us)</b>	<b>Chirp Width (MHz)</b>	<b>Number of Pulses per Burst</b>	<b>PRI-1 (us)</b>	<b>PRI-2 (us)</b>	<b>PRI-3 (us)</b>
			0	628071.0	94.0	11	3	1643.0	1748.0	1941.0
			1	853391.0	70.8	11	2	1177.0	1201.0	-
			2	156223.0	56.3	11	1	1006.0	-	-
			3	378734.0	96.7	11	3	1230.0	1163.0	1332.0
			4	601331.0	90.6	11	3	1217.0	1582.0	1498.0
			5	825462.0	74.5	11	2	1569.0	1281.0	-
			6	128265.0	92.6	11	3	1065.0	1669.0	1222.0
			7	351161.0	89.0	11	3	1493.0	1135.0	1380.0
			8	573425.0	96.5	11	3	1607.0	1822.0	1602.0



Unless otherwise agreed in writing, this document is issued by the Company subject to its General Conditions of Service printed overleaf, available on request or accessible at <http://www.sgs.com/en/Terms-and-Conditions.aspx> and, for electronic format documents, subject to Terms and Conditions for Electronic Documents at <http://www.sgs.com/en/Terms-and-Conditions/Terms-e-Documents.aspx>. Attention is drawn to the limitation of liability, indemnification and jurisdiction issues defined therein. Any holder of this document is advised that information contained hereon reflects the Company's findings at the time of its intervention only and within the limits of Client's instructions, if any. The Company's sole responsibility is to its Client and this document does not exonerate parties to a transaction from exercising all their rights and obligations under the transaction documents. This document cannot be reproduced except in full, without prior written approval of the Company. Any unauthorized alteration, forgery or falsification of the content or appearance of this document is unlawful and offenders may be prosecuted to the fullest extent of the law. Unless otherwise stated the results shown in this test report refer only to the sample(s) tested and such sample(s) are retained for 30 days only. **Attention: To check the authenticity of testing/inspection report & certificate, please contact us at telephone: (86-755) 8307 1443, or email: CN.Doccheck@sgs.com**

Compliance Certification Services (Kunshan) Inc. Shenzhen Branch

Fuyong Lab, Xinlong TechnoPark, Fengtang Road, Fuyong Subdistrict, Bao'an, Shenzhen, China 518103 t (86-755) 88663988 f (86-755) 26710594 www.sgs.com.cn  
 中国·深圳·宝安区福永街道凤塘大道鑫龙科技园福永实验室 邮编: 518103 t (86-755) 88663988 f (86-755) 26710594 sgs.china@sgs.com

## Compliance Certification Services (Kunshan) Inc. Shenzhen Branch

SZCCS-TRF-01 Rev. A/0 Aug01,2022

Report No.: FYCR221200049005

Page: 80 of 115

### Radar Type 5 - Trial 24

Trial List										
	Download	Trial Id	Radar Type	Number of Bursts	Burst Period (s)	Waveform Length (s)	Center Frequency (GHz)			
<input type="checkbox"/>	Download	24	Type 5	13	0.9230769	12.00000000	5.498100000			
			<b>Burst ID</b>	<b>Burst Offset (us)</b>	<b>Pulse Width (us)</b>	<b>Chirp Width (MHz)</b>	<b>Number of Pulses per Burst</b>	<b>PRI-1 (us)</b>	<b>PRI-2 (us)</b>	<b>PRI-3 (us)</b>
			0	628071.0	94.0	11	3	1643.0	1748.0	1941.0
			1	853391.0	70.8	11	2	1177.0	1201.0	-
			2	156223.0	56.3	11	1	1006.0	-	-
			3	378734.0	96.7	11	3	1230.0	1163.0	1332.0
			4	601331.0	90.6	11	3	1217.0	1582.0	1498.0
			5	825462.0	74.5	11	2	1569.0	1281.0	-
			6	128265.0	92.6	11	3	1065.0	1669.0	1222.0
			7	351161.0	89.0	11	3	1493.0	1135.0	1380.0
			8	573425.0	96.5	11	3	1607.0	1822.0	1602.0
			9	798431.0	70.5	11	2	1141.0	1178.0	-
			10	100737.0	94.0	11	3	1009.0	1629.0	1956.0
			11	324661.0	55.8	11	1	1290.0	-	-
			12	546278.0	87.7	11	3	1435.0	1963.0	1164.0
<input type="checkbox"/>	Download	25	Type 5	8	1.5000000	12.00000000	5.500500000			
			<b>Burst ID</b>	<b>Burst Offset (us)</b>	<b>Pulse Width (us)</b>	<b>Chirp Width (MHz)</b>	<b>Number of Pulses per Burst</b>	<b>PRI-1 (us)</b>	<b>PRI-2 (us)</b>	<b>PRI-3 (us)</b>
			0	1253842.0	68.6	5	2	1306.0	1161.0	-
			1	119486.0	83.1	5	2	1420.0	1315.0	-
			2	482958.0	60.9	5	1	1687.0	-	-
			3	845641.0	77.7	5	2	1776.0	1158.0	-
			4	1208428.0	77.4	5	2	1793.0	1510.0	-
			5	74748.0	66.8	5	2	1576.0	1323.0	-
			6	438300.0	63.7	5	1	1333.0	-	-
			7	800152.0	91.2	5	3	1409.0	1681.0	1275.0
<input type="checkbox"/>	Download	26	Type 5	17	0.7058824	12.00000000	5.496100000			
			<b>Burst ID</b>	<b>Burst Offset (us)</b>	<b>Pulse Width (us)</b>	<b>Chirp Width (MHz)</b>	<b>Number of Pulses per Burst</b>	<b>PRI-1 (us)</b>	<b>PRI-2 (us)</b>	<b>PRI-3 (us)</b>



Unless otherwise agreed in writing, this document is issued by the Company subject to its General Conditions of Service printed overleaf, available on request or accessible at <http://www.sgs.com/en/Terms-and-Conditions.aspx> and, for electronic format documents, subject to Terms and Conditions for Electronic Documents at <http://www.sgs.com/en/Terms-and-Conditions/Terms-e-Documents.aspx>. Attention is drawn to the limitation of liability, indemnification and jurisdiction issues defined therein. Any holder of this document is advised that information contained hereon reflects the Company's findings at the time of its intervention only and within the limits of Client's instructions, if any. The Company's sole responsibility is to its Client and this document does not exonerate parties to a transaction from exercising all their rights and obligations under the transaction documents. This document cannot be reproduced except in full, without prior written approval of the Company. Any unauthorized alteration, forgery or falsification of the content or appearance of this document is unlawful and offenders may be prosecuted to the fullest extent of the law. Unless otherwise stated the results shown in this test report refer only to the sample(s) tested and such sample(s) are retained for 30 days only. Attention: To check the authenticity of testing/inspection report & certificate, please contact us at telephone: (86-755) 8307 1443, or email: CN.Doccheck@sgs.com

Compliance Certification Services (Kunshan) Inc. Shenzhen Branch

Fuyong Lab, Xinlong TechnoPark, Fengtang Road, Fuyong Subdistrict, Bao'an, Shenzhen, China 518103 t (86-755) 88663988 f (86-755) 26710594 www.sgs.com.cn  
 中国·深圳·宝安区福永街道凤塘大道鑫龙科技园福永实验室 邮编: 518103 t (86-755) 88663988 f (86-755) 26710594 sgs.china@sgs.com



## Compliance Certification Services (Kunshan) Inc. Shenzhen Branch

SZCCS-TRF-01 Rev. A/0 Aug01,2022

Report No.: FYCR221200049005

Page: 81 of 115

### Radar Type 5 - Trial 25

Trial List										
	Trial Id	Radar Type	Number of Bursts	Burst Period (s)	Waveform Length (s)	Center Frequency (GHz)				
Download	25	Type 5	8	1.5000000	12.0000000	5.500500000				
		<b>Burst ID</b>	<b>Burst Offset (us)</b>	<b>Pulse Width (us)</b>	<b>Chirp Width (MHz)</b>	<b>Number of Pulses per Burst</b>	<b>PRI-1 (us)</b>	<b>PRI-2 (us)</b>	<b>PRI-3 (us)</b>	
		0	1253842.0	68.6	5	2	1306.0	1161.0	-	
		1	119486.0	83.1	5	2	1420.0	1315.0	-	
		2	482958.0	60.9	5	1	1687.0	-	-	
		3	845641.0	77.7	5	2	1776.0	1158.0	-	
		4	1208428.0	77.4	5	2	1793.0	1510.0	-	
		5	74748.0	66.8	5	2	1576.0	1323.0	-	
		6	438300.0	63.7	5	1	1333.0	-	-	
		7	800152.0	91.2	5	3	1409.0	1681.0	1275.0	
Download	26	Type 5	17	0.7058824	12.0000000	5.496100000				
		<b>Burst ID</b>	<b>Burst Offset (us)</b>	<b>Pulse Width (us)</b>	<b>Chirp Width (MHz)</b>	<b>Number of Pulses per Burst</b>	<b>PRI-1 (us)</b>	<b>PRI-2 (us)</b>	<b>PRI-3 (us)</b>	
		0	545865.0	83.6	16	3	1632.0	1195.0	1000.0	
		1	14067.0	89.4	16	3	1173.0	1627.0	1656.0	
		2	184953.0	55.8	16	1	1532.0	-	-	
		3	353759.0	90.9	16	3	1981.0	1554.0	1998.0	
		4	526388.0	54.7	16	1	1825.0	-	-	
		5	694806.0	97.7	16	3	1734.0	1202.0	1250.0	
		6	163568.0	67.5	16	2	1571.0	1434.0	-	
		7	333410.0	96.7	16	3	1589.0	1469.0	1268.0	
		8	504006.0	68.3	16	2	1750.0	1954.0	-	
		9	675297.0	78.3	16	2	1591.0	1082.0	-	
		10	142890.0	55.0	16	1	1427.0	-	-	
		11	312479.0	84.9	16	3	1129.0	1936.0	1199.0	
		12	482953.0	74.6	16	2	1959.0	1856.0	-	
		13	655022.0	63.3	16	1	1885.0	-	-	



Unless otherwise agreed in writing, this document is issued by the Company subject to its General Conditions of Service printed overleaf, available on request or accessible at <http://www.sgs.com/en/Terms-and-Conditions.aspx> and, for electronic format documents, subject to Terms and Conditions for Electronic Documents at <http://www.sgs.com/en/Terms-and-Conditions/Terms-e-Documents.aspx>. Attention is drawn to the limitation of liability, indemnification and jurisdiction issues defined therein. Any holder of this document is advised that information contained hereon reflects the Company's findings at the time of its intervention only and within the limits of Client's instructions, if any. The Company's sole responsibility is to its Client and this document does not exonerate parties to a transaction from exercising all their rights and obligations under the transaction documents. This document cannot be reproduced except in full, without prior written approval of the Company. Any unauthorized alteration, forgery or falsification of the content or appearance of this document is unlawful and offenders may be prosecuted to the fullest extent of the law. Unless otherwise stated the results shown in this test report refer only to the sample(s) tested and such sample(s) are retained for 30 days only. Attention: To check the authenticity of testing/inspection report & certificate, please contact us at telephone: (86-755) 8307 1443, or email: CN.Doccheck@sgs.com

Compliance Certification Services (Kunshan) Inc. Shenzhen Branch

Fuyong Lab, Xinlong TechnoPark, Fengtang Road, Fuyong Subdistrict, Bao'an, Shenzhen, China 518103 t (86-755) 88663988 f (86-755) 26710594 www.sgs.com.cn  
 中国·深圳·宝安区福永街道凤塘大道鑫龙科技园福永实验室 邮编: 518103 t (86-755) 88663988 f (86-755) 26710594 sgs.china@sgs.com

## Compliance Certification Services (Kunshan) Inc. Shenzhen Branch

SZCCS-TRF-01 Rev. A/0 Aug01,2022

Report No.: FYCR221200049005

Page: 82 of 115

### Radar Type 5 - Trial 26

Trial List										
	Download	Trial Id	Radar Type	Number of Bursts	Burst Period (s)	Waveform Length (s)	Center Frequency (GHz)			
			Burst ID	Burst Offset (us)	Pulse Width (us)	Chirp Width (MHz)	Number of Pulses per Burst	PRI-1 (us)	PRI-2 (us)	PRI-3 (us)
		26	Type 5	17	0.7058824	12.0000000	5.496100000			
			0	545865.0	83.6	16	3	1632.0	1195.0	1000.0
			1	14067.0	89.4	16	3	1173.0	1627.0	1656.0
			2	184953.0	55.8	16	1	1532.0	-	-
			3	353759.0	90.9	16	3	1981.0	1554.0	1998.0
			4	526388.0	54.7	16	1	1825.0	-	-
			5	694806.0	97.7	16	3	1734.0	1202.0	1250.0
			6	163568.0	67.5	16	2	1571.0	1434.0	-
			7	333410.0	96.7	16	3	1589.0	1469.0	1268.0
			8	504006.0	68.3	16	2	1750.0	1954.0	-
			9	675297.0	78.3	16	2	1591.0	1082.0	-
			10	142890.0	55.0	16	1	1427.0	-	-
			11	312479.0	84.9	16	3	1129.0	1936.0	1199.0
			12	482953.0	74.6	16	2	1959.0	1856.0	-
			13	655022.0	63.3	16	1	1885.0	-	-
			14	121457.0	99.8	16	3	1035.0	1515.0	1120.0
			15	292606.0	63.6	16	1	1647.0	-	-
			16	461322.0	87.3	16	3	1931.0	1051.0	1831.0
	Download	27	Type 5	19	0.6315789	12.0000000	5.494900000			
			0	565136.0	65.6	19	3	1946.0	1078.0	1015.0
			1	89970.0	68.6	19	2	1029.0	1780.0	-
			2	243121.0	54.2	19	1	1111.0	-	-
			3	396034.0	61.2	19	1	1104.0	-	-
			4	546225.0	97.1	19	3	1157.0	1969.0	1100.0



Unless otherwise agreed in writing, this document is issued by the Company subject to its General Conditions of Service printed overleaf, available on request or accessible at <http://www.sgs.com/en/Terms-and-Conditions.aspx> and, for electronic format documents, subject to Terms and Conditions for Electronic Documents at <http://www.sgs.com/en/Terms-and-Conditions/Terms-e-Documents.aspx>. Attention is drawn to the limitation of liability, indemnification and jurisdiction issues defined therein. Any holder of this document is advised that information contained hereon reflects the Company's findings at the time of its intervention only and within the limits of Client's instructions, if any. The Company's sole responsibility is to its Client and this document does not exonerate parties to a transaction from exercising all their rights and obligations under the transaction documents. This document cannot be reproduced except in full, without prior written approval of the Company. Any unauthorized alteration, forgery or falsification of the content or appearance of this document is unlawful and offenders may be prosecuted to the fullest extent of the law. Unless otherwise stated the results shown in this test report refer only to the sample(s) tested and such sample(s) are retained for 30 days only. Attention: To check the authenticity of testing/inspection report & certificate, please contact us at telephone: (86-755) 8307 1443, or email: CN.Doccheck@sgs.com

Compliance Certification Services (Kunshan) Inc. Shenzhen Branch

Fuyong Lab, Xinlong TechnoPark, Fengtang Road, Fuyong Subdistrict, Bao'an, Shenzhen, China 518103 t (86-755) 88663988 f (86-755) 26710594 www.sgs.com.cn  
 中国·深圳·宝安区福永街道凤塘大道鑫龙科技园福永实验室 邮编: 518103 t (86-755) 88663988 f (86-755) 26710594 sgs.china@sgs.com

## Compliance Certification Services (Kunshan) Inc. Shenzhen Branch

SZCCS-TRF-01 Rev. A/0 Aug01,2022

Report No.: FYCR221200049005

Page: 83 of 115

### Radar Type 5 - Trial 27

Trial List										
	Download	Trial Id	Radar Type	Number of Bursts	Burst Period (s)	Waveform Length (s)	Center Frequency (GHz)			
<input type="checkbox"/>	Download	27	Type 5	19	0.6315789	12.00000000	5.494900000			
			<b>Burst ID</b>	<b>Burst Offset (us)</b>	<b>Pulse Width (us)</b>	<b>Chirp Width (MHz)</b>	<b>Number of Pulses per Burst</b>	<b>PRI-1 (us)</b>	<b>PRI-2 (us)</b>	<b>PRI-3 (us)</b>
			0	565136.0	85.6	19	3	1946.0	1078.0	1015.0
			1	89970.0	68.6	19	2	1029.0	1780.0	-
			2	243121.0	54.2	19	1	1111.0	-	-
			3	396034.0	61.2	19	1	1104.0	-	-
			4	546225.0	97.1	19	3	1157.0	1969.0	1100.0
			5	70998.0	98.3	19	3	1142.0	1699.0	1622.0
			6	224093.0	62.4	19	1	1655.0	-	-
			7	376127.0	80.2	19	2	1126.0	1769.0	-
			8	527806.0	87.5	19	3	1216.0	1448.0	1179.0
			9	52247.0	85.8	19	3	1847.0	1348.0	1472.0
			10	204582.0	88.1	19	3	1023.0	1124.0	1631.0
			11	357941.0	65.3	19	1	1848.0	-	-
			12	510977.0	52.5	19	1	1470.0	-	-
			13	33698.0	52.3	19	1	1312.0	-	-
			14	186023.0	74.1	19	2	1915.0	1200.0	-
			15	339327.0	54.9	19	1	1479.0	-	-
			16	491053.0	76.2	19	2	1376.0	1502.0	-
			17	14858.0	60.4	19	1	1758.0	-	-
			18	167387.0	81.5	19	2	1491.0	1103.0	-
<input type="checkbox"/>	Download	28	Type 5	12	1.0000000	12.00000000	5.498500000			
			<b>Burst ID</b>	<b>Burst Offset (us)</b>	<b>Pulse Width (us)</b>	<b>Chirp Width (MHz)</b>	<b>Number of Pulses per Burst</b>	<b>PRI-1 (us)</b>	<b>PRI-2 (us)</b>	<b>PRI-3 (us)</b>
			0	507709.0	50.5	10	1	1857.0	-	-
			1	750249.0	55.7	10	1	1246.0	-	-
			2	989003.0	85.8	10	3	1774.0	1002.0	1967.0



Unless otherwise agreed in writing, this document is issued by the Company subject to its General Conditions of Service printed overleaf, available on request or accessible at <http://www.sgs.com/en/Terms-and-Conditions.aspx> and, for electronic format documents, subject to Terms and Conditions for Electronic Documents at <http://www.sgs.com/en/Terms-and-Conditions/Terms-e-Documents.aspx>. Attention is drawn to the limitation of liability, indemnification and jurisdiction issues defined therein. Any holder of this document is advised that information contained hereon reflects the Company's findings at the time of its intervention only and within the limits of Client's instructions, if any. The Company's sole responsibility is to its Client and this document does not exonerate parties to a transaction from exercising all their rights and obligations under the transaction documents. This document cannot be reproduced except in full, without prior written approval of the Company. Any unauthorized alteration, forgery or falsification of the content or appearance of this document is unlawful and offenders may be prosecuted to the fullest extent of the law. Unless otherwise stated the results shown in this test report refer only to the sample(s) tested and such sample(s) are retained for 30 days only. Attention: To check the authenticity of testing/inspection report & certificate, please contact us at telephone: (86-755) 8307 1443, or email: CN.Doccheck@sgs.com

Compliance Certification Services (Kunshan) Inc. Shenzhen Branch

Fuyong Lab, Xinlong TechnoPark, Fengtang Road, Fuyong Subdistrict, Bao'an, Shenzhen, China 518103 t (86-755) 88663988 f (86-755) 26710594 www.sgs.com.cn  
 中国·深圳·宝安区福永街道凤塘大道鑫龙科技园福永实验室 邮编: 518103 t (86-755) 88663988 f (86-755) 26710594 sgs.china@sgs.com

## Compliance Certification Services (Kunshan) Inc. Shenzhen Branch

SZCCS-TRF-01 Rev. A/0 Aug01,2022

Report No.: FYCR221200049005

Page: 84 of 115

### Radar Type 5 - Trial 28

Trial List										
	Download	Trial Id	Radar Type	Number of Bursts	Burst Period (s)	Waveform Length (s)	Center Frequency (GHz)			
		28	Type 5	12	1.00000000	12.00000000	5.498500000			
			<b>Burst ID</b>	<b>Burst Offset (us)</b>	<b>Pulse Width (us)</b>	<b>Chirp Width (MHz)</b>	<b>Number of Pulses per Burst</b>	<b>PRI-1 (us)</b>	<b>PRI-2 (us)</b>	<b>PRI-3 (us)</b>
			0	507709.0	50.5	10	1	1857.0	-	-
			1	750249.0	55.7	10	1	1246.0	-	-
			2	989003.0	85.8	10	3	1774.0	1002.0	1967.0
			3	235634.0	76.9	10	2	1125.0	1474.0	-
			4	477675.0	75.1	10	2	1254.0	1052.0	-
			5	718312.0	92.3	10	3	1180.0	1486.0	1492.0
			6	960895.0	78.1	10	2	1301.0	1757.0	-
			7	205370.0	92.2	10	3	1898.0	1252.0	1713.0
			8	446940.0	89.0	10	3	1260.0	1706.0	1411.0
			9	689225.0	70.9	10	2	1578.0	1620.0	-
			10	932305.0	63.1	10	1	1782.0	-	-
			11	176231.0	55.3	10	1	1522.0	-	-
	Download	29	Type 5	18	0.66666667	12.00000000	5.495700000			
			<b>Burst ID</b>	<b>Burst Offset (us)</b>	<b>Pulse Width (us)</b>	<b>Chirp Width (MHz)</b>	<b>Number of Pulses per Burst</b>	<b>PRI-1 (us)</b>	<b>PRI-2 (us)</b>	<b>PRI-3 (us)</b>
			0	277485.0	83.4	17	3	1454.0	1205.0	1801.0
			1	437880.0	97.3	17	3	1319.0	1826.0	1635.0
			2	598445.0	90.4	17	3	1079.0	1986.0	1674.0
			3	97088.0	91.8	17	3	1563.0	1151.0	1802.0
			4	257251.0	98.2	17	3	1876.0	1977.0	1766.0
			5	419893.0	59.5	17	1	1952.0	-	-
			6	580724.0	80.0	17	2	1253.0	1137.0	-
			7	77366.0	86.5	17	3	1054.0	1128.0	1828.0
			8	238032.0	91.1	17	3	1105.0	1599.0	1442.0
			9	398605.0	93.5	17	3	1867.0	1373.0	1087.0



Unless otherwise agreed in writing, this document is issued by the Company subject to its General Conditions of Service printed overleaf, available on request or accessible at <http://www.sgs.com/en/Terms-and-Conditions.aspx> and, for electronic format documents, subject to Terms and Conditions for Electronic Documents at <http://www.sgs.com/en/Terms-and-Conditions/Terms-e-Documents.aspx>. Attention is drawn to the limitation of liability, indemnification and jurisdiction issues defined therein. Any holder of this document is advised that information contained hereon reflects the Company's findings at the time of its intervention only and within the limits of Client's instructions, if any. The Company's sole responsibility is to its Client and this document does not exonerate parties to a transaction from exercising all their rights and obligations under the transaction documents. This document cannot be reproduced except in full, without prior written approval of the Company. Any unauthorized alteration, forgery or falsification of the content or appearance of this document is unlawful and offenders may be prosecuted to the fullest extent of the law. Unless otherwise stated the results shown in this test report refer only to the sample(s) tested and such sample(s) are retained for 30 days only. Attention: To check the authenticity of testing/inspection report & certificate, please contact us at telephone: (86-755) 8307 1443, or email: CN.Doccheck@sgs.com

Compliance Certification Services (Kunshan) Inc. Shenzhen Branch

Fuyong lab, Xinlong TechnoPark, Fengtang Road, Fuyong Subdistrict, Bao'an, Shenzhen, China 518103 t (86-755) 88663988 f (86-755) 26710594 www.sgs.com.cn  
 中国·深圳·宝安区福永街道凤塘大道鑫龙科技园福永实验室 邮编: 518103 t (86-755) 88663988 f (86-755) 26710594 sgs.china@sgs.com

## Compliance Certification Services (Kunshan) Inc. Shenzhen Branch

SZCCS-TRF-01 Rev. A/0 Aug01,2022

Report No.: FYCR221200049005

Page: 85 of 115

### Radar Type 5 - Trial 29

Trial List										
	Trial Id	Radar Type	Number of Bursts	Burst Period (s)	Waveform Length (s)	Center Frequency (GHz)				
		6	960895.0	78.1	10	2	1301.0	1757.0	-	
		7	205370.0	92.2	10	3	1898.0	1252.0	1713.0	
		8	446940.0	89.0	10	3	1260.0	1706.0	1411.0	
		9	689225.0	70.9	10	2	1578.0	1620.0	-	
		10	932305.0	63.1	10	1	1782.0	-	-	
		11	176231.0	55.3	10	1	1522.0	-	-	
Download	29	Type 5	18	0.66666667	12.00000000	5.495700000				
		Burst ID	Burst Offset (us)	Pulse Width (us)	Chirp Width (MHz)	Number of Pulses per Burst	PRI-1 (us)	PRI-2 (us)	PRI-3 (us)	
		0	277485.0	83.4	17	3	1454.0	1205.0	1801.0	
		1	437880.0	97.3	17	3	1319.0	1826.0	1635.0	
		2	598445.0	90.4	17	3	1079.0	1986.0	1674.0	
		3	97088.0	91.8	17	3	1563.0	1151.0	1802.0	
		4	257251.0	98.2	17	3	1876.0	1977.0	1766.0	
		5	419893.0	59.5	17	1	1952.0	-	-	
		6	580724.0	80.0	17	2	1253.0	1137.0	-	
		7	77366.0	86.5	17	3	1054.0	1128.0	1828.0	
		8	238032.0	91.1	17	3	1105.0	1599.0	1442.0	
		9	398605.0	93.5	17	3	1867.0	1373.0	1087.0	
		10	562025.0	60.7	17	1	1033.0	-	-	
		11	57684.0	67.2	17	2	1288.0	1405.0	-	
		12	219083.0	61.8	17	1	1585.0	-	-	
		13	379234.0	79.4	17	2	1933.0	1667.0	-	
		14	540896.0	81.4	17	2	1096.0	1464.0	-	
		15	37916.0	65.7	17	1	1496.0	-	-	
		16	198794.0	76.0	17	2	1733.0	1255.0	-	
		17	359754.0	81.0	17	2	1326.0	1668.0	-	



Unless otherwise agreed in writing, this document is issued by the Company subject to its General Conditions of Service printed overleaf, available on request or accessible at <http://www.sgs.com/en/Terms-and-Conditions.aspx> and, for electronic format documents, subject to Terms and Conditions for Electronic Documents at <http://www.sgs.com/en/Terms-and-Conditions/Terms-e-Documents.aspx>. Attention is drawn to the limitation of liability, indemnification and jurisdiction issues defined therein. Any holder of this document is advised that information contained hereon reflects the Company's findings at the time of its intervention only and within the limits of Client's instructions, if any. The Company's sole responsibility is to its Client and this document does not exonerate parties to a transaction from exercising all their rights and obligations under the transaction documents. This document cannot be reproduced except in full, without prior written approval of the Company. Any unauthorized alteration, forgery or falsification of the content or appearance of this document is unlawful and offenders may be prosecuted to the fullest extent of the law. Unless otherwise stated the results shown in this test report refer only to the sample(s) tested and such sample(s) are retained for 30 days only. Attention: To check the authenticity of testing/inspection report & certificate, please contact us at telephone: (86-755) 8307 1443, or email: CN.Doccheck@sgs.com

Fuyong Lab, Xinlong TechnoPark, Fengtang Road, Fuyong Subdistrict, Bao'an, Shenzhen, China 518103 t (86-755) 88663988 f (86-755) 26710594 www.sgs.com.cn  
 中国·深圳·宝安区福永街道凤塘大道鑫龙科技园福永实验室 邮编: 518103 t (86-755) 88663988 f (86-755) 26710594 sgs.china@sgs.com

## Compliance Certification Services (Kunshan) Inc. Shenzhen Branch

SZCCS-TRF-01 Rev. A/0 Aug01,2022

Report No.: FYCR221200049005

Page: 86 of 115

### Radar Type 6 - Trial 0

Trial List									
	Download	Trial Id	Radar Type	Pulse Width (us)	PRI (us)	Pulses per Hop	Hopping Rate (kHz)	Hopping Sequence Length (ms)	Visible Frequency Number
<input type="checkbox"/>	Download	0	Type 6	1.0	333.3	9	0.3333	300.0000000	21
			<b>Frequency List (MHz)</b>	<b>0</b>	<b>1</b>	<b>2</b>	<b>3</b>	<b>4</b>	
			0	5364	5717	5334	5705	5549	
			5	5312	5260	5635	5503	5570	
			10	5347	5508	5292	5447	5588	
			15	5621	5638	5296	5482	5455	
			20	5636	5593	5434	5306	5411	
			25	5556	5378	5478	5432	5341	
			30	5438	5294	5496	5285	5327	
			35	5293	5502	5277	5403	5330	
			40	5612	5720	5544	5615	5561	
			45	5676	5704	5366	5290	5387	
			50	5278	5723	5383	5368	5263	
			55	5630	5375	5718	5281	5604	
			60	5453	5509	5479	5400	5262	
			65	5354	5467	5545	5466	5611	
			70	5715	5402	5568	5641	5396	
			75	5567	5557	5674	5359	5392	
			80	5313	5537	5258	5475	5272	
			85	5388	5474	5555	5410	5355	
			90	5517	5382	5386	5664	5697	
			95	5721	5268	5489	5706	5525	
<input type="checkbox"/>	Download	1	Type 6	1.0	333.3	9	0.3333	300.0000000	16
			<b>Frequency List (MHz)</b>	<b>0</b>	<b>1</b>	<b>2</b>	<b>3</b>	<b>4</b>	
			0	5619	5578	5270	5294	5354	
			5	5660	5710	5666	5399	5656	
			10	5297	5333	5642	5609	5709	
			15	5668	5527	5647	5547	5284	
			20	5375	5395	5384	5444	5705	
			25	5584	5536	5480	5658	5453	



Unless otherwise agreed in writing, this document is issued by the Company subject to its General Conditions of Service printed overleaf, available on request or accessible at <http://www.sgs.com/en/Terms-and-Conditions.aspx> and, for electronic format documents, subject to Terms and Conditions for Electronic Documents at <http://www.sgs.com/en/Terms-and-Conditions/Terms-e-Documents.aspx>. Attention is drawn to the limitation of liability, indemnification and jurisdiction issues defined therein. Any holder of this document is advised that information contained hereon reflects the Company's findings at the time of its intervention only and within the limits of Client's instructions, if any. The Company's sole responsibility is to its Client and this document does not exonerate parties to a transaction from exercising all their rights and obligations under the transaction documents. This document cannot be reproduced except in full, without prior written approval of the Company. Any unauthorized alteration, forgery or falsification of the content or appearance of this document is unlawful and offenders may be prosecuted to the fullest extent of the law. Unless otherwise stated the results shown in this test report refer only to the sample(s) tested and such sample(s) are retained for 30 days only.  
**Attention: To check the authenticity of testing /inspection report & certificate, please contact us at telephone: (86-755) 8307 1443, or email: CN.Doccheck@sgs.com**

Compliance Certification Services (Kunshan) Inc. Shenzhen Branch

Fuyong lab, Xinlong TechnoPark, Fengtang Road, Fuyong Subdistrict, Bao'an, Shenzhen, China 518103 t (86-755) 88663988 f (86-755) 26710594 www.sgs.com.cn  
 中国·深圳·宝安区福永街道凤塘大道鑫龙科技园福永实验室 邮编: 518103 t (86-755) 88663988 f (86-755) 26710594 sgs.china@sgs.com

## Compliance Certification Services (Kunshan) Inc. Shenzhen Branch

SZCCS-TRF-01 Rev. A/0 Aug01,2022

Report No.: FYCR221200049005

Page: 87 of 115

### Radar Type 6 - Trial 1

Trial List									
	Download	Trial Id	Radar Type	Pulse Width (us)	PRI (us)	Pulses per Hop	Hopping Rate (kHz)	Hopping Sequence Length (ms)	Visible Frequency Number
<input type="checkbox"/>	Download	1	Type 6	1.0	333.3	9	0.3333	300.0000000	16
			<b>Frequency List (MHz)</b>	<b>0</b>	<b>1</b>	<b>2</b>	<b>3</b>	<b>4</b>	
			0	5619	5578	5270	5294	5354	
			5	5660	5710	5666	5399	5656	
			10	5297	5333	5642	5609	5709	
			15	5668	5527	5647	5547	5284	
			20	5375	5395	5384	5444	5705	
			25	5584	5536	5480	5658	5453	
			30	5403	5576	5588	5641	5465	
			35	5674	5580	5623	5559	5627	
			40	5553	5704	5673	5633	5724	
			45	5373	5348	5331	5513	5637	
			50	5544	5314	5585	5697	5257	
			55	5672	5471	5423	5424	5638	
			60	5644	5345	5569	5655	5413	
			65	5271	5415	5550	5371	5335	
			70	5382	5416	5533	5706	5558	
			75	5535	5692	5256	5436	5716	
			80	5385	5669	5458	5349	5456	
			85	5336	5634	5703	5352	5280	
			90	5506	5313	5690	5326	5631	
			95	5628	5546	5289	5490	5590	
<input type="checkbox"/>	Download	2	Type 6	1.0	333.3	9	0.3333	300.0000000	18
			<b>Frequency List (MHz)</b>	<b>0</b>	<b>1</b>	<b>2</b>	<b>3</b>	<b>4</b>	
			0	5302	5342	5681	5455	5611	
			5	5493	5682	5310	5257	5606	
			10	5587	5561	5374	5362	5630	
			15	5322	5320	5502	5475	5364	
			20	5555	5353	5316	5387	5357	



Unless otherwise agreed in writing, this document is issued by the Company subject to its General Conditions of Service printed overleaf, available on request or accessible at <http://www.sgs.com/en/Terms-and-Conditions.aspx> and, for electronic format documents, subject to Terms and Conditions for Electronic Documents at <http://www.sgs.com/en/Terms-and-Conditions/Terms-e-Documents.aspx>. Attention is drawn to the limitation of liability, indemnification and jurisdiction issues defined therein. Any holder of this document is advised that information contained hereon reflects the Company's findings at the time of its intervention only and within the limits of Client's instructions, if any. The Company's sole responsibility is to its Client and this document does not exonerate parties to a transaction from exercising all their rights and obligations under the transaction documents. This document cannot be reproduced except in full, without prior written approval of the Company. Any unauthorized alteration, forgery or falsification of the content or appearance of this document is unlawful and offenders may be prosecuted to the fullest extent of the law. Unless otherwise stated the results shown in this test report refer only to the sample(s) tested and such sample(s) are retained for 30 days only. Attention: To check the authenticity of testing /inspection report & certificate, please contact us at telephone: (86-755) 8307 1443, or email: CN.Doccheck@sgs.com

Compliance Certification Services (Kunshan) Inc. Shenzhen Branch

Fuyong lab, Xinlong TechnoPark, Fengtang Road, Fuyong Subdistrict, Bao'an, Shenzhen, China 518103 t (86-755) 88663988 f (86-755) 26710594 www.sgs.com.cn  
 中国·深圳·宝安区福永街道凤塘大道鑫龙科技园福永实验室 邮编: 518103 t (86-755) 88663988 f (86-755) 26710594 sgs.china@sgs.com

## Compliance Certification Services (Kunshan) Inc. Shenzhen Branch

SZCCS-TRF-01 Rev. A/0 Aug01,2022

Report No.: FYCR221200049005

Page: 88 of 115

### Radar Type 6 - Trial 2

Trial List									
		Trial Id	Radar Type	Pulse Width (us)	PRI (us)	Pulses per Hop	Hopping Rate (kHz)	Hopping Sequence Length (ms)	Visible Frequency Number
<input type="checkbox"/>	Download	2	Type 6	1.0	333.3	9	0.3333	300.0000000	18
			<b>Frequency List (MHz)</b>	<b>0</b>	<b>1</b>	<b>2</b>	<b>3</b>	<b>4</b>	
			0	5302	5342	5681	5455	5611	
			5	5493	5682	5310	5257	5606	
			10	5587	5561	5374	5362	5630	
			15	5322	5320	5502	5475	5364	
			20	5555	5353	5316	5387	5357	
			25	5332	5654	5312	5262	5409	
			30	5522	5547	5410	5618	5253	
			35	5311	5683	5556	5470	5258	
			40	5537	5398	5710	5491	5469	
			45	5670	5465	5704	5456	5406	
			50	5384	5400	5513	5720	5365	
			55	5296	5276	5641	5445	5626	
			60	5564	5620	5395	5334	5290	
			65	5401	5578	5359	5569	5586	
			70	5282	5649	5407	5368	5647	
			75	5643	5509	5592	5675	5678	
			80	5581	5275	5381	5512	5600	
			85	5304	5382	5389	5458	5666	
			90	5419	5642	5350	5526	5519	
			95	5709	5692	5418	5653	5354	
<input type="checkbox"/>	Download	3	Type 6	1.0	333.3	9	0.3333	300.0000000	22
<input type="checkbox"/>	Download	4	Type 6	1.0	333.3	9	0.3333	300.0000000	21
<input type="checkbox"/>	Download	5	Type 6	1.0	333.3	9	0.3333	300.0000000	19
<input type="checkbox"/>	Download	6	Type 6	1.0	333.3	9	0.3333	300.0000000	17
<input type="checkbox"/>	Download	7	Type 6	1.0	333.3	9	0.3333	300.0000000	17
<input type="checkbox"/>	Download	8	Type 6	1.0	333.3	9	0.3333	300.0000000	27



Unless otherwise agreed in writing, this document is issued by the Company subject to its General Conditions of Service printed overleaf, available on request or accessible at <http://www.sgs.com/en/Terms-and-Conditions.aspx> and, for electronic format documents, subject to Terms and Conditions for Electronic Documents at <http://www.sgs.com/en/Terms-and-Conditions/Terms-e-Documents.aspx>. Attention is drawn to the limitation of liability, indemnification and jurisdiction issues defined therein. Any holder of this document is advised that information contained hereon reflects the Company's findings at the time of its intervention only and within the limits of Client's instructions, if any. The Company's sole responsibility is to its Client and this document does not exonerate parties to a transaction from exercising all their rights and obligations under the transaction documents. This document cannot be reproduced except in full, without prior written approval of the Company. Any unauthorized alteration, forgery or falsification of the content or appearance of this document is unlawful and offenders may be prosecuted to the fullest extent of the law. Unless otherwise stated the results shown in this test report refer only to the sample(s) tested and such sample(s) are retained for 30 days only.  
**Attention: To check the authenticity of testing /inspection report & certificate, please contact us at telephone: (86-755) 8307 1443, or email: CN.Doccheck@sgs.com**

Compliance Certification Services (Kunshan) Inc. Shenzhen Branch

Fuyong lab, Xinlong TechnoPark, Fengtang Road, Fuyong Subdistrict, Bao'an, Shenzhen, China 518103 t (86-755) 88663988 f (86-755) 26710594 www.sgs.com.cn  
 中国·深圳·宝安区福永街道凤塘大道鑫龙科技园福永实验室 邮编: 518103 t (86-755) 88663988 f (86-755) 26710594 sgs.china@sgs.com



## Compliance Certification Services (Kunshan) Inc. Shenzhen Branch

SZCCS-TRF-01 Rev. A/0 Aug01,2022

Report No.: FYCR221200049005

Page: 89 of 115

### Radar Type 6 - Trial 3

Trial List									
	Trial Id	Radar Type	Pulse Width (us)	PRI (us)	Pulses per Hop	Hopping Rate (kHz)	Hopping Sequence Length (ms)	Visible Frequency Number	
<input type="checkbox"/>	Download	3	Type 6	1.0	333.3	9	0.3333	300.0000000	22
			<b>Frequency List (MHz)</b>	<b>0</b>	<b>1</b>	<b>2</b>	<b>3</b>	<b>4</b>	
			0	5557	5581	5617	5616	5356	
			5	5535	5704	5385	5420	5338	
			10	5518	5350	5415	5651	5313	
			15	5447	5605	5520	5653	5563	
			20	5519	5257	5476	5330	5598	
			25	5506	5515	5366	5443	5661	
			30	5533	5367	5358	5502	5606	
			35	5347	5647	5266	5411	5451	
			40	5334	5332	5709	5667	5394	
			45	5684	5539	5464	5437	5665	
			50	5389	5421	5416	5574	5488	
			55	5536	5580	5279	5439	5324	
			60	5499	5710	5708	5404	5305	
			65	5295	5525	5589	5359	5452	
			70	5576	5272	5492	5388	5551	
			75	5547	5323	5724	5256	5721	
			80	5293	5379	5584	5361	5508	
			85	5479	5693	5341	5655	5715	
			90	5629	5494	5401	5637	5423	
			95	5280	5316	5662	5281	5649	
<input type="checkbox"/>	Download	4	Type 6	1.0	333.3	9	0.3333	300.0000000	21
			<b>Frequency List (MHz)</b>	<b>0</b>	<b>1</b>	<b>2</b>	<b>3</b>	<b>4</b>	
			0	5337	5345	5553	5302	5673	
			5	5577	5629	5460	5583	5642	
			10	5352	5614	5456	5655	5672	
			15	5401	5574	5611	5565	5370	
			20	5571	5588	5295	5468	5303	
			25	5496	5358	5718	5470	5380	



Unless otherwise agreed in writing, this document is issued by the Company subject to its General Conditions of Service printed overleaf, available on request or accessible at <http://www.sgs.com/en/Terms-and-Conditions.aspx> and, for electronic format documents, subject to Terms and Conditions for Electronic Documents at <http://www.sgs.com/en/Terms-and-Conditions/Terms-e-Documents.aspx>. Attention is drawn to the limitation of liability, indemnification and jurisdiction issues defined therein. Any holder of this document is advised that information contained hereon reflects the Company's findings at the time of its intervention only and within the limits of Client's instructions, if any. The Company's sole responsibility is to its Client and this document does not exonerate parties to a transaction from exercising all their rights and obligations under the transaction documents. This document cannot be reproduced except in full, without prior written approval of the Company. Any unauthorized alteration, forgery or falsification of the content or appearance of this document is unlawful and offenders may be prosecuted to the fullest extent of the law. Unless otherwise stated the results shown in this test report refer only to the sample(s) tested and such sample(s) are retained for 30 days only. Attention: To check the authenticity of testing/inspection report & certificate, please contact us at telephone: (86-755) 8307 1443, or email: CN.Doccheck@sgs.com

Compliance Certification Services (Kunshan) Inc. Shenzhen Branch

Fuyong Lab, Xinlong TechnoPark, Fengtang Road, Fuyong Subdistrict, Bao'an, Shenzhen, China 518103 t (86-755) 88663988 f (86-755) 26710594 www.sgs.com.cn  
 中国·深圳·宝安区福永街道凤塘大道鑫龙科技园福永实验室 邮编: 518103 t (86-755) 88663988 f (86-755) 26710594 sgs.china@sgs.com

# Compliance Certification Services (Kunshan) Inc. Shenzhen Branch

SZCCS-TRF-01 Rev. A/0 Aug01,2022

Report No.: FYCR221200049005

Page: 90 of 115

## Radar Type 6 - Trial 4

Trial List									
	Trial Id	Radar Type	Pulse Width (us)	PRI (us)	Pulses per Hop	Hopping Rate (kHz)	Hopping Sequence Length (ms)	Visible Frequency Number	
<input type="checkbox"/>	Download	4	Type 6	1.0	333.3	9	0.3333	300.0000000	21
			<b>Frequency List (MHz)</b>	<b>0</b>	<b>1</b>	<b>2</b>	<b>3</b>	<b>4</b>	
			0	5337	5345	5553	5302	5673	
			5	5577	5629	5460	5583	5642	
			10	5352	5614	5456	5655	5672	
			15	5401	5574	5611	5565	5370	
			20	5571	5588	5295	5468	5303	
			25	5486	5358	5718	5470	5380	
			30	5703	5422	5324	5573	5654	
			35	5426	5263	5634	5661	5462	
			40	5648	5498	5270	5474	5664	
			45	5701	5622	5425	5490	5552	
			50	5265	5597	5467	5300	5432	
			55	5724	5437	5489	5258	5715	
			60	5453	5277	5637	5705	5348	
			65	5593	5262	5561	5251	5255	
			70	5275	5341	5364	5510	5516	
			75	5346	5712	5504	5549	5356	
			80	5527	5376	5264	5447	5442	
			85	5454	5658	5428	5544	5374	
			90	5343	5663	5478	5689	5384	
			95	5372	5707	5274	5292	5466	
<input type="checkbox"/>	Download	5	Type 6	1.0	333.3	9	0.3333	300.0000000	19
			<b>Frequency List (MHz)</b>	<b>0</b>	<b>1</b>	<b>2</b>	<b>3</b>	<b>4</b>	
			0	5592	5584	5489	5463	5418	
			5	5619	5651	5535	5271	5374	
			10	5283	5500	5594	5375	5693	
			15	5604	5714	5610	5562	5482	



Unless otherwise agreed in writing, this document is issued by the Company subject to its General Conditions of Service printed overleaf, available on request or accessible at <http://www.sgs.com/en/Terms-and-Conditions.aspx> and, for electronic format documents, subject to Terms and Conditions for Electronic Documents at <http://www.sgs.com/en/Terms-and-Conditions/Terms-e-Documents.aspx>. Attention is drawn to the limitation of liability, indemnification and jurisdiction issues defined therein. Any holder of this document is advised that information contained hereon reflects the Company's findings at the time of its intervention only and within the limits of Client's instructions, if any. The Company's sole responsibility is to its Client and this document does not exonerate parties to a transaction from exercising all their rights and obligations under the transaction documents. This document cannot be reproduced except in full, without prior written approval of the Company. Any unauthorized alteration, forgery or falsification of the content or appearance of this document is unlawful and offenders may be prosecuted to the fullest extent of the law. Unless otherwise stated the results shown in this test report refer only to the sample(s) tested and such sample(s) are retained for 30 days only.  
**Attention: To check the authenticity of testing /inspection report & certificate, please contact us at telephone: (86-755) 8307 1443, or email: CN.Doccheck@sgs.com**

Compliance Certification Services (Kunshan) Inc. Shenzhen Branch

Fuyong lab, Xinlong TechnoPark, Fengtang Road, Fuyong Subdistrict, Bao'an, Shenzhen, China 518103 t (86-755) 88663988 f (86-755) 26710594 www.sgs.com.cn  
 中国·深圳·宝安区福永街道凤塘大道鑫科技园福永实验室 邮编: 518103 t (86-755) 88663988 f (86-755) 26710594 sgs.china@sgs.com

## Compliance Certification Services (Kunshan) Inc. Shenzhen Branch

SZCCS-TRF-01 Rev. A/0 Aug01,2022

Report No.: FYCR221200049005

Page: 91 of 115

### Radar Type 6 - Trial 5

Trial List									
		Trial Id	Radar Type	Pulse Width (us)	PRI (us)	Pulses per Hop	Hopping Rate (kHz)	Hopping Sequence Length (ms)	Visible Frequency Number
<input type="checkbox"/>	Download	5	Type 6	1.0	333.3	9	0.3333	300.0000000	19
			<b>Frequency List (MHz)</b>	<b>0</b>	<b>1</b>	<b>2</b>	<b>3</b>	<b>4</b>	
			0	5592	5584	5489	5463	5418	
			5	5619	5651	5535	5271	5374	
			10	5283	5500	5594	5375	5693	
			15	5604	5714	5610	5562	5482	
			20	5279	5711	5557	5276	5277	
			25	5307	5446	5574	5414	5270	
			30	5408	5281	5691	5428	5624	
			35	5625	5354	5430	5339	5376	
			40	5487	5581	5683	5617	5630	
			45	5644	5705	5483	5342	5519	
			50	5298	5518	5563	5598	5437	
			55	5391	5659	5455	5686	5582	
			60	5697	5469	5628	5294	5319	
			65	5597	5631	5521	5436	5423	
			70	5278	5665	5340	5485	5466	
			75	5438	5315	5275	5614	5330	
			80	5520	5590	5596	5264	5289	
			85	5405	5646	5526	5346	5676	
			90	5267	5539	5349	5600	5258	
			95	5671	5533	5345	5587	5523	
<input type="checkbox"/>	Download	6	Type 6	1.0	333.3	9	0.3333	300.0000000	17
			<b>Frequency List (MHz)</b>	<b>0</b>	<b>1</b>	<b>2</b>	<b>3</b>	<b>4</b>	
			0	5372	5348	5425	5624	5260	
			5	5283	5576	5610	5434	5581	
			10	5689	5289	5635	5570	5714	



Unless otherwise agreed in writing, this document is issued by the Company subject to its General Conditions of Service printed overleaf, available on request or accessible at <http://www.sgs.com/en/Terms-and-Conditions.aspx> and, for electronic format documents, subject to Terms and Conditions for Electronic Documents at <http://www.sgs.com/en/Terms-and-Conditions/Terms-e-Documents.aspx>. Attention is drawn to the limitation of liability, indemnification and jurisdiction issues defined therein. Any holder of this document is advised that information contained hereon reflects the Company's findings at the time of its intervention only and within the limits of Client's instructions, if any. The Company's sole responsibility is to its Client and this document does not exonerate parties to a transaction from exercising all their rights and obligations under the transaction documents. This document cannot be reproduced except in full, without prior written approval of the Company. Any unauthorized alteration, forgery or falsification of the content or appearance of this document is unlawful and offenders may be prosecuted to the fullest extent of the law. Unless otherwise stated the results shown in this test report refer only to the sample(s) tested and such sample(s) are retained for 30 days only. **Attention: To check the authenticity of testing /inspection report & certificate, please contact us at telephone: (86-755) 8307 1443, or email: CN.Doccheck@sgs.com**

Compliance Certification Services (Kunshan) Inc. Shenzhen Branch

Fuyong lab, Xinlong TechnoPark, Fengtang Road, Fuyong Subdistrict, Bao'an, Shenzhen, China 518103 t (86-755) 88663988 f (86-755) 26710594 www.sgs.com.cn  
 中国·深圳·宝安区福永街道凤塘大道鑫龙科技园福永实验室 邮编: 518103 t (86-755) 88663988 f (86-755) 26710594 sgs.china@sgs.com

## Compliance Certification Services (Kunshan) Inc. Shenzhen Branch

SZCCS-TRF-01 Rev. A/0 Aug01,2022

Report No.: FYCR221200049005

Page: 92 of 115

### Radar Type 6 - Trial 6

Trial List									
		Trial Id	Radar Type	Pulse Width (us)	PRI (us)	Pulses per Hop	Hopping Rate (kHz)	Hopping Sequence Length (ms)	Visible Frequency Number
<input type="checkbox"/>	Download	6	Type 6	1.0	333.3	9	0.3333	300.0000000	17
			<b>Frequency List (MHz)</b>	<b>0</b>	<b>1</b>	<b>2</b>	<b>3</b>	<b>4</b>	
			0	5372	5348	5425	5624	5260	
			5	5283	5576	5610	5434	5581	
			10	5689	5289	5635	5570	5714	
			15	5577	5256	5342	5558	5279	
			20	5490	5652	5549	5724	5640	
			25	5634	5552	5300	5448	5409	
			30	5297	5713	5431	5580	5444	
			35	5667	5445	5701	5492	5290	
			40	5326	5286	5621	5382	5280	
			45	5559	5313	5541	5499	5704	
			50	5395	5474	5569	5274	5421	
			55	5698	5625	5345	5374	5657	
			60	5711	5519	5642	5301	5454	
			65	5715	5520	5536	5366	5413	
			70	5414	5378	5417	5316	5428	
			75	5357	5586	5484	5296	5430	
			80	5627	5684	5653	5273	5606	
			85	5465	5363	5491	5352	5355	
			90	5518	5631	5688	5588	5329	
			95	5485	5502	5590	5390	5531	
<input type="checkbox"/>	Download	7	Type 6	1.0	333.3	9	0.3333	300.0000000	17
			<b>Frequency List (MHz)</b>	<b>0</b>	<b>1</b>	<b>2</b>	<b>3</b>	<b>4</b>	
			0	5530	5587	5361	5310	5480	
			5	5325	5598	5685	5500	5410	
			10	5523	5553	5676	5290	5260	



Unless otherwise agreed in writing, this document is issued by the Company subject to its General Conditions of Service printed overleaf, available on request or accessible at <http://www.sgs.com/en/Terms-and-Conditions.aspx> and, for electronic format documents, subject to Terms and Conditions for Electronic Documents at <http://www.sgs.com/en/Terms-and-Conditions/Terms-e-Documents.aspx>. Attention is drawn to the limitation of liability, indemnification and jurisdiction issues defined therein. Any holder of this document is advised that information contained hereon reflects the Company's findings at the time of its intervention only and within the limits of Client's instructions, if any. The Company's sole responsibility is to its Client and this document does not exonerate parties to a transaction from exercising all their rights and obligations under the transaction documents. This document cannot be reproduced except in full, without prior written approval of the Company. Any unauthorized alteration, forgery or falsification of the content or appearance of this document is unlawful and offenders may be prosecuted to the fullest extent of the law. Unless otherwise stated the results shown in this test report refer only to the sample(s) tested and such sample(s) are retained for 30 days only. **Attention: To check the authenticity of testing /inspection report & certificate, please contact us at telephone: (86-755) 8307 1443, or email: CN.Doccheck@sgs.com**

Compliance Certification Services (Kunshan) Inc. Shenzhen Branch

Fuyong lab, Xinlong TechnoPark, Fengtang Road, Fuyong Subdistrict, Bao'an, Shenzhen, China 518103 t (86-755) 88663988 f (86-755) 26710594 www.sgs.com.cn  
 中国·深圳·宝安区福永街道凤塘大道鑫龙科技园福永实验室 邮编: 518103 t (86-755) 88663988 f (86-755) 26710594 sgs.china@sgs.com

## Compliance Certification Services (Kunshan) Inc. Shenzhen Branch

SZCCS-TRF-01 Rev. A/0 Aug01,2022

Report No.: FYCR221200049005

Page: 93 of 115

### Radar Type 6 - Trial 7

Trial List									
	Trial Id	Radar Type	Pulse Width (us)	PRI (us)	Pulses per Hop	Hopping Rate (kHz)	Hopping Sequence Length (ms)	Visible Frequency Number	
<input type="checkbox"/>	Download	7	Type 6	1.0	333.3	9	0.3333	300.0000000	17
			<b>Frequency List (MHz)</b>	<b>0</b>	<b>1</b>	<b>2</b>	<b>3</b>	<b>4</b>	
			0	5530	5587	5361	5310	5480	
			5	5325	5598	5685	5500	5410	
			10	5523	5553	5676	5290	5260	
			15	5568	5383	5445	5603	5471	
			20	5498	5514	5690	5638	5697	
			25	5431	5583	5280	5404	5482	
			30	5451	5661	5670	5646	5354	
			35	5642	5331	5633	5594	5267	
			40	5301	5640	5369	5559	5622	
			45	5277	5391	5507	5396	5502	
			50	5552	5494	5271	5650	5620	
			55	5363	5719	5545	5338	5299	
			60	5564	5628	5268	5684	5608	
			65	5283	5343	5584	5572	5673	
			70	5683	5517	5492	5381	5266	
			75	5292	5387	5326	5706	5627	
			80	5682	5282	5367	5276	5716	
			85	5270	5511	5428	5458	5359	
			90	5351	5600	5285	5394	5571	
			95	5400	5285	5327	5643	5313	
<input type="checkbox"/>	Download	8	Type 6	1.0	333.3	9	0.3333	300.0000000	27
			<b>Frequency List (MHz)</b>	<b>0</b>	<b>1</b>	<b>2</b>	<b>3</b>	<b>4</b>	
			0	5310	5351	5297	5374	5322	
			5	5367	5523	5285	5663	5617	
			10	5454	5342	5717	5485	5281	



Unless otherwise agreed in writing, this document is issued by the Company subject to its General Conditions of Service printed overleaf, available on request or accessible at <http://www.sgs.com/en/Terms-and-Conditions.aspx> and, for electronic format documents, subject to Terms and Conditions for Electronic Documents at <http://www.sgs.com/en/Terms-and-Conditions/Terms-e-Documents.aspx>. Attention is drawn to the limitation of liability, indemnification and jurisdiction issues defined therein. Any holder of this document is advised that information contained hereon reflects the Company's findings at the time of its intervention only and within the limits of Client's instructions, if any. The Company's sole responsibility is to its Client and this document does not exonerate parties to a transaction from exercising all their rights and obligations under the transaction documents. This document cannot be reproduced except in full, without prior written approval of the Company. Any unauthorized alteration, forgery or falsification of the content or appearance of this document is unlawful and offenders may be prosecuted to the fullest extent of the law. Unless otherwise stated the results shown in this test report refer only to the sample(s) tested and such sample(s) are retained for 30 days only. Attention: To check the authenticity of testing /inspection report & certificate, please contact us at telephone: (86-755) 8307 1443, or email: CN.Doccheck@sgs.com

Compliance Certification Services (Kunshan) Inc. Shenzhen Branch

Fuyong lab, Xinlong TechnoPark, Fengtang Road, Fuyong Subdistrict, Bao'an, Shenzhen, China 518103 t (86-755) 88663988 f (86-755) 26710594 www.sgs.com.cn  
 中国·深圳·宝安区福永街道凤塘大道鑫龙科技园福永实验室 邮编: 518103 t (86-755) 88663988 f (86-755) 26710594 sgs.china@sgs.com

## Compliance Certification Services (Kunshan) Inc. Shenzhen Branch

SZCCS-TRF-01 Rev. A/0 Aug01,2022

Report No.: FYCR221200049005

Page: 94 of 115

### Radar Type 6 - Trial 8

Trial List									
		Trial Id	Radar Type	Pulse Width (us)	PRI (us)	Pulses per Hop	Hopping Rate (kHz)	Hopping Sequence Length (ms)	Visible Frequency Number
<input type="checkbox"/>	Download	8	Type 6	1.0	333.3	9	0.3333	300.0000000	27
			<b>Frequency List (MHz)</b>	<b>0</b>	<b>1</b>	<b>2</b>	<b>3</b>	<b>4</b>	
			0	5310	5351	5297	5374	5322	
			5	5367	5523	5285	5663	5617	
			10	5454	5342	5717	5485	5281	
			15	5656	5510	5548	5648	5409	
			20	5680	5631	5630	5670	5319	
			25	5435	5483	5508	5516	5493	
			30	5647	5627	5386	5506	5462	
			35	5470	5724	5390	5420	5690	
			40	5576	5452	5497	5387	5274	
			45	5320	5487	5479	5560	5605	
			50	5381	5622	5671	5445	5489	
			55	5526	5253	5279	5502	5397	
			60	5629	5440	5678	5704	5544	
			65	5533	5608	5408	5478	5655	
			70	5481	5590	5268	5346	5673	
			75	5254	5295	5258	5459	5372	
			80	5623	5401	5267	5706	5545	
			85	5488	5650	5324	5305	5373	
			90	5559	5464	5660	5344	5698	
			95	5394	5378	5363	5321	5311	
<input type="checkbox"/>	Download	9	Type 6	1.0	333.3	9	0.3333	300.0000000	20
			<b>Frequency List (MHz)</b>	<b>0</b>	<b>1</b>	<b>2</b>	<b>3</b>	<b>4</b>	
			0	5565	5590	5708	5535	5542	
			5	5409	5545	5360	5351	5349	
			10	5288	5606	5283	5583	5302	
			15	5269	5637	5554	5693	5380	
			20	5417	5274	5572	5719	5643	



Unless otherwise agreed in writing, this document is issued by the Company subject to its General Conditions of Service printed overleaf, available on request or accessible at <http://www.sgs.com/en/Terms-and-Conditions.aspx> and, for electronic format documents, subject to Terms and Conditions for Electronic Documents at <http://www.sgs.com/en/Terms-and-Conditions/Terms-e-Documents.aspx>. Attention is drawn to the limitation of liability, indemnification and jurisdiction issues defined therein. Any holder of this document is advised that information contained hereon reflects the Company's findings at the time of its intervention only and within the limits of Client's instructions, if any. The Company's sole responsibility is to its Client and this document does not exonerate parties to a transaction from exercising all their rights and obligations under the transaction documents. This document cannot be reproduced except in full, without prior written approval of the Company. Any unauthorized alteration, forgery or falsification of the content or appearance of this document is unlawful and offenders may be prosecuted to the fullest extent of the law. Unless otherwise stated the results shown in this test report refer only to the sample(s) tested and such sample(s) are retained for 30 days only. Attention: To check the authenticity of testing/inspection report & certificate, please contact us at telephone: (86-755) 8307 1443, or email: CN.Doccheck@sgs.com

Compliance Certification Services (Kunshan) Inc. Shenzhen Branch

Fuyong lab, Xinlong TechnoPark, Fengtang Road, Fuyong Subdistrict, Bao'an, Shenzhen, China 518103 t (86-755) 88663988 f (86-755) 26710594 www.sgsgroup.com.cn  
 中国·深圳·宝安区福永街道凤塘大道鑫龙科技园福永实验室 邮编: 518103 t (86-755) 88663988 f (86-755) 26710594 sgs.china@sgs.com

## Compliance Certification Services (Kunshan) Inc. Shenzhen Branch

SZCCS-TRF-01 Rev. A/0 Aug01,2022

Report No.: FYCR221200049005

Page: 95 of 115

### Radar Type 6 - Trial 9

Trial List									
	Download	Trial Id	Radar Type	Pulse Width (us)	PRI (us)	Pulses per Hop	Hopping Rate (kHz)	Hopping Sequence Length (ms)	Visible Frequency Number
<input type="checkbox"/>	Download	9	Type 6	1.0	333.3	9	0.3333	300.0000000	20
			<b>Frequency List (MHz)</b>	<b>0</b>	<b>1</b>	<b>2</b>	<b>3</b>	<b>4</b>	
			0	5565	5590	5708	5535	5542	
			5	5409	5545	5360	5351	5349	
			10	5288	5606	5283	5583	5302	
			15	5269	5637	5554	5693	5380	
			20	5417	5274	5572	5719	5643	
			25	5682	5287	5686	5612	5550	
			30	5632	5536	5584	5504	5280	
			35	5660	5512	5340	5661	5573	
			40	5604	5415	5435	5530	5271	
			45	5627	5467	5562	5618	5658	
			50	5646	5401	5527	5722	5541	
			55	5268	5336	5714	5372	5473	
			60	5526	5539	5574	5369	5650	
			65	5367	5482	5547	5715	5370	
			70	5598	5252	5464	5484	5439	
			75	5622	5305	5642	5374	5341	
			80	5711	5385	5404	5264	5523	
			85	5448	5326	5451	5270	5667	
			90	5356	5621	5303	5724	5470	
			95	5639	5386	5361	5278	5378	
<input type="checkbox"/>	Download	10	Type 6	1.0	333.3	9	0.3333	300.0000000	20
			<b>Frequency List (MHz)</b>	<b>0</b>	<b>1</b>	<b>2</b>	<b>3</b>	<b>4</b>	
			0	5345	5354	5644	5696	5384	
			5	5548	5470	5435	5514	5653	
			10	5694	5492	5324	5303	5323	
			15	5357	5667	5657	5641	5572	



Unless otherwise agreed in writing, this document is issued by the Company subject to its General Conditions of Service printed overleaf, available on request or accessible at <http://www.sgs.com/en/Terms-and-Conditions.aspx> and, for electronic format documents, subject to Terms and Conditions for Electronic Documents at <http://www.sgs.com/en/Terms-and-Conditions/Terms-e-Documents.aspx>. Attention is drawn to the limitation of liability, indemnification and jurisdiction issues defined therein. Any holder of this document is advised that information contained hereon reflects the Company's findings at the time of its intervention only and within the limits of Client's instructions, if any. The Company's sole responsibility is to its Client and this document does not exonerate parties to a transaction from exercising all their rights and obligations under the transaction documents. This document cannot be reproduced except in full, without prior written approval of the Company. Any unauthorized alteration, forgery or falsification of the content or appearance of this document is unlawful and offenders may be prosecuted to the fullest extent of the law. Unless otherwise stated the results shown in this test report refer only to the sample(s) tested and such sample(s) are retained for 30 days only. Attention: To check the authenticity of testing /inspection report & certificate, please contact us at telephone: (86-755) 8307 1443, or email: CN.Doccheck@sgs.com

Compliance Certification Services (Kunshan) Inc. Shenzhen Branch

Fuyong lab, Xinlong TechnoPark, Fengtang Road, Fuyong Subdistrict, Bao'an, Shenzhen, China 518103 t (86-755) 88663988 f (86-755) 26710594 www.sgs.com.cn  
 中国·深圳·宝安区福永街道凤塘大道鑫科技园福永实验室 邮编: 518103 t (86-755) 88663988 f (86-755) 26710594 sgs.china@sgs.com

## Compliance Certification Services (Kunshan) Inc. Shenzhen Branch

SZCCS-TRF-01 Rev. A/0 Aug01,2022

Report No.: FYCR221200049005

Page: 96 of 115

### Radar Type 6 - Trial 10

Trial List									
	Download	Trial Id	Radar Type	Pulse Width (us)	PRI (us)	Pulses per Hop	Hopping Rate (kHz)	Hopping Sequence Length (ms)	Visible Frequency Number
<input type="checkbox"/>	Download	10	Type 6	1.0	333.3	9	0.3333	300.0000000	20
			<b>Frequency List (MHz)</b>	<b>0</b>	<b>1</b>	<b>2</b>	<b>3</b>	<b>4</b>	
			0	5345	5354	5644	5696	5384	
			5	5548	5470	5435	5514	5653	
			10	5694	5492	5324	5303	5323	
			15	5357	5667	5657	5641	5572	
			20	5425	5440	5610	5711	5616	
			25	5473	5414	5338	5584	5674	
			30	5541	5719	5432	5480	5651	
			35	5431	5457	5348	5615	5254	
			40	5715	5373	5295	5365	5556	
			45	5447	5645	5579	5533	5277	
			50	5703	5298	5252	5566	5280	
			55	5330	5636	5562	5403	5444	
			60	5655	5704	5519	5676	5427	
			65	5596	5568	5583	5450	5640	
			70	5304	5421	5547	5288	5598	
			75	5264	5494	5484	5695	5488	
			80	5495	5660	5293	5527	5639	
			85	5718	5351	5643	5511	5462	
			90	5632	5310	5394	5501	5476	
			95	5576	5327	5378	5333	5362	
<input type="checkbox"/>	Download	11	Type 6	1.0	333.3	9	0.3333	300.0000000	26
			<b>Frequency List (MHz)</b>	<b>0</b>	<b>1</b>	<b>2</b>	<b>3</b>	<b>4</b>	
			0	5503	5593	5580	5382	5604	
			5	5590	5492	5510	5385	5625	
			10	5281	5365	5498	5344	5348	
			15	5319	5285	5686	5386	5336	



Unless otherwise agreed in writing, this document is issued by the Company subject to its General Conditions of Service printed overleaf, available on request or accessible at <http://www.sgs.com/en/Terms-and-Conditions.aspx> and, for electronic format documents, subject to Terms and Conditions for Electronic Documents at <http://www.sgs.com/en/Terms-and-Conditions/Terms-e-Documents.aspx>. Attention is drawn to the limitation of liability, indemnification and jurisdiction issues defined therein. Any holder of this document is advised that information contained hereon reflects the Company's findings at the time of its intervention only and within the limits of Client's instructions, if any. The Company's sole responsibility is to its Client and this document does not exonerate parties to a transaction from exercising all their rights and obligations under the transaction documents. This document cannot be reproduced except in full, without prior written approval of the Company. Any unauthorized alteration, forgery or falsification of the content or appearance of this document is unlawful and offenders may be prosecuted to the fullest extent of the law. Unless otherwise stated the results shown in this test report refer only to the sample(s) tested and such sample(s) are retained for 30 days only. Attention: To check the authenticity of testing /inspection report & certificate, please contact us at telephone: (86-755) 8307 1443, or email: CN.Doccheck@sgs.com

Compliance Certification Services (Kunshan) Inc. Shenzhen Branch

Fuyong lab, Xinlong TechnoPark, Fengtang Road, Fuyong Subdistrict, Bao'an, Shenzhen, China 518103 t (86-755) 88663988 f (86-755) 26710594 www.sgs.com.cn  
 中国·深圳·宝安区福永街道凤塘大道鑫龙科技园福永实验室 邮编: 518103 t (86-755) 88663988 f (86-755) 26710594 sgs.china@sgs.com



### Radar Type 6 - Trial 11

Trial List									
	Download	Trial Id	Radar Type	Pulse Width (us)	PRI (us)	Pulses per Hop	Hopping Rate (kHz)	Hopping Sequence Length (ms)	Visible Frequency Number
<input type="checkbox"/>	Download	11	Type 6	1.0	333.3	9	0.3333	300.0000000	26
			<b>Frequency List (MHz)</b>	<b>0</b>	<b>1</b>	<b>2</b>	<b>3</b>	<b>4</b>	
			0	5503	5593	5580	5382	5604	
			5	5590	5492	5510	5385	5625	
			10	5281	5365	5498	5344	5348	
			15	5319	5285	5686	5386	5336	
			20	5509	5551	5325	5589	5361	
			25	5563	5520	5442	5618	5716	
			30	5411	5459	5681	5300	5315	
			35	5522	5350	5501	5529	5568	
			40	5323	5689	5535	5362	5485	
			45	5427	5253	5637	5667	5628	
			50	5404	5349	5341	5389	5602	
			55	5518	5277	5697	5415	5309	
			60	5394	5464	5508	5639	5391	
			65	5380	5282	5532	5582	5493	
			70	5533	5587	5515	5574	5698	
			75	5483	5614	5530	5676	5265	
			80	5605	5441	5360	5636	5438	
			85	5351	5474	5654	5500	5642	
			90	5321	5579	5482	5610	5684	
			95	5388	5443	5547	5581	5527	
<input type="checkbox"/>	Download	12	Type 6	1.0	333.3	9	0.3333	300.0000000	21
			<b>Frequency List (MHz)</b>	<b>0</b>	<b>1</b>	<b>2</b>	<b>3</b>	<b>4</b>	
			0	5283	5357	5516	5543	5446	
			5	5632	5417	5585	5268	5592	
			10	5459	5545	5406	5693	5365	



Unless otherwise agreed in writing, this document is issued by the Company subject to its General Conditions of Service printed overleaf, available on request or accessible at <http://www.sgs.com/en/Terms-and-Conditions.aspx> and, for electronic format documents, subject to Terms and Conditions for Electronic Documents at <http://www.sgs.com/en/Terms-and-Conditions/Terms-e-Documents.aspx>. Attention is drawn to the limitation of liability, indemnification and jurisdiction issues defined therein. Any holder of this document is advised that information contained hereon reflects the Company's findings at the time of its intervention only and within the limits of Client's instructions, if any. The Company's sole responsibility is to its Client and this document does not exonerate parties to a transaction from exercising all their rights and obligations under the transaction documents. This document cannot be reproduced except in full, without prior written approval of the Company. Any unauthorized alteration, forgery or falsification of the content or appearance of this document is unlawful and offenders may be prosecuted to the fullest extent of the law. Unless otherwise stated the results shown in this test report refer only to the sample(s) tested and such sample(s) are retained for 30 days only. Attention: To check the authenticity of testing /inspection report & certificate, please contact us at telephone: (86-755) 8307 1443, or email: CN.Doccheck@sgs.com

## Compliance Certification Services (Kunshan) Inc. Shenzhen Branch

SZCCS-TRF-01 Rev. A/0 Aug01,2022

Report No.: FYCR221200049005

Page: 98 of 115

### Radar Type 6 - Trial 12

Trial List									
	Download	Trial Id	Radar Type	Pulse Width (us)	PRI (us)	Pulses per Hop	Hopping Rate (kHz)	Hopping Sequence Length (ms)	Visible Frequency Number
<input type="checkbox"/>	Download	12	Type 6	1.0	333.3	9	0.3333	300.0000000	21
			<b>Frequency List (MHz)</b>	<b>0</b>	<b>1</b>	<b>2</b>	<b>3</b>	<b>4</b>	
			0	5283	5357	5516	5543	5446	
			5	5632	5417	5585	5268	5592	
			10	5459	5545	5406	5693	5365	
			15	5436	5388	5256	5578	5344	
			20	5675	5492	5317	5562	5627	
			25	5512	5723	5546	5652	5380	
			30	5300	5455	5674	5356	5498	
			35	5454	5710	5621	5654	5443	
			40	5504	5678	5359	5407	5336	
			45	5695	5720	5685	5580	5400	
			50	5430	5687	5706	5544	5467	
			55	5419	5289	5438	5559	5506	
			60	5340	5554	5329	5556	5327	
			65	5385	5662	5519	5590	5364	
			70	5550	5657	5355	5259	5673	
			75	5420	5618	5697	5524	5275	
			80	5633	5254	5424	5534	5274	
			85	5465	5315	5415	5269	5488	
			90	5547	5566	5616	5509	5427	
			95	5445	5560	5636	5347	5432	
<input type="checkbox"/>	Download	13	Type 6	1.0	333.3	9	0.3333	300.0000000	25
			<b>Frequency List (MHz)</b>	<b>0</b>	<b>1</b>	<b>2</b>	<b>3</b>	<b>4</b>	
			0	5538	5596	5452	5704	5666	
			5	5674	5439	5660	5431	5324	
			10	5390	5334	5544	5413	5386	



Unless otherwise agreed in writing, this document is issued by the Company subject to its General Conditions of Service printed overleaf, available on request or accessible at <http://www.sgs.com/en/Terms-and-Conditions.aspx> and, for electronic format documents, subject to Terms and Conditions for Electronic Documents at <http://www.sgs.com/en/Terms-and-Conditions/Terms-e-Documents.aspx>. Attention is drawn to the limitation of liability, indemnification and jurisdiction issues defined therein. Any holder of this document is advised that information contained hereon reflects the Company's findings at the time of its intervention only and within the limits of Client's instructions, if any. The Company's sole responsibility is to its Client and this document does not exonerate parties to a transaction from exercising all their rights and obligations under the transaction documents. This document cannot be reproduced except in full, without prior written approval of the Company. Any unauthorized alteration, forgery or falsification of the content or appearance of this document is unlawful and offenders may be prosecuted to the fullest extent of the law. Unless otherwise stated the results shown in this test report refer only to the sample(s) tested and such sample(s) are retained for 30 days only. Attention: To check the authenticity of testing /inspection report & certificate, please contact us at telephone: (86-755) 8307 1443, or email: CN.Doccheck@sgs.com

Compliance Certification Services (Kunshan) Inc. Shenzhen Branch

Fuyong lab, Xinlong TechnoPark, Fengtang Road, Fuyong Subdistrict, Bao'an, Shenzhen, China 518103 t (86-755) 88663988 f (86-755) 26710594 www.sgs.com.cn  
 中国·深圳·宝安区福永街道凤塘大道鑫龙科技园福永实验室 邮编: 518103 t (86-755) 88663988 f (86-755) 26710594 sgs.china@sgs.com

## Compliance Certification Services (Kunshan) Inc. Shenzhen Branch

SZCCS-TRF-01 Rev. A/0 Aug01,2022

Report No.: FYCR221200049005

Page: 99 of 115

### Radar Type 6 - Trial 13

Trial List									
	Download	Trial Id	Radar Type	Pulse Width (us)	PRI (us)	Pulses per Hop	Hopping Rate (kHz)	Hopping Sequence Length (ms)	Visible Frequency Number
<input type="checkbox"/>	Download	13	Type 6	1.0	333.3	9	0.3333	300.000000	25
			<b>Frequency List (MHz)</b>	<b>0</b>	<b>1</b>	<b>2</b>	<b>3</b>	<b>4</b>	
			0	5538	5596	5452	5704	5666	
			5	5674	5439	5660	5431	5324	
			10	5390	5334	5544	5413	5386	
			15	5524	5573	5491	5301	5295	
			20	5352	5269	5530	5406	5535	
			25	5515	5364	5451	5650	5686	
			30	5422	5664	5412	5317	5607	
			35	5318	5496	5326	5417	5429	
			40	5454	5343	5489	5565	5443	
			45	5356	5721	5387	5419	5656	
			50	5298	5475	5283	5281	5519	
			55	5393	5498	5657	5713	5260	
			60	5470	5724	5647	5477	5531	
			65	5278	5594	5597	5663	5259	
			70	5505	5690	5688	5526	5282	
			75	5719	5638	5672	5253	5478	
			80	5338	5630	5450	5632	5266	
			85	5497	5466	5333	5366	5339	
			90	5434	5591	5581	5351	5250	
			95	5411	5442	5264	5545	5527	
<input type="checkbox"/>	Download	14	Type 6	1.0	333.3	9	0.3333	300.000000	20
			<b>Frequency List (MHz)</b>	<b>0</b>	<b>1</b>	<b>2</b>	<b>3</b>	<b>4</b>	
			0	5318	5360	5388	5390	5508	
			5	5338	5364	5260	5594	5628	
			10	5321	5598	5585	5511	5407	
			15	5612	5700	5497	5724	5487	



Unless otherwise agreed in writing, this document is issued by the Company subject to its General Conditions of Service printed overleaf, available on request or accessible at <http://www.sgs.com/en/Terms-and-Conditions.aspx> and, for electronic format documents, subject to Terms and Conditions for Electronic Documents at <http://www.sgs.com/en/Terms-and-Conditions/Terms-e-Documents.aspx>. Attention is drawn to the limitation of liability, indemnification and jurisdiction issues defined therein. Any holder of this document is advised that information contained hereon reflects the Company's findings at the time of its intervention only and within the limits of Client's instructions, if any. The Company's sole responsibility is to its Client and this document does not exonerate parties to a transaction from exercising all their rights and obligations under the transaction documents. This document cannot be reproduced except in full, without prior written approval of the Company. Any unauthorized alteration, forgery or falsification of the content or appearance of this document is unlawful and offenders may be prosecuted to the fullest extent of the law. Unless otherwise stated the results shown in this test report refer only to the sample(s) tested and such sample(s) are retained for 30 days only. Attention: To check the authenticity of testing /inspection report & certificate, please contact us at telephone: (86-755) 8307 1443, or email: CN.Doccheck@sgs.com

Compliance Certification Services (Kunshan) Inc. Shenzhen Branch

Fuyong lab, Xinlong TechnoPark, Fengtang Road, Fuyong Subdistrict, Bao'an, Shenzhen, China 518103 t (86-755) 88663988 f (86-755) 26710594 www.sgs.com.cn  
 中国·深圳·宝安区福永街道凤塘大道鑫龙科技园福永实验室 邮编: 518103 t (86-755) 88663988 f (86-755) 26710594 sgs.china@sgs.com

### Radar Type 6 - Trial 14

Trial List									
	Download	Trial Id	Radar Type	Pulse Width (us)	PRI (us)	Pulses per Hop	Hopping Rate (kHz)	Hopping Sequence Length (ms)	Visible Frequency Number
<input type="checkbox"/>	Download	14	Type 6	1.0	333.3	9	0.3333	300.0000000	20
			<b>Frequency List (MHz)</b>	<b>0</b>	<b>1</b>	<b>2</b>	<b>3</b>	<b>4</b>	
			0	5318	5360	5388	5390	5508	
			5	5338	5364	5260	5594	5628	
			10	5321	5598	5585	5511	5407	
			15	5612	5700	5497	5724	5487	
			20	5263	5435	5471	5396	5306	
			25	5691	5654	5279	5720	5464	
			30	5650	5369	5532	5284	5516	
			35	5635	5417	5310	5582	5368	
			40	5657	5669	5503	5683	5353	
			45	5553	5270	5502	5714	5351	
			50	5362	5634	5457	5608	5711	
			55	5337	5607	5452	5372	5706	
			60	5599	5414	5396	5576	5303	
			65	5574	5616	5702	5533	5534	
			70	5489	5466	5428	5588	5693	
			75	5537	5478	5293	5402	5387	
			80	5716	5449	5266	5259	5377	
			85	5401	5627	5645	5632	5583	
			90	5557	5561	5298	5320	5339	
			95	5597	5518	5708	5262	5543	
<input type="checkbox"/>	Download	15	Type 6	1.0	333.3	9	0.3333	300.0000000	20
			<b>Frequency List (MHz)</b>	<b>0</b>	<b>1</b>	<b>2</b>	<b>3</b>	<b>4</b>	
			0	5573	5599	5324	5551	5253	
			5	5380	5386	5335	5660	5360	
			10	5630	5484	5626	5706	5428	



Unless otherwise agreed in writing, this document is issued by the Company subject to its General Conditions of Service printed overleaf, available on request or accessible at <http://www.sgs.com/en/Terms-and-Conditions.aspx> and, for electronic format documents, subject to Terms and Conditions for Electronic Documents at <http://www.sgs.com/en/Terms-and-Conditions/Terms-e-Documents.aspx>. Attention is drawn to the limitation of liability, indemnification and jurisdiction issues defined therein. Any holder of this document is advised that information contained hereon reflects the Company's findings at the time of its intervention only and within the limits of Client's instructions, if any. The Company's sole responsibility is to its Client and this document does not exonerate parties to a transaction from exercising all their rights and obligations under the transaction documents. This document cannot be reproduced except in full, without prior written approval of the Company. Any unauthorized alteration, forgery or falsification of the content or appearance of this document is unlawful and offenders may be prosecuted to the fullest extent of the law. Unless otherwise stated the results shown in this test report refer only to the sample(s) tested and such sample(s) are retained for 30 days only. Attention: To check the authenticity of testing /inspection report & certificate, please contact us at telephone: (86-755) 8307 1443, or email: CN.Doccheck@sgs.com

## Compliance Certification Services (Kunshan) Inc. Shenzhen Branch

SZCCS-TRF-01 Rev. A/0 Aug01,2022

Report No.: FYCR221200049005

Page: 101 of 115

### Radar Type 6 - Trial 15

Trial List									
	Download	Trial Id	Radar Type	Pulse Width (us)	PRI (us)	Pulses per Hop	Hopping Rate (kHz)	Hopping Sequence Length (ms)	Visible Frequency Number
<input type="checkbox"/>	Download	15	Type 6	1.0	333.3	9	0.3333	300.0000000	20
			<b>Frequency List (MHz)</b>	<b>0</b>	<b>1</b>	<b>2</b>	<b>3</b>	<b>4</b>	
			0	5573	5599	5324	5551	5253	
			5	5380	5386	5335	5660	5360	
			10	5630	5484	5626	5706	5428	
			15	5603	5255	5600	5294	5679	
			20	5271	5504	5412	5487	5481	
			25	5669	5640	5382	5480	5279	
			30	5506	5539	5326	5272	5533	
			35	5336	5299	5508	5581	5260	
			40	5282	5496	5277	5441	5448	
			45	5447	5482	5250	5585	5297	
			50	5404	5627	5510	5633	5553	
			55	5319	5534	5659	5320	5406	
			60	5562	5351	5677	5579	5438	
			65	5408	5604	5520	5342	5651	
			70	5569	5366	5284	5647	5500	
			75	5574	5318	5289	5381	5437	
			80	5522	5530	5697	5701	5376	
			85	5515	5444	5561	5624	5365	
			90	5535	5278	5641	5371	5587	
			95	5357	5552	5493	5560	5608	
<input type="checkbox"/>	Download	16	Type 6	1.0	333.3	9	0.3333	300.0000000	20
			<b>Frequency List (MHz)</b>	<b>0</b>	<b>1</b>	<b>2</b>	<b>3</b>	<b>4</b>	
			0	5256	5460	5260	5615	5570	
			5	5422	5311	5410	5348	5567	
			10	5561	5273	5667	5426	5449	



Unless otherwise agreed in writing, this document is issued by the Company subject to its General Conditions of Service printed overleaf, available on request or accessible at <http://www.sgs.com/en/Terms-and-Conditions.aspx> and, for electronic format documents, subject to Terms and Conditions for Electronic Documents at <http://www.sgs.com/en/Terms-and-Conditions/Terms-e-Documents.aspx>. Attention is drawn to the limitation of liability, indemnification and jurisdiction issues defined therein. Any holder of this document is advised that information contained hereon reflects the Company's findings at the time of its intervention only and within the limits of Client's instructions, if any. The Company's sole responsibility is to its Client and this document does not exonerate parties to a transaction from exercising all their rights and obligations under the transaction documents. This document cannot be reproduced except in full, without prior written approval of the Company. Any unauthorized alteration, forgery or falsification of the content or appearance of this document is unlawful and offenders may be prosecuted to the fullest extent of the law. Unless otherwise stated the results shown in this test report refer only to the sample(s) tested and such sample(s) are retained for 30 days only. Attention: To check the authenticity of testing /inspection report & certificate, please contact us at telephone: (86-755) 8307 1443, or email: CN.Doccheck@sgs.com

Compliance Certification Services (Kunshan) Inc. Shenzhen Branch

Fuyong lab, Xinlong TechnoPark, Fengtang Road, Fuyong Subdistrict, Bao'an, Shenzhen, China 518103 t (86-755) 88663988 f (86-755) 26710594 www.sgs.com.cn  
 中国·深圳·宝安区福永街道凤塘大道鑫龙科技园福永实验室 邮编: 518103 t (86-755) 88663988 f (86-755) 26710594 sgs.china@sgs.com

## Compliance Certification Services (Kunshan) Inc. Shenzhen Branch

SZCCS-TRF-01 Rev. A/0 Aug01,2022

Report No.: FYCR221200049005

Page: 102 of 115

### Radar Type 6 - Trial 16

Trial List									
	Download	Trial Id	Radar Type	Pulse Width (us)	PRI (us)	Pulses per Hop	Hopping Rate (kHz)	Hopping Sequence Length (ms)	Visible Frequency Number
<input type="checkbox"/>	Download	16	Type 6	1.0	333.3	9	0.3333	300.0000000	20
			<b>Frequency List (MHz)</b>	<b>0</b>	<b>1</b>	<b>2</b>	<b>3</b>	<b>4</b>	
			0	5256	5460	5260	5615	5570	
			5	5422	5311	5410	5348	5567	
			10	5561	5273	5667	5426	5449	
			15	5691	5382	5703	5339	5396	
			20	5279	5670	5353	5479	5454	
			25	5557	5492	5488	5584	5313	
			30	5645	5525	5283	5487	5685	
			35	5534	5341	5599	5377	5413	
			40	5671	5335	5360	5379	5591	
			45	5444	5411	5705	5668	5258	
			50	5457	5514	5289	5334	5604	
			55	5408	5357	5603	5263	5655	
			60	5548	5551	5269	5383	5715	
			65	5527	5466	5640	5600	5508	
			70	5576	5651	5450	5669	5560	
			75	5321	5613	5609	5642	5678	
			80	5478	5486	5296	5608	5624	
			85	5524	5438	5364	5580	5470	
			90	5606	5325	5555	5489	5375	
			95	5480	5674	5663	5282	5573	
<input type="checkbox"/>	Download	17	Type 6	1.0	333.3	9	0.3333	300.0000000	26
			<b>Frequency List (MHz)</b>	<b>0</b>	<b>1</b>	<b>2</b>	<b>3</b>	<b>4</b>	
			0	5511	5699	5671	5301	5315	
			5	5464	5333	5485	5396	5492	
			10	5537	5708	5621	5470	5304	
			15	5509	5331	5287	5588	5665	



Unless otherwise agreed in writing, this document is issued by the Company subject to its General Conditions of Service printed overleaf, available on request or accessible at <http://www.sgs.com/en/Terms-and-Conditions.aspx> and, for electronic format documents, subject to Terms and Conditions for Electronic Documents at <http://www.sgs.com/en/Terms-and-Conditions/Terms-e-Documents.aspx>. Attention is drawn to the limitation of liability, indemnification and jurisdiction issues defined therein. Any holder of this document is advised that information contained hereon reflects the Company's findings at the time of its intervention only and within the limits of Client's instructions, if any. The Company's sole responsibility is to its Client and this document does not exonerate parties to a transaction from exercising all their rights and obligations under the transaction documents. This document cannot be reproduced except in full, without prior written approval of the Company. Any unauthorized alteration, forgery or falsification of the content or appearance of this document is unlawful and offenders may be prosecuted to the fullest extent of the law. Unless otherwise stated the results shown in this test report refer only to the sample(s) tested and such sample(s) are retained for 30 days only. Attention: To check the authenticity of testing /inspection report & certificate, please contact us at telephone: (86-755) 8307 1443, or email: CN.Doccheck@sgs.com

Compliance Certification Services (Kunshan) Inc. Shenzhen Branch

Fuyong lab, Xinlong TechnoPark, Fengtang Road, Fuyong Subdistrict, Bao'an, Shenzhen, China 518103 t (86-755) 88663988 f (86-755) 26710594 www.sgs.com.cn  
 中国·深圳·宝安区福永街道凤塘大道鑫龙科技园福永实验室 邮编: 518103 t (86-755) 88663988 f (86-755) 26710594 sgs.china@sgs.com

## Compliance Certification Services (Kunshan) Inc. Shenzhen Branch

SZCCS-TRF-01 Rev. A/0 Aug01,2022

Report No.: FYCR221200049005

Page: 103 of 115

### Radar Type 6 - Trial 17

Trial List									
	Download	Trial Id	Radar Type	Pulse Width (us)	PRI (us)	Pulses per Hop	Hopping Rate (kHz)	Hopping Sequence Length (ms)	Visible Frequency Number
<input type="checkbox"/>	Download	17	Type 6	1.0	333.3	9	0.3333	300.0000000	26
			<b>Frequency List (MHz)</b>	<b>0</b>	<b>1</b>	<b>2</b>	<b>3</b>	<b>4</b>	
			0	5511	5699	5671	5301	5315	
			5	5464	5333	5485	5396	5492	
			10	5537	5708	5621	5470	5304	
			15	5509	5331	5287	5588	5665	
			20	5264	5391	5568	5427	5348	
			25	5441	5691	5688	5347	5687	
			30	5414	5715	5605	5459	5354	
			35	5480	5312	5648	5663	5682	
			40	5271	5540	5317	5356	5718	
			45	5685	5276	5316	5413	5640	
			50	5510	5655	5497	5558	5450	
			55	5599	5692	5370	5367	5522	
			60	5434	5328	5547	5353	5412	
			65	5366	5549	5544	5408	5446	
			70	5253	5266	5546	5421	5462	
			75	5355	5481	5719	5659	5633	
			80	5499	5552	5297	5521	5280	
			85	5438	5681	5543	5565	5474	
			90	5279	5608	5375	5619	5712	
			95	5523	5257	5541	5507	5261	
<input type="checkbox"/>	Download	18	Type 6	1.0	333.3	9	0.3333	300.0000000	17
			<b>Frequency List (MHz)</b>	<b>0</b>	<b>1</b>	<b>2</b>	<b>3</b>	<b>4</b>	
			0	5291	5463	5607	5462	5632	
			5	5603	5258	5560	5674	5326	
			10	5274	5341	5491	5392	5636	
			15	5434	5332	5305	5673	5430	
			20	5400	5311	5600	5410	5212	



Unless otherwise agreed in writing, this document is issued by the Company subject to its General Conditions of Service printed overleaf, available on request or accessible at <http://www.sgs.com/en/Terms-and-Conditions.aspx> and, for electronic format documents, subject to Terms and Conditions for Electronic Documents at <http://www.sgs.com/en/Terms-and-Conditions/Terms-e-Documents.aspx>. Attention is drawn to the limitation of liability, indemnification and jurisdiction issues defined therein. Any holder of this document is advised that information contained hereon reflects the Company's findings at the time of its intervention only and within the limits of Client's instructions, if any. The Company's sole responsibility is to its Client and this document does not exonerate parties to a transaction from exercising all their rights and obligations under the transaction documents. This document cannot be reproduced except in full, without prior written approval of the Company. Any unauthorized alteration, forgery or falsification of the content or appearance of this document is unlawful and offenders may be prosecuted to the fullest extent of the law. Unless otherwise stated the results shown in this test report refer only to the sample(s) tested and such sample(s) are retained for 30 days only. Attention: To check the authenticity of testing /inspection report & certificate, please contact us at telephone: (86-755) 8307 1443, or email: CN.Doccheck@sgs.com

Compliance Certification Services (Kunshan) Inc. Shenzhen Branch

Fuyong lab, Xinlong TechnoPark, Fengtang Road, Fuyong Subdistrict, Bao'an, Shenzhen, China 518103 t (86-755) 88663988 f (86-755) 26710594 www.sgs.com.cn  
 中国·深圳·宝安区福永街道凤塘大道鑫龙科技园福永实验室 邮编: 518103 t (86-755) 88663988 f (86-755) 26710594 sgs.china@sgs.com

## Compliance Certification Services (Kunshan) Inc. Shenzhen Branch

SZCCS-TRF-01 Rev. A/0 Aug01,2022

Report No.: FYCR221200049005

Page: 104 of 115

### Radar Type 6 - Trial 18

Trial List									
	Download	Trial Id	Radar Type	Pulse Width (us)	PRI (us)	Pulses per Hop	Hopping Rate (kHz)	Hopping Sequence Length (ms)	Visible Frequency Number
<input type="checkbox"/>	Download	18	Type 6	1.0	333.3	9	0.3333	300.0000000	17
			<b>Frequency List (MHz)</b>	<b>0</b>	<b>1</b>	<b>2</b>	<b>3</b>	<b>4</b>	
			0	5291	5463	5607	5462	5632	
			5	5603	5258	5560	5674	5326	
			10	5274	5341	5491	5392	5636	
			15	5434	5332	5305	5673	5430	
			20	5400	5711	5293	5419	5317	
			25	5381	5254	5303	5672	5345	
			30	5611	5649	5619	5403	5541	
			35	5596	5585	5623	5633	5438	
			40	5647	5665	5359	5374	5466	
			45	5666	5516	5589	5706	5586	
			50	5394	5312	5646	5661	5493	
			55	5543	5599	5273	5476	5276	
			60	5455	5664	5498	5580	5618	
			65	5338	5531	5435	5629	5424	
			70	5311	5309	5314	5450	5310	
			75	5290	5640	5410	5609	5333	
			80	5461	5275	5518	5572	5620	
			85	5506	5282	5342	5330	5573	
			90	5718	5557	5517	5601	5708	
			95	5298	5525	5405	5304	5682	
<input type="checkbox"/>	Download	19	Type 6	1.0	333.3	9	0.3333	300.0000000	19
			<b>Frequency List (MHz)</b>	<b>0</b>	<b>1</b>	<b>2</b>	<b>3</b>	<b>4</b>	
			0	5546	5702	5543	5623	5377	
			5	5645	5280	5635	5265	5335	
			10	5257	5590	5315	5439	5512	
			15	5383	5288	5440	5594	5681	



Unless otherwise agreed in writing, this document is issued by the Company subject to its General Conditions of Service printed overleaf, available on request or accessible at <http://www.sgs.com/en/Terms-and-Conditions.aspx> and, for electronic format documents, subject to Terms and Conditions for Electronic Documents at <http://www.sgs.com/en/Terms-and-Conditions/Terms-e-Documents.aspx>. Attention is drawn to the limitation of liability, indemnification and jurisdiction issues defined therein. Any holder of this document is advised that information contained hereon reflects the Company's findings at the time of its intervention only and within the limits of Client's instructions, if any. The Company's sole responsibility is to its Client and this document does not exonerate parties to a transaction from exercising all their rights and obligations under the transaction documents. This document cannot be reproduced except in full, without prior written approval of the Company. Any unauthorized alteration, forgery or falsification of the content or appearance of this document is unlawful and offenders may be prosecuted to the fullest extent of the law. Unless otherwise stated the results shown in this test report refer only to the sample(s) tested and such sample(s) are retained for 30 days only. Attention: To check the authenticity of testing /inspection report & certificate, please contact us at telephone: (86-755) 8307 1443, or email: CN.Doccheck@sgs.com

Compliance Certification Services (Kunshan) Inc. Shenzhen Branch

Fuyong lab, Xinlong TechnoPark, Fengtang Road, Fuyong Subdistrict, Bao'an, Shenzhen, China 518103 t (86-755) 88663988 f (86-755) 26710594 www.sgs.com.cn  
 中国·深圳·宝安区福永街道凤塘大道鑫龙科技园福永实验室 邮编: 518103 t (86-755) 88663988 f (86-755) 26710594 sgs.china@sgs.com



## Compliance Certification Services (Kunshan) Inc. Shenzhen Branch

SZCCS-TRF-01 Rev. A/0 Aug01,2022

Report No.: FYCR221200049005

Page: 105 of 115

### Radar Type 6 - Trial 19

Trial List									
	Download	Trial Id	Radar Type	Pulse Width (us)	PRI (us)	Pulses per Hop	Hopping Rate (kHz)	Hopping Sequence Length (ms)	Visible Frequency Number
<input type="checkbox"/>	Download	19	Type 6	1.0	333.3	9	0.3333	300.0000000	19
			<b>Frequency List (MHz)</b>	<b>0</b>	<b>1</b>	<b>2</b>	<b>3</b>	<b>4</b>	
			0	5546	5702	5543	5623	5377	
			5	5645	5280	5635	5265	5335	
			10	5257	5590	5315	5439	5512	
			15	5383	5288	5440	5594	5681	
			20	5596	5273	5649	5373	5502	
			25	5620	5622	5518	5415	5393	
			30	5289	5629	5560	5385	5372	
			35	5283	5494	5337	5510	5424	
			40	5706	5571	5361	5435	5479	
			45	5442	5519	5456	5392	5290	
			50	5282	5297	5679	5716	5500	
			55	5600	5275	5464	5672	5308	
			60	5577	5401	5390	5447	5450	
			65	5608	5334	5507	5615	5524	
			70	5285	5322	5430	5433	5621	
			75	5662	5719	5589	5528	5515	
			80	5292	5462	5566	5307	5284	
			85	5296	5474	5724	5399	5710	
			90	5250	5353	5509	5303	5597	
			95	5407	5428	5562	5678	5300	
<input type="checkbox"/>	Download	20	Type 6	1.0	333.3	9	0.3333	300.0000000	22
			<b>Frequency List (MHz)</b>	<b>0</b>	<b>1</b>	<b>2</b>	<b>3</b>	<b>4</b>	
			0	5704	5466	5479	5309	5597	
			5	5687	5680	5710	5428	5639	
			10	5566	5379	5356	5634	5533	
			15	5471	5318	5543	5422	5311	



Unless otherwise agreed in writing, this document is issued by the Company subject to its General Conditions of Service printed overleaf, available on request or accessible at <http://www.sgs.com/en/Terms-and-Conditions.aspx> and, for electronic format documents, subject to Terms and Conditions for Electronic Documents at <http://www.sgs.com/en/Terms-and-Conditions/Terms-e-Documents.aspx>. Attention is drawn to the limitation of liability, indemnification and jurisdiction issues defined therein. Any holder of this document is advised that information contained hereon reflects the Company's findings at the time of its intervention only and within the limits of Client's instructions, if any. The Company's sole responsibility is to its Client and this document does not exonerate parties to a transaction from exercising all their rights and obligations under the transaction documents. This document cannot be reproduced except in full, without prior written approval of the Company. Any unauthorized alteration, forgery or falsification of the content or appearance of this document is unlawful and offenders may be prosecuted to the fullest extent of the law. Unless otherwise stated the results shown in this test report refer only to the sample(s) tested and such sample(s) are retained for 30 days only. Attention: To check the authenticity of testing /inspection report & certificate, please contact us at telephone: (86-755) 8307 1443, or email: CN.Doccheck@sgs.com

Compliance Certification Services (Kunshan) Inc. Shenzhen Branch

Fuyong lab, Xinlong TechnoPark, Fengtang Road, Fuyong Subdistrict, Bao'an, Shenzhen, China 518103 t (86-755) 88663988 f (86-755) 26710594 www.sgs.com.cn  
 中国·深圳·宝安区福永街道凤塘大道鑫科技园福永实验室 邮编: 518103 t (86-755) 88663988 f (86-755) 26710594 sgs.china@sgs.com

## Compliance Certification Services (Kunshan) Inc. Shenzhen Branch

SZCCS-TRF-01 Rev. A/0 Aug01,2022

Report No.: FYCR221200049005

Page: 106 of 115

### Radar Type 6 - Trial 20

Trial List									
	Download	Trial Id	Radar Type	Pulse Width (us)	PRI (us)	Pulses per Hop	Hopping Rate (kHz)	Hopping Sequence Length (ms)	Visible Frequency Number
<input type="checkbox"/>	Download	20	Type 6	1.0	333.3	9	0.3333	300.0000000	22
			<b>Frequency List (MHz)</b>	<b>0</b>	<b>1</b>	<b>2</b>	<b>3</b>	<b>4</b>	
			0	5704	5466	5479	5309	5597	
			5	5687	5680	5710	5428	5639	
			10	5566	5379	5356	5634	5533	
			15	5471	5318	5543	5422	5311	
			20	5592	5665	5641	5443	5390	
			25	5569	5350	5622	5449	5435	
			30	5653	5586	5300	5537	5667	
			35	5325	5585	5608	5269	5521	
			40	5263	5314	5509	5504	5529	
			45	5408	5528	5525	5393	5572	
			50	5343	5646	5333	5386	5502	
			55	5660	5688	5554	5465	5677	
			60	5338	5326	5454	5260	5615	
			65	5403	5347	5591	5396	5555	
			70	5515	5579	5601	5527	5387	
			75	5261	5707	5291	5550	5602	
			80	5439	5257	5370	5692	5498	
			85	5512	5487	5719	5401	5650	
			90	5335	5402	5255	5659	5722	
			95	5364	5493	5676	5510	5700	
<input type="checkbox"/>	Download	21	Type 6	1.0	333.3	9	0.3333	300.0000000	26
			<b>Frequency List (MHz)</b>	<b>0</b>	<b>1</b>	<b>2</b>	<b>3</b>	<b>4</b>	
			0	5484	5705	5415	5470	5439	
			5	5351	5702	5310	5591	5371	
			10	5497	5265	5494	5354	5554	
			15	5558	5415	5618	5638	5588	



Unless otherwise agreed in writing, this document is issued by the Company subject to its General Conditions of Service printed overleaf, available on request or accessible at <http://www.sgs.com/en/Terms-and-Conditions.aspx> and, for electronic format documents, subject to Terms and Conditions for Electronic Documents at <http://www.sgs.com/en/Terms-and-Conditions/Terms-e-Documents.aspx>. Attention is drawn to the limitation of liability, indemnification and jurisdiction issues defined therein. Any holder of this document is advised that information contained hereon reflects the Company's findings at the time of its intervention only and within the limits of Client's instructions, if any. The Company's sole responsibility is to its Client and this document does not exonerate parties to a transaction from exercising all their rights and obligations under the transaction documents. This document cannot be reproduced except in full, without prior written approval of the Company. Any unauthorized alteration, forgery or falsification of the content or appearance of this document is unlawful and offenders may be prosecuted to the fullest extent of the law. Unless otherwise stated the results shown in this test report refer only to the sample(s) tested and such sample(s) are retained for 30 days only. Attention: To check the authenticity of testing/inspection report & certificate, please contact us at telephone: (86-755) 8307 1443, or email: CN.Doccheck@sgs.com

Compliance Certification Services (Kunshan) Inc. Shenzhen Branch

Fuyong lab, Xinlong TechnoPark, Fengtang Road, Fuyong Subdistrict, Bao'an, Shenzhen, China 518103 t (86-755) 88663988 f (86-755) 26710594 www.sgs.com.cn  
 中国·深圳·宝安区福永街道凤塘大道鑫科技园福永实验室 邮编: 518103 t (86-755) 88663988 f (86-755) 26710594 sgs.china@sgs.com

### Radar Type 6 - Trial 21

Trial List									
	Download	Trial Id	Radar Type	Pulse Width (us)	PRI (us)	Pulses per Hop	Hopping Rate (kHz)	Hopping Sequence Length (ms)	Visible Frequency Number
<input type="checkbox"/>	Download	21	Type 6	1.0	333.3	9	0.3333	300.0000000	26
			<b>Frequency List (MHz)</b>	<b>0</b>	<b>1</b>	<b>2</b>	<b>3</b>	<b>4</b>	
			0	5484	5705	5415	5470	5439	
			5	5351	5702	5310	5591	5371	
			10	5497	5265	5494	5354	5554	
			15	5559	5445	5646	5370	5503	
			20	5600	5356	5252	5255	5416	
			25	5656	5421	5456	5251	5483	
			30	5477	5542	5543	5418	5311	
			35	5390	5464	5676	5501	5422	
			40	5435	5674	5447	5269	5526	
			45	5337	5508	5608	5451	5625	
			50	5522	5642	5384	5475	5703	
			55	5507	5401	5655	5496	5309	
			60	5455	5619	5680	5326	5414	
			65	5345	5492	5295	5318	5273	
			70	5587	5530	5711	5615	5666	
			75	5638	5670	5622	5583	5691	
			80	5367	5626	5381	5561	5412	
			85	5682	5718	5589	5286	5289	
			90	5553	5314	5329	5261	5465	
			95	5541	5463	5574	5671	5458	
<input type="checkbox"/>	Download	22	Type 6	1.0	333.3	9	0.3333	300.0000000	27
			<b>Frequency List (MHz)</b>	<b>0</b>	<b>1</b>	<b>2</b>	<b>3</b>	<b>4</b>	
			0	5264	5469	5351	5631	5659	
			5	5393	5627	5385	5279	5578	
			10	5428	5529	5535	5549	5575	



Unless otherwise agreed in writing, this document is issued by the Company subject to its General Conditions of Service printed overleaf, available on request or accessible at <http://www.sgs.com/en/Terms-and-Conditions.aspx> and, for electronic format documents, subject to Terms and Conditions for Electronic Documents at <http://www.sgs.com/en/Terms-and-Conditions/Terms-e-Document.aspx>. Attention is drawn to the limitation of liability, indemnification and jurisdiction issues defined therein. Any holder of this document is advised that information contained hereon reflects the Company's findings at the time of its intervention only and within the limits of Client's instructions, if any. The Company's sole responsibility is to its Client and this document does not exonerate parties to a transaction from exercising all their rights and obligations under the transaction documents. This document cannot be reproduced except in full, without prior written approval of the Company. Any unauthorized alteration, forgery or falsification of the content or appearance of this document is unlawful and offenders may be prosecuted to the fullest extent of the law. Unless otherwise stated the results shown in this test report refer only to the sample(s) tested and such sample(s) are retained for 30 days only. Attention: To check the authenticity of testing /inspection report & certificate, please contact us at telephone: (86-755) 8307 1443, or email: CN.Doccheck@sgs.com

## Compliance Certification Services (Kunshan) Inc. Shenzhen Branch

SZCCS-TRF-01 Rev. A/0 Aug01,2022

Report No.: FYCR221200049005

Page: 108 of 115

### Radar Type 6 - Trial 22

Trial List									
		Trial Id	Radar Type	Pulse Width (us)	PRI (us)	Pulses per Hop	Hopping Rate (kHz)	Hopping Sequence Length (ms)	Visible Frequency Number
<input type="checkbox"/>	Download	22	Type 6	1.0	333.3	9	0.3333	300.0000000	27
			<b>Frequency List (MHz)</b>	<b>0</b>	<b>1</b>	<b>2</b>	<b>3</b>	<b>4</b>	
			0	5264	5469	5351	5631	5659	
			5	5393	5627	5385	5279	5578	
			10	5428	5529	5535	5549	5575	
			15	5647	5572	5274	5415	5695	
			20	5608	5425	5668	5722	5389	
			25	5544	5370	5355	5517	5616	
			30	5528	5500	5633	5463	5685	
			35	5603	5292	5297	5349	5513	
			40	5577	5509	5523	5644	5488	
			45	5691	5412	5678	5495	5398	
			50	5343	5435	5564	5526	5451	
			55	5589	5462	5315	5280	5584	
			60	5309	5625	5336	5615	5294	
			65	5530	5702	5565	5596	5345	
			70	5670	5630	5560	5591	5607	
			75	5693	5468	5477	5407	5545	
			80	5721	5409	5402	5525	5552	
			85	5381	5483	5340	5326	5609	
			90	5494	5364	5499	5423	5465	
			95	5518	5558	5569	5716	5718	
<input type="checkbox"/>	Download	23	Type 6	1.0	333.3	9	0.3333	300.0000000	23
			<b>Frequency List (MHz)</b>	<b>0</b>	<b>1</b>	<b>2</b>	<b>3</b>	<b>4</b>	
			0	5519	5708	5287	5695	5501	
			5	5435	5649	5460	5442	5407	
			10	5262	5318	5576	5269	5596	



Unless otherwise agreed in writing, this document is issued by the Company subject to its General Conditions of Service printed overleaf, available on request or accessible at <http://www.sgs.com/en/Terms-and-Conditions.aspx> and, for electronic format documents, subject to Terms and Conditions for Electronic Documents at <http://www.sgs.com/en/Terms-and-Conditions/Terms-e-Documents.aspx>. Attention is drawn to the limitation of liability, indemnification and jurisdiction issues defined therein. Any holder of this document is advised that information contained hereon reflects the Company's findings at the time of its intervention only and within the limits of Client's instructions, if any. The Company's sole responsibility is to its Client and this document does not exonerate parties to a transaction from exercising all their rights and obligations under the transaction documents. This document cannot be reproduced except in full, without prior written approval of the Company. Any unauthorized alteration, forgery or falsification of the content or appearance of this document is unlawful and offenders may be prosecuted to the fullest extent of the law. Unless otherwise stated the results shown in this test report refer only to the sample(s) tested and such sample(s) are retained for 30 days only. Attention: To check the authenticity of testing /inspection report & certificate, please contact us at telephone: (86-755) 8307 1443, or email: CN.Doccheck@sgs.com

Compliance Certification Services (Kunshan) Inc. Shenzhen Branch

Fuyong lab, Xinlong TechnoPark, Fengtang Road, Fuyong Subdistrict, Bao'an, Shenzhen, China 518103 t (86-755) 88663988 f (86-755) 26710594 www.sgs.com.cn  
 中国·深圳·宝安区福永街道凤塘大道鑫龙科技园福永实验室 邮编: 518103 t (86-755) 88663988 f (86-755) 26710594 sgs.china@sgs.com

## Compliance Certification Services (Kunshan) Inc. Shenzhen Branch

SZCCS-TRF-01 Rev. A/0 Aug01,2022

Report No.: FYCR221200049005

Page: 109 of 115

### Radar Type 6 - Trial 23

Trial List									
	Download	Trial Id	Radar Type	Pulse Width (us)	PRI (us)	Pulses per Hop	Hopping Rate (kHz)	Hopping Sequence Length (ms)	Visible Frequency Number
<input type="checkbox"/>	Download	23	Type 6	1.0	333.3	9	0.3333	300.0000000	23
			<b>Frequency List (MHz)</b>	<b>0</b>	<b>1</b>	<b>2</b>	<b>3</b>	<b>4</b>	
			0	5519	5708	5287	5695	5501	
			5	5435	5649	5460	5442	5407	
			10	5262	5318	5576	5269	5596	
			15	5638	5699	5377	5412	5591	
			20	5706	5336	5362	5432	5697	
			25	5387	5556	5454	5658	5417	
			30	5457	5373	5712	5408	5645	
			35	5480	5568	5350	5360	5352	
			40	5660	5323	5652	5520	5573	
			45	5468	5299	5470	5634	5285	
			50	5274	5486	5275	5349	5298	
			55	5680	5416	5463	5512	5251	
			60	5713	5474	5667	5683	5453	
			65	5282	5438	5718	5566	5534	
			70	5399	5514	5656	5633	5409	
			75	5567	5584	5338	5545	5623	
			80	5490	5663	5612	5309	5406	
			85	5694	5525	5499	5448	5294	
			90	5574	5332	5659	5370	5436	
			95	5477	5415	5542	5467	5319	
<input type="checkbox"/>	Download	24	Type 6	1.0	333.3	9	0.3333	300.0000000	19
			<b>Frequency List (MHz)</b>	<b>0</b>	<b>1</b>	<b>2</b>	<b>3</b>	<b>4</b>	
			0	5299	5472	5698	5381	5721	
			5	5477	5574	5535	5508	5614	
			10	5668	5582	5617	5367	5251	



Unless otherwise agreed in writing, this document is issued by the Company subject to its General Conditions of Service printed overleaf, available on request or accessible at <http://www.sgs.com/en/Terms-and-Conditions.aspx> and, for electronic format documents, subject to Terms and Conditions for Electronic Documents at <http://www.sgs.com/en/Terms-and-Conditions/Terms-e-Documents.aspx>. Attention is drawn to the limitation of liability, indemnification and jurisdiction issues defined therein. Any holder of this document is advised that information contained hereon reflects the Company's findings at the time of its intervention only and within the limits of Client's instructions, if any. The Company's sole responsibility is to its Client and this document does not exonerate parties to a transaction from exercising all their rights and obligations under the transaction documents. This document cannot be reproduced except in full, without prior written approval of the Company. Any unauthorized alteration, forgery or falsification of the content or appearance of this document is unlawful and offenders may be prosecuted to the fullest extent of the law. Unless otherwise stated the results shown in this test report refer only to the sample(s) tested and such sample(s) are retained for 30 days only. Attention: To check the authenticity of testing /inspection report & certificate, please contact us at telephone: (86-755) 8307 1443, or email: CN.Doccheck@sgs.com

Compliance Certification Services (Kunshan) Inc. Shenzhen Branch

Fuyong lab, Xinlong TechnoPark, Fengtang Road, Fuyong Subdistrict, Bao'an, Shenzhen, China 518103 t (86-755) 88663988 f (86-755) 26710594 www.sgs.com.cn  
 中国·深圳·宝安区福永街道凤塘大道鑫龙科技园福永实验室 邮编: 518103 t (86-755) 88663988 f (86-755) 26710594 sgs.china@sgs.com

## Compliance Certification Services (Kunshan) Inc. Shenzhen Branch

SZCCS-TRF-01 Rev. A/0 Aug01,2022

Report No.: FYCR221200049005

Page: 110 of 115

### Radar Type 6 - Trial 24

Trial List									
	Download	Trial Id	Radar Type	Pulse Width (us)	PRI (us)	Pulses per Hop	Hopping Rate (kHz)	Hopping Sequence Length (ms)	Visible Frequency Number
<input type="checkbox"/>	Download	24	Type 6	1.0	333.3	9	0.3333	300.0000000	19
			<b>Frequency List (MHz)</b>	<b>0</b>	<b>1</b>	<b>2</b>	<b>3</b>	<b>4</b>	
			0	5299	5472	5698	5381	5721	
			5	5477	5574	5535	5508	5614	
			10	5668	5582	5617	5367	5251	
			15	5351	5383	5505	5604	5527	
			20	5660	5647	5328	5335	5549	
			25	5590	5488	5700	5403	5414	
			30	5588	5389	5703	5309	5571	
			35	5364	5503	5274	5666	5365	
			40	5261	5417	5517	5405	5448	
			45	5382	5528	5687	5695	5537	
			50	5717	5393	5370	5653	5331	
			55	5600	5270	5639	5612	5515	
			60	5376	5667	5269	5252	5677	
			65	5586	5642	5258	5636	5543	
			70	5458	5479	5623	5400	5444	
			75	5301	5372	5428	5341	5575	
			80	5290	5316	5345	5347	5627	
			85	5349	5470	5565	5432	5628	
			90	5676	5447	5672	5552	5468	
			95	5469	5359	5321	5325	5678	
<input type="checkbox"/>	Download	25	Type 6	1.0	333.3	9	0.3333	300.0000000	19
			<b>Frequency List (MHz)</b>	<b>0</b>	<b>1</b>	<b>2</b>	<b>3</b>	<b>4</b>	
			0	5457	5711	5634	5542	5563	
			5	5616	5596	5610	5671	5346	
			10	5599	5371	5668	5562	5638	



Unless otherwise agreed in writing, this document is issued by the Company subject to its General Conditions of Service printed overleaf, available on request or accessible at <http://www.sgs.com/en/Terms-and-Conditions.aspx> and, for electronic format documents, subject to Terms and Conditions for Electronic Documents at <http://www.sgs.com/en/Terms-and-Conditions/Terms-e-Documents.aspx>. Attention is drawn to the limitation of liability, indemnification and jurisdiction issues defined therein. Any holder of this document is advised that information contained hereon reflects the Company's findings at the time of its intervention only and within the limits of Client's instructions, if any. The Company's sole responsibility is to its Client and this document does not exonerate parties to a transaction from exercising all their rights and obligations under the transaction documents. This document cannot be reproduced except in full, without prior written approval of the Company. Any unauthorized alteration, forgery or falsification of the content or appearance of this document is unlawful and offenders may be prosecuted to the fullest extent of the law. Unless otherwise stated the results shown in this test report refer only to the sample(s) tested and such sample(s) are retained for 30 days only. Attention: To check the authenticity of testing /inspection report & certificate, please contact us at telephone: (86-755) 8307 1443, or email: CN.Doccheck@sgs.com

Compliance Certification Services (Kunshan) Inc. Shenzhen Branch

Fuyong lab, Xinlong TechnoPark, Fengtang Road, Fuyong Subdistrict, Bao'an, Shenzhen, China 518103 t (86-755) 88663988 f (86-755) 26710594 www.sgs.com.cn  
 中国·深圳·宝安区福永街道凤塘大道鑫龙科技园福永实验室 邮编: 518103 t (86-755) 88663988 f (86-755) 26710594 sgs.china@sgs.com

### Radar Type 6 - Trial 25

Trial List									
	Download	Trial Id	Radar Type	Pulse Width (us)	PRI (us)	Pulses per Hop	Hopping Rate (kHz)	Hopping Sequence Length (ms)	Visible Frequency Number
<input type="checkbox"/>	Download	25	Type 6	1.0	333.3	9	0.3333	300.0000000	19
			<b>Frequency List (MHz)</b>	<b>0</b>	<b>1</b>	<b>2</b>	<b>3</b>	<b>4</b>	
			0	5457	5711	5634	5542	5563	
			5	5616	5596	5610	5671	5346	
			10	5599	5371	5658	5562	5638	
			15	5339	5381	5486	5453	5321	
			20	5535	5351	5588	5417	5308	
			25	5586	5498	5318	5289	5522	
			30	5364	5292	5706	5426	5448	
			35	5662	5257	5656	5663	5505	
			40	5674	5657	5514	5334	5428	
			45	5465	5489	5265	5437	5404	
			50	5396	5373	5564	5581	5324	
			55	5368	5625	5571	5399	5329	
			60	5557	5347	5677	5271	5462	
			65	5541	5576	5383	5280	5250	
			70	5261	5485	5519	5502	5578	
			75	5525	5604	5652	5613	5700	
			80	5435	5400	5609	5331	5635	
			85	5385	5281	5299	5595	5350	
			90	5382	5407	5695	5546	5683	
			95	5607	5263	5655	5550	5459	
<input type="checkbox"/>	Download	26	Type 6	1.0	333.3	9	0.3333	300.0000000	16
			<b>Frequency List (MHz)</b>	<b>0</b>	<b>1</b>	<b>2</b>	<b>3</b>	<b>4</b>	
			0	5712	5475	5570	5703	5308	
			5	5658	5521	5685	5359	5650	
			10	5433	5257	5699	5282	5659	



Unless otherwise agreed in writing, this document is issued by the Company subject to its General Conditions of Service printed overleaf, available on request or accessible at <http://www.sgs.com/en/Terms-and-Conditions.aspx> and, for electronic format documents, subject to Terms and Conditions for Electronic Documents at <http://www.sgs.com/en/Terms-and-Conditions/Terms-e-Documents.aspx>. Attention is drawn to the limitation of liability, indemnification and jurisdiction issues defined therein. Any holder of this document is advised that information contained hereon reflects the Company's findings at the time of its intervention only and within the limits of Client's instructions, if any. The Company's sole responsibility is to its Client and this document does not exonerate parties to a transaction from exercising all their rights and obligations under the transaction documents. This document cannot be reproduced except in full, without prior written approval of the Company. Any unauthorized alteration, forgery or falsification of the content or appearance of this document is unlawful and offenders may be prosecuted to the fullest extent of the law. Unless otherwise stated the results shown in this test report refer only to the sample(s) tested and such sample(s) are retained for 30 days only. Attention: To check the authenticity of testing /inspection report & certificate, please contact us at telephone: (86-755) 8307 1443, or email: CN.Doccheck@sgs.com

## Compliance Certification Services (Kunshan) Inc. Shenzhen Branch

SZCCS-TRF-01 Rev. A/0 Aug01,2022

Report No.: FYCR221200049005

Page: 112 of 115

### Radar Type 6 - Trial 26

Trial List									
	Download	Trial Id	Radar Type	Pulse Width (us)	PRI (us)	Pulses per Hop	Hopping Rate (kHz)	Hopping Sequence Length (ms)	Visible Frequency Number
<input type="checkbox"/>	Download	26	Type 6	1.0	333.3	9	0.3333	300.000000	16
			<b>Frequency List (MHz)</b>	<b>0</b>	<b>1</b>	<b>2</b>	<b>3</b>	<b>4</b>	
			0	5712	5475	5570	5703	5308	
			5	5658	5521	5685	5359	5650	
			10	5433	5257	5699	5282	5659	
			15	5427	5508	5589	5496	5610	
			20	5446	5420	5626	5409	5281	
			25	5377	5350	5424	5393	5556	
			30	5406	5656	5328	5315	5721	
			35	5587	5278	5528	5431	5674	
			40	5441	5531	5515	5422	5608	
			45	5263	5408	5548	5547	5318	
			50	5324	5280	5572	5639	5542	
			55	5671	5294	5558	5347	5494	
			60	5502	5654	5600	5692	5663	
			65	5662	5577	5311	5414	5661	
			70	5352	5711	5361	5334	5398	
			75	5461	5289	5698	5668	5585	
			80	5429	5723	5481	5629	5595	
			85	5300	5329	5331	5597	5598	
			90	5624	5368	5645	5679	5485	
			95	5707	5563	5591	5636	5537	
<input type="checkbox"/>	Download	27	Type 6	1.0	333.3	9	0.3333	300.000000	23
			<b>Frequency List (MHz)</b>	<b>0</b>	<b>1</b>	<b>2</b>	<b>3</b>	<b>4</b>	
			0	5492	5714	5506	5389	5625	
			5	5700	5543	5285	5522	5382	
			10	5364	5521	5265	5477	5680	



Unless otherwise agreed in writing, this document is issued by the Company subject to its General Conditions of Service printed overleaf, available on request or accessible at <http://www.sgs.com/en/Terms-and-Conditions.aspx> and, for electronic format documents, subject to Terms and Conditions for Electronic Documents at <http://www.sgs.com/en/Terms-and-Conditions/Terms-e-Documents.aspx>. Attention is drawn to the limitation of liability, indemnification and jurisdiction issues defined therein. Any holder of this document is advised that information contained hereon reflects the Company's findings at the time of its intervention only and within the limits of Client's instructions, if any. The Company's sole responsibility is to its Client and this document does not exonerate parties to a transaction from exercising all their rights and obligations under the transaction documents. This document cannot be reproduced except in full, without prior written approval of the Company. Any unauthorized alteration, forgery or falsification of the content or appearance of this document is unlawful and offenders may be prosecuted to the fullest extent of the law. Unless otherwise stated the results shown in this test report refer only to the sample(s) tested and such sample(s) are retained for 30 days only. Attention: To check the authenticity of testing /inspection report & certificate, please contact us at telephone: (86-755) 8307 1443, or email: CN.Doccheck@sgs.com

Compliance Certification Services (Kunshan) Inc. Shenzhen Branch

Fuyong lab, Xinlong TechnoPark, Fengtang Road, Fuyong Subdistrict, Bao'an, Shenzhen, China 518103 t (86-755) 88663988 f (86-755) 26710594 www.sgs.com.cn  
 中国·深圳·宝安区福永街道凤塘大道鑫龙科技园福永实验室 邮编: 518103 t (86-755) 88663988 f (86-755) 26710594 sgs.china@sgs.com



## Compliance Certification Services (Kunshan) Inc. Shenzhen Branch

SZCCS-TRF-01 Rev. A/0 Aug01,2022

Report No.: FYCR221200049005

Page: 113 of 115

### Radar Type 6 - Trial 27

Trial List									
	Download	Trial Id	Radar Type	Pulse Width (us)	PRI (us)	Pulses per Hop	Hopping Rate (kHz)	Hopping Sequence Length (ms)	Visible Frequency Number
<input type="checkbox"/>	Download	27	Type 6	1.0	333.3	9	0.3333	300.0000000	23
			<b>Frequency List (MHz)</b>	<b>0</b>	<b>1</b>	<b>2</b>	<b>3</b>	<b>4</b>	
			0	5492	5714	5506	5389	5625	
			5	5700	5543	5285	5522	5382	
			10	5364	5521	5265	5477	5680	
			15	5418	5635	5692	5327	5454	
			20	5586	5567	5498	5254	5299	
			25	5627	5594	5590	5448	5642	
			30	5661	5564	5541	5629	5369	
			35	5324	5584	5588	5280	5614	
			40	5453	5565	5605	5570	5291	
			45	5631	5371	5589	5534	5273	
			50	5690	5494	5355	5482	5707	
			55	5641	5513	5657	5659	5544	
			60	5486	5426	5638	5611	5516	
			65	5618	5684	5464	5697	5658	
			70	5374	5420	5258	5721	5566	
			75	5681	5358	5262	5696	5297	
			80	5621	5709	5439	5672	5304	
			85	5616	5368	5491	5475	5341	
			90	5580	5318	5281	5380	5519	
			95	5537	5362	5645	5524	5325	
<input type="checkbox"/>	Download	28	Type 6	1.0	333.3	9	0.3333	300.0000000	22
			<b>Frequency List (MHz)</b>	<b>0</b>	<b>1</b>	<b>2</b>	<b>3</b>	<b>4</b>	
			0	5272	5478	5539	5550	5370	
			5	5267	5565	5360	5588	5589	
			10	5205	5210	5200	5220	5201	



Unless otherwise agreed in writing, this document is issued by the Company subject to its General Conditions of Service printed overleaf, available on request or accessible at <http://www.sgs.com/en/Terms-and-Conditions.aspx> and, for electronic format documents, subject to Terms and Conditions for Electronic Documents at <http://www.sgs.com/en/Terms-and-Conditions/Terms-e-Documents.aspx>. Attention is drawn to the limitation of liability, indemnification and jurisdiction issues defined therein. Any holder of this document is advised that information contained hereon reflects the Company's findings at the time of its intervention only and within the limits of Client's instructions, if any. The Company's sole responsibility is to its Client and this document does not exonerate parties to a transaction from exercising all their rights and obligations under the transaction documents. This document cannot be reproduced except in full, without prior written approval of the Company. Any unauthorized alteration, forgery or falsification of the content or appearance of this document is unlawful and offenders may be prosecuted to the fullest extent of the law. Unless otherwise stated the results shown in this test report refer only to the sample(s) tested and such sample(s) are retained for 30 days only.  
**Attention: To check the authenticity of testing /inspection report & certificate, please contact us at telephone: (86-755) 8307 1443, or email: CN.Doccheck@sgs.com**

Compliance Certification Services (Kunshan) Inc. Shenzhen Branch

Fuyong lab, Xinlong TechnoPark, Fengtang Road, Fuyong Subdistrict, Bao'an, Shenzhen, China 518103 t (86-755) 88663988 f (86-755) 26710594 www.sgs.com.cn  
 中国·深圳·宝安区福永街道凤塘大道鑫龙科技园福永实验室 邮编: 518103 t (86-755) 88663988 f (86-755) 26710594 sgs.china@sgs.com

## Compliance Certification Services (Kunshan) Inc. Shenzhen Branch

SZCCS-TRF-01 Rev. A/0 Aug01,2022

Report No.: FYCR221200049005

Page: 114 of 115

### Radar Type 6 - Trial 28

Trial List									
	Download	Trial Id	Radar Type	Pulse Width (us)	PRI (us)	Pulses per Hop	Hopping Rate (kHz)	Hopping Sequence Length (ms)	Visible Frequency Number
<input type="checkbox"/>	Download	28	Type 6	1.0	333.3	9	0.3333	300.0000000	22
			<b>Frequency List (MHz)</b>	<b>0</b>	<b>1</b>	<b>2</b>	<b>3</b>	<b>4</b>	
			0	5272	5478	5539	5550	5370	
			5	5267	5565	5360	5586	5589	
			10	5295	5310	5306	5672	5701	
			15	5506	5287	5320	5491	5519	
			20	5462	5655	5508	5490	5702	
			25	5531	5626	5355	5696	5624	
			30	5717	5401	5716	5264	5293	
			35	5557	5692	5262	5502	5594	
			40	5319	5391	5330	5602	5499	
			45	5271	5336	5663	5424	5476	
			50	5410	5449	5266	5342	5317	
			55	5299	5670	5564	5463	5460	
			60	5387	5311	5349	5489	5415	
			65	5252	5681	5687	5560	5552	
			70	5353	5576	5593	5683	5464	
			75	5507	5350	5379	5605	5366	
			80	5382	5547	5361	5371	5518	
			85	5385	5721	5294	5341	5612	
			90	5378	5621	5389	5457	5292	
			95	5534	5497	5412	5374	5597	
<input type="checkbox"/>	Download	29	Type 6	1.0	333.3	9	0.3333	300.0000000	24
			<b>Frequency List (MHz)</b>	<b>0</b>	<b>1</b>	<b>2</b>	<b>3</b>	<b>4</b>	
			0	5430	5717	5475	5711	5687	
			5	5406	5490	5435	5276	5321	



Unless otherwise agreed in writing, this document is issued by the Company subject to its General Conditions of Service printed overleaf, available on request or accessible at <http://www.sgs.com/en/Terms-and-Conditions.aspx> and, for electronic format documents, subject to Terms and Conditions for Electronic Documents at <http://www.sgs.com/en/Terms-and-Conditions/Terms-e-Documents.aspx>. Attention is drawn to the limitation of liability, indemnification and jurisdiction issues defined therein. Any holder of this document is advised that information contained hereon reflects the Company's findings at the time of its intervention only and within the limits of Client's instructions, if any. The Company's sole responsibility is to its Client and this document does not exonerate parties to a transaction from exercising all their rights and obligations under the transaction documents. This document cannot be reproduced except in full, without prior written approval of the Company. Any unauthorized alteration, forgery or falsification of the content or appearance of this document is unlawful and offenders may be prosecuted to the fullest extent of the law. Unless otherwise stated the results shown in this test report refer only to the sample(s) tested and such sample(s) are retained for 30 days only. Attention: To check the authenticity of testing /inspection report & certificate, please contact us at telephone: (86-755) 8307 1443, or email: CN.Doccheck@sgs.com

Compliance Certification Services (Kunshan) Inc. Shenzhen Branch

Fuyong lab, Xinlong TechnoPark, Fengtang Road, Fuyong Subdistrict, Bao'an, Shenzhen, China 518103 t (86-755) 88663988 f (86-755) 26710594 www.sgs.com.cn  
 中国·深圳·宝安区福永街道凤塘大道鑫龙科技园福永实验室 邮编: 518103 t (86-755) 88663988 f (86-755) 26710594 sgs.china@sgs.com

## Compliance Certification Services (Kunshan) Inc. Shenzhen Branch

SZCCS-TRF-01 Rev. A/0 Aug01,2022

Report No.: FYCR221200049005

Page: 115 of 115

### Radar Type 6 - Trial 29

Trial List									
	Trial Id	Radar Type	Pulse Width (us)	PRI (us)	Pulses per Hop	Hopping Rate (kHz)	Hopping Sequence Length (ms)	Visible Frequency Number	
		80	5382	5547	5361	5371	5518		
		85	5385	5721	5294	5341	5612		
		90	5378	5621	5389	5457	5292		
		95	5534	5497	5412	5374	5597		
<input checked="" type="checkbox"/>	Download	29	Type 6	1.0	333.3	9	0.3333	300.0000000	24
			<b>Frequency List (MHz)</b>	<b>0</b>	<b>1</b>	<b>2</b>	<b>3</b>	<b>4</b>	
			0	5430	5717	5475	5711	5687	
			5	5406	5490	5435	5276	5321	
			10	5604	5574	5444	5295	5722	
			15	5594	5414	5326	5536	5373	
			20	5346	5546	5579	5675	5419	
			25	5478	5558	5327	5658	5629	
			30	5420	5674	5519	5559	5432	
			35	5648	5488	5512	5513	5433	
			40	5402	5329	5570	5599	5331	
			45	5251	5624	5477	5266	5286	
			50	5625	5317	5431	5518	5621	
			55	5653	5279	5358	5343	5514	
			60	5434	5650	5627	5413	5509	
			65	5491	5660	5371	5545	5665	
			70	5291	5467	5259	5336	5486	
			75	5428	5528	5613	5481	5299	
			80	5549	5309	5612	5695	5681	
			85	5581	5422	5540	5386	5699	
			90	5503	5446	5256	5462	5640	
			95	5427	5377	5487	5396	5307	

- End of the Report -



Unless otherwise agreed in writing, this document is issued by the Company subject to its General Conditions of Service printed overleaf, available on request or accessible at <http://www.sgs.com/en/Terms-and-Conditions/Terms-e-Documents.aspx> and, for electronic format documents, subject to Terms and Conditions for Electronic Documents at <http://www.sgs.com/en/Terms-and-Conditions/Terms-e-Documents.aspx>. Attention is drawn to the limitation of liability, indemnification and jurisdiction issues defined therein. Any holder of this document is advised that information contained hereon reflects the Company's findings at the time of its intervention only and within the limits of Client's instructions, if any. The Company's sole responsibility is to its Client and this document does not exonerate parties to a transaction from exercising all their rights and obligations under the transaction documents. This document cannot be reproduced except in full, without prior written approval of the Company. Any unauthorized alteration, forgery or falsification of the content or appearance of this document is unlawful and offenders may be prosecuted to the fullest extent of the law. Unless otherwise stated the results shown in this test report refer only to the sample(s) tested and such sample(s) are retained for 30 days only. Attention: To check the authenticity of testing /inspection report & certificate, please contact us at telephone: (86-755) 8307 1443, or email: CN.Doccheck@sgs.com

Compliance Certification Services (Kunshan) Inc. Shenzhen Branch

Fuyong lab, Xinlong TechnoPark, Fengtang Road, Fuyong Subdistrict, Bao'an, Shenzhen, China 518103 t (86-755) 88663988 f (86-755) 26710594 www.sgs.com.cn  
 中国·深圳·宝安区福永街道凤塘大道鑫龙科技园福永实验室 邮编: 518103 t (86-755) 88663988 f (86-755) 26710594 sgs.china@sgs.com