

# TEST REPORT

**Product Name : Wireless Access Point**

**Model Number : RG-RAP2200(E)**

**FCC ID : 2AX5J-RAP2200EV2**

Prepared for : Ruijie Networks Co., Ltd.  
Address : Building 19, Juyuanzhou Industrial Park, No.618 Jinshan Road, Cangshan District, Fuzhou, Fujian, China

Prepared by : EMTEK (SHENZHEN) CO., LTD.  
Address : Bldg 69, Majialong Industry Zone, Nanshan District, Shenzhen, Guangdong, China

Tel: (0755) 26954280  
Fax: (0755) 26954282

Report Number : ENS2310200026W00202R  
Date(s) of Tests : October 25, 2023 to November 13, 2023  
Date of issue : November 15, 2023

## TABLE OF CONTENTS

<b>1 TEST RESULT CERTIFICATION.....</b>	<b>4</b>
<b>2 EUT TECHNICAL DESCRIPTION.....</b>	<b>5</b>
<b>3 SUMMARY OF TEST RESULT.....</b>	<b>7</b>
<b>4 TEST METHODOLOGY.....</b>	<b>8</b>
4.1 GENERAL DESCRIPTION OF APPLIED STANDARDS.....	8
4.2 MEASUREMENT EQUIPMENT USED.....	8
4.3 DESCRIPTION OF TEST MODES.....	9
<b>5 FACILITIES AND ACCREDITATIONS.....</b>	<b>13</b>
5.1 FACILITIES.....	13
5.2 LABORATORY ACCREDITATIONS AND LISTINGS.....	13
<b>6 TEST SYSTEM UNCERTAINTY.....</b>	<b>14</b>
<b>7 SETUP OF EQUIPMENT UNDER TEST.....</b>	<b>15</b>
7.1 RADIO FREQUENCY TEST SETUP.....	15
7.2 RADIO FREQUENCY TEST SETUP.....	15
7.3 CONDUCTED EMISSION TEST SETUP.....	17
7.4 BLOCK DIAGRAM CONFIGURATION OF TEST SYSTEM.....	18
7.5 SUPPORT EQUIPMENT.....	18
<b>8 TEST REQUIREMENTS.....</b>	<b>19</b>
8.1 BANDWIDTH MEASUREMENT.....	19
8.2 MAXIMUM CONDUCTED OUTPUT POWER.....	118
8.3 MAXIMUM PEAK POWER DENSITY.....	184
8.4 UNDESIRABLE RADIATED SPURIOUS EMISSION.....	230
8.5 POWER LINE CONDUCTED EMISSIONS.....	267
8.6 ANTENNA APPLICATION.....	270

## Modified Information

Version	Report No.	Revision Date	Summary
Ver.1.0	ENS2310200026W00202R	/	Original Report

# 1 TEST RESULT CERTIFICATION

Applicant : Ruijie Networks Co., Ltd.  
 Address : Building 19,Juyuanzhou Industrial Park, No.618 Jinshan Road, CangshanDistrict,Fuzhou,Fujian, China  
 Manufacturer : Ruijie Networks Co., Ltd.  
 Address : Building 19,Juyuanzhou Industrial Park, No.618 Jinshan Road, CangshanDistrict,Fuzhou,Fujian, China  
 EUT : Wireless Access Point  
 Model Name : RG-RAP2200(E)  
 Trademark : *Ruijie*, *Reyee*, *Ruijie* | *Reyee*, *Reyee*, *Ruijie* | *瑞**Reyee*

**Measurement Procedure Used:**

APPLICABLE STANDARDS	
STANDARD	TEST RESULT
FCC 47 CFR Part 2, Subpart J FCC 47 CFR Part 15, Subpart E	<b>PASS</b>

The above equipment was tested by EMTEK (SHENZHEN) CO., LTD. The test data, data evaluation, test procedures, and equipment configurations shown in this report were made in accordance with the procedures given in ANSI C63.10 (2013) and the energy emitted by the sample EUT tested as described in this report is in compliance with the above table standards requirement.

The test results of this report relate only to the tested sample identified in this report.

Date of Test : October 25, 2023 to November 13, 2023

Prepared by : *Una Yu*  
Una Yu/Editor

Reviewer : *Joe Xia*  
Joe Xia/Supervisor

Approved & Authorized Signer : *Lisa Wang*  
Lisa Wang/Manager



## 2 EUT TECHNICAL DESCRIPTION

Characteristics	Description
Product	Wireless Access Point
Model Number	RG-RAP2200(E)
Wifi Type	UNII-1: 5150MHz-5250MHz Band UNII-2A: with 5250MHz-5350MHz Band UNII-2C: with 5470MHz-5725MHz Band UNII-3 with 5725MHz-5850MHz Band
WLAN Supported	802.11a 802.11n(20MHz channel bandwidth) 802.11n(40MHz channel bandwidth) 802.11ac(20MHz channel bandwidth) 802.11ac(40MHz channel bandwidth) 802.11ac(80MHz channel bandwidth)
Modulation	OFDM
Frequency Range	UNII-1: 5150MHz-5250MHz Band
	5180-5240MHz for 802.11a 5180-5240MHz for 802.11n(HT20) 5180-5240MHz for 802.11ac(HT20) 5190-5230MHz for 802.11n(HT40) 5190-5230MHz for 802.11ac(HT40) 5210MHz for 802.11ac(HT80)
	UNII-2A: with 5250MHz-5350MHz Band
	5260-5320MHz for 802.11a 5260-5320MHz for 802.11n(HT20) 5260-5320MHz for 802.11ac(HT20) 5270-5310MHz for 802.11n(HT40) 5270-5310MHz for 802.11ac(HT40) 5290MHz for 802.11ac(HT80)
	UNII-2C: with 5470MHz-5725MHz Band
	5500-5700MHz for 802.11a 5500-5700MHz for 802.11n(HT20) 5500-5700MHz for 802.11ac(HT20) 5510-5670MHz for 802.11n(HT40) 5510-5670MHz for 802.11ac(HT40) 5530-5610MHz for 802.11ac(HT80)
	UNII-3 with 5725MHz-5850MHz Band
	5745-5825MHz for 802.11a 5745-5825MHz for 802.11n(HT20) 5745-5825MHz for 802.11ac(HT20) 5755-5795MHz for 802.11n(HT40) 5755-5795MHz for 802.11ac(HT40) 5775MHz for 802.11ac(HT80)
TPC Function	Applicable

<b>Antenna Type</b>	Integrated Antenna
<b>Antenna Gain</b>	ANT1: 4.67dBi, ANT2: 4.67dBi (Note: The antenna information is provided by the customers, which will have a certain impact on the test results.)
<b>Smart system</b>	MIMO
<b>Power Supply</b>	DC 48V by POE adapter DC 12V by Power adapter
<b>Temperature Range</b>	0°C ~ 40°C

*Note: for more details, please refer to the user's manual of the EUT.*



### 3 SUMMARY OF TEST RESULT

FCC Part Clause	Test Parameter	Verdict	Remark
15.407 (a) 15.407 (e)	99% , 6dB and 26dB Bandwidth	PASS	
15.407 (a)	Maximum Conducted Output Power	PASS	
15.407 (a)	Peak Power Spectral Density	PASS	
15.407 (b)	Radiated Spurious Emission	PASS	
15.407 (b)(6) 15.207	Power Line Conducted Emission	PASS	
15.407(a) 15.203	Antenna Application	PASS	

NOTE1: The results of this report do not take into account the uncertainty.

NOTE2: According to FCC OET KDB 789033 D2 General UNII Test Procedures New Rules v02r01, In addition, the radiated test is also performed to ensure the emissions emanating from the device cabinet also comply with the applicable limits.

#### RELATED SUBMITTAL(S) / GRANT(S):

This submittal(s) (test report) is intended for FCC ID: 2AX5J-RAP2200EV2 filing to comply with Section 15.247 of the FCC Part 15, Subpart E Rules.

## 4 TEST METHODOLOGY

### 4.1 GENERAL DESCRIPTION OF APPLIED STANDARDS

According to its specifications, the EUT must comply with the requirements of the following standards:

FCC 47 CFR Part 2, Subpart J

FCC 47 CFR Part 15, Subpart E

FCC KDB 789033 D2 General UNII Test Procedures New Rules v02r01

### 4.2 MEASUREMENT EQUIPMENT USED

#### For Conducted Emission Test

Equipment	Manufacturer	Model No.	Serial No.	Last Cal.	Cal. Interval
EMI Test Receiver	Rohde & Schwarz	ESCI	101384	2023/5/13	1Year
AMN	Rohde & Schwarz	ENV216	101161	2023/5/13	1Year

#### For Spurious Emissions Test

Equipment	Manufacturer	Model No.	Serial No.	Last Cal.	Cal. Interval
Pre-Amplifier	Bonn	BLMA 011001N	2213967A	2022/10/31 2023/10/23	1Year
EMI Test Receiver	Rohde & Schwarz	ESR7	102551	2022/10/31 2023/10/23	1Year
Bilog Antenna	Schwarzbeck	VULB9163	9163142	2022/7/24	2Year
Horn antenna	Schwarzbeck	BBHA9120D	9120D-1198	2023/6/2	2Year
Pre-Amplifier	Bonn	BLMA 0118-5G	2213967B-01	2022/10/31 2023/10/23	1Year
Spectrum Analyzer	Rohde & Schwarz	FSV3044	101290	2022/10/31 2023/10/23	1Year
Horn antenna	Schwarzbeck	BBHA9170	9170-399	2023/5/12	2Year
Pre-Amplifier	Lunar EM	LNA18G26-40	J1012131010 001	2023/5/10	1Year
Pre-Amplifier	Lunar EM	LNA26G40-40	J1013131028 001	2023/5/10	1Year
Loop Antenna	Schwarzbeck	FMZB1519	1519-012	2023/5/12	2Year
Thermometer	Hegao	HTC-1	\	2023/5/16	1Year

#### For Other Test

Equipment	Manufacturer	Model No.	Serial No.	Last Cal.	Cal. Interval
Wideband Radio Communication Tester	R&S	CMW500	171168	2023/9/14	1Year
Frequency Extender	R&S	CMW-Z800A	100430	2022/11/2 2023/11/1	1Year
Spectrum Analyzer	R&S	FSV3044	101289	2023/9/14	1Year
Analog Signal Generator	R&S	SMB100A	183237	2023/9/16	1Year
Vector Signal Generator	R&S	SMM100A	101808	2023/9/16	1Year
RF Control Unit(Power Meter)	Tonscend	JS0806-2	22C8060567	2023/9/14	1Year
Temperature&Hum idity Chamber	ESPEC	EL-02KA	12107166	2023/5/10	1 Year



### 4.3 DESCRIPTION OF TEST MODES

The EUT has been tested under its typical operating condition.

The EUT configuration for testing is installed on RF field strength measurement to meet the Commissions requirement and operating in a manner which intends to maximize its emission characteristics in a continuous normal application.

The Transmitter was operated in the normal operating mode. The TX frequency was fixed which was for the purpose of the measurements.

Test of channel included the lowest and middle and highest frequency to perform the test, then record on this report.

Pre-defined engineering program for regulatory testing used to control the EUT for staying in continuous transmitting and receiving mode is programmed.

#### Wifi 5G with 5150-5250MHz

Frequency and Channels list for 802.11a/n(20)/802.11ac(20):

Channel	Frequency (MHz)	Channel	Frequency (MHz)	Channel	Frequency (MHz)
36	5180	44	5220		
40	5200	48	5240		

Frequency and Channels list for 802.11n (40)/802.11ac(40):

Channel	Frequency (MHz)	Channel	Frequency (MHz)	Channel	Frequency (MHz)
38	5190				
46	5230				

Frequency and Channel list for 802.11ac(80):

Channel	Frequency (MHz)	Channel	Frequency (MHz)	Channel	Frequency (MHz)
42	5210				

Test Frequency and Channels for 802.11a/n(20)/802.11ac(20):

Lowest Frequency		Middle Frequency		Highest Frequency	
Channel	Frequency (MHz)	Channel	Frequency (MHz)	Channel	Frequency (MHz)
36	5180	40	5200	48	5240

Test Frequency and channels for 802.11n (40)/ 802.11ac(40):

Lowest Frequency		Middle Frequency		Highest Frequency	
Channel	Frequency (MHz)	Channel	Frequency (MHz)	Channel	Frequency (MHz)
38	5190	N/A	N/A	46	5230

Test Frequency and channels for 802.11ac(80):

Lowest Frequency		Middle Frequency		Highest Frequency	
Channel	Frequency (MHz)	Channel	Frequency (MHz)	Channel	Frequency (MHz)
42	5210	N/A	N/A	N/A	N/A

**Wifi 5G with 5250-5350MHz**

Frequency and Channels list for 802.11a/n(20)/802.11ac(20):

Channel	Frequency (MHz)	Channel	Frequency (MHz)	Channel	Frequency (MHz)
52	5260	60	5300		
56	5280	64	5320		

Frequency and Channels list for 802.11n (40)/ 802.11ac(40):

Channel	Frequency (MHz)	Channel	Frequency (MHz)	Channel	Frequency (MHz)
54	5270				
62	5310				

Frequency and Channels list for 802.11ac(80):

Channel	Frequency (MHz)	Channel	Frequency (MHz)	Channel	Frequency (MHz)
58	5290				

**Test Frequency and Channels** for 802.11a/n(20)/802.11ac(20):

Lowest Frequency		Middle Frequency		Highest Frequency	
Channel	Frequency (MHz)	Channel	Frequency (MHz)	Channel	Frequency (MHz)
52	5260	56	5280	64	5320

**Test Frequency and channels** for 802.11n(40)/ 802.11ac(40):

Lowest Frequency		Middle Frequency		Highest Frequency	
Channel	Frequency (MHz)	Channel	Frequency (MHz)	Channel	Frequency (MHz)
54	5270	N/A	N/A	62	5310

**Test Frequency and channels** for 802.11ac(80):

Lowest Frequency		Middle Frequency		Highest Frequency	
Channel	Frequency (MHz)	Channel	Frequency (MHz)	Channel	Frequency (MHz)
58	5290				

**Wifi 5G with 5470-5725MHz**

Frequency and Channels list for 802.11a/n(20)/802.11ac(20):

Channel	Frequency (MHz)	Channel	Frequency (MHz)	Channel	Frequency (MHz)
100	5500	116	5580	132	5660
104	5520	120	5600	136	5680
108	5540	124	5620	140	5700
112	5560	128	5640		

Frequency and Channels list for 802.11n(40)/ 802.11ac(40):

Channel	Frequency (MHz)	Channel	Frequency (MHz)	Channel	Frequency (MHz)
102	5510	118	5590	134	5670
110	5550	126	5630		

Frequency and Channels list for 802.11ac(80):

Channel	Frequency (MHz)	Channel	Frequency (MHz)	Channel	Frequency (MHz)
106	5530	138	5690		

**Test Frequency and Channels** for 802.11a/n(20)/802.11ac(20):

Lowest Frequency		Middle Frequency		Highest Frequency	
Channel	Frequency (MHz)	Channel	Frequency (MHz)	Channel	Frequency (MHz)
100	5500	116	5580	140	5700

**Test Frequency and channels** for 802.11n(40)/ 802.11ac(40):

Lowest Frequency		Middle Frequency		Highest Frequency	
Channel	Frequency (MHz)	Channel	Frequency (MHz)	Channel	Frequency (MHz)
102	5510			134	5670

**Test Frequency and channels** for 802.11ac(80):

Lowest Frequency		Middle Frequency		Highest Frequency	
Channel	Frequency (MHz)	Channel	Frequency (MHz)	Channel	Frequency (MHz)
106	5530	138	5690		

**Wifi 5G with 5725MHz-5850MHz**

Frequency and Channels list for 802.11a/n(20)/802.11ac(20):

Channel	Frequency (MHz)	Channel	Frequency (MHz)	Channel	Frequency (MHz)
149	5745	157	5785	165	5825
153	5765	161	5805		

Frequency and Channels list for 802.11n (40)/ 802.11ac(40):

Channel	Frequency (MHz)	Channel	Frequency (MHz)	Channel	Frequency (MHz)
151	5755				
159	5795				

Frequency and Channels list for 802.11ac(80):

Channel	Frequency (MHz)	Channel	Frequency (MHz)	Channel	Frequency (MHz)
155	5775				

**Test Frequency and Channels** for 802.11a/n(20)/802.11ac(20):

Lowest Frequency		Middle Frequency		Highest Frequency	
Channel	Frequency (MHz)	Channel	Frequency (MHz)	Channel	Frequency (MHz)
149	5745	157	5785	165	5825

**Test Frequency and channels** for 802.11n (40)/ 802.11ac(40):

Lowest Frequency		Middle Frequency		Highest Frequency	
Channel	Frequency (MHz)	Channel	Frequency (MHz)	Channel	Frequency (MHz)
151	5755			159	5795

**Test Frequency and channels** for 802.11ac(80):

Lowest Frequency		Middle Frequency		Highest Frequency	
Channel	Frequency (MHz)	Channel	Frequency (MHz)	Channel	Frequency (MHz)
155	5775				

Multi-antenna correlation:

<input checked="" type="checkbox"/>	Transmit Signals are Correlated
	Directional gain = $10 \log[(10^{G^1/20} + 10^{G^2/20} + \dots + 10^{G^N/20})^2 / N_{ANT}]$ dBi
<input type="checkbox"/>	All Transmit Signals are Completely Uncorrelated
	Directional gain = $10 \log[(10^{G^1/10} + 10^{G^2/10} + \dots + 10^{G^N/10}) / N_{ANT}]$ dBi

ANT1: 4.67dBi, ANT2: 4.67dBi

ANT1+ANT2: Directional gain =  $10 \log [(10^{4.67/20} + 10^{4.67/20})^2 / 2]$  dBi=7.68dBi

## 5 FACILITIES AND ACCREDITATIONS

### 5.1 FACILITIES

All measurement facilities used to collect the measurement data are located at:

Bldg 69, Majialong Industry Zone District, Nanshan District, Shenzhen, China

The sites are constructed in conformance with the requirements of ANSI C63.7, ANSI C63.10 and CISPR Publication 22.

### 5.2 LABORATORY ACCREDITATIONS AND LISTINGS

Site Description

EMC Lab.

: **Accredited by CNAS**

The Certificate Registration Number is L2291

The Laboratory has been assessed and proved to be in compliance with CNAS-CL01 (identical to ISO/IEC 17025:2017)

**Accredited by FCC**

Designation Number: CN1204

Test Firm Registration Number: 882943

**Accredited by A2LA**

The Certificate Number is 4321.01

**Accredited by Industry Canada**

The Conformity Assessment Body Identifier is CN0008

Name of Firm

: EMTEK (SHENZHEN) CO., LTD.

Site Location

: Building 69, Majialong Industry Zone, Nanshan District, Shenzhen, Guangdong, China

## 6 TEST SYSTEM UNCERTAINTY

The following measurement uncertainty levels have been estimated for tests performed on the apparatus:

Parameter	Uncertainty
Radio Frequency	$\pm 1 \times 10^{-5}$
Maximum Peak Output Power Test	$\pm 1.0\text{dB}$
Conducted Emissions Test	$\pm 2.0\text{dB}$
Radiated Emission Test	$\pm 2.0\text{dB}$
Power Density	$\pm 2.0\text{dB}$
Occupied Bandwidth Test	$\pm 1.0\text{dB}$
Band Edge Test	$\pm 3\text{dB}$
All emission, radiated	$\pm 3\text{dB}$
Antenna Port Emission	$\pm 3\text{dB}$
Temperature	$\pm 0.5^\circ\text{C}$
Humidity	$\pm 3\%$

Measurement Uncertainty for a level of Confidence of 95%.

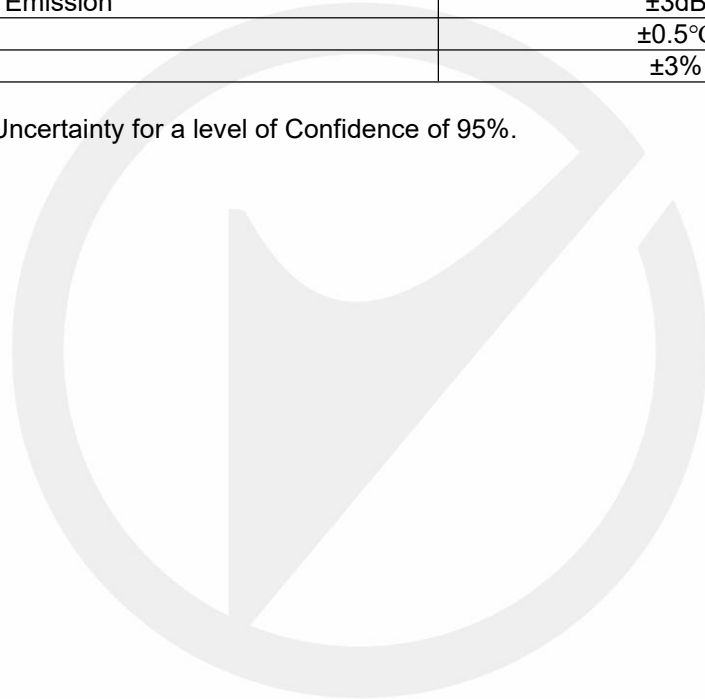

## 7 SETUP OF EQUIPMENT UNDER TEST

### 7.1 RADIO FREQUENCY TEST SETUP

The WLAN component's antenna ports(s) of the EUT are connected to the measurement instrument per an appropriate attenuator. The EUT is controlled by PC/software to emit the specified signals for the purpose of measurements.

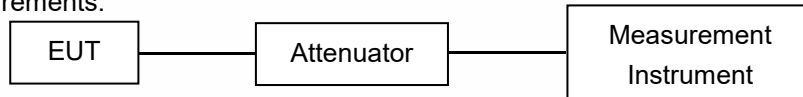

### 7.2 RADIO FREQUENCY TEST SETUP

The test site semi-anechoic chamber has met the requirement of NSA tolerance 4 dB according to the standards: ANSI C63.10. The test distance is 3m. The setup is according to the requirements in Section 13.1.4.1 of ANSI C63.10-2013 and CAN/CSA-CEI/IEC CISPR 22.

Below 30MHz:

The EUT is placed on a turntable 0.8 meters above the ground in the chamber, 3 meter away from the antenna (loop antenna). The Antenna should be positioned with its plane vertical at the specified distance from the EUT and rotated about its vertical axis for maximum response at each azimuth about the EUT. The center of the loop shall be 1 m above the ground. For certain applications, the loop antenna plane may also need to be positioned horizontally at the specified distance from the EUT.

Above 30MHz:

The EUT is placed on a turntable 0.8 meters above the ground in the chamber, 3 meter away from the antenna. The maximal emission value is acquired by adjusting the antenna height, polarisation and turntable azimuth. Normally, the height range of antenna is 1 m to 4 m, the azimuth range of turntable is 0° to 360°, and the receive antenna has two polarizations Vertical (V) and Horizontal (H).

Above 1GHz:

(Note: the FCC's permission to use 1.5m as an alternative per TCBC Conf call of Dec. 2, 2014.)

The EUT is placed on a turntable 1.5 meters above the ground in the chamber, 3 meter away from the antenna. The maximal emission value is acquired by adjusting the antenna height, polarisation and turntable azimuth. Normally, the height range of antenna is 1 m to 4 m, the azimuth range of turntable is 0° to 360°, and the receive antenna has two polarizations Vertical (V) and Horizontal (H).

(a) Radiated Emission Test Set-Up, Frequency Below 30MHz

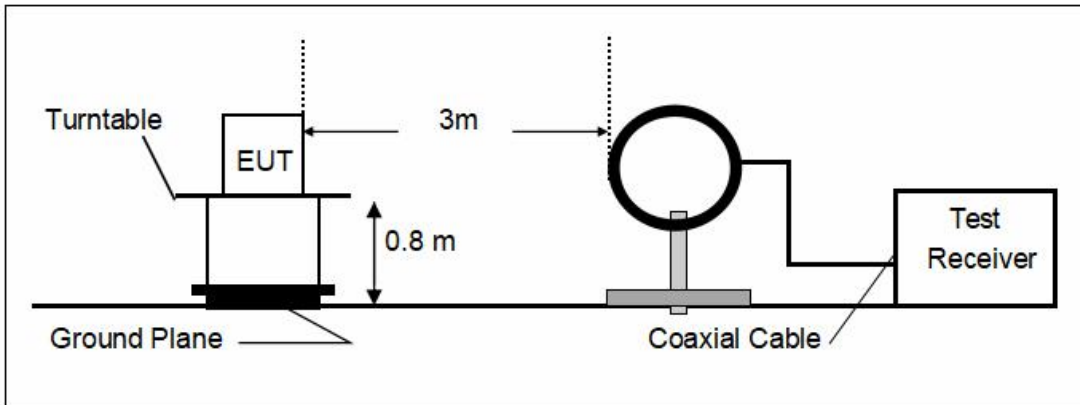

(b) Radiated Emission Test Set-Up, Frequency Below 1000MHz

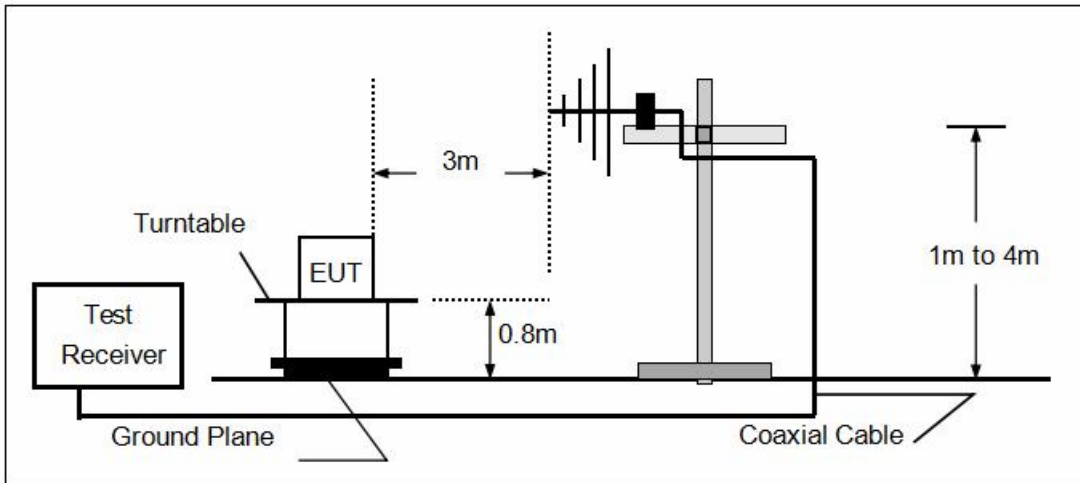

(c) Radiated Emission Test Set-Up, Frequency above 1000MHz

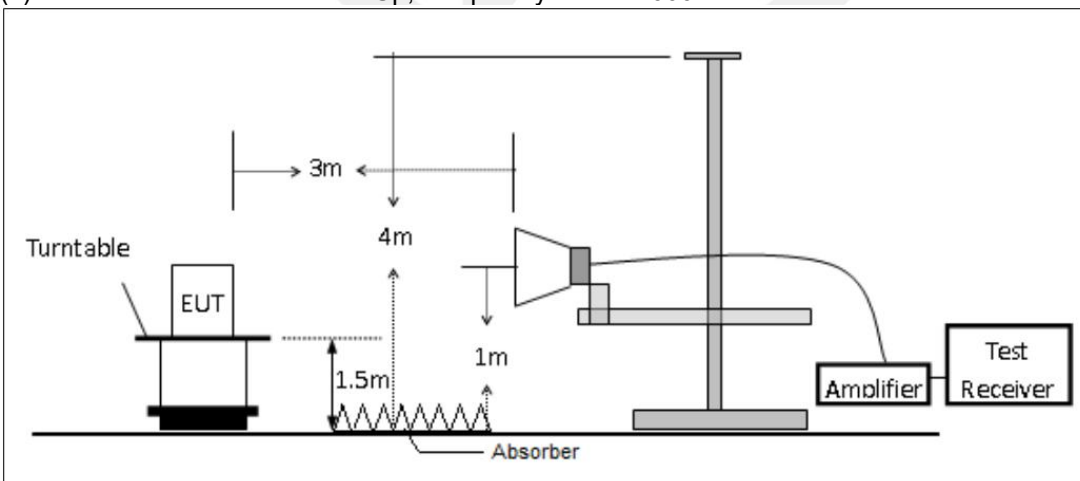



### 7.3 CONDUCTED EMISSION TEST SETUP

The mains cable of the EUT (maybe per AC/DC Adapter) must be connected to LISN. The LISN shall be placed 0.8 m from the boundary of EUT and bonded to a ground reference plane for LISN mounted on top of the ground reference plane. This distance is between the closest points of the LISN and the EUT. All other units of the EUT and associated equipment shall be at least 0.8m from the LISN.

Ground connections, where required for safety purposes, shall be connected to the reference ground point of the LISN and, where not otherwise provided or specified by the manufacturer, shall be of same length as the mains cable and run parallel to the mains connection at a separation distance of not more than 0.1 m.

According to the requirements in Section 13.1.4.1 of ANSI C63.10-2013 Conducted emissions from the EUT measured in the frequency range between 0.15 MHz and 30 MHz using CISPR Quasi-Peak and average detector mode.

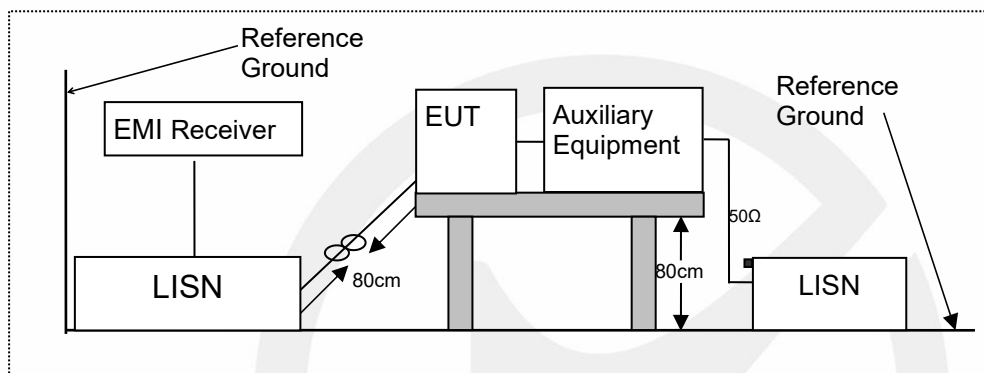

## 7.4 BLOCK DIAGRAM CONFIGURATION OF TEST SYSTEM

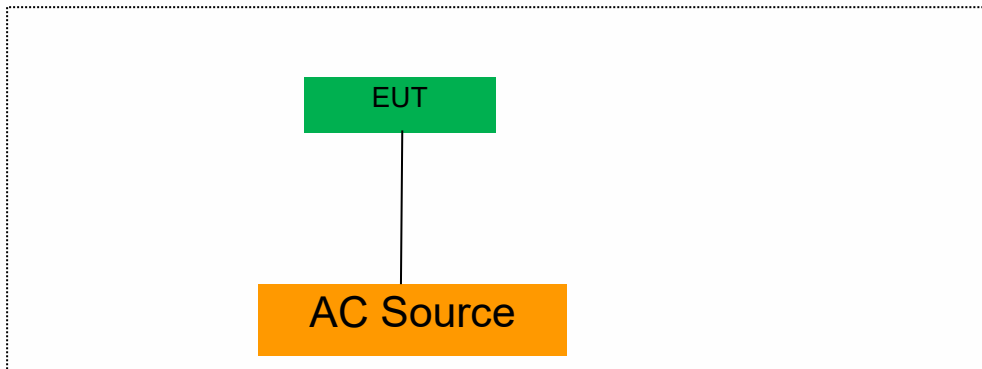

## 7.5 SUPPORT EQUIPMENT

POE Adapter : Model: PSA16U-480(POE)  
Input: 100-240V~0.4A, 50-60Hz  
Output: 48V, 0.32A  
CE, FCC

Power Adapter : Model: RD1201500-C55-198GB  
Input: 100-240V~50/60Hz, 0.6A  
Output: 12V, 1.5A  
CE, FCC

**Notes:**

1. All the equipment/cables were placed in the worst-case configuration to maximize the emission during the test.
2. Grounding was established in accordance with the manufacturer's requirements and conditions for the intended use.

## 8 TEST REQUIREMENTS

### 8.1 BANDWIDTH MEASUREMENT

#### 8.1.1 Applicable Standard

According to FCC Part 15.407(a)(1) for UNII Band I  
According to FCC Part 15.407(a)(2) for UNII Band II-A and UNII Band II-C  
According to FCC Part 15.407(a)(3) for UNII Band III  
According to FCC Part 15.407(e) for UNII Band III  
According to 789033 D02 Section II(C)  
According to 789033 D02 Section II(D)

#### 8.1.2 Conformance Limit

(1) For the band 5.15-5.25 GHz.

(iv) For mobile and portable client devices in the 5.15-5.25 GHz band, the maximum conducted output power over the frequency band of operation shall not exceed 250 mW provided the maximum antenna gain does not exceed 6 dBi. In addition, the maximum power spectral density shall not exceed 11 dBm in any 1 megahertz band. If transmitting antennas of directional gain greater than 6 dBi are used, both the maximum conducted output power and the maximum power spectral density shall be reduced by the amount in dB that the directional gain of the antenna exceeds 6 dBi.

(2) For the 5.25-5.35 GHz and 5.47-5.725 GHz bands, the maximum conducted output power over the frequency bands of operation shall not exceed the lesser of 250 mW or  $11 \text{ dBm} + 10 \log B$ , where B is the 26 dB emission bandwidth in megahertz. In addition, the maximum power spectral density shall not exceed 11 dBm in any 1 megahertz band. If transmitting antennas of directional gain greater than 6 dBi are used, both the maximum conducted output power and the maximum power spectral density shall be reduced by the amount in dB that the directional gain of the antenna exceeds 6 dBi.

(3) For the band 5.725-5.85 GHz, the maximum conducted output power over the frequency band of operation shall not exceed 1 W. In addition, the maximum power spectral density shall not exceed 30 dBm in any 500-kHz band. If transmitting antennas of directional gain greater than 6 dBi are used, both the maximum conducted output power and the maximum power spectral density shall be reduced by the amount in dB that the directional gain of the antenna exceeds 6 dBi. However, fixed point-to-point U-NII devices operating in this band may employ transmitting antennas with directional gain greater than 6 dBi without any corresponding reduction in transmitter conducted power. Fixed, point-to-point operations exclude the use of point-to-multipoint systems, omnidirectional applications, and multiple collocated transmitters transmitting the same information. The operator of the U-NII device, or if the equipment is professionally installed, the installer, is responsible for ensuring that systems employing high gain directional antennas are used exclusively for fixed, point-to-point operations.

(e) Within the 5.725-5.85 GHz band, the minimum 6 dB bandwidth of U-NII devices shall be at least 500 kHz.

#### 8.1.3 Test Configuration

Test according to clause 6.1 radio frequency test setup.

#### 8.1.4 Test Procedure

According to 789033 D02 v02r01 section C&D, the following is the measurement procedure.

##### 1. Emission Bandwidth (EBW)

- a) Set RBW = approximately 1% of the emission bandwidth.
- b) Set the VBW > RBW.
- c) Detector = Peak.
- d) Trace mode = max hold.
- e) Measure the maximum width of the emission that is 26 dB down from the maximum of the emission.

Compare this with the RBW setting of the analyzer. Readjust RBW and repeat measurement as needed until the RBW/EBW ratio is approximately 1%.

## 2. Minimum Emission Bandwidth for the band 5.725-5.85 GHz

Section 15.407(e) specifies the minimum 6 dB emission bandwidth of at least 500 KHz for the band 5.715-5.85 GHz. The following procedure shall be used for measuring this bandwidth:

- a) Set RBW = 100 kHz.
- b) Set the video bandwidth (VBW)  $\geq 3 \times$  RBW.
- c) Detector = Peak.
- d) Trace mode = max hold.
- e) Sweep = auto couple.
- f) Allow the trace to stabilize.
- g) Measure the maximum width of the emission that is constrained by the frequencies associated with the two outermost amplitude points (upper and lower frequencies) that are attenuated by 6 dB relative to the maximum level measured in the fundamental emission.

Note: The automatic bandwidth measurement capability of a spectrum analyzer or EMI receiver may be employed if it implements the functionality described above.

## D. 99 Percent Occupied Bandwidth

The 99-percent occupied bandwidth is the frequency bandwidth such that, below its lower and above its upper frequency limits, the mean powers are each equal to 0.5 % of the total mean power of the given emission. Measurement of the 99-percent occupied bandwidth is required only as a condition for using the optional band-edge measurement techniques described in section II.G.3.d). Measurements of 99-percent occupied bandwidth may also optionally be used in lieu of the EBW to 789033 D02 v01r02 General UNII Test Procedures New Rules v01 define the minimum frequency range over which the spectrum is integrated when measuring maximum conducted output power as described in section II.E. However, the EBW must be measured to determine bandwidth dependent limits on maximum conducted output power in accordance with 15.407(a).

The following procedure shall be used for measuring (99 %) power bandwidth:

1. Set center frequency to the nominal EUT channel center frequency.
2. Set span = 1.5 times to 5.0 times the OBW.
3. Set RBW = 1 % to 5 % of the OBW.
4. Set VBW  $\geq 3 \times$  RBW.
5. Video averaging is not permitted. Where practical, a sample detection and single sweep mode shall be used. Otherwise, peak detection and max hold mode (until the trace stabilizes) shall be used.
6. Use the 99 % power bandwidth function of the instrument (if available).
7. If the instrument does not have a 99 % power bandwidth function, the trace data points are recovered and directly summed in power units. The recovered amplitude data points, beginning at the lowest frequency, are placed in a running sum until 0.5 % of the total is reached; that frequency is recorded as the lower frequency. The process is repeated until 99.5 % of the total is reached; that frequency is recorded as the upper frequency. The 99% occupied bandwidth is the difference between these two frequencies.

8.1.5 Test Results

Temperature : 25°C  
Humidity : 60 %

ATM Pressure:: 1011 mbar  
Test Engineer: XXH

**Emission Bandwidth (26dB)**

TestMode	Antenna	Frequency[MHz]	26db EBW [MHz]	FL[MHz]	FH[MHz]	Limit[MHz]	Verdict	
11A	Ant1	5180	19.80	5170.04	5189.84	---	---	
	Ant2	5180	19.52	5170.24	5189.76	---	---	
	Ant1	5200	19.76	5190.08	5209.84	---	---	
	Ant2	5200	19.56	5190.20	5209.76	---	---	
	Ant1	5240	19.96	5230.04	5250.00	---	---	
	Ant2	5240	19.52	5230.16	5249.68	---	---	
	Ant1	5260	19.92	5250.00	5269.92	---	---	
	Ant2	5260	19.60	5250.16	5269.76	---	---	
	Ant1	5280	19.92	5270.04	5289.96	---	---	
	Ant2	5280	19.60	5270.16	5289.76	---	---	
	Ant1	5320	19.80	5310.08	5329.88	---	---	
	Ant2	5320	19.60	5310.16	5329.76	---	---	
	Ant1	5500	19.88	5490.04	5509.92	---	---	
	Ant2	5500	19.48	5490.20	5509.68	---	---	
	Ant1	5580	19.88	5570.00	5589.88	---	---	
	Ant2	5580	19.68	5570.20	5589.88	---	---	
	Ant1	5700	19.92	5690.04	5709.96	---	---	
	Ant2	5700	19.68	5690.16	5709.84	---	---	
	Ant1	5745	19.84	5735.04	5754.88	---	---	
	Ant2	5745	19.48	5735.28	5754.76	---	---	
	Ant1	5785	19.72	5775.12	5794.84	---	---	
	Ant2	5785	19.72	5775.12	5794.84	---	---	
	11N20MIMO	Ant1	5825	19.80	5815.08	5834.88	---	---
		Ant2	5825	19.56	5815.24	5834.80	---	---
Ant1		5180	20.08	5169.96	5190.04	---	---	
Ant2		5180	20.24	5169.92	5190.16	---	---	
Ant1		5200	20.36	5189.84	5210.20	---	---	
Ant2		5200	20.16	5189.88	5210.04	---	---	
Ant1		5240	20.28	5229.88	5250.16	---	---	
Ant2		5240	20.24	5229.84	5250.08	---	---	
Ant1		5260	20.16	5249.92	5270.08	---	---	
Ant2		5260	20.04	5249.96	5270.00	---	---	
Ant1		5280	20.24	5269.84	5290.08	---	---	
Ant2		5280	20.04	5269.96	5290.00	---	---	
Ant1		5320	20.12	5309.92	5330.04	---	---	
Ant2		5320	19.88	5310.08	5329.96	---	---	
Ant1		5500	20.24	5489.84	5510.08	---	---	
Ant2		5500	20.00	5489.96	5509.96	---	---	
Ant1		5580	20.24	5569.92	5590.16	---	---	
Ant2		5580	20.00	5570.00	5590.00	---	---	
Ant1		5700	20.20	5689.92	5710.12	---	---	
Ant2		5700	19.96	5690.04	5710.00	---	---	
Ant1		5745	20.20	5734.88	5755.08	---	---	
Ant2		5745	20.04	5734.96	5755.00	---	---	
Ant1		5785	20.16	5774.92	5795.08	---	---	

	Ant2	5785	20.08	5775.00	5795.08	---	---	
	Ant1	5825	20.16	5814.92	5835.08	---	---	
	Ant2	5825	20.04	5814.92	5834.96	---	---	
11N40MIMO	Ant1	5190	40.88	5169.60	5210.48	---	---	
	Ant2	5190	40.32	5169.84	5210.16	---	---	
	Ant1	5230	40.72	5209.68	5250.40	---	---	
	Ant2	5230	40.40	5209.76	5250.16	---	---	
	Ant1	5270	40.88	5249.60	5290.48	---	---	
	Ant2	5270	40.40	5249.76	5290.16	---	---	
	Ant1	5310	41.04	5289.52	5330.56	---	---	
	Ant2	5310	40.40	5289.76	5330.16	---	---	
	Ant1	5510	41.52	5489.28	5530.80	---	---	
	Ant2	5510	40.32	5489.84	5530.16	---	---	
	Ant1	5550	41.60	5529.36	5570.96	---	---	
	Ant2	5550	40.08	5529.92	5570.00	---	---	
	Ant1	5670	41.20	5649.44	5690.64	---	---	
	Ant2	5670	40.32	5649.84	5690.16	---	---	
	Ant1	5755	40.96	5734.60	5775.56	---	---	
	Ant2	5755	40.32	5734.84	5775.16	---	---	
	Ant1	5795	40.88	5774.60	5815.48	---	---	
	Ant2	5795	40.40	5774.76	5815.16	---	---	
	11AC20MIMO	Ant1	5180	20.36	5169.80	5190.16	---	---
		Ant2	5180	20.20	5169.88	5190.08	---	---
Ant1		5200	20.24	5189.92	5210.16	---	---	
Ant2		5200	20.20	5189.88	5210.08	---	---	
Ant1		5240	20.36	5229.84	5250.20	---	---	
Ant2		5240	20.24	5229.88	5250.12	---	---	
Ant1		5260	20.12	5249.92	5270.04	---	---	
Ant2		5260	20.08	5249.92	5270.00	---	---	
Ant1		5280	20.16	5269.92	5290.08	---	---	
Ant2		5280	20.04	5269.96	5290.00	---	---	
Ant1		5320	20.32	5309.84	5330.16	---	---	
Ant2		5320	20.04	5310.00	5330.04	---	---	
Ant1		5500	20.20	5489.88	5510.08	---	---	
Ant2		5500	20.16	5489.92	5510.08	---	---	
Ant1		5580	20.28	5569.92	5590.20	---	---	
Ant2		5580	20.00	5570.00	5590.00	---	---	
Ant1		5700	20.24	5689.92	5710.16	---	---	
Ant2		5700	20.04	5689.96	5710.00	---	---	
Ant1		5745	20.32	5734.84	5755.16	---	---	
Ant2		5745	20.00	5735.04	5755.04	---	---	
Ant1		5785	20.12	5774.96	5795.08	---	---	
Ant2		5785	20.00	5775.04	5795.04	---	---	
Ant1		5825	20.20	5814.88	5835.08	---	---	
Ant2		5825	20.00	5815.00	5835.00	---	---	
11AC40MIMO		Ant1	5190	41.20	5169.44	5210.64	---	---
		Ant2	5190	40.40	5169.84	5210.24	---	---
		Ant1	5230	41.28	5209.44	5250.72	---	---
		Ant2	5230	40.72	5209.68	5250.40	---	---
	Ant1	5270	41.28	5249.44	5290.72	---	---	
	Ant2	5270	40.88	5249.52	5290.40	---	---	
	Ant1	5310	41.20	5289.44	5330.64	---	---	
	Ant2	5310	40.48	5289.76	5330.24	---	---	
	Ant1	5510	41.36	5489.36	5530.72	---	---	
	Ant2	5510	40.64	5489.60	5530.24	---	---	

	Ant1	5550	41.20	5529.44	5570.64	---	---
	Ant2	5550	40.40	5529.84	5570.24	---	---
	Ant1	5670	41.44	5649.36	5690.80	---	---
	Ant2	5670	40.48	5649.76	5690.24	---	---
	Ant1	5755	41.20	5734.44	5775.64	---	---
	Ant2	5755	40.48	5734.84	5775.32	---	---
	Ant1	5795	41.44	5774.36	5815.80	---	---
	Ant2	5795	40.40	5774.76	5815.16	---	---
11AC80MIMO	Ant1	5210	81.28	5169.36	5250.64	---	---
	Ant2	5210	80.80	5169.52	5250.32	---	---
	Ant1	5290	81.28	5249.52	5330.80	---	---
	Ant2	5290	81.12	5249.52	5330.64	---	---
	Ant1	5530	81.28	5489.36	5570.64	---	---
	Ant2	5530	81.28	5489.20	5570.48	---	---
	Ant1	5610	81.76	5569.04	5650.80	---	---
	Ant2	5610	80.80	5569.68	5650.48	---	---
	Ant1	5775	81.12	5734.52	5815.64	---	---
	Ant2	5775	80.64	5734.68	5815.32	---	---

## 11A\_Ant1\_5180

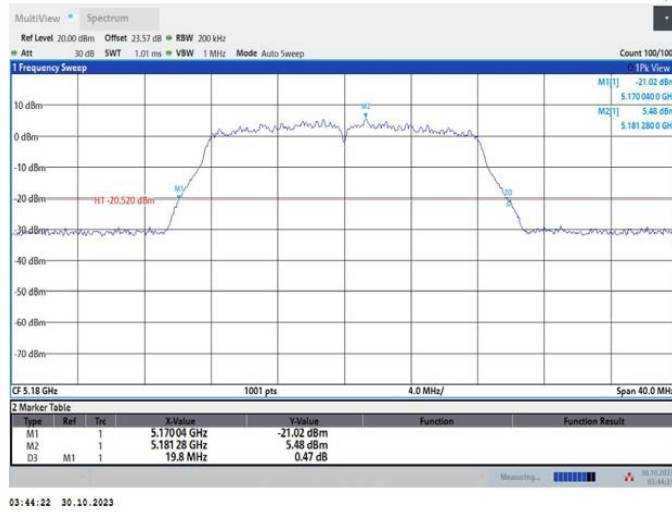

## 11A\_Ant2\_5180

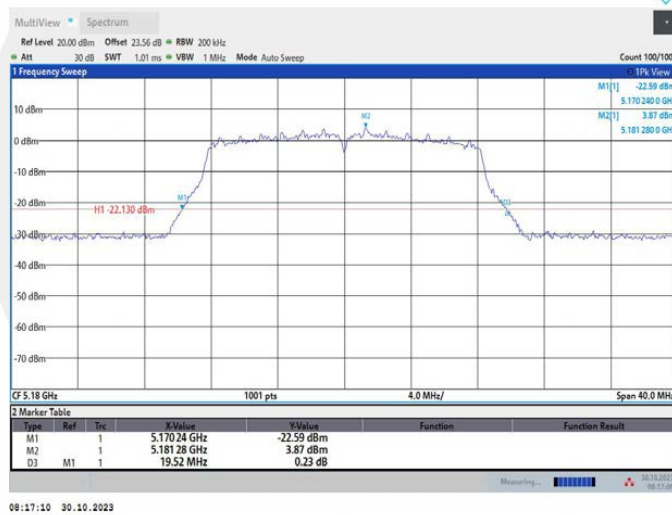

## 11A\_Ant1\_5200

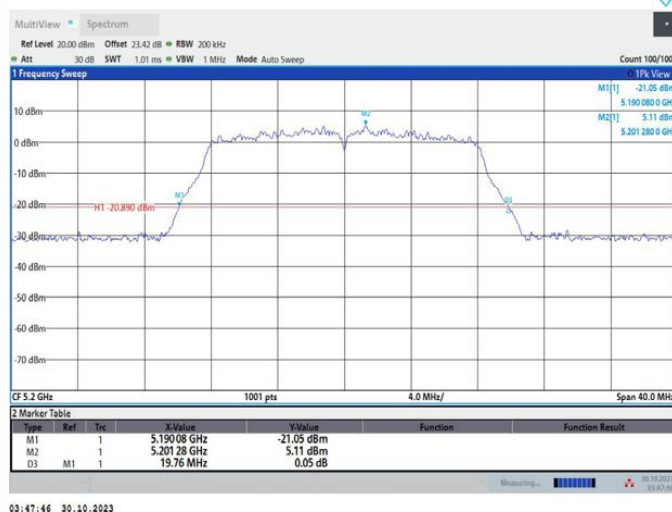



## 11A\_Ant2\_5200

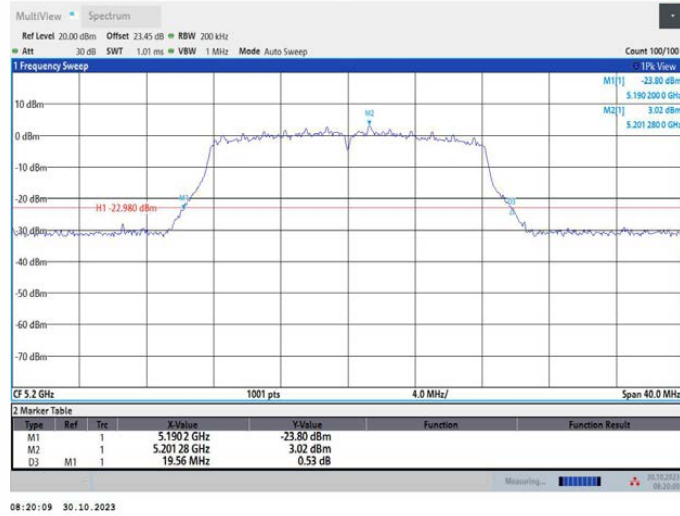

## 11A\_Ant1\_5240

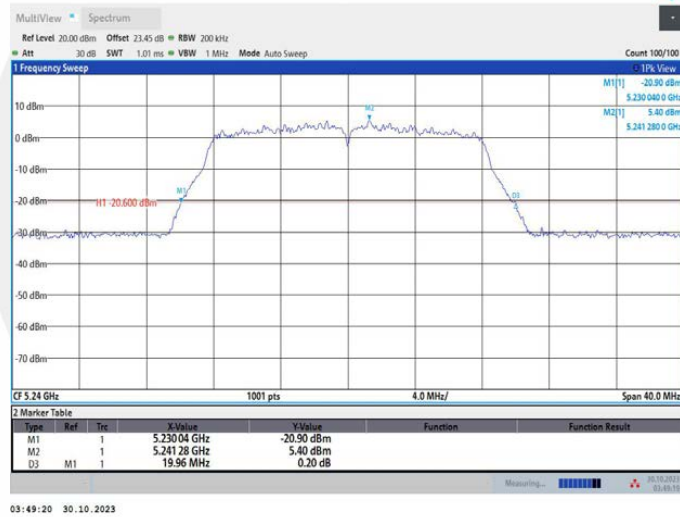

## 11A\_Ant2\_5240

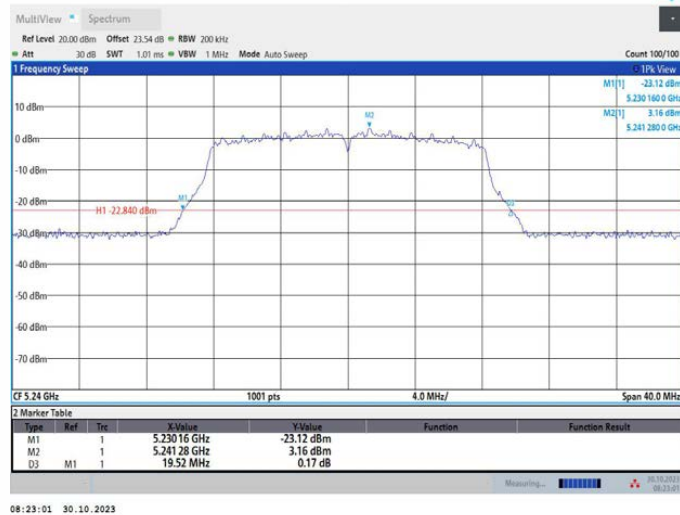

## 11A\_Ant1\_5260

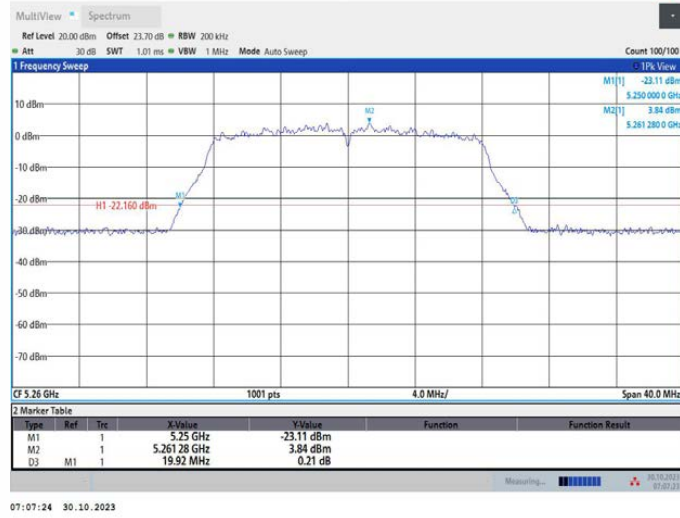

## 11A\_Ant2\_5260

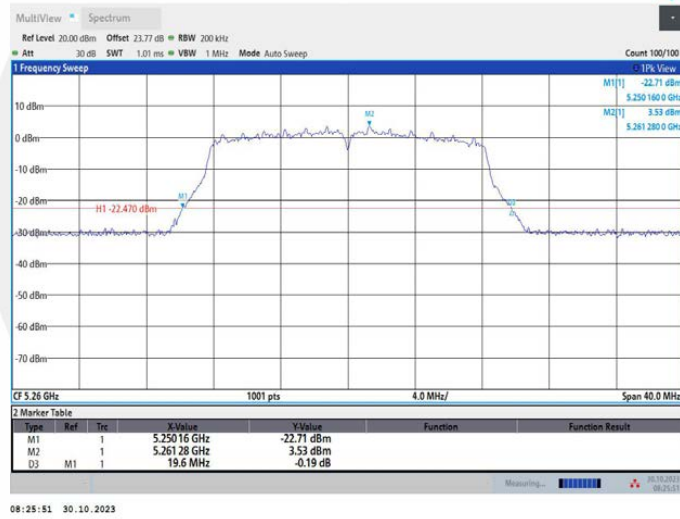

## 11A\_Ant1\_5280

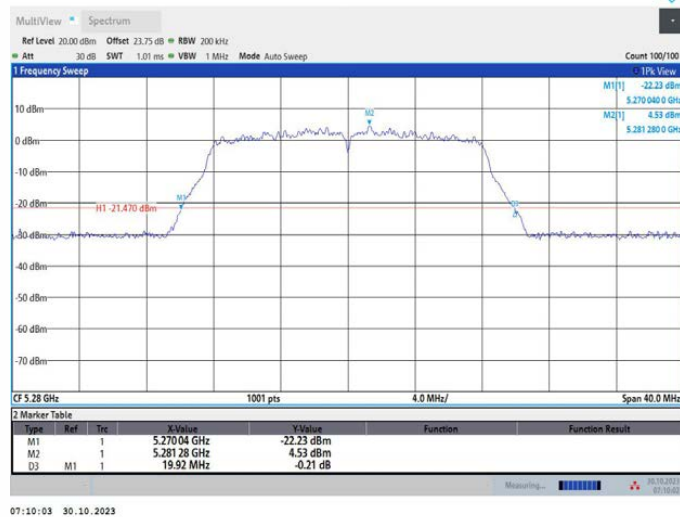

## 11A\_Ant2\_5280

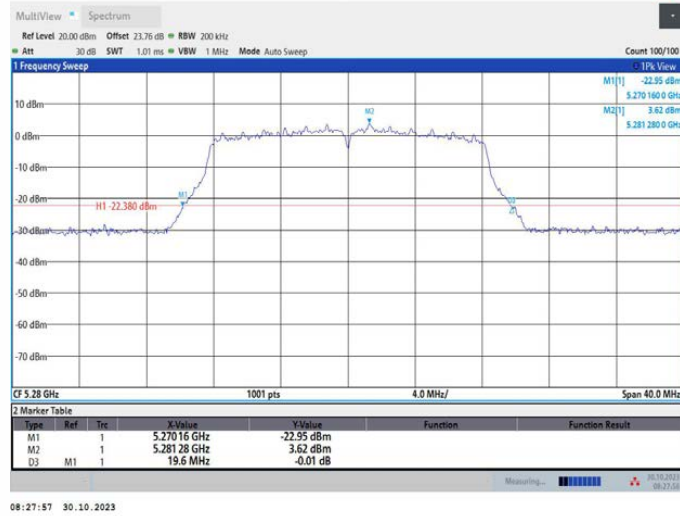

## 11A\_Ant1\_5320

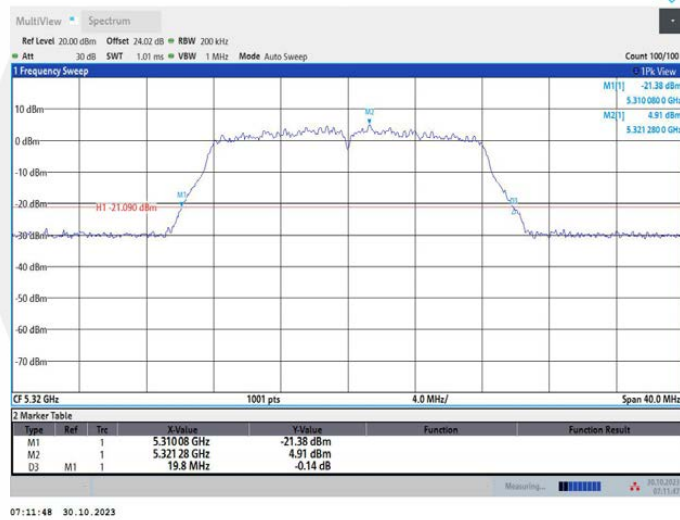

## 11A\_Ant2\_5320

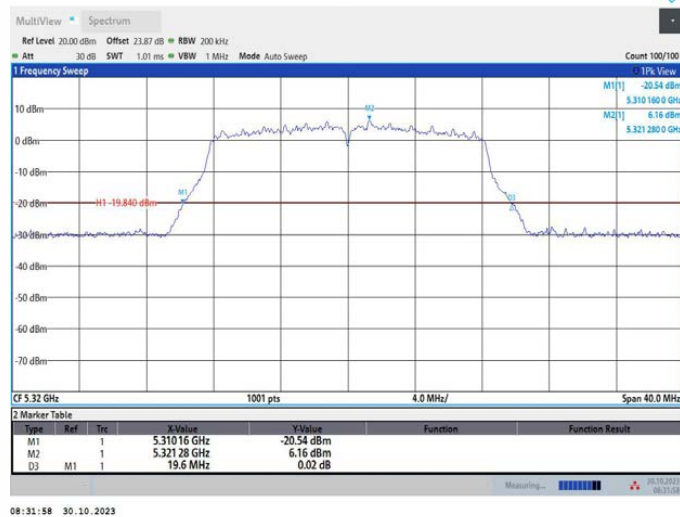

## 11A\_Ant1\_5500

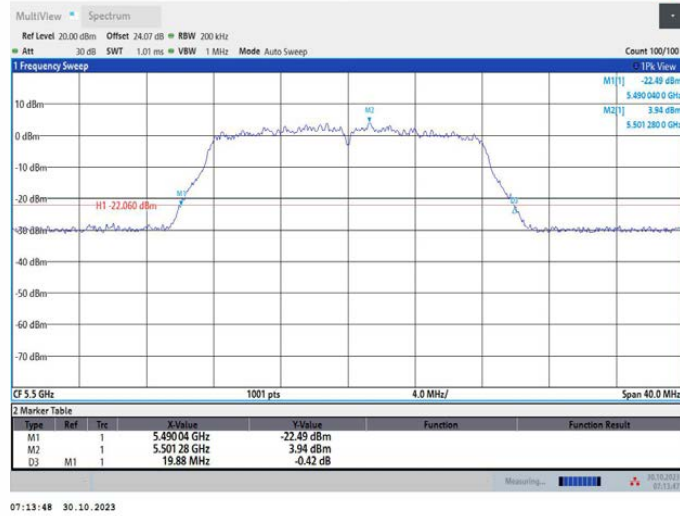

## 11A\_Ant2\_5500

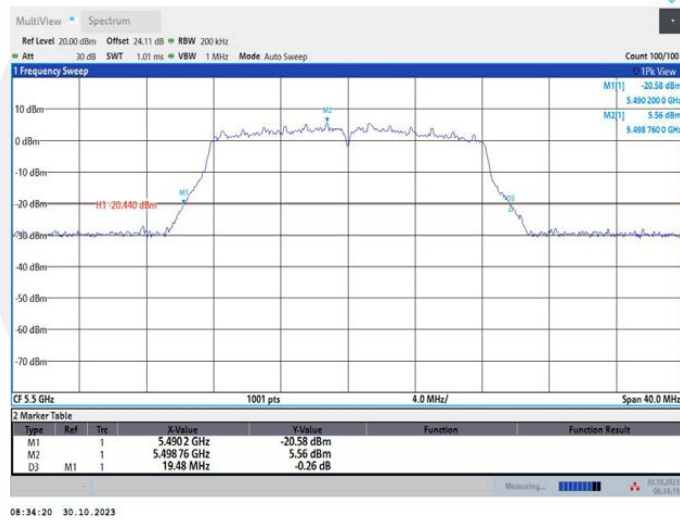

## 11A\_Ant1\_5580

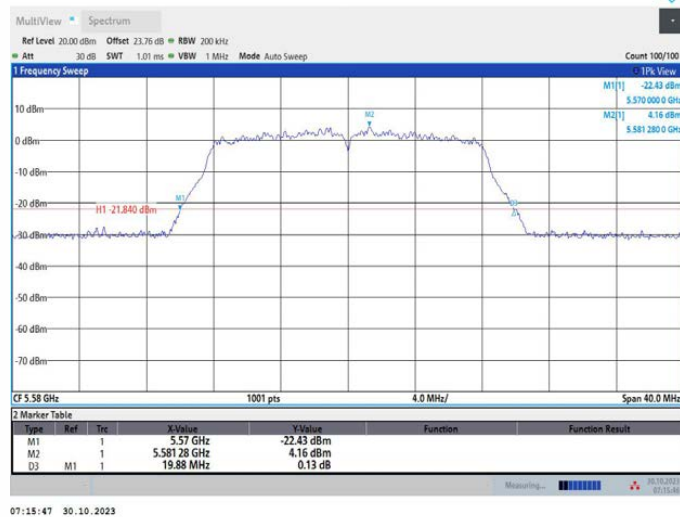

## 11A\_Ant2\_5580

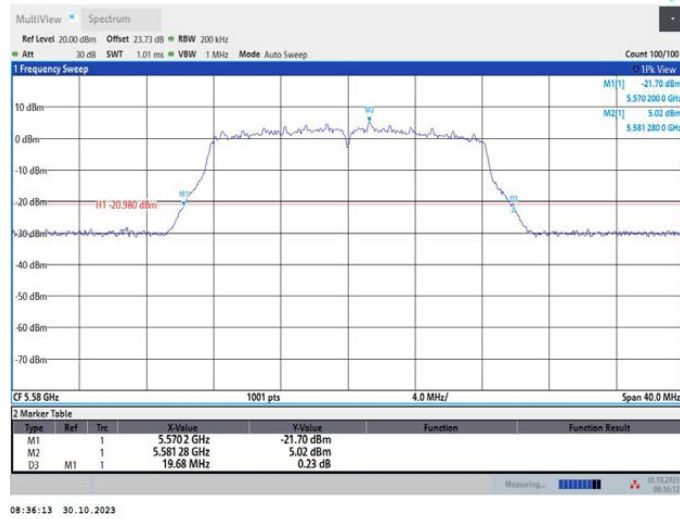

## 11A\_Ant1\_5700

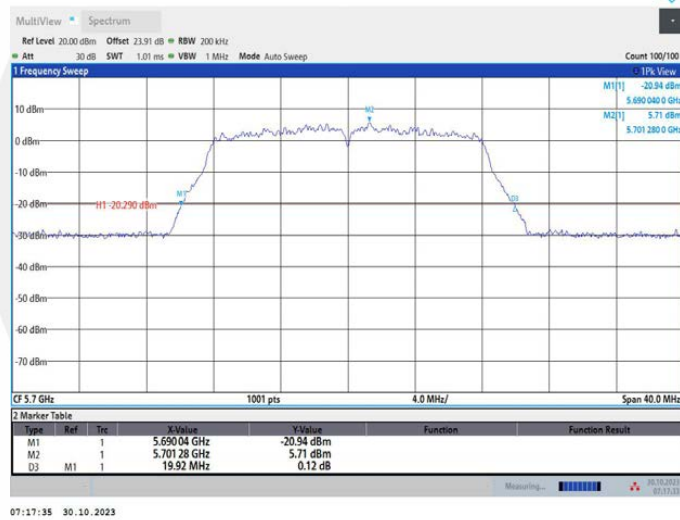

## 11A\_Ant2\_5700

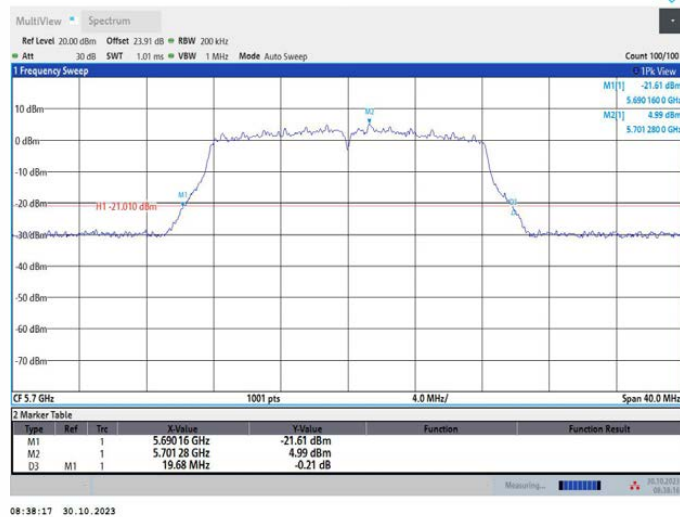

## 11A\_Ant1\_5745

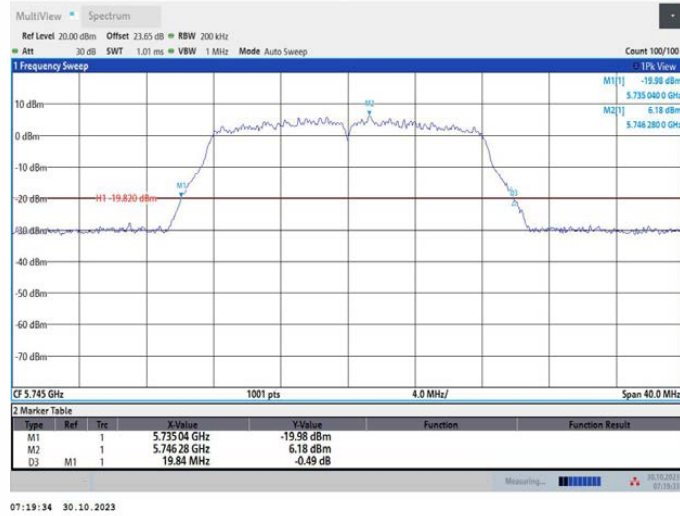

## 11A\_Ant2\_5745

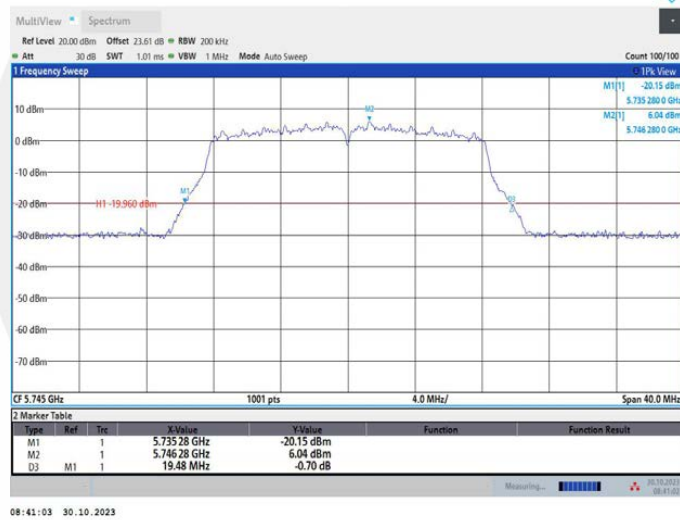

## 11A\_Ant1\_5785

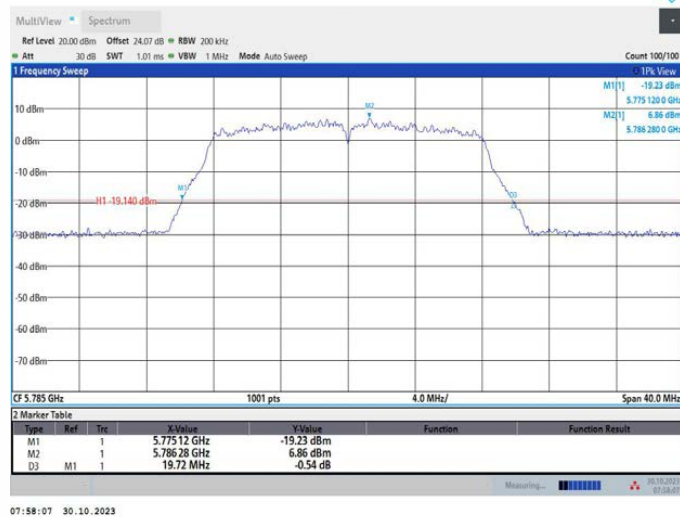

## 11A\_Ant2\_5785

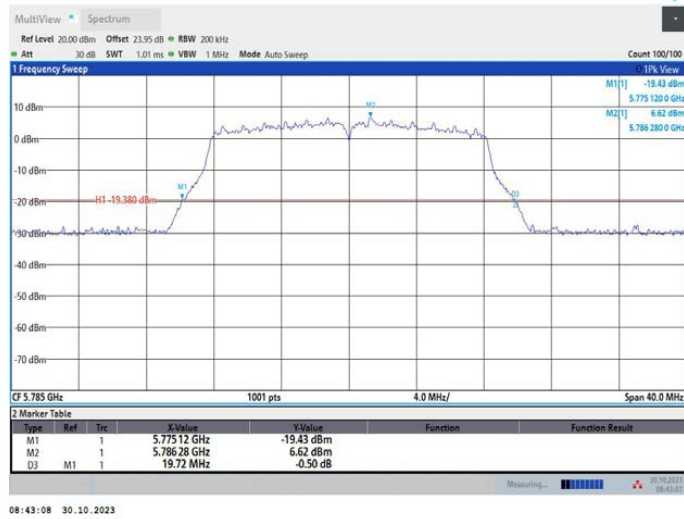

## 11A\_Ant1\_5825

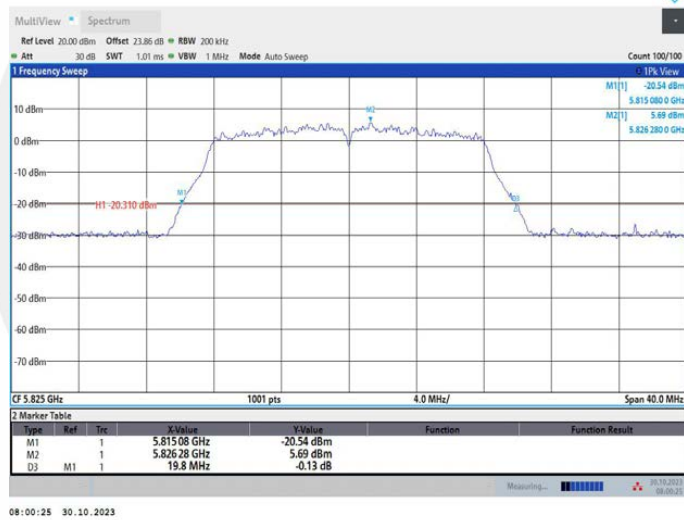

## 11A\_Ant2\_5825

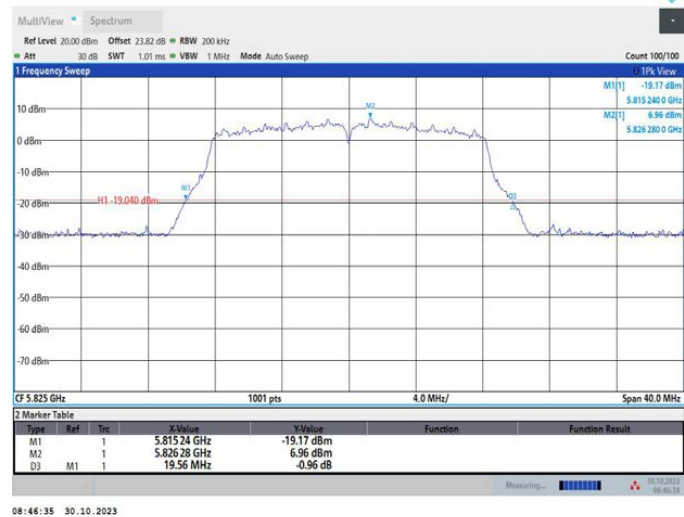

### 11N20MIMO\_Ant1\_5180

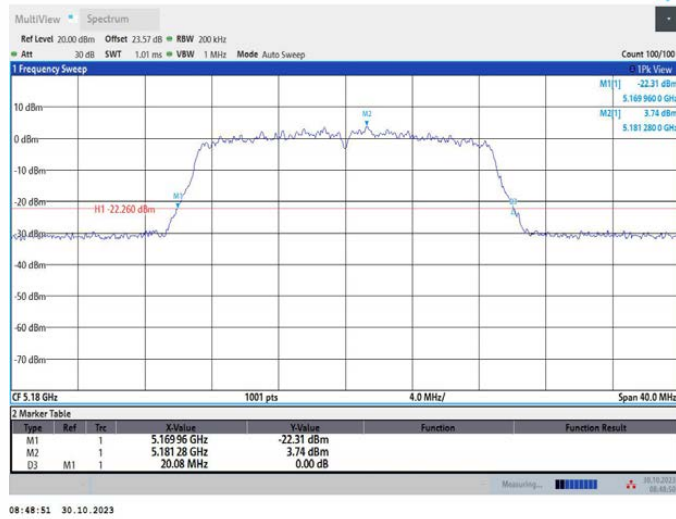

### 11N20MIMO\_Ant2\_5180

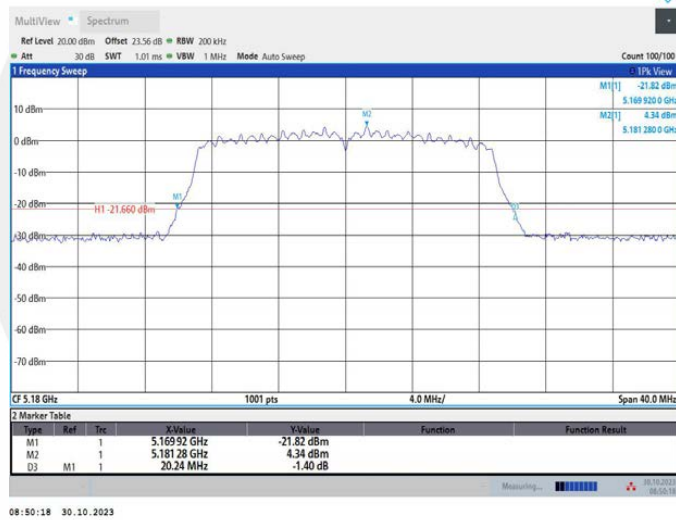

### 11N20MIMO\_Ant1\_5200

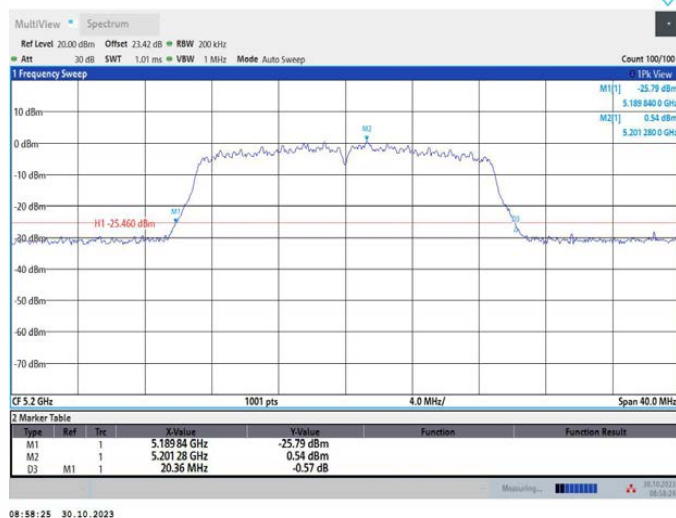



### 11N20MIMO\_Ant2\_5200

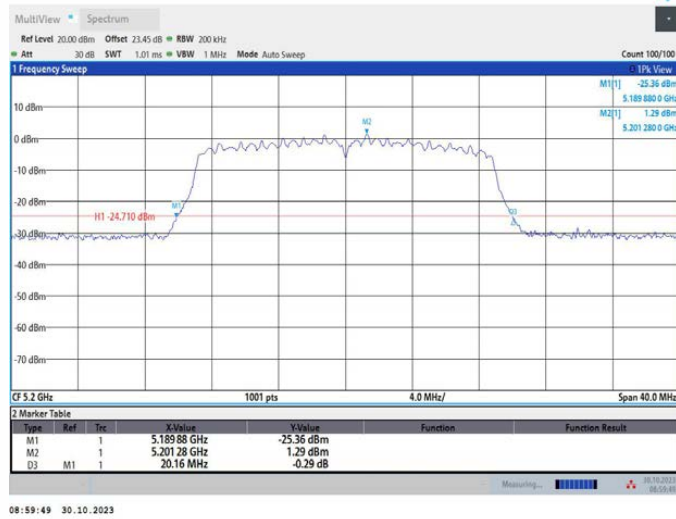

### 11N20MIMO\_Ant1\_5240

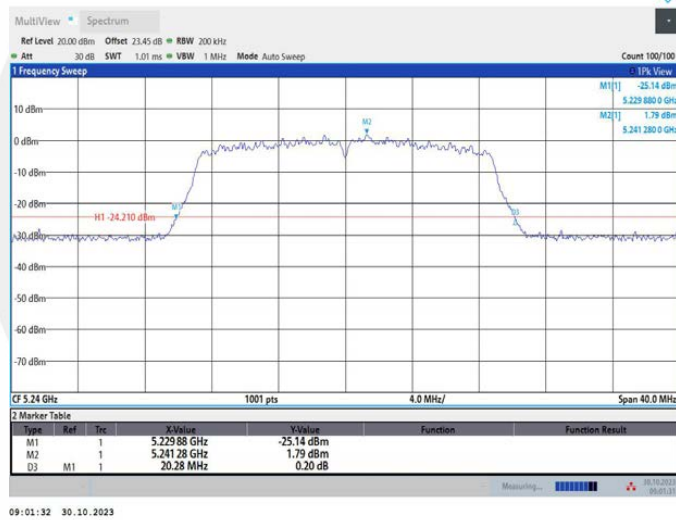

### 11N20MIMO\_Ant2\_5240

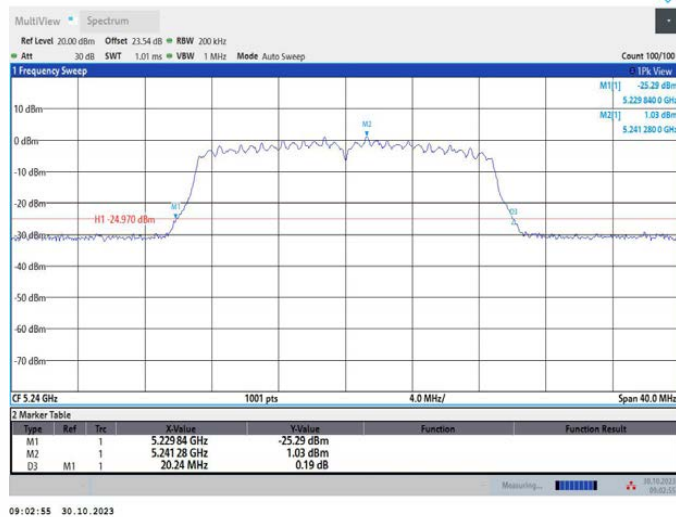

## 11N20MIMO\_Ant1\_5260

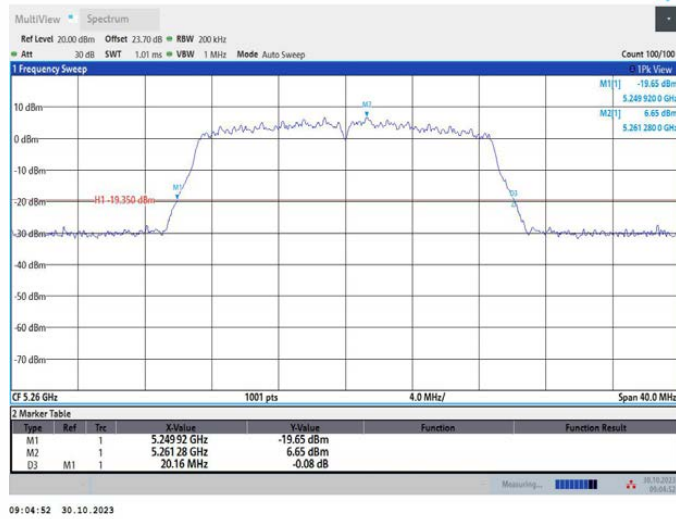

## 11N20MIMO\_Ant2\_5260

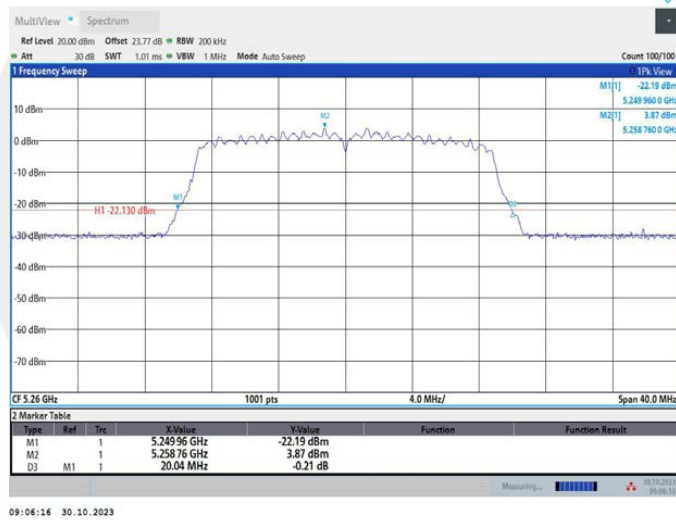

## 11N20MIMO\_Ant1\_5280

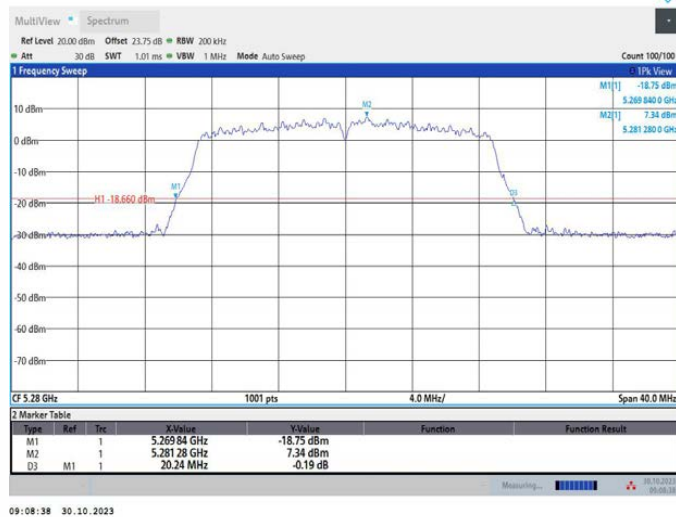

## 11N20MIMO\_Ant2\_5280

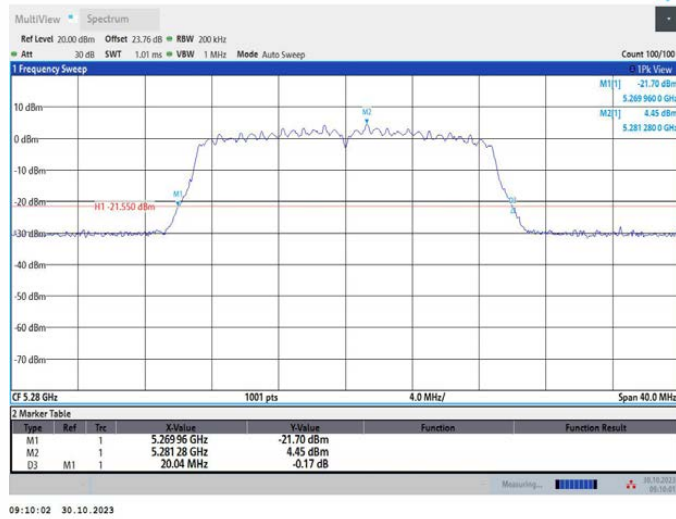

## 11N20MIMO\_Ant1\_5320

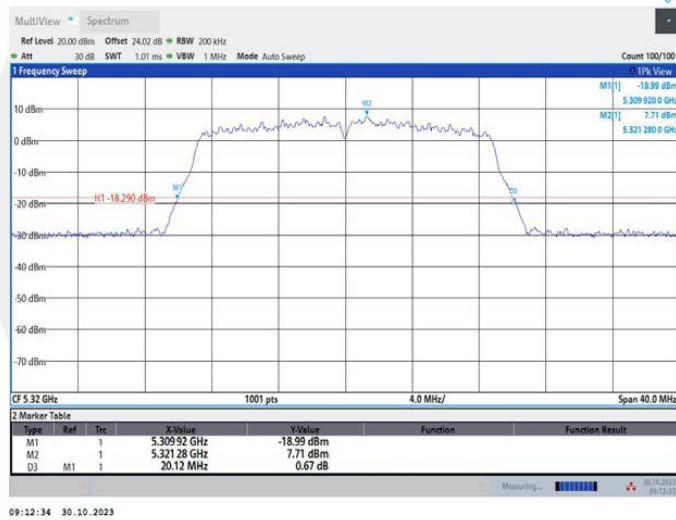

## 11N20MIMO\_Ant2\_5320

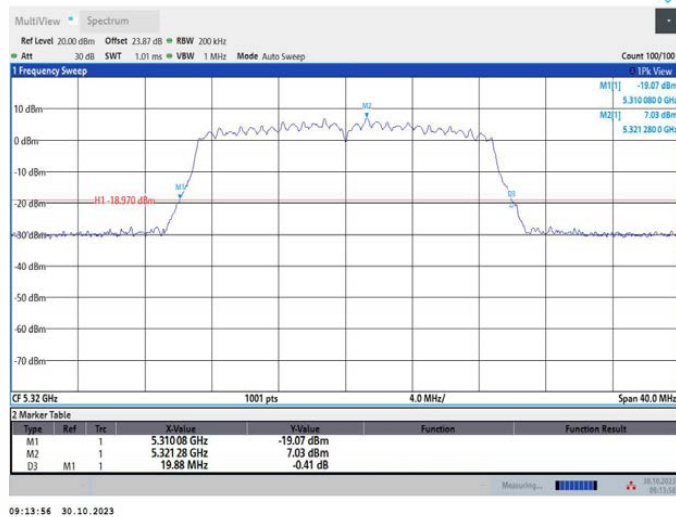

## 11N20MIMO\_Ant1\_5500

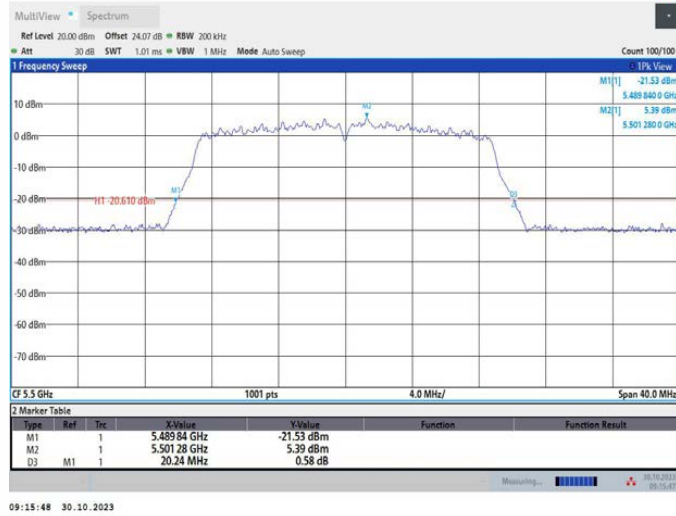

## 11N20MIMO\_Ant2\_5500

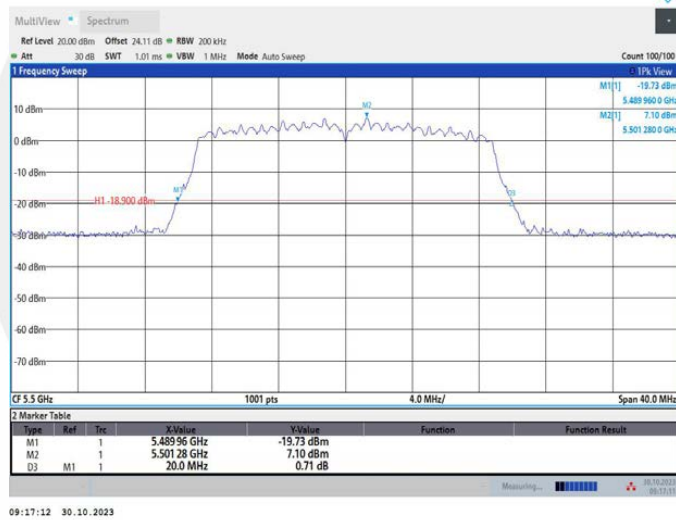

## 11N20MIMO\_Ant1\_5580

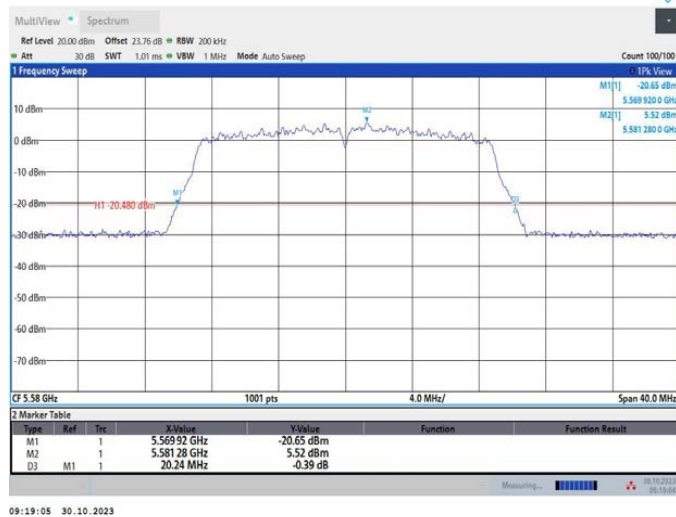

## 11N20MIMO\_Ant2\_5580

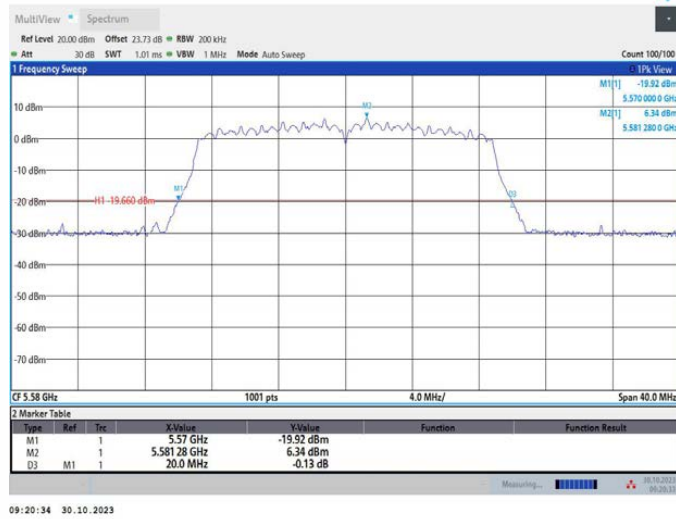

## 11N20MIMO\_Ant1\_5700

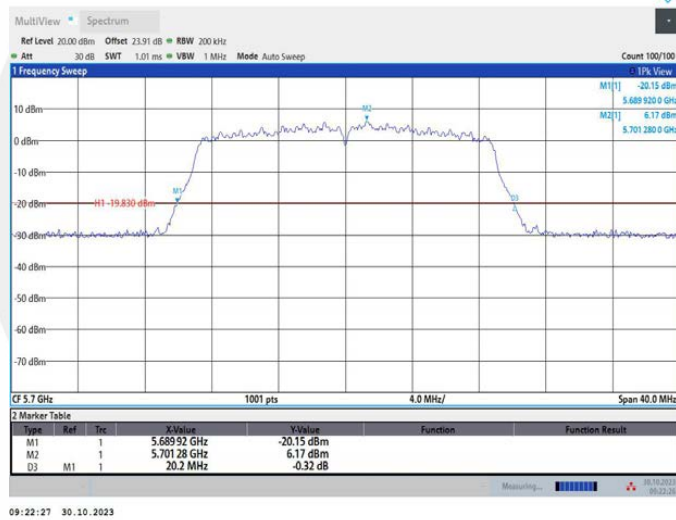

## 11N20MIMO\_Ant2\_5700

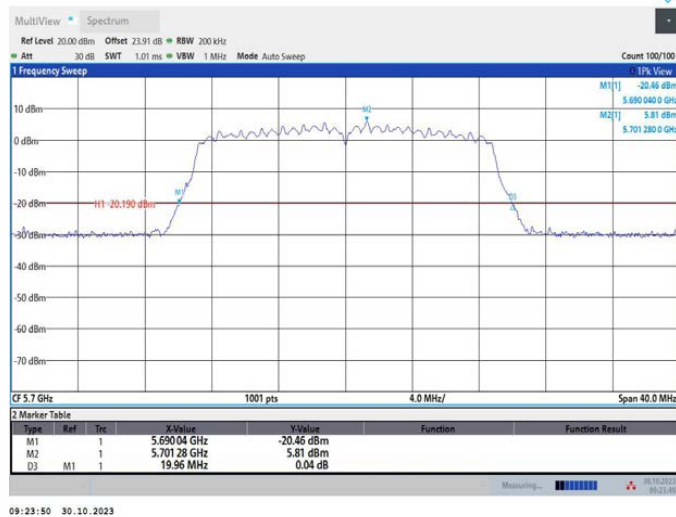

### 11N20MIMO\_Ant1\_5745

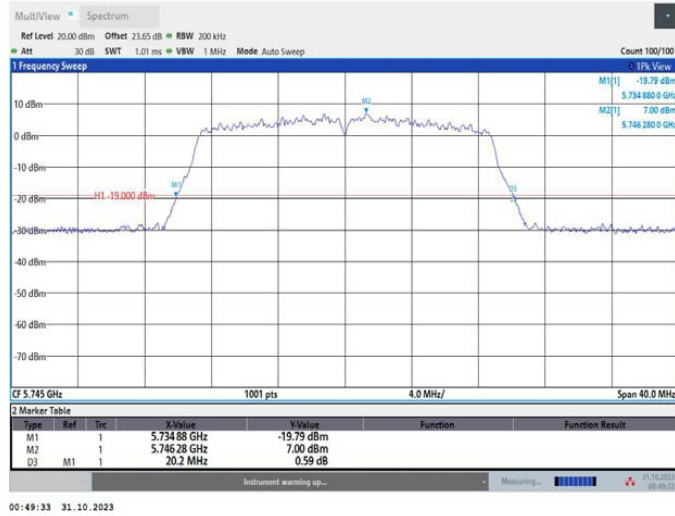

### 11N20MIMO\_Ant2\_5745

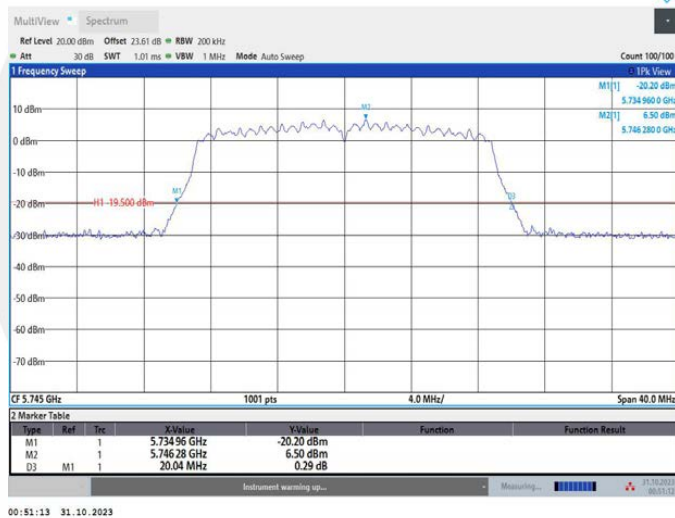

### 11N20MIMO\_Ant1\_5785

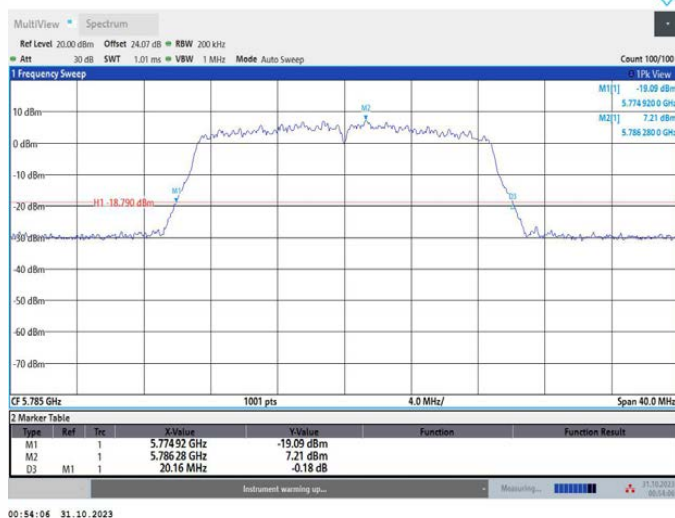

## 11N20MIMO\_Ant2\_5785

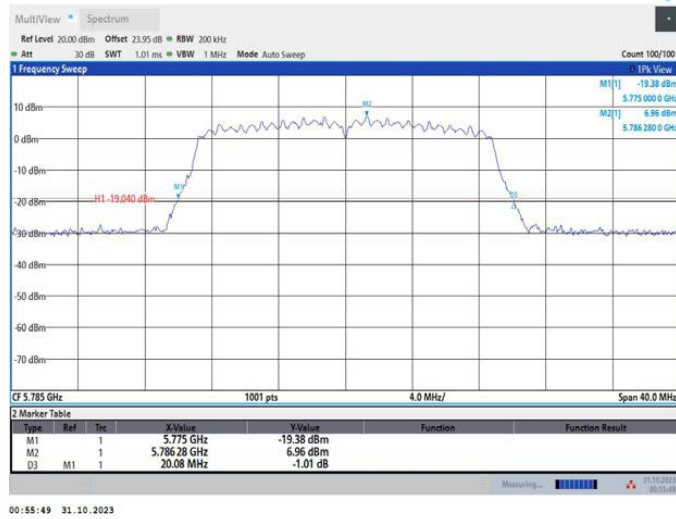

## 11N20MIMO\_Ant1\_5825

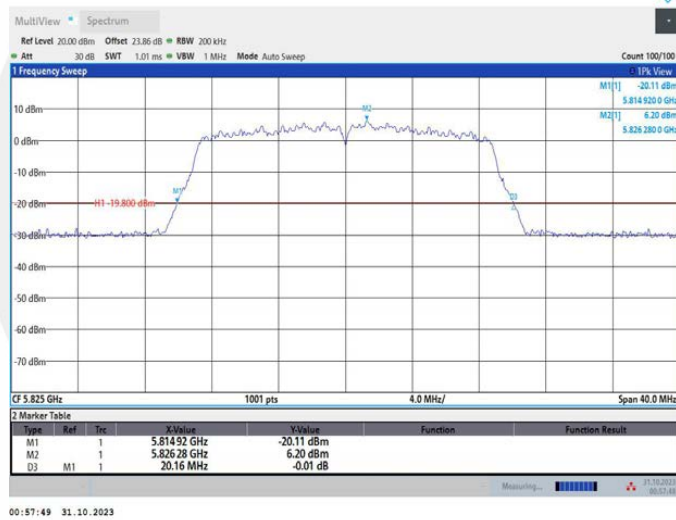

## 11N20MIMO\_Ant2\_5825

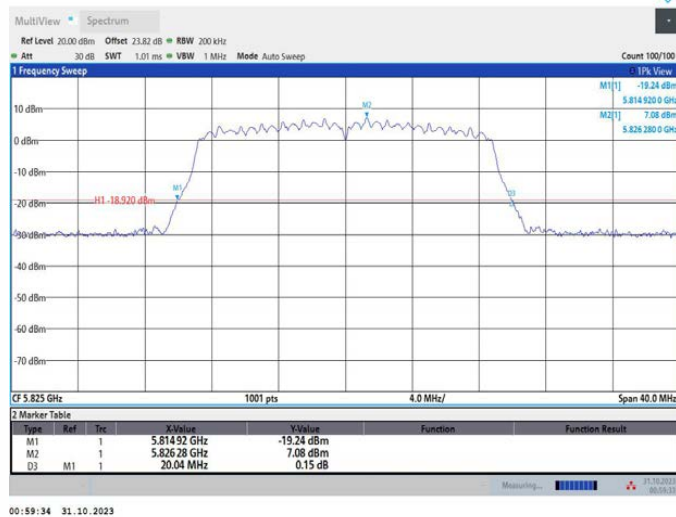

### 11N40MIMO\_Ant1\_5190



### 11N40MIMO\_Ant2\_5190



### 11N40MIMO\_Ant1\_5230

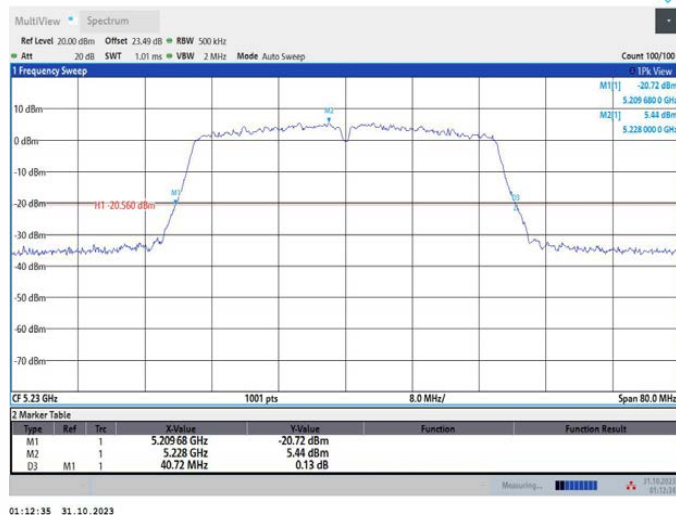



## 11N40MIMO\_Ant2\_5230

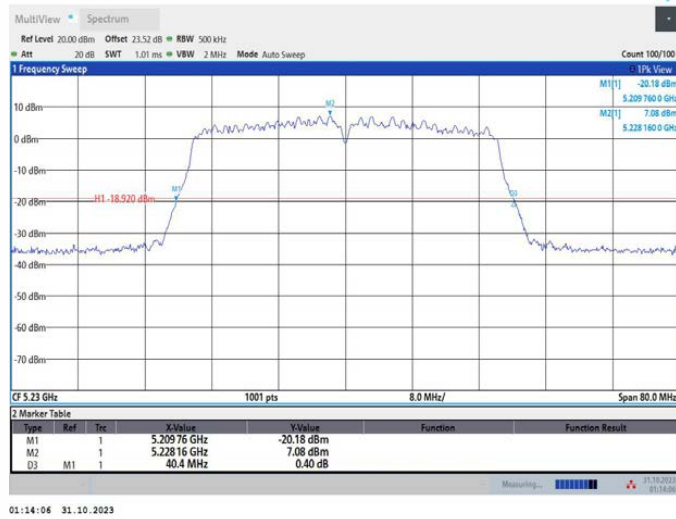

## 11N40MIMO\_Ant1\_5270

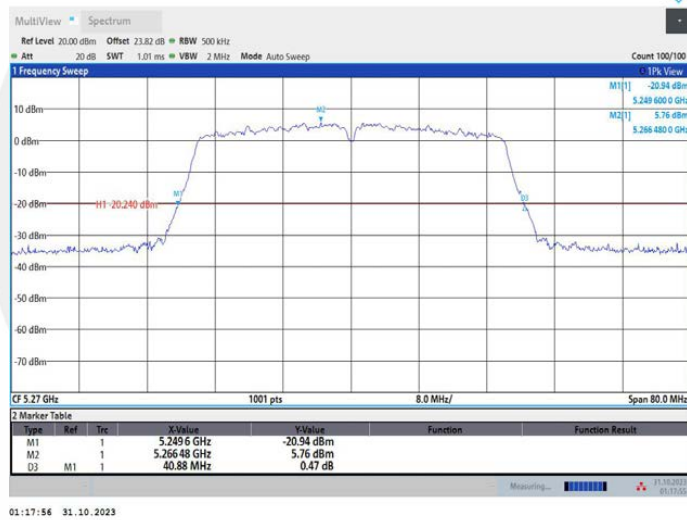

## 11N40MIMO\_Ant2\_5270

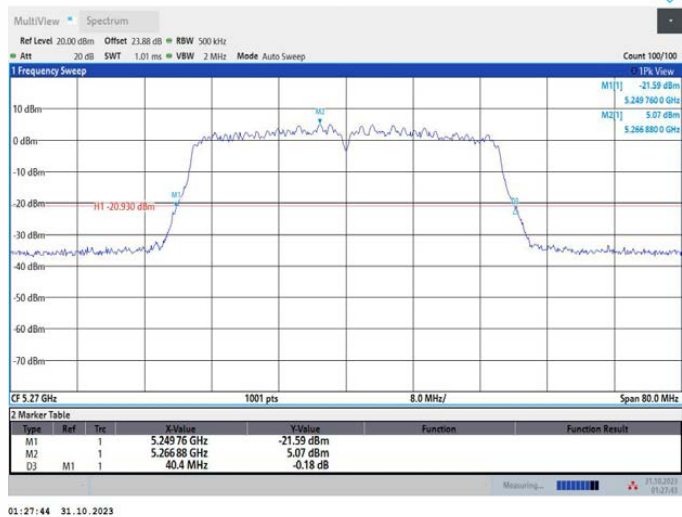

### 11N40MIMO\_Ant1\_5310

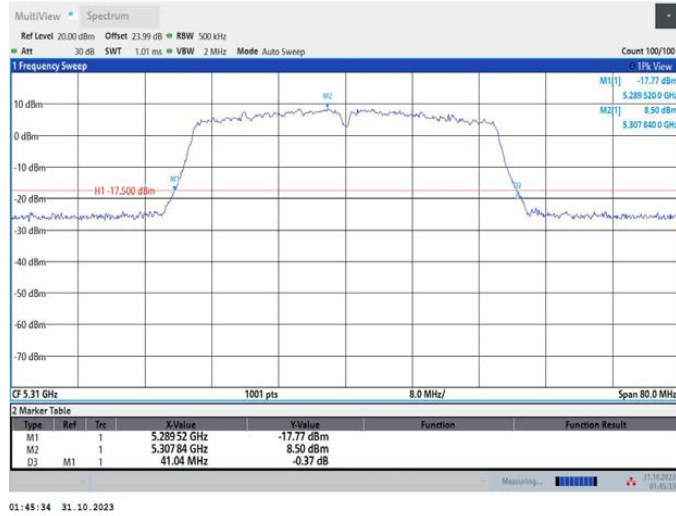

### 11N40MIMO\_Ant2\_5310

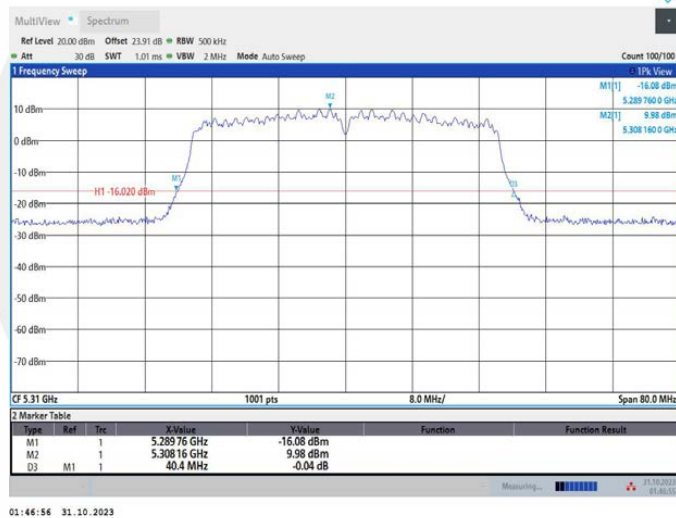

### 11N40MIMO\_Ant1\_5510

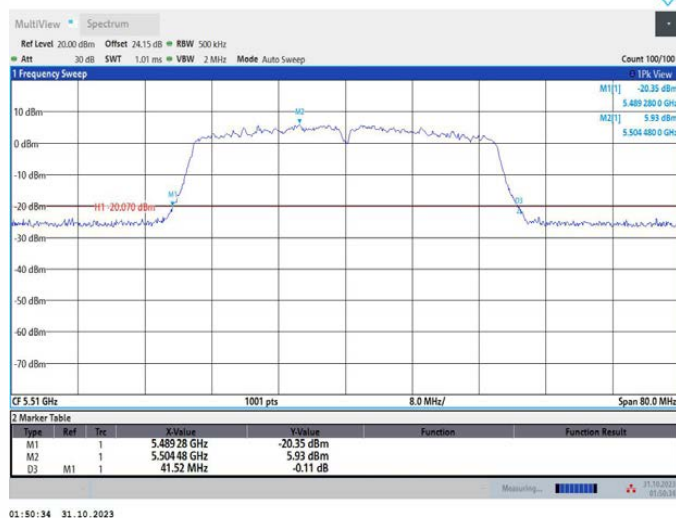

### 11N40MIMO\_Ant2\_5510

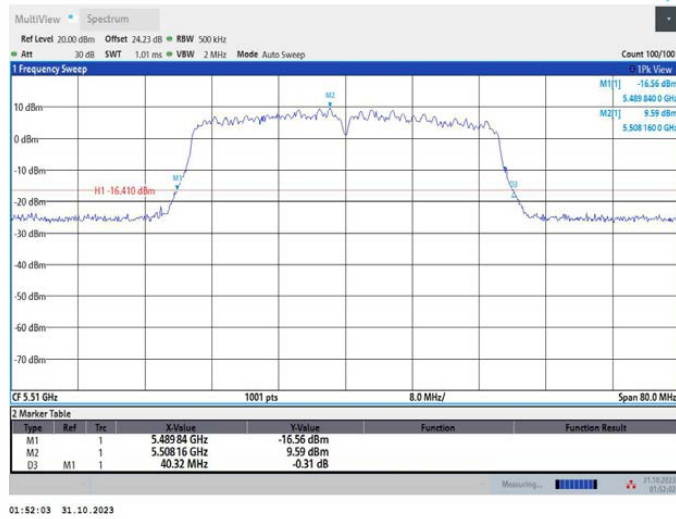

01:52:03 31.10.2023

### 11N40MIMO\_Ant1\_5550

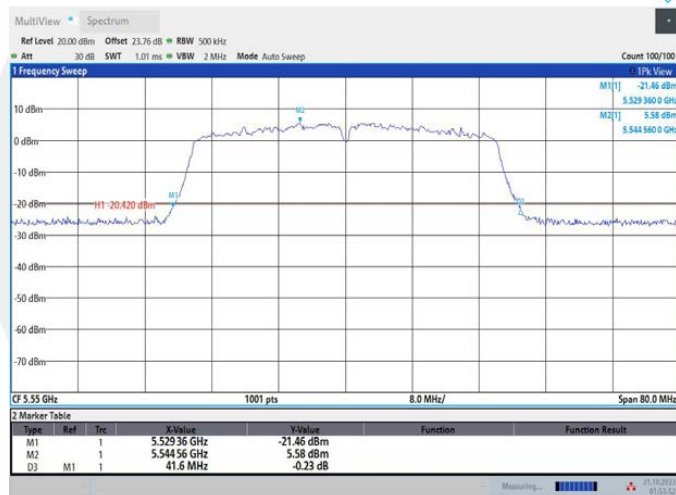

01:53:53 31.10.2023

### 11N40MIMO\_Ant2\_5550

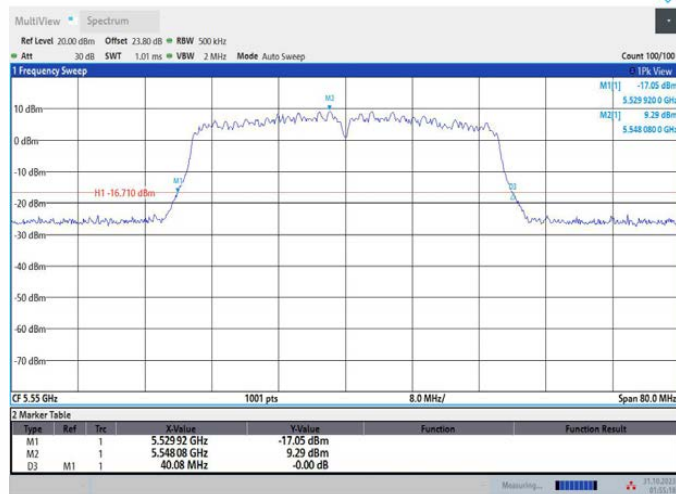

01:55:18 31.10.2023

### 11N40MIMO\_Ant1\_5670



### 11N40MIMO\_Ant2\_5670

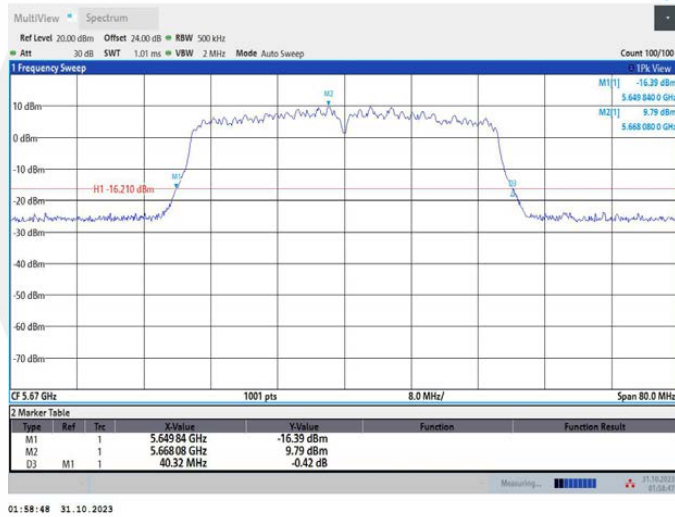

### 11N40MIMO\_Ant1\_5755

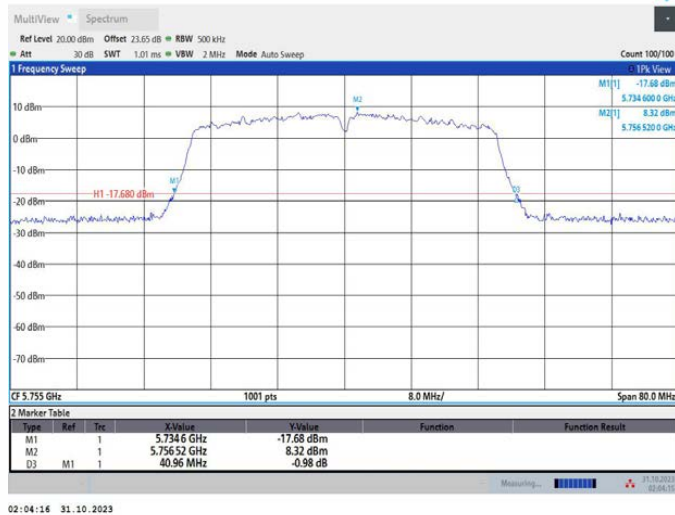

## 11N40MIMO\_Ant2\_5755

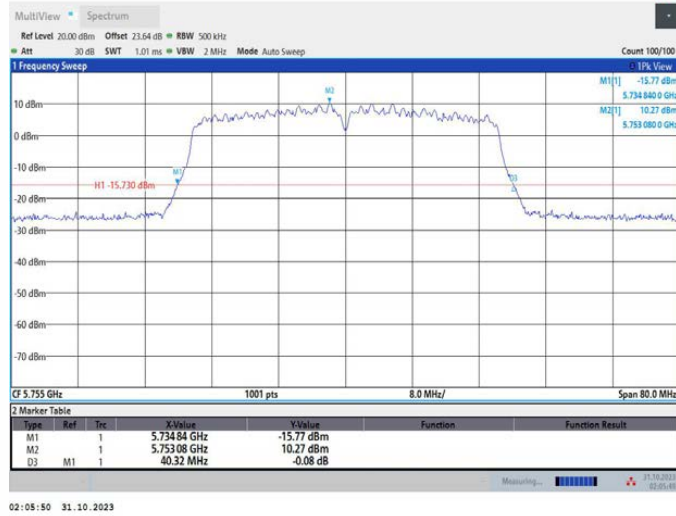

## 11N40MIMO\_Ant1\_5795

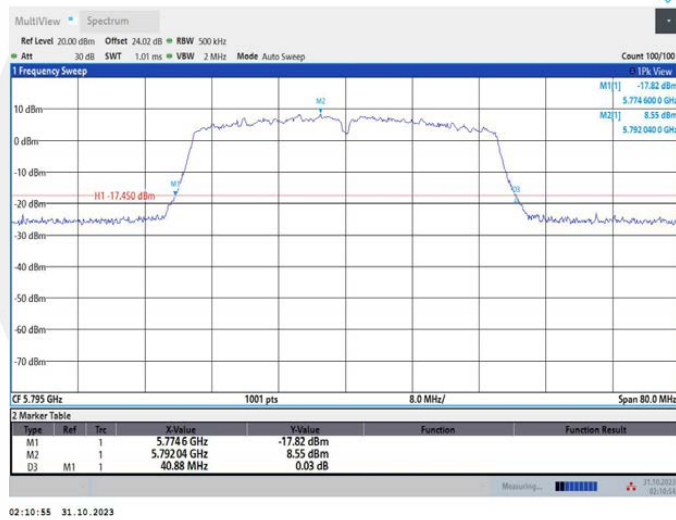

## 11N40MIMO\_Ant2\_5795

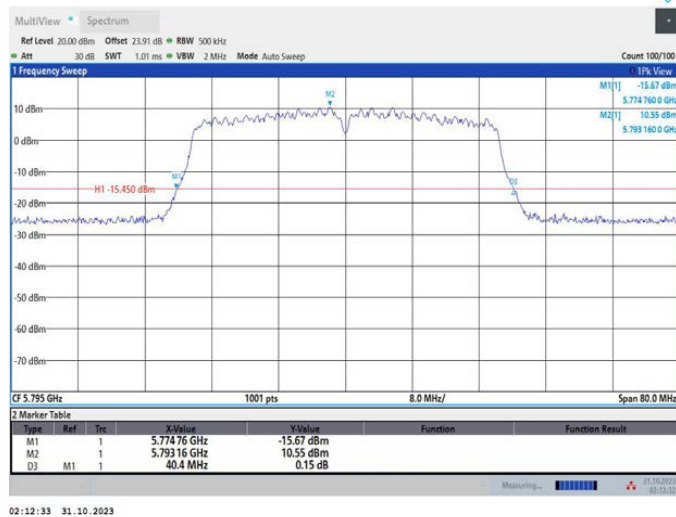

### 11AC20MIMO\_Ant1\_5180

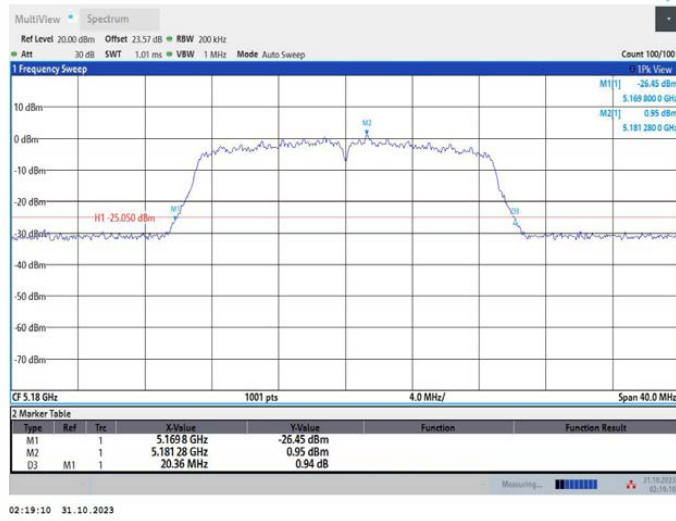

### 11AC20MIMO\_Ant2\_5180

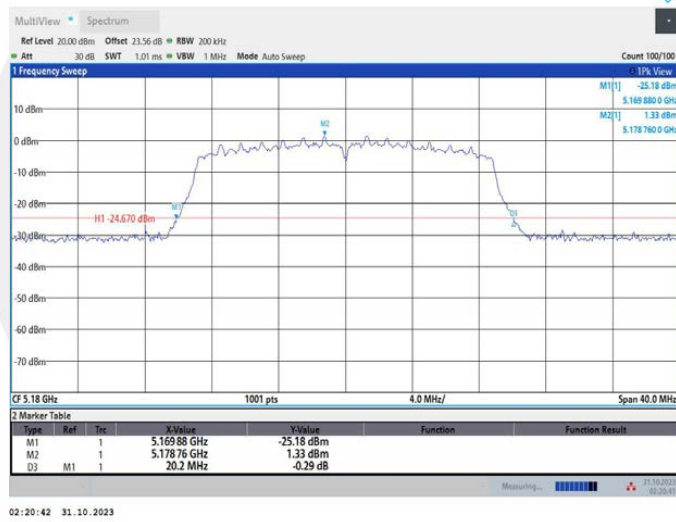

### 11AC20MIMO\_Ant1\_5200

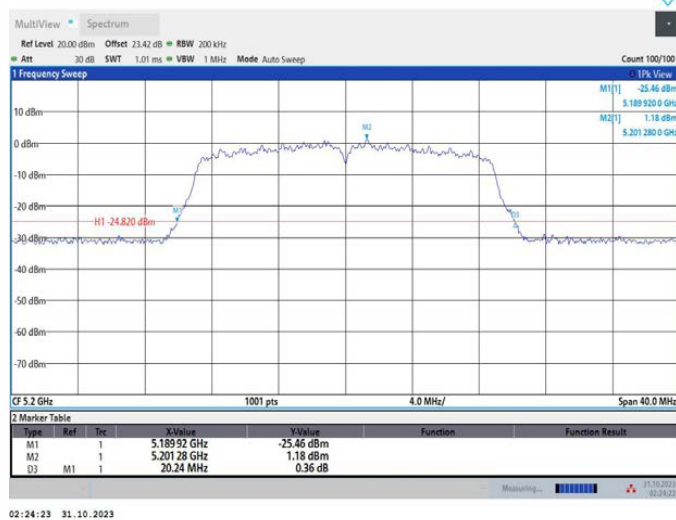

### 11AC20MIMO\_Ant2\_5200

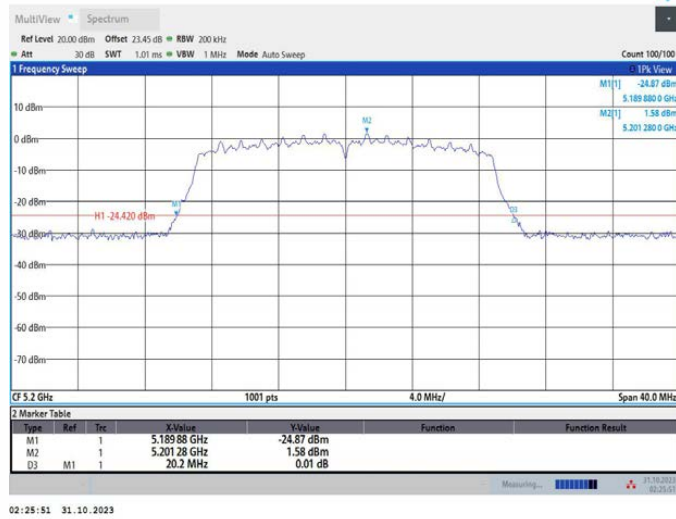

### 11AC20MIMO\_Ant1\_5240

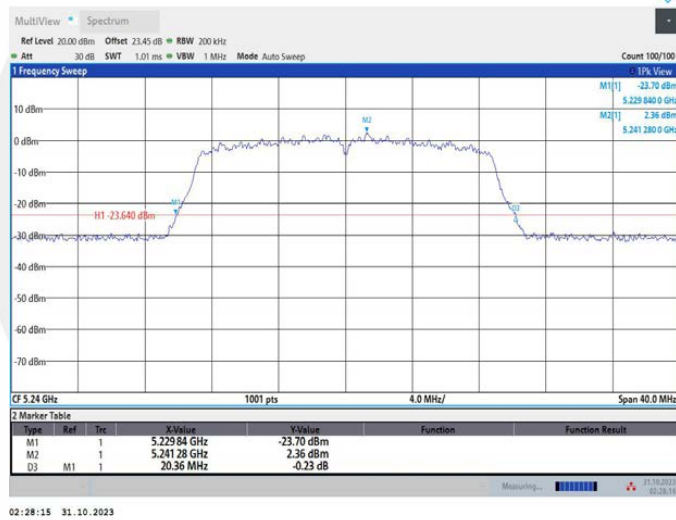

### 11AC20MIMO\_Ant2\_5240

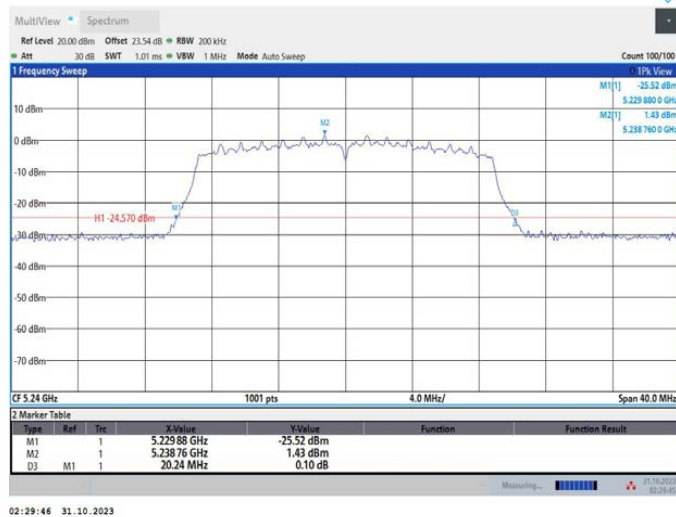

11AC20MIMO\_Ant1\_5260

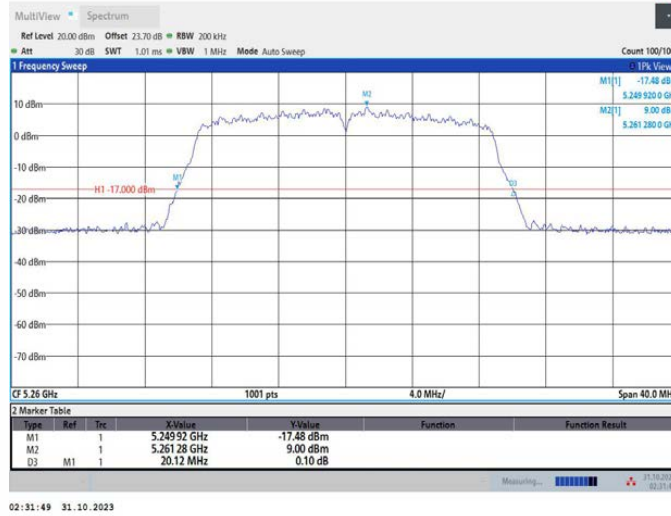

02:31:49 31.10.2023

11AC20MIMO\_Ant2\_5260

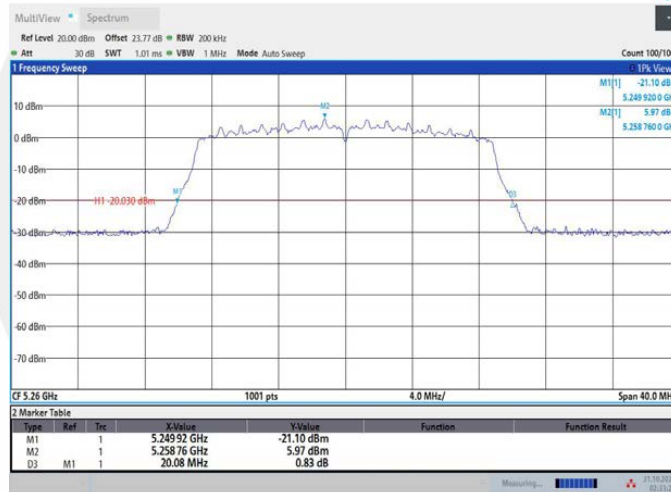

02:33:21 31.10.2023

11AC20MIMO\_Ant1\_5280

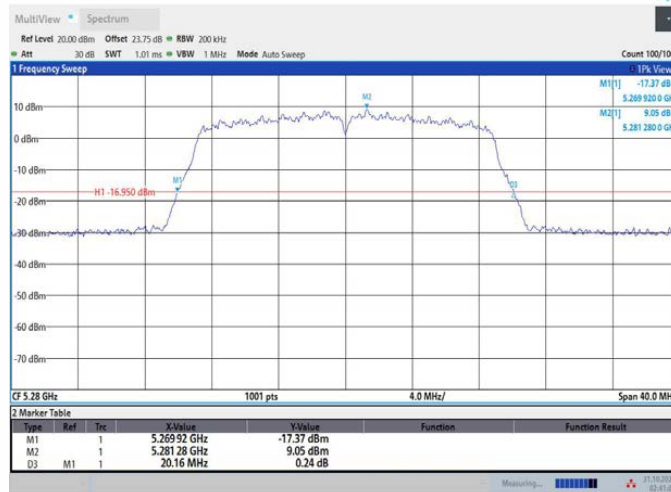

02:41:01 31.10.2023



### 11AC20MIMO\_Ant2\_5280

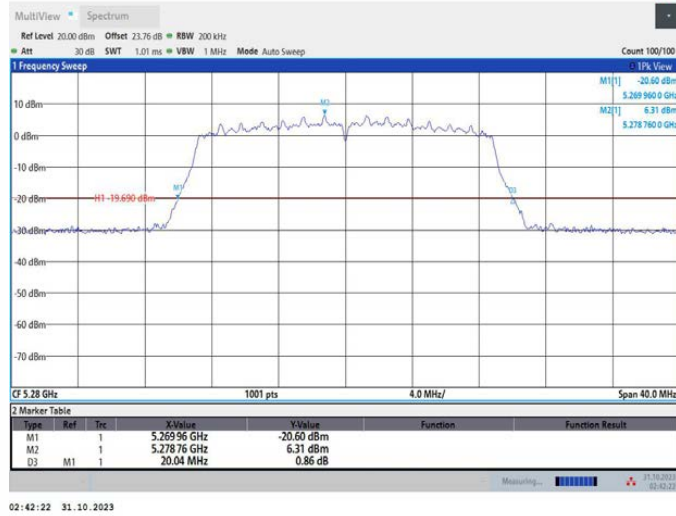

### 11AC20MIMO\_Ant1\_5320

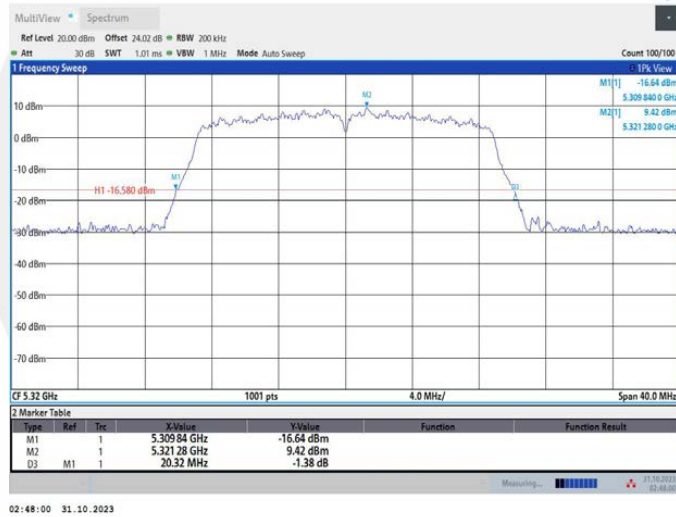

### 11AC20MIMO\_Ant2\_5320

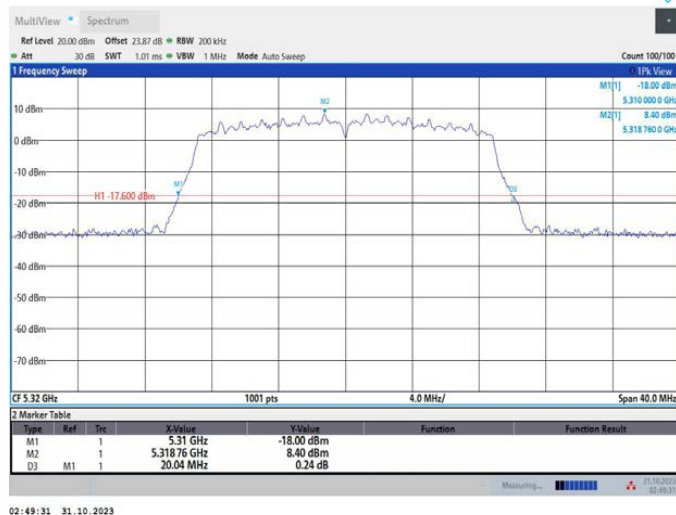

11AC20MIMO\_Ant1\_5500

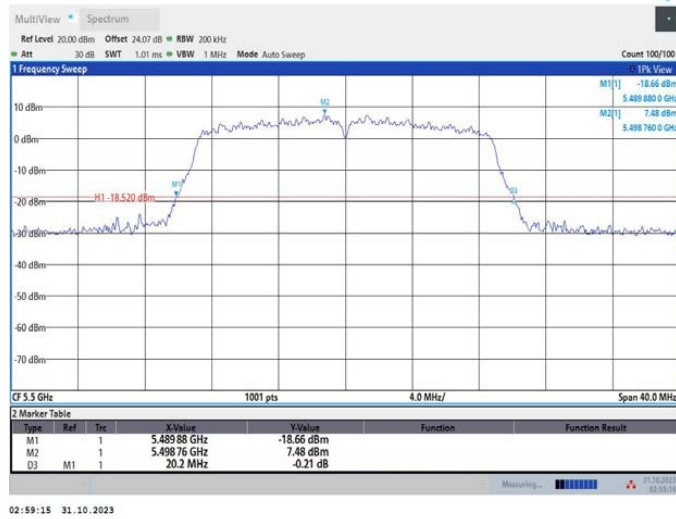

02:59:15 31.10.2023

11AC20MIMO\_Ant2\_5500

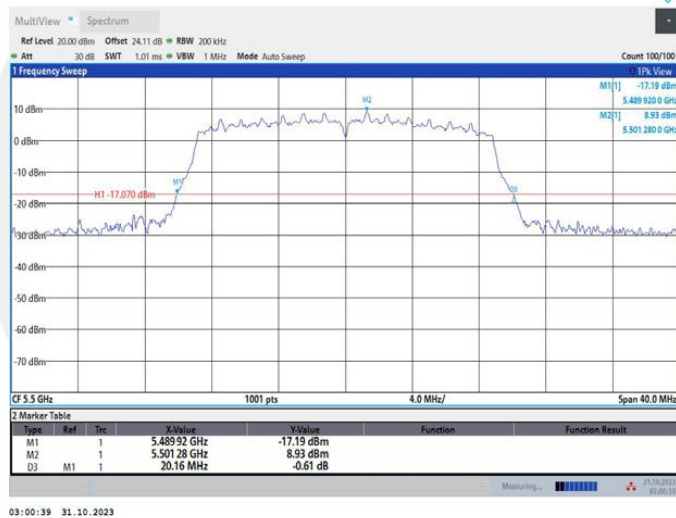

03:00:39 31.10.2023

11AC20MIMO\_Ant1\_5580

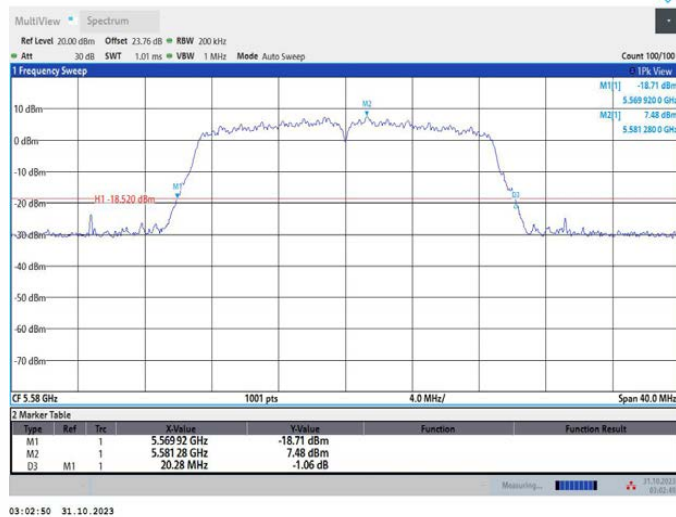

03:02:50 31.10.2023

11AC20MIMO\_Ant2\_5580

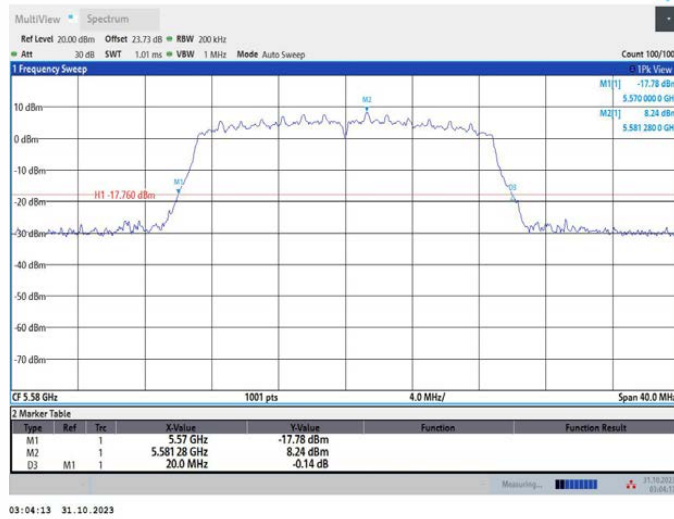

03:04:13 31.10.2023

11AC20MIMO\_Ant1\_5700

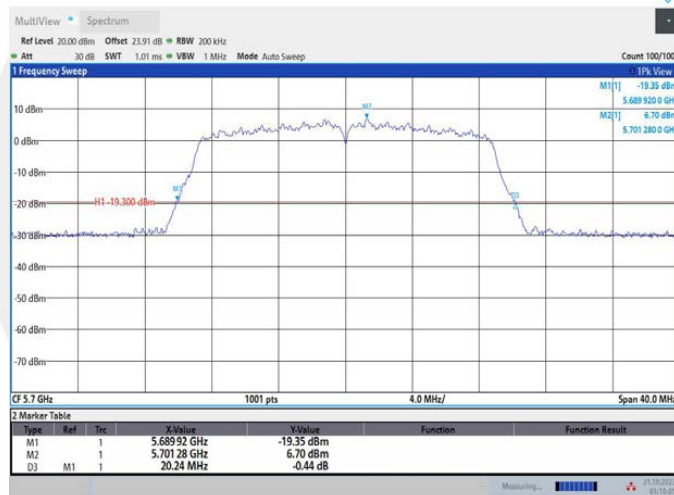

03:10:05 31.10.2023

11AC20MIMO\_Ant2\_5700



03:11:30 31.10.2023

11AC20MIMO\_Ant1\_5745

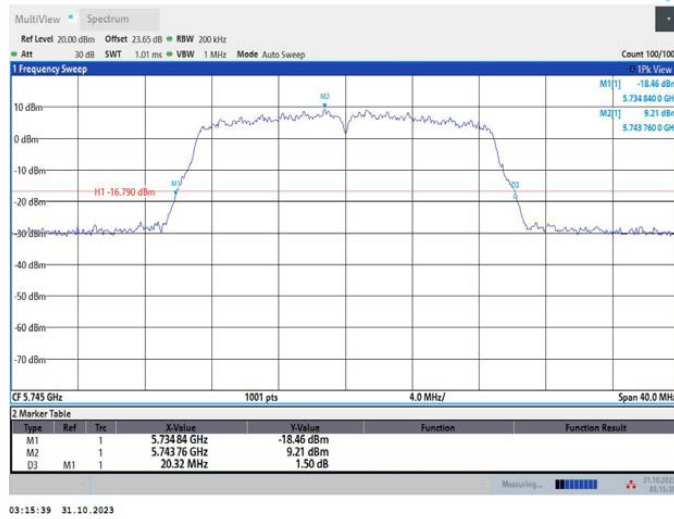

11AC20MIMO\_Ant2\_5745

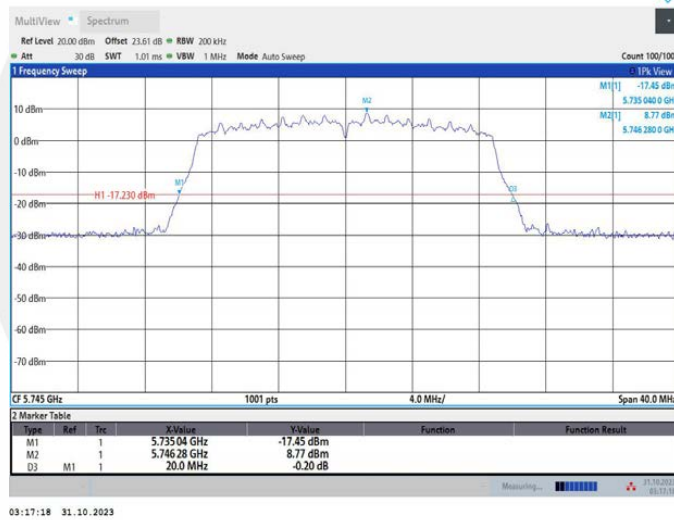

11AC20MIMO\_Ant1\_5785

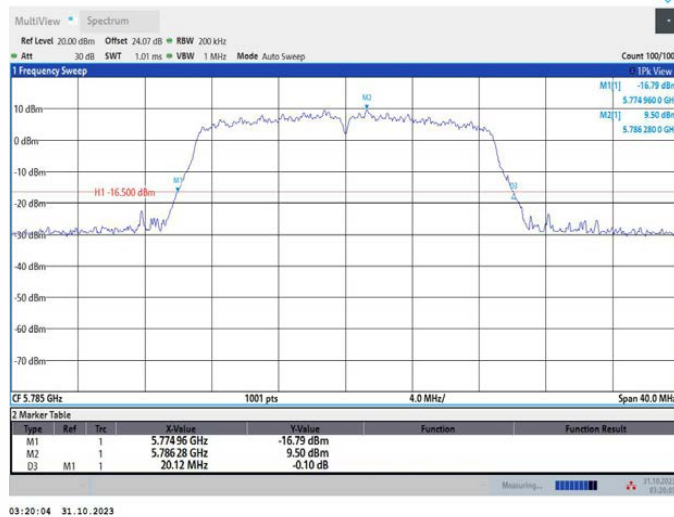

## 11AC20MIMO\_Ant2\_5785

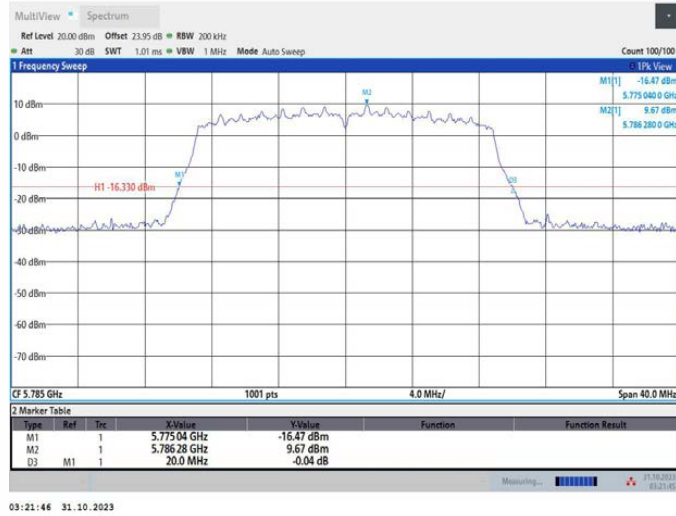

## 11AC20MIMO\_Ant1\_5825

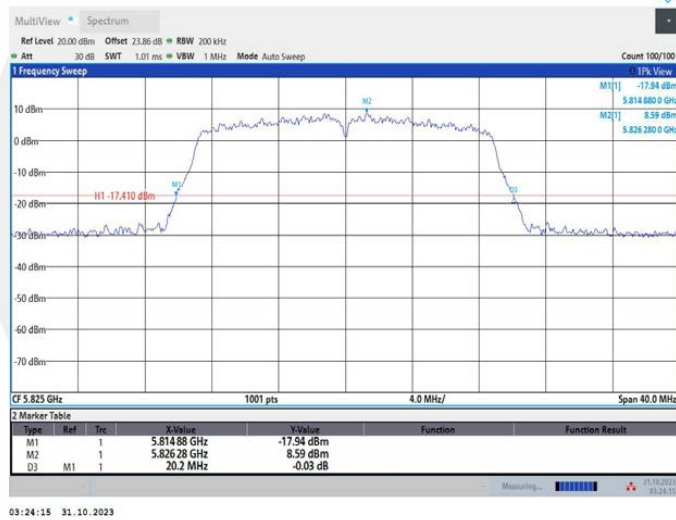

## 11AC20MIMO\_Ant2\_5825

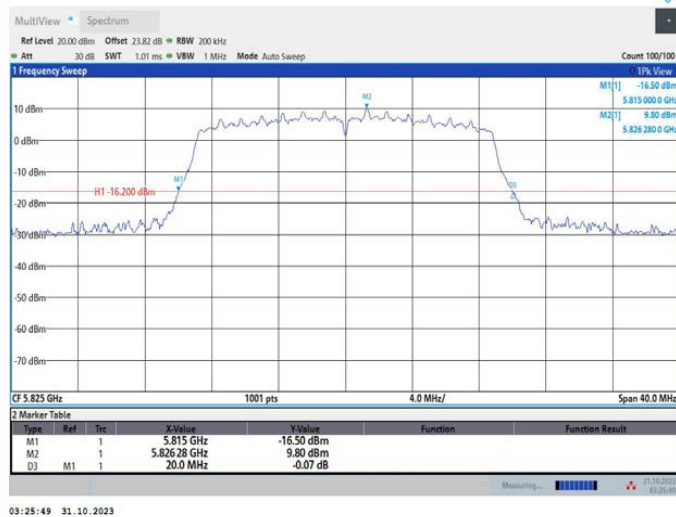

### 11AC40MIMO\_Ant1\_5190

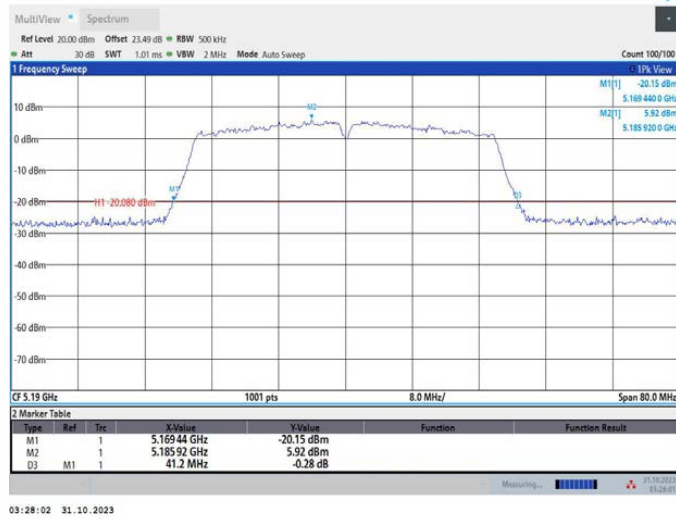

### 11AC40MIMO\_Ant2\_5190

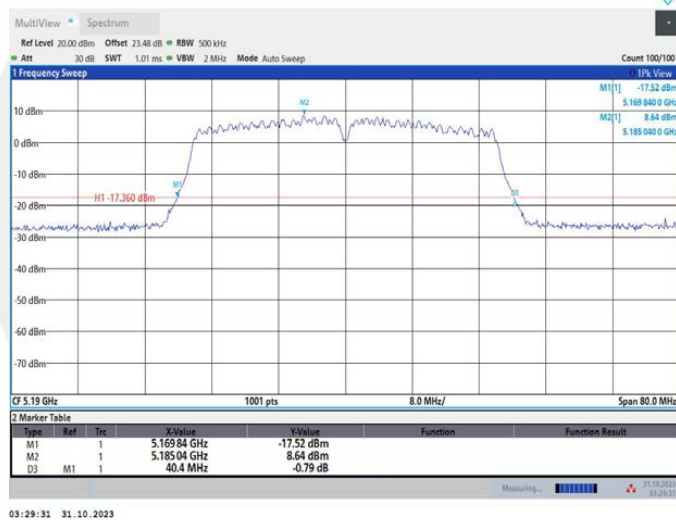

### 11AC40MIMO\_Ant1\_5230

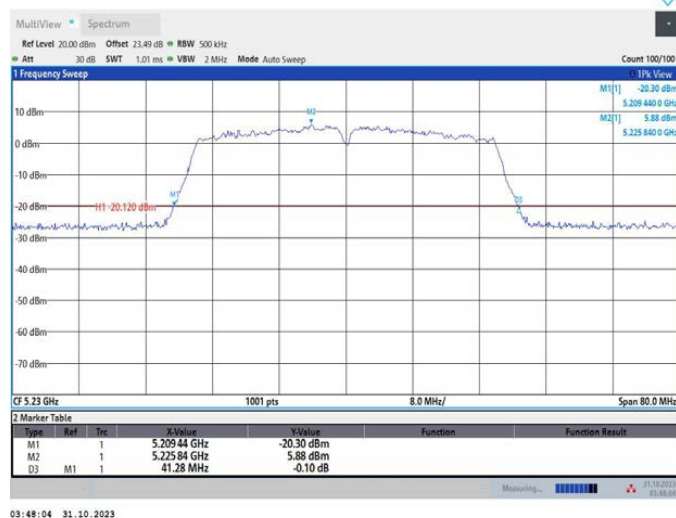

## 11AC40MIMO\_Ant2\_5230

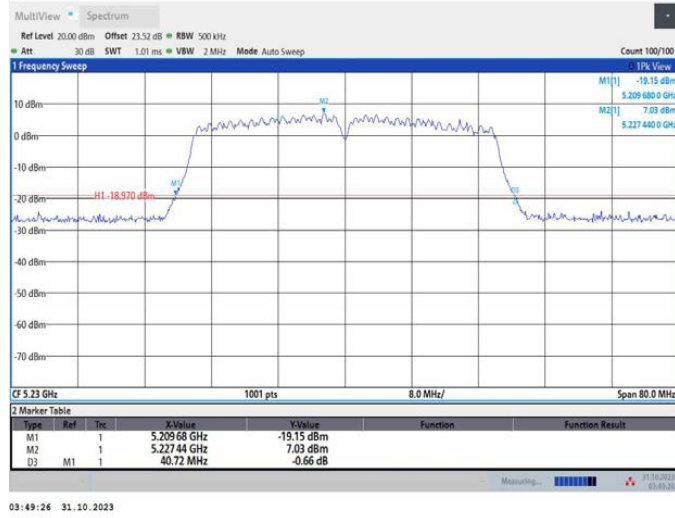

## 11AC40MIMO\_Ant1\_5270

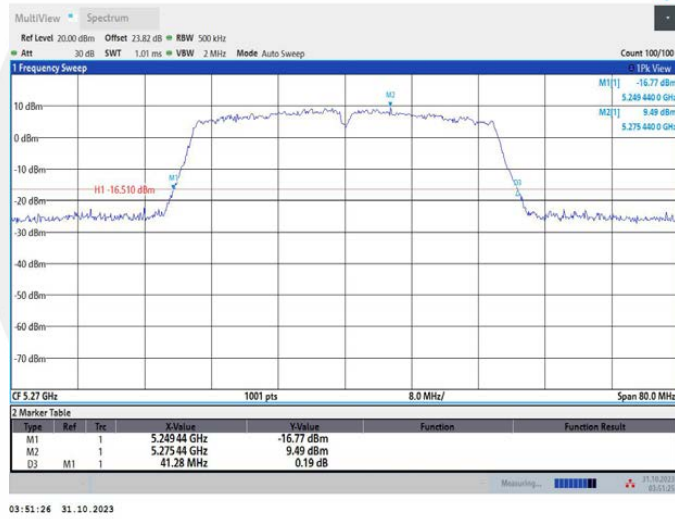

## 11AC40MIMO\_Ant2\_5270

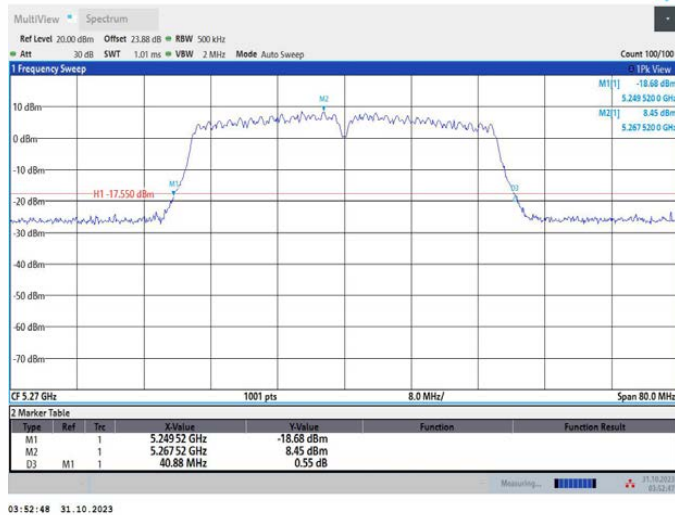

## 11AC40MIMO\_Ant1\_5310



## 11AC40MIMO\_Ant2\_5310

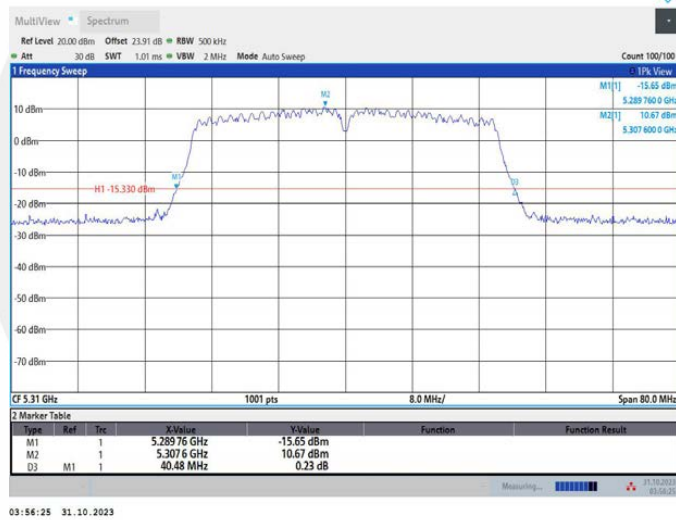

## 11AC40MIMO\_Ant1\_5510

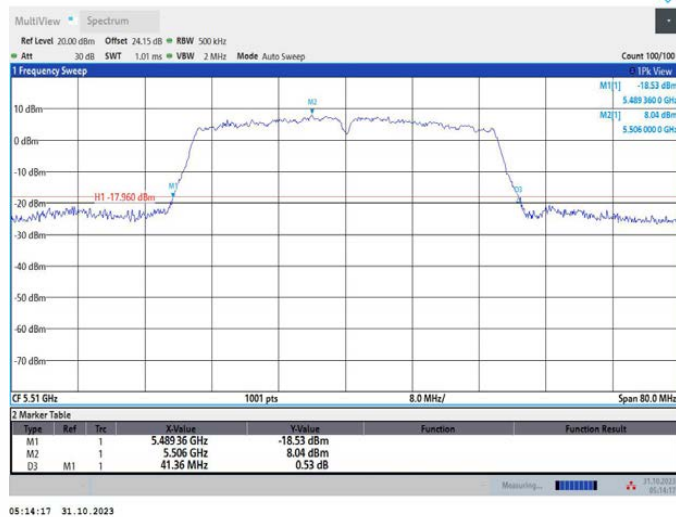



11AC40MIMO\_Ant2\_5510



11AC40MIMO\_Ant1\_5550

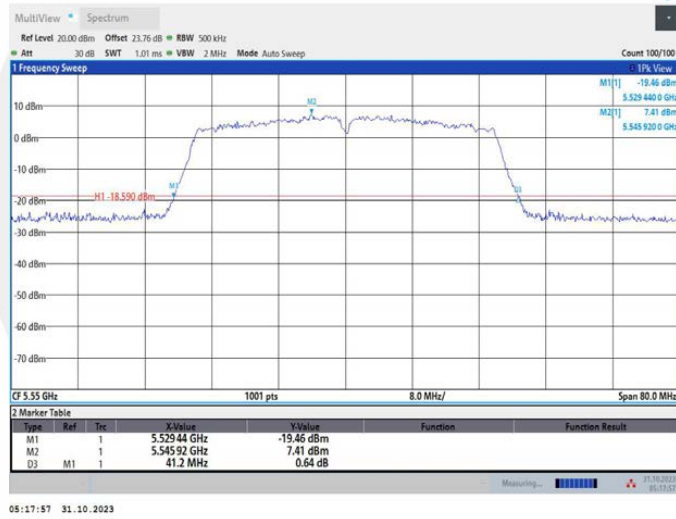

11AC40MIMO\_Ant2\_5550

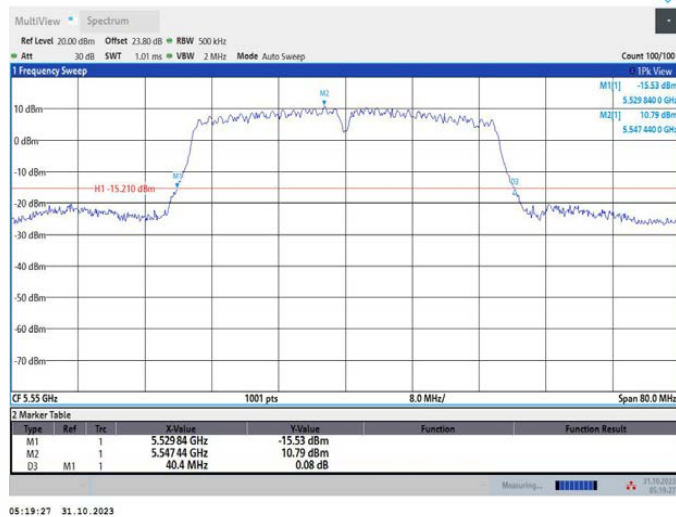

### 11AC40MIMO\_Ant1\_5670



### 11AC40MIMO\_Ant2\_5670

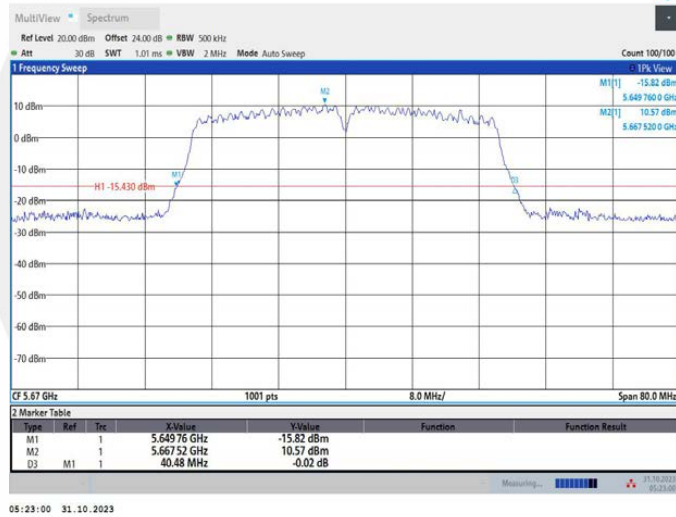

### 11AC40MIMO\_Ant1\_5755

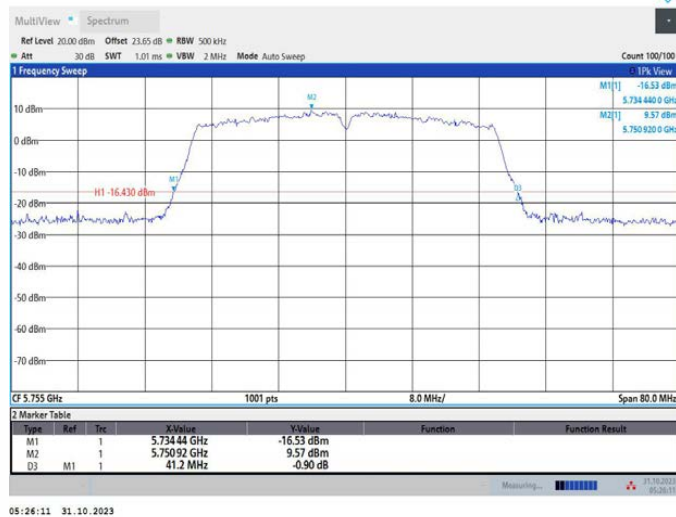

## 11AC40MIMO\_Ant2\_5755

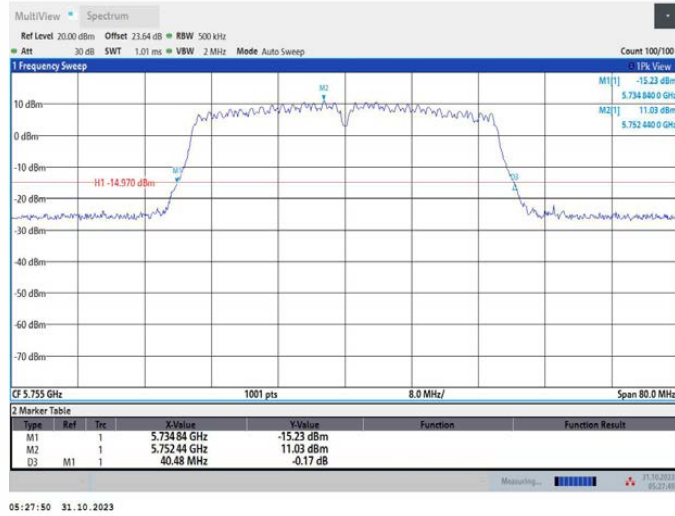

## 11AC40MIMO\_Ant1\_5795



## 11AC40MIMO\_Ant2\_5795

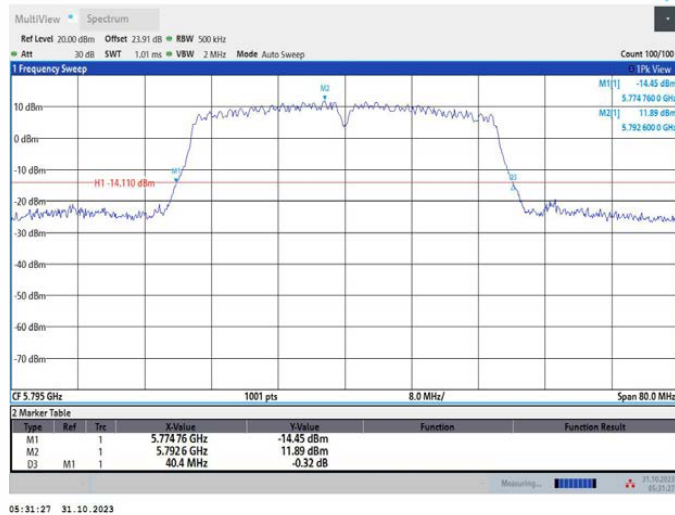

## 11AC80MIMO\_Ant1\_5210

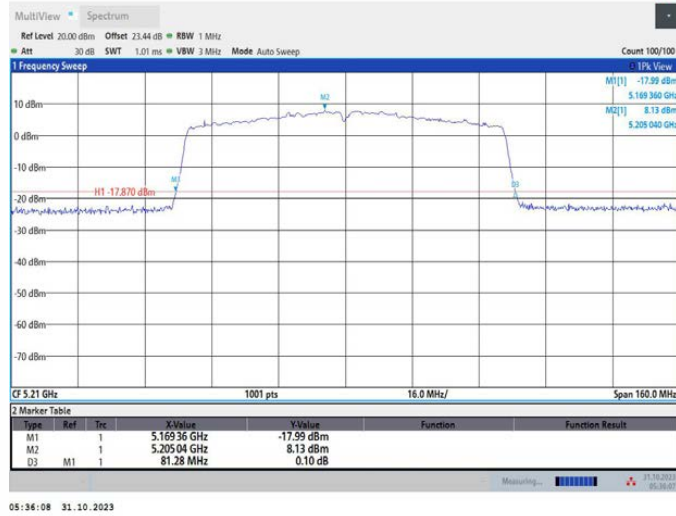

## 11AC80MIMO\_Ant2\_5210

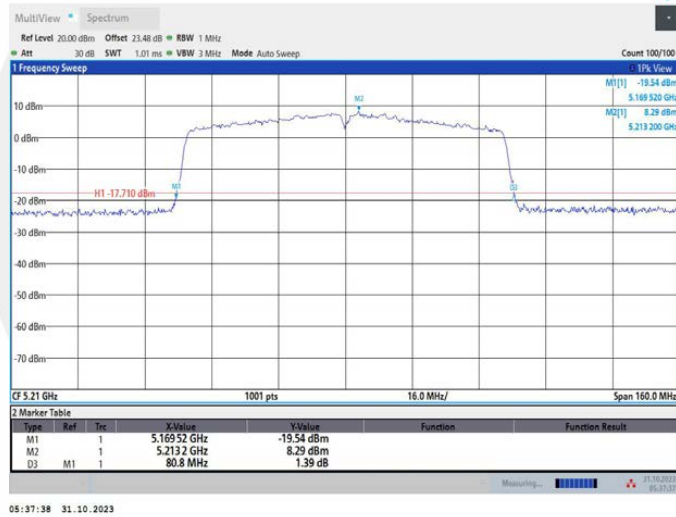

## 11AC80MIMO\_Ant1\_5290

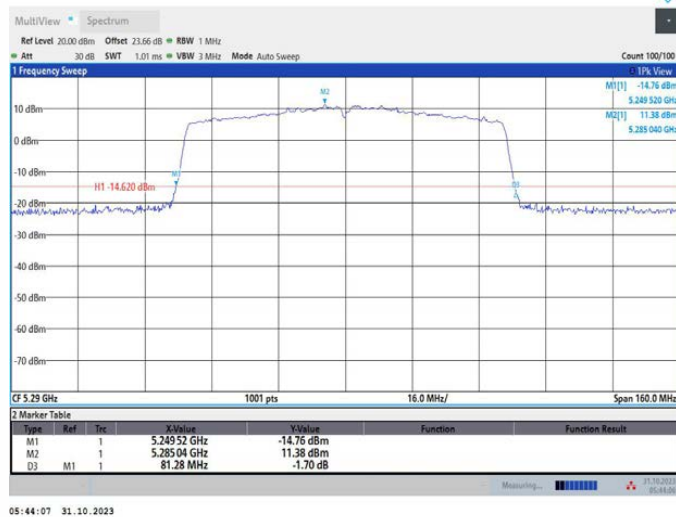

11AC80MIMO\_Ant2\_5290



11AC80MIMO\_Ant1\_5530

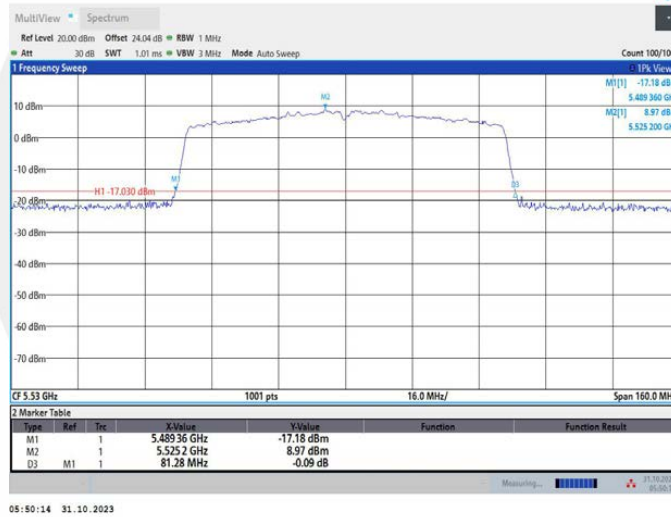

11AC80MIMO\_Ant2\_5530

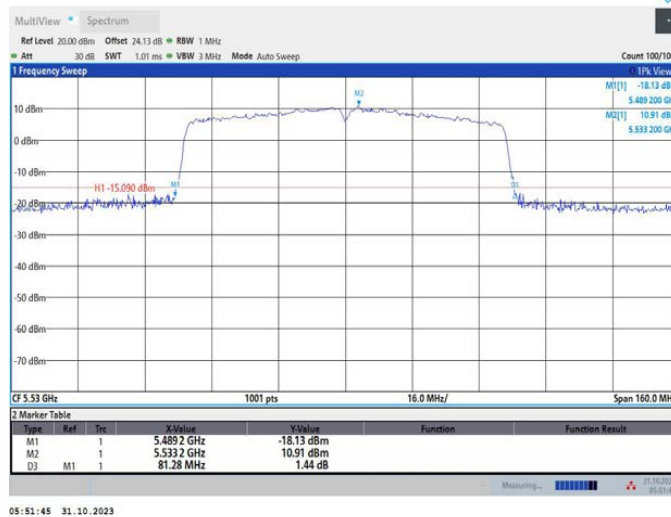

11AC80MIMO\_Ant1\_5610

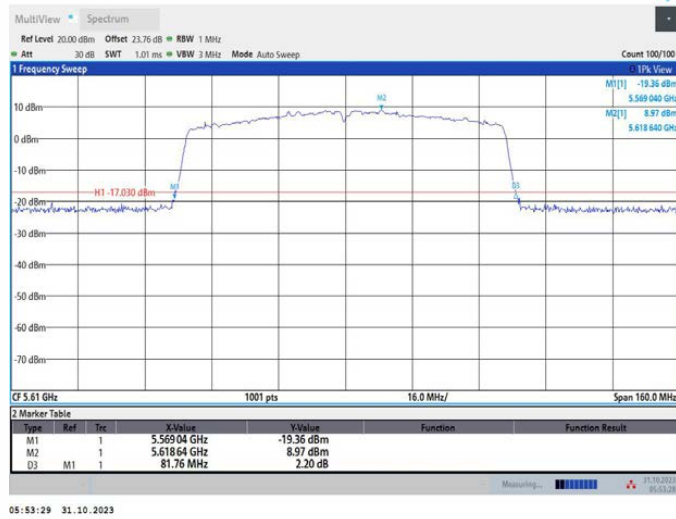

11AC80MIMO\_Ant2\_5610

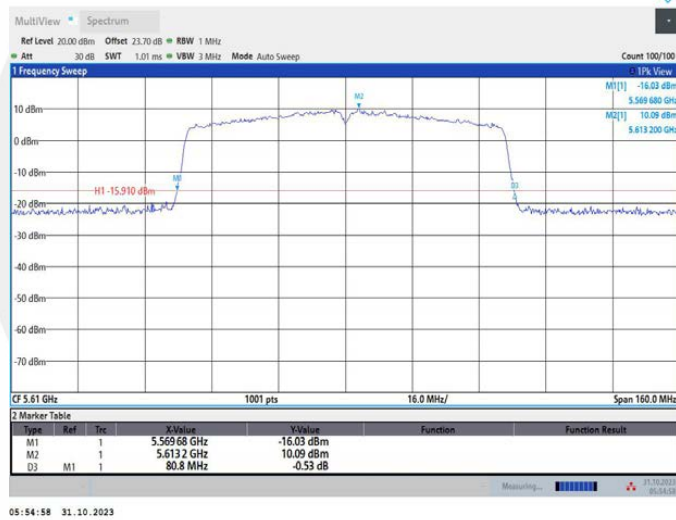

11AC80MIMO\_Ant1\_5775

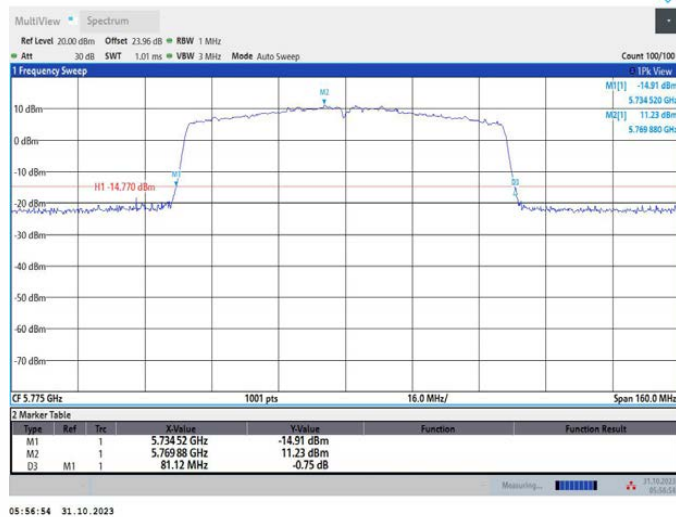

## 11AC80MIMO\_Ant2\_5775

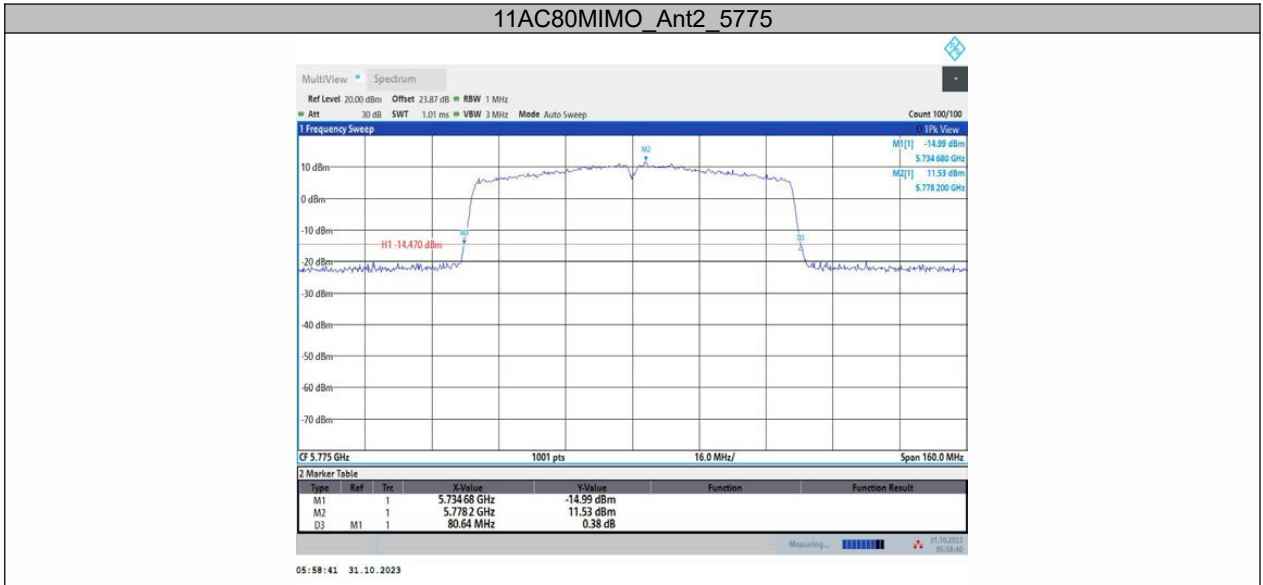

**Occupied channel bandwidth (99%)**

TestMode	Antenna	Frequency[MHz]	OCB [MHz]	FL[MHz]	FH[MHz]	Limit[MHz]	Verdict
11A	Ant1	5180	17.214	5171.3313	5188.5453	---	---
	Ant2	5180	16.764	5171.5881	5188.3516	---	---
	Ant1	5200	17.261	5191.2933	5208.5543	---	---
	Ant2	5200	16.767	5191.5879	5208.3553	---	---
	Ant1	5240	17.229	5231.3206	5248.5494	---	---
	Ant2	5240	16.768	5231.5745	5248.3423	---	---
	Ant1	5260	17.295	5251.2989	5268.5937	---	---
	Ant2	5260	16.749	5251.5695	5268.3185	---	---
	Ant1	5280	17.24	5271.3332	5288.5733	---	---
	Ant2	5280	16.763	5271.5988	5288.3615	---	---
	Ant1	5320	17.252	5311.3187	5328.5705	---	---
	Ant2	5320	16.735	5311.6208	5328.3562	---	---
	Ant1	5500	17.254	5491.2920	5508.5463	---	---
	Ant2	5500	16.761	5491.5679	5508.3287	---	---
	Ant1	5580	17.293	5571.3096	5588.6025	---	---
	Ant2	5580	16.758	5571.5986	5588.3564	---	---
	Ant1	5700	17.229	5691.3526	5708.5819	---	---
	Ant2	5700	16.714	5691.6354	5708.3490	---	---
	Ant1	5745	17.22	5736.3359	5753.5559	---	---
	Ant2	5745	16.742	5736.5939	5753.3356	---	---
	Ant1	5785	17.231	5776.3237	5793.5551	---	---
	Ant2	5785	16.722	5776.6344	5793.3564	---	---
	Ant1	5825	17.225	5816.3321	5833.5569	---	---
	Ant2	5825	16.707	5816.6331	5833.3402	---	---
11N20MIMO	Ant1	5180	18.018	5170.9747	5188.9924	---	---
	Ant2	5180	17.635	5171.1610	5188.7964	---	---
	Ant1	5200	18.101	5190.9347	5209.0358	---	---
	Ant2	5200	17.688	5191.1311	5208.8192	---	---
	Ant1	5240	18.047	5230.9668	5249.0137	---	---
	Ant2	5240	17.697	5231.1290	5248.8256	---	---
	Ant1	5260	17.953	5250.9851	5268.9380	---	---
	Ant2	5260	17.655	5251.1457	5268.8010	---	---
	Ant1	5280	17.984	5270.9951	5288.9790	---	---
	Ant2	5280	17.657	5271.1707	5288.8274	---	---
	Ant1	5320	17.98	5310.9860	5328.9663	---	---
	Ant2	5320	17.653	5311.1626	5328.8152	---	---
	Ant1	5500	17.99	5490.9509	5508.9413	---	---
	Ant2	5500	17.647	5491.1383	5508.7855	---	---
	Ant1	5580	18.026	5570.9693	5588.9951	---	---
	Ant2	5580	17.665	5571.1520	5588.8166	---	---
	Ant1	5700	18	5690.9888	5708.9888	---	---
	Ant2	5700	17.651	5691.1699	5708.8210	---	---
	Ant1	5745	17.991	5735.9786	5753.9699	---	---
	Ant2	5745	17.627	5736.1880	5753.8152	---	---
	Ant1	5785	17.956	5775.9740	5793.9301	---	---
	Ant2	5785	17.624	5776.1813	5793.8050	---	---
	Ant1	5825	17.967	5815.9901	5833.9572	---	---
	Ant2	5825	17.62	5816.1841	5833.8045	---	---
11N40MIMO	Ant1	5190	36.168	5171.8914	5208.0596	---	---
	Ant2	5190	36.363	5171.8026	5208.1653	---	---
	Ant1	5230	36.128	5211.9211	5248.0490	---	---



	Ant2	5230	36.366	5211.7997	5248.1653	---	---
	Ant1	5270	36.213	5251.8642	5288.0769	---	---
	Ant2	5270	36.424	5251.7731	5288.1972	---	---
	Ant1	5310	36.204	5291.8712	5328.0756	---	---
	Ant2	5310	36.441	5291.7915	5328.2325	---	---
	Ant1	5510	36.309	5491.7964	5528.1051	---	---
	Ant2	5510	36.416	5491.7237	5528.1394	---	---
	Ant1	5550	36.28	5531.8791	5568.1590	---	---
	Ant2	5550	36.422	5531.7927	5568.2151	---	---
	Ant1	5670	36.23	5651.9069	5688.1365	---	---
	Ant2	5670	36.46	5651.7984	5688.2588	---	---
	Ant1	5755	36.165	5736.8625	5773.0272	---	---
	Ant2	5755	36.411	5736.8185	5773.2295	---	---
	Ant1	5795	36.149	5776.8513	5813.0002	---	---
	Ant2	5795	36.431	5776.7971	5813.2282	---	---
11AC20MIMO	Ant1	5180	18.099	5170.9125	5189.0114	---	---
	Ant2	5180	17.812	5171.0616	5188.8733	---	---
	Ant1	5200	18.101	5190.9155	5209.0169	---	---
	Ant2	5200	17.8	5191.0691	5208.8691	---	---
	Ant1	5240	18.077	5230.9289	5249.0064	---	---
	Ant2	5240	17.797	5231.0606	5248.8579	---	---
	Ant1	5260	17.994	5250.9486	5268.9431	---	---
	Ant2	5260	17.751	5251.0835	5268.8347	---	---
	Ant1	5280	18.016	5270.9702	5288.9863	---	---
	Ant2	5280	17.749	5271.1028	5288.8519	---	---
	Ant1	5320	18.005	5310.9577	5328.9622	---	---
	Ant2	5320	17.733	5311.1095	5328.8422	---	---
	Ant1	5500	18.031	5490.9195	5508.9502	---	---
	Ant2	5500	17.769	5491.0690	5508.8381	---	---
	Ant1	5580	18.015	5570.9652	5588.9798	---	---
	Ant2	5580	17.757	5571.0837	5588.8406	---	---
	Ant1	5700	17.998	5690.9907	5708.9884	---	---
	Ant2	5700	17.759	5691.0941	5708.8531	---	---
	Ant1	5745	17.988	5735.9700	5753.9582	---	---
	Ant2	5745	17.746	5736.1003	5753.8463	---	---
	Ant1	5785	17.992	5775.9734	5793.9655	---	---
	Ant2	5785	17.74	5776.1011	5793.8410	---	---
	Ant1	5825	17.981	5815.9683	5833.9494	---	---
	Ant2	5825	17.748	5816.0920	5833.8403	---	---
11AC40MIMO	Ant1	5190	36.417	5171.7837	5208.2003	---	---
	Ant2	5190	36.3	5171.7909	5208.0912	---	---
	Ant1	5230	36.42	5211.7832	5248.2032	---	---
	Ant2	5230	36.409	5211.7229	5248.1315	---	---
	Ant1	5270	36.385	5251.8227	5288.2072	---	---
	Ant2	5270	36.405	5251.7634	5288.1683	---	---
	Ant1	5310	36.349	5291.8045	5328.1531	---	---
	Ant2	5310	36.339	5291.8224	5328.1611	---	---
	Ant1	5510	36.47	5491.7445	5528.2150	---	---
	Ant2	5510	36.458	5491.6729	5528.1313	---	---
	Ant1	5550	36.378	5531.8572	5568.2352	---	---
	Ant2	5550	36.365	5531.7640	5568.1294	---	---
	Ant1	5670	36.38	5651.8547	5688.2348	---	---
	Ant2	5670	36.351	5651.8170	5688.1678	---	---
	Ant1	5755	36.284	5736.8502	5773.1343	---	---
Ant2	5755	36.299	5736.8299	5773.1286	---	---	

	Ant1	5795	36.353	5776.7508	5813.1040	---	---
	Ant2	5795	36.302	5776.7817	5813.0837	---	---
11AC80MIMO	Ant1	5210	75.501	5172.3210	5247.8223	---	---
	Ant2	5210	75.443	5172.2819	5247.7250	---	---
	Ant1	5290	75.261	5252.4125	5327.6736	---	---
	Ant2	5290	75.395	5252.3824	5327.7769	---	---
	Ant1	5530	75.558	5492.2894	5567.8471	---	---
	Ant2	5530	75.484	5492.1521	5567.6358	---	---
	Ant1	5610	75.302	5572.5010	5647.8030	---	---
	Ant2	5610	75.427	5572.3112	5647.7383	---	---
	Ant1	5775	75.201	5737.3989	5812.6001	---	---
	Ant2	5775	75.292	5737.4108	5812.7024	---	---



## 11A\_Ant1\_5180

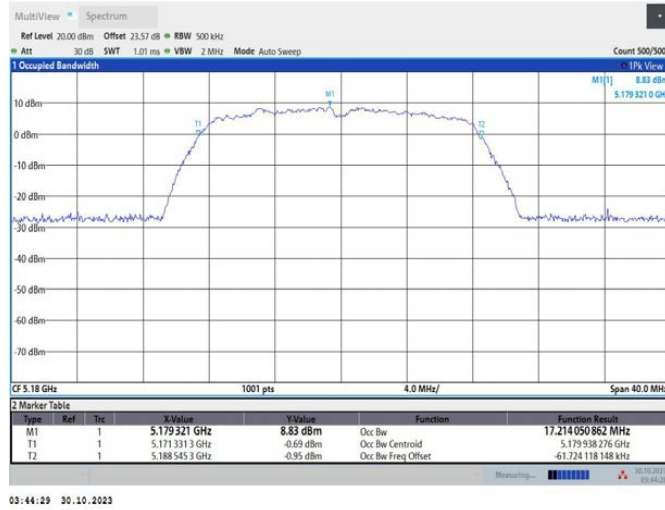

## 11A\_Ant2\_5180



## 11A\_Ant1\_5200

