

TEST REPORT

Product Name : AX3200 Wi-Fi 6 Dual-band Mesh Router

Model Number : RG-E5

FCC ID : 2AX5J-E5V2

Prepared for : Ruijie Networks Co., Ltd.
Address : Building 19, Juyuanzhou Industrial Park, No.618 Jinshan Road, Cangshan District, Fuzhou, Fujian, China

Prepared by : EMTEK (SHENZHEN) CO., LTD.
Address : Bldg 69, Majialong Industry Zone, Nanshan District, Shenzhen, Guangdong, China

Tel: (0755) 26954280
Fax: (0755) 26954282

Report Number : ENS2310300205W00202R
Date(s) of Tests : December 11, 2023 to January 9, 2024
Date of issue : January 12, 2024

TABLE OF CONTENTS

1 TEST RESULT CERTIFICATION.....	4
2 EUT TECHNICAL DESCRIPTION.....	5
3 SUMMARY OF TEST RESULT.....	7
4 TEST METHODOLOGY.....	8
4.1 GENERAL DESCRIPTION OF APPLIED STANDARDS.....	8
4.2 MEASUREMENT EQUIPMENT USED.....	8
4.3 DESCRIPTION OF TEST MODES.....	9
5 FACILITIES AND ACCREDITATIONS.....	13
5.1 FACILITIES.....	13
5.2 LABORATORY ACCREDITATIONS AND LISTINGS.....	13
6 TEST SYSTEM UNCERTAINTY.....	14
7 SETUP OF EQUIPMENT UNDER TEST.....	15
7.1 RADIO FREQUENCY TEST SETUP.....	15
7.2 RADIO FREQUENCY TEST SETUP.....	15
7.3 CONDUCTED EMISSION TEST SETUP.....	17
7.4 BLOCK DIAGRAM CONFIGURATION OF TEST SYSTEM.....	18
7.5 SUPPORT EQUIPMENT.....	18
8 TEST REQUIREMENTS.....	19
8.1 BANDWIDTH MEASUREMENT.....	19
8.2 MAXIMUM CONDUCTED OUTPUT POWER.....	292
8.3 MAXIMUM PEAK POWER DENSITY.....	478
8.4 UNDESIRABLE RADIATED SPURIOUS EMISSION.....	601
8.5 POWER LINE CONDUCTED EMISSIONS.....	638
8.6 ANTENNA APPLICATION.....	641

1 TEST RESULT CERTIFICATION

Applicant : Ruijie Networks Co., Ltd.
 Address : Building 19,Juyuanzhou Industrial Park, No.618 Jinshan Road, CangshanDistrict,Fuzhou,Fujian, China
 Manufacturer : Ruijie Networks Co., Ltd.
 Address : Building 19,Juyuanzhou Industrial Park, No.618 Jinshan Road, CangshanDistrict,Fuzhou,Fujian, China
 EUT : AX3200 Wi-Fi 6 Dual-band Mesh Router
 Model Name : RG-E5
 Trademark : REYEE

Measurement Procedure Used:

APPLICABLE STANDARDS	
STANDARD	TEST RESULT
FCC 47 CFR Part 2, Subpart J FCC 47 CFR Part 15, Subpart E	PASS

The above equipment was tested by EMTEK (SHENZHEN) CO., LTD. The test data, data evaluation, test procedures, and equipment configurations shown in this report were made in accordance with the procedures given in ANSI C63.10 (2013) and the energy emitted by the sample EUT tested as described in this report is in compliance with the above table standards requirement.
 The test results of this report relate only to the tested sample identified in this report.

Date of Test : December 11, 2023 to January 9, 2024

Prepared by : 
 Una Yu/Editor

Reviewer : 
 Joe Xia/Supervisor

Approved & Authorized Signer : 
 Lisa Wang/Manager



2 EUT TECHNICAL DESCRIPTION

Characteristics	Description
Product	AX3200 Wi-Fi 6 Dual-band Mesh Router
Model Number	RG-E5
Wifi Type	UNII-1: 5150MHz-5250MHz Band UNII-2A: with 5250MHz-5350MHz Band UNII-2C: with 5470MHz-5725MHz Band UNII-3: with 5725MHz-5850MHz Band
WLAN Supported	802.11a 802.11n(20MHz channel bandwidth) 802.11n(40MHz channel bandwidth) 802.11ac(20MHz channel bandwidth) 802.11ac(40MHz channel bandwidth) 802.11ac(80MHz channel bandwidth) 802.11ax(20MHz channel bandwidth) 802.11ax(40MHz channel bandwidth) 802.11ax(80MHz channel bandwidth)
Data Rate	802.11a:54/48/36/24/18/12/9/6Mbps 802.11n:up to 600 Mbps 802.11ac/ax:up to 1.733Gbps
Modulation	OFDM with BPSK/QPSK/16QAM/64QAM for 802.11a/n OFDM/OFDMA with BPSK/QPSK/16QAM/64QAM/256QAM/1024QAM for 802.11ac/ax
Frequency Range	5150MHz-5250MHz Band
	5180-5240MHz for 802.11a 5180-5240MHz for 802.11n(HT20) 5190-5230MHz for 802.11n(HT40) 5180-5240MHz for 802.11ac(HT20) 5190-5230MHz for 802.11ac(HT40) 5210MHz for 802.11ac(HT80) 5180-5240MHz for 802.11ax(HT20) 5190-5230MHz for 802.11ax(HT40) 5210MHz for 802.11ax(HT80)
	5250MHz-5350MHz Band
	5260-5320MHz for 802.11a 5260-5320MHz for 802.11n(HT20) 5270-5310MHz for 802.11n(HT40) 5260-5320MHz for 802.11ac(HT20) 5270-5310MHz for 802.11ac(HT40) 5290MHz for 802.11ac(HT80) 5260-5320MHz for 802.11ax(HT20) 5270-5310MHz for 802.11ax(HT40) 5290MHz for 802.11ax(HT80)
	5470MHz-5725MHz Band

	<p>5500-5700MHz for 802.11a 5500-5700MHz for 802.11n(HT20) 5510-5670MHz for 802.11n(HT40) 5500-5700MHz for 802.11ac(HT20) 5510-5670MHz for 802.11ac(HT40) 5530-5610MHz for 802.11ac(HT80) 5500-5700MHz for 802.11ax(HT20) 5510-5670MHz for 802.11ax(HT40) 5530-5610MHz for 802.11ax(HT80)</p>
	<p>5725MHz-5850MHz Band</p>
	<p>5745-5825MHz for 802.11a 5745-5825MHz for 802.11n(HT20) 5755-5795MHz for 802.11n(HT40) 5745-5825MHz for 802.11ac(HT20) 5755-5795MHz for 802.11ac(HT40) 5775MHz for 802.11ac(HT80) 5745-5825MHz for 802.11ax(HT20) 5755-5795MHz for 802.11ax(HT40) 5775MHz for 802.11ax(HT80)</p>
TPC Function	Applicable
Smart system	MIMO
Antenna Type	Integrated Antenna
Antenna Gain	Ant1: 5.13dBi, Ant2: 5.19dBi, Ant3:5.37dBi , Ant4: 5.35dBi (Note: The antenna information is provided by the customers, which will have a certain impact on the test results.)
Power Supply	AC 100-240V, 50/60Hz by Adapter Adapter : Model: F3017-120250SPACP Input: 100-240V~50/60Hz, 0.8A Output: 12V, 2.5A, 30W
Temperature Range	-10 °C ~ 45°C

Note: for more details, please refer to the user's manual of the EUT.

3 SUMMARY OF TEST RESULT

FCC Part Clause	Test Parameter	Verdict	Remark
15.407 (a) 15.407 (e)	99% , 6dB and 26dB Bandwidth	PASS	
15.407 (a)	Maximum Conducted Output Power	PASS	
15.407 (a)	Peak Power Spectral Density	PASS	
15.407 (b)	Radiated Spurious Emission	PASS	
15.407 (b)(6) 15.207	Power Line Conducted Emission	PASS	
15.407(a) 15.203	Antenna Application	PASS	

NOTE1: The results of this report do not take into account the uncertainty.

NOTE2: According to FCC OET KDB 789033 D2 General UNII Test Procedures New Rules v02r01, In addition, the radiated test is also performed to ensure the emissions emanating from the device cabinet also comply with the applicable limits.

RELATED SUBMITTAL(S) / GRANT(S):

This submittal(s) (test report) is intended for **FCC ID: 2AX5J-E5V2** filing to comply with the above table standards requirement.

4 TEST METHODOLOGY

4.1 GENERAL DESCRIPTION OF APPLIED STANDARDS

According to its specifications, the EUT must comply with the requirements of the following standards:

FCC 47 CFR Part 2, Subpart J

FCC 47 CFR Part 15, Subpart E

FCC KDB 789033 D2 General UNII Test Procedures New Rules v02r01

4.2 MEASUREMENT EQUIPMENT USED

For Conducted Emission Test

Equipment	Manufacturer	Model No.	Serial No.	Last Cal.	Cal. Interval
EMI Test Receiver	Rohde & Schwarz	ESCI	101384	2023/5/13	1Year
AMN	Rohde & Schwarz	ENV216	101161	2023/5/13	1Year

For Spurious Emissions Test

Equipment	Manufacturer	Model No.	Serial No.	Last Cal.	Cal. Interval
Pre-Amplifier	Bonn	BLMA 011001N	2213967A	2023/10/23	1Year
EMI Test Receiver	Rohde & Schwarz	ESR7	102551	2023/10/23	1Year
Bilog Antenna	Schwarzbeck	VULB9163	9163142	2022/7/24	2Year
Horn antenna	Schwarzbeck	BBHA9120D	9120D-1198	2023/6/2	2Year
Pre-Amplifier	Bonn	BLMA 0118-5G	2213967B-01	2023/10/23	1Year
Spectrum Analyzer	Rohde & Schwarz	FSV3044	101290	2023/10/23	1Year
Horn antenna	Schwarzbeck	BBHA9170	9170-399	2023/5/12	2Year
Pre-Amplifier	Lunar EM	LNA18G26-40	J1012131010 001	2023/5/10	1Year
Pre-Amplifier	Lunar EM	LNA26G40-40	J1013131028 001	2023/5/10	1Year
Loop Antenna	Schwarzbeck	FMZB1519	1519-012	2023/5/12	2Year
Thermometer	Hegao	HTC-1	\	2023/5/16	1Year

For Other Test

Equipment	Manufacturer	Model No.	Serial No.	Last Cal.	Cal. Interval
Wideband Radio Communication Tester	R&S	CMW500	171168	2023/9/14	1Year
Frequency Extender	R&S	CMW-Z800A	100430	2023/11/1	1Year
Spectrum Analyzer	R&S	FSV3044	101289	2023/9/14	1Year
Analog Signal Generator	R&S	SMB100A	183237	2023/9/16	1Year
Vector Signal Generator	R&S	SMM100A	101808	2023/9/16	1Year
RF Control Unit(Power Meter)	Tonscend	JS0806-2	22C8060567	2023/9/14	1Year
Temperature&Hum idity Chamber	ESPEC	EL-02KA	12107166	2023/5/10	1 Year

4.3 DESCRIPTION OF TEST MODES

The EUT has been tested under its typical operating condition.

The EUT configuration for testing is installed on RF field strength measurement to meet the Commissions requirement and operating in a manner which intends to maximize its emission characteristics in a continuous normal application.

The Transmitter was operated in the normal operating mode. The TX frequency was fixed which was for the purpose of the measurements.

Test of channel included the lowest and middle and highest frequency to perform the test, then record on this report.

Pre-defined engineering program for regulatory testing used to control the EUT for staying in continuous transmitting and receiving mode is programmed.

Wifi 5G with 5150-5250MHz

Frequency and Channels list for 802.11a/n(20)/802.11ac(20)/802.11ax(20):

Channel	Frequency (MHz)	Channel	Frequency (MHz)	Channel	Frequency (MHz)
36	5180	44	5220		
40	5200	48	5240		

Frequency and Channels list for 802.11n (40)/802.11ac(40)/802.11ax(40):

Channel	Frequency (MHz)	Channel	Frequency (MHz)	Channel	Frequency (MHz)
38	5190				
46	5230				

Frequency and Channel list for 802.11ac(80)/802.11ax(80):

Channel	Frequency (MHz)	Channel	Frequency (MHz)	Channel	Frequency (MHz)
42	5210				

Test Frequency and Channels for 802.11a/n(20)/802.11ac(20)/802.11ax(20):

Lowest Frequency		Middle Frequency		Highest Frequency	
Channel	Frequency (MHz)	Channel	Frequency (MHz)	Channel	Frequency (MHz)
36	5180	40	5200	48	5240

Test Frequency and channels for 802.11n (40)/802.11ac(40)/802.11ax(40):

Lowest Frequency		Middle Frequency		Highest Frequency	
Channel	Frequency (MHz)	Channel	Frequency (MHz)	Channel	Frequency (MHz)
38	5190	N/A	N/A	46	5230

Test Frequency and channels for 802.11ac(80)/802.11ax(80):

Lowest Frequency		Middle Frequency		Highest Frequency	
Channel	Frequency (MHz)	Channel	Frequency (MHz)	Channel	Frequency (MHz)
42	5210	N/A	N/A	N/A	N/A

Wifi 5G with 5250-5350MHz

Frequency and Channels list for 802.11a/n(20)/802.11ac(20)/802.11ax(20):

Channel	Frequency (MHz)	Channel	Frequency (MHz)	Channel	Frequency (MHz)
52	5260	60	5300		
56	5280	64	5320		

Frequency and Channels list for 802.11n (40)/802.11ac(40)/802.11ax(40):

Channel	Frequency (MHz)	Channel	Frequency (MHz)	Channel	Frequency (MHz)
54	5270				
62	5310				

Frequency and Channels list for 802.11ac(80)/802.11ax(80):

Channel	Frequency (MHz)	Channel	Frequency (MHz)	Channel	Frequency (MHz)
58	5290				

Test Frequency and Channels for 802.11a/n(20)/802.11ac(20)/802.11ax(20):

Lowest Frequency		Middle Frequency		Highest Frequency	
Channel	Frequency (MHz)	Channel	Frequency (MHz)	Channel	Frequency (MHz)
52	5260	56	5280	64	5320

Test Frequency and channels for 802.11n (40)/802.11ac(40)/802.11ax(40):

Lowest Frequency		Middle Frequency		Highest Frequency	
Channel	Frequency (MHz)	Channel	Frequency (MHz)	Channel	Frequency (MHz)
54	5270	N/A	N/A	62	5310

Test Frequency and channels for 802.11ac(80)/802.11ax(80):

Lowest Frequency		Middle Frequency		Highest Frequency	
Channel	Frequency (MHz)	Channel	Frequency (MHz)	Channel	Frequency (MHz)
58	5290				

Wifi 5G with 5470-5725MHz

Frequency and Channels list for 802.11a/n(20)/802.11ac(20)/802.11ax(20):

Channel	Frequency (MHz)	Channel	Frequency (MHz)	Channel	Frequency (MHz)
100	5500	116	5580	132	5660
104	5520	120	5600	136	5680
108	5540	124	5620	140	5700
112	5560	128	5640		

Frequency and Channels list for 802.11n (40)/802.11ac(40)/802.11ax(40):

Channel	Frequency (MHz)	Channel	Frequency (MHz)	Channel	Frequency (MHz)
102	5510	118	5590	134	5670
110	5550	126	5630		

Frequency and Channels list for 802.11ac(80)/802.11ax(80):

Channel	Frequency (MHz)	Channel	Frequency (MHz)	Channel	Frequency (MHz)
106	5530	122	5610		

Test Frequency and Channels for 802.11a/n(20)/802.11ac(20)/802.11ax(20):

Lowest Frequency		Middle Frequency		Highest Frequency	
Channel	Frequency (MHz)	Channel	Frequency (MHz)	Channel	Frequency (MHz)
100	5500	116	5580	140	5700

Test Frequency and channels for 802.11n (40)/802.11ac(40)/802.11ax(40):

Lowest Frequency		Middle Frequency		Highest Frequency	
Channel	Frequency (MHz)	Channel	Frequency (MHz)	Channel	Frequency (MHz)
102	5510			134	5670

Test Frequency and channels for 802.11ac(80)/802.11ax(80):

Lowest Frequency		Middle Frequency		Highest Frequency	
Channel	Frequency (MHz)	Channel	Frequency (MHz)	Channel	Frequency (MHz)
106	5530	122	5610		

Wifi 5G with 5725MHz-5850MHz

Frequency and Channels list for 802.11a/n(20)/802.11ac(20)/802.11ax(20):

Channel	Frequency (MHz)	Channel	Frequency (MHz)	Channel	Frequency (MHz)
149	5745	157	5785	165	5825
153	5765	161	5805		

Frequency and Channels list for 802.11n (40)/802.11ac(40)/802.11ax(40):

Channel	Frequency (MHz)	Channel	Frequency (MHz)	Channel	Frequency (MHz)
151	5755				
159	5795				

Frequency and Channels list for 802.11ac(80)/802.11ax(80):

Channel	Frequency (MHz)	Channel	Frequency (MHz)	Channel	Frequency (MHz)
155	5775				

Test Frequency and Channels for 802.11a/n(20)/802.11ac(20)/802.11ax(20):

Lowest Frequency		Middle Frequency		Highest Frequency	
Channel	Frequency (MHz)	Channel	Frequency (MHz)	Channel	Frequency (MHz)
149	5745	157	5785	165	5825

Test Frequency and channels for 802.11n (40)/802.11ac(40)/802.11ax(40):

Lowest Frequency		Middle Frequency		Highest Frequency	
Channel	Frequency (MHz)	Channel	Frequency (MHz)	Channel	Frequency (MHz)
151	5755			159	5795

Test Frequency and channels for 802.11ac(80)/802.11ax(80):

Lowest Frequency		Middle Frequency		Highest Frequency	
Channel	Frequency (MHz)	Channel	Frequency (MHz)	Channel	Frequency (MHz)
155	5775				

Multi-antenna correlation:

<input checked="" type="checkbox"/>	Transmit Signals are Correlated
	Directional gain = $10 \log[(10^{G1/20} + 10^{G2/20} + \dots + 10^{GN/20})^2 / N_{ANT}]$ dBi
<input type="checkbox"/>	All Transmit Signals are Completely Uncorrelated
	Directional gain = $10 \log[(10^{G1/10} + 10^{G2/10} + \dots + 10^{GN/10}) / N_{ANT}]$ dBi

Ant1: 5.13dBi, Ant2: 5.19dBi, Ant3:5.37dBi , Ant4: 5.35dBi

Directional gain =11.22dBi

5 FACILITIES AND ACCREDITATIONS

5.1 FACILITIES

All measurement facilities used to collect the measurement data are located at:

Bldg 69, Majialong Industry Zone District, Nanshan District, Shenzhen, China

The sites are constructed in conformance with the requirements of ANSI C63.7, ANSI C63.10 and CISPR Publication 22.

5.2 LABORATORY ACCREDITATIONS AND LISTINGS

Site Description

EMC Lab.

: **Accredited by CNAS**

The Certificate Registration Number is L2291

The Laboratory has been assessed and proved to be in compliance with CNAS-CL01 (identical to ISO/IEC 17025:2017)

Accredited by FCC

Designation Number: CN1204

Test Firm Registration Number: 882943

Accredited by A2LA

The Certificate Number is 4321.01

Accredited by Industry Canada

The Conformity Assessment Body Identifier is CN0008

Name of Firm

: EMTEK (SHENZHEN) CO., LTD.

Site Location

: Building 69, Majialong Industry Zone, Nanshan District, Shenzhen, Guangdong, China

6 TEST SYSTEM UNCERTAINTY

The following measurement uncertainty levels have been estimated for tests performed on the apparatus:

Parameter	Uncertainty
Radio Frequency	$\pm 1 \times 10^{-5}$
Maximum Peak Output Power Test	$\pm 1.0\text{dB}$
Conducted Emissions Test	$\pm 2.0\text{dB}$
Radiated Emission Test	$\pm 2.0\text{dB}$
Power Density	$\pm 2.0\text{dB}$
Occupied Bandwidth Test	$\pm 1.0\text{dB}$
Band Edge Test	$\pm 3\text{dB}$
All emission, radiated	$\pm 3\text{dB}$
Antenna Port Emission	$\pm 3\text{dB}$
Temperature	$\pm 0.5^\circ\text{C}$
Humidity	$\pm 3\%$

Measurement Uncertainty for a level of Confidence of 95%.

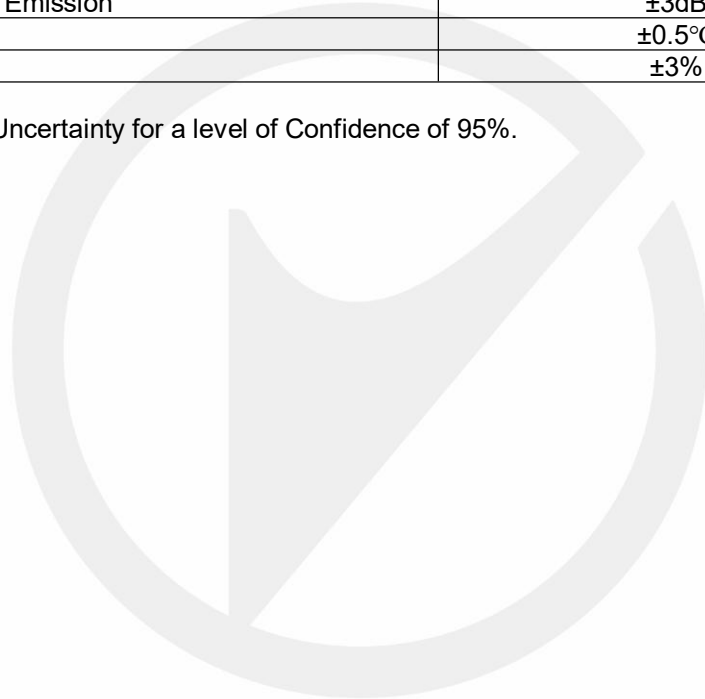

7 SETUP OF EQUIPMENT UNDER TEST

7.1 RADIO FREQUENCY TEST SETUP

The WLAN component's antenna ports(s) of the EUT are connected to the measurement instrument per an appropriate attenuator. The EUT is controlled by PC/software to emit the specified signals for the purpose of measurements.

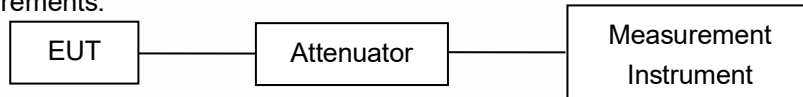

7.2 RADIO FREQUENCY TEST SETUP

The test site semi-anechoic chamber has met the requirement of NSA tolerance 4 dB according to the standards: ANSI C63.10. The test distance is 3m. The setup is according to the requirements in Section 13.1.4.1 of ANSI C63.10-2013 and CAN/CSA-CEI/IEC CISPR 22.

Below 30MHz:

The EUT is placed on a turntable 0.8 meters above the ground in the chamber, 3 meter away from the antenna (loop antenna). The Antenna should be positioned with its plane vertical at the specified distance from the EUT and rotated about its vertical axis for maximum response at each azimuth about the EUT. The center of the loop shall be 1 m above the ground. For certain applications, the loop antenna plane may also need to be positioned horizontally at the specified distance from the EUT.

Above 30MHz:

The EUT is placed on a turntable 0.8 meters above the ground in the chamber, 3 meter away from the antenna. The maximal emission value is acquired by adjusting the antenna height, polarisation and turntable azimuth. Normally, the height range of antenna is 1 m to 4 m, the azimuth range of turntable is 0° to 360°, and the receive antenna has two polarizations Vertical (V) and Horizontal (H).

Above 1GHz:

(Note: the FCC's permission to use 1.5m as an alternative per TCBC Conf call of Dec. 2, 2014.)

The EUT is placed on a turntable 1.5 meters above the ground in the chamber, 3 meter away from the antenna. The maximal emission value is acquired by adjusting the antenna height, polarisation and turntable azimuth. Normally, the height range of antenna is 1 m to 4 m, the azimuth range of turntable is 0° to 360°, and the receive antenna has two polarizations Vertical (V) and Horizontal (H).

(a) Radiated Emission Test Set-Up, Frequency Below 30MHz

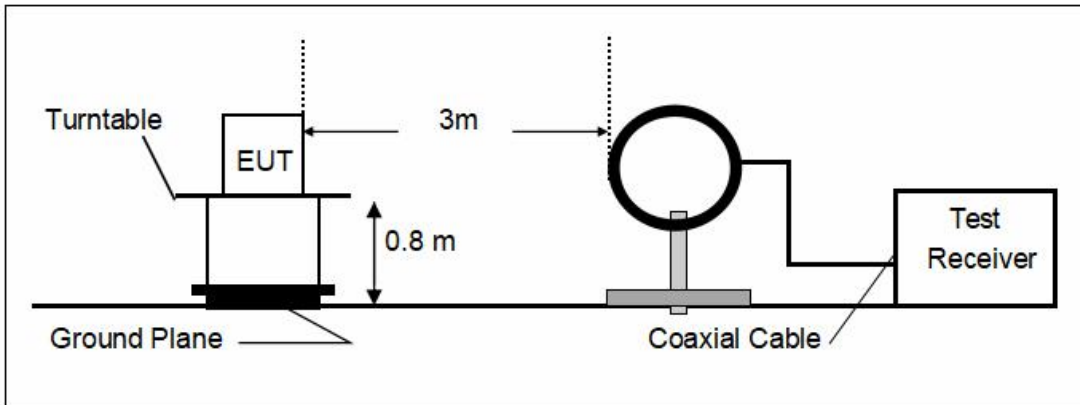

(b) Radiated Emission Test Set-Up, Frequency Below 1000MHz

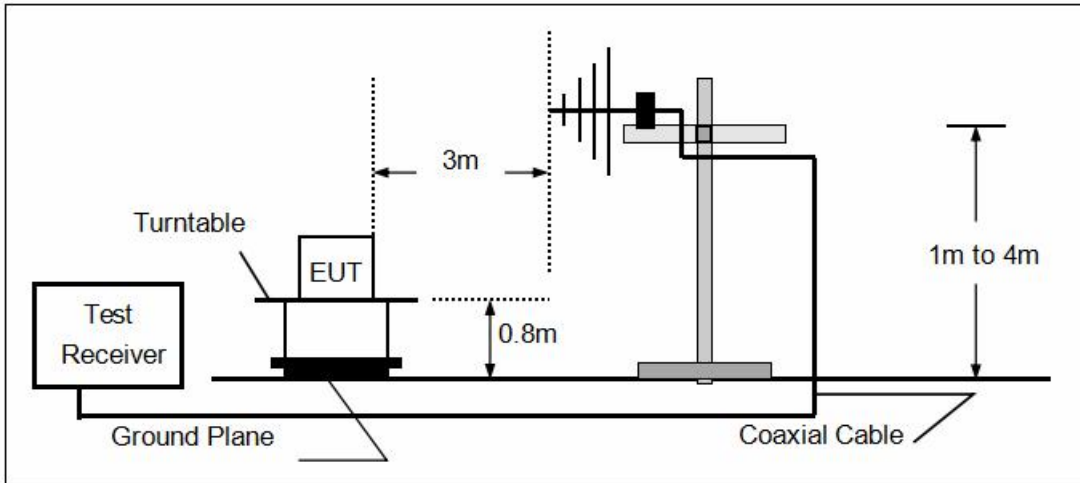

(c) Radiated Emission Test Set-Up, Frequency above 1000MHz

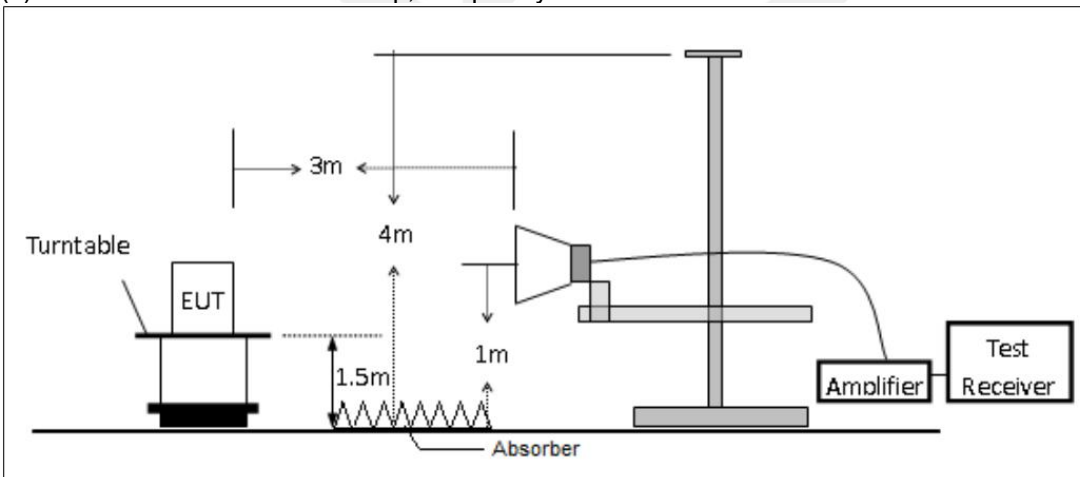

7.3 CONDUCTED EMISSION TEST SETUP

The mains cable of the EUT (maybe per AC/DC Adapter) must be connected to LISN. The LISN shall be placed 0.8 m from the boundary of EUT and bonded to a ground reference plane for LISN mounted on top of the ground reference plane. This distance is between the closest points of the LISN and the EUT. All other units of the EUT and associated equipment shall be at least 0.8m from the LISN.

Ground connections, where required for safety purposes, shall be connected to the reference ground point of the LISN and, where not otherwise provided or specified by the manufacturer, shall be of same length as the mains cable and run parallel to the mains connection at a separation distance of not more than 0.1 m.

According to the requirements in Section 13.1.4.1 of ANSI C63.10-2013 Conducted emissions from the EUT measured in the frequency range between 0.15 MHz and 30 MHz using CISPR Quasi-Peak and average detector mode.

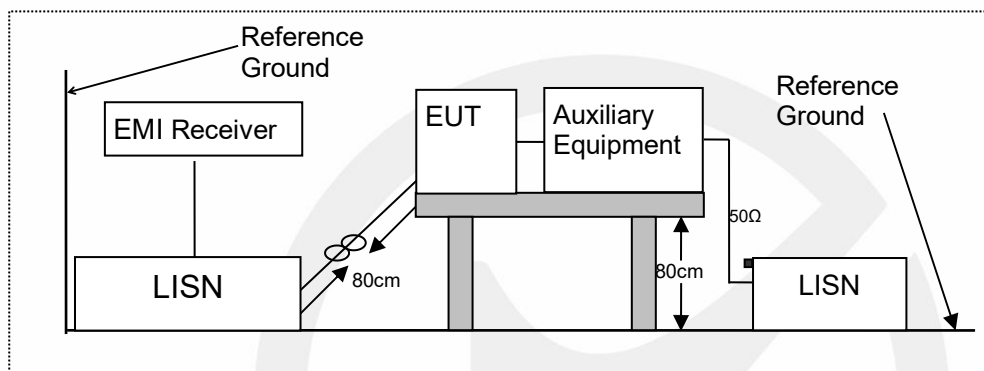

7.4 BLOCK DIAGRAM CONFIGURATION OF TEST SYSTEM

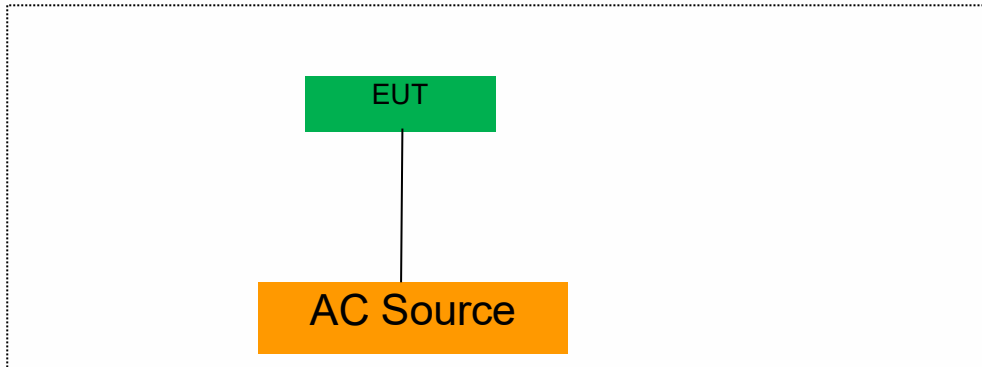

7.5 SUPPORT EQUIPMENT

N/A

Notes:

1. All the equipment/cables were placed in the worst-case configuration to maximize the emission during the test.
2. Grounding was established in accordance with the manufacturer's requirements and conditions for the intended use.
3. Unless otherwise denoted as EUT in [Remark] column, device(s) used in tested system is a support equipment.

8 TEST REQUIREMENTS

8.1 BANDWIDTH MEASUREMENT

8.1.1 Applicable Standard

According to FCC Part 15.407(a)(1) for UNII Band I
According to FCC Part 15.407(a)(2) for UNII Band II-A and UNII Band II-C
According to FCC Part 15.407(a)(3) for UNII Band III
According to FCC Part 15.407(e) for UNII Band III
According to 789033 D02 Section II(C)
According to 789033 D02 Section II(D)

8.1.2 Conformance Limit

(1) For the band 5.15-5.25 GHz.

(iv) For mobile and portable client devices in the 5.15-5.25 GHz band, the maximum conducted output power over the frequency band of operation shall not exceed 250 mW provided the maximum antenna gain does not exceed 6 dBi. In addition, the maximum power spectral density shall not exceed 11 dBm in any 1 megahertz band. If transmitting antennas of directional gain greater than 6 dBi are used, both the maximum conducted output power and the maximum power spectral density shall be reduced by the amount in dB that the directional gain of the antenna exceeds 6 dBi.

(2) For the 5.25-5.35 GHz and 5.47-5.725 GHz bands, the maximum conducted output power over the frequency bands of operation shall not exceed the lesser of 250 mW or $11 \text{ dBm} + 10 \log B$, where B is the 26 dB emission bandwidth in megahertz. In addition, the maximum power spectral density shall not exceed 11 dBm in any 1 megahertz band. If transmitting antennas of directional gain greater than 6 dBi are used, both the maximum conducted output power and the maximum power spectral density shall be reduced by the amount in dB that the directional gain of the antenna exceeds 6 dBi.

(3) For the band 5.725-5.85 GHz, the maximum conducted output power over the frequency band of operation shall not exceed 1 W. In addition, the maximum power spectral density shall not exceed 30 dBm in any 500-kHz band. If transmitting antennas of directional gain greater than 6 dBi are used, both the maximum conducted output power and the maximum power spectral density shall be reduced by the amount in dB that the directional gain of the antenna exceeds 6 dBi. However, fixed point-to-point U-NII devices operating in this band may employ transmitting antennas with directional gain greater than 6 dBi without any corresponding reduction in transmitter conducted power. Fixed, point-to-point operations exclude the use of point-to-multipoint systems, omnidirectional applications, and multiple collocated transmitters transmitting the same information. The operator of the U-NII device, or if the equipment is professionally installed, the installer, is responsible for ensuring that systems employing high gain directional antennas are used exclusively for fixed, point-to-point operations.

(e) Within the 5.725-5.85 GHz band, the minimum 6 dB bandwidth of U-NII devices shall be at least 500 kHz.

8.1.3 Test Configuration

Test according to clause 6.1 radio frequency test setup.

8.1.4 Test Procedure

According to 789033 D02 v02r01 section C&D, the following is the measurement procedure.

1. Emission Bandwidth (EBW)

- a) Set RBW = approximately 1% of the emission bandwidth.
- b) Set the VBW > RBW.
- c) Detector = Peak.
- d) Trace mode = max hold.
- e) Measure the maximum width of the emission that is 26 dB down from the maximum of the emission.

Compare this with the RBW setting of the analyzer. Readjust RBW and repeat measurement as needed until the RBW/EBW ratio is approximately 1%.

2. Minimum Emission Bandwidth for the band 5.725-5.85 GHz

Section 15.407(e) specifies the minimum 6 dB emission bandwidth of at least 500 KHz for the band 5.715-5.85 GHz. The following procedure shall be used for measuring this bandwidth:

- a) Set RBW = 100 kHz.
- b) Set the video bandwidth (VBW) $\geq 3 \times$ RBW.
- c) Detector = Peak.
- d) Trace mode = max hold.
- e) Sweep = auto couple.
- f) Allow the trace to stabilize.
- g) Measure the maximum width of the emission that is constrained by the frequencies associated with the two outermost amplitude points (upper and lower frequencies) that are attenuated by 6 dB relative to the maximum level measured in the fundamental emission.

Note: The automatic bandwidth measurement capability of a spectrum analyzer or EMI receiver may be employed if it implements the functionality described above.

D. 99 Percent Occupied Bandwidth

The 99-percent occupied bandwidth is the frequency bandwidth such that, below its lower and above its upper frequency limits, the mean powers are each equal to 0.5 % of the total mean power of the given emission. Measurement of the 99-percent occupied bandwidth is required only as a condition for using the optional band-edge measurement techniques described in section II.G.3.d). Measurements of 99-percent occupied bandwidth may also optionally be used in lieu of the EBW to 789033 D02 v01r02 General UNII Test Procedures New Rules v01 define the minimum frequency range over which the spectrum is integrated when measuring maximum conducted output power as described in section II.E. However, the EBW must be measured to determine bandwidth dependent limits on maximum conducted output power in accordance with 15.407(a).

The following procedure shall be used for measuring (99 %) power bandwidth:

1. Set center frequency to the nominal EUT channel center frequency.
2. Set span = 1.5 times to 5.0 times the OBW.
3. Set RBW = 1 % to 5 % of the OBW.
4. Set VBW $\geq 3 \times$ RBW.
5. Video averaging is not permitted. Where practical, a sample detection and single sweep mode shall be used. Otherwise, peak detection and max hold mode (until the trace stabilizes) shall be used.
6. Use the 99 % power bandwidth function of the instrument (if available).
7. If the instrument does not have a 99 % power bandwidth function, the trace data points are recovered and directly summed in power units. The recovered amplitude data points, beginning at the lowest frequency, are placed in a running sum until 0.5 % of the total is reached; that frequency is recorded as the lower frequency. The process is repeated until 99.5 % of the total is reached; that frequency is recorded as the upper frequency. The 99% occupied bandwidth is the difference between these two frequencies.

	Ant3	5825	19.84	5815.04	5834.88	---	---
	Ant4	5825	20.08	5815.08	5835.16	---	---
11N20MIMO	Ant1	5180	20.16	5169.92	5190.08	---	---
	Ant2	5180	20.08	5170.00	5190.08	---	---
	Ant3	5180	20.16	5169.84	5190.00	---	---
	Ant4	5180	20.20	5169.84	5190.04	---	---
	Ant1	5200	20.28	5189.80	5210.08	---	---
	Ant2	5200	20.32	5189.76	5210.08	---	---
	Ant3	5200	20.12	5189.84	5209.96	---	---
	Ant4	5200	19.92	5189.96	5209.88	---	---
	Ant1	5240	20.44	5229.72	5250.16	---	---
	Ant2	5240	19.96	5230.00	5249.96	---	---
	Ant3	5240	20.04	5229.88	5249.92	---	---
	Ant4	5240	20.04	5229.88	5249.92	---	---
	Ant1	5260	20.20	5249.80	5270.00	---	---
	Ant2	5260	20.04	5249.88	5269.92	---	---
	Ant3	5260	20.12	5249.80	5269.92	---	---
	Ant4	5260	20.20	5249.76	5269.96	---	---
	Ant1	5280	20.28	5269.88	5290.16	---	---
	Ant2	5280	20.16	5269.80	5289.96	---	---
	Ant3	5280	20.28	5269.84	5290.12	---	---
	Ant4	5280	20.24	5269.88	5290.12	---	---
	Ant1	5320	20.28	5309.80	5330.08	---	---
	Ant2	5320	20.16	5309.80	5329.96	---	---
	Ant3	5320	20.16	5309.88	5330.04	---	---
	Ant4	5320	20.24	5309.80	5330.04	---	---
	Ant1	5500	20.20	5489.84	5510.04	---	---
	Ant2	5500	20.12	5489.88	5510.00	---	---
	Ant3	5500	20.28	5489.72	5510.00	---	---
	Ant4	5500	20.00	5489.92	5509.92	---	---
	Ant1	5580	20.20	5569.84	5590.04	---	---
	Ant2	5580	20.28	5569.84	5590.12	---	---
	Ant3	5580	20.28	5569.80	5590.08	---	---
	Ant4	5580	20.12	5569.84	5589.96	---	---
	Ant1	5700	20.24	5689.84	5710.08	---	---
	Ant2	5700	20.04	5689.92	5709.96	---	---
	Ant3	5700	20.08	5689.92	5710.00	---	---
	Ant4	5700	20.08	5689.96	5710.04	---	---
	Ant1	5745	20.24	5734.84	5755.08	---	---
	Ant2	5745	20.12	5734.84	5754.96	---	---
	Ant3	5745	19.96	5734.96	5754.92	---	---
	Ant4	5745	19.84	5735.00	5754.84	---	---
Ant1	5785	20.12	5774.84	5794.96	---	---	
Ant2	5785	20.08	5774.92	5795.00	---	---	
Ant3	5785	20.00	5774.88	5794.88	---	---	
Ant4	5785	19.96	5775.00	5794.96	---	---	
Ant1	5825	20.04	5814.88	5834.92	---	---	
Ant2	5825	20.04	5815.00	5835.04	---	---	
Ant3	5825	20.00	5814.92	5834.92	---	---	
Ant4	5825	19.96	5814.96	5834.92	---	---	
11N40MIMO	Ant1	5190	41.12	5169.36	5210.48	---	---
	Ant2	5190	40.24	5169.76	5210.00	---	---
	Ant3	5190	40.96	5169.44	5210.40	---	---
	Ant4	5190	40.32	5169.76	5210.08	---	---
	Ant1	5230	40.88	5209.52	5250.40	---	---

	Ant2	5230	40.64	5209.68	5250.32	---	---
	Ant3	5230	40.56	5209.68	5250.24	---	---
	Ant4	5230	40.56	5209.76	5250.32	---	---
	Ant1	5270	41.36	5249.36	5290.72	---	---
	Ant2	5270	41.20	5249.28	5290.48	---	---
	Ant3	5270	41.76	5248.96	5290.72	---	---
	Ant4	5270	40.24	5249.84	5290.08	---	---
	Ant1	5310	41.68	5289.12	5330.80	---	---
	Ant2	5310	40.88	5289.28	5330.16	---	---
	Ant3	5310	41.36	5289.36	5330.72	---	---
	Ant4	5310	40.64	5289.36	5330.00	---	---
	Ant1	5510	41.12	5489.44	5530.56	---	---
	Ant2	5510	40.96	5489.44	5530.40	---	---
	Ant3	5510	41.20	5489.28	5530.48	---	---
	Ant4	5510	40.88	5489.52	5530.40	---	---
	Ant1	5550	41.52	5529.04	5570.56	---	---
	Ant2	5550	40.64	5529.60	5570.24	---	---
	Ant3	5550	40.88	5529.52	5570.40	---	---
	Ant4	5550	40.16	5530.00	5570.16	---	---
	Ant1	5670	41.68	5649.20	5690.88	---	---
	Ant2	5670	40.56	5649.84	5690.40	---	---
	Ant3	5670	40.72	5649.52	5690.24	---	---
	Ant4	5670	40.88	5649.44	5690.32	---	---
	Ant1	5755	40.96	5734.44	5775.40	---	---
	Ant2	5755	40.32	5734.84	5775.16	---	---
	Ant3	5755	40.32	5734.84	5775.16	---	---
	Ant4	5755	40.80	5734.44	5775.24	---	---
	Ant1	5795	41.04	5774.36	5815.40	---	---
	Ant2	5795	40.40	5774.68	5815.08	---	---
	Ant3	5795	40.80	5774.52	5815.32	---	---
	Ant4	5795	40.64	5774.52	5815.16	---	---
11AC20MIMO	Ant1	5180	20.12	5169.88	5190.00	---	---
	Ant2	5180	19.92	5169.96	5189.88	---	---
	Ant3	5180	19.76	5170.08	5189.84	---	---
	Ant4	5180	19.92	5170.00	5189.92	---	---
	Ant1	5200	20.24	5189.88	5210.12	---	---
	Ant2	5200	20.08	5189.96	5210.04	---	---
	Ant3	5200	20.00	5189.96	5209.96	---	---
	Ant4	5200	20.00	5189.96	5209.96	---	---
	Ant1	5240	20.12	5229.88	5250.00	---	---
	Ant2	5240	20.00	5230.00	5250.00	---	---
	Ant3	5240	19.80	5230.04	5249.84	---	---
	Ant4	5240	19.84	5230.04	5249.88	---	---
	Ant1	5260	20.16	5249.84	5270.00	---	---
	Ant2	5260	19.88	5250.04	5269.92	---	---
	Ant3	5260	20.16	5249.80	5269.96	---	---
	Ant4	5260	19.96	5249.92	5269.88	---	---
	Ant1	5280	19.96	5270.00	5289.96	---	---
	Ant2	5280	19.92	5270.00	5289.92	---	---
	Ant3	5280	19.96	5269.96	5289.92	---	---
	Ant4	5280	19.96	5269.96	5289.92	---	---
	Ant1	5320	20.00	5309.92	5329.92	---	---
	Ant2	5320	19.96	5309.96	5329.92	---	---
	Ant3	5320	20.08	5309.92	5330.00	---	---
	Ant4	5320	20.08	5309.84	5329.92	---	---

	Ant1	5500	20.24	5489.76	5510.00	---	---
	Ant2	5500	20.00	5489.96	5509.96	---	---
	Ant3	5500	20.04	5489.92	5509.96	---	---
	Ant4	5500	20.04	5489.96	5510.00	---	---
	Ant1	5580	20.28	5569.76	5590.04	---	---
	Ant2	5580	20.16	5569.84	5590.00	---	---
	Ant3	5580	20.08	5569.92	5590.00	---	---
	Ant4	5580	20.04	5570.00	5590.04	---	---
	Ant1	5700	20.08	5689.88	5709.96	---	---
	Ant2	5700	20.00	5690.00	5710.00	---	---
	Ant3	5700	20.12	5689.88	5710.00	---	---
	Ant4	5700	19.92	5689.96	5709.88	---	---
	Ant1	5745	20.08	5734.88	5754.96	---	---
	Ant2	5745	19.84	5735.04	5754.88	---	---
	Ant3	5745	19.96	5734.96	5754.92	---	---
	Ant4	5745	19.84	5735.04	5754.88	---	---
	Ant1	5785	20.12	5774.84	5794.96	---	---
	Ant2	5785	19.84	5775.04	5794.88	---	---
	Ant3	5785	19.88	5775.04	5794.92	---	---
	Ant4	5785	19.96	5774.92	5794.88	---	---
	Ant1	5825	20.00	5814.96	5834.96	---	---
	Ant2	5825	20.00	5814.88	5834.88	---	---
	Ant3	5825	19.92	5815.00	5834.92	---	---
	Ant4	5825	19.92	5814.92	5834.84	---	---
11AC40MIMO	Ant1	5190	40.80	5169.44	5210.24	---	---
	Ant2	5190	40.08	5169.92	5210.00	---	---
	Ant3	5190	40.24	5169.84	5210.08	---	---
	Ant4	5190	40.16	5169.84	5210.00	---	---
	Ant1	5230	40.72	5209.76	5250.48	---	---
	Ant2	5230	40.16	5209.92	5250.08	---	---
	Ant3	5230	40.72	5209.60	5250.32	---	---
	Ant4	5230	40.40	5209.76	5250.16	---	---
	Ant1	5270	40.56	5249.68	5290.24	---	---
	Ant2	5270	40.16	5249.92	5290.08	---	---
	Ant3	5270	40.64	5249.60	5290.24	---	---
	Ant4	5270	40.24	5249.68	5289.92	---	---
	Ant1	5310	40.56	5289.68	5330.24	---	---
	Ant2	5310	40.16	5289.84	5330.00	---	---
	Ant3	5310	40.40	5289.68	5330.08	---	---
	Ant4	5310	40.00	5289.84	5329.84	---	---
	Ant1	5510	40.72	5489.60	5530.32	---	---
	Ant2	5510	39.92	5489.92	5529.84	---	---
	Ant3	5510	40.32	5489.60	5529.92	---	---
	Ant4	5510	40.40	5489.76	5530.16	---	---
	Ant1	5550	40.24	5529.76	5570.00	---	---
	Ant2	5550	39.92	5530.08	5570.00	---	---
	Ant3	5550	40.32	5529.92	5570.24	---	---
	Ant4	5550	40.40	5529.84	5570.24	---	---
	Ant1	5670	40.56	5649.68	5690.24	---	---
	Ant2	5670	40.24	5649.92	5690.16	---	---
	Ant3	5670	40.32	5649.84	5690.16	---	---
	Ant4	5670	40.56	5649.68	5690.24	---	---
	Ant1	5755	40.80	5734.52	5775.32	---	---
	Ant2	5755	39.92	5735.00	5774.92	---	---
	Ant3	5755	40.00	5735.00	5775.00	---	---

	Ant4	5755	40.56	5734.52	5775.08	---	---
	Ant1	5795	40.64	5774.52	5815.16	---	---
	Ant2	5795	40.40	5774.68	5815.08	---	---
	Ant3	5795	40.40	5774.68	5815.08	---	---
	Ant4	5795	40.24	5774.76	5815.00	---	---
11AC80MIMO	Ant1	5210	80.16	5169.84	5250.00	---	---
	Ant2	5210	80.00	5170.16	5250.16	---	---
	Ant3	5210	79.68	5170.16	5249.84	---	---
	Ant4	5210	80.00	5170.00	5250.00	---	---
	Ant1	5290	80.32	5249.68	5330.00	---	---
	Ant2	5290	80.16	5249.84	5330.00	---	---
	Ant3	5290	80.00	5249.84	5329.84	---	---
	Ant4	5290	79.84	5250.00	5329.84	---	---
	Ant1	5530	80.16	5490.00	5570.16	---	---
	Ant2	5530	80.16	5489.84	5570.00	---	---
	Ant3	5530	79.84	5490.00	5569.84	---	---
	Ant4	5530	80.00	5490.16	5570.16	---	---
	Ant1	5610	80.32	5569.68	5650.00	---	---
	Ant2	5610	80.16	5570.00	5650.16	---	---
	Ant3	5610	79.84	5570.00	5649.84	---	---
	Ant4	5610	80.00	5570.00	5650.00	---	---
	Ant1	5775	80.16	5734.84	5815.00	---	---
	Ant2	5775	80.00	5735.00	5815.00	---	---
	Ant3	5775	79.68	5735.00	5814.68	---	---
	Ant4	5775	79.84	5735.00	5814.84	---	---
11AX20MIMO	Ant1	5180	23.04	5168.32	5191.36	---	---
	Ant2	5180	22.76	5168.44	5191.20	---	---
	Ant3	5180	24.32	5167.28	5191.60	---	---
	Ant4	5180	24.20	5167.04	5191.24	---	---
	Ant1	5200	23.76	5187.76	5211.52	---	---
	Ant2	5200	23.88	5188.36	5212.24	---	---
	Ant3	5200	23.40	5187.68	5211.08	---	---
	Ant4	5200	23.16	5188.52	5211.68	---	---
	Ant1	5240	19.92	5230.00	5249.92	---	---
	Ant2	5240	19.84	5230.04	5249.88	---	---
	Ant3	5240	19.88	5230.00	5249.88	---	---
	Ant4	5240	19.88	5230.00	5249.88	---	---
	Ant1	5260	24.92	5247.28	5272.20	---	---
	Ant2	5260	23.92	5247.68	5271.60	---	---
	Ant3	5260	25.08	5246.48	5271.56	---	---
	Ant4	5260	23.84	5247.32	5271.16	---	---
	Ant1	5280	23.56	5267.76	5291.32	---	---
	Ant2	5280	22.80	5268.12	5290.92	---	---
	Ant3	5280	27.00	5268.12	5295.12	---	---
	Ant4	5280	23.16	5268.68	5291.84	---	---
	Ant1	5320	23.40	5308.72	5332.12	---	---
	Ant2	5320	25.12	5307.28	5332.40	---	---
	Ant3	5320	23.24	5308.32	5331.56	---	---
	Ant4	5320	23.80	5307.72	5331.52	---	---
	Ant1	5500	22.96	5488.72	5511.68	---	---
	Ant2	5500	23.20	5488.64	5511.84	---	---
	Ant3	5500	26.96	5484.76	5511.72	---	---
	Ant4	5500	22.96	5488.72	5511.68	---	---
	Ant1	5580	24.76	5567.68	5592.44	---	---
	Ant2	5580	21.88	5569.08	5590.96	---	---

	Ant3	5580	22.76	5568.36	5591.12	---	---
	Ant4	5580	23.32	5568.68	5592.00	---	---
	Ant1	5700	23.40	5688.48	5711.88	---	---
	Ant2	5700	22.96	5688.76	5711.72	---	---
	Ant3	5700	23.08	5688.36	5711.44	---	---
	Ant4	5700	23.92	5687.48	5711.40	---	---
	Ant1	5745	25.00	5731.52	5756.52	---	---
	Ant2	5745	23.56	5733.04	5756.60	---	---
	Ant3	5745	24.16	5732.44	5756.60	---	---
	Ant4	5745	23.64	5732.96	5756.60	---	---
	Ant1	5785	24.84	5771.60	5796.44	---	---
	Ant2	5785	23.68	5773.08	5796.76	---	---
	Ant3	5785	23.52	5772.76	5796.28	---	---
	Ant4	5785	25.12	5772.56	5797.68	---	---
	Ant1	5825	22.16	5813.96	5836.12	---	---
	Ant2	5825	24.24	5812.04	5836.28	---	---
	Ant3	5825	22.20	5813.56	5835.76	---	---
	Ant4	5825	22.84	5813.56	5836.40	---	---
11AX40MIMO	Ant1	5190	39.84	5170.08	5209.92	---	---
	Ant2	5190	39.92	5170.00	5209.92	---	---
	Ant3	5190	39.84	5170.00	5209.84	---	---
	Ant4	5190	39.84	5170.00	5209.84	---	---
	Ant1	5230	39.84	5210.08	5249.92	---	---
	Ant2	5230	39.76	5210.08	5249.84	---	---
	Ant3	5230	39.76	5210.08	5249.84	---	---
	Ant4	5230	39.76	5210.08	5249.84	---	---
	Ant1	5270	40.00	5250.00	5290.00	---	---
	Ant2	5270	39.84	5250.00	5289.84	---	---
	Ant3	5270	39.68	5250.08	5289.76	---	---
	Ant4	5270	39.84	5250.00	5289.84	---	---
	Ant1	5310	39.76	5290.08	5329.84	---	---
	Ant2	5310	39.84	5290.08	5329.92	---	---
	Ant3	5310	39.76	5290.08	5329.84	---	---
	Ant4	5310	39.84	5290.00	5329.84	---	---
	Ant1	5510	39.84	5490.08	5529.92	---	---
	Ant2	5510	39.84	5490.00	5529.84	---	---
	Ant3	5510	39.92	5490.00	5529.92	---	---
	Ant4	5510	39.76	5490.08	5529.84	---	---
	Ant1	5550	39.84	5530.00	5569.84	---	---
	Ant2	5550	39.76	5530.08	5569.84	---	---
	Ant3	5550	39.76	5530.08	5569.84	---	---
	Ant4	5550	39.92	5530.00	5569.92	---	---
	Ant1	5670	39.84	5650.08	5689.92	---	---
	Ant2	5670	39.76	5650.08	5689.84	---	---
	Ant3	5670	39.84	5650.00	5689.84	---	---
	Ant4	5670	39.76	5650.08	5689.84	---	---
	Ant1	5755	39.76	5735.08	5774.84	---	---
	Ant2	5755	39.84	5735.00	5774.84	---	---
	Ant3	5755	39.92	5735.00	5774.92	---	---
	Ant4	5755	39.68	5735.08	5774.76	---	---
Ant1	5795	39.84	5775.00	5814.84	---	---	
Ant2	5795	39.76	5775.08	5814.84	---	---	
Ant3	5795	39.76	5775.08	5814.84	---	---	
Ant4	5795	39.76	5775.00	5814.76	---	---	
11AX80MIMO	Ant1	5210	80.64	5169.52	5250.16	---	---

Ant2	5210	80.80	5169.68	5250.48	---	---
Ant3	5210	80.80	5169.52	5250.32	---	---
Ant4	5210	80.48	5169.68	5250.16	---	---
Ant1	5290	80.80	5249.52	5330.32	---	---
Ant2	5290	80.48	5249.68	5330.16	---	---
Ant3	5290	80.80	5249.52	5330.32	---	---
Ant4	5290	80.48	5249.68	5330.16	---	---
Ant1	5530	80.80	5489.52	5570.32	---	---
Ant2	5530	80.80	5489.52	5570.32	---	---
Ant3	5530	80.64	5489.68	5570.32	---	---
Ant4	5530	80.64	5489.68	5570.32	---	---
Ant1	5610	80.48	5569.68	5650.16	---	---
Ant2	5610	80.64	5569.68	5650.32	---	---
Ant3	5610	80.64	5569.68	5650.32	---	---
Ant4	5610	80.48	5569.68	5650.16	---	---
Ant1	5775	80.64	5734.68	5815.32	---	---
Ant2	5775	80.48	5734.68	5815.16	---	---
Ant3	5775	80.64	5734.68	5815.32	---	---
Ant4	5775	80.64	5734.52	5815.16	---	---

11A_Ant1_5180

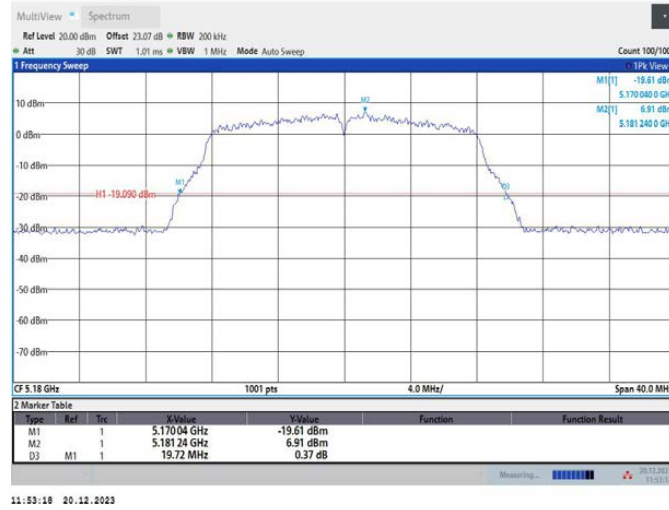

11A_Ant2_5180

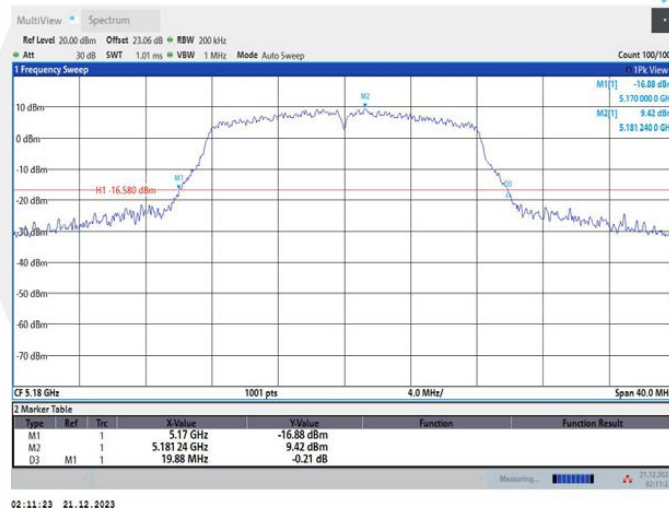

11A_Ant3_5180

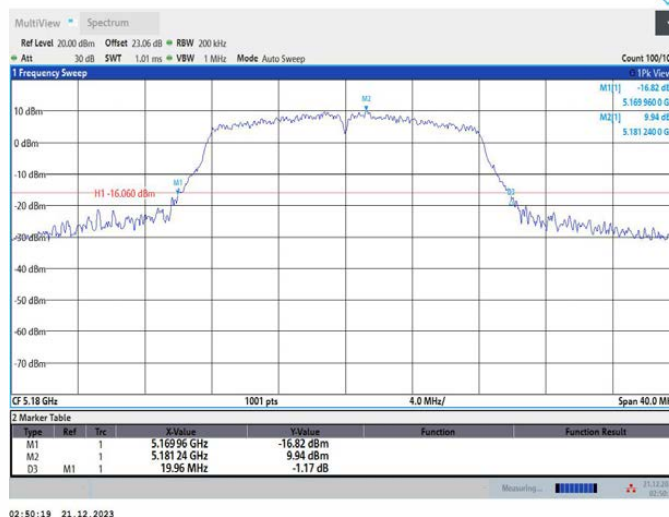

11A_Ant4_5180

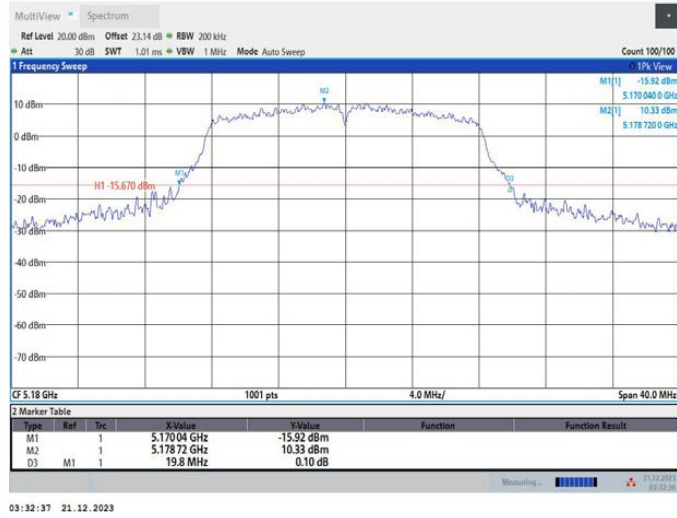

11A_Ant1_5200

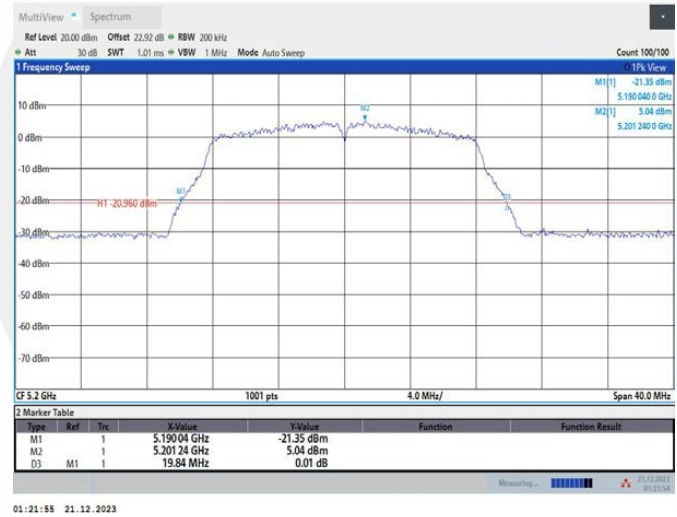

11A_Ant2_5200

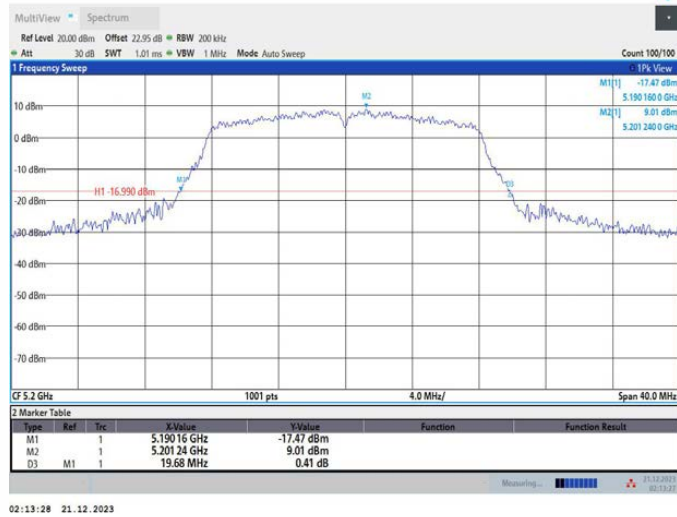

11A_Ant3_5200

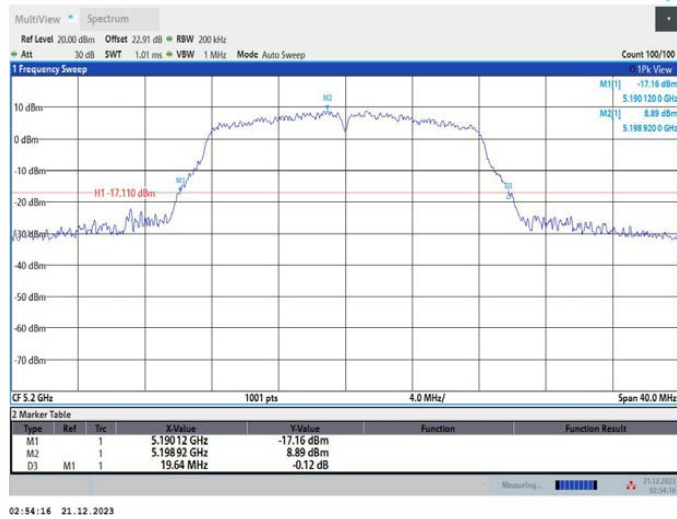

11A_Ant4_5200

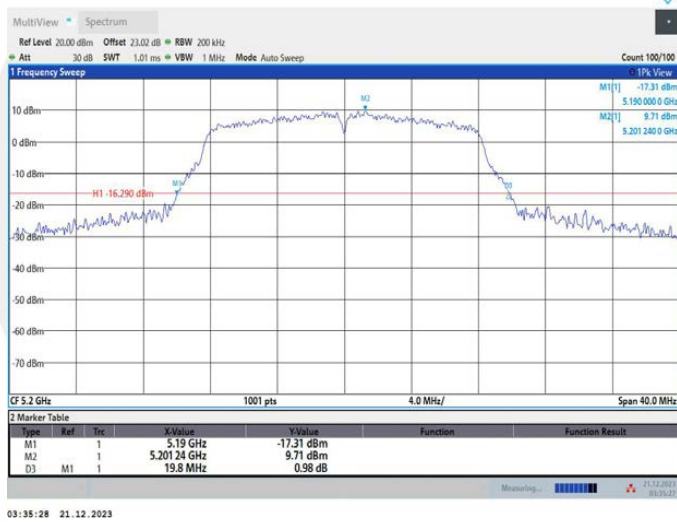

11A_Ant1_5240



11A_Ant2_5240

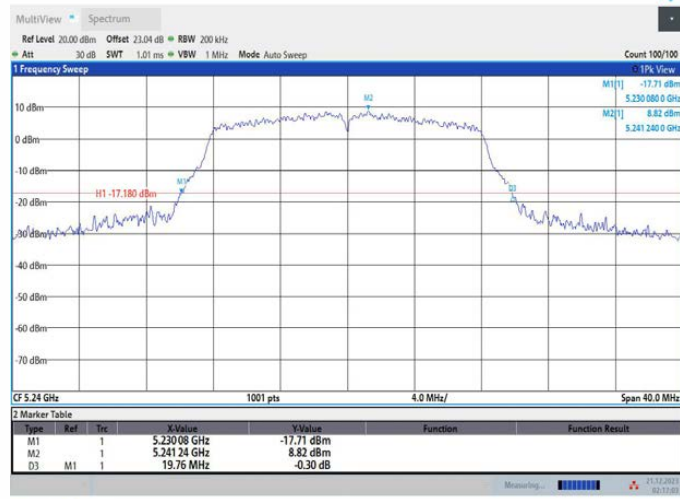

02:17:03 21.12.2023

11A_Ant3_5240

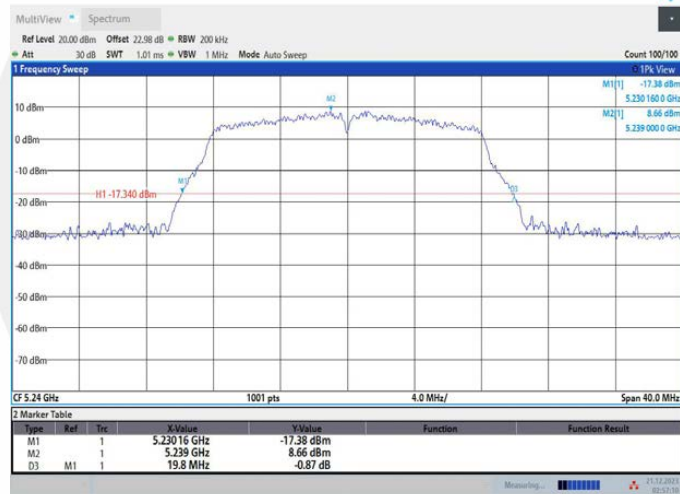

02:57:11 21.12.2023

11A_Ant4_5240



03:38:20 21.12.2023

11A_Ant1_5260

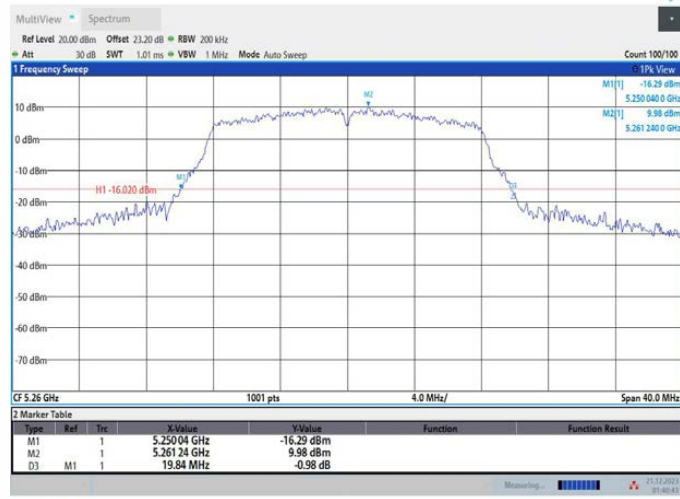

01:40:43 21.12.2023

11A_Ant2_5260



02:21:15 21.12.2023

11A_Ant3_5260



03:02:36 21.12.2023

11A_Ant4_5260

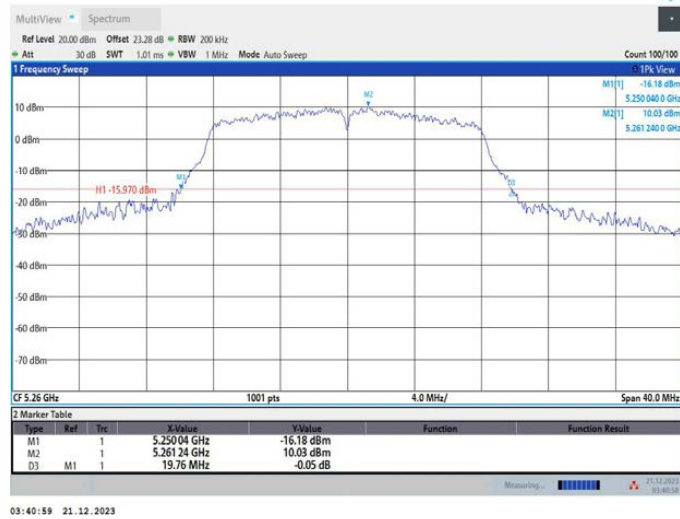

11A_Ant1_5280

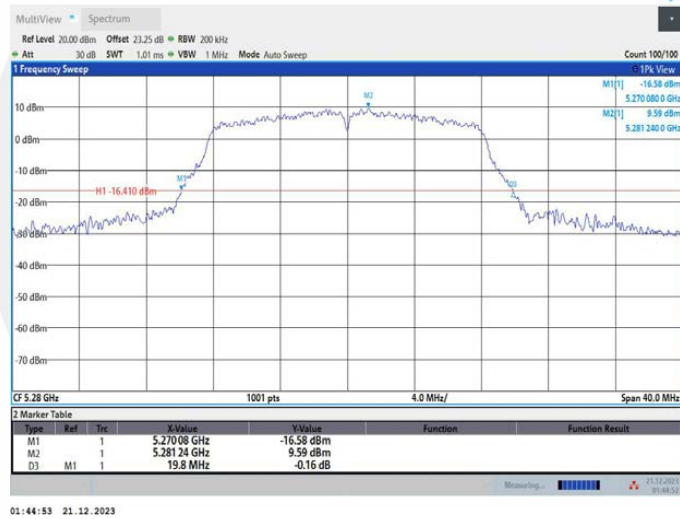

11A_Ant2_5280

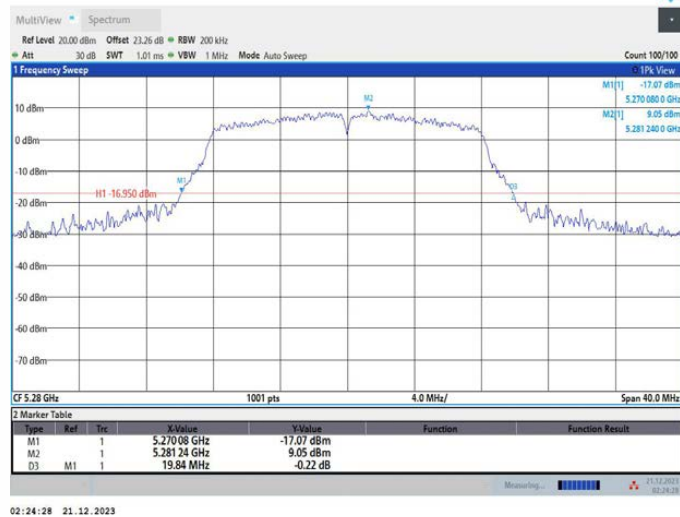

11A_Ant3_5280

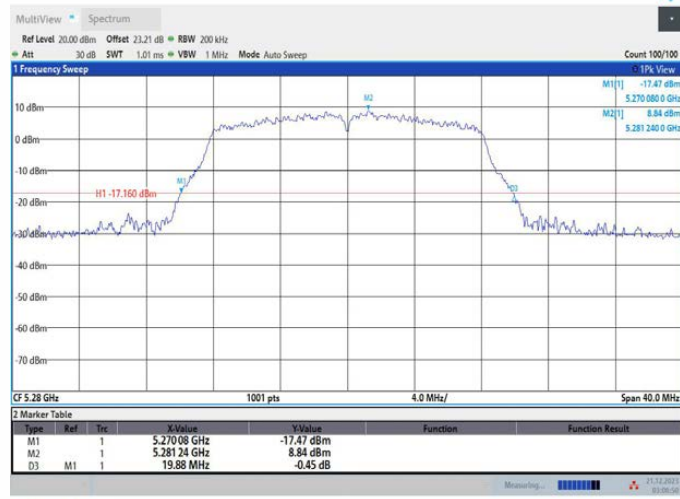

03:06:51 21.12.2023

11A_Ant4_5280



03:43:13 21.12.2023

11A_Ant1_5320



01:48:06 21.12.2023

11A_Ant2_5320

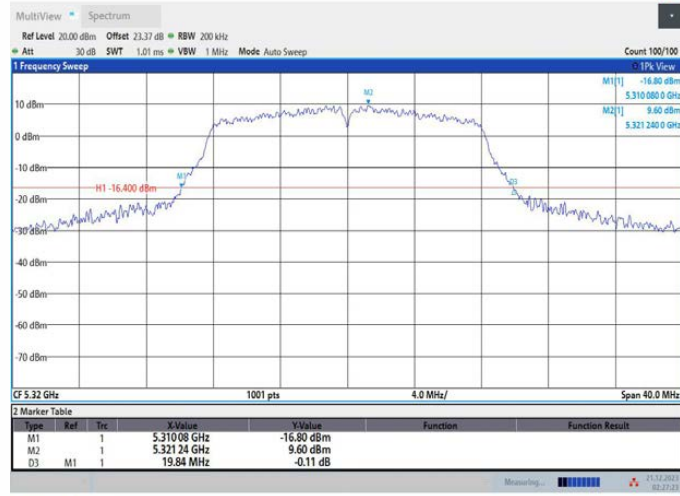

02:27:23 21.12.2023

11A_Ant3_5320

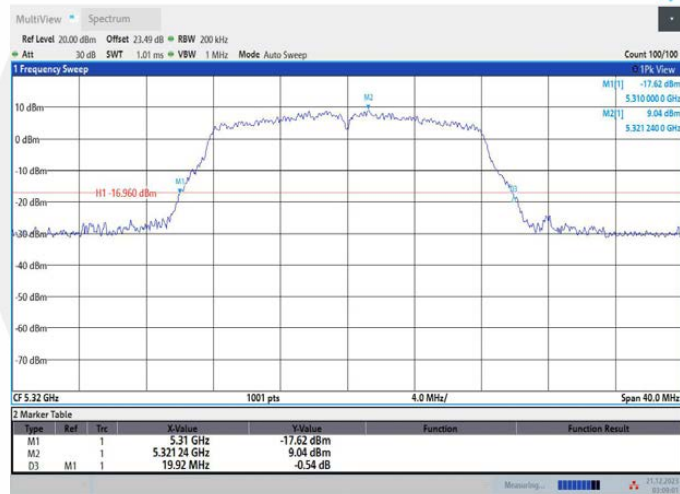

03:09:01 21.12.2023

11A_Ant4_5320

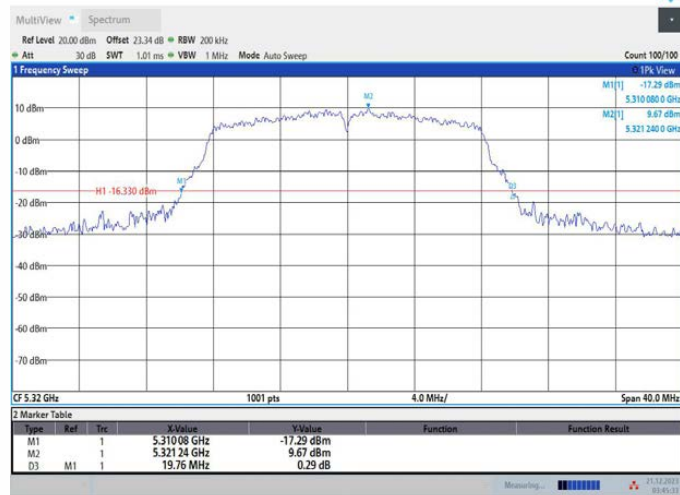

03:45:34 21.12.2023

11A_Ant1_5500

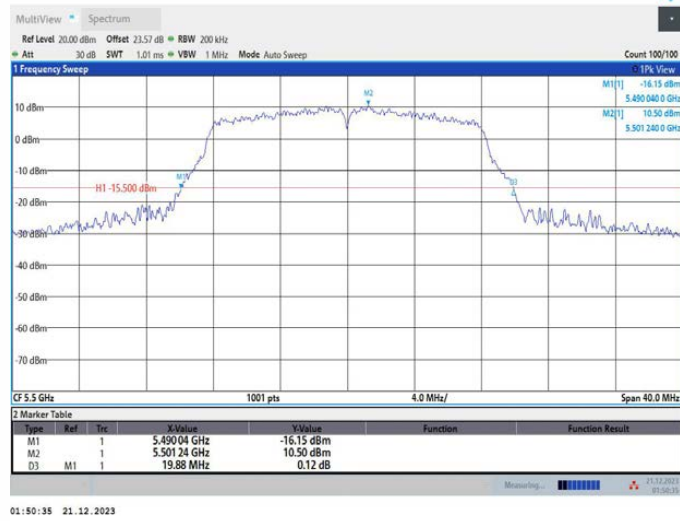

01:50:35 21.12.2023

11A_Ant2_5500

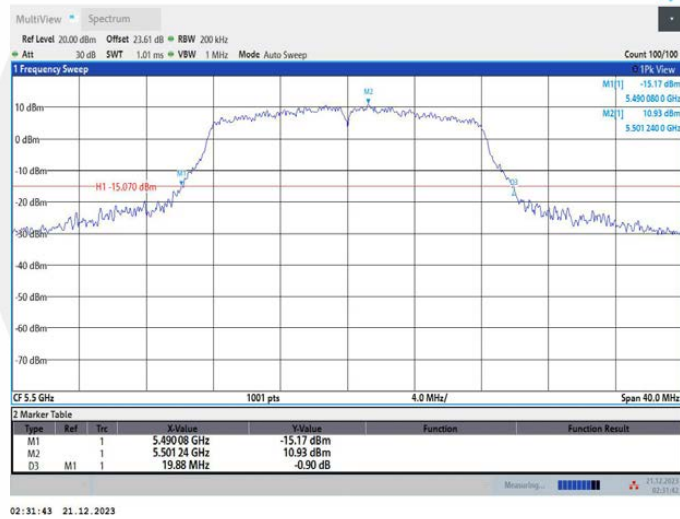

02:31:43 21.12.2023

11A_Ant3_5500

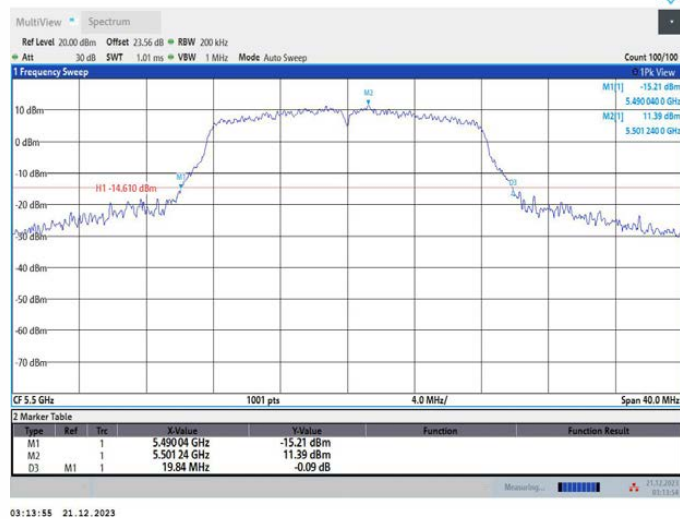

03:13:56 21.12.2023

11A_Ant4_5500

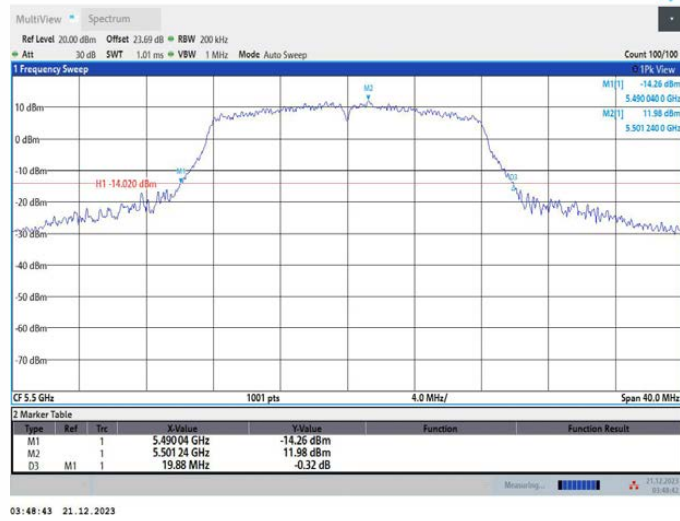

11A_Ant1_5580

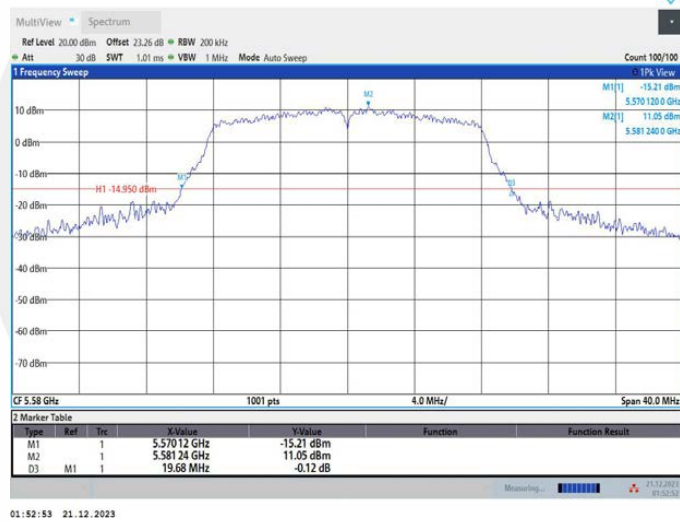

11A_Ant2_5580

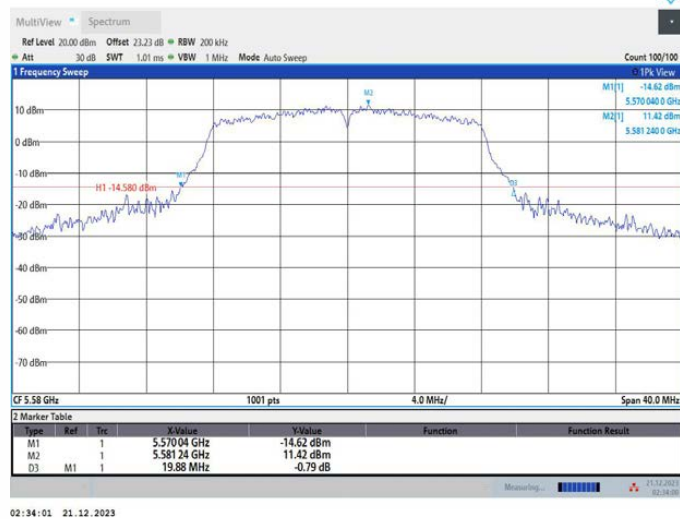

11A_Ant3_5580

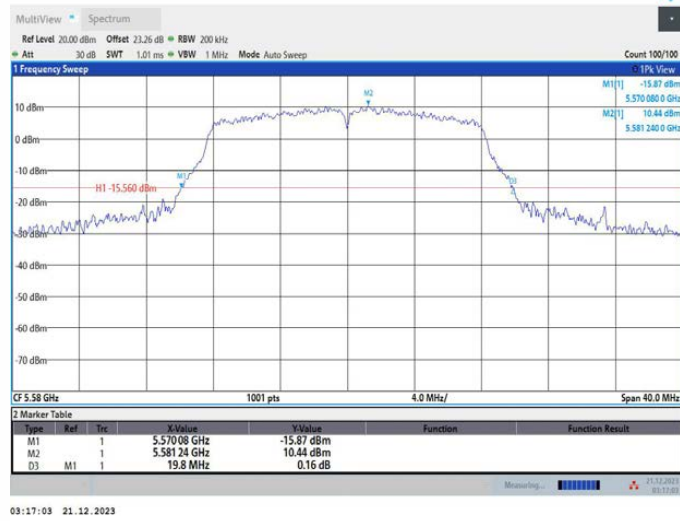

03:17:03 21.12.2023

11A_Ant4_5580

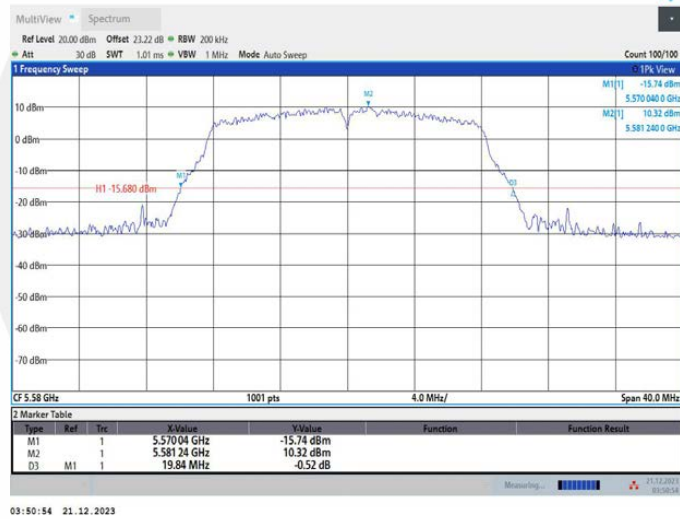

03:50:54 21.12.2023

11A_Ant1_5700

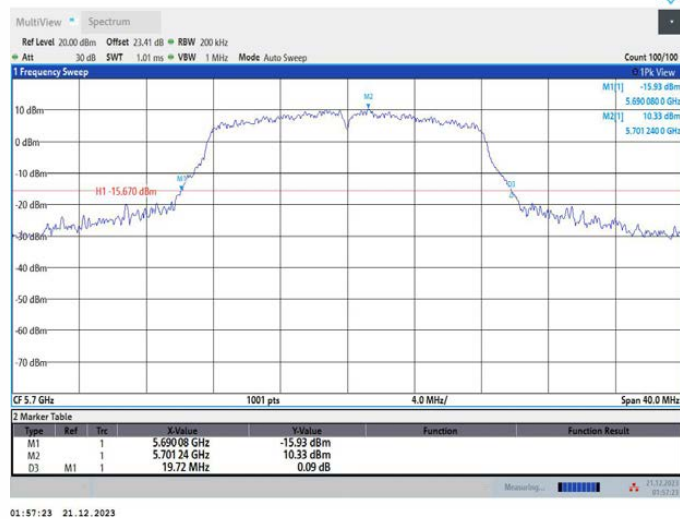

01:57:23 21.12.2023

11A_Ant2_5700

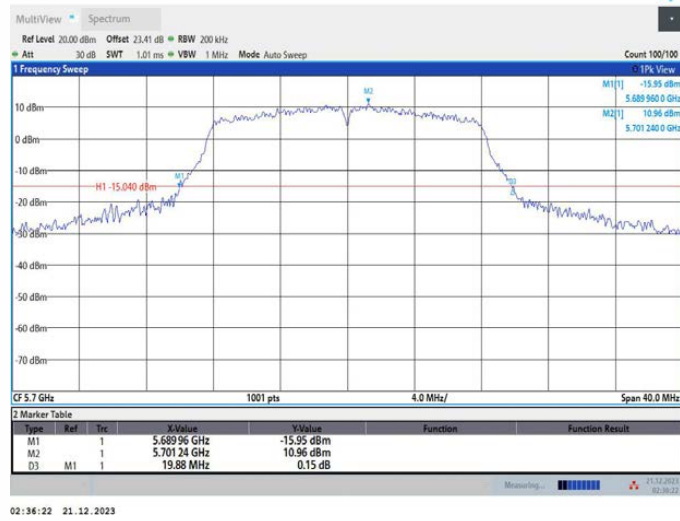

11A_Ant3_5700

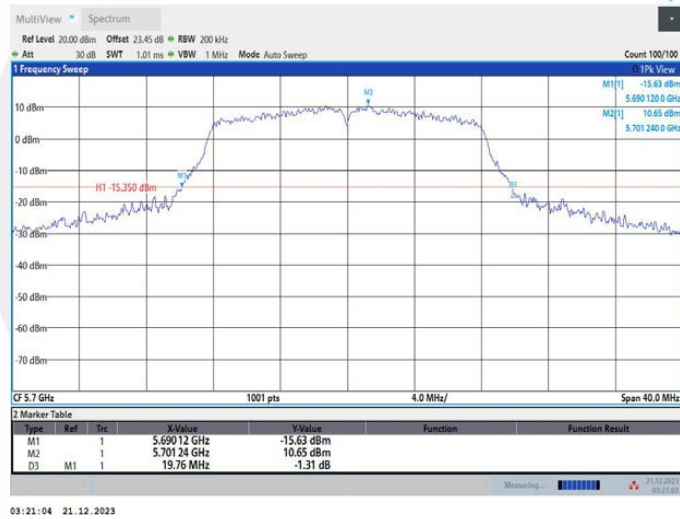

11A_Ant4_5700

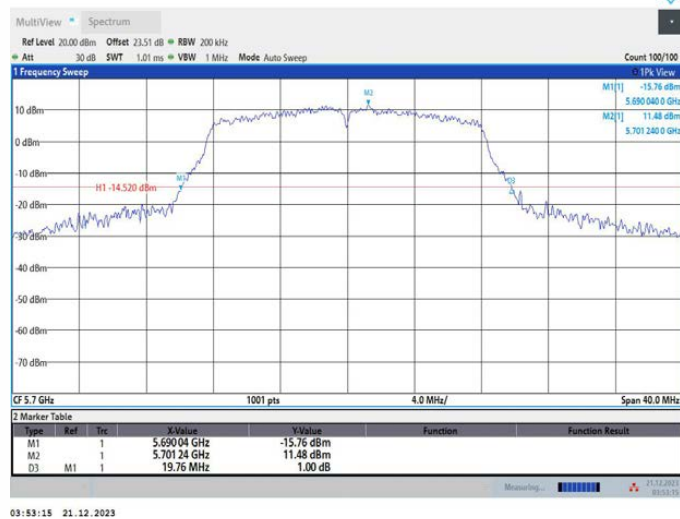

11A_Ant1_5745

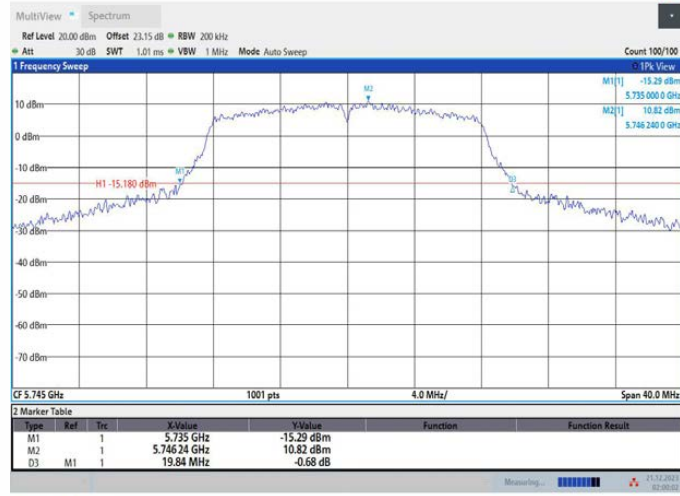

02:00:02 21.12.2023

11A_Ant2_5745



02:39:26 21.12.2023

11A_Ant3_5745

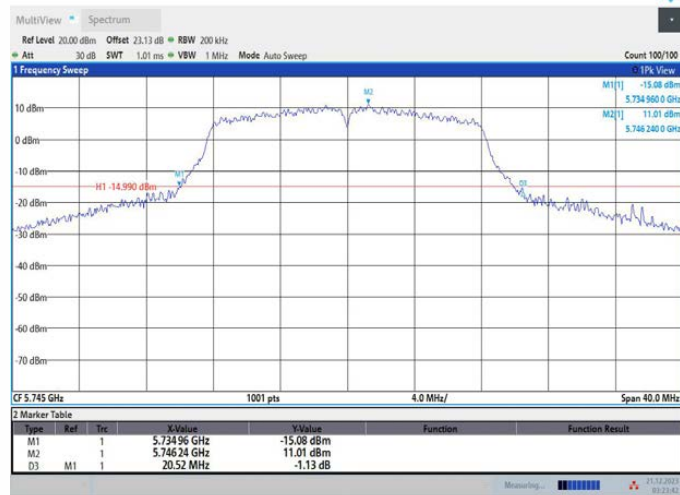

03:23:42 21.12.2023

11A_Ant4_5745

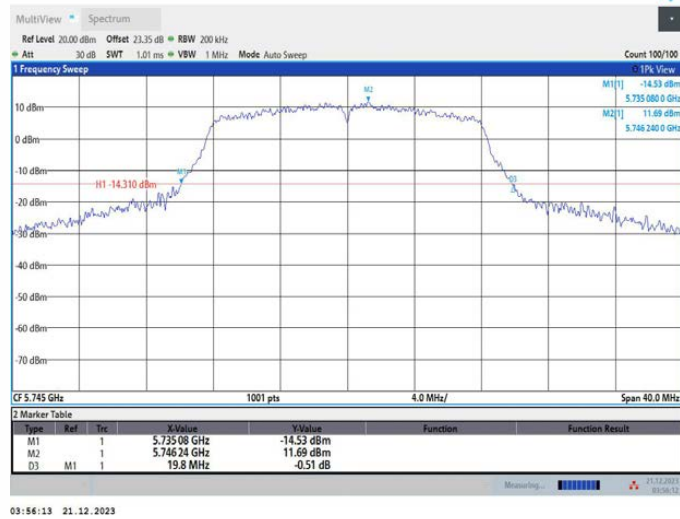

03:56:13 21.12.2023

11A_Ant1_5785

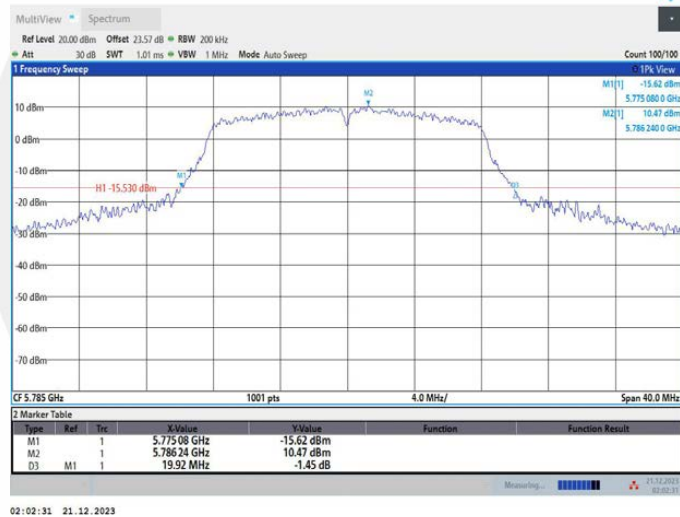

02:02:31 21.12.2023

11A_Ant2_5785

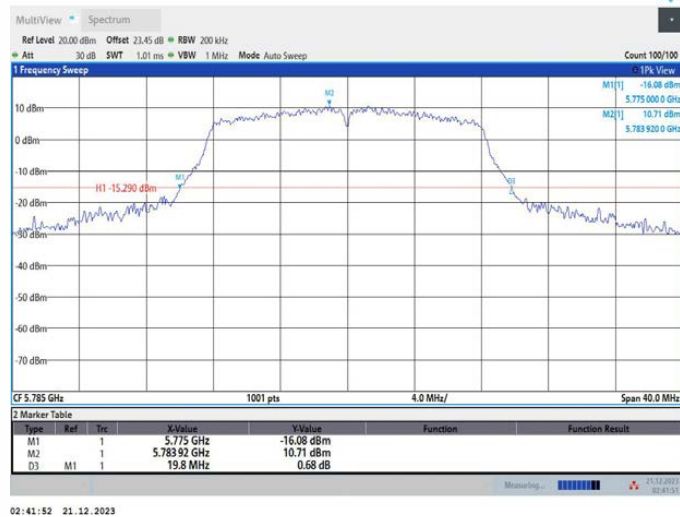

02:41:52 21.12.2023

11A_Ant3_5785

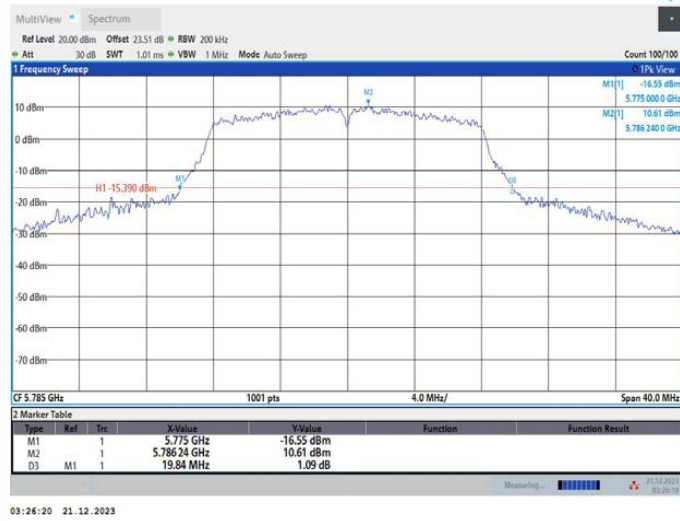

03:26:20 21.12.2023

11A_Ant4_5785

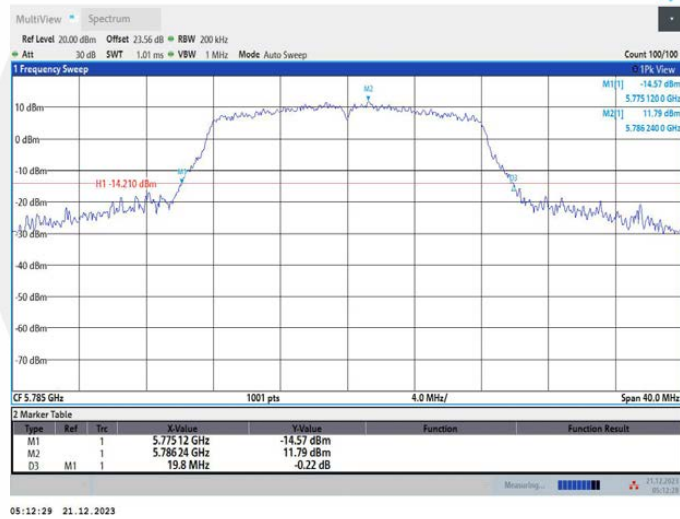

05:12:29 21.12.2023

11A_Ant1_5825

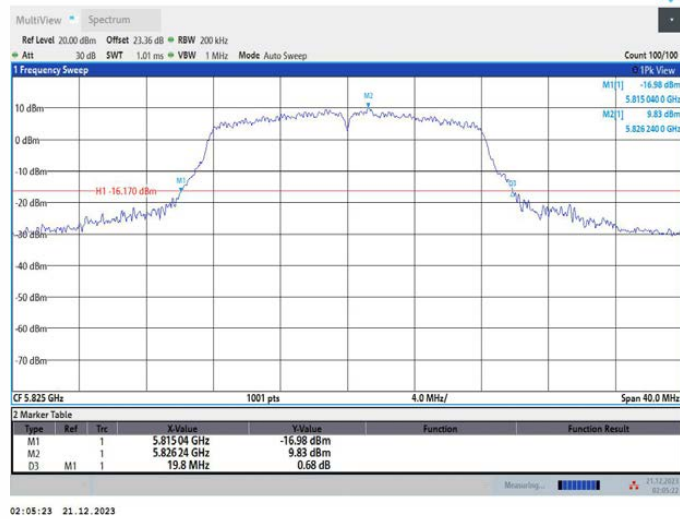

02:05:23 21.12.2023

11A_Ant2_5825

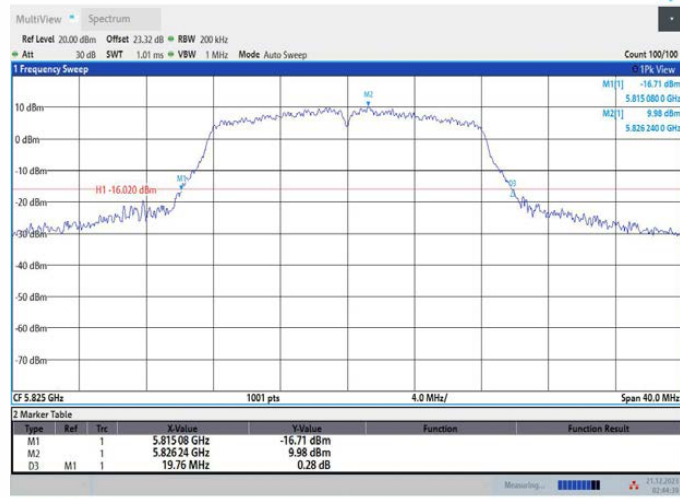

02:44:40 21.12.2023

11A_Ant3_5825



03:29:20 21.12.2023

11A_Ant4_5825



05:14:52 21.12.2023

11N20MIMO_Ant1_5180

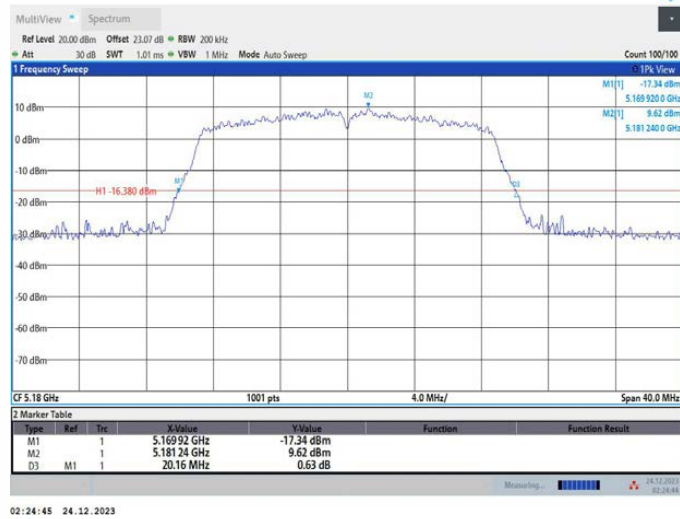

11N20MIMO_Ant2_5180

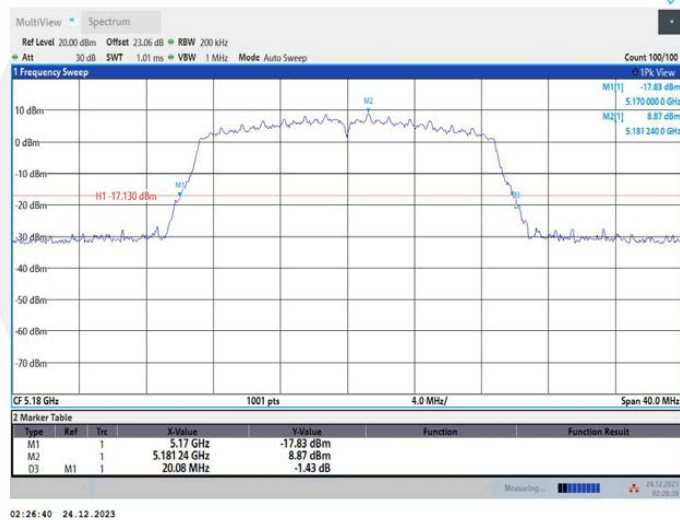

11N20MIMO_Ant3_5180

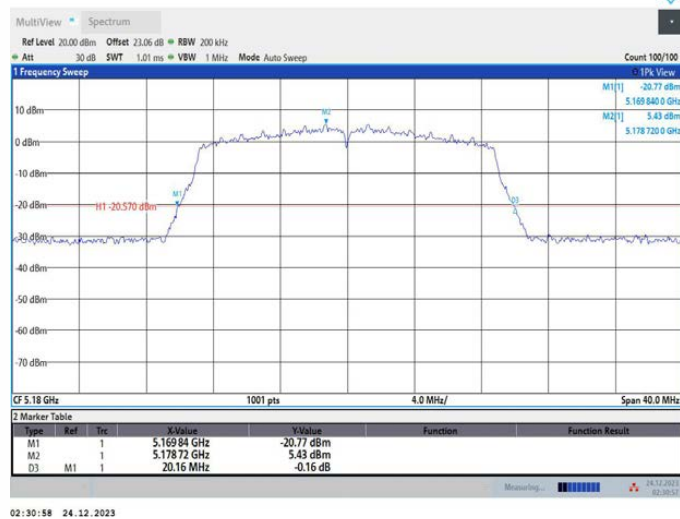

11N20MIMO_Ant4_5180

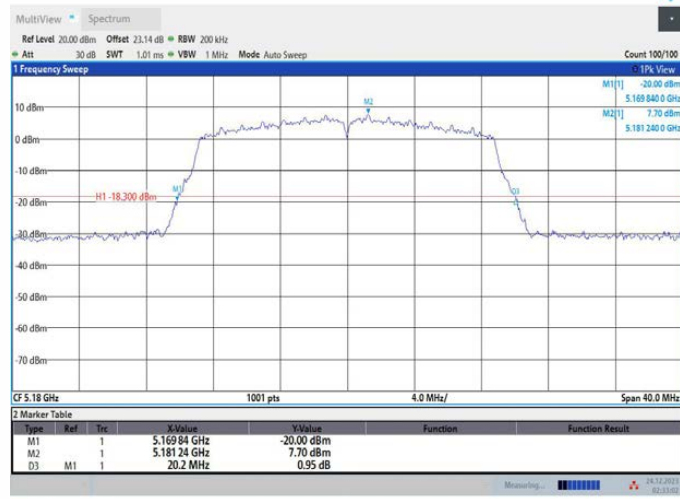

11N20MIMO_Ant1_5200



11N20MIMO_Ant2_5200



11N20MIMO_Ant3_5200

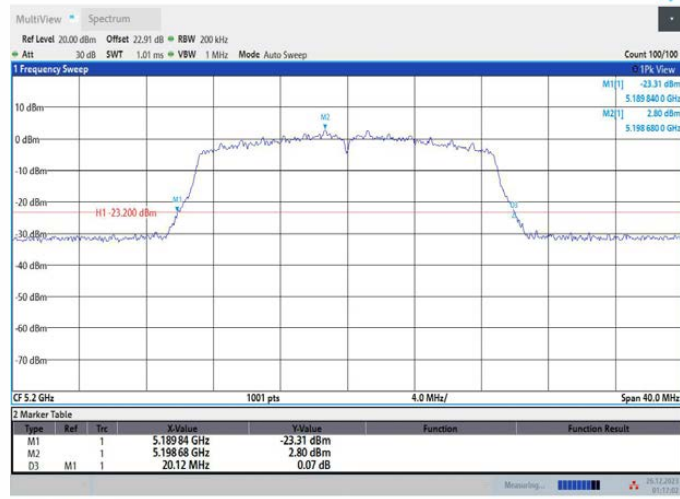

01:17:02 26.12.2023

11N20MIMO_Ant4_5200



06:39:12 26.12.2023

11N20MIMO_Ant1_5240



01:27:14 26.12.2023

11N20MIMO_Ant2_5240

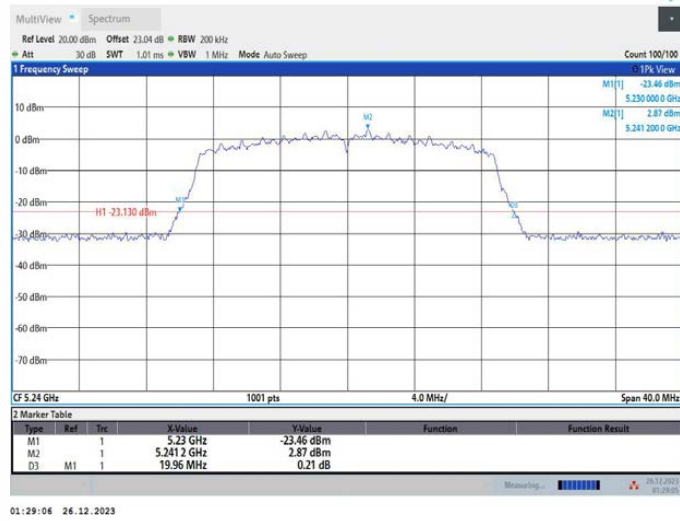

11N20MIMO_Ant3_5240

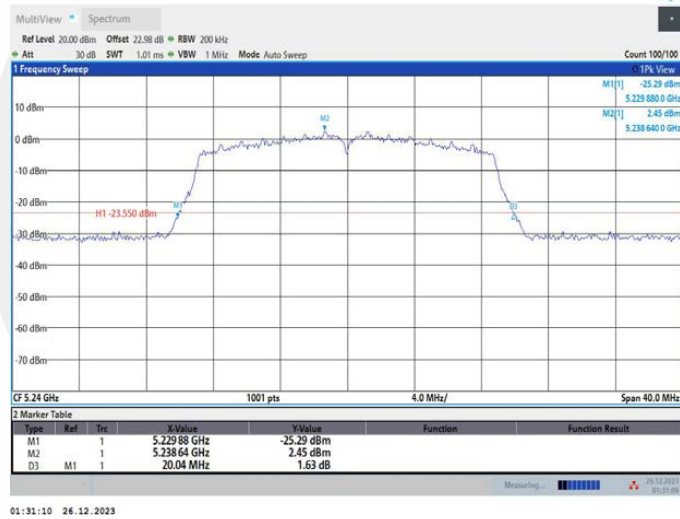

11N20MIMO_Ant4_5240

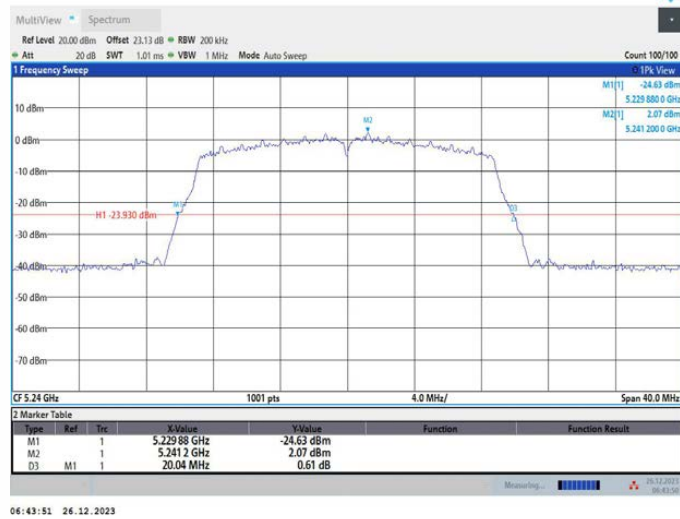

11N20MIMO_Ant1_5260

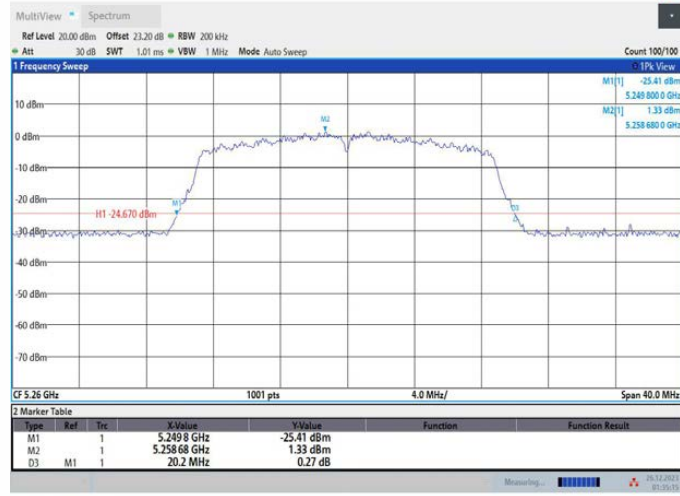

01:35:16 26.12.2023

11N20MIMO_Ant2_5260

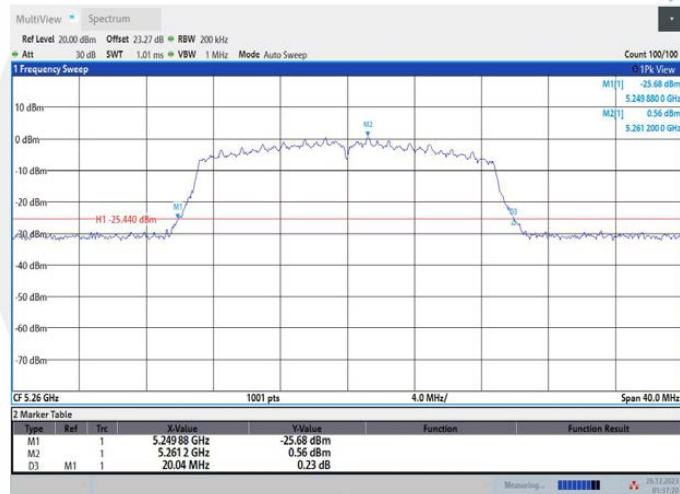

01:37:20 26.12.2023

11N20MIMO_Ant3_5260



01:39:21 26.12.2023

11N20MIMO_Ant4_5260

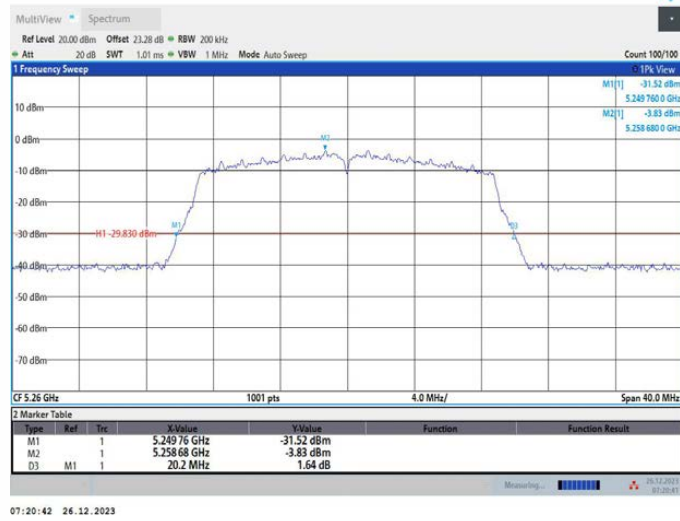

11N20MIMO_Ant1_5280

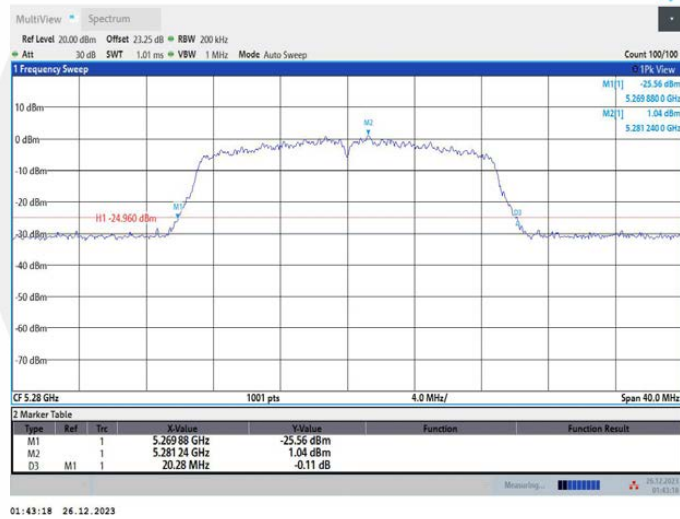

11N20MIMO_Ant2_5280

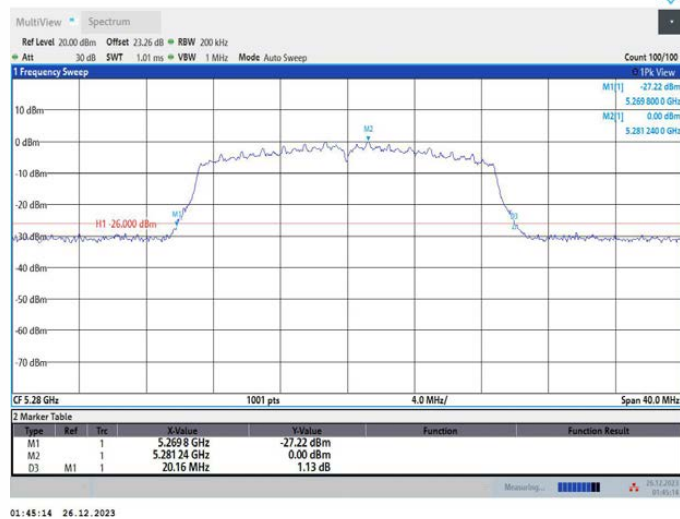

11N20MIMO_Ant3_5280

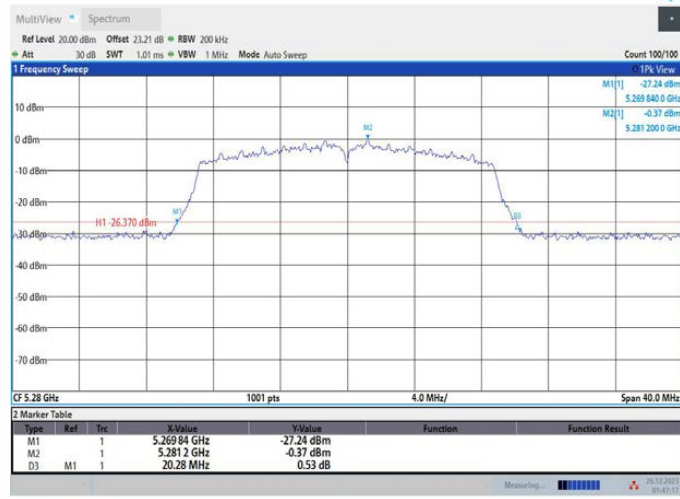

01:47:17 26.12.2023

11N20MIMO_Ant4_5280



07:29:06 26.12.2023

11N20MIMO_Ant1_5320

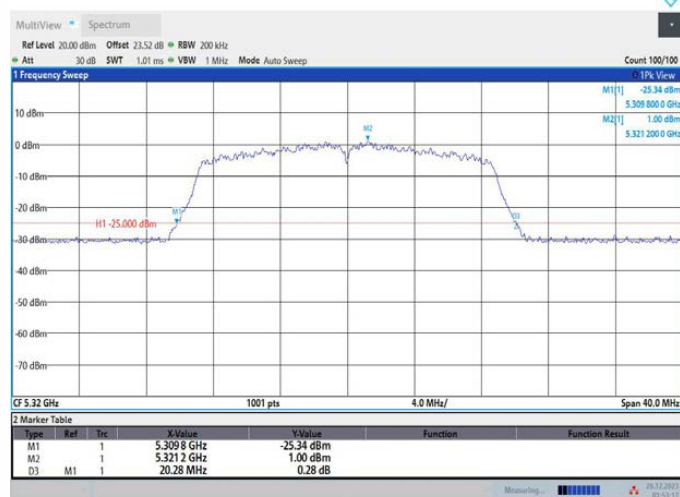

01:53:17 26.12.2023

11N20MIMO_Ant2_5320

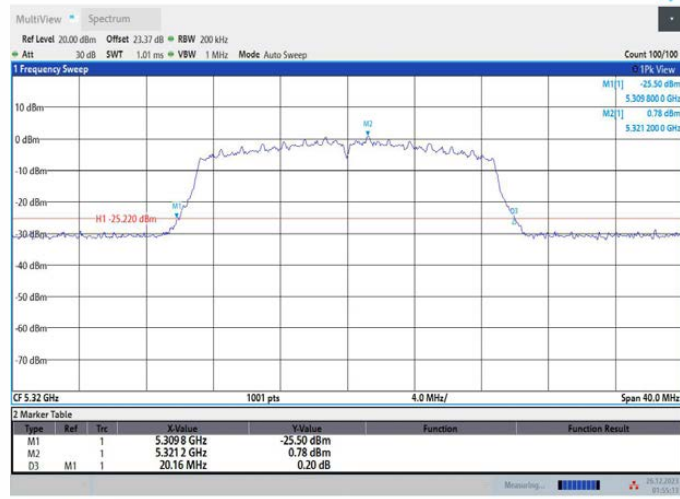

01:55:14 26.12.2023

11N20MIMO_Ant3_5320



01:57:17 26.12.2023

11N20MIMO_Ant4_5320



07:33:24 26.12.2023

11N20MIMO_Ant1_5500

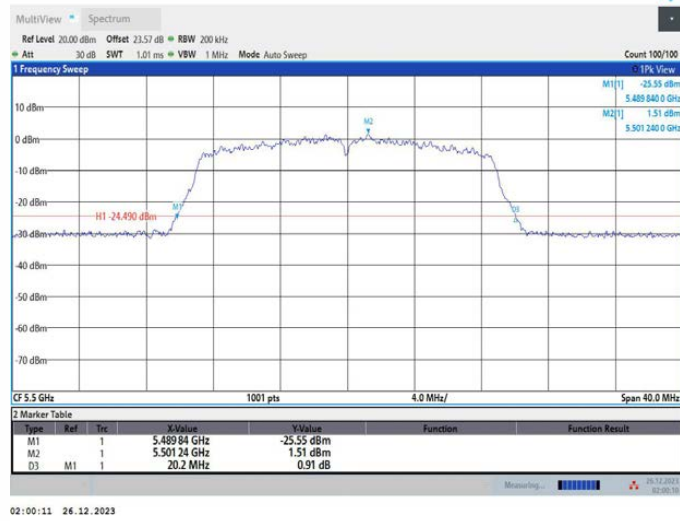

11N20MIMO_Ant2_5500

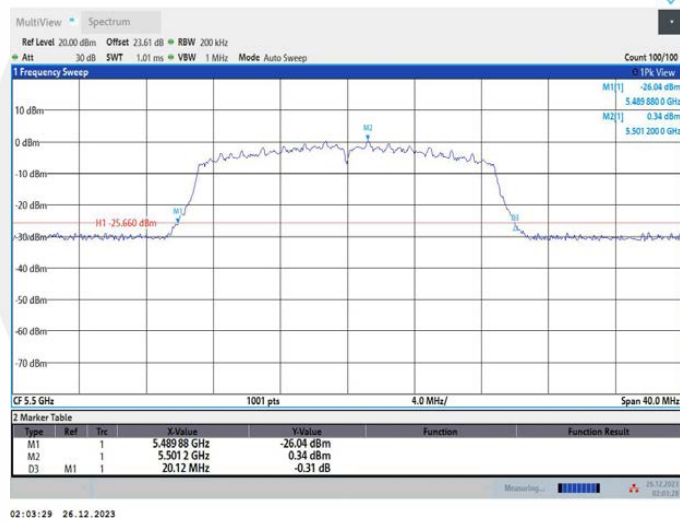

11N20MIMO_Ant3_5500

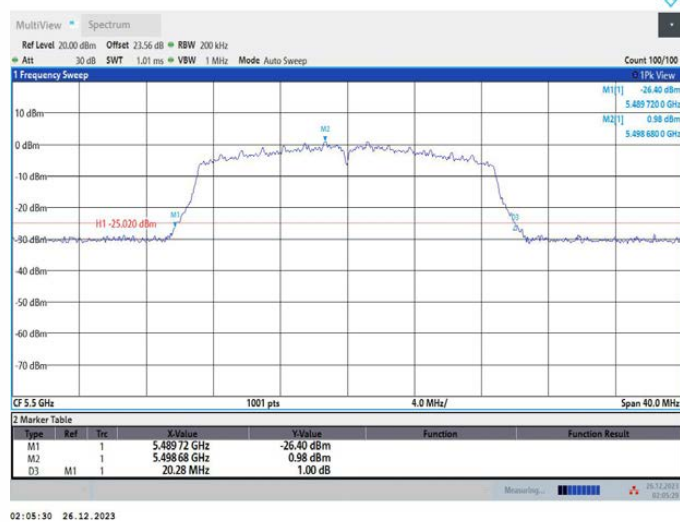

11N20MIMO_Ant4_5500

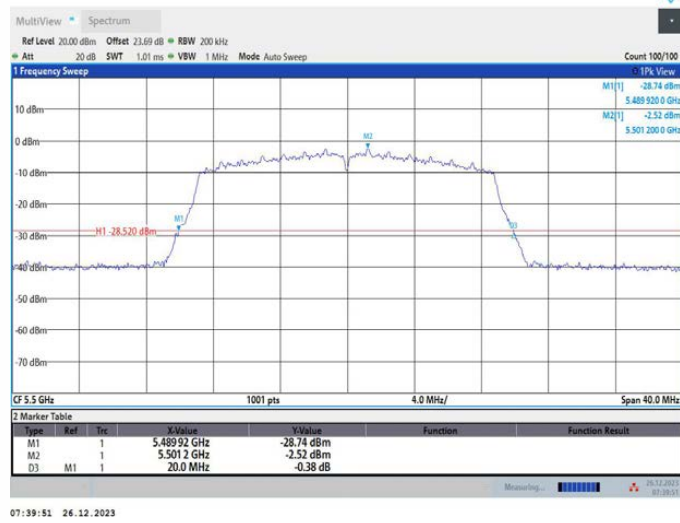

11N20MIMO_Ant1_5580

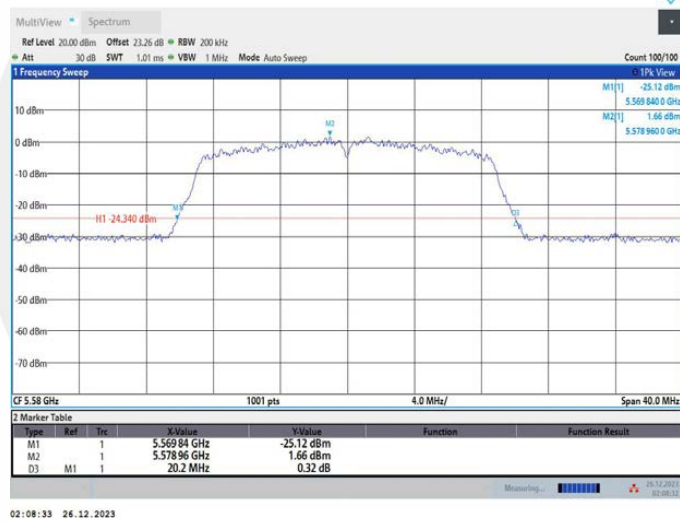

11N20MIMO_Ant2_5580

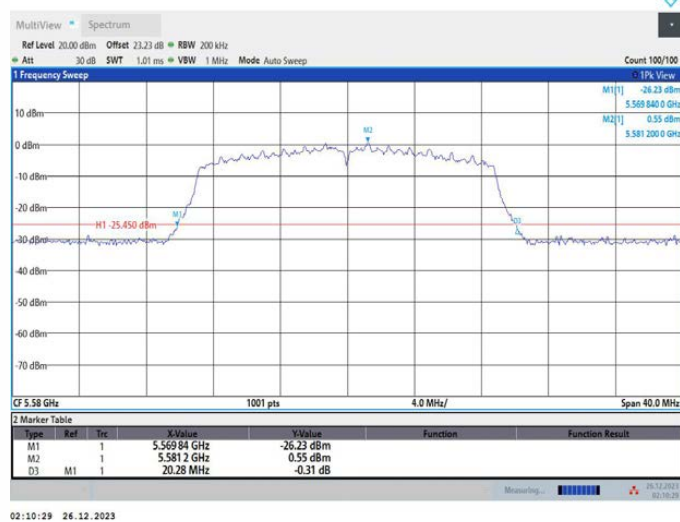

11N20MIMO_Ant3_5580



11N20MIMO_Ant4_5580

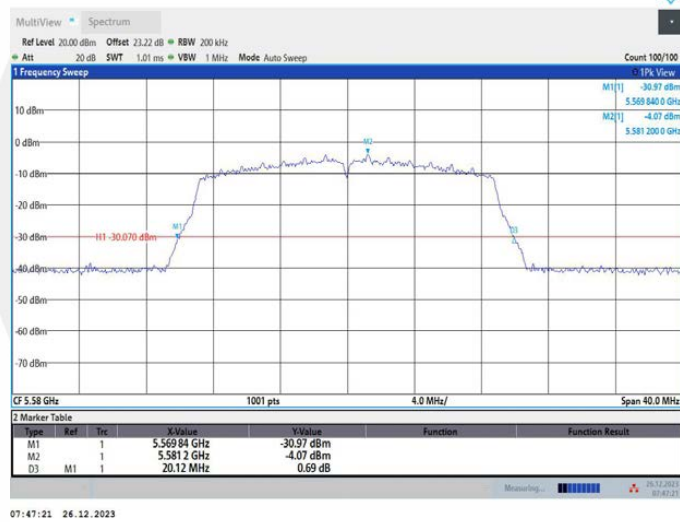

11N20MIMO_Ant1_5700

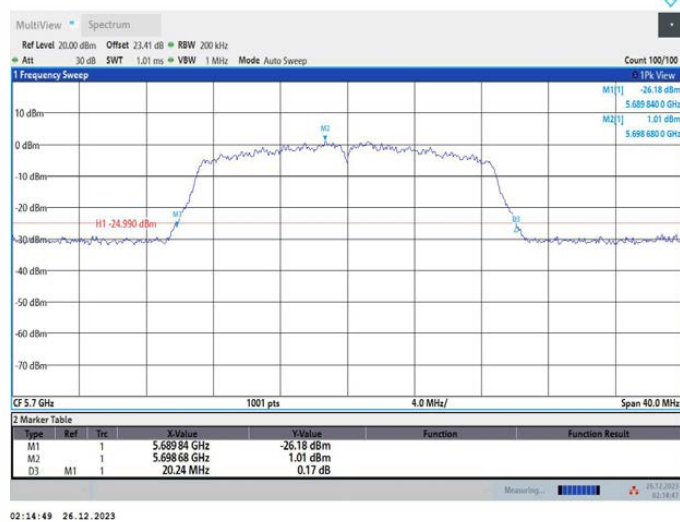

11N20MIMO_Ant2_5700

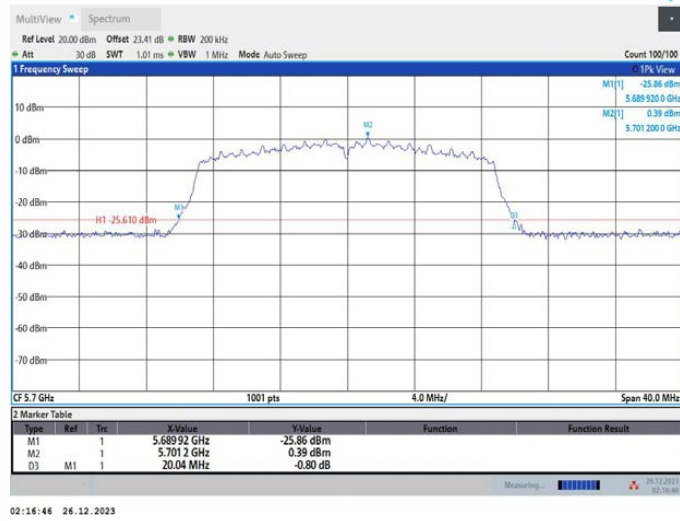

11N20MIMO_Ant3_5700

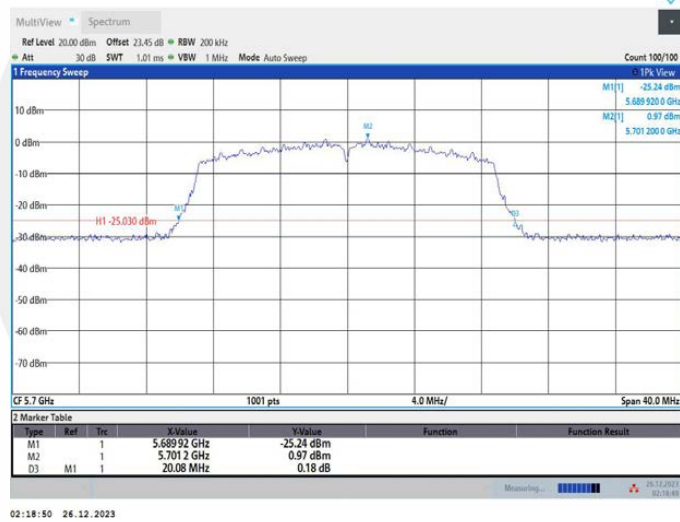

11N20MIMO_Ant4_5700

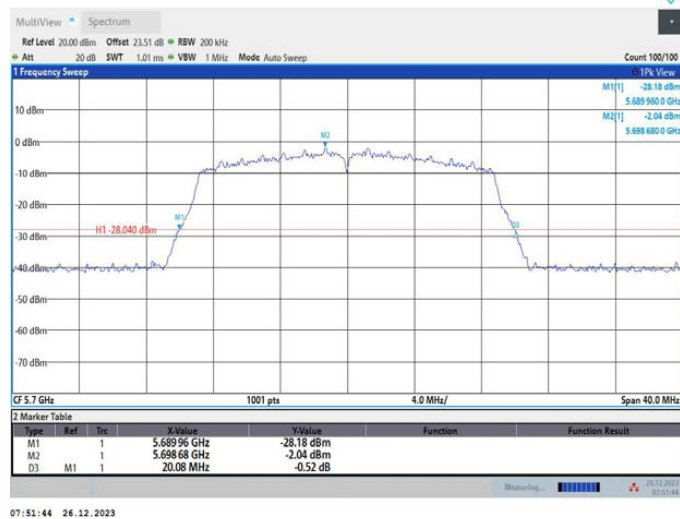

11N20MIMO_Ant1_5745

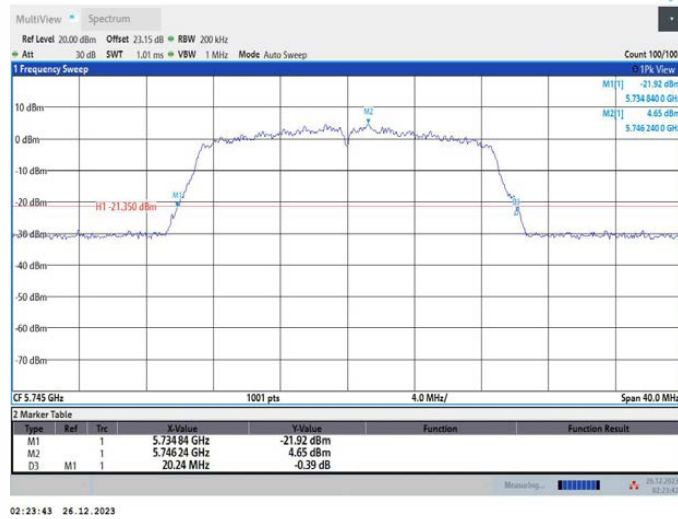

11N20MIMO_Ant2_5745

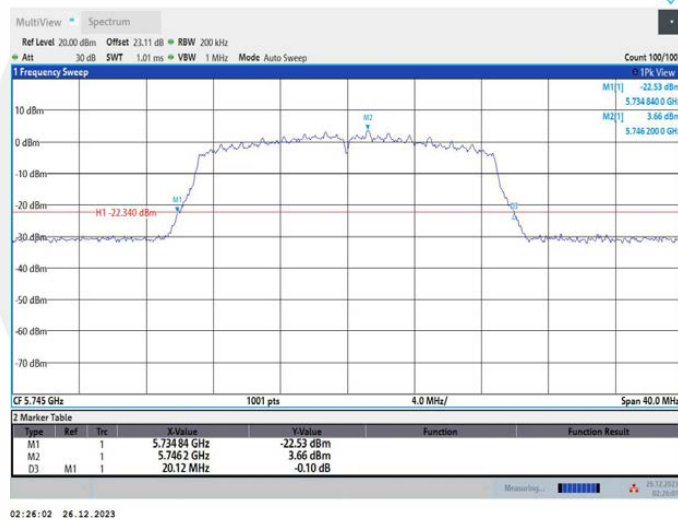

11N20MIMO_Ant3_5745

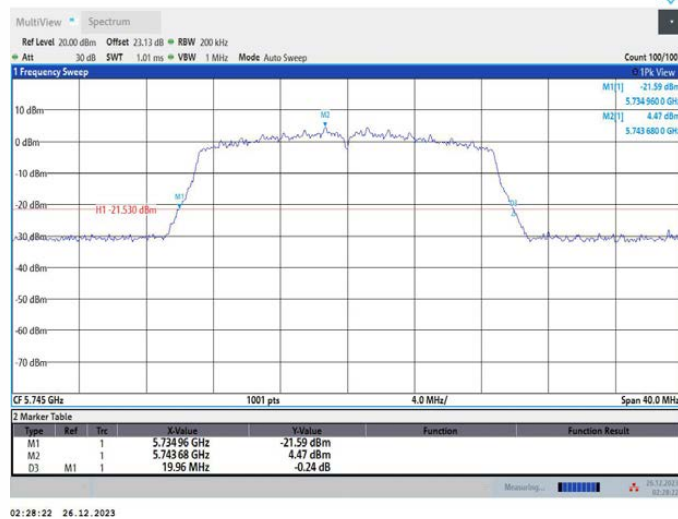

11N20MIMO_Ant4_5745

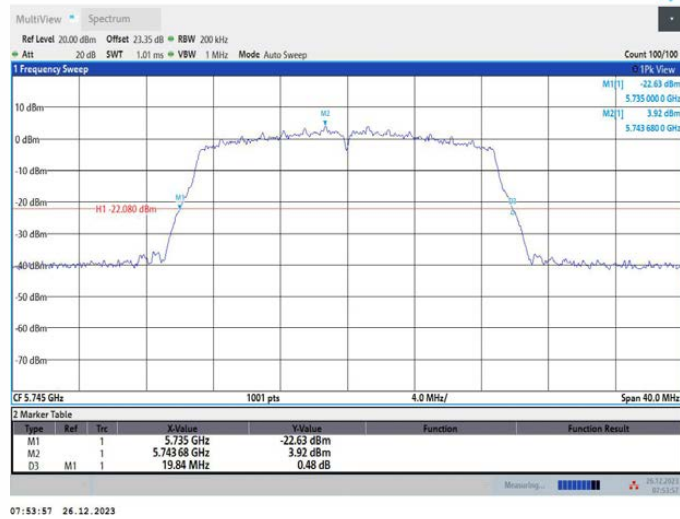

11N20MIMO_Ant1_5785

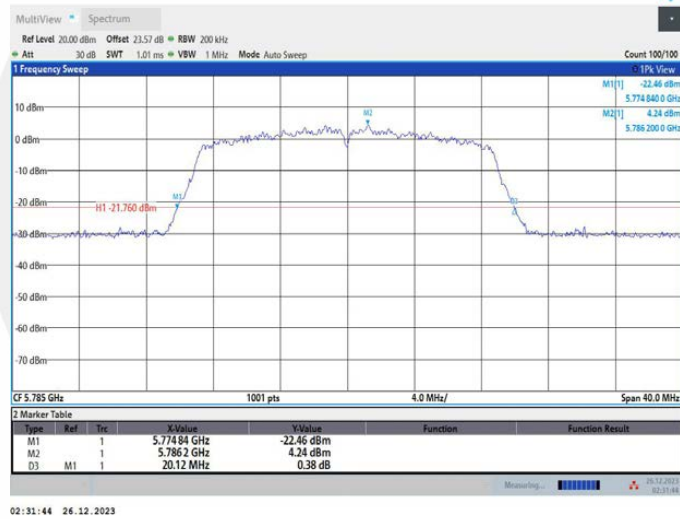

11N20MIMO_Ant2_5785

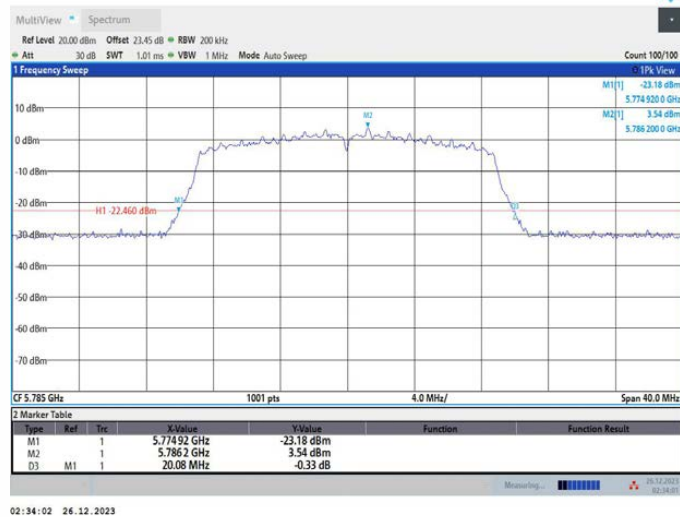

11N20MIMO_Ant3_5785



11N20MIMO_Ant4_5785

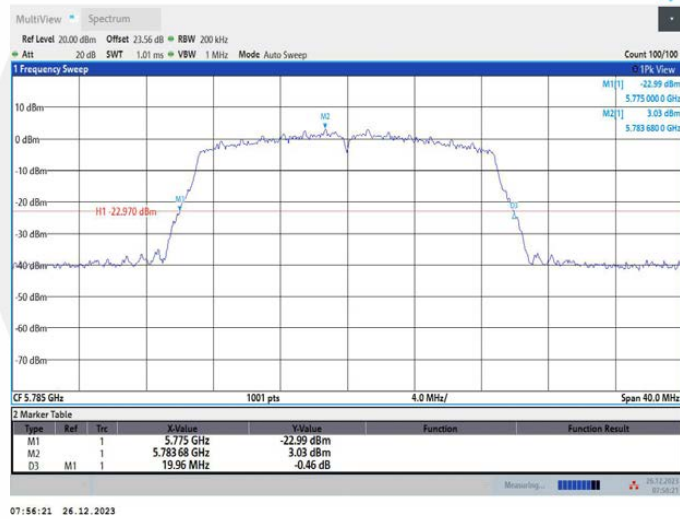

11N20MIMO_Ant1_5825

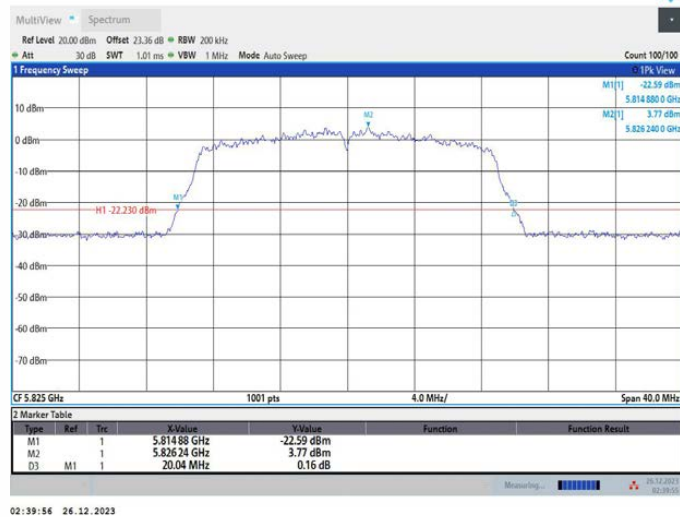

11N20MIMO_Ant2_5825

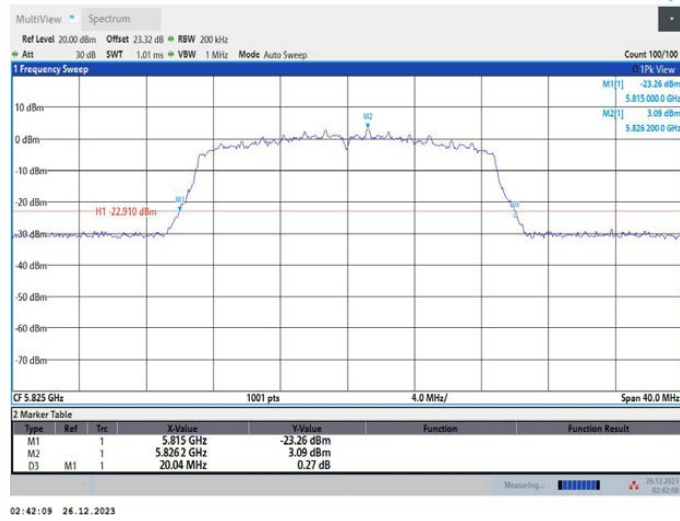

02:42:09 26.12.2023

11N20MIMO_Ant3_5825

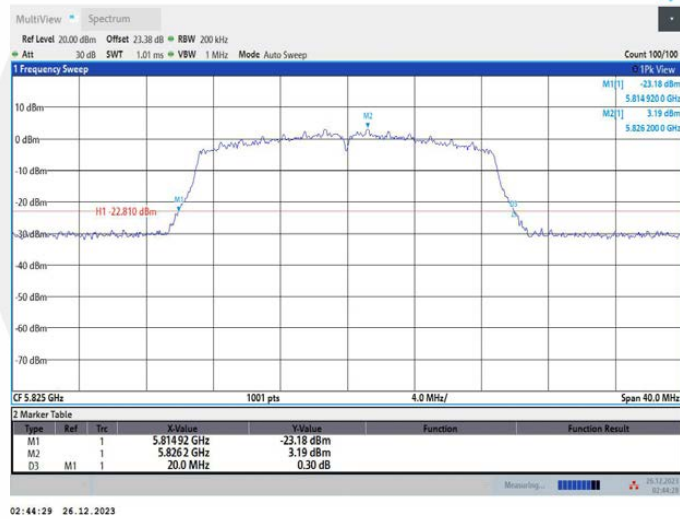

02:44:29 26.12.2023

11N20MIMO_Ant4_5825

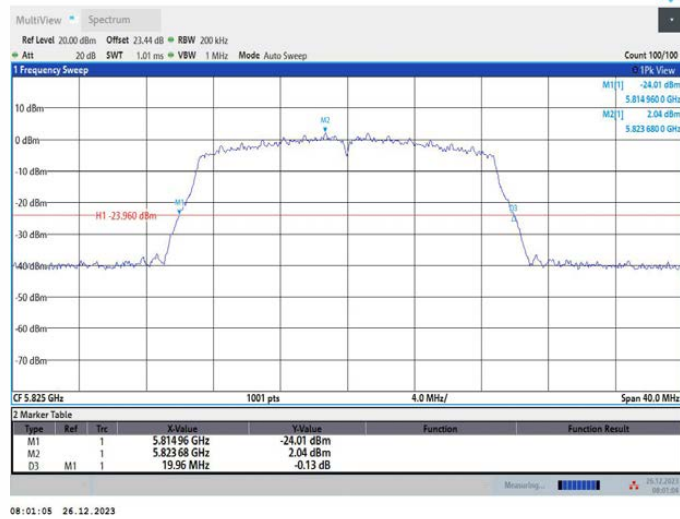

08:01:06 26.12.2023

11N40MIMO_Ant1_5190

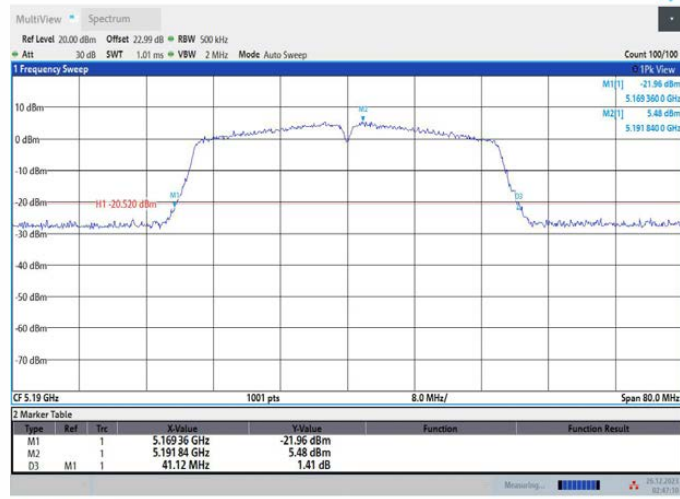

02:47:11 26.12.2023

11N40MIMO_Ant2_5190



02:50:22 26.12.2023

11N40MIMO_Ant3_5190

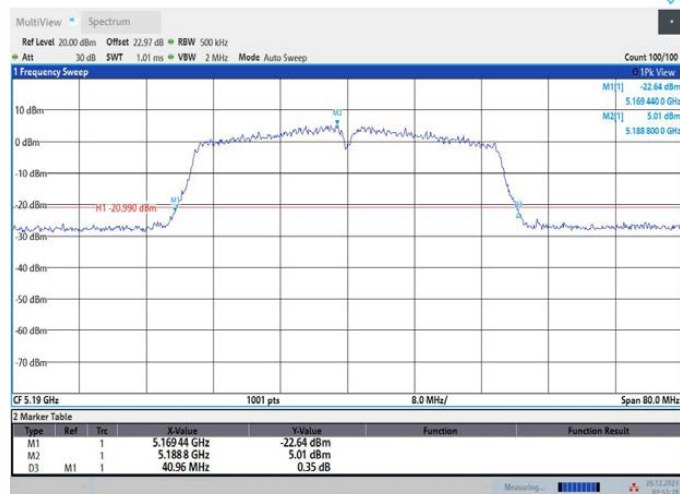

02:53:29 26.12.2023

11N40MIMO_Ant4_5190

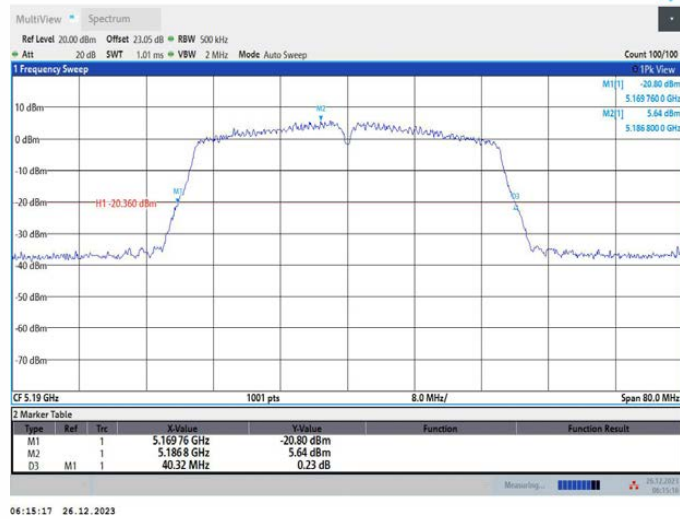

11N40MIMO_Ant1_5230

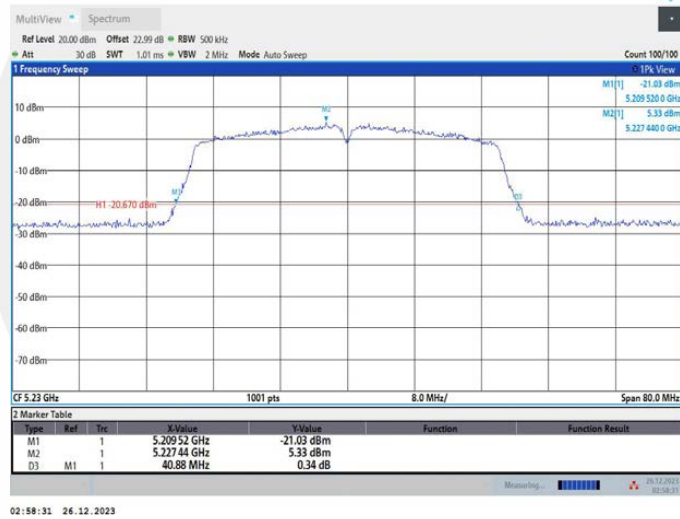

11N40MIMO_Ant2_5230

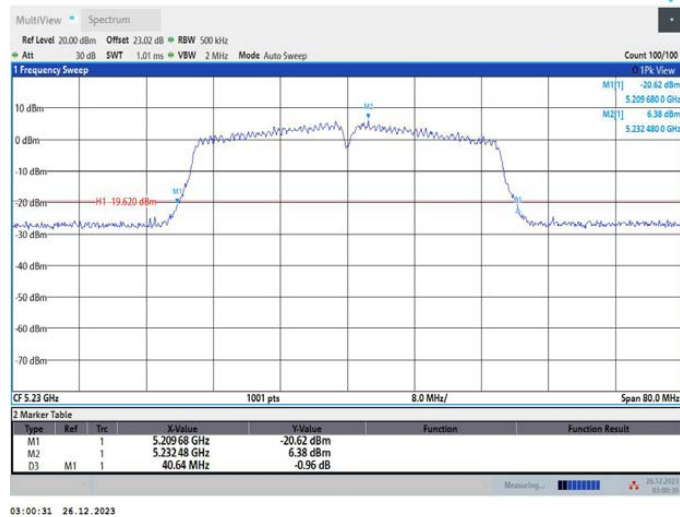

11N40MIMO_Ant3_5230

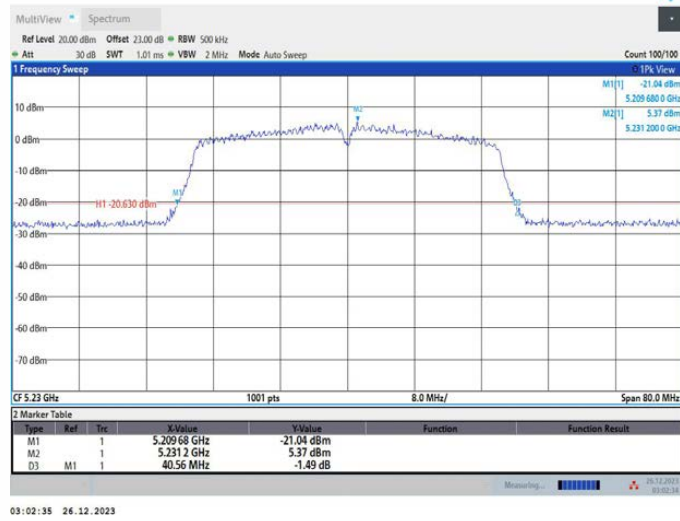

11N40MIMO_Ant4_5230

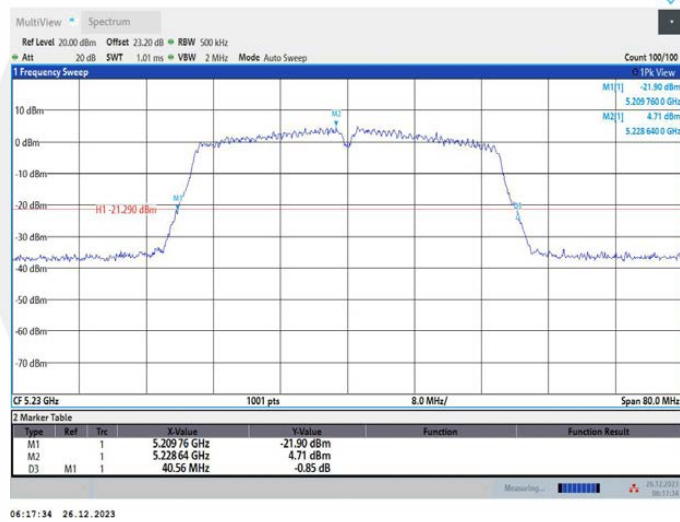

11N40MIMO_Ant1_5270



11N40MIMO_Ant2_5270

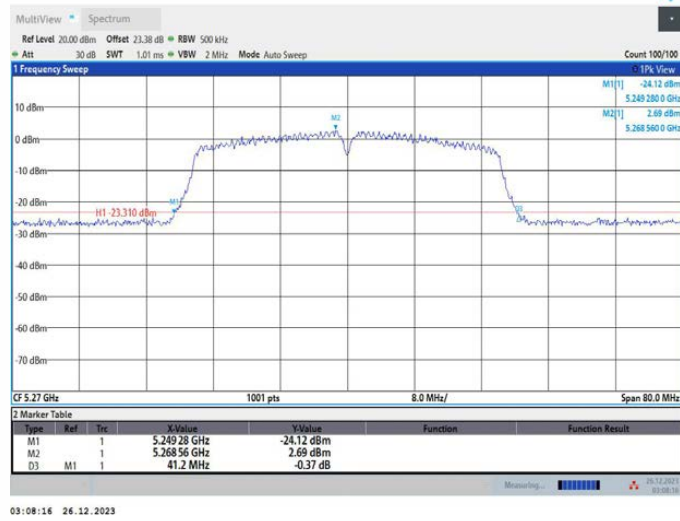

11N40MIMO_Ant3_5270

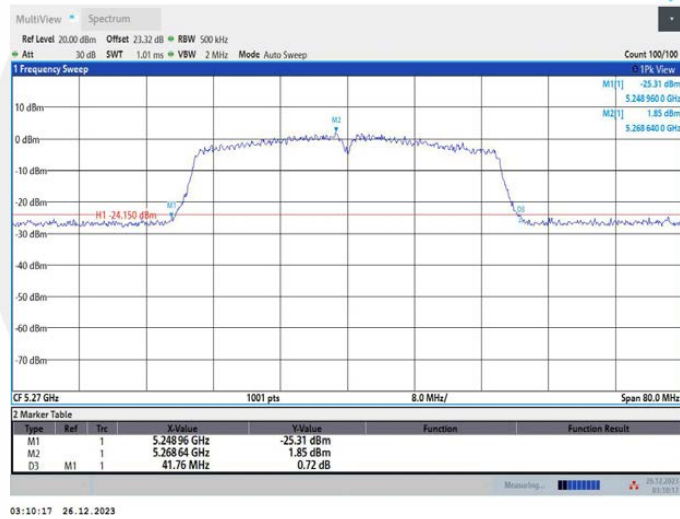

11N40MIMO_Ant4_5270

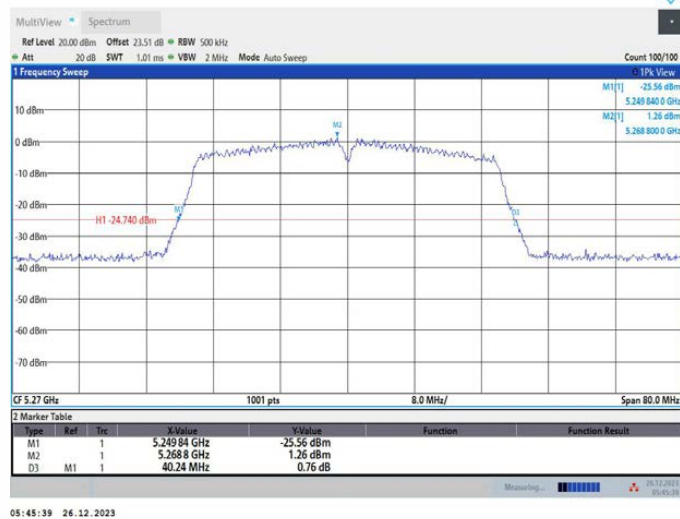

11N40MIMO_Ant1_5310

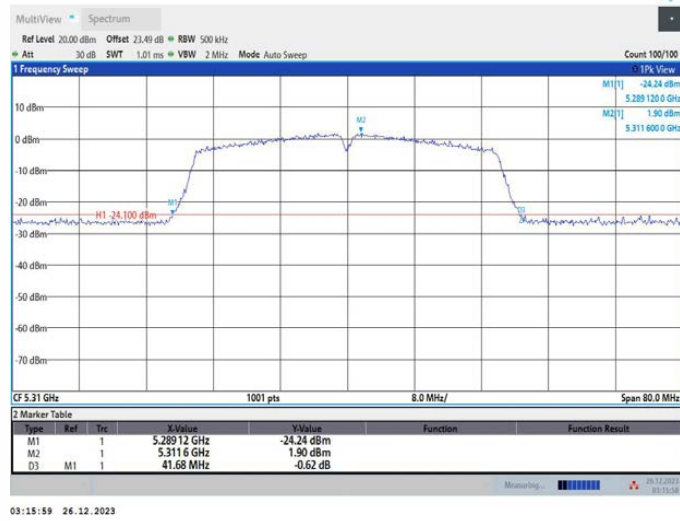

11N40MIMO_Ant2_5310

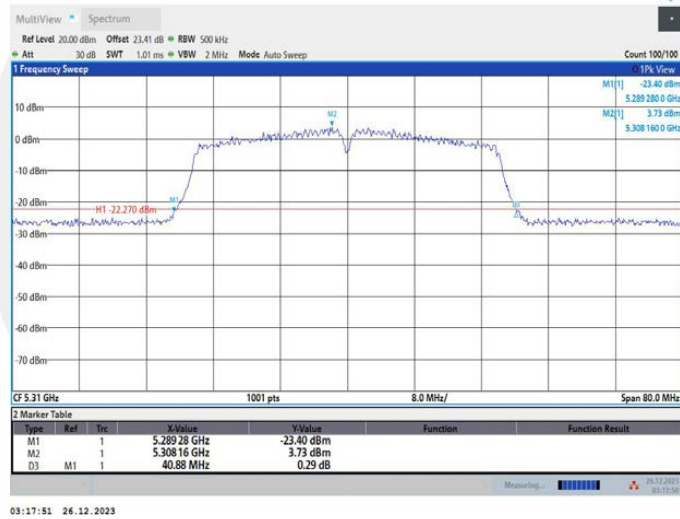

11N40MIMO_Ant3_5310

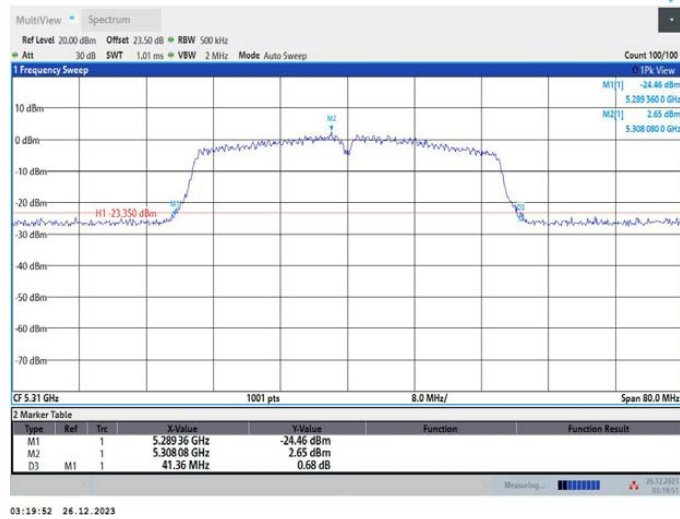

11N40MIMO_Ant4_5310

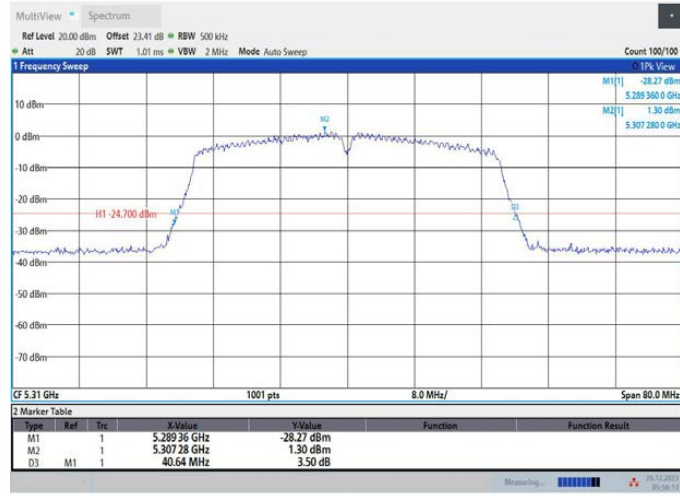

11N40MIMO_Ant1_5510

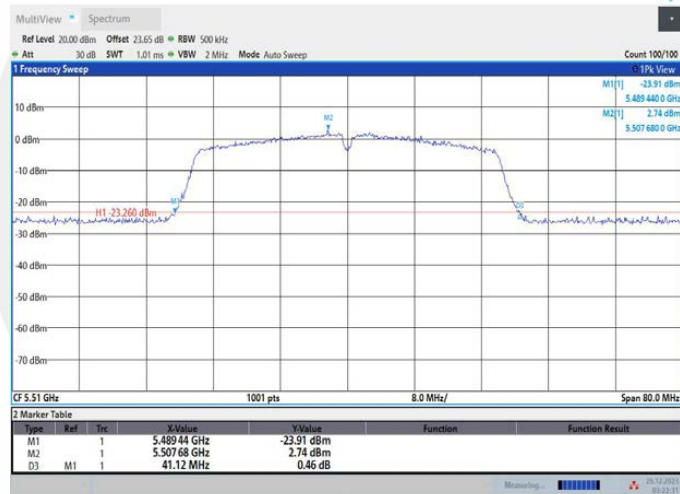

11N40MIMO_Ant2_5510



11N40MIMO_Ant3_5510

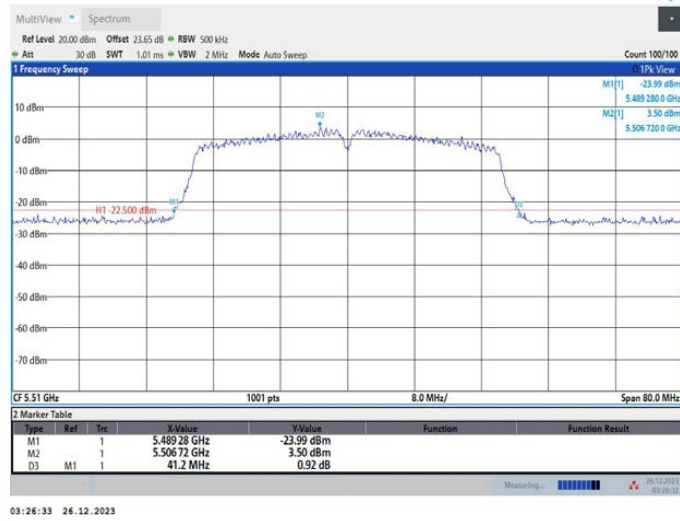

11N40MIMO_Ant4_5510

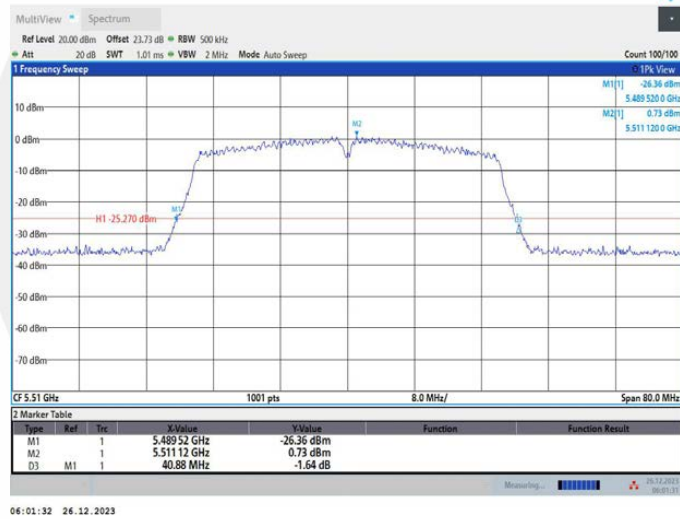

11N40MIMO_Ant1_5550



11N40MIMO_Ant2_5550

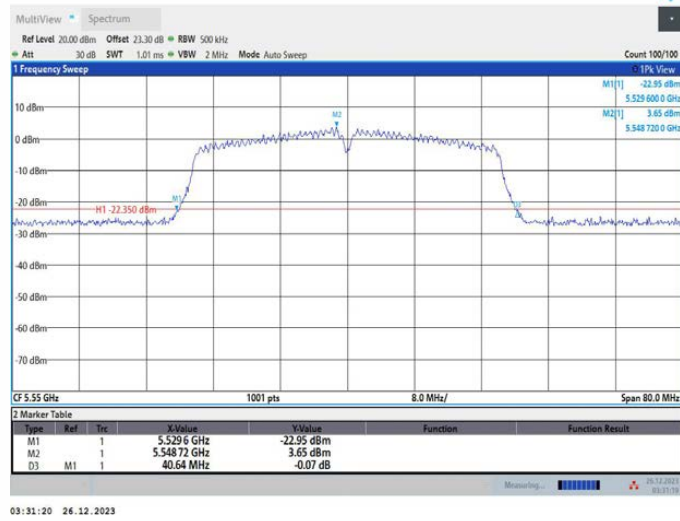

11N40MIMO_Ant3_5550

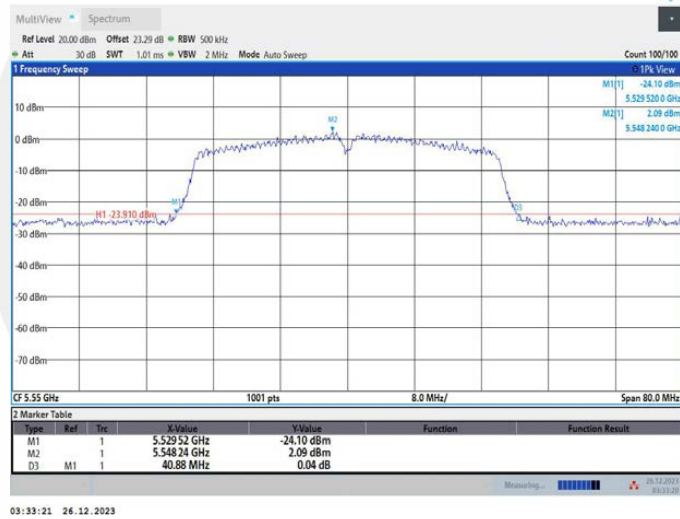

11N40MIMO_Ant4_5550

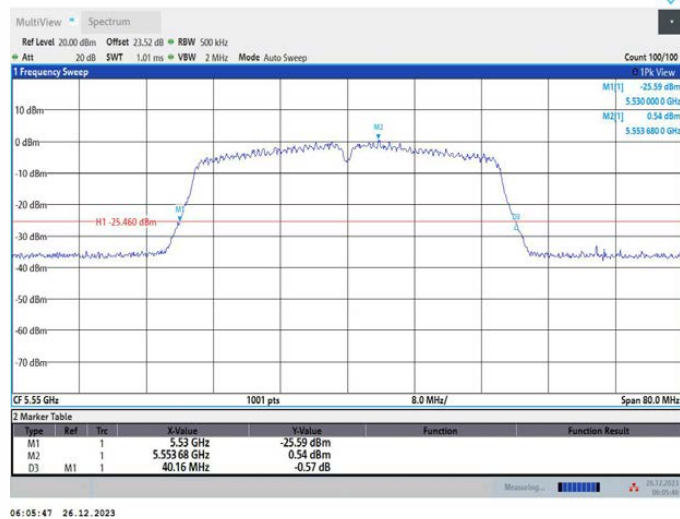

11N40MIMO_Ant1_5670

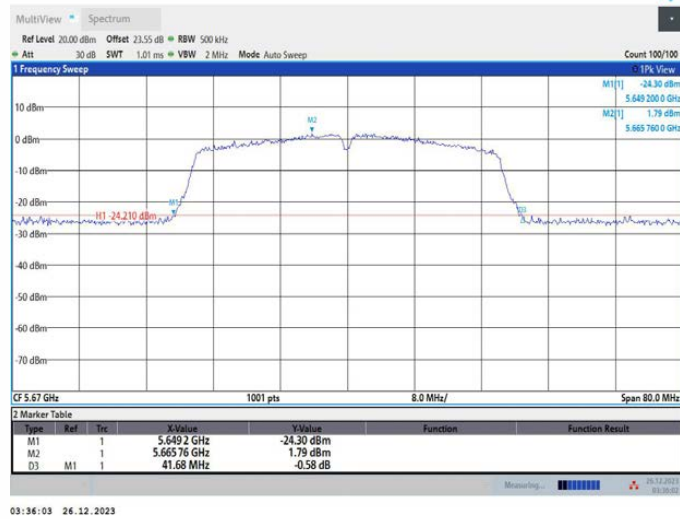

11N40MIMO_Ant2_5670

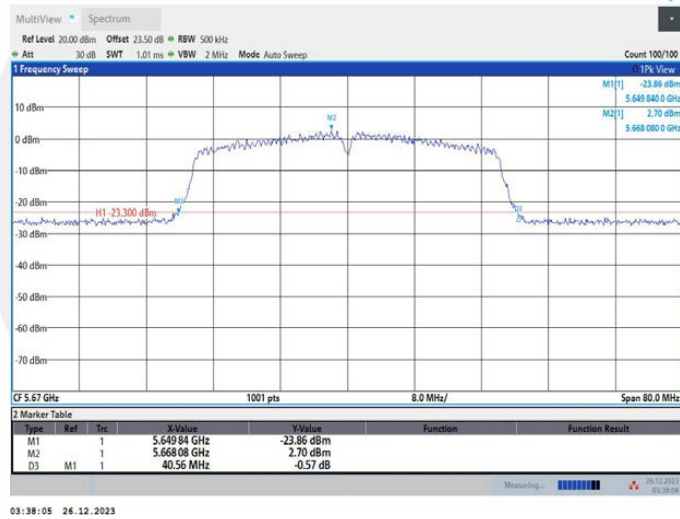

11N40MIMO_Ant3_5670

