

TEST REPORT

Product Name : **Wireless Bridge**
Model Number : **RG-AirMetro550G-B**
FCC ID : **2AX5J-AM550GB**

Prepared for : Ruijie Networks Co., Ltd.
Address : Building 19, Juyuanzhou Industrial Park, No.618 Jinshan Road, Cangshan District, Fuzhou, Fujian, China

Prepared by : EMTEK (SHENZHEN) CO., LTD.
Address : Building 69, Majialong Industry Zone, Nanshan District, Shenzhen, Guangdong, China

Tel: (0755) 26954280
Fax: (0755) 26954282

Report Number : ENS2406250044W00103R
Date(s) of Tests : September 9, 2024 to October 10, 2024
Date of Issue : October 12, 2024

TABLE OF CONTENTS

1 EUT DESCRIPTION.....	5
2 SUMMARY OF TEST RESULT.....	7
3 TEST METHODOLOGY.....	8
1.1 GENERAL DESCRIPTION OF APPLIED STANDARDS.....	8
3.1 MEASUREMENT EQUIPMENT USED.....	8
3.2 DESCRIPTION OF TEST MODES.....	9
4 FACILITIES AND ACCREDITATIONS.....	12
4.1 EQUIPMENT.....	12
4.2 DESCRIPTION OF TEST FACILITY.....	12
5 SETUP OF EQUIPMENT UNDER TEST.....	13
5.1 SETUP CONFIGURATION OF EUT.....	13
5.2 CALIBRATION OF DFS DETECTION THRESHOLD LEVEL.....	13
5.3 SUPPORT EQUIPMENT.....	14
6 DYNAMIC FREQUENCY SELECTION REQUIREMENTS.....	15
6.1 APPLICABLE STANDARD.....	15
6.2 CONFORMANCE LIMIT.....	15
6.3 TEST CONFIGURATION.....	15
6.4 TEST PARAMETERS OF DFS TEST SIGNAL.....	16
6.5 OPERATION MODES AND REQUIREMENT TEST ITEMS.....	53
6.6 TEST PROCEDURE.....	53
7 TEST RESULT.....	54
7.1 DFS DETECTION THRESHOLD.....	54
7.2 CHANNEL AVAILABILITY CHECK TIME.....	69
7.3 NON- OCCUPANCY PERIOD.....	86
7.4 UNIFORM SPREADING.....	87
7.5 U-NII DETECTION BANDWIDTH.....	88

Modified Information

Version	Report No.	Revision Date	Summary
Ver.1.0	ENS2406250044W00103R	/	Original Report

TEST RESULT CERTIFICATION

Applicant: : Ruijie Networks Co., Ltd.
 Address: Building 19, Juyuanzhou Industrial Park, No.618 Jinshan Road, Cangshan District, Fuzhou, Fujian, China
 Manufacturer: : Ruijie Networks Co., Ltd.
 Address: Building 19, Juyuanzhou Industrial Park, No.618 Jinshan Road, Cangshan District, Fuzhou, Fujian, China
 EUT: : Wireless Bridge
 Model Name: : RG-AirMetro550G-B
 Trademark: :   REYEE REYEE REYEE

Measurement Procedure Used:

APPLICABLE STANDARDS	
STANDARD	TEST RESULT
FCC 47 CFR Part 2, Subpart J FCC 47 CFR Part 15, Subpart E	PASS

The above equipment was tested by EMTEK (SHENZHEN) CO., LTD. The test data, data evaluation, test procedures, and equipment configurations shown in this report were made in accordance with the procedures given in ANSI C63.10 (2013) and the energy emitted by the sample EUT tested as described in this report is in compliance with the above table standards requirement.

The test results of this report relate only to the tested sample identified in this report.

Date of Test : September 9, 2024 to October 10, 2024

Prepared by : 
 Una Yu/Editor

Reviewer : 
 Joe Xia/Supervisor

Approved & Authorized Signer : 
 Lisa Wang/Manager



1 EUT DESCRIPTION

Product Name:	Wireless Bridge
Model Number:	RG-AirMetro550G-B
WIFI Type:	UNII-2A: With 5250MHz-5350MHz Band UNII-2C: With 5470MHz-5725MHz Band
WLAN Supported:	IEEE 802.11a IEEE 802.11n(20MHz channel bandwidth) IEEE 802.11n(40MHz channel bandwidth) IEEE 802.11ac(20MHz channel bandwidth) IEEE 802.11ac(40MHz channel bandwidth) IEEE 802.11ac(80MHz channel bandwidth)
Frequency Range:	5250MHz-5350MHz Band: 5260-5320MHz for 802.11a 5260-5320MHz for 802.11n(20) 5270-5310MHz for 802.11n(40) 5260-5320MHz for 802.11ac(20) 5270-5310MHz for 802.11ac(40) 5290MHz for 802.11ac(80)
	5470MHz-5725MHz Band: 5500-5700MHz for 802.11a 5500-5700MHz for 802.11n(20) 5510-5670MHz for 802.11n(40) 5500-5700MHz for 802.11ac(20) 5510-5670MHz for 802.11ac(40) 5530-5610MHz for 802.11ac(80)
Modulation:	OFDM
TCP Function:	Support
Beamforming:	Not Support
DFS Function:	Master
Antenna Type:	External Antenna
Antenna Gain:	RG-ANT20S-90 Antenna: B1: 5150-5250MHz: Ant1: 17.78dBi, Ant2: 17.31dBi B2: 5250-5350MHz: Ant1: 18.02dBi, Ant2: 17.57dBi B3: 5470-5725MHz: Ant1: 18.77dBi, Ant2: 18.25dBi B4: 5725-5850MHz: Ant1: 18.98dBi, Ant2: 18.31dBi RG-ANT13-360 Antenna: B1: 5150-5250MHz: Ant1: 11.96dBi, Ant2: 10.44dBi B2: 5250-5350MHz: Ant1: 11.96dBi, Ant2: 10.42dBi B3: 5470-5725MHz: Ant1: 12.07dBi, Ant2: 10.79dBi B4: 5725-5850MHz: Ant1: 12.22dBi, Ant2: 10.89dBi (Note1: The EUT has two 5G WIFI antennas, RG-ANT20S-90 and RG-ANT13-360 antenna, Pre testing all antennas, and find the RG-ANT20S-90 antenna is the worst, so only the worst data is shown in the report.) (Note2: The antenna information is provided by the customers, which will have a certain impact on the test results.)

Smart System:	MIMO
Power Supply:	DC:12.0Vdc 1.0A or POE: 24Vdc 0.5A POE Information: Model: RP023-2400500ZG Input: 100-240V~50/60Hz, 0.5A Max Output: 24V, 0.5A, 12W (Note: The EUT has two power supplies, Pre testing all power supplies, and find the POE is the worst, so only the worst data is shown in the report.)
Temperature Range:	-40°C~80°C (Note: When a power adapter is used, the maximum operating temperature for both the device and the power adapter is 60°C (140° F).)

Note: for more details, please refer to the user's manual of the EUT.



2 SUMMARY OF TEST RESULT

Clause	MODES	Test Parameter	Verdict	Remark
15.407	<input checked="" type="checkbox"/> Master	DFS Detection Threshold	PASS	Applicable
15.407		Channel Availability Check Time	PASS	Applicable
15.407		Channel Move Time	PASS	Applicable
15.407		Channel Closing Transmission Time	PASS	Applicable
15.407		Non-Occupancy Period	PASS	Applicable
15.407		Uniform Spreading	PASS	Applicable
15.407		U-NII Detection Bandwidth	PASS	Applicable
15.407	<input type="checkbox"/> Slave	Radar Detection Threshold	N/A	N/A
15.407		Channel Move Time	N/A	N/A
15.407		Channel Closing Transmission Time	N/A	N/A
15.407		Non-Occupancy Period	N/A	N/A
15.407		U-NII Detection Bandwidth	N/A	N/A

NOTE 1: N/A is an abbreviation for not applicable.
 NOTE 2: The results of this report do not take into account the uncertainty.

3 TEST METHODOLOGY

1.1 GENERAL DESCRIPTION OF APPLIED STANDARDS

According to its specifications, the EUT must comply with the requirements of the following standards:

FCC 06-96

FCC 47 CFR Parts 15, Subpart E

FCC KDB 905462 D02 UNII DFS Compliance Procedures New Rules v02

3.1 MEASUREMENT EQUIPMENT USED

Equipment	Manufacturer	Model No.	Serial No.	Last Cal.	Cal. Interval
Wideband Radio Communication Tester	R&S	CMW500	171168	2024/9/18	1Year
Frequency Extender	R&S	CMW-Z800A	100430	2024/9/18	1Year
Spectrum Analyzer	R&S	FSV3044	101289	2024/9/18	1Year
Analog Signal Generator	R&S	SMB100A	183237	2024/9/18	1Year
Vector Signal Generator	R&S	SMM100A	101808	2024/9/18	1Year
RF Control Unit(Power Meter)	Tonscend	JS0806-2	22C8060567	2024/9/18	1Year
Temperature&Humidity Chamber	ESPEC	EL-02KA	12107166	2024/5/10	1 Year
DC Power Supply	KEYSIGHT	E3642A	MY53030016	2024/9/18	1 Year

3.2 DESCRIPTION OF TEST MODES

The EUT has been tested under its typical operating condition.

The EUT configuration for testing is installed on RF field strength measurement to meet the Commissions requirement and operating in a manner which intends to maximize its emission characteristics in a continuous normal application.

The Transmitter was operated in the normal operating mode. The TX frequency was fixed which was for the purpose of the measurements.

Test of channel included the lowest and middle and highest frequency to perform the test, then record on this report.

Pre-defined engineering program for regulatory testing used to control the EUT for staying in continuous transmitting and receiving mode is programmed.

5GHz	Frequency Range (MHz)	Center Frequency (MHz)
802.11a	[5170,5330]U[5490,5710] U[5735,5835]	"5180 5185 5190 5195 5200 5205 5210 5215 5220 5225 5230 5235 5240 5260 5265 5270 5275 5280 5285 5290 5295 5300 5305 5310 5315 5320 5500 5505 5510 5515 5520 5525 5530 5535 5540 5545 5550 5555 5560 5565 5570 5575 5580 5585 5590 5595 5600 5605 5610 5615 5620 5625 5630 5635 5640 5645 5650 5655 5660 5665 5670 5675 5680 5685 5690 5695 5700 5745 5750 5755 5760 5765 5770 5775 5780 5785 5790 5795 5800 5805 5810 5815 5820 5825"
802.11n(20MHz)	[5170,5330]U[5490,5710] U[5735,5835]	"5180 5185 5190 5195 5200 5205 5210 5215 5220 5225 5230 5235 5240 5260 5265 5270 5275 5280 5285 5290 5295 5300 5305 5310 5315 5320 5500 5505 5510 5515 5520 5525 5530 5535 5540 5545 5550 5555 5560 5565 5570 5575 5580 5585 5590 5595 5600 5605 5610 5615 5620 5625 5630 5635 5640 5645 5650 5655 5660 5665 5670 5675 5680 5685 5690 5695 5700 5745 5750 5755 5760 5765 5770 5775 5780 5785 5790 5795 5800 5805 5810 5815 5820 5825"
802.11n(40MHz)	[5170,5330]U[5490,5710] U[5735,5835]	"5190 5195 5200 5205 5210 5215 5220 5225 5230 5270 5275 5280 5285 5290 5295 5300 5305 5310 5510 5515 5520 5525 5530 5535 5540 5545 5550 5555 5560 5565 5570 5575 5580 5585 5590 5595 5600 5605 5610 5615 5620 5625 5630 5635 5640 5645 5650 5655 5660 5665 5670 5675 5680 5685 5690 5755 5760 5765 5770 5775 5780 5785 5790 5795 5800 5805 5810 5815"
802.11ac(20MHz)	[5170,5330]U[5490,5710] U[5735,5835]	"5180 5185 5190 5195 5200 5205 5210 5215 5220 5225 5230 5235 5240 5260 5265 5270 5275 5280 5285 5290 5295 5300 5305 5310 5315 5320 5500 5505 5510 5515 5520 5525 5530 5535 5540 5545 5550 5555 5560 5565 5570 5575 5580 5585 5590 5595 5600 5605 5610 5615 5620 5625 5630 5635 5640 5645 5650 5655 5660 5665 5670 5675 5680 5685 5690 5695 5700 5745 5750 5755 5760 5765 5770 5775 5780 5785 5790 5795 5800 5805 5810 5815 5820 5825"
802.11ac(40MHz)	[5170,5330]U[5490,5710] U[5735,5835]	"5190 5195 5200 5205 5210 5215 5220 5225 5230 5270 5275 5280 5285 5290 5295 5300 5305 5310 5510 5515 5520 5525 5530 5535 5540 5545 5550 5555 5560 5565 5570 5575 5580 5585 5590 5595 5600 5605 5610 5615 5620 5625 5630 5635 5640 5645 5650 5655 5660 5665 5670 5675 5680 5685 5690 5755 5760 5765 5770 5775 5780 5785 5790 5795 5800 5805 5810 5815"
802.11ac(80MHz)	[5170,5330]U[5490,5710] U[5735,5835]	"5210 5290 5530 5535 5540 5545 5550 5555 5560 5565 5570 5575 5580 5585 5590 5595 5600 5605 5610 5615 5620 5625 5630 5635 5640 5645 5650 5655 5660 5665 5670 5775 5780 5785 5790 5795"

WIFI 5G with 5250-5350MHz

Frequency and Channels list for 802.11a/n(20)/ac(20):

Channel	Frequency (MHz)	Channel	Frequency (MHz)	Channel	Frequency (MHz)
52	5260	60	5300	-	-
56	5280	64	5320	-	-

Frequency and Channels list for 802.11n (40)/ac(40):

Channel	Frequency (MHz)	Channel	Frequency (MHz)	Channel	Frequency (MHz)
54	5270	-	-	-	-
62	5310	-	-	-	-

Frequency and Channels list for 802.11ac(80):

Channel	Frequency (MHz)	Channel	Frequency (MHz)	Channel	Frequency (MHz)
58	5290	-	-	-	-

Test Frequency and Channels for 802.11a/n(20)/ac(20):

Lowest Frequency		Middle Frequency		Highest Frequency	
Channel	Frequency (MHz)	Channel	Frequency (MHz)	Channel	Frequency (MHz)
52	5260	56	5280	64	5320

Test Frequency and channels for 802.11n (40)/802.11ac(40):

Lowest Frequency		Middle Frequency		Highest Frequency	
Channel	Frequency (MHz)	Channel	Frequency (MHz)	Channel	Frequency (MHz)
54	5270	-	-	62	5310

Test Frequency and channels for 802.11ac(80):

Lowest Frequency		Middle Frequency		Highest Frequency	
Channel	Frequency (MHz)	Channel	Frequency (MHz)	Channel	Frequency (MHz)
58	5290	-	-	-	-

WIFI 5G with 5470-5725MHz

Frequency and Channels list for 802.11a/n(20)/ac(20):

Channel	Frequency (MHz)	Channel	Frequency (MHz)	Channel	Frequency (MHz)
100	5500	116	5580	132	5660
104	5520	120	5600	136	5680
108	5540	124	5620	140	5700
112	5560	128	5640	-	-

Frequency and Channels list for 802.11n (40)/ac(40):

Channel	Frequency (MHz)	Channel	Frequency (MHz)	Channel	Frequency (MHz)
102	5510	118	5590	134	5670
110	5550	126	5630	-	-

Frequency and Channels list for 802.11ac(80):

Channel	Frequency (MHz)	Channel	Frequency (MHz)	Channel	Frequency (MHz)
106	5530	122	5610	-	-

Test Frequency and Channels for 802.11a/n(20)/ac(20):

Lowest Frequency		Middle Frequency		Highest Frequency	
Channel	Frequency (MHz)	Channel	Frequency (MHz)	Channel	Frequency (MHz)
100	5500	116	5580	140	5700

Test Frequency and channels for 802.11n (40)/802.11ac(40):

Lowest Frequency		Middle Frequency		Highest Frequency	
Channel	Frequency (MHz)	Channel	Frequency (MHz)	Channel	Frequency (MHz)
102	5510	-	-	134	5670

Test Frequency and channels for 802.11ac(80):

Lowest Frequency		Middle Frequency		Highest Frequency	
Channel	Frequency (MHz)	Channel	Frequency (MHz)	Channel	Frequency (MHz)
106	5530	122	5610	-	-

4 FACILITIES AND ACCREDITATIONS

4.1 EQUIPMENT

Radiated emissions are measured with one or more of the following types of linearly polarized antennas: tuned dipole, biconical, log periodic, bi-log, and/or ridged waveguide, horn. Spectrum analyzers with preselectors and quasi-peak detectors are used to perform radiated measurements.

Conducted emissions are measured with Line Impedance Stabilization Networks and EMI Test Receivers. Calibrated wideband preamplifiers, coaxial cables, and coaxial attenuators are also used for making measurements.

All receiving equipment conforms to CISPR Publication 16-1, "Radio Interference Measuring Apparatus and Measurement Methods."

4.2 DESCRIPTION OF TEST FACILITY

Site Description

Name of Firm : EMTEK (SHENZHEN) CO., LTD.

Site Location : Building 69, Majialong Industry Zone, Nanshan District, Shenzhen, Guangdong, China



5 SETUP OF EQUIPMENT UNDER TEST

5.1 SETUP CONFIGURATION OF EUT

Master Mode

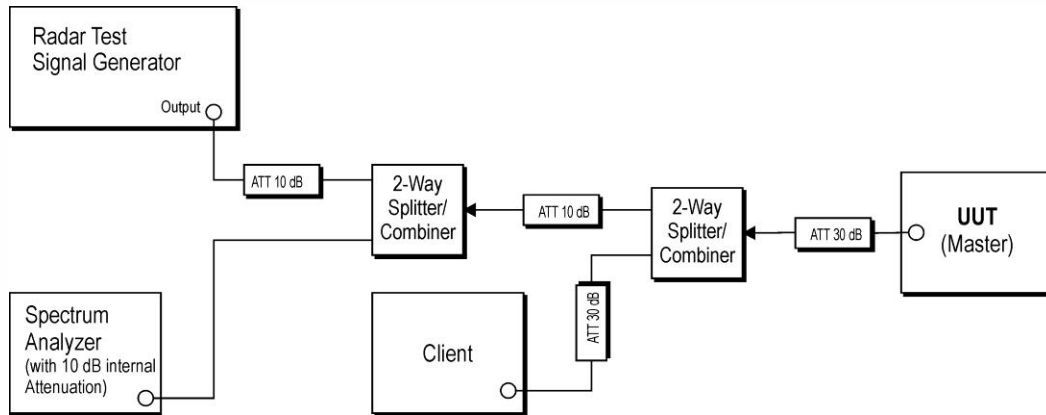

Slave Mode

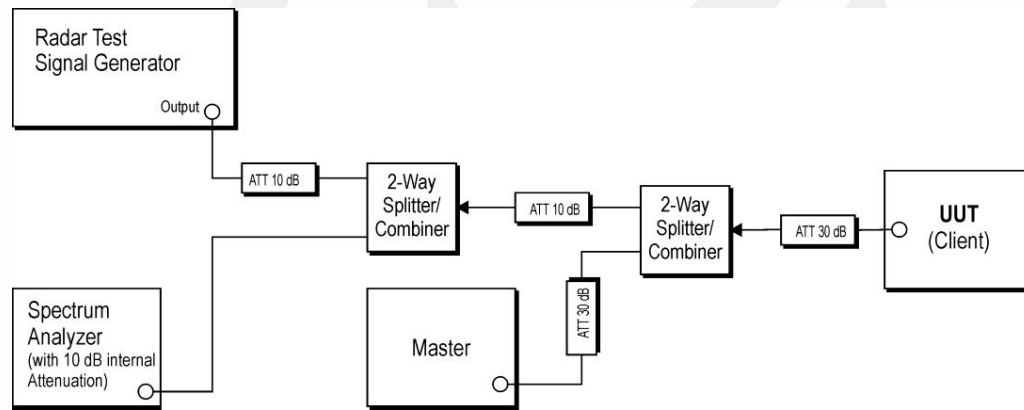

5.2 CALIBRATION OF DFS DETECTION THRESHOLD LEVEL

A 50 ohm load is connected in place of the spectrum analyzer, and the spectrum analyzer is connected in place of the master device and the signal generator is set to CW mode. The amplitude of the signal generator is adjusted to yield a level of -62 dBm as measured on the spectrum analyzer.

Without changing any of the instrument settings, the spectrum analyzer is reconnected to the Common port of the Spectrum Analyzer Combiner/Divider. Measure the amplitude and calculate the difference from -62 dBm. Adjust the Reference Level Offset of the spectrum analyzer to this difference.

The spectrum analyzer displays the level of the signal generator as received at the antenna ports of the Master Device. The interference detection threshold may be varied from the calibrated value of -62 dBm and the spectrum analyzer will still indicate the level as received by the Master Device.

Set the signal generator to produce a radar waveform, trigger a burst manually and measure the level on the spectrum analyzer. Readjust the amplitude of the signal generator as required so that the peak level of the waveform is at a displayed level equal to the required or desired interference detection threshold. Separate signal generator amplitude settings are determined as required for each radar type.

5.3 SUPPORT EQUIPMENT

Tablet	: Model: xTablet T1180 Mfr/Brand: MobileDemand FCC ID: O86T1180 IC: 10591A-T1180
Adapter	: Model: AD-120200U0W Input: 100-240V~50/60Hz, 0.8A Output: 12V, 2A, 24W CE, FCC

Notes:

1. All the equipment/cables were placed in the worst-case configuration to maximize the emission during the test.
2. Grounding was established in accordance with the manufacturer's requirements and conditions for the intended use.



6 DYNAMIC FREQUENCY SELECTION REQUIREMENTS

6.1 APPLICABLE STANDARD

According to 15.407

6.2 CONFORMANCE LIMIT

The dynamic frequency selection requirement

Parameter	Value
Non-occupancy period	Minimum 30 minutes
Channel Availability Check Time	60 seconds
Channel Move Time	10 seconds See Note 1.
Channel Closing Transmission Time	200 milliseconds + an aggregate of 60 milliseconds over remaining 10 second periods. See Notes 1 and 2.
U-NII Detection Bandwidth	Minimum 100% of the U-NII 99% transmission power bandwidth. See Note 3.
<p>Note 1: <i>Channel Move Time</i> and the <i>Channel Closing Transmission Time</i> should be performed with Radar Type 0. The measurement timing begins at the end of the Radar Type 0 burst.</p> <p>Note 2: The <i>Channel Closing Transmission Time</i> is comprised of 200 milliseconds starting at the beginning of the <i>Channel Move Time</i> plus any additional intermittent control signals required to facilitate a <i>Channel</i> move (an aggregate of 60 milliseconds) during the remainder of the 10 second period. The aggregate duration of control signals will not count quiet periods in between transmissions.</p> <p>Note 3: During the <i>U-NII Detection Bandwidth</i> detection test, radar type 0 should be used. For each frequency step the minimum percentage of detection is 90 percent. Measurements are performed with no data traffic.</p>	

The following table lists the DFS The detection threshold values

Maximum Transmit Power	Value (See Notes 1, 2, and 3)
EIRP \geq 200 milliwatt	-64 dBm
EIRP < 200 milliwatt and power spectral density < 10 dBm/MHz	-62 dBm
EIRP < 200 milliwatt that do not meet the power spectral density requirement	-64 dBm
<p>Note 1: This is the level at the input of the receiver assuming a 0 dBi receive antenna.</p> <p>Note 2: Throughout these test procedures an additional 1 dB has been added to the amplitude of the test transmission waveforms to account for variations in measurement equipment. This will ensure that the test signal is at or above the detection threshold level to trigger a DFS response.</p> <p>Note 3: EIRP is based on the highest antenna gain. For MIMO devices refer to KDB Publication 662911 D01.</p>	

6.3 TEST CONFIGURATION

Conducted measurements shall be used for DFS test.

6.4 TEST PARAMETERS OF DFS TEST SIGNAL

The following table lists the parameters of radar test signals

Short Pulse Radar Test Waveforms

Radar Type	Pulse Width (μsec)	PRI (μsec)	Number of Pulses	Minimum Percentage of Successful Detection	Minimum Number of Trials
0	1	1428	18	See Note 1	See Note 1
1	1	Test A: 15 unique PRI values randomly selected from the list of 23 PRI values in Table 5a	Roundup $\left\{ \begin{array}{l} \left(\frac{1}{360} \right) \cdot \\ \left(\frac{19 \cdot 10^6}{\text{PRI}_{\mu\text{sec}}} \right) \end{array} \right\}$	60%	30
		Test B: 15 unique PRI values randomly selected within the range of 518-3066 μsec, with a minimum increment of 1 μsec, excluding PRI values selected in Test A			
2	1-5	150-230	23-29	60%	30
3	6-10	200-500	16-18	60%	30
4	11-20	200-500	12-16	60%	30
Aggregate (Radar Types 1-4)				80%	120
Note 1: Short Pulse Radar Type 0 should be used for the detection bandwidth test, channel move time, and channel closing time tests.					

Long Pulse Radar Test Waveform

Radar Type	Pulse Width (μsec)	Chirp Width (MHz)	PRI (μsec)	Number of Pulses per Burst	Number of Bursts	Minimum Percentage of Successful Detection	Minimum Number of Trials
5	50-100	5-20	1000-2000	1-3	8-20	80%	30

Frequency Hopping Radar Test Waveform

Radar Type	Pulse Width (μsec)	PRI (μsec)	Pulses per Hop	Hopping Rate (kHz)	Hopping Sequence Length (msec)	Minimum Percentage of Successful Detection	Minimum Number of Trials
6	1	333	9	0.333	300	70%	30

Temperature : 25°C
Humidity : 60 %

ATM Pressure:: 1011 mbar
Test Engineer: GJ

RADAR TYPE 0		Rohde & Schwarz K350 Pulse Sequencer DFS		
Trial #	Number of Pulses per Burst	Pulse Width (µsec)	PRI (µs)	Waveform length(us)
1	18	1	1428	25704
2	18	1	1428	25704
3	18	1	1428	25704
4	18	1	1428	25704
5	18	1	1428	25704
6	18	1	1428	25704
7	18	1	1428	25704
8	18	1	1428	25704
9	18	1	1428	25704
10	18	1	1428	25704
11	18	1	1428	25704
12	18	1	1428	25704
13	18	1	1428	25704
14	18	1	1428	25704
15	18	1	1428	25704
16	18	1	1428	25704
17	18	1	1428	25704
18	18	1	1428	25704
19	18	1	1428	25704
20	18	1	1428	25704
21	18	1	1428	25704
22	18	1	1428	25704
23	18	1	1428	25704
24	18	1	1428	25704
25	18	1	1428	25704
26	18	1	1428	25704
27	18	1	1428	25704
28	18	1	1428	25704
29	18	1	1428	25704
30	18	1	1428	25704

RADAR TYPE 1			Rohde & Schwarz K350 Pulse Sequencer DFS	
Trial #	Number of Pulses per Burst	Pulse Width (μsec)	PRI (μs)	Waveform length(us)
1	18	1	3066	55188
2	70	1	758	53060
3	63	1	838	52794
4	68	1	778	52904
5	67	1	798	53466
6	76	1	698	53048
7	57	1	938	53466
8	92	1	578	53176
9	74	1	718	53132
10	98	1	538	52724
11	59	1	898	52982
12	72	1	738	53136
13	61	1	878	53558
14	86	1	618	53148
15	65	1	818	53170
16	31	1	1715	53165
17	90	1	589	53010
18	67	1	793	53131
19	24	1	2290	54960
20	27	1	2025	54675
21	48	1	1107	53136
22	51	1	1038	52938
23	23	1	2376	54648
24	22	1	2489	54758
25	20	1	2686	53720
26	28	1	1930	54040
27	41	1	1309	53669
28	50	1	1056	52800
29	30	1	1794	53820
30	19	1	2895	55005

RADAR TYPE 2				Rohde & Schwarz K350 Pulse Sequencer DFS
Trial #	Number of Pulses per Burst	Pulse Width (µsec)	PRI (µs)	Waveform length(us)
1	27	1.9	229	6183
2	25	4.2	219	5475
3	26	4.7	156	4056
4	24	1.1	215	5160
5	26	3	227	5902
6	23	4	150	3450
7	24	1.2	186	4464
8	28	3.6	226	6328
9	28	1.1	192	5376
10	25	2.4	157	3925
11	24	4.9	163	3912
12	27	1.8	210	5670
13	24	3.7	201	4824
14	27	1.6	210	5670
15	28	2.6	194	5432
16	24	2.6	212	5088
17	28	4.9	205	5740
18	24	4.4	206	4944
19	28	3.4	208	5824
20	24	3.7	226	5424
21	28	1.8	190	5320
22	25	4.9	190	4750
23	25	2.7	204	5100
24	29	1.9	176	5104
25	26	3.9	213	5538
26	27	4	185	4995
27	23	3.5	217	4991
28	27	3.5	178	4806
29	26	3.6	204	5304
30	29	3	190	5510

RADAR TYPE 3				Rohde & Schwarz K350 Pulse Sequencer DFS
Trial #	Number of Pulses per Burst	Pulse Width (µsec)	PRI (µs)	Waveform length(us)
1	18	8.8	349	6282
2	17	8.4	357	6069
3	18	9.6	246	4428
4	18	6.3	403	7254
5	16	7.3	433	6928
6	18	9.3	378	6804
7	17	9.8	256	4352
8	18	9.4	406	7308
9	17	6.9	215	3655
10	16	6.8	422	6752
11	16	7.1	334	5344
12	17	9.4	229	3893
13	18	6.2	259	4662
14	18	6.3	401	7218
15	18	7.8	453	8154
16	17	6.9	253	4301
17	16	6.5	466	7456
18	17	8.4	409	6953
19	18	6.6	213	3834
20	17	8.9	376	6392
21	16	9.8	487	7792
22	17	9.8	429	7293
23	17	9	471	8007
24	17	9.9	494	8398
25	17	7.3	377	6409
26	17	7.4	282	4794
27	17	9.4	351	5967
28	17	8	477	8109
29	16	9.1	214	3424
30	18	6.3	348	6264

RADAR TYPE 4				Rohde & Schwarz K350 Pulse Sequencer DFS
Trial #	Number of Pulses per Burst	Pulse Width (µsec)	PRI (µs)	Waveform length(us)
1	12	11.1	303	3636
2	13	18.3	239	3107
3	16	18.7	406	6496
4	13	17	492	6396
5	16	18	365	5840
6	15	15.1	205	3075
7	15	15.1	499	7485
8	14	17.3	470	6580
9	14	17.9	213	2982
10	16	11.2	338	5408
11	13	19.8	453	5889
12	12	16.1	209	2508
13	13	13.9	267	3471
14	12	12.3	366	4392
15	14	15.8	205	2870
16	15	12.2	408	6120
17	15	11.7	435	6525
18	14	19.2	284	3976
19	14	17.1	301	4214
20	14	12.6	402	5628
21	12	11.8	365	4380
22	15	13.5	333	4995
23	12	11	272	3264
24	15	12.8	402	6030
25	15	17.6	433	6495
26	15	13.7	381	5715
27	13	13.6	242	3146
28	14	15.1	201	2814
29	14	13.7	418	5852
30	14	15.9	369	5166

TYPE 5			
Rohde & Schwarz K350 Pulse Sequencer DFS			
Trial #	Chirp Width (MHz)	Subset	Fc
1	16	1	5500
2	8	1	5500
3	14	1	5500
4	18	1	5500
5	15	1	5500
6	17	1	5500
7	9	1	5500
8	7	1	5500
9	13	1	5500
10	15	1	5500
11	16	2	5497.4
12	7	2	5493.8
13	12	2	5495.8
14	8	2	5494.2
15	17	2	5497.8
16	10	2	5495
17	18	2	5498.2
18	15	2	5497
19	18	2	5498.2
20	12	2	5495.8
21	8	3	5505.8
22	15	3	5503
23	10	3	5505
24	8	3	5505.8
25	9	3	5505.4
26	12	3	5504.2
27	8	3	5505.8
28	11	3	5504.6
29	12	3	5504.2
30	16	3	5502.6

TYPE 5 PARAMETER SHEET						Rohde & Schwarz Pulse Sequencer
Trial Number : 1						
Bursts in Trial: 20						
Burst	Number of Pulses	Pulse Width (µsec)	Chirp Width (MHz)	Pulse 1-to-2 PRI (µsec)	Pulse 2-to-3 PRI (µsec)	Start Location Within Interval (msec)
1	2	52.6	16	1072		178.327
2	3	64.7	16	1341	1483	10.74
3	3	80.2	16	1500	1205	232.82
4	2	69	16	1863		249.91
5	3	80.4	16	1118	1375	247.93
6	2	95.3	16	1520		194.42
7	2	74.2	16	1133		349.98
8	2	91.9	16	1339		224.03
9	1	91.1	16			159.19
10	2	58.3	16	1914		286.14
11	2	71.5	16	1980		337.22
12	2	67	16	1228		505.95
13	1	63.9	16			129.53
14	2	68	16	1380		485.29
15	2	65.4	16	1821		170.28
16	1	51.1	16			291.16
17	3	59.9	16	1945	1515	317.61
18	3	73	16	1004	1973	531.4
19	2	67.5	16	1141		92.2
20	2	83.7	16	1363		314.7

TYPE 5 PARAMETER SHEET

 Rohde & Schwarz
Pulse Sequencer

Trial Number : 2
Bursts in Trial: 19

Burst	Number of Pulses	Pulse Width (μsec)	Chirp Width (MHz)	Pulse 1-to-2 PRI (μsec)	Pulse 2-to-3 PRI (μsec)	Start Location Within Interval (msec)
1	1	86.5	8			410.191
2	2	50.3	8	1228		578.671
3	3	92	8	1453	1039	320.092
4	2	83	8	1472		286.303
5	3	64.3	8	1799	1838	401.304
6	2	57.1	8	1883		104.695
7	2	85.2	8	1004		429.166
8	2	97.7	8	1571		556.907
9	2	79.4	8	1140		79.978
10	1	64.9	8			555.639
11	1	96.7	8			415.811
12	1	95.9	8			609.532
13	2	94	8	1770		540.533
14	1	97.8	8			31.314
15	2	72.3	8	1623		299.455
16	2	84.7	8	1918		324.876
17	3	54.6	8	1199	1946	428.337
18	1	90.5	8			417.258
19	2	91	8	1182		69.679

TYPE 5 PARAMETER SHEET

 Rohde & Schwarz
Pulse Sequencer

Trial Number : 4
Bursts in Trial: 15

Burst	Number of Pulses	Pulse Width (µsec)	Chirp Width (MHz)	Pulse 1-to-2 PRI (µsec)	Pulse 2-to-3 PRI (µsec)	Start Location Within Interval (msec)
1	3	65.5	18	1689	1886	60.356
2	2	55	18	1537		450.52
3	1	60.7	18			147.52
4	2	95.1	18	1028		592.66
5	2	96	18	1128		408.95
6	2	60.1	18	1416		761.46
7	1	86.9	18			222.23
8	2	92.7	18	1331		681.58
9	1	92.2	18			411.37
10	2	75.9	18	1687		2.03
11	1	88.5	18			73.03
12	3	59.9	18	1079	1641	87.63
13	1	89.7	18			246.08
14	2	66.1	18	1224		429.7
15	3	75.4	18	1735	1741	268.5

TYPE 5 PARAMETER SHEET

 Rohde & Schwarz
Pulse Sequencer

Trial Number : 5
Bursts in Trial: 13

Burst	Number of Pulses	Pulse Width (µsec)	Chirp Width (MHz)	Pulse 1-to-2 PRI (µsec)	Pulse 2-to-3 PRI (µsec)	Start Location Within Interval (msec)
1	1	98.1	15			879.441
2	3	82.9	15	1594	1556	342.133
3	2	94	15	1916		853.056
4	1	97.6	15			723.629
5	3	80.5	15	1104	1687	252.952
6	2	87.4	15	1212		440.985
7	2	74.1	15	1828		832.878
8	1	63.2	15			765.012
9	1	54.6	15			591.875
10	3	72.6	15	1814	1172	463.038
11	2	84.2	15	1741		714.931
12	3	52.5	15	1095	1346	138.554
13	3	61.4	15	1639	1567	539.077

TYPE 5 PARAMETER SHEET

 Rohde & Schwarz
Pulse Sequencer

Trial Number : 6
Bursts in Trial: 12

Burst	Number of Pulses	Pulse Width (µsec)	Chirp Width (MHz)	Pulse 1-to-2 PRI (µsec)	Pulse 2-to-3 PRI (µsec)	Start Location Within Interval (msec)
1	2	96.7	17	1586		953.33
2	2	72.7	17	1646		65.95
3	2	83.3	17	1233		767.76
4	2	62	17	1875		339.09
5	2	68.2	17	1109		425.66
6	3	59	17	1968	1084	527.55
7	2	54.6	17	1383		537.11
8	1	71.8	17			72.23
9	3	89.7	17	1173	1839	626.29
10	2	60.4	17	1618		243.11
11	2	81.4	17	1613		900.2
12	2	86.2	17	1893		845

TYPE 5 PARAMETER SHEET

 Rohde & Schwarz
Pulse Sequencer

Trial Number : 7
Bursts in Trial: 9

Burst	Number of Pulses	Pulse Width (µsec)	Chirp Width (MHz)	Pulse 1-to-2 PRI (µsec)	Pulse 2-to-3 PRI (µsec)	Start Location Within Interval (msec)
1	2	94.6	9	1845		209.942
2	3	74.6	9	1464	1759	749.647
3	1	79.5	9			695.433
4	3	99.9	9	1412	1276	903.33
5	3	50.6	9	1930	1208	926.657
6	3	53.6	9	1624	1533	314.763
7	3	72.2	9	1686	1835	987.36
8	2	99.2	9	1056		1017.867
9	1	84.2	9			401.133



TYPE 5 PARAMETER SHEET

 Rohde & Schwarz
Pulse Sequencer

Trial Number : 8
Bursts in Trial: 15

Burst	Number of Pulses	Pulse Width (μsec)	Chirp Width (MHz)	Pulse 1-to-2 Spacing (μsec)	Pulse 2-to-3 PRI (μsec)	Start Location Within Interval (msec)
1	2	74.4	7	1226		176.754
2	2	71.7	7	1697		777.63
3	3	95.6	7	1435	1117	720.7
4	1	98.1	7			464.12
5	2	85.6	7	1843		173.67
6	2	70.6	7	1482		184.74
7	2	61.6	7	1028		719.83
8	2	68.8	7	1955		171.13
9	3	79.9	7	1700	1077	372.31
10	1	76.2	7			749.76
11	2	85.1	7	1594		194.7
12	2	86.9	7	1738		409.52
13	3	91.2	7	1209	1936	595.2
14	2	88.1	7	1333		774.7
15	2	78.8	7	1892		788.8

TYPE 5 PARAMETER SHEET						Rohde & Schwarz Pulse Sequencer
Trial Number : 9						
Bursts in Trial: 14						
Burst	Number of Pulses	Pulse Width (µsec)	Chirp Width (MHz)	Pulse 1-to-2 PRI (µsec)	Pulse 2-to-3 PRI (µsec)	Start Location Within Interval (msec)
1	3	70.7	13	1159	1233	628.059
2	3	53.2	13	1379	1970	344.187
3	2	89.2	13	1641		395.314
4	3	89.4	13	1520	1076	122.811
5	1	76.7	13			507.829
6	2	98.7	13	1764		390.286
7	1	60.8	13			403.433
8	1	96.4	13			798.88
9	1	70	13			451.477
10	2	80.8	13	1247		834.504
11	1	69.8	13			635.131
12	2	64.5	13	1864		97.029
13	3	54.6	13	1327	1453	341.586
14	1	90.5	13			243.643

TYPE 5 PARAMETER SHEET						Rohde & Schwarz Pulse Sequencer
Trial Number : 10						
Bursts in Trial: 19						
Burst	Number of Pulses	Pulse Width (µsec)	Chirp Width (MHz)	Pulse 1-to-2 PRI (µsec)	Pulse 2-to-3 PRI (µsec)	Start Location Within Interval (msec)
1	2	78.6	15	1765		350.687
2	2	94.1	15	1120		187.089
3	3	93.1	15	1422	1503	228.162
4	1	62.1	15			461.483
5	3	83.4	15	1717	1699	229.644
6	3	74	15	1908	1938	279.725
7	2	71.5	15	1123		217.086
8	1	52.2	15			495.327
9	2	96.7	15	1517		527.818
10	3	51.9	15	1068	1576	375.679
11	3	67.6	15	1992	1186	382.431
12	2	53.1	15	1799		602.052
13	2	59.2	15	1259		133.273
14	3	67.6	15	1883	1124	260.044
15	3	88	15	1771	1881	149.875
16	3	63.5	15	1725	1398	35.626
17	2	72.1	15	1047		623.837
18	2	78.7	15	1238		324.158
19	2	99.4	15	1300		20.179

TYPE 5 PARAMETER SHEET

 Rohde & Schwarz
Pulse Sequencer

Trial Number : 11
Bursts in Trial: 17

Burst	Number of Pulses	Pulse Width (µsec)	Chirp Width (MHz)	Pulse 1-to-2 PRI (µsec)	Pulse 2-to-3 PRI (µsec)	Start Location Within Interval (msec)
1	3	73	16	1337	1692	369.319
2	3	65.8	16	1473	1314	145.857
3	2	76.7	16	1095		384.395
4	3	89.2	16	1817	1632	121.133
5	2	85.2	16	1865		668.501
6	1	61.7	16			436.758
7	1	90.5	16			566.936
8	2	54	16	1780		28.804
9	1	53.2	16			441.121
10	1	54.5	16			232.939
11	2	70.7	16	1237		468.326
12	2	60.7	16	1406		519.724
13	2	56.3	16	1661		84.192
14	3	80.9	16	1023	1621	537.539
15	3	97.5	16	1574	1524	101.817
16	2	76.4	16	1396		453.365
17	1	88.5	16			131.382

TYPE 5 PARAMETER SHEET

 Rohde & Schwarz
Pulse Sequencer

Trial Number : 12
Bursts in Trial: 18

Burst	Number of Pulses	Pulse Width (μsec)	Chirp Width (MHz)	Pulse 1-to-2 PRI (μsec)	Pulse 2-to-3 PRI (μsec)	Start Location Within Interval (msec)
1	3	73	7	1585	1532	284.591
2	2	64.3	7	1991		331.309
3	2	98.8	7	1712		297.607
4	1	77.2	7			68.57
5	1	91.8	7			373.463
6	2	83.9	7	1297		174.757
7	3	54.4	7	1888	1527	328.98
8	1	69.3	7			45.273
9	2	54	7	1171		534.547
10	3	75.7	7	1270	1573	635.73
11	2	84.8	7	1870		111.973
12	3	93.2	7	1051	1998	107.667
13	2	64.5	7	1572		254.83
14	2	58.3	7	1028		143.203
15	1	84.9	7			444.157
16	1	77.8	7			622.8
17	3	68.7	7	1747	1559	281.933
18	2	89.8	7	1505		218.567

TYPE 5 PARAMETER SHEET						Rohde & Schwarz Pulse Sequencer
Trial Number : 13						
Bursts in Trial: 14						
Burst	Number of Pulses	Pulse Width (µsec)	Chirp Width (MHz)	Pulse 1-to-2 PRI (µsec)	Pulse 2-to-3 PRI (µsec)	Start Location Within Interval (msec)
1	2	91.4	12	1300		249.808
2	2	73.3	12	1298		704.917
3	2	92.3	12	1966		763.324
4	3	50.4	12	1805	1903	24.581
5	2	72.2	12	1367		652.779
6	3	81.3	12	1332	1881	86.126
7	1	54.8	12			474.523
8	2	80.6	12	1170		74.79
9	2	78.3	12	1308		312.877
10	1	95.3	12			749.494
11	2	86.8	12	1649		563.741
12	1	99.4	12			44.489
13	3	89.4	12	1718	1543	771.586
14	1	74.3	12			731.943

TYPE 5 PARAMETER SHEET

 Rohde & Schwarz
Pulse Sequencer

Trial Number : 14
Bursts in Trial: 18

Burst	Number of Pulses	Pulse Width (µsec)	Chirp Width (MHz)	Pulse 1-to-2 PRI (µsec)	Pulse 2-to-3 PRI (µsec)	Start Location Within Interval (msec)
1	2	76.8	8	1852		152.946
2	2	92.6	8	1940		100.518
3	1	77.1	8			351.997
4	1	97.7	8			367.2
5	1	87.5	8			349.733
6	3	56	8	1546	1177	255.087
7	2	66.9	8	1118		615
8	1	95.3	8			572.363
9	3	68.6	8	1264	1207	553.807
10	3	53.9	8	1956	1859	193.7
11	2	95.1	8	1684		399.203
12	2	59.6	8	1492		187.667
13	1	79.9	8			142.95
14	2	55.1	8	1311		341.323
15	1	70.1	8			178.047
16	1	60.1	8			620.4
17	1	95.5	8			200.933
18	2	69.3	8	1856		501.867

TYPE 5 PARAMETER SHEET						Rohde & Schwarz Pulse Sequencer
Trial Number : 15						
Bursts in Trial: 18						
Burst	Number of Pulses	Pulse Width (µsec)	Chirp Width (MHz)	Pulse 1-to-2 PRI (µsec)	Pulse 2-to-3 PRI (µsec)	Start Location Within Interval (msec)
1	1	66.6	17			658.103
2	2	54.4	17	1209		485.123
3	2	51.5	17	1212		250.727
4	1	79.8	17			323.53
5	3	65	17	1442	1602	462.143
6	3	50.3	17	1314	1423	203.057
7	2	71	17	1286		489.25
8	3	71.1	17	1246	1804	560.213
9	3	52.5	17	1166	1222	634.857
10	1	67.3	17			388.99
11	2	67.5	17	1341		185.343
12	2	54.5	17	1287		59.627
13	1	78.8	17			0.96
14	2	68.2	17	1130		398.363
15	2	99	17	1478		488.047
16	1	59.6	17			594.9
17	1	83	17			296.433
18	1	57.6	17			106.667

TYPE 5 PARAMETER SHEET						Rohde & Schwarz Pulse Sequencer
Trial Number : 16						
Bursts in Trial: 11						
Burst	Number of Pulses	Pulse Width (µsec)	Chirp Width (MHz)	Pulse 1-to-2 PRI (µsec)	Pulse 2-to-3 PRI (µsec)	Start Location Within Interval (msec)
1	2	59.8	10	1544		832.641
2	2	69.7	10	1375		157.141
3	2	78.8	10	1226		952.682
4	1	68.3	10			763.453
5	3	84.8	10	1922	1695	976.954
6	1	97.3	10			920.705
7	2	59.9	10	1584		612.935
8	1	51.6	10			494.946
9	2	61.2	10	1726		793.587
10	3	77.5	10	1068	1690	493.918
11	3	89.5	10	1619	1123	387.309

TYPE 5 PARAMETER SHEET						Rohde & Schwarz Pulse Sequencer
Trial Number : 17						
Bursts in Trial: 11						
Burst	Number of Pulses	Pulse Width (µsec)	Chirp Width (MHz)	Pulse 1-to-2 PRI (µsec)	Pulse 2-to-3 PRI (µsec)	Start Location Within Interval (msec)
1	3	83.2	18	1336	1483	286.226
2	3	56.1	18	1443	1586	384.411
3	1	65.5	18			959.692
4	2	85	18	1865		645.603
5	3	65.4	18	1965	1083	518.294
6	3	99	18	1933	1111	197.645
7	2	75.5	18	1447		824.925
8	2	66.4	18	1054		21.906
9	3	69.2	18	1712	1493	497.587
10	3	52.3	18	1837	1564	375.318
11	1	60.8	18			793.209

TYPE 5 PARAMETER SHEET						Rohde & Schwarz Pulse Sequencer
Trial Number : 18						
Bursts in Trial: 8						
Burst	Number of Pulses	Pulse Width (µsec)	Chirp Width (MHz)	Pulse 1-to-2 PRI (µsec)	Pulse 2-to-3 PRI (µsec)	Start Location Within Interval (msec)
1	3	78.2	15	1810	1633	171.94
2	2	96.4	15	1170		730.27
3	1	86.3	15			916.49
4	1	55.5	15			634.84
5	3	84.3	15	1984	1723	810.84
6	3	58.8	15	1565	1973	1423.28
7	2	91.7	15	1608		1259.6
8	3	87.8	15	1025	1940	537.9



TYPE 5 PARAMETER SHEET

 Rohde & Schwarz
Pulse Sequencer

Trial Number : 19
Bursts in Trial: 13

Burst	Number of Pulses	Pulse Width (µsec)	Chirp Width (MHz)	Pulse 1-to-2 PRI (µsec)	Pulse 2-to-3 PRI (µsec)	Start Location Within Interval (msec)
1	3	70.3	18	1837	1314	754.144
2	2	88.2	18	1880		773.143
3	3	77.1	18	1425	1180	191.466
4	3	61.8	18	1196	1247	675.969
5	2	94.3	18	1371		167.922
6	1	74.8	18			489.865
7	2	75.2	18	1744		889.058
8	3	70.9	18	1432	1891	222.552
9	3	56.3	18	1226	1365	414.115
10	3	56.3	18	1634	1008	64.798
11	1	81.1	18			590.071
12	3	91	18	1092	1195	768.054
13	1	95.3	18			575.677

TYPE 5 PARAMETER SHEET						Rohde & Schwarz Pulse Sequencer
Trial Number : 20						
Bursts in Trial: 20						
Burst	Number of Pulses	Pulse Width (µsec)	Chirp Width (MHz)	Pulse 1-to-2 PRI (µsec)	Pulse 2-to-3 PRI (µsec)	Start Location Within Interval (msec)
1	3	92.1	12	1287	1337	78.181
2	2	67.4	12	1582		26.287
3	2	61.8	12	1198		113.98
4	3	71.3	12	1703	1800	162.93
5	2	76.6	12	1647		355.82
6	2	90.1	12	1570		232.46
7	2	93.4	12	1789		399.58
8	2	79.8	12	1629		185.32
9	1	94.1	12			543.23
10	2	97.1	12	1590		117.79
11	3	50.4	12	1859	1290	243.54
12	2	76.2	12	1521		501.01
13	1	70	12			116.61
14	2	65.4	12	1417		5.56
15	1	89.6	12			9.95
16	2	50.4	12	1317		58.89
17	2	52	12	1839		514.8
18	2	80.1	12	1942		25.1
19	3	54.6	12	1496	1001	78
20	1	64	12			193.7

TYPE 5 PARAMETER SHEET

 Rohde & Schwarz
Pulse Sequencer

Trial Number : 21
Bursts in Trial: 18

Burst	Number of Pulses	Pulse Width (µsec)	Chirp Width (MHz)	Pulse 1-to-2 PRI (µsec)	Pulse 2-to-3 PRI (µsec)	Start Location Within Interval (msec)
1	2	75.2	8	1559		633.788
2	2	65.3	8	1573		34.859
3	1	96.8	8			145.637
4	1	77.2	8			309.03
5	2	97.4	8	1410		559.603
6	2	78	8	1161		590.097
7	2	85.6	8	1200		659.89
8	1	90.3	8			293.883
9	2	88.9	8	1118		31.717
10	2	70.3	8	1650		606.7
11	3	91.3	8	1651	1293	354.593
12	3	65.9	8	1783	1267	62.677
13	1	73.3	8			274.89
14	1	75.1	8			336.683
15	2	96.2	8	1107		108.847
16	2	65.3	8	1293		354.6
17	1	90	8			191.933
18	2	78.8	8	1085		295.467

TYPE 5 PARAMETER SHEET						Rohde & Schwarz Pulse Sequencer
Trial Number : 22						
Bursts in Trial: 10						
Burst	Number of Pulses	Pulse Width (µsec)	Chirp Width (MHz)	Pulse 1-to-2 PRI (µsec)	Pulse 2-to-3 PRI (µsec)	Start Location Within Interval (msec)
1	3	65.7	15	1473	1999	290.871
2	3	57.9	15	1286	1748	993.68
3	1	91.1	15			122.13
4	1	78	15			270.58
5	3	86.2	15	1675	1776	1085.34
6	1	69.6	15			684.66
7	3	88.8	15	1585	1739	191.82
8	1	89.1	15			674.69
9	2	68.2	15	1951		1181.5
10	1	94.3	15			44.4

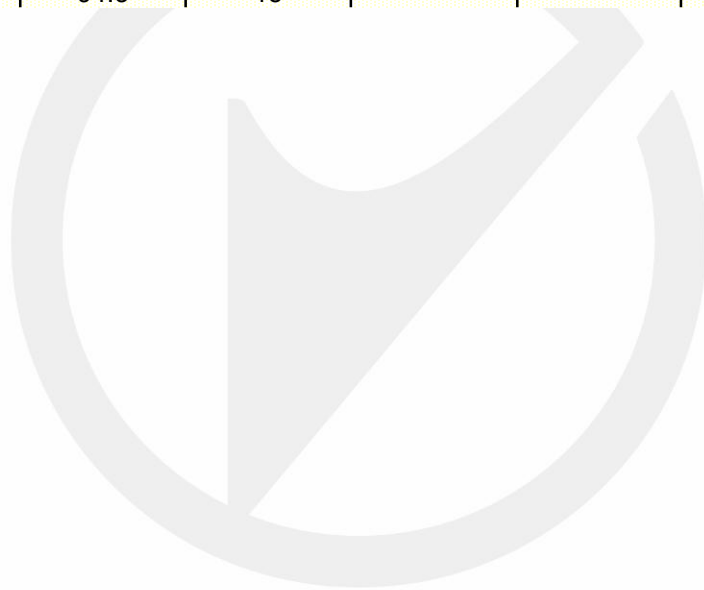

TYPE 5 PARAMETER SHEET						Rohde & Schwarz Pulse Sequencer
Trial Number : 23						
Bursts in Trial: 10						
Burst	Number of Pulses	Pulse Width (µsec)	Chirp Width (MHz)	Pulse 1-to-2 PRI (µsec)	Pulse 2-to-3 PRI (µsec)	Start Location Within Interval (msec)
1	2	67.1	10	1010		730.443
2	3	79.9	10	1872	1967	433.89
3	2	64.8	10	1454		1026.99
4	1	70.9	10			974.03
5	3	65.2	10	1596	1803	544.53
6	2	99.3	10	1244		743.23
7	3	79	10	1180	1220	891.08
8	3	76.7	10	1128	1411	632.61
9	3	51.2	10	1791	1743	918.6
10	1	72	10			788.8

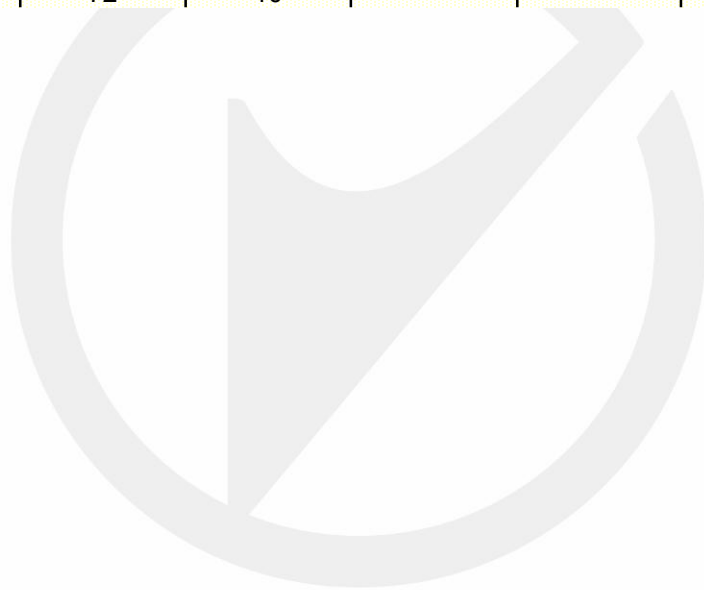

TYPE 5 PARAMETER SHEET						Rohde & Schwarz Pulse Sequencer
Trial Number : 24						
Bursts in Trial: 11						
Burst	Number of Pulses	Pulse Width (µsec)	Chirp Width (MHz)	Pulse 1-to-2 PRI (µsec)	Pulse 2-to-3 PRI (µsec)	Start Location Within Interval (msec)
1	2	80.9	8	1169		878.307
2	2	65.4	8	1128		510.331
3	2	75.8	8	1996		713.202
4	2	85.7	8	1979		56.153
5	2	90.9	8	1178		0.294
6	3	96	8	1485	1544	1053.325
7	2	69.1	8	1013		589.885
8	2	86.6	8	1013		396.836
9	3	70.6	8	1284	1165	800.107
10	2	77.5	8	1458		104.288
11	1	63.2	8			594.909



TYPE 5 PARAMETER SHEET

 Rohde & Schwarz
Pulse Sequencer

Trial Number : 25
Bursts in Trial: 11

Burst	Number of Pulses	Pulse Width (µsec)	Chirp Width (MHz)	Pulse 1-to-2 PRI (µsec)	Pulse 2-to-3 PRI (µsec)	Start Location Within Interval (msec)
1	3	81.4	9	1485	1439	274.893
2	1	57.1	9			52.641
3	3	71.6	9	1618	1716	1079.262
4	2	64.3	9	1280		309.463
5	2	63.3	9	1497		684.424
6	3	59.5	9	1389	1228	558.875
7	2	67.4	9	1499		725.045
8	3	58	9	1581	1274	624.756
9	3	54.9	9	1806	1804	519.847
10	1	71.7	9			157.008
11	2	77	9	1843		89.809

TYPE 5 PARAMETER SHEET

 Rohde & Schwarz
Pulse Sequencer

Trial Number : 26
Bursts in Trial: 20

Burst	Number of Pulses	Pulse Width (μsec)	Chirp Width (MHz)	Pulse 1-to-2 PRI (μsec)	Pulse 2-to-3 PRI (μsec)	Start Location Within Interval (msec)
1	1	79.9	12			349.029
2	3	68.4	12	1626	1815	264.872
3	3	69	12	1986	1564	424.46
4	3	50.7	12	1840	1803	332.13
5	3	83.6	12	1770	1795	142.12
6	2	60.8	12	1981		550
7	3	50.6	12	1691	1741	413.63
8	2	81.8	12	1231		105.27
9	1	65.1	12			409.54
10	1	58.2	12			179.75
11	2	87.7	12	1654		432.94
12	2	64.5	12	1724		81.69
13	2	76.9	12	1823		291.62
14	2	59.9	12	1889		46.06
15	2	99.1	12	1646		446.77
16	2	81.2	12	1009		97.23
17	3	99	12	1380	1357	362.24
18	2	74.7	12	1965		177.5
19	1	86.2	12			466.9
20	2	76.4	12	1815		179.5

TYPE 5 PARAMETER SHEET

 Rohde & Schwarz
Pulse Sequencer

Trial Number : 27
Bursts in Trial: 17

Burst	Number of Pulses	Pulse Width (µsec)	Chirp Width (MHz)	Pulse 1-to-2 PRI (µsec)	Pulse 2-to-3 PRI (µsec)	Start Location Within Interval (msec)
1	2	64.6	8	1536		571.131
2	3	55.9	8	1828	1652	189.004
3	2	84	8	1438		407.755
4	2	50.7	8	1528		400.673
5	1	58.4	8			28.151
6	3	92.5	8	1641	1098	666.818
7	2	75.2	8	1450		33.086
8	3	76.9	8	1558	1641	305.124
9	2	56.5	8	1855		638.041
10	2	96.6	8	1188		317.069
11	3	78.8	8	1562	1946	285.376
12	3	84.9	8	1691	1135	116.084
13	2	78.2	8	1255		575.272
14	1	74.3	8			219.759
15	3	76.6	8	1012	1701	97.307
16	1	95.5	8			446.265
17	2	52.4	8	1965		286.182

TYPE 5 PARAMETER SHEET

 Rohde & Schwarz
Pulse Sequencer

Trial Number : 28
Bursts in Trial: 14

Burst	Number of Pulses	Pulse Width (µsec)	Chirp Width (MHz)	Pulse 1-to-2 PRI (µsec)	Pulse 2-to-3 PRI (µsec)	Start Location Within Interval (msec)
1	2	50.6	11	1735		358.942
2	2	64.7	11	1420		695.487
3	2	65.7	11	1163		565.834
4	3	73	11	1811	1571	760.311
5	3	97.5	11	1091	1330	86.279
6	3	62.9	11	1994	1040	594.896
7	2	99.6	11	1816		238.423
8	2	72.3	11	1925		522.48
9	2	79.4	11	1296		793.367
10	1	76.6	11			240.544
11	1	74.8	11			88.831
12	3	75	11	1146	1860	369.559
13	3	57.9	11	1597	1123	628.686
14	2	95.1	11	1352		60.143

TYPE 5 PARAMETER SHEET

 Rohde & Schwarz
Pulse Sequencer

Trial Number : 29
Bursts in Trial: 20

Burst	Number of Pulses	Pulse Width (µsec)	Chirp Width (MHz)	Pulse 1-to-2 PRI (µsec)	Pulse 2-to-3 PRI (µsec)	Start Location Within Interval (msec)
1	3	64.7	12	1234	1652	71.305
2	3	71.2	12	1203	1444	410.55
3	2	54.9	12	1136		311.6
4	3	89.5	12	1193	1883	461.44
5	3	95.5	12	1968	1710	444.34
6	2	83.5	12	1354		485.33
7	3	63	12	1138	1162	430.94
8	2	98.8	12	1065		200.05
9	2	85.3	12	1411		390.07
10	2	83.9	12	1427		224.26
11	3	89.2	12	1881	1711	122.35
12	1	55.1	12			428.03
13	2	72.5	12	1586		399.79
14	3	64.8	12	1297	1676	97.81
15	3	73.4	12	1951	1664	241.92
16	3	70.4	12	1695	1592	241.19
17	2	75.9	12	1472		159.05
18	2	66.1	12	1370		138.7
19	2	92.2	12	1162		465.9
20	2	85	12	1938		572.5

TYPE 5 PARAMETER SHEET						Rohde & Schwarz Pulse Sequencer
Trial Number : 30						
Bursts in Trial: 13						
Burst	Number of Pulses	Pulse Width (µsec)	Chirp Width (MHz)	Pulse 1-to-2 PRI (µsec)	Pulse 2-to-3 PRI (µsec)	Start Location Within Interval (msec)
1	1	58.9	16			290.364
2	1	61.8	16			174.233
3	2	91.8	16	1460		131.666
4	2	68.5	16	1377		225.409
5	3	61.1	16	1795	1031	49.192
6	2	83.2	16	1457		733.495
7	2	61.3	16	1821		529.768
8	3	71.2	16	1969	1464	33.932
9	2	77.6	16	1113		168.365
10	2	81.3	16	1842		76.698
11	3	56.5	16	1825	1078	863.831
12	1	67.5	16			674.454
13	3	84.7	16	1299	1103	338.877

RADAR TYPE 6				Rohde & Schwarz K350 Pulse Sequencer DFS			
Trial #	Number of Pulses per Burst	Pulse Width (µsec)	PRI (µs)	Pulse Per hop	Hopping rate (KHz)	Hopping sequence length (ms)	Visible frequency number
1	18	1	333	9	0.333	300	20
2	18	1	333	9	0.333	300	18
3	18	1	333	9	0.333	300	25
4	18	1	333	9	0.333	300	19
5	18	1	333	9	0.333	300	22
6	18	1	333	9	0.333	300	23
7	18	1	333	9	0.333	300	17
8	18	1	333	9	0.333	300	15
9	18	1	333	9	0.333	300	14
10	18	1	333	9	0.333	300	16
11	18	1	333	9	0.333	300	26
12	18	1	333	9	0.333	300	23
13	18	1	333	9	0.333	300	12
14	18	1	333	9	0.333	300	25
15	18	1	333	9	0.333	300	24
16	18	1	333	9	0.333	300	19
17	18	1	333	9	0.333	300	22
18	18	1	333	9	0.333	300	18
19	18	1	333	9	0.333	300	27
20	18	1	333	9	0.333	300	28
21	18	1	333	9	0.333	300	21
22	18	1	333	9	0.333	300	20
23	18	1	333	9	0.333	300	22
24	18	1	333	9	0.333	300	18
25	18	1	333	9	0.333	300	19
26	18	1	333	9	0.333	300	21
27	18	1	333	9	0.333	300	25
28	18	1	333	9	0.333	300	17
29	18	1	333	9	0.333	300	16
30	18	1	333	9	0.333	300	14

6.5 OPERATION MODES AND REQUIREMENT TEST ITEMS

The manufacture shall state whether the EUT is capable of operating as a Master or a Slave modes,if the EUT is capable of operating in more than one operational mode then every operating mode shall be assessed separately.

Applicability of DFS Requirements Prior to Use of a Channel

Requirement	Operational Mode		
	Master	Client Without Radar Detection	Client With Radar Detection
Non-Occupancy Period	Yes	Not required	Yes
DFS Detection Threshold	Yes	Not required	Yes
Channel Availability Check Time	Yes	Not required	Not required
Uniform Spreading	Yes	Not required	Not required
U-NII Detection Bandwidth	Yes	Not required	Yes

Applicability of DFS requirements during normal operation

Requirement	Operational Mode		
	Master	Client Without Radar Detection	Client With Radar Detection
DFS Detection Threshold	Yes	Not required	Yes
Channel Closing Transmission Time	Yes	Yes	Yes
Channel Move Time	Yes	Yes	Yes
U-NII Detection Bandwidth	Yes	Not required	Yes

6.6 TEST PROCEDURE

According to KDB 905462 D02v02 Section 7.

7 TEST RESULT

7.1 DFS DETECTION THRESHOLD

Temperature : 25°C ATM Pressure:: 1011 mbar
 Humidity : 45% Test Engineer: GJ

NOTE: All the modes are tested, the data of the worst WIFI mode are described in the table.

TestMode	Frequency[dbm]	Radar Type	Result	Limit[dbm]	Verdict
11A	5260	Type0	-44.37	-43.98	PASS
		Type1	-44.40	-43.98	PASS
		Type2	-44.30	-43.98	PASS
		Type3	-44.31	-43.98	PASS
		Type4	-44.33	-43.98	PASS
		Type5	-44.34	-43.98	PASS
		Type6	-44.04	-43.98	PASS
	5500	Type0	-43.49	-43.23	PASS
		Type1	-43.46	-43.23	PASS
		Type2	-43.43	-43.23	PASS
		Type3	-43.44	-43.23	PASS
		Type4	-43.48	-43.23	PASS
		Type5	-43.44	-43.23	PASS
		Type6	-43.64	-43.23	PASS
11N40MIMO	5270	Type0	-44.22	-43.98	PASS
		Type1	-44.27	-43.98	PASS
		Type2	-44.20	-43.98	PASS
		Type3	-44.21	-43.98	PASS
		Type4	-44.22	-43.98	PASS
		Type5	-44.18	-43.98	PASS
		Type6	-43.98	-43.98	PASS
	5510	Type0	-43.57	-43.23	PASS
		Type1	-43.61	-43.23	PASS
		Type2	-43.61	-43.23	PASS
		Type3	-43.55	-43.23	PASS
		Type4	-43.53	-43.23	PASS
		Type5	-43.59	-43.23	PASS
		Type6	-43.34	-43.23	PASS
11AC80MIMO	5530	Type0	-43.48	-43.23	PASS
		Type1	-43.59	-43.23	PASS
		Type2	-43.54	-43.23	PASS
		Type3	-43.46	-43.23	PASS
		Type4	-43.49	-43.23	PASS
		Type5	-43.49	-43.23	PASS
		Type6	-43.47	-43.23	PASS

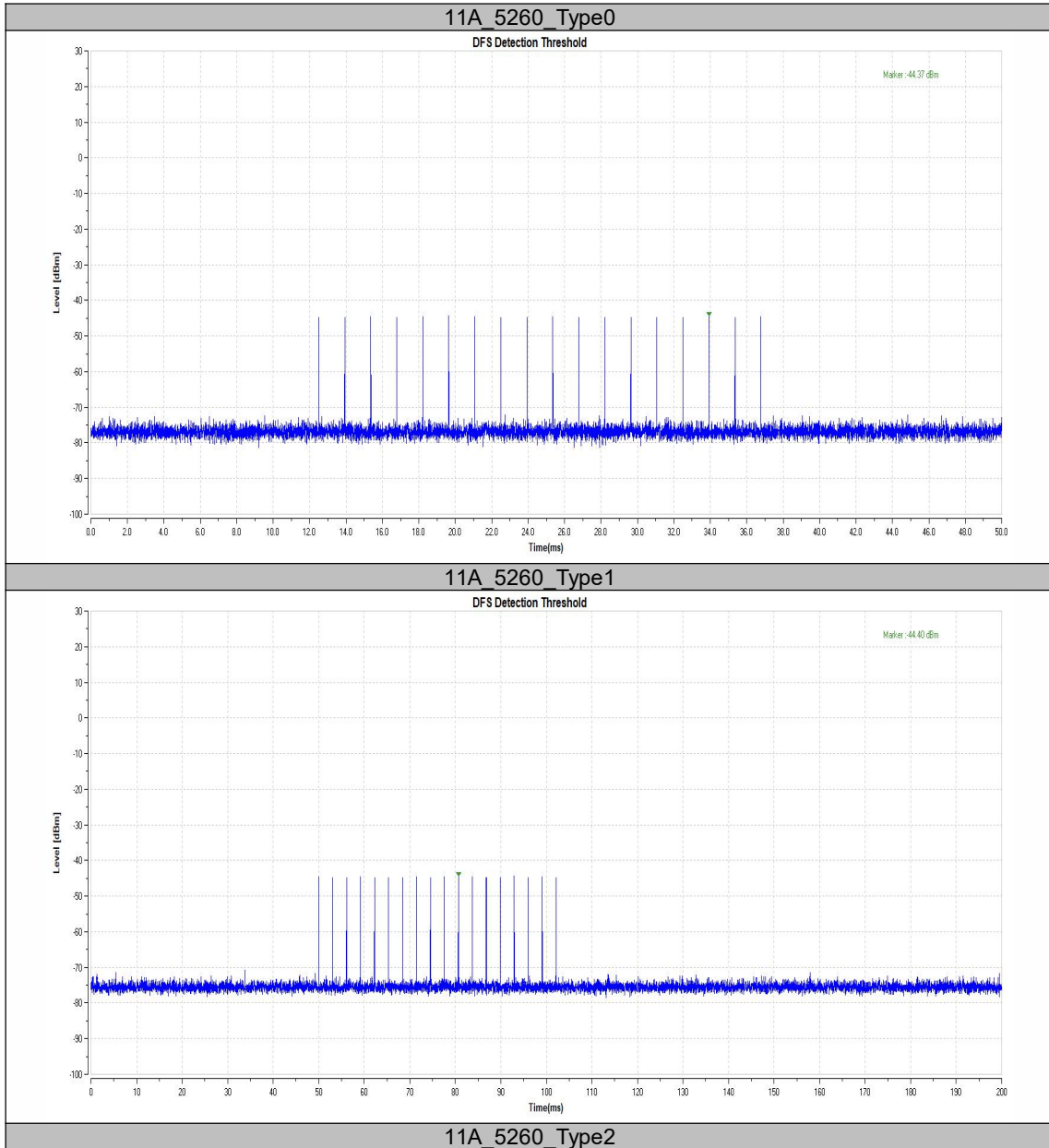

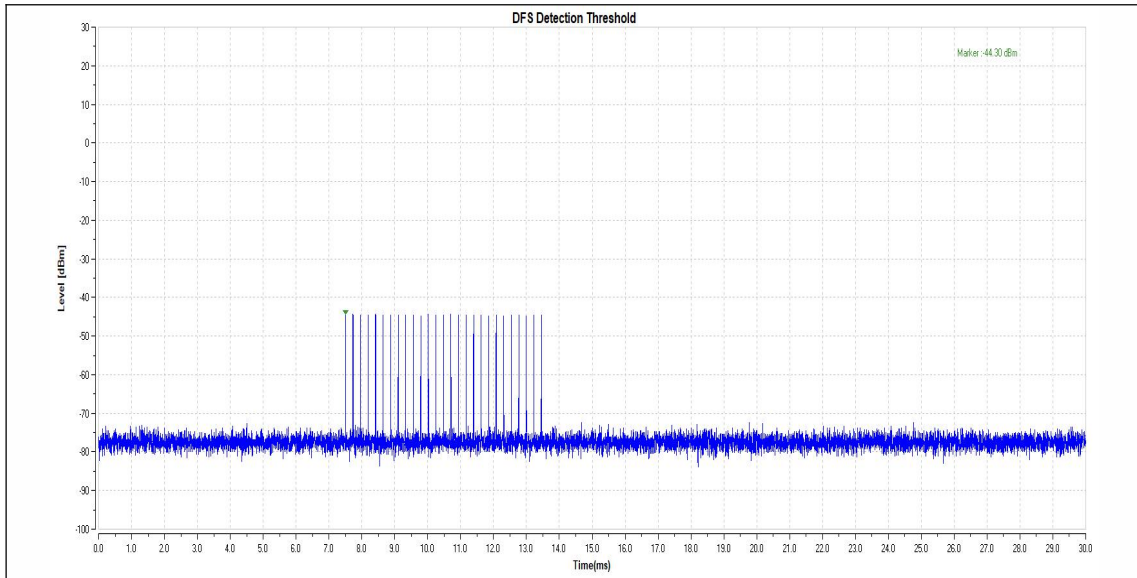

11A_5260_Type3

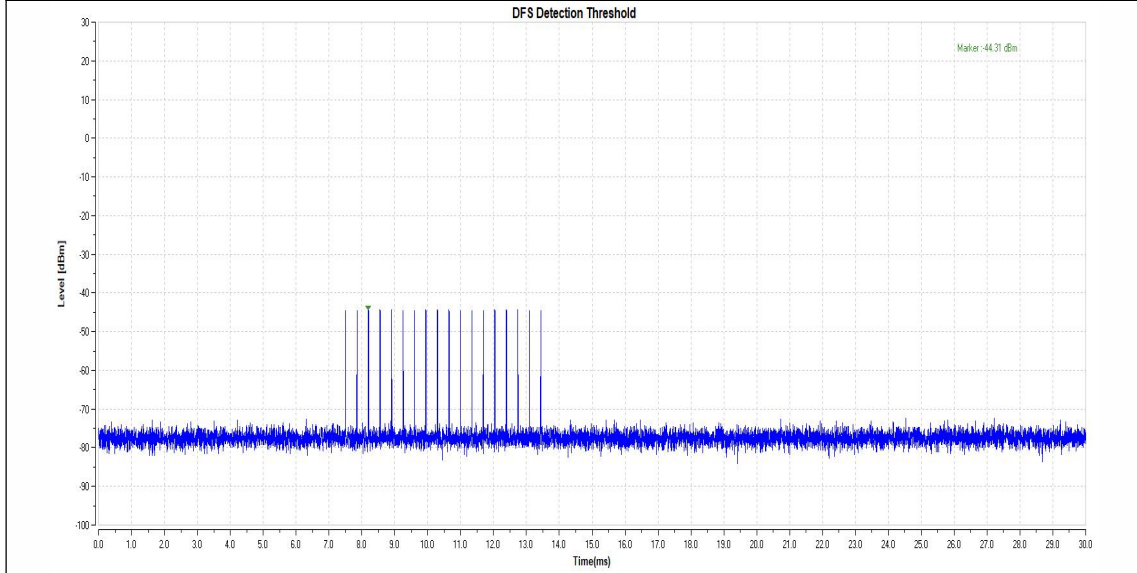

11A_5260_Type4

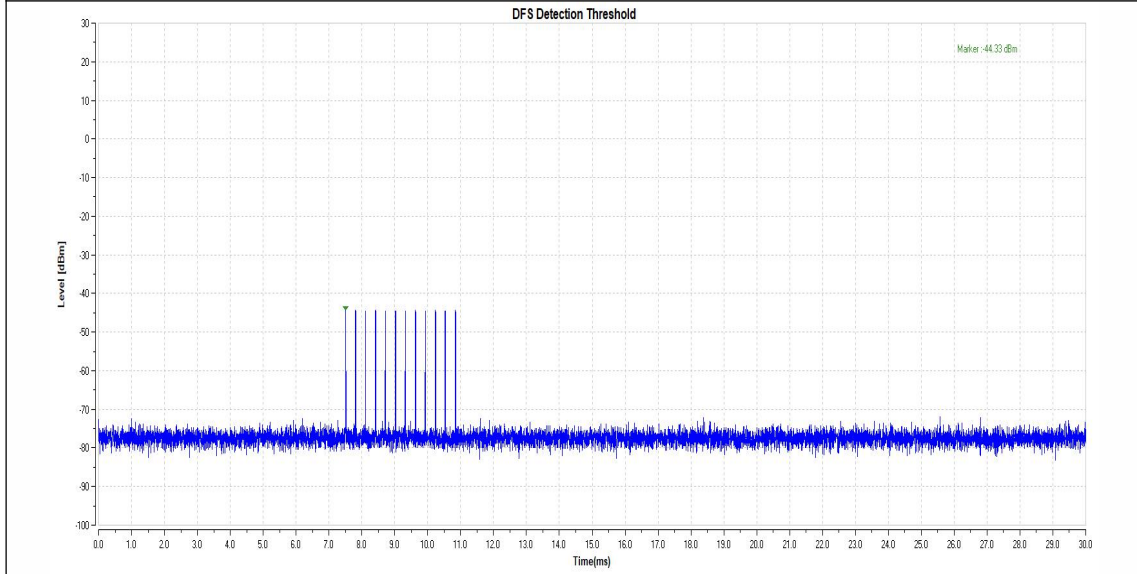

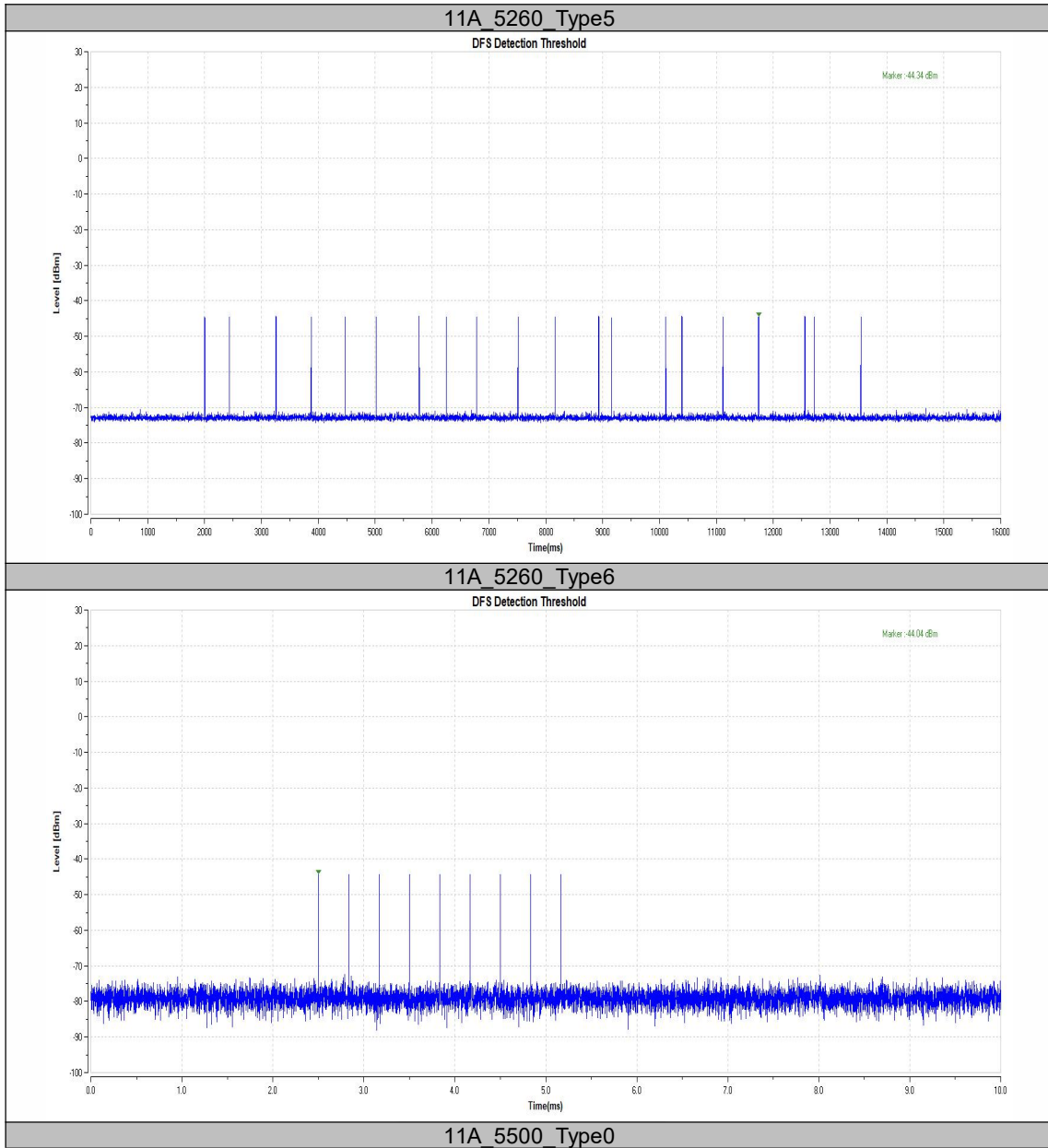

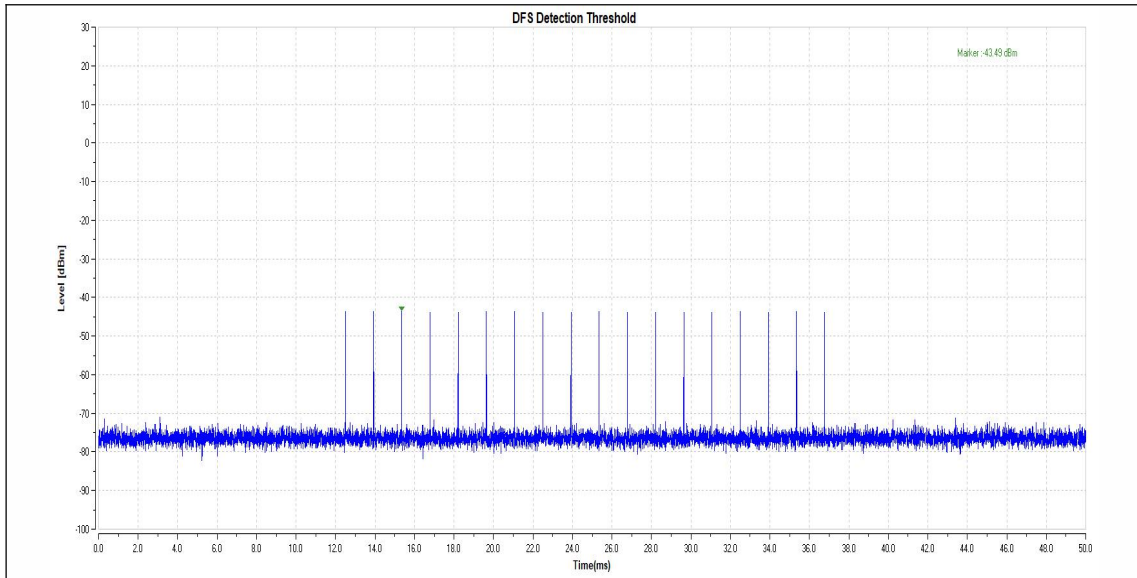

11A_5500_Type1

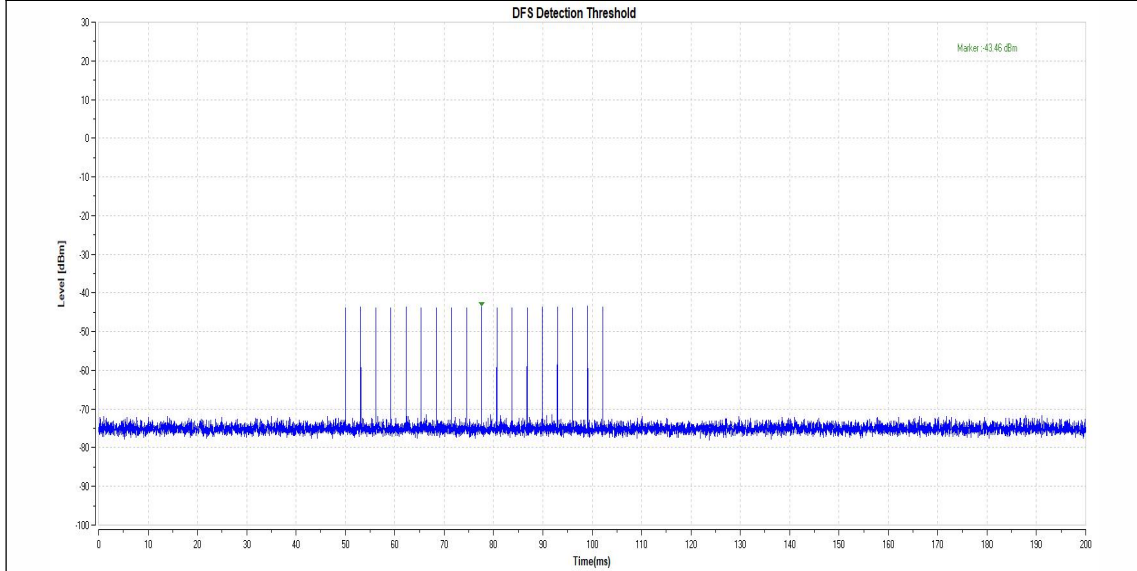

11A_5500_Type2

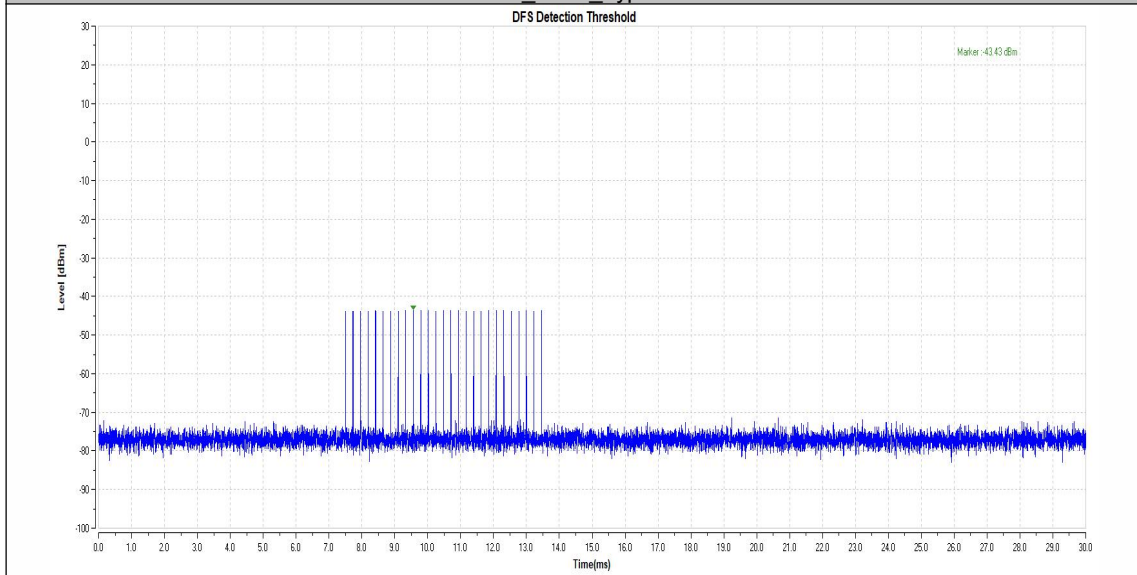

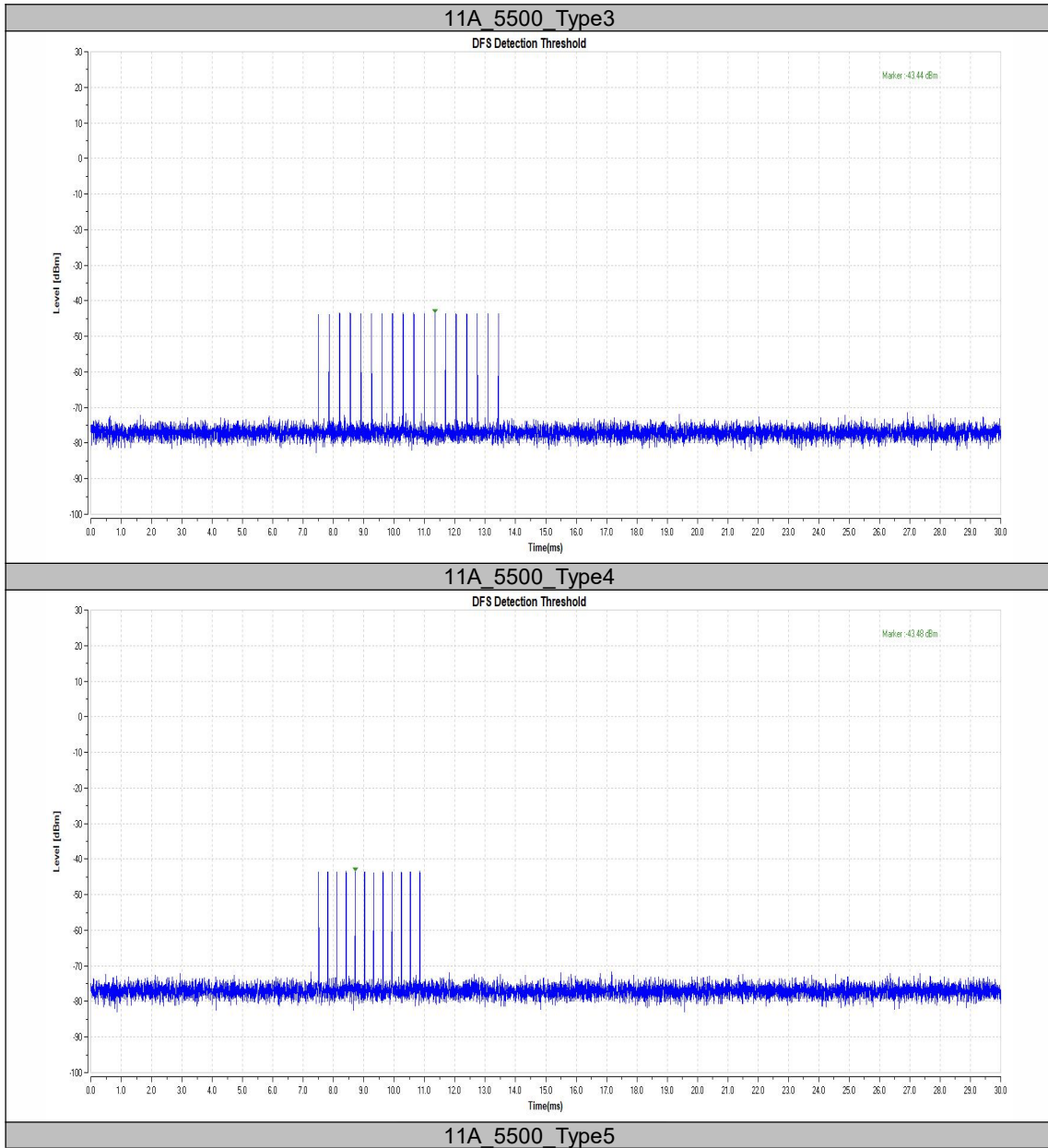

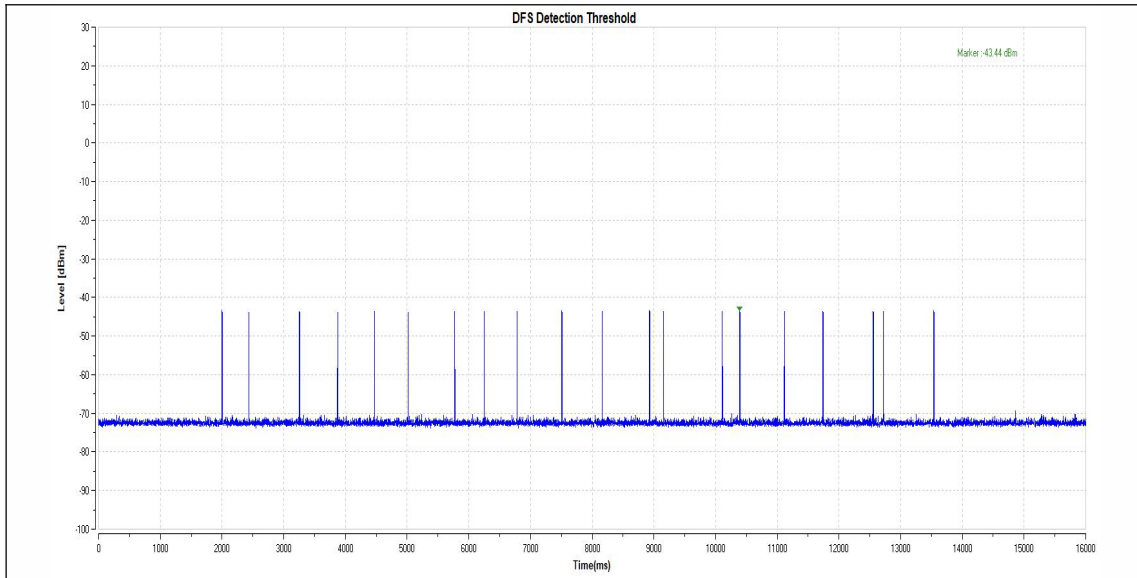

11A_5500_Type6

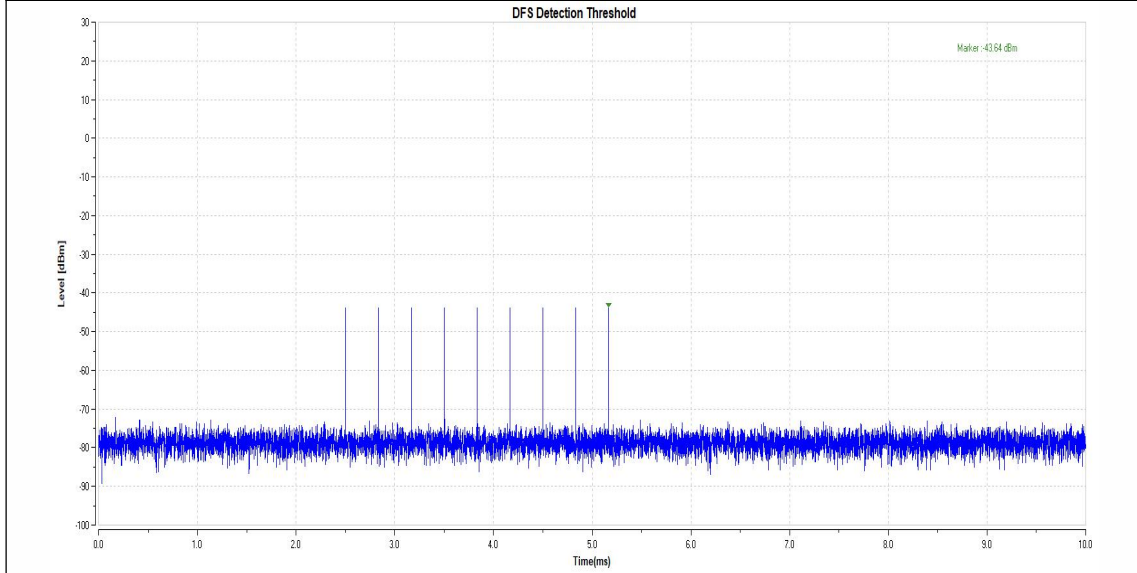

11N40MIMO_5270_Type0

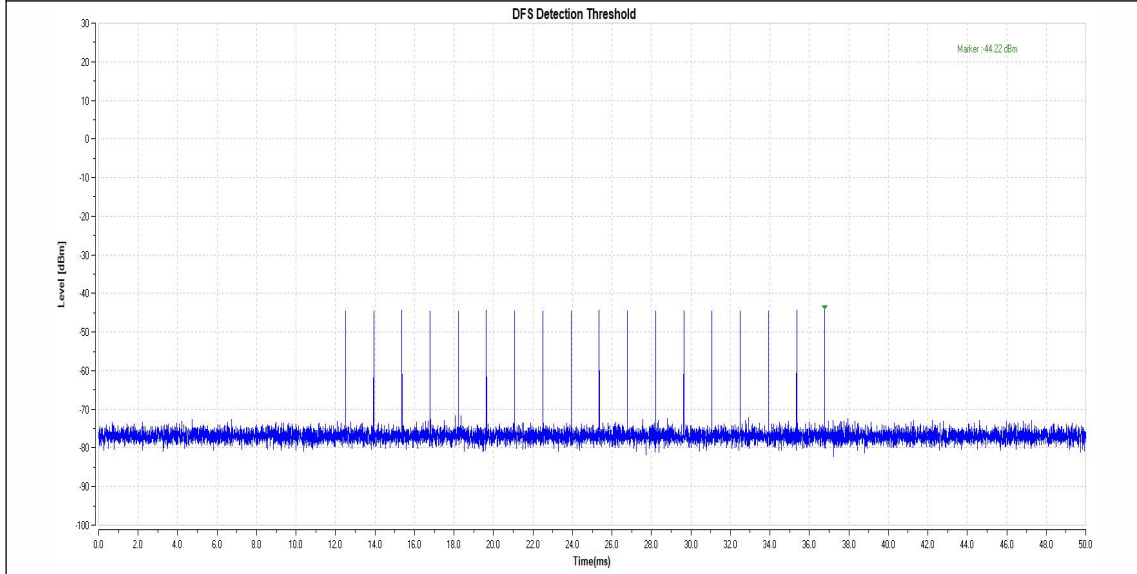

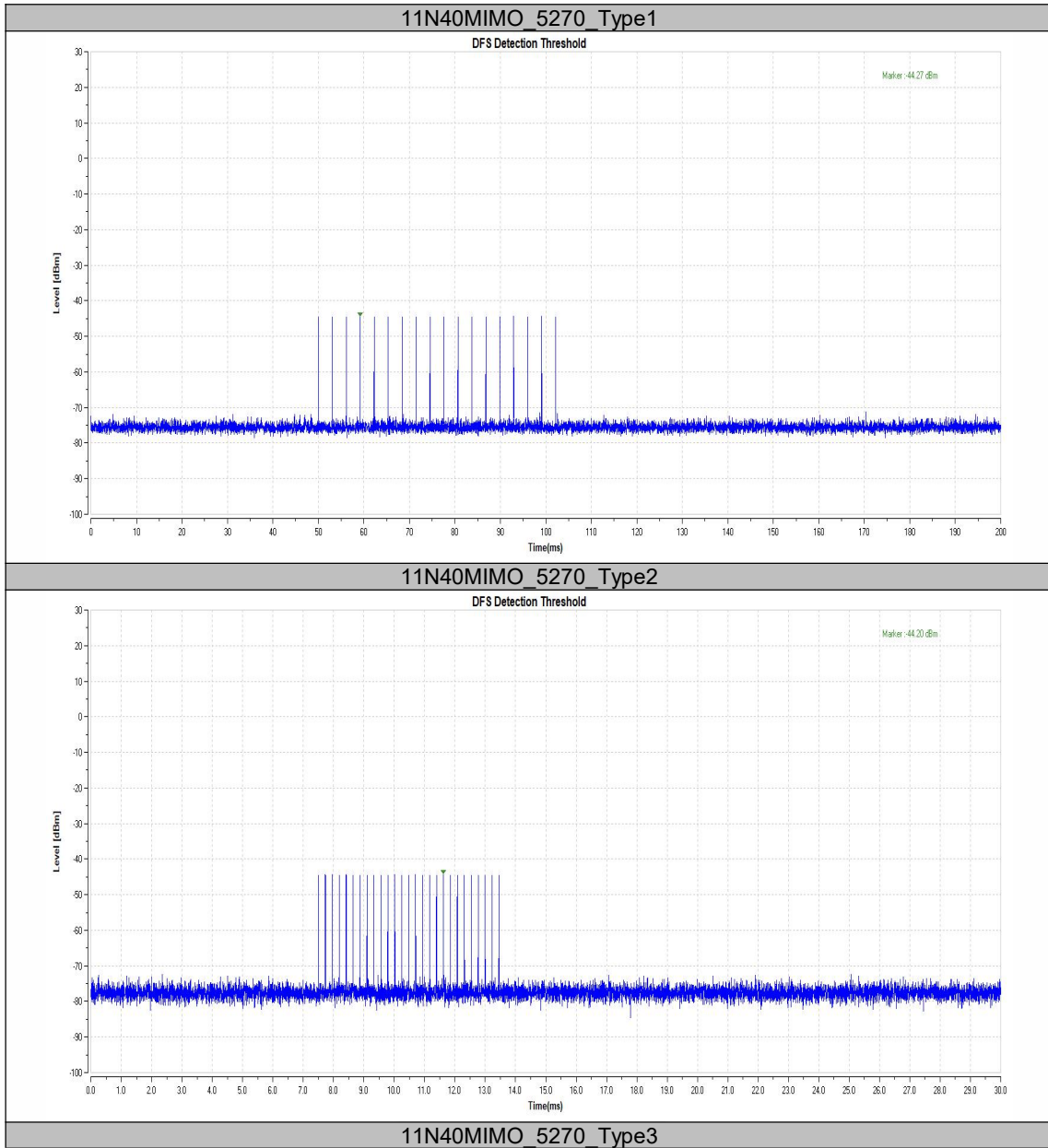

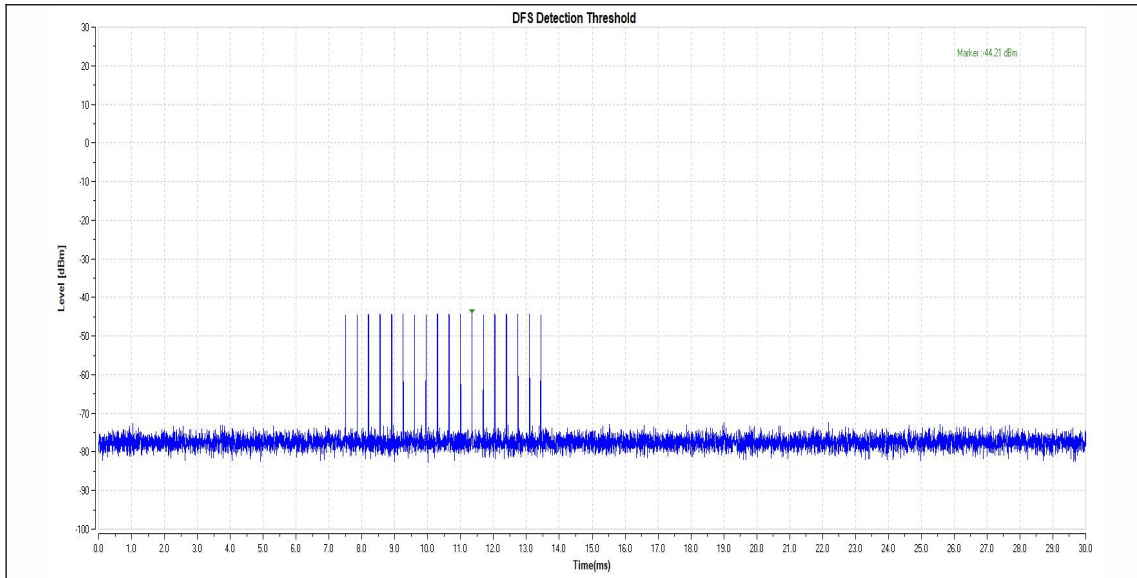

11N40MIMO_5270_Type4

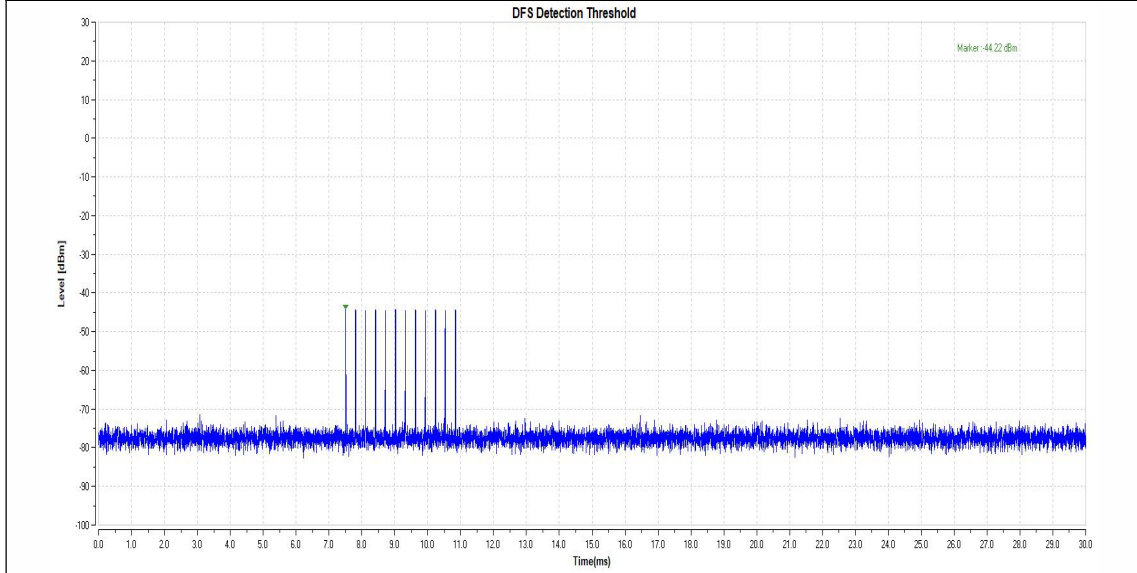

11N40MIMO_5270_Type5

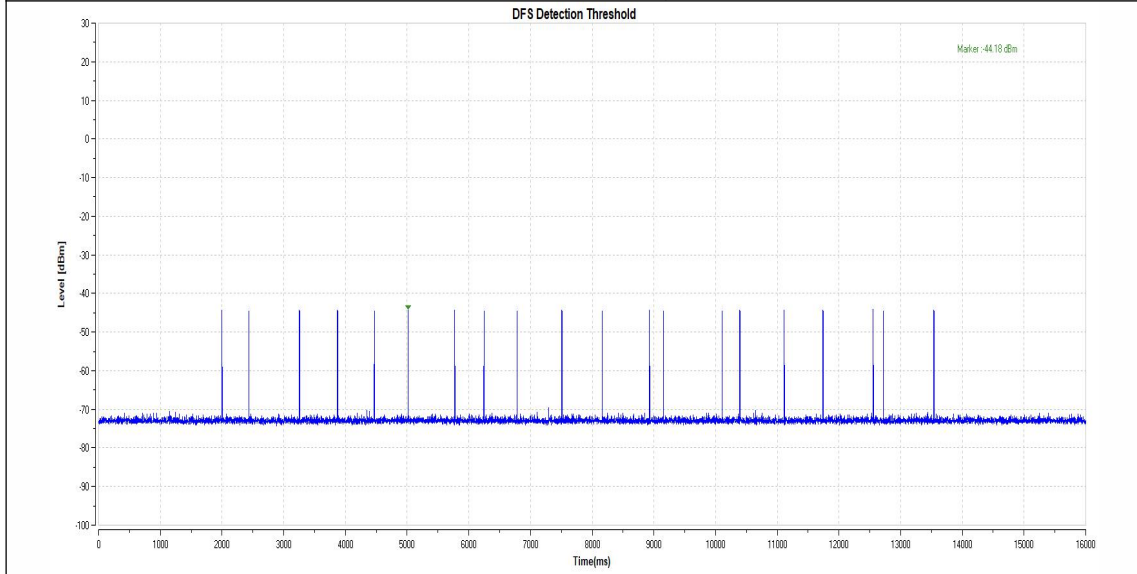

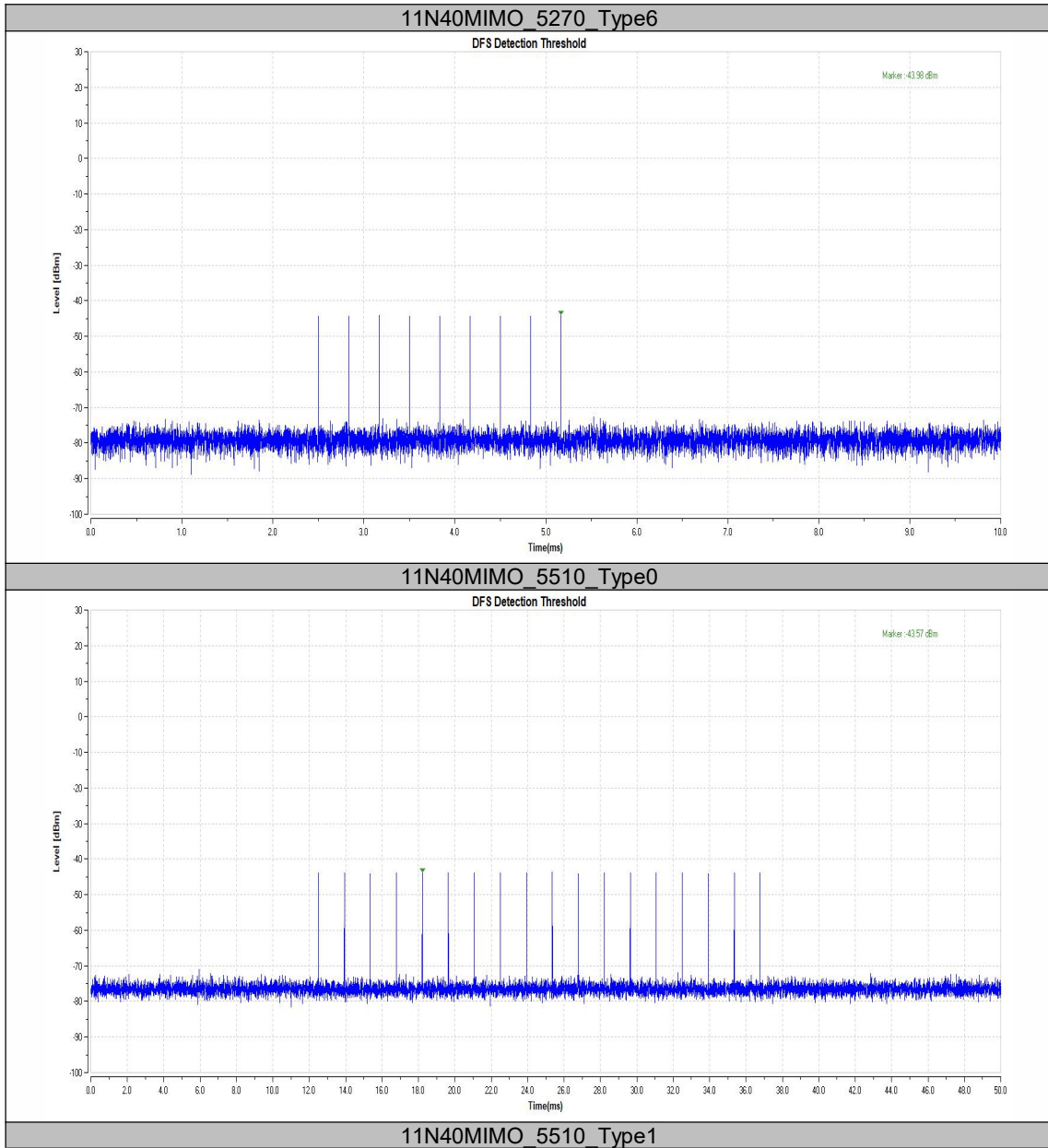

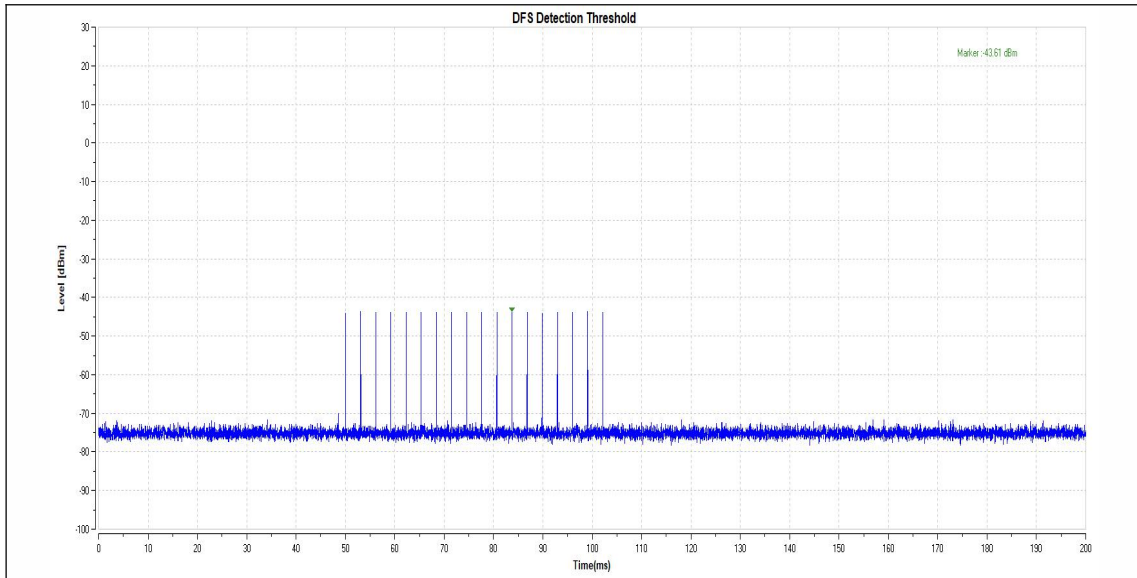

11N40MIMO_5510_Type2

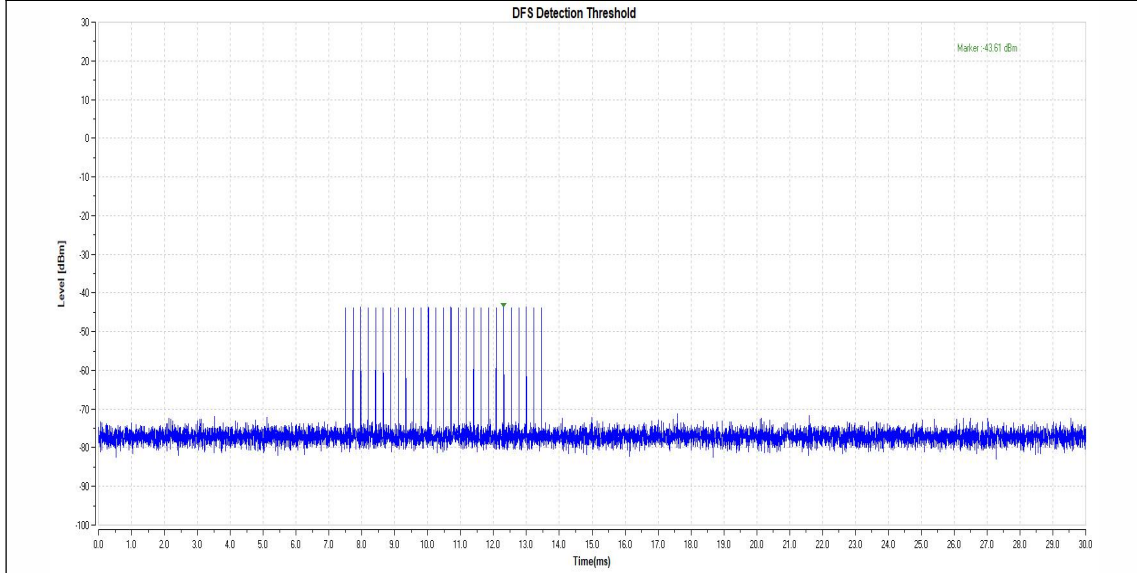

11N40MIMO_5510_Type3

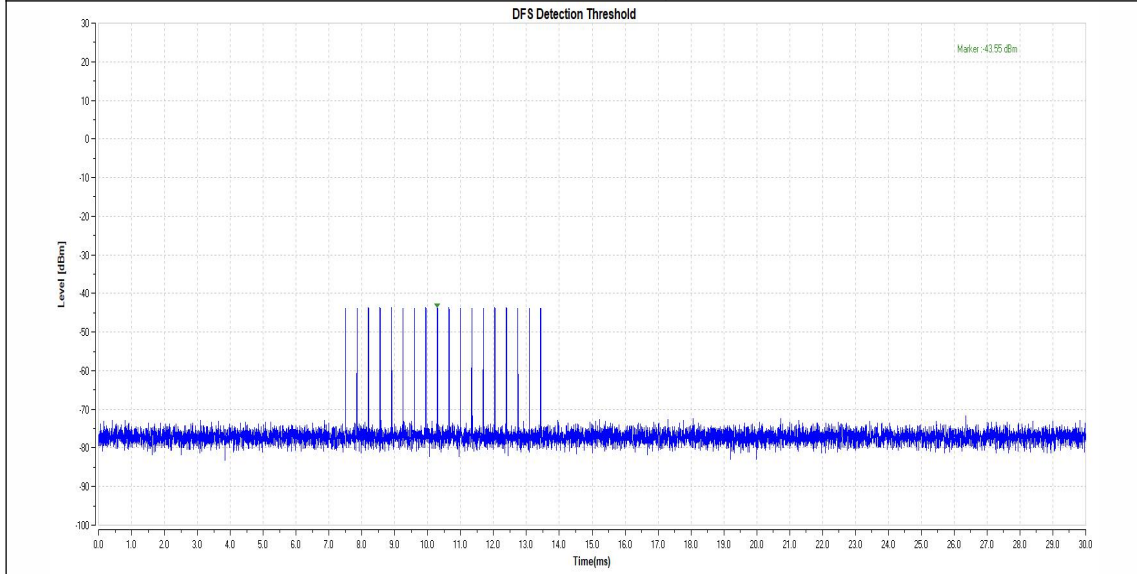

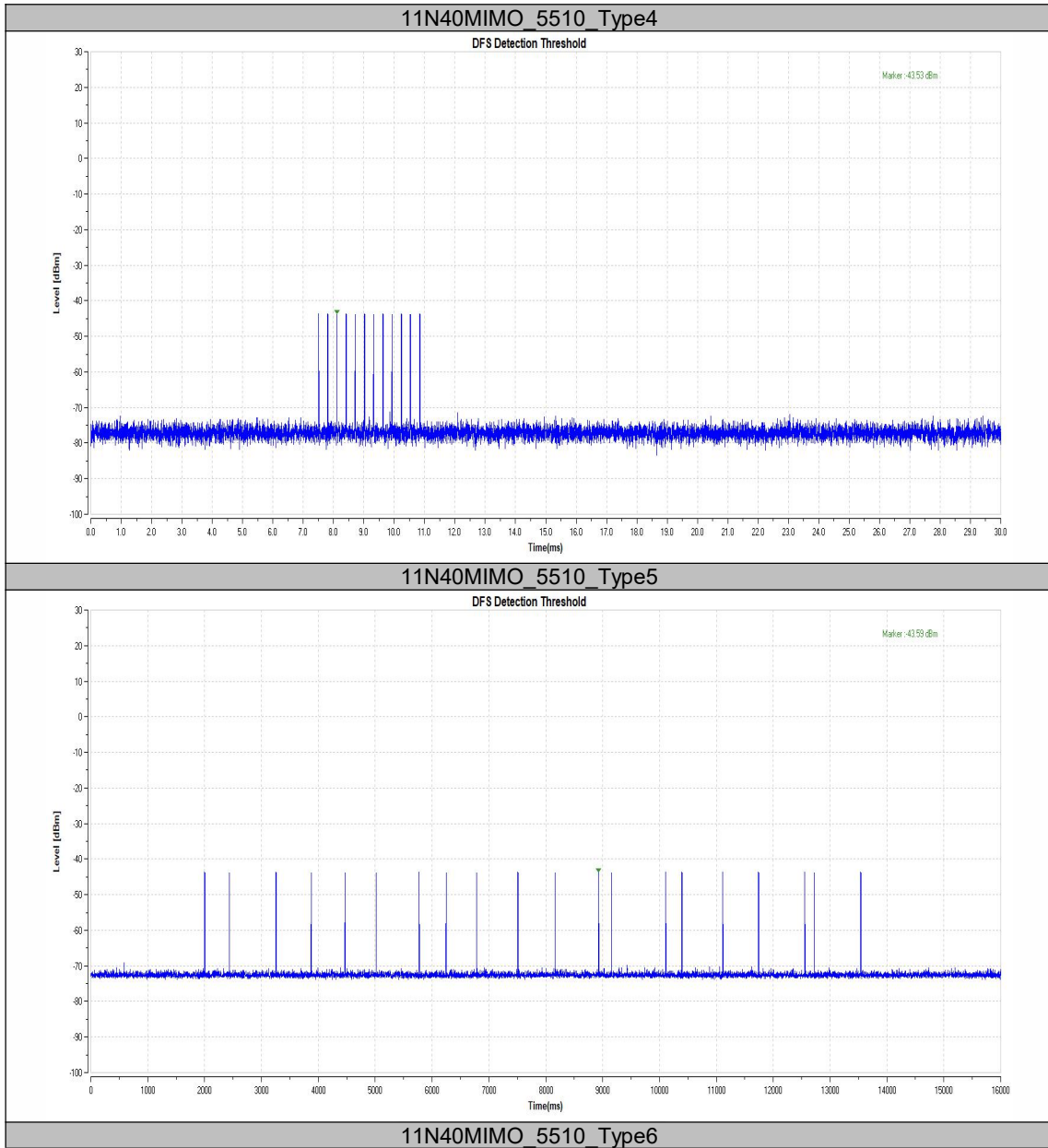

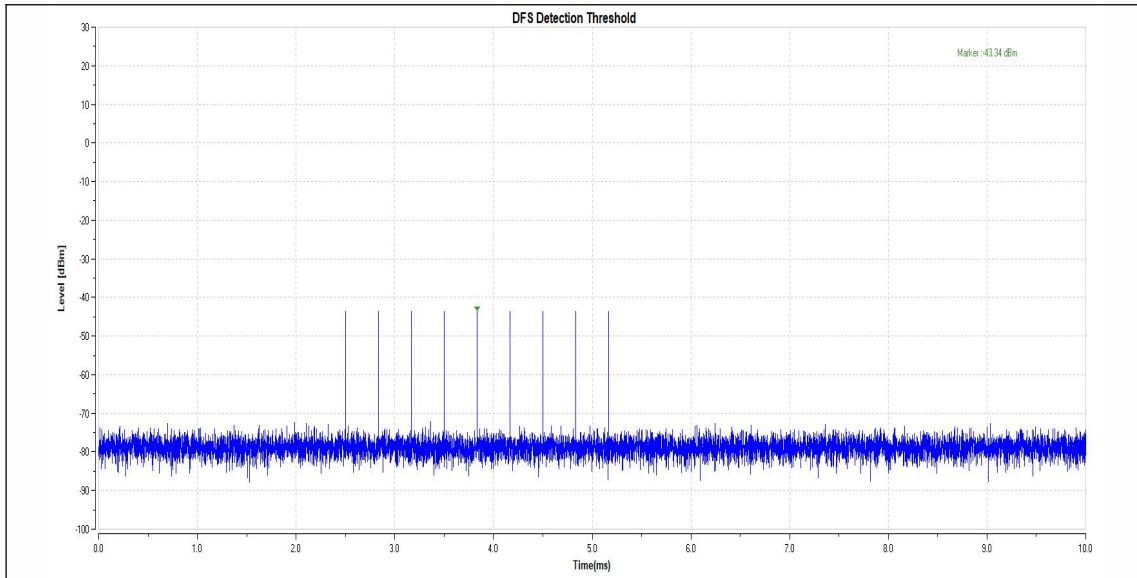

11AC80MIMO_5530_Type0

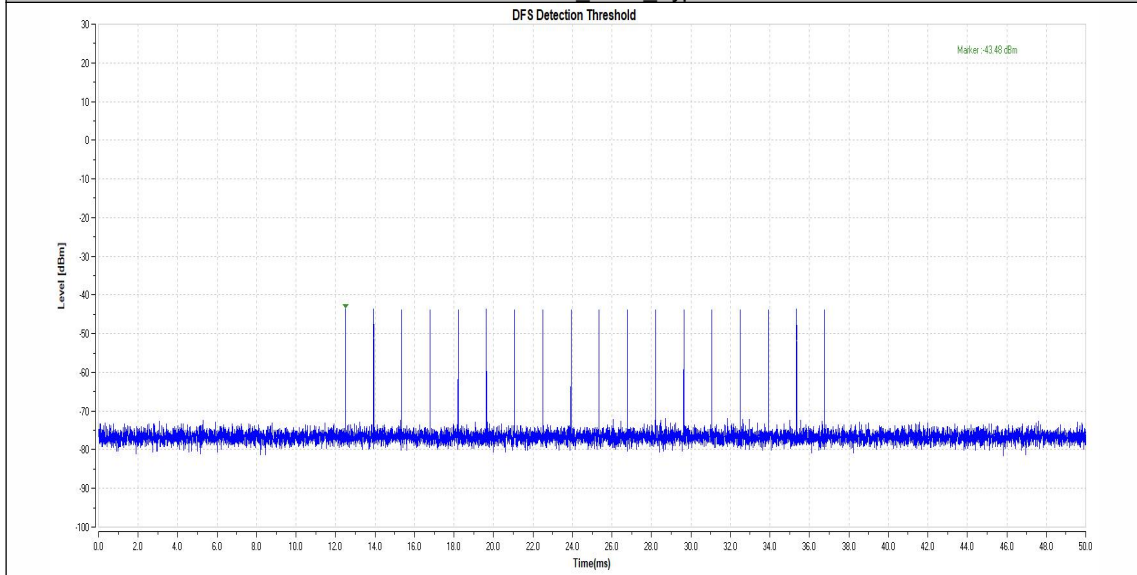

11AC80MIMO_5530_Type1

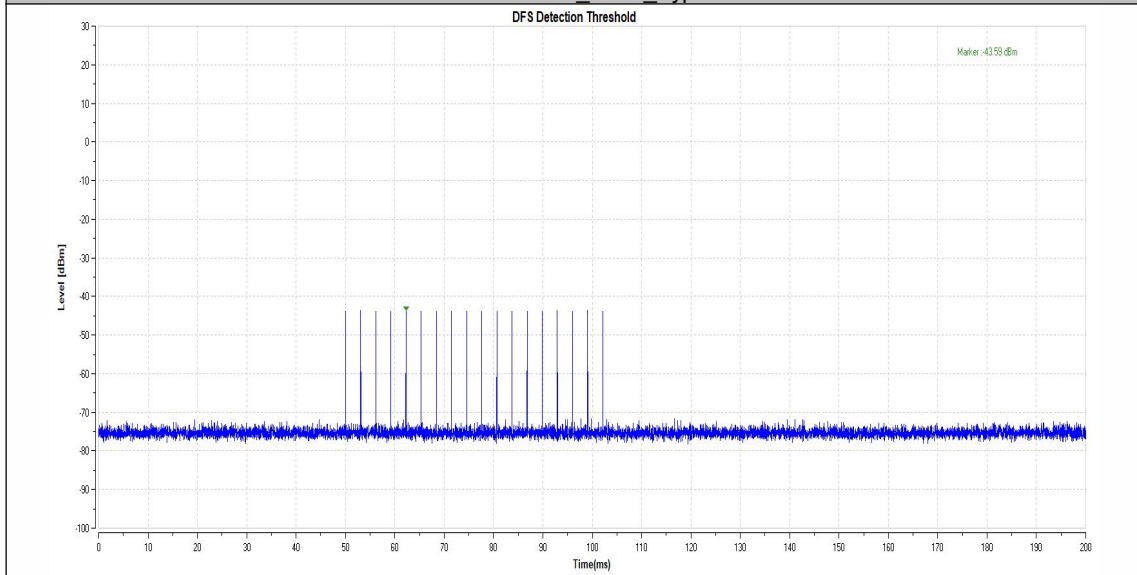

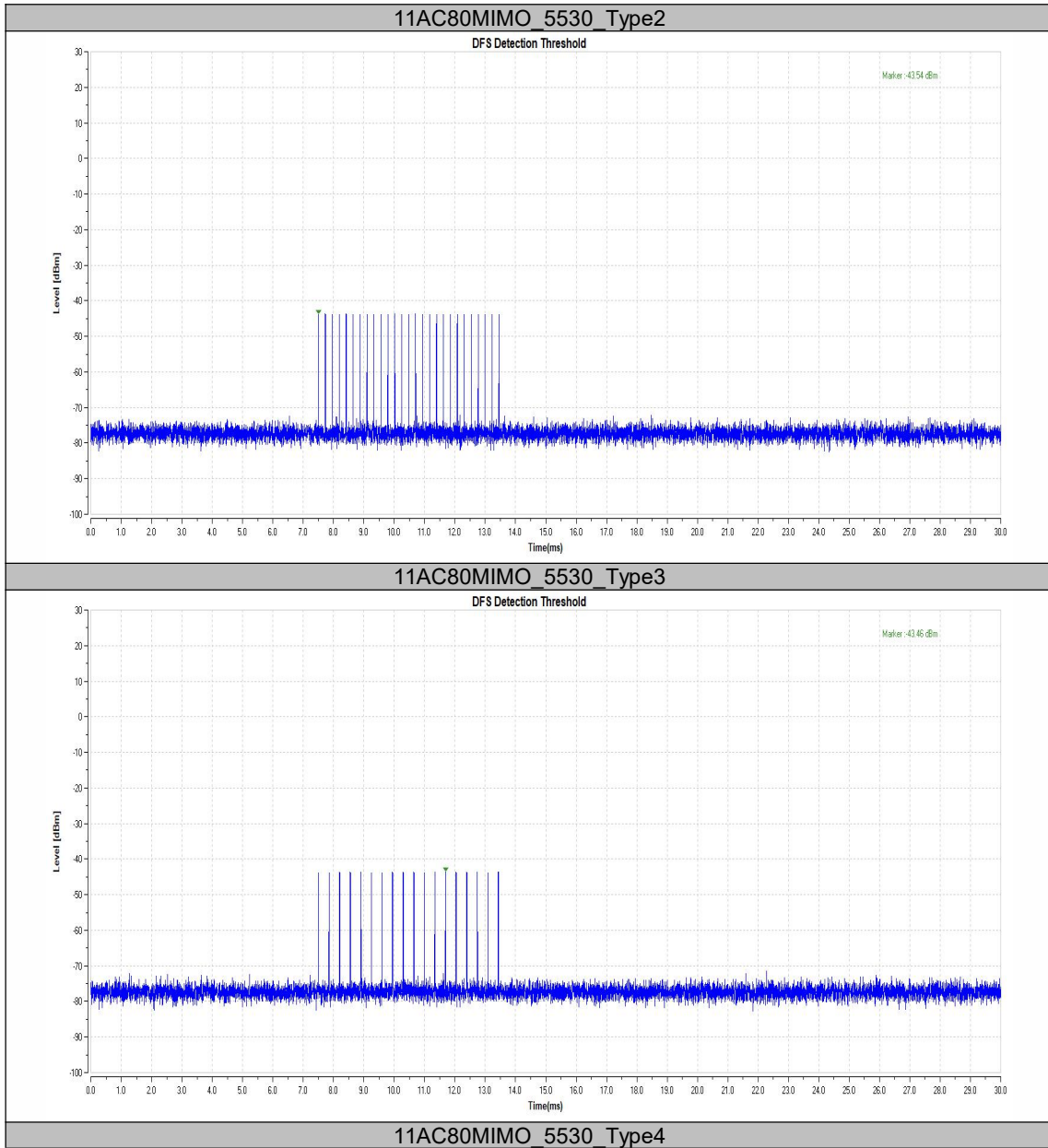

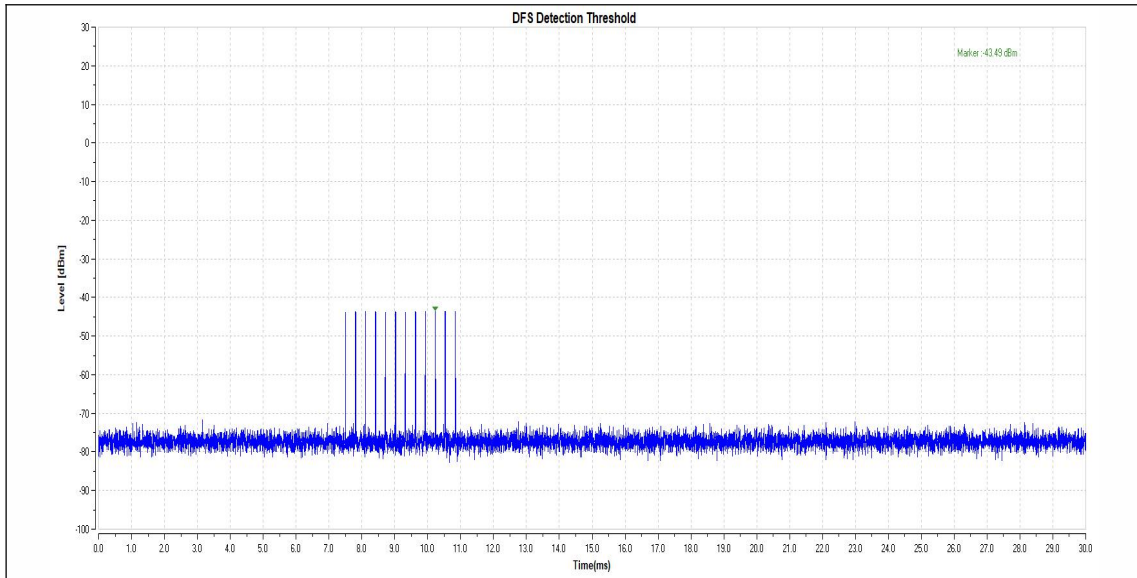

11AC80MIMO_5530_Type5

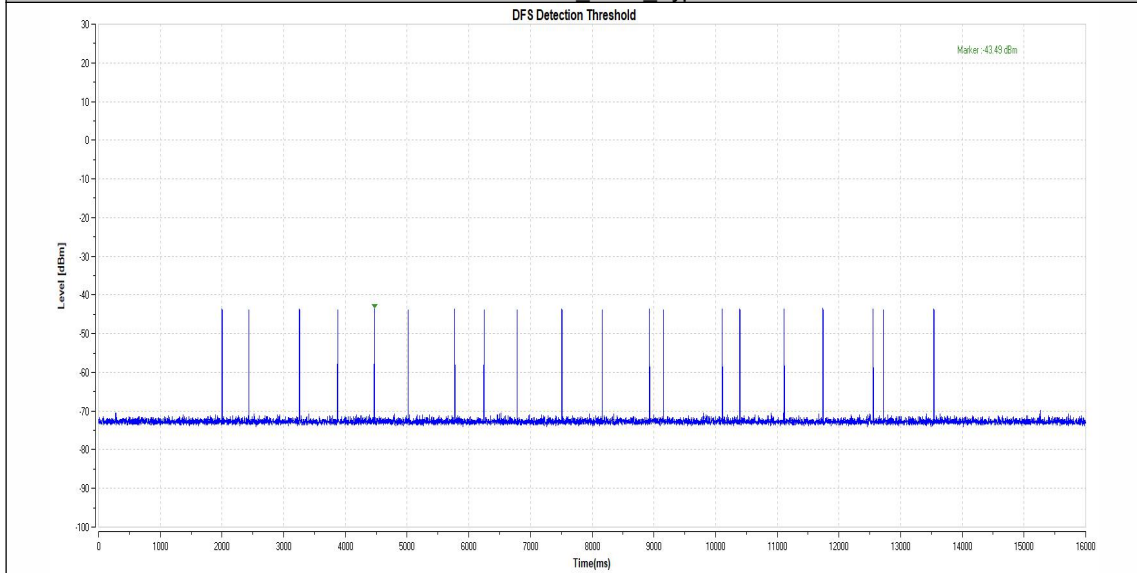

11AC80MIMO_5530_Type6

