

# TEST REPORT

**Product Name** : Wireless Bridge  
**Model Number** : RG-AirMetro550G-B  
**FCC ID** : 2AX5J-AM550GB

**Prepared for** : Ruijie Networks Co., Ltd.  
**Address** : Building 19, Juyuanzhou Industrial Park, No.618 Jinshan Road, Cangshan District, Fuzhou, Fujian, China

**Prepared by** : EMTEK (SHENZHEN) CO., LTD.  
**Address** : Bldg 69, Majialong Industry Zone, Nanshan District, Shenzhen, Guangdong, China

Tel: (0755) 26954280  
Fax: (0755) 26954282

**Report Number** : ENS2406250044W00102R  
**Date(s) of Tests** : September 9, 2024 to October 10, 2024  
**Date of Issue** : October 12, 2024

# TABLE OF CONTENTS

<b>1 TEST RESULT CERTIFICATION.....</b>	<b>4</b>
<b>2 EUT TECHNICAL DESCRIPTION.....</b>	<b>5</b>
<b>3 SUMMARY OF TEST RESULT.....</b>	<b>7</b>
<b>4 TEST METHODOLOGY.....</b>	<b>8</b>
4.1 GENERAL DESCRIPTION OF APPLIED STANDARDS.....	8
4.2 MEASUREMENT EQUIPMENT USED.....	8
4.3 DESCRIPTION OF TEST MODES.....	9
<b>5 FACILITIES AND ACCREDITATIONS.....</b>	<b>14</b>
5.1 EQUIPMENT.....	14
5.2 DESCRIPTION OF TEST FACILITY.....	14
<b>6 TEST SYSTEM UNCERTAINTY.....</b>	<b>15</b>
<b>7 SETUP OF EQUIPMENT UNDER TEST.....</b>	<b>16</b>
7.1 RADIO FREQUENCY TEST SETUP.....	16
7.2 RADIO FREQUENCY TEST SETUP.....	16
7.3 CONDUCTED EMISSION TEST SETUP.....	18
7.4 BLOCK DIAGRAM CONFIGURATION OF TEST SYSTEM.....	19
7.5 SUPPORT EQUIPMENT.....	19
<b>8 TEST REQUIREMENTS.....</b>	<b>20</b>
8.1 BANDWIDTH MEASUREMENT.....	20
8.2 MAXIMUM CONDUCTED OUTPUT POWER.....	99
8.3 MAXIMUM PEAK POWER DENSITY.....	294
8.4 UNDESIRABLE RADIATED SPURIOUS EMISSION.....	359
8.5 POWER LINE CONDUCTED EMISSIONS.....	396
8.6 ANTENNA APPLICATION.....	399

## Modified Information

Version	Report No.	Revision Date	Summary
Ver.1.0	ENS2406250044W00102R	/	Original Report

# 1 TEST RESULT CERTIFICATION

Applicant : Ruijie Networks Co., Ltd.  
 Address : Building 19,Juyuanzhou Industrial Park, No.618 Jinshan Road, CangshanDistrict,Fuzhou,Fujian, China  
 Manufacturer : Ruijie Networks Co., Ltd.  
 Address : Building 19,Juyuanzhou Industrial Park, No.618 Jinshan Road, CangshanDistrict,Fuzhou,Fujian, China  
 EUT : Wireless Bridge  
 Model Name : RG-AirMetro550G-B  
 Trademark : 

**Measurement Procedure Used:**

APPLICABLE STANDARDS	
STANDARD	TEST RESULT
FCC 47 CFR Part 2, Subpart J FCC 47 CFR Part 15, Subpart E	<b>PASS</b>

The above equipment was tested by EMTEK (SHENZHEN) CO., LTD. The test data, data evaluation, test procedures, and equipment configurations shown in this report were made in accordance with the procedures given in ANSI C63.10 (2013) and the energy emitted by the sample EUT tested as described in this report is in compliance with the above table standards requirement.

The test results of this report relate only to the tested sample identified in this report.

Date of Test : September 9, 2024 to October 10, 2024

Prepared by :   
 Una Yu/Editor

Reviewer :   
 Joe Xia/Supervisor

Approved & Authorized Signer :   
 Lisa Wang/Manager

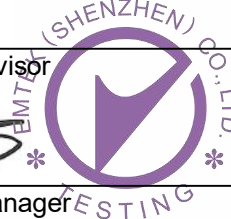

## 2 EUT TECHNICAL DESCRIPTION

<b>Product Name:</b>	Wireless Bridge
<b>Model Number:</b>	RG-AirMetro550G-B
<b>WIFI Type:</b>	UNII-1: 5150MHz-5250MHz Band UNII-2A: 5250MHz-5350MHz Band UNII-2C: 5470MHz-5725MHz Band UNII-3: 5725MHz-5850MHz Band
<b>WLAN Supported:</b>	IEEE 802.11a IEEE 802.11n(20MHz channel bandwidth) IEEE 802.11n(40MHz channel bandwidth) IEEE 802.11ac(20MHz channel bandwidth) IEEE 802.11ac(40MHz channel bandwidth) IEEE 802.11ac(80MHz channel bandwidth)
<b>Frequency Range:</b>	5150MHz-5250MHz Band: 5180-5240MHz for 802.11a 5180-5240MHz for 802.11n(20) 5190-5230MHz for 802.11n(40) 5180-5240MHz for 802.11ac(20) 5190-5230MHz for 802.11ac(40) 5210MHz for 802.11ac(80)
	5250MHz-5350MHz Band: 5260-5320MHz for 802.11a 5260-5320MHz for 802.11n(20) 5270-5310MHz for 802.11n(40) 5260-5320MHz for 802.11ac(20) 5270-5310MHz for 802.11ac(40) 5290MHz for 802.11ac(80)
	5470MHz-5725MHz Band: 5500-5700MHz for 802.11a 5500-5700MHz for 802.11n(20) 5510-5670MHz for 802.11n(40) 5500-5700MHz for 802.11ac(20) 5510-5670MHz for 802.11ac(40) 5530-5610MHz for 802.11ac(80)
	5725MHz-5850MHz Band: 5745-5825MHz for 802.11a 5745-5825MHz for 802.11n(20) 5755-5795MHz for 802.11n(40) 5745-5825MHz for 802.11ac(20) 5755-5795MHz for 802.11ac(40) 5775MHz for 802.11ac(80)
<b>Modulation:</b>	OFDM
<b>TPC Function:</b>	Support
<b>Beamforming:</b>	Not Support

<b>DFS Function:</b>	Master
<b>Antenna Type:</b>	External Antenna
<b>Antenna Gain:</b>	<p>RG-ANT20S-90 Antenna:            B1: 5150-5250MHz: Ant1: 17.78dBi, Ant2: 17.31dBi            B2: 5250-5350MHz: Ant1: 18.02dBi, Ant2: 17.57dBi            B3: 5470-5725MHz: Ant1: 18.77dBi, Ant2: 18.25dBi            B4: 5725-5850MHz: Ant1: 18.98dBi, Ant2: 18.31dBi</p> <p>RG-ANT13-360 Antenna:            B1: 5150-5250MHz: Ant1: 11.96dBi, Ant2: 10.44dBi            B2: 5250-5350MHz: Ant1: 11.96dBi, Ant2: 10.42dBi            B3: 5470-5725MHz: Ant1: 12.07dBi, Ant2: 10.79dBi            B4: 5725-5850MHz: Ant1: 12.22dBi, Ant2: 10.89dBi</p> <p>(Note1: The EUT has two 5G WIFI antennas, RG-ANT20S-90 and RG-ANT13-360 antenna, Pre testing all antennas, and find the RG-ANT20S-90 antenna is the worst, so only the worst data is shown in the report.)            (Note2: The antenna information is provided by the customers, which will have a certain impact on the test results.)</p>
<b>Smart System:</b>	MIMO
<b>Power Supply:</b>	<p>DC: 12.0Vdc 1.0A or POE: 24Vdc 0.5A            POE Information:            Model: RP023-2400500ZG            Input: 100-240V~50/60Hz, 0.5A Max            Output: 24V, 0.5A, 12W</p> <p>(Note: The EUT has two power supplies, Pre testing all power supplies, and find the POE is the worst, so only the worst data is shown in the report.)</p>
<b>Temperature Range:</b>	<p>-40°C~80°C            (Note: When a power adapter is used, the maximum operating temperature for both the device and the power adapter is 60°C (140°F).)</p>

Note: for more details, please refer to the user's manual of the EUT.

### 3 SUMMARY OF TEST RESULT

FCC Part Clause	Test Parameter	Verdict	Remark
15.407 (a) 15.407 (e)	99% , 6dB and 26dB Bandwidth	PASS	
15.407 (a)	Maximum Conducted Output Power	PASS	
15.407 (a)	Peak Power Spectral Density	PASS	
15.407 (b)	Radiated Spurious Emission	PASS	
15.407 (b)(6) 15.207	Power Line Conducted Emission	PASS	
15.407(a) 15.203	Antenna Application	PASS	

NOTE1: The results of this report do not take into account the uncertainty.

NOTE2: According to FCC OET KDB 789033 D2 General UNII Test Procedures New Rules v02r01, In addition, the radiated test is also performed to ensure the emissions emanating from the device cabinet also comply with the applicable limits.

#### RELATED SUBMITTAL(S) / GRANT(S):

This submittal(s) (test report) is filing to comply with the above table standards requirement.

## 4 TEST METHODOLOGY

### 4.1 GENERAL DESCRIPTION OF APPLIED STANDARDS

According to its specifications, the EUT must comply with the requirements of the following standards:

FCC 47 CFR Part 2, Subpart J

FCC 47 CFR Part 15, Subpart E

FCC KDB 789033 D2 General UNII Test Procedures New Rules v02r01

### 4.2 MEASUREMENT EQUIPMENT USED

#### For Conducted Emission Test

Equipment	Manufacturer	Model No.	Serial No.	Last Cal.	Cal. Interval
EMI Test Receiver	Rohde & Schwarz	ESCI	101384	2024/5/11	1Year
AMN	Rohde & Schwarz	ENV216	101161	2024/5/10	1Year

#### For Spurious Emissions Test

Equipment	Manufacturer	Model No.	Serial No.	Last Cal.	Cal. Interval
Pre-Amplifier	Bonn	BLMA 011001N	2213967A	2023/10/23	1Year
EMI Test Receiver	Rohde & Schwarz	ESR7	102551	2023/10/23	1Year
Bilog Antenna	Schwarzbeck	VULB9163	9163142	2024/7/8	2Year
Horn antenna	Schwarzbeck	BBHA9120D	9120D-1198	2023/6/2	2Year
Pre-Amplifier	Bonn	BLMA 0118-5G	2213967B-01	2023/10/23	1Year
Spectrum Analyzer	Rohde & Schwarz	FSV3044	101290	2023/10/23	1Year
Horn antenna	Schwarzbeck	BBHA9170	9170-399	2023/5/12	2Year
Pre-Amplifier	Lunar EM	LNA18G26-40	J1012131010 001	2024/5/11	1Year
Pre-Amplifier	Lunar EM	LNA26G40-40	J1013131028 001	2024/5/11	1Year
Loop Antenna	Schwarzbeck	FMZB1519	1519-012	2023/5/12	2Year
Wideband Radio Communication Tester	R&S	CMW500	171168	2023/9/14	1Year

#### For Other Test

Equipment	Manufacturer	Model No.	Serial No.	Last Cal.	Cal. Interval
Wideband Radio Communication Tester	R&S	CMW500	171168	2024/9/18	1Year
Frequency Extender	R&S	CMW-Z800A	100430	2024/9/18	1Year
Spectrum Analyzer	R&S	FSV3044	101289	2024/9/18	1Year
Analog Signal Generator	R&S	SMB100A	183237	2024/9/18	1Year
Vector Signal Generator	R&S	SMM100A	101808	2024/9/18	1Year
RF Control Unit(Power Meter)	Tonscend	JS0806-2	22C8060567	2024/9/18	1Year
Temperature&Hum idity Chamber	ESPEC	EL-02KA	12107166	2024/5/10	1 Year
DC Power Supply	KEYSIGHT	E3642A	MY53030016	2024/9/18	1 Year



### 4.3 DESCRIPTION OF TEST MODES

The EUT has been tested under its typical operating condition.

The EUT configuration for testing is installed on RF field strength measurement to meet the Commissions requirement and operating in a manner which intends to maximize its emission characteristics in a continuous normal application.

The Transmitter was operated in the normal operating mode. The TX frequency was fixed which was for the purpose of the measurements.

Test of channel included the lowest and middle and highest frequency to perform the test, then record on this report.

Pre-defined engineering program for regulatory testing used to control the EUT for staying in continuous transmitting and receiving mode is programmed.

5GHz	Frequency Range (MHz)	Center Frequency (MHz)
802.11a	[5170,5330]U[5490,5710] U[5735,5835]	"5180 5185 5190 5195 5200 5205 5210 5215 5220 5225 5230 5235 5240 5260 5265 5270 5275 5280 5285 5290 5295 5300 5305 5310 5315 5320 5500 5505 5510 5515 5520 5525 5530 5535 5540 5545 5550 5555 5560 5565 5570 5575 5580 5585 5590 5595 5600 5605 5610 5615 5620 5625 5630 5635 5640 5645 5650 5655 5660 5665 5670 5675 5680 5685 5690 5695 5700 5745 5750 5755 5760 5765 5770 5775 5780 5785 5790 5795 5800 5805 5810 5815 5820 5825"
802.11n(20MHz)	[5170,5330]U[5490,5710] U[5735,5835]	"5180 5185 5190 5195 5200 5205 5210 5215 5220 5225 5230 5235 5240 5260 5265 5270 5275 5280 5285 5290 5295 5300 5305 5310 5315 5320 5500 5505 5510 5515 5520 5525 5530 5535 5540 5545 5550 5555 5560 5565 5570 5575 5580 5585 5590 5595 5600 5605 5610 5615 5620 5625 5630 5635 5640 5645 5650 5655 5660 5665 5670 5675 5680 5685 5690 5695 5700 5745 5750 5755 5760 5765 5770 5775 5780 5785 5790 5795 5800 5805 5810 5815 5820 5825"
802.11n(40MHz)	[5170,5330]U[5490,5710] U[5735,5835]	"5190 5195 5200 5205 5210 5215 5220 5225 5230 5270 5275 5280 5285 5290 5295 5300 5305 5310 5510 5515 5520 5525 5530 5535 5540 5545 5550 5555 5560 5565 5570 5575 5580 5585 5590 5595 5600 5605 5610 5615 5620 5625 5630 5635 5640 5645 5650 5655 5660 5665 5670 5675 5680 5685 5690 5755 5760 5765 5770 5775 5780 5785 5790 5795 5800 5805 5810 5815"
802.11ac(20MHz)	[5170,5330]U[5490,5710] U[5735,5835]	"5180 5185 5190 5195 5200 5205 5210 5215 5220 5225 5230 5235 5240 5260 5265 5270 5275 5280 5285 5290 5295 5300 5305 5310 5315 5320 5500 5505 5510 5515 5520 5525 5530 5535 5540 5545 5550 5555 5560 5565 5570 5575 5580 5585 5590 5595 5600 5605 5610 5615 5620 5625 5630 5635 5640 5645 5650 5655 5660 5665 5670 5675 5680 5685 5690 5695 5700 5745 5750 5755 5760 5765 5770 5775 5780 5785 5790 5795 5800 5805 5810 5815 5820 5825"
802.11ac(40MHz)	[5170,5330]U[5490,5710] U[5735,5835]	"5190 5195 5200 5205 5210 5215 5220 5225 5230 5270 5275 5280 5285 5290 5295 5300 5305 5310 5510 5515 5520 5525 5530 5535 5540 5545 5550 5555 5560 5565 5570 5575 5580 5585 5590 5595 5600 5605 5610 5615 5620 5625 5630 5635 5640 5645 5650 5655 5660 5665 5670 5675 5680 5685 5690 5755 5760 5765 5770 5775 5780 5785 5790 5795 5800 5805 5810 5815"
802.11ac(80MHz)	[5170,5330]U[5490,5710] U[5735,5835]	"5210 5290 5530 5535 5540 5545 5550 5555 5560 5565 5570 5575 5580 5585 5590 5595 5600 5605 5610 5615 5620 5625 5630 5635 5640 5645 5650 5655 5660 5665 5670 5775 5780 5785 5790 5795"

**WIFI 5G with 5150-5250MHz**

Frequency and Channels list for 802.11a/n(20)/ac(20):

Channel	Frequency (MHz)	Channel	Frequency (MHz)	Channel	Frequency (MHz)
36	5180	44	5220		
40	5200	48	5240		

Frequency and Channels list for 802.11n (40)/ac(40):

Channel	Frequency (MHz)	Channel	Frequency (MHz)	Channel	Frequency (MHz)
38	5190				
46	5230				

Frequency and Channel list for 802.11ac(80):

Channel	Frequency (MHz)	Channel	Frequency (MHz)	Channel	Frequency (MHz)
42	5210				

**Test Frequency and Channels** for 802.11a/n(20)/ac(20):

Lowest Frequency		Middle Frequency		Highest Frequency	
Channel	Frequency (MHz)	Channel	Frequency (MHz)	Channel	Frequency (MHz)
36	5180	40	5200	48	5240

**Test Frequency and channels** for 802.11n (40)/ 802.11ac(40):

Lowest Frequency		Middle Frequency		Highest Frequency	
Channel	Frequency (MHz)	Channel	Frequency (MHz)	Channel	Frequency (MHz)
38	5190	N/A	N/A	46	5230

**Test Frequency and channels** for 802.11ac(80):

Lowest Frequency		Middle Frequency		Highest Frequency	
Channel	Frequency (MHz)	Channel	Frequency (MHz)	Channel	Frequency (MHz)
42	5210	N/A	N/A	N/A	N/A

**WIFI 5G with 5250-5350MHz**

Frequency and Channels list for 802.11a/n(20)/ac(20):

Channel	Frequency (MHz)	Channel	Frequency (MHz)	Channel	Frequency (MHz)
52	5260	60	5300		
56	5280	64	5320		

Frequency and Channels list for 802.11n (40)/ 802.11ac(40):

Channel	Frequency (MHz)	Channel	Frequency (MHz)	Channel	Frequency (MHz)
54	5270				
62	5310				

Frequency and Channels list for 802.11ac(80):

Channel	Frequency (MHz)	Channel	Frequency (MHz)	Channel	Frequency (MHz)
58	5290				

**Test Frequency and Channels** for 802.11a/n(20)/ac(20):

Lowest Frequency		Middle Frequency		Highest Frequency	
Channel	Frequency (MHz)	Channel	Frequency (MHz)	Channel	Frequency (MHz)
52	5260	56	5280	64	5320

**Test Frequency and channels** for 802.11n(40)/ 802.11ac(40):

Lowest Frequency		Middle Frequency		Highest Frequency	
Channel	Frequency (MHz)	Channel	Frequency (MHz)	Channel	Frequency (MHz)
54	5270	N/A	N/A	62	5310

**Test Frequency and channels** for 802.11ac(80):

Lowest Frequency		Middle Frequency		Highest Frequency	
Channel	Frequency (MHz)	Channel	Frequency (MHz)	Channel	Frequency (MHz)
58	5290				

**WIFI 5G with 5470-5725MHz**

Frequency and Channels list for 802.11a/n(20)/ac(20):

Channel	Frequency (MHz)	Channel	Frequency (MHz)	Channel	Frequency (MHz)
100	5500	116	5580	132	5660
104	5520	120	5600	136	5680
108	5540	124	5620	140	5700
112	5560	128	5640		

Frequency and Channels list for 802.11n(40)/ 802.11ac(40):

Channel	Frequency (MHz)	Channel	Frequency (MHz)	Channel	Frequency (MHz)
102	5510	118	5590	134	5670
110	5550	126	5630		

Frequency and Channels list for 802.11ac(80):

Channel	Frequency (MHz)	Channel	Frequency (MHz)	Channel	Frequency (MHz)
106	5530	138	5690		

**Test Frequency and Channels** for 802.11a/n(20)/ac(20):

Lowest Frequency		Middle Frequency		Highest Frequency	
Channel	Frequency (MHz)	Channel	Frequency (MHz)	Channel	Frequency (MHz)
100	5500	116	5580	140	5700

**Test Frequency and channels** for 802.11n(40)/ac(40):

Lowest Frequency		Middle Frequency		Highest Frequency	
Channel	Frequency (MHz)	Channel	Frequency (MHz)	Channel	Frequency (MHz)
102	5510			134	5670

**Test Frequency and channels** for 802.11ac(80):

Lowest Frequency		Middle Frequency		Highest Frequency	
Channel	Frequency (MHz)	Channel	Frequency (MHz)	Channel	Frequency (MHz)
106	5530	138	5690		

**WIFI 5G with 5725MHz-5850MHz**

Frequency and Channels list for 802.11a/n(20)/ac(20):

Channel	Frequency (MHz)	Channel	Frequency (MHz)	Channel	Frequency (MHz)
149	5745	157	5785	165	5825
153	5765	161	5805		

Frequency and Channels list for 802.11n (40)/ 802.11ac(40):

Channel	Frequency (MHz)	Channel	Frequency (MHz)	Channel	Frequency (MHz)
151	5755				
159	5795				

Frequency and Channels list for 802.11ac(80):

Channel	Frequency (MHz)	Channel	Frequency (MHz)	Channel	Frequency (MHz)
155	5775				

**Test Frequency and Channels** for 802.11a/n(20)/ac(20):

Lowest Frequency		Middle Frequency		Highest Frequency	
Channel	Frequency (MHz)	Channel	Frequency (MHz)	Channel	Frequency (MHz)
149	5745	157	5785	165	5825

**Test Frequency and channels** for 802.11n (40)/ac(40):

Lowest Frequency		Middle Frequency		Highest Frequency	
Channel	Frequency (MHz)	Channel	Frequency (MHz)	Channel	Frequency (MHz)
151	5755			159	5795

**Test Frequency and channels** for 802.11ac(80):

Lowest Frequency		Middle Frequency		Highest Frequency	
Channel	Frequency (MHz)	Channel	Frequency (MHz)	Channel	Frequency (MHz)
155	5775				

Multi-antenna correlation:

<input checked="" type="checkbox"/>	Transmit Signals are Correlated
	Directional gain = $10 \log[(10^{G^1/20} + 10^{G^2/20} + \dots + 10^{G^N/20})^2 / N_{ANT}]$ dBi
<input type="checkbox"/>	All Transmit Signals are Completely Uncorrelated
	Directional gain = $10 \log[(10^{G^1/10} + 10^{G^2/10} + \dots + 10^{G^N/10}) / N_{ANT}]$ dBi

B1: 5150-5250MHz: Ant1: 17.78dBi, Ant2: 17.31dBi, Directional gain = 20.56dBi

B2: 5250-5350MHz: Ant1: 18.02dBi, Ant2: 17.57dBi, Directional gain = 20.81dBi

B3: 5470-5725MHz: Ant1: 18.77dBi, Ant2: 18.25dBi, Directional gain = 21.52dBi

B4: 5725-5850MHz: Ant1: 18.98dBi, Ant2: 18.31dBi, Directional gain = 21.66dBi

## 5 FACILITIES AND ACCREDITATIONS

### 5.1 EQUIPMENT

Radiated emissions are measured with one or more of the following types of linearly polarized antennas: tuned dipole, biconical, log periodic, bi-log, and/or ridged wave guide, horn. Spectrum analyzers with preselectors and quasi-peak detectors are used to perform radiated measurements.

Conducted emissions are measured with Line Impedance Stabilization Networks and EMI Test Receivers.

Calibrated wide band preamplifiers, coaxial cables, and coaxial attenuators are also used for making measurements.

All receiving equipment conforms to CISPR Publication 16-1, "Radio Interference Measuring Apparatus and Measurement Methods".

### 5.2 DESCRIPTION OF TEST FACILITY

Site Description

Name of Firm : EMTEK (SHENZHEN) CO., LTD.

Site Location : Building 69, Majialong Industry Zone, Nanshan District, Shenzhen, Guangdong, China

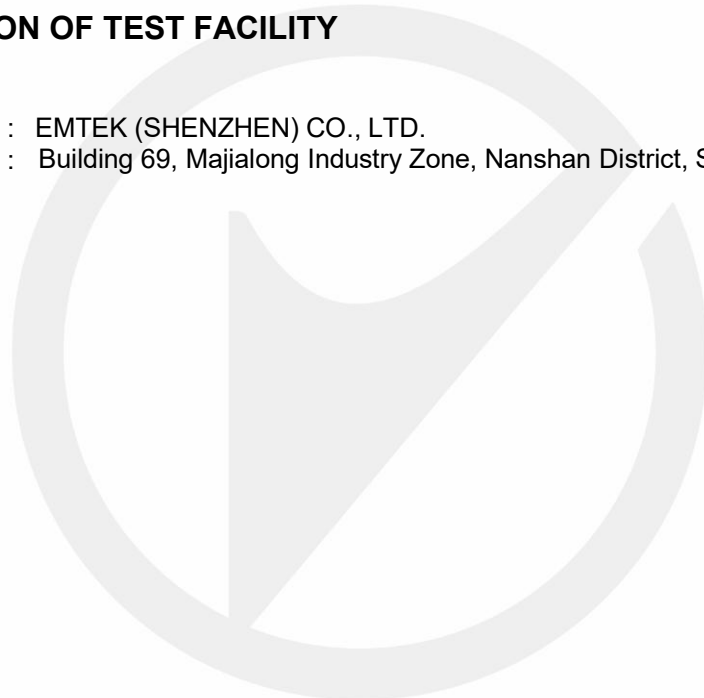

## 6 TEST SYSTEM UNCERTAINTY

The following measurement uncertainty levels have been estimated for tests performed on the apparatus:

Parameter	Uncertainty
Radio Frequency	$\pm 1 \times 10^{-5}$
Maximum Peak Output Power Test	$\pm 1.0\text{dB}$
Conducted Emissions Test	$\pm 2.0\text{dB}$
Radiated Emission Test	$\pm 2.0\text{dB}$
Power Density	$\pm 2.0\text{dB}$
Occupied Bandwidth Test	$\pm 1.0\text{dB}$
Band Edge Test	$\pm 3\text{dB}$
All emission, radiated	$\pm 3\text{dB}$
Antenna Port Emission	$\pm 3\text{dB}$
Temperature	$\pm 0.5^\circ\text{C}$
Humidity	$\pm 3\%$

Measurement Uncertainty for a level of Confidence of 95%.

## 7 SETUP OF EQUIPMENT UNDER TEST

### 7.1 RADIO FREQUENCY TEST SETUP

The WLAN component's antenna ports(s) of the EUT are connected to the measurement instrument per an appropriate attenuator. The EUT is controlled by PC/software to emit the specified signals for the purpose of measurements.

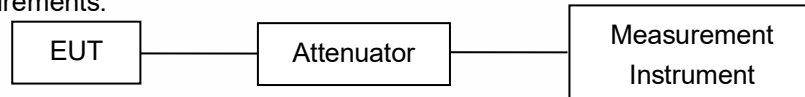

### 7.2 RADIO FREQUENCY TEST SETUP

The test site semi-anechoic chamber has met the requirement of NSA tolerance 4 dB according to the standards: ANSI C63.10. The test distance is 3m. The setup is according to the requirements in Section 13.1.4.1 of ANSI C63.10-2013 and CAN/CSA-CEI/IEC CISPR 22.

Below 30MHz:

The EUT is placed on a turntable 0.8 meters above the ground in the chamber, 3 meter away from the antenna (loop antenna). The Antenna should be positioned with its plane vertical at the specified distance from the EUT and rotated about its vertical axis for maximum response at each azimuth about the EUT. The center of the loop shall be 1 m above the ground. For certain applications, the loop antenna plane may also need to be positioned horizontally at the specified distance from the EUT.

Above 30MHz:

The EUT is placed on a turntable 0.8 meters above the ground in the chamber, 3 meter away from the antenna. The maximal emission value is acquired by adjusting the antenna height, polarisation and turntable azimuth. Normally, the height range of antenna is 1 m to 4 m, the azimuth range of turntable is 0° to 360°, and the receive antenna has two polarizations Vertical (V) and Horizontal (H).

Above 1GHz:

(Note: the FCC's permission to use 1.5m as an alternative per TCBC Conf call of Dec. 2, 2014.)

The EUT is placed on a turntable 1.5 meters above the ground in the chamber, 3 meter away from the antenna. The maximal emission value is acquired by adjusting the antenna height, polarisation and turntable azimuth. Normally, the height range of antenna is 1 m to 4 m, the azimuth range of turntable is 0° to 360°, and the receive antenna has two polarizations Vertical (V) and Horizontal (H).



(a) Radiated Emission Test Set-Up, Frequency Below 30MHz

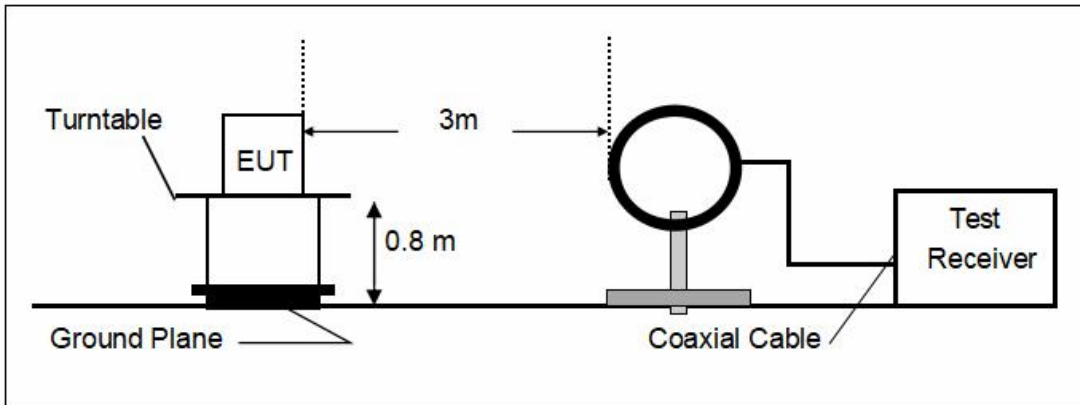

(b) Radiated Emission Test Set-Up, Frequency Below 1000MHz

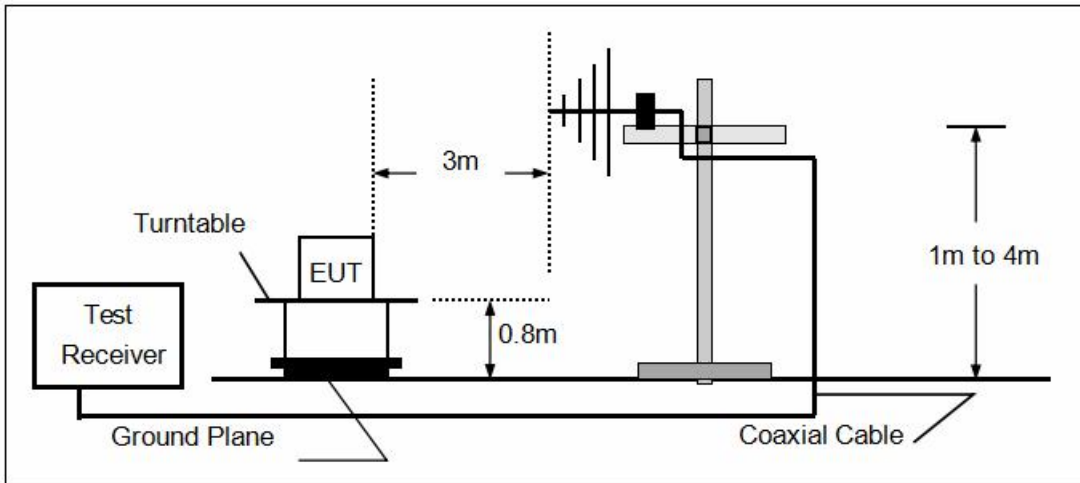

(c) Radiated Emission Test Set-Up, Frequency above 1000MHz

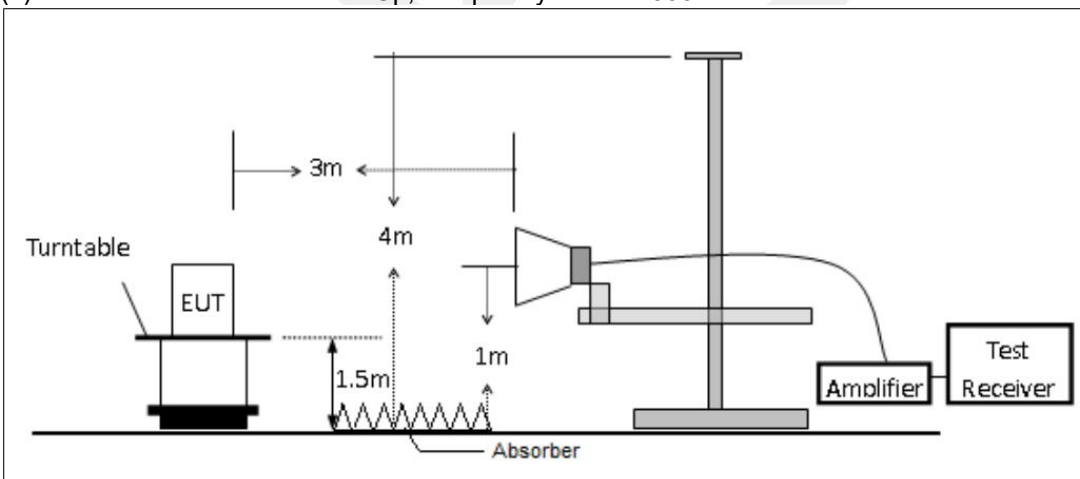

### 7.3 CONDUCTED EMISSION TEST SETUP

The mains cable of the EUT (maybe per AC/DC Adapter) must be connected to LISN. The LISN shall be placed 0.8 m from the boundary of EUT and bonded to a ground reference plane for LISN mounted on top of the ground reference plane. This distance is between the closest points of the LISN and the EUT. All other units of the EUT and associated equipment shall be at least 0.8m from the LISN.

Ground connections, where required for safety purposes, shall be connected to the reference ground point of the LISN and, where not otherwise provided or specified by the manufacturer, shall be of same length as the mains cable and run parallel to the mains connection at a separation distance of not more than 0.1 m.

According to the requirements in Section 13.1.4.1 of ANSI C63.10-2013 Conducted emissions from the EUT measured in the frequency range between 0.15 MHz and 30 MHz using CISPR Quasi-Peak and average detector mode.

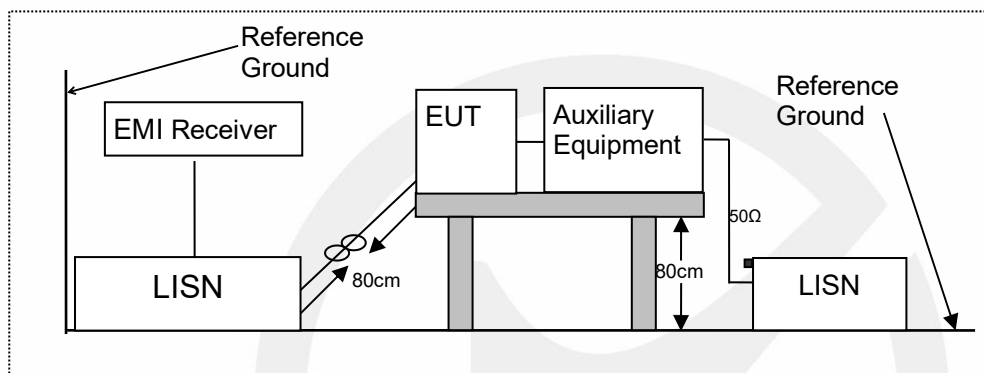

## 7.4 BLOCK DIAGRAM CONFIGURATION OF TEST SYSTEM

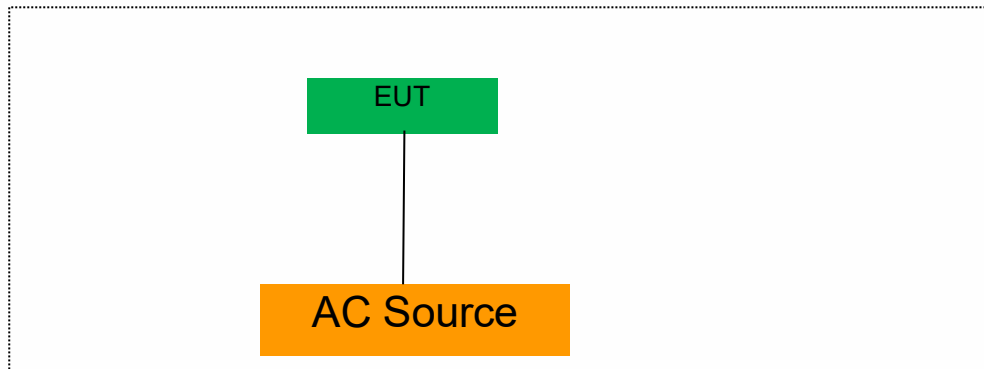

## 7.5 SUPPORT EQUIPMENT

Adapter : Model: AD-120200U0W  
Input: 100-240V~50/60Hz, 0.8A  
Output: 12V, 2A, 24W  
CE, FCC

### Notes:

- 1.All the equipment/cables were placed in the worst-case configuration to maximize the emission during the test.
- 2.Grounding was established in accordance with the manufacturer's requirements and conditions for the intended use.

## 8 TEST REQUIREMENTS

### 8.1 BANDWIDTH MEASUREMENT

#### 8.1.1 Applicable Standard

According to FCC Part 15.407(a)(1) for UNII Band I  
According to FCC Part 15.407(a)(2) for UNII Band II-A and UNII Band II-C  
According to FCC Part 15.407(a)(3) for UNII Band III  
According to FCC Part 15.407(e) for UNII Band III  
According to 789033 D02 Section II(C)  
According to 789033 D02 Section II(D)

#### 8.1.2 Conformance Limit

(1) For the band 5.15-5.25 GHz.

(iv) For mobile and portable client devices in the 5.15-5.25 GHz band, the maximum conducted output power over the frequency band of operation shall not exceed 250 mW provided the maximum antenna gain does not exceed 6 dBi. In addition, the maximum power spectral density shall not exceed 11 dBm in any 1 megahertz band. If transmitting antennas of directional gain greater than 6 dBi are used, both the maximum conducted output power and the maximum power spectral density shall be reduced by the amount in dB that the directional gain of the antenna exceeds 6 dBi.

(2) For the 5.25-5.35 GHz and 5.47-5.725 GHz bands, the maximum conducted output power over the frequency bands of operation shall not exceed the lesser of 250 mW or  $11 \text{ dBm} + 10 \log B$ , where B is the 26 dB emission bandwidth in megahertz. In addition, the maximum power spectral density shall not exceed 11 dBm in any 1 megahertz band. If transmitting antennas of directional gain greater than 6 dBi are used, both the maximum conducted output power and the maximum power spectral density shall be reduced by the amount in dB that the directional gain of the antenna exceeds 6 dBi.

(3) For the band 5.725-5.85 GHz, the maximum conducted output power over the frequency band of operation shall not exceed 1 W. In addition, the maximum power spectral density shall not exceed 30 dBm in any 500-kHz band. If transmitting antennas of directional gain greater than 6 dBi are used, both the maximum conducted output power and the maximum power spectral density shall be reduced by the amount in dB that the directional gain of the antenna exceeds 6 dBi. However, fixed point-to-point U-NII devices operating in this band may employ transmitting antennas with directional gain greater than 6 dBi without any corresponding reduction in transmitter conducted power. Fixed, point-to-point operations exclude the use of point-to-multipoint systems, omnidirectional applications, and multiple collocated transmitters transmitting the same information. The operator of the U-NII device, or if the equipment is professionally installed, the installer, is responsible for ensuring that systems employing high gain directional antennas are used exclusively for fixed, point-to-point operations.

(e) Within the 5.725-5.85 GHz band, the minimum 6 dB bandwidth of U-NII devices shall be at least 500 kHz.

#### 8.1.3 Test Configuration

Test according to clause 6.1 radio frequency test setup.

#### 8.1.4 Test Procedure

According to 789033 D02 v02r01 section C&D, the following is the measurement procedure.

##### 1. Emission Bandwidth (EBW)

- a) Set RBW = approximately 1% of the emission bandwidth.
- b) Set the VBW > RBW.
- c) Detector = Peak.
- d) Trace mode = max hold.
- e) Measure the maximum width of the emission that is 26 dB down from the maximum of the emission.

Compare this with the RBW setting of the analyzer. Readjust RBW and repeat measurement as needed until the RBW/EBW ratio is approximately 1%.

## 2. Minimum Emission Bandwidth for the band 5.725-5.85 GHz

Section 15.407(e) specifies the minimum 6 dB emission bandwidth of at least 500 KHz for the band 5.715-5.85 GHz. The following procedure shall be used for measuring this bandwidth:

- a) Set RBW = 100 kHz.
- b) Set the video bandwidth (VBW)  $\geq 3 \times$  RBW.
- c) Detector = Peak.
- d) Trace mode = max hold.
- e) Sweep = auto couple.
- f) Allow the trace to stabilize.
- g) Measure the maximum width of the emission that is constrained by the frequencies associated with the two outermost amplitude points (upper and lower frequencies) that are attenuated by 6 dB relative to the maximum level measured in the fundamental emission.

Note: The automatic bandwidth measurement capability of a spectrum analyzer or EMI receiver may be employed if it implements the functionality described above.

## D. 99 Percent Occupied Bandwidth

The 99-percent occupied bandwidth is the frequency bandwidth such that, below its lower and above its upper frequency limits, the mean powers are each equal to 0.5 % of the total mean power of the given emission. Measurement of the 99-percent occupied bandwidth is required only as a condition for using the optional band-edge measurement techniques described in section II.G.3.d). Measurements of 99-percent occupied bandwidth may also optionally be used in lieu of the EBW to 789033 D02 v01r02 General UNII Test Procedures New Rules v01 define the minimum frequency range over which the spectrum is integrated when measuring maximum conducted output power as described in section II.E. However, the EBW must be measured to determine bandwidth dependent limits on maximum conducted output power in accordance with 15.407(a).

The following procedure shall be used for measuring (99 %) power bandwidth:

1. Set center frequency to the nominal EUT channel center frequency.
2. Set span = 1.5 times to 5.0 times the OBW.
3. Set RBW = 1 % to 5 % of the OBW.
4. Set VBW  $\geq 3 \times$  RBW.
5. Video averaging is not permitted. Where practical, a sample detection and single sweep mode shall be used. Otherwise, peak detection and max hold mode (until the trace stabilizes) shall be used.
6. Use the 99 % power bandwidth function of the instrument (if available).
7. If the instrument does not have a 99 % power bandwidth function, the trace data points are recovered and directly summed in power units. The recovered amplitude data points, beginning at the lowest frequency, are placed in a running sum until 0.5 % of the total is reached; that frequency is recorded as the lower frequency. The process is repeated until 99.5 % of the total is reached; that frequency is recorded as the upper frequency. The 99% occupied bandwidth is the difference between these two frequencies.

### 8.1.5 Test Results

Temperature : 25°C  
Humidity : 45 %

ATM Pressure:: 1011 mbar  
Test Engineer: GJ

#### Emission Bandwidth (26dB)

TestMode	Antenna	Frequency[MHz]	26db EBW [MHz]	FL[MHz]	FH[MHz]	Limit[MHz]	Verdict
11A	Ant1	5180	19.96	5170.04	5190.00	---	---
	Ant2	5180	19.60	5170.16	5189.76	---	---
	Ant1	5200	19.88	5190.04	5209.92	---	---
	Ant2	5200	19.64	5190.16	5209.80	---	---
	Ant1	5240	19.96	5230.00	5249.96	---	---
	Ant2	5240	19.64	5230.12	5249.76	---	---
	Ant1	5260	19.96	5250.04	5270.00	---	---
	Ant2	5260	19.60	5250.12	5269.72	---	---
	Ant1	5280	19.92	5270.04	5289.96	---	---
	Ant2	5280	19.68	5270.12	5289.80	---	---
	Ant1	5320	20.04	5309.96	5330.00	---	---
	Ant2	5320	19.64	5310.12	5329.76	---	---
	Ant1	5500	19.96	5489.96	5509.92	---	---
	Ant2	5500	19.72	5490.08	5509.80	---	---
	Ant1	5580	19.92	5570.08	5590.00	---	---
	Ant2	5580	19.76	5570.08	5589.84	---	---
	Ant1	5700	20.04	5689.92	5709.96	---	---
	Ant2	5700	19.64	5690.16	5709.80	---	---
	Ant1	5745	19.92	5735.00	5754.92	---	---
	Ant2	5745	19.60	5735.16	5754.76	---	---
11N20MIM O	Ant1	5785	19.96	5774.96	5794.92	---	---
	Ant2	5785	19.56	5775.12	5794.68	---	---
	Ant1	5825	19.96	5815.04	5835.00	---	---
	Ant2	5825	19.60	5815.08	5834.68	---	---
	Ant1	5180	20.24	5169.88	5190.12	---	---
	Ant2	5180	20.08	5169.96	5190.04	---	---
	Ant1	5200	20.24	5189.88	5210.12	---	---
	Ant2	5200	20.12	5189.96	5210.08	---	---
	Ant1	5240	20.20	5229.88	5250.08	---	---
	Ant2	5240	20.12	5229.88	5250.00	---	---
	Ant1	5260	20.20	5249.88	5270.08	---	---
	Ant2	5260	20.08	5249.92	5270.00	---	---
	Ant1	5280	20.24	5269.84	5290.08	---	---
	Ant2	5280	20.16	5269.92	5290.08	---	---
	Ant1	5320	20.28	5309.80	5330.08	---	---
	Ant2	5320	20.08	5310.00	5330.08	---	---
	Ant1	5500	20.20	5489.92	5510.12	---	---
	Ant2	5500	20.08	5489.96	5510.04	---	---
	Ant1	5580	20.36	5569.80	5590.16	---	---
	Ant2	5580	20.16	5569.88	5590.04	---	---
Ant1	5700	20.20	5690.00	5710.20	---	---	
Ant2	5700	20.12	5689.92	5710.04	---	---	
Ant1	5745	20.32	5734.84	5755.16	---	---	
Ant2	5745	20.12	5734.88	5755.00	---	---	
Ant1	5785	20.16	5774.88	5795.04	---	---	
Ant2	5785	20.04	5774.92	5794.96	---	---	
Ant1	5825	20.16	5814.88	5835.04	---	---	
Ant2	5825	20.16	5814.84	5835.00	---	---	
11N40MIM O	Ant1	5190	40.80	5169.68	5210.48	---	---
	Ant2	5190	40.40	5169.92	5210.32	---	---
	Ant1	5230	41.28	5209.36	5250.64	---	---
	Ant2	5230	40.08	5210.00	5250.08	---	---
	Ant1	5270	41.28	5249.28	5290.56	---	---
	Ant2	5270	40.48	5249.68	5290.16	---	---
Ant1	5310	40.80	5289.44	5330.24	---	---	
Ant2	5310	40.32	5289.84	5330.16	---	---	

	Ant1	5510	41.28	5489.28	5530.56	---	---
	Ant2	5510	40.80	5489.52	5530.32	---	---
	Ant1	5550	41.04	5529.36	5570.40	---	---
	Ant2	5550	40.72	5529.68	5570.40	---	---
	Ant1	5670	41.12	5649.44	5690.56	---	---
	Ant2	5670	40.72	5649.52	5690.24	---	---
	Ant1	5755	41.12	5734.44	5775.56	---	---
	Ant2	5755	40.64	5734.68	5775.32	---	---
	Ant1	5795	40.96	5774.36	5815.32	---	---
	Ant2	5795	40.40	5774.68	5815.08	---	---
11AC20MI MO	Ant1	5180	20.36	5169.84	5190.20	---	---
	Ant2	5180	20.08	5169.92	5190.00	---	---
	Ant1	5200	20.12	5189.92	5210.04	---	---
	Ant2	5200	20.08	5190.00	5210.08	---	---
	Ant1	5240	20.20	5229.88	5250.08	---	---
	Ant2	5240	20.16	5229.92	5250.08	---	---
	Ant1	5260	20.16	5249.92	5270.08	---	---
	Ant2	5260	20.04	5249.92	5269.96	---	---
	Ant1	5280	20.24	5269.84	5290.08	---	---
	Ant2	5280	20.12	5269.88	5290.00	---	---
	Ant1	5320	20.28	5309.80	5330.08	---	---
	Ant2	5320	20.16	5309.88	5330.04	---	---
	Ant1	5500	20.24	5489.84	5510.08	---	---
	Ant2	5500	20.08	5489.96	5510.04	---	---
	Ant1	5580	20.44	5569.76	5590.20	---	---
	Ant2	5580	20.24	5569.88	5590.12	---	---
	Ant1	5700	20.24	5689.88	5710.12	---	---
	Ant2	5700	20.04	5690.04	5710.08	---	---
	Ant1	5745	20.36	5734.80	5755.16	---	---
	Ant2	5745	20.04	5734.96	5755.00	---	---
Ant1	5785	20.24	5774.88	5795.12	---	---	
Ant2	5785	20.12	5774.96	5795.08	---	---	
Ant1	5825	20.36	5814.76	5835.12	---	---	
Ant2	5825	20.16	5814.84	5835.00	---	---	
11AC40MI MO	Ant1	5190	40.72	5169.60	5210.32	---	---
	Ant2	5190	40.16	5170.00	5210.16	---	---
	Ant1	5230	40.88	5209.60	5250.48	---	---
	Ant2	5230	40.32	5209.76	5250.08	---	---
	Ant1	5270	40.88	5249.52	5290.40	---	---
	Ant2	5270	40.40	5249.76	5290.16	---	---
	Ant1	5310	41.20	5289.44	5330.64	---	---
	Ant2	5310	40.32	5289.84	5330.16	---	---
	Ant1	5510	40.96	5489.44	5530.40	---	---
	Ant2	5510	40.48	5489.60	5530.08	---	---
	Ant1	5550	41.28	5529.28	5570.56	---	---
	Ant2	5550	40.40	5529.84	5570.24	---	---
	Ant1	5670	40.96	5649.60	5690.56	---	---
	Ant2	5670	40.40	5649.84	5690.24	---	---
	Ant1	5755	40.80	5734.60	5775.40	---	---
	Ant2	5755	40.16	5734.92	5775.08	---	---
	Ant1	5795	40.96	5774.44	5815.40	---	---
	Ant2	5795	40.32	5774.76	5815.08	---	---
11AC80MI MO	Ant1	5210	81.60	5169.20	5250.80	---	---
	Ant2	5210	81.12	5169.52	5250.64	---	---
	Ant1	5290	81.76	5249.20	5330.96	---	---
	Ant2	5290	81.28	5249.20	5330.48	---	---
	Ant1	5530	81.92	5488.88	5570.80	---	---
	Ant2	5530	81.28	5489.36	5570.64	---	---
	Ant1	5610	81.60	5569.04	5650.64	---	---
	Ant2	5610	80.96	5569.36	5650.32	---	---
	Ant1	5775	81.28	5734.52	5815.80	---	---
	Ant2	5775	80.80	5734.52	5815.32	---	---

### Emission Bandwidth (26dB) Test Graphs

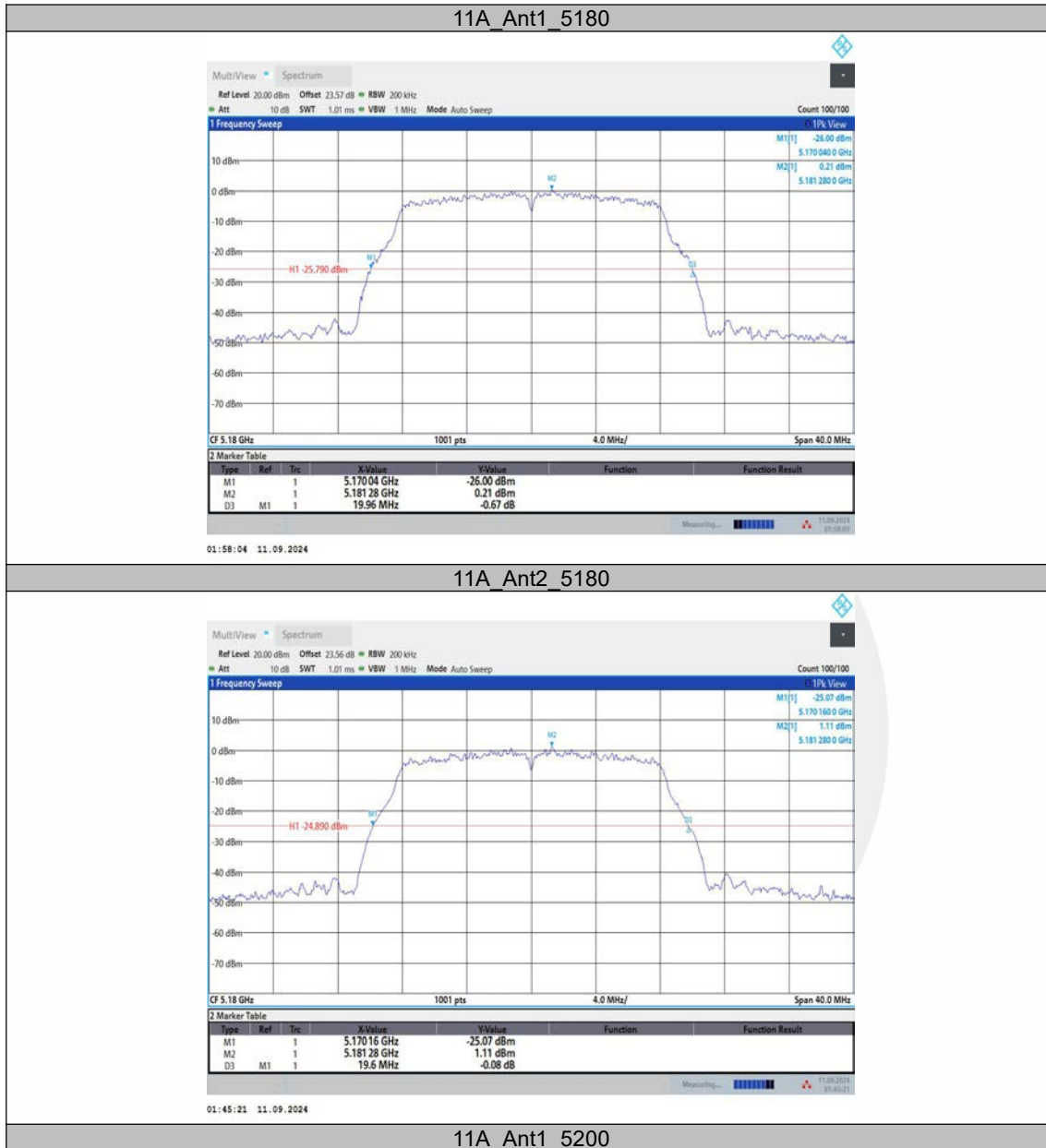



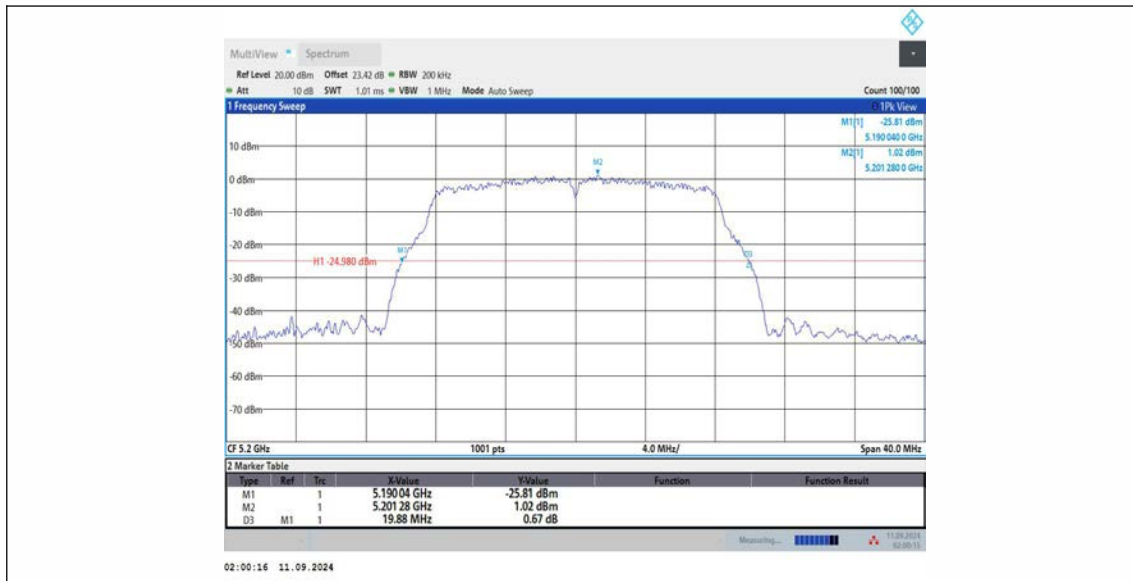

11A\_Ant2\_5200



11A\_Ant1\_5240

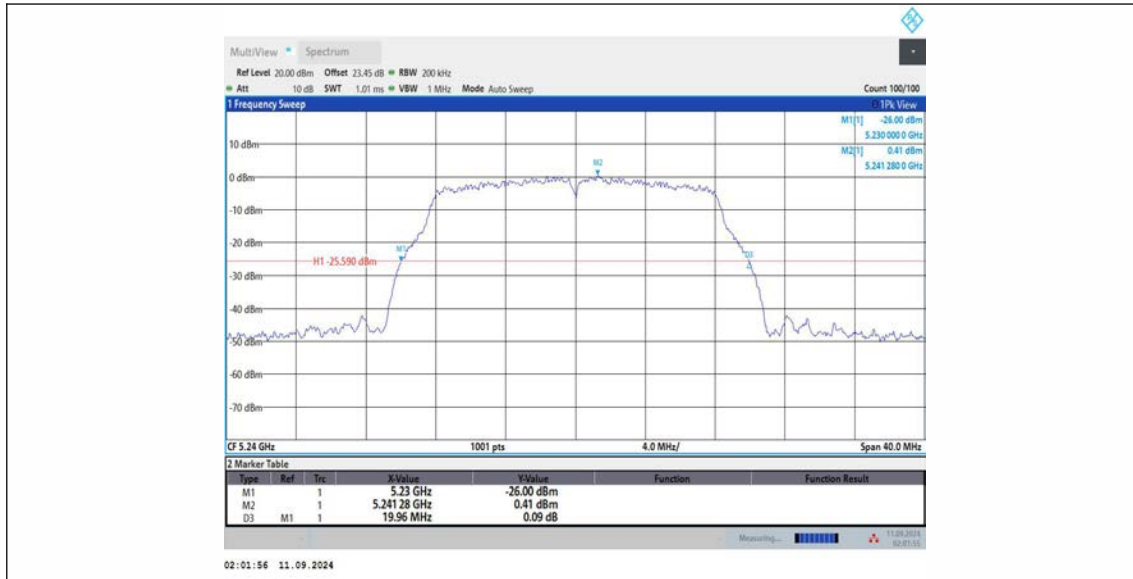

11A\_Ant2\_5240

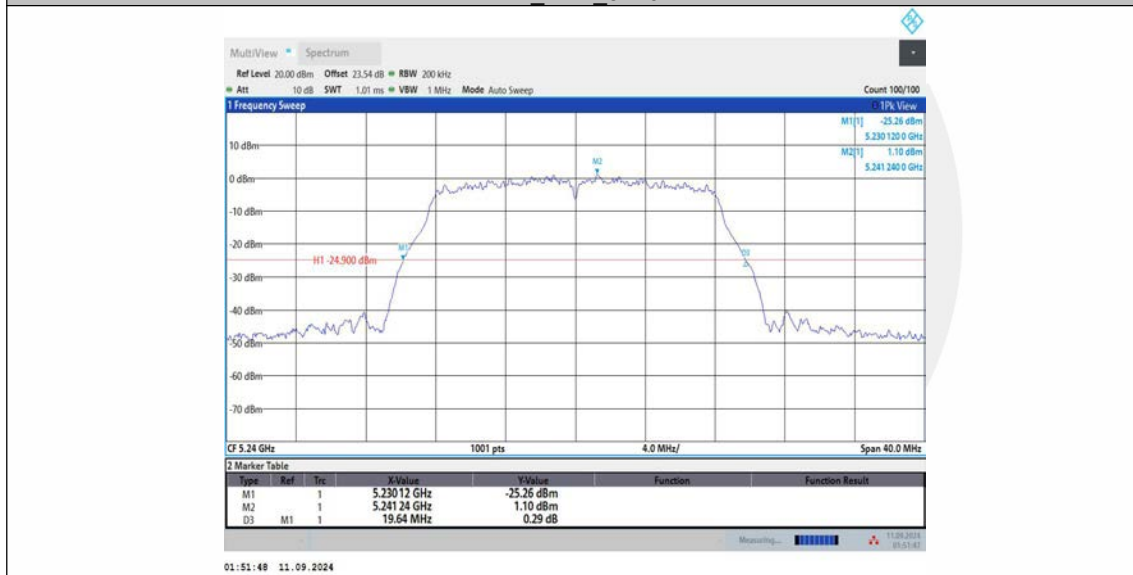

11A\_Ant1\_5260

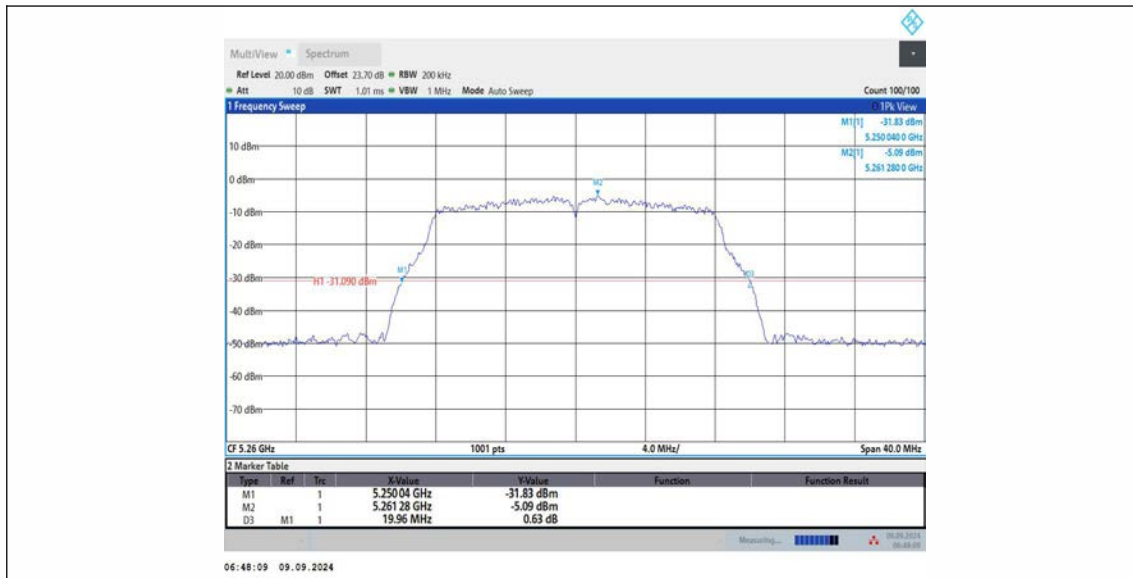

11A\_Ant2\_5260

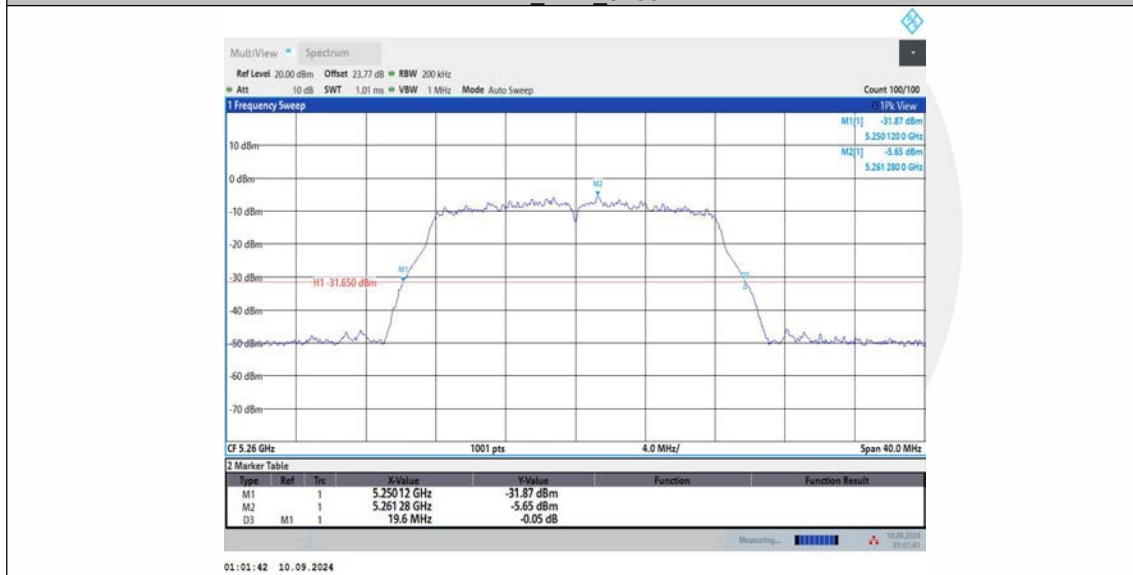

11A\_Ant1\_5280

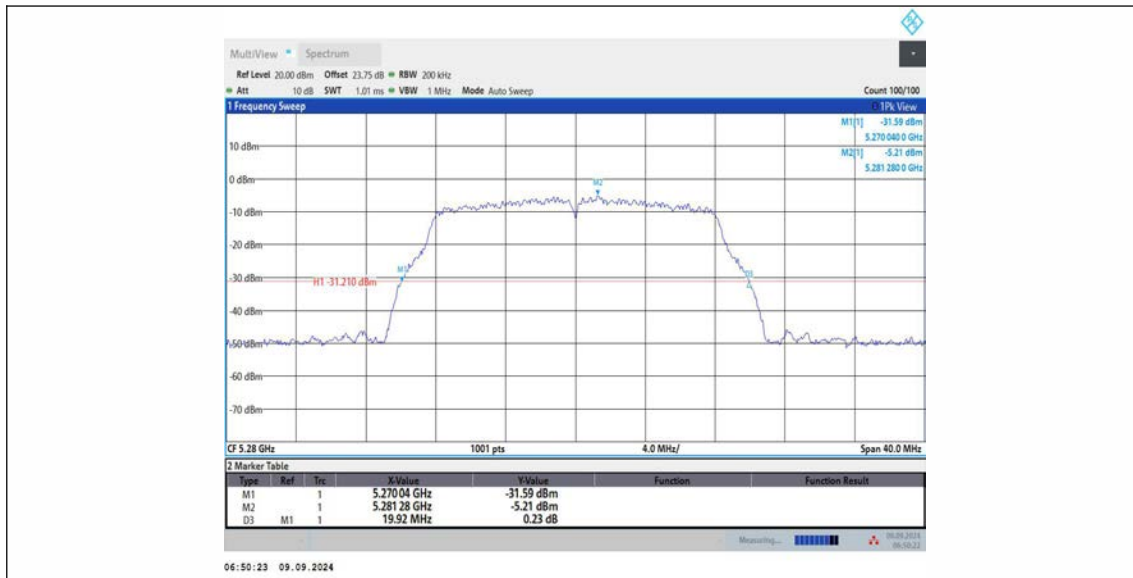

11A\_Ant2\_5280

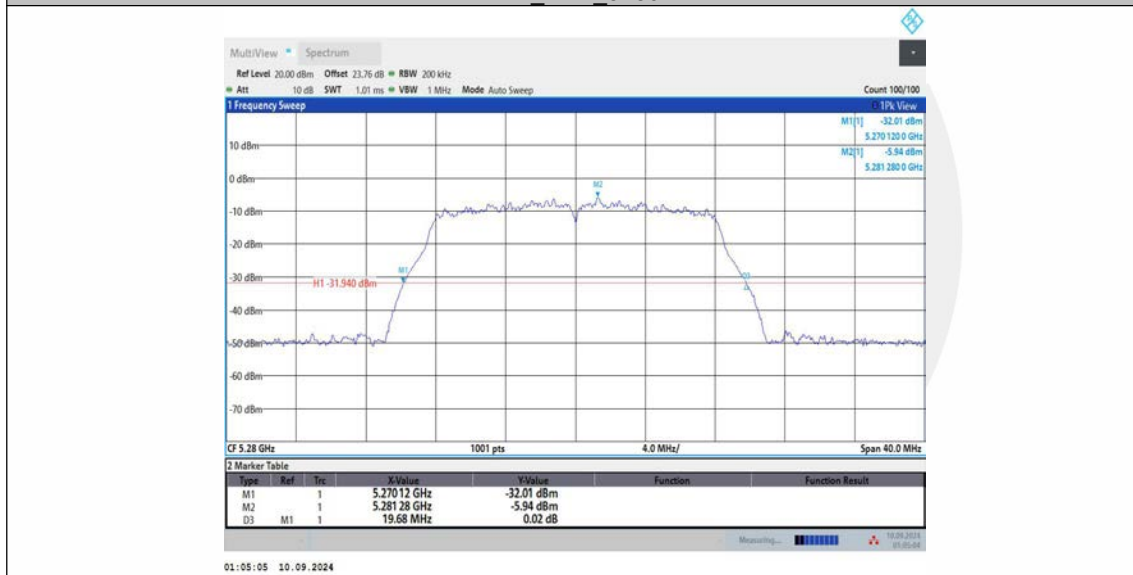

11A\_Ant1\_5320

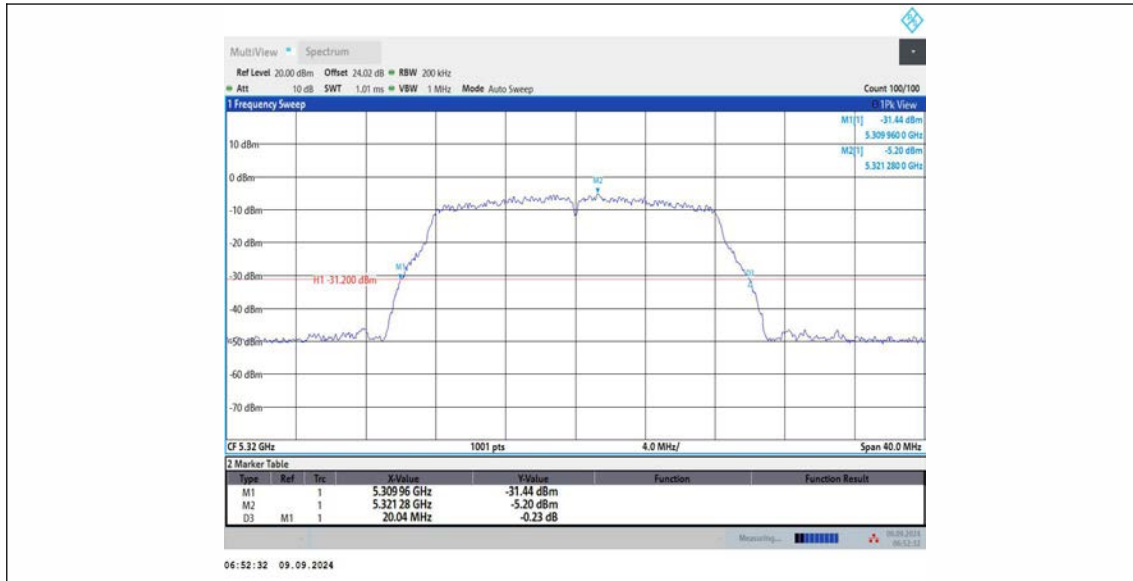

11A\_Ant2\_5320

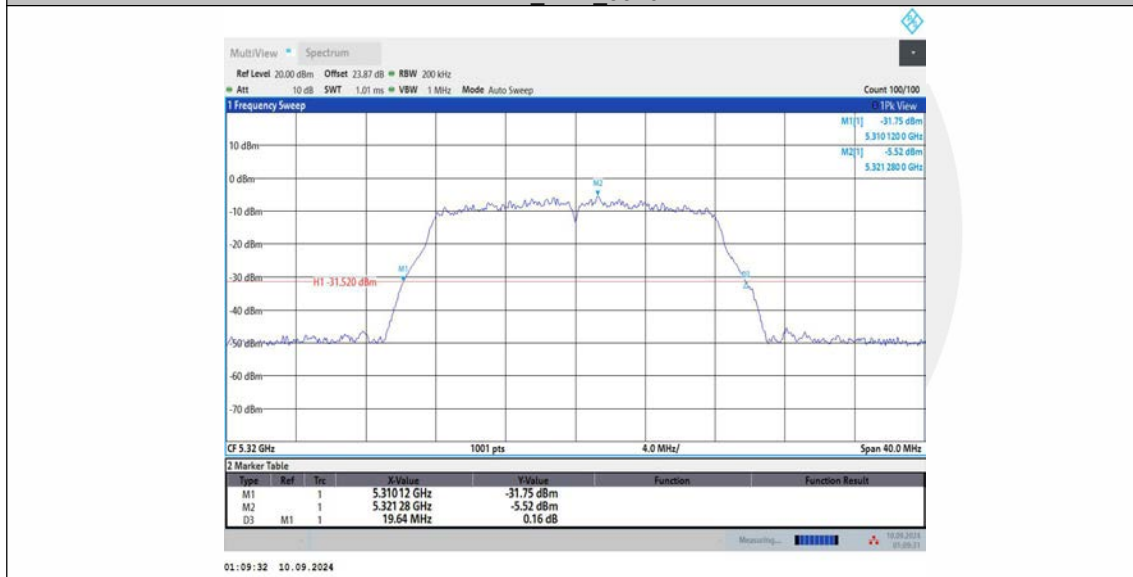

11A\_Ant1\_5500

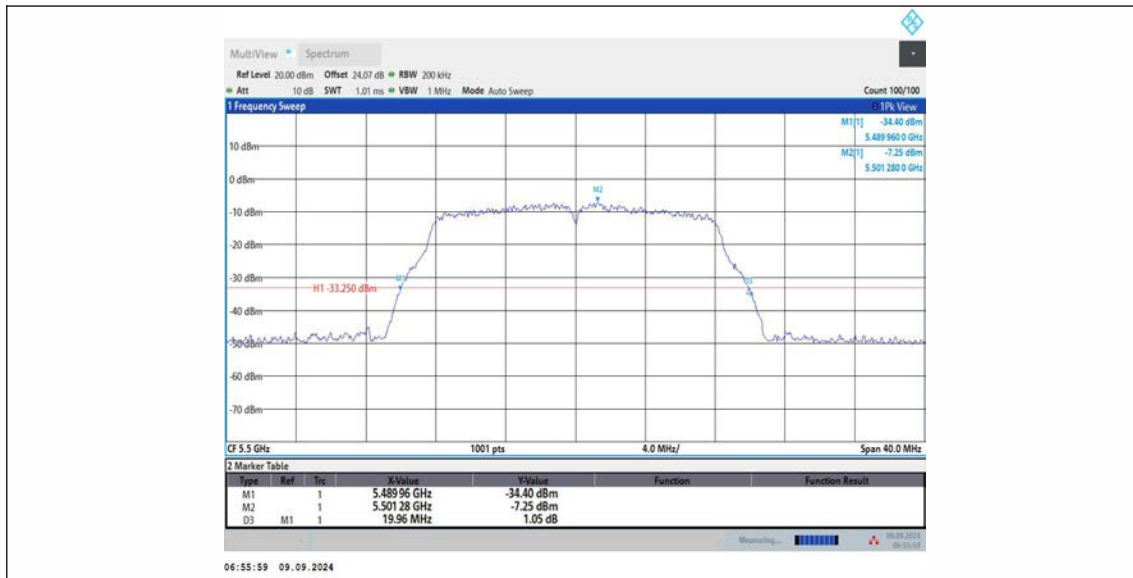

11A\_Ant2\_5500



11A\_Ant1\_5580

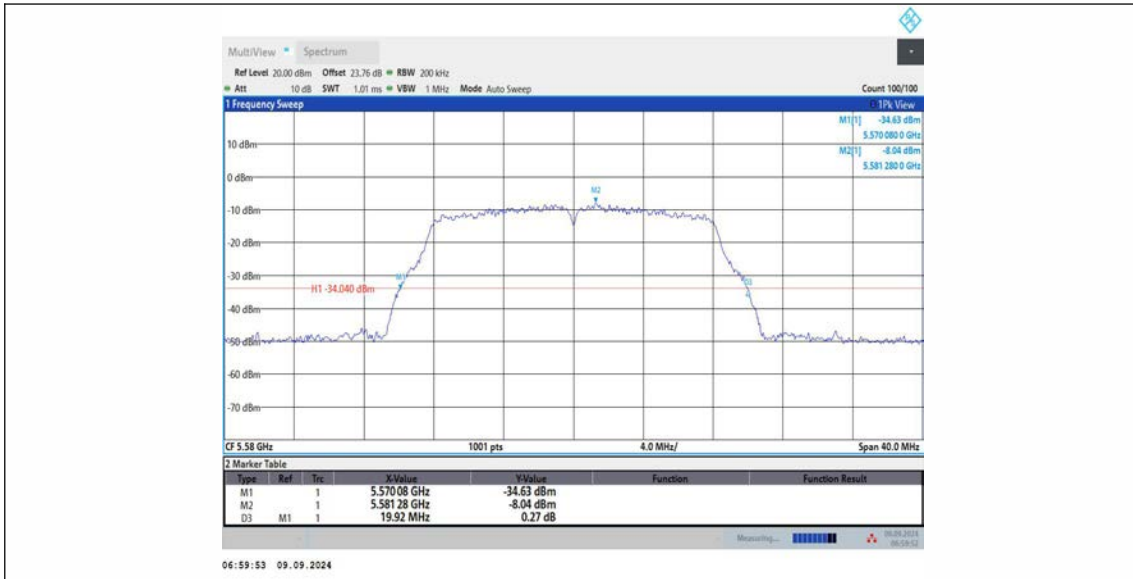

11A\_Ant2\_5580

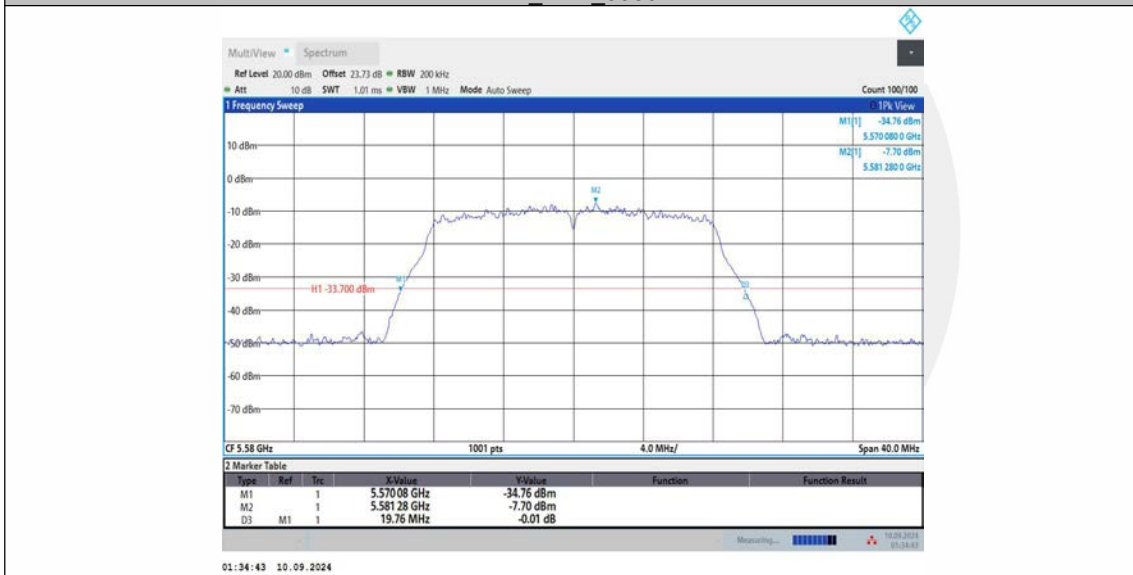

11A\_Ant1\_5700

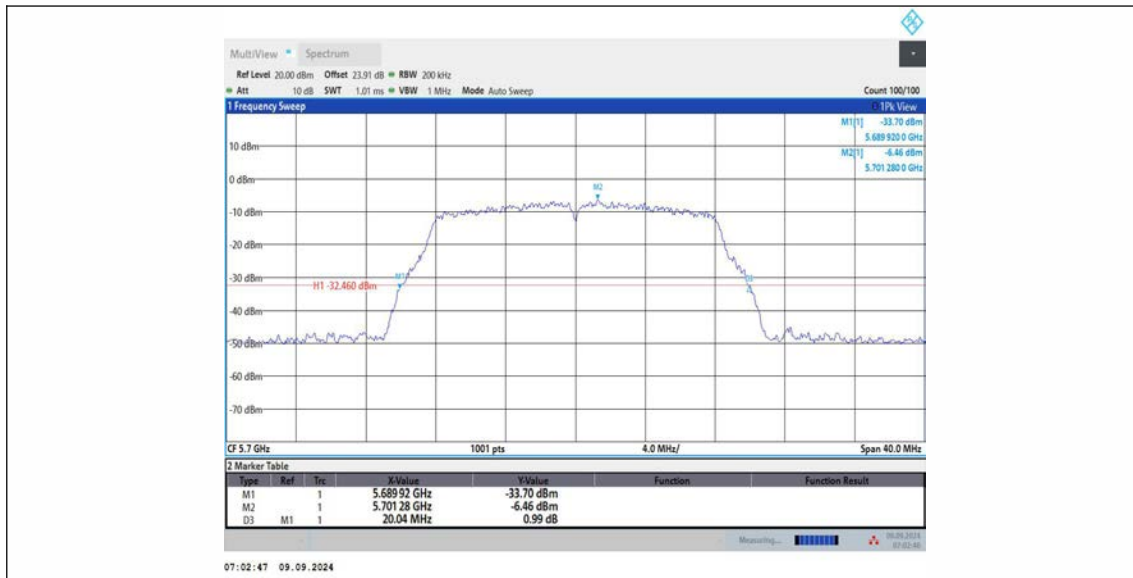

11A\_Ant2\_5700

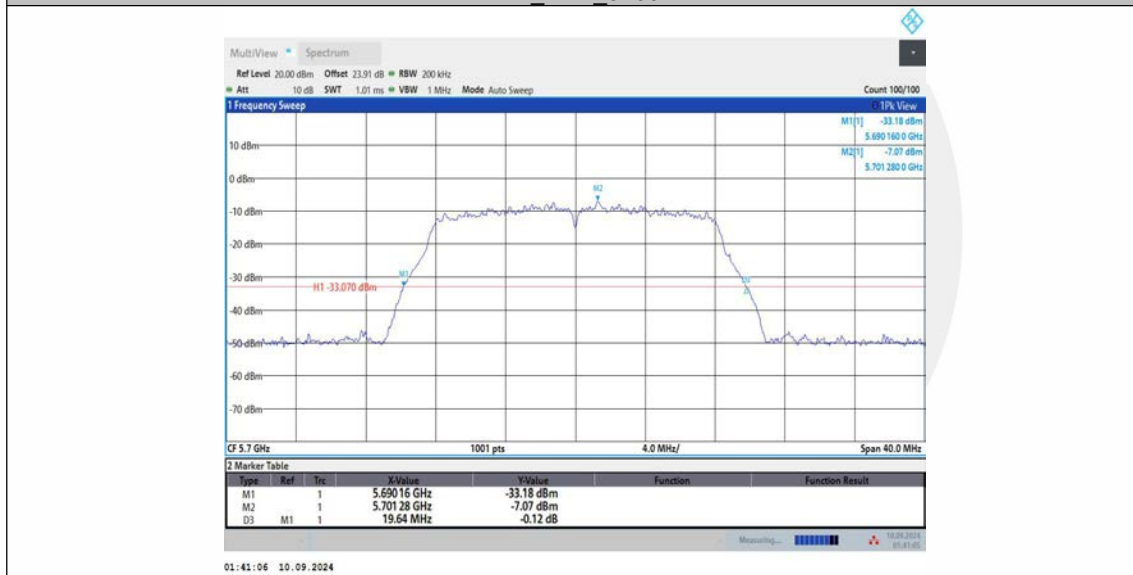

11A\_Ant1\_5745



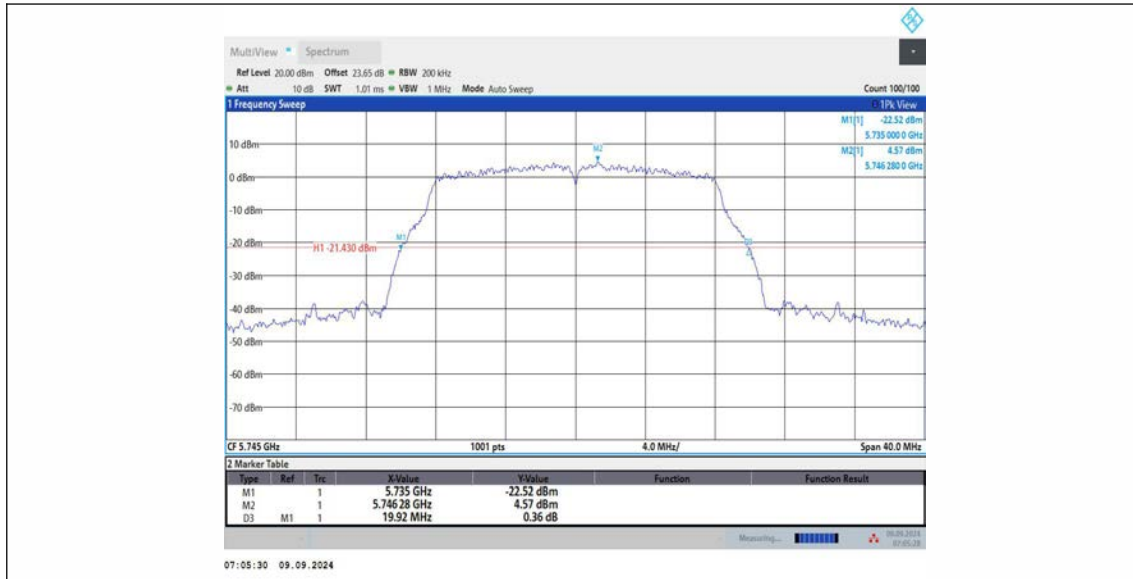

11A\_Ant2\_5745

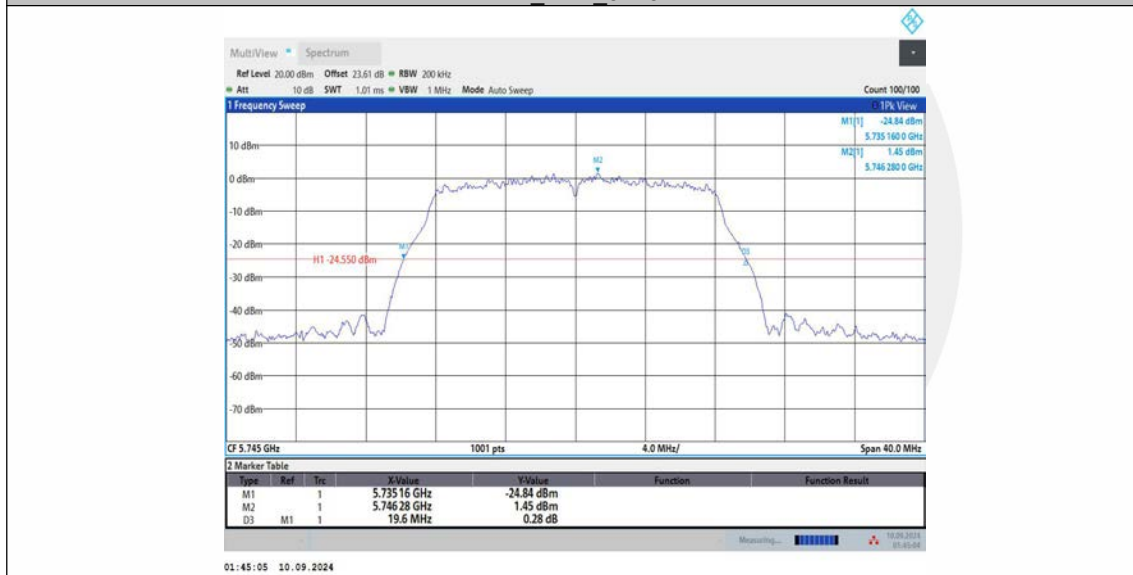

11A\_Ant1\_5785

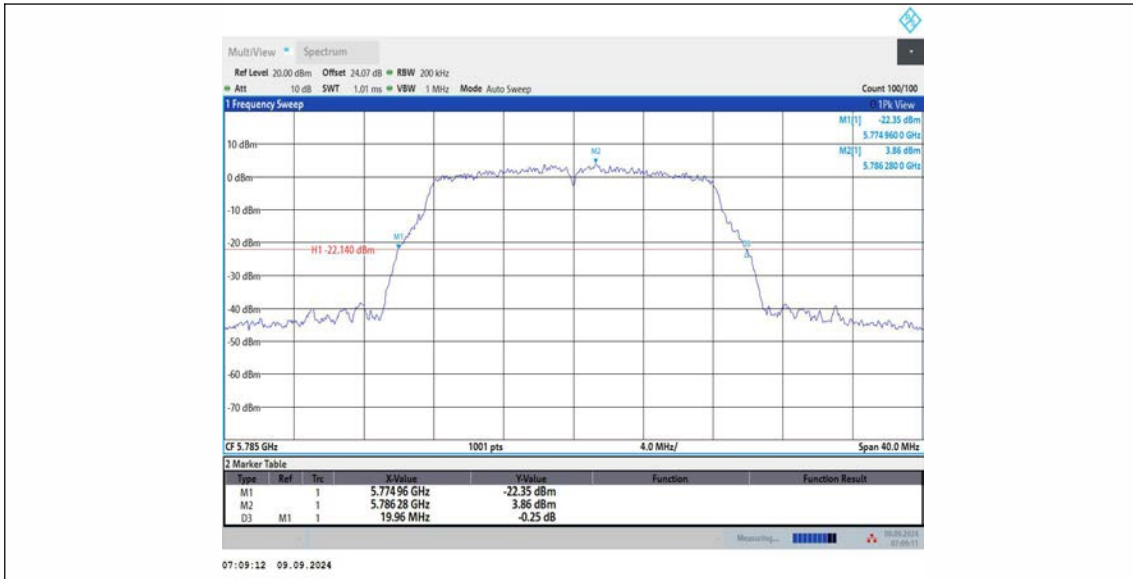

11A\_Ant2\_5785

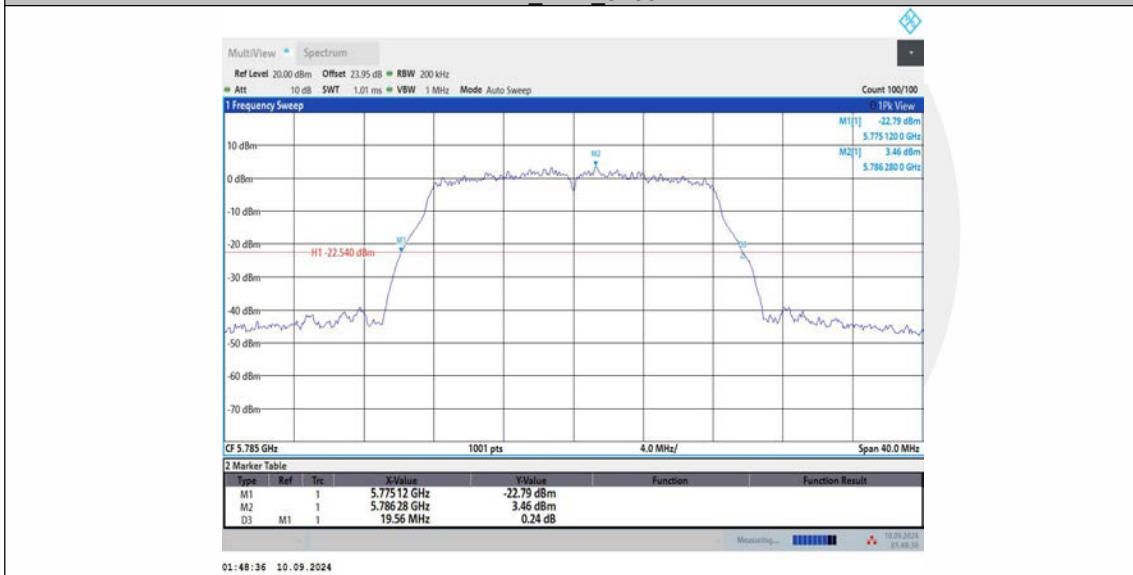

11A\_Ant1\_5825

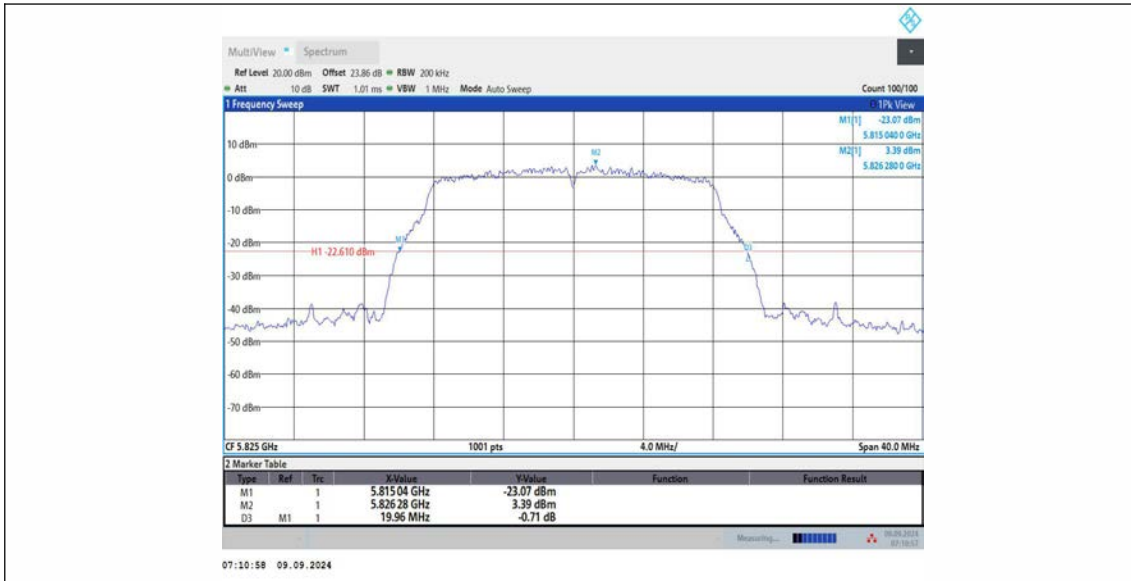

11A\_Ant2\_5825

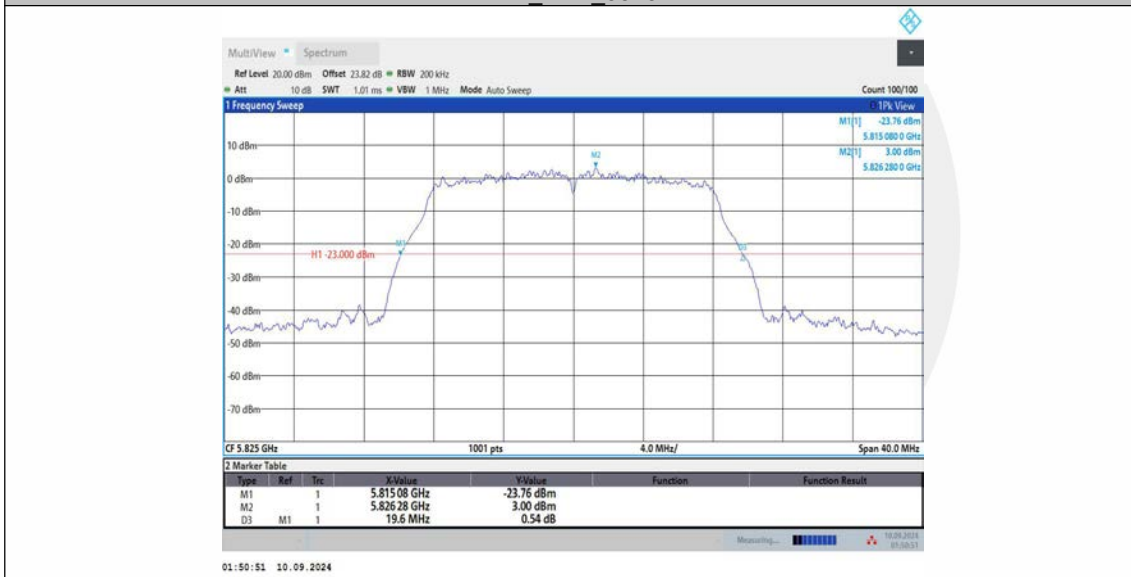

11N20MIMO Ant1\_5180

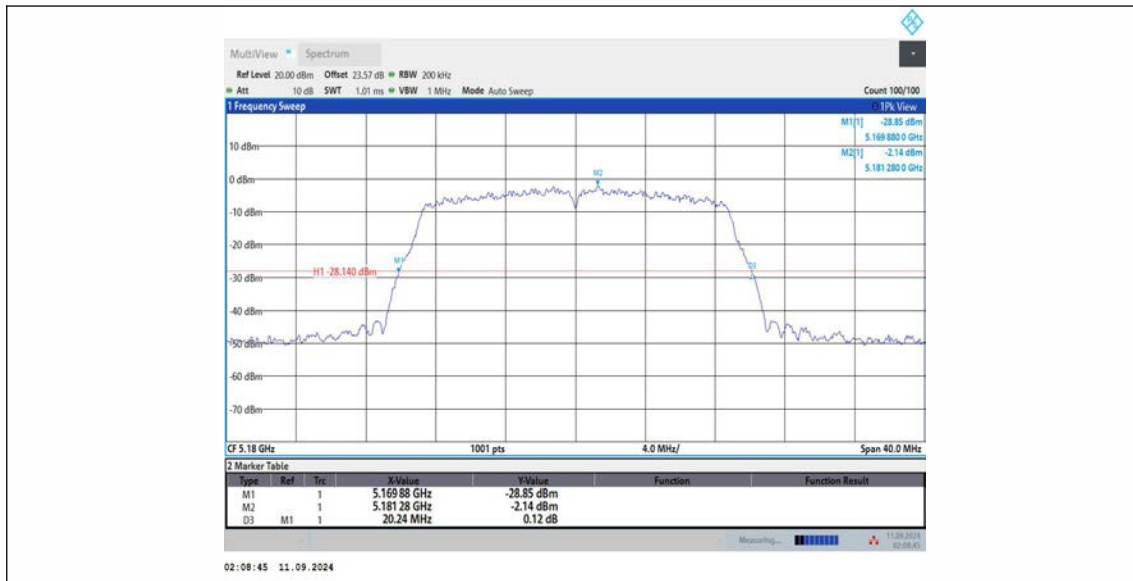

11N20MIMO\_Ant2\_5180

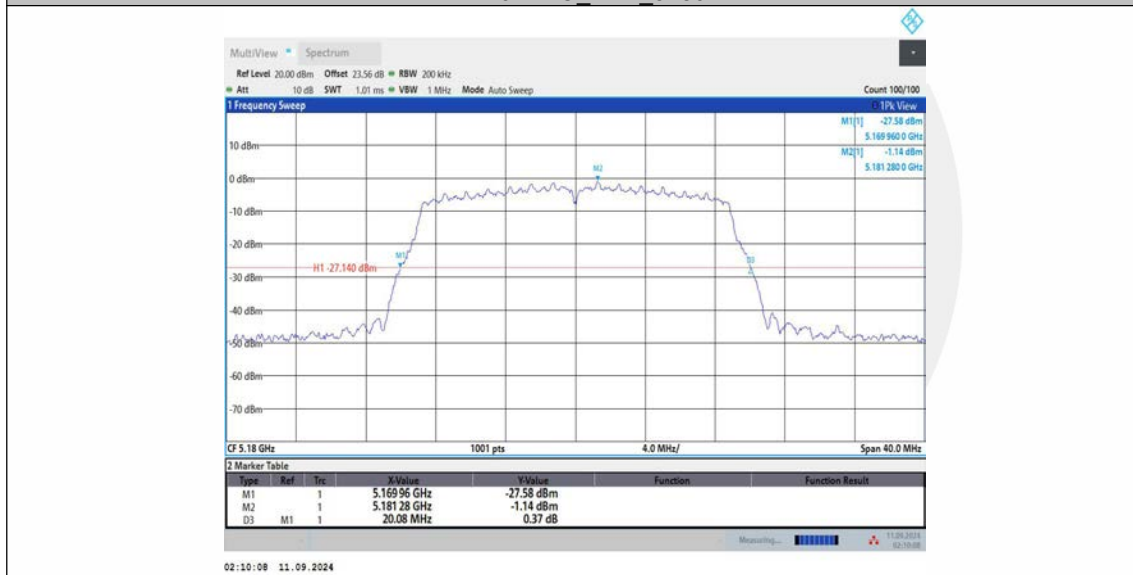

11N20MIMO\_Ant1\_5200

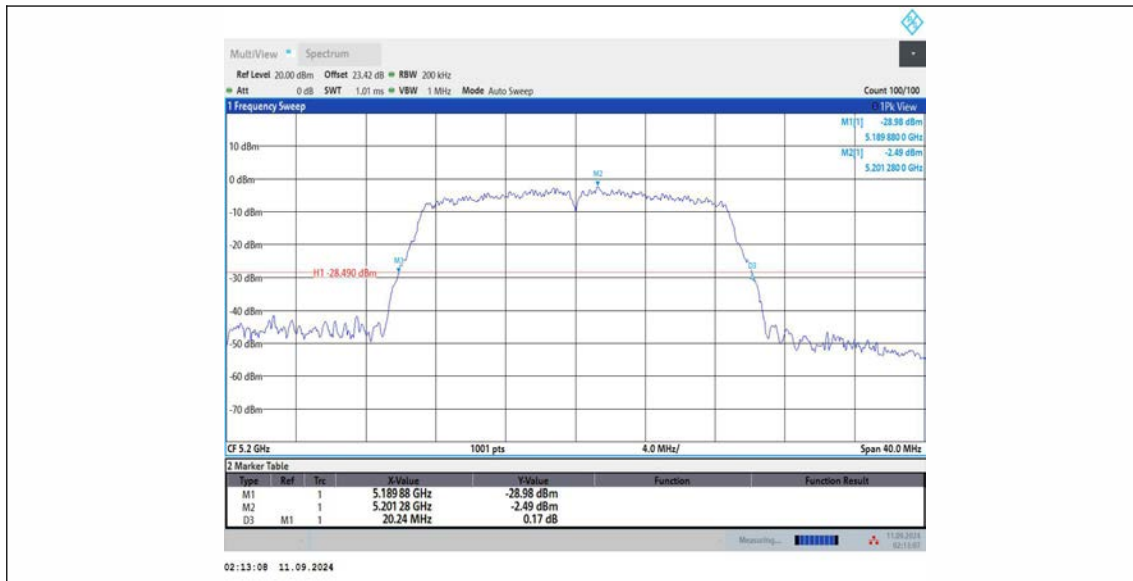

11N20MIMO\_Ant2\_5200

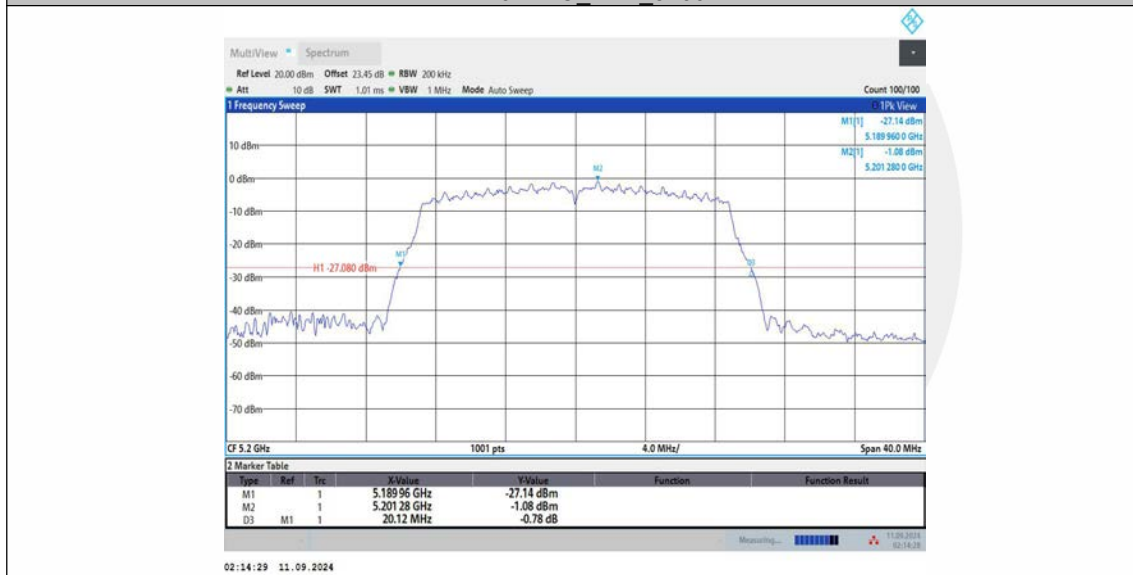

11N20MIMO\_Ant1\_5240

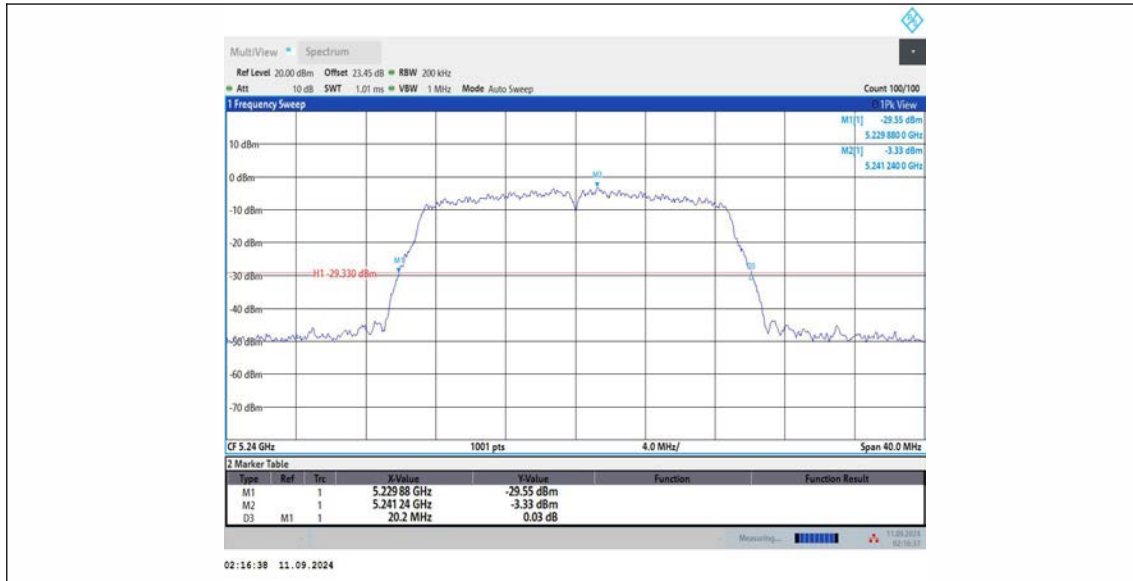

11N20MIMO\_Ant2\_5240

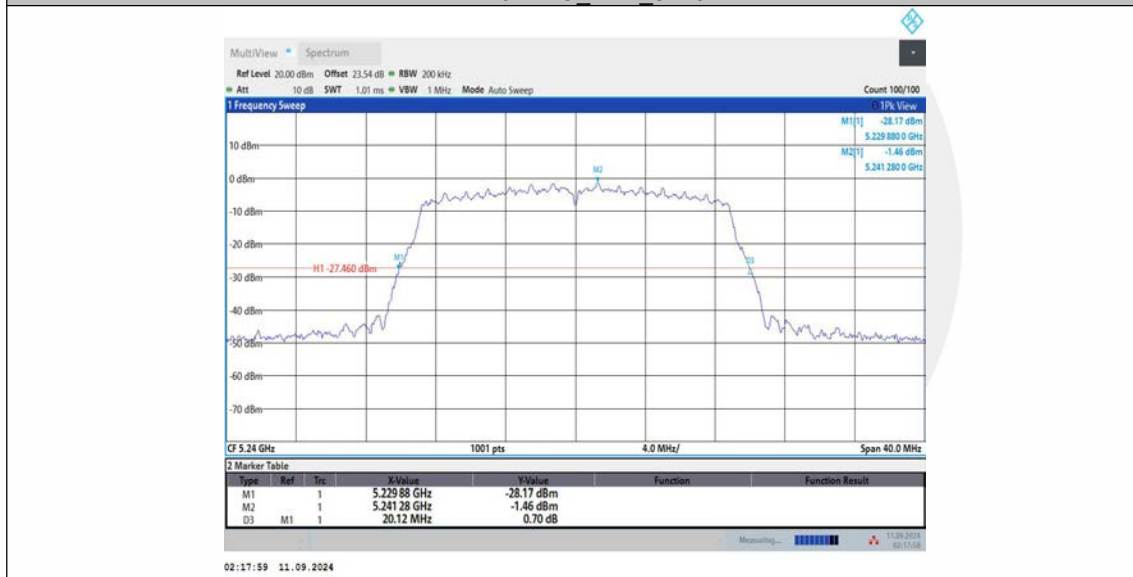

11N20MIMO Ant1\_5260

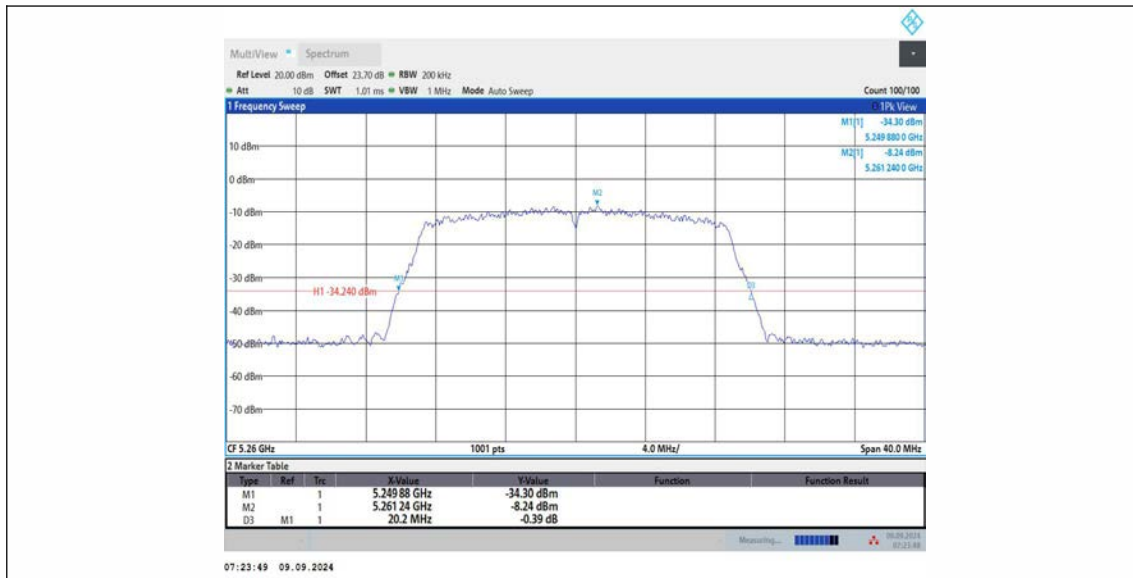

11N20MIMO\_Ant2\_5260

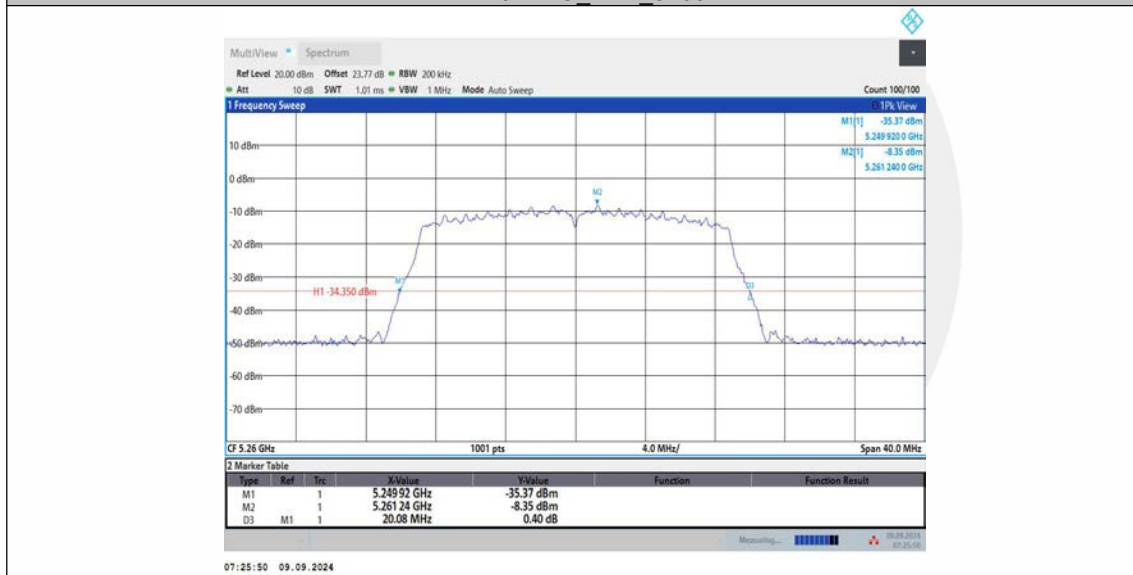

11N20MIMO\_Ant1\_5280

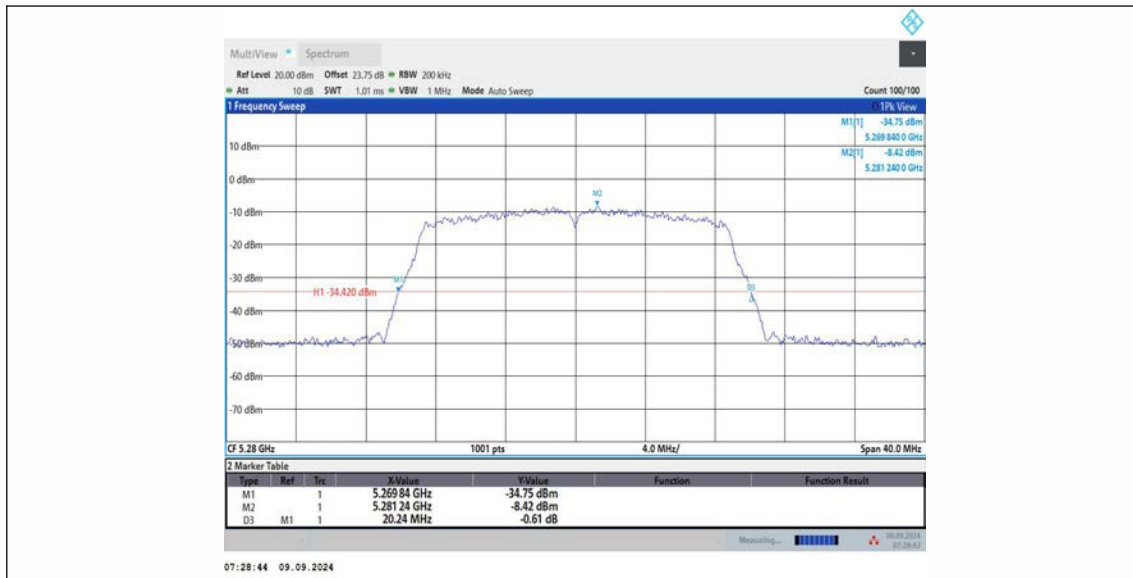

11N20MIMO\_Ant2\_5280

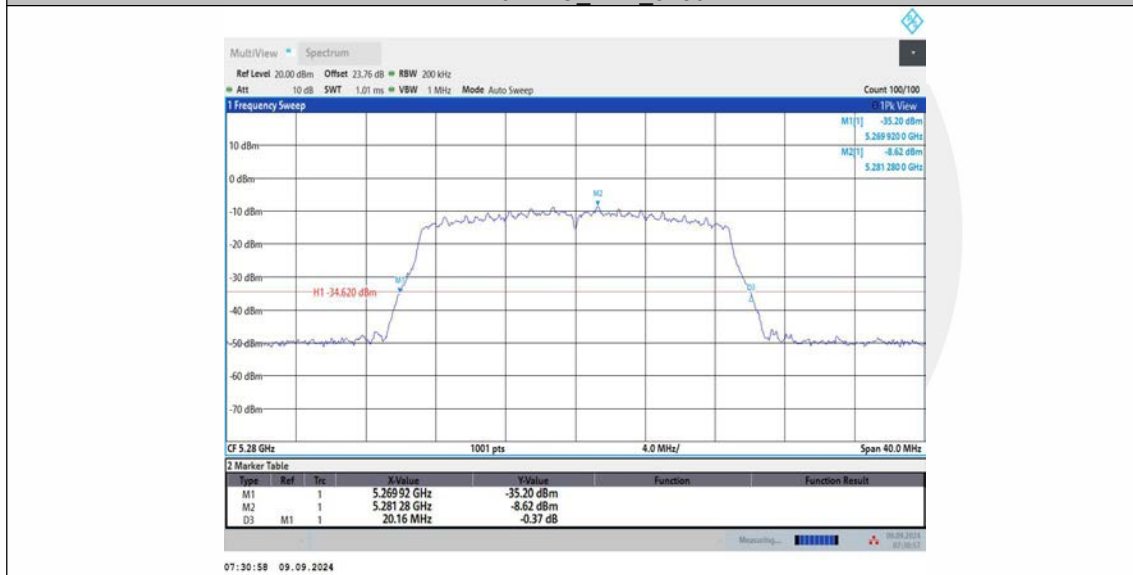

11N20MIMO\_Ant1\_5320



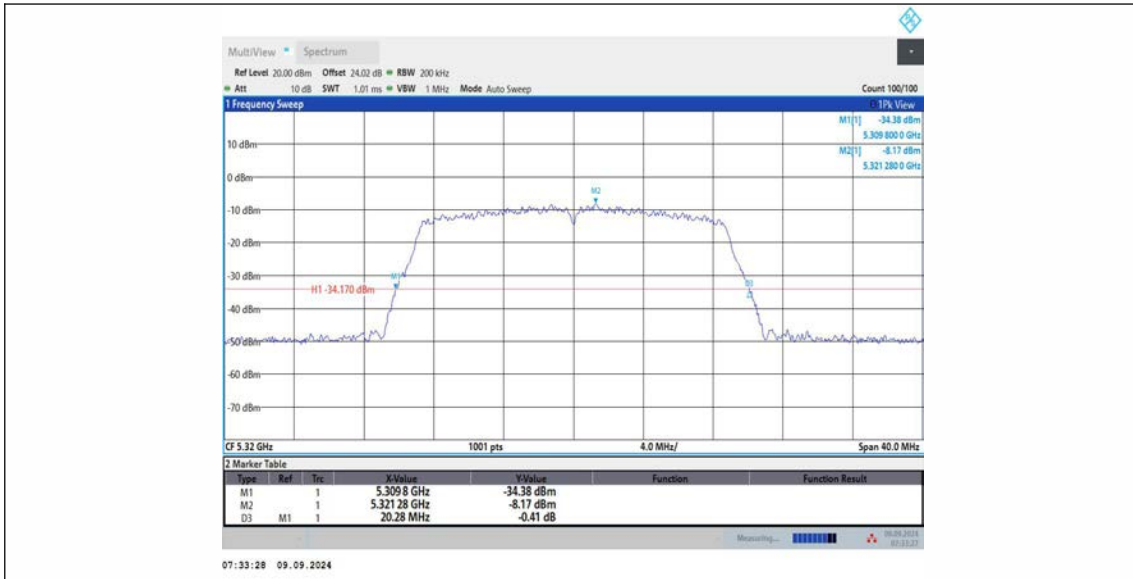

11N20MIMO\_Ant2\_5320

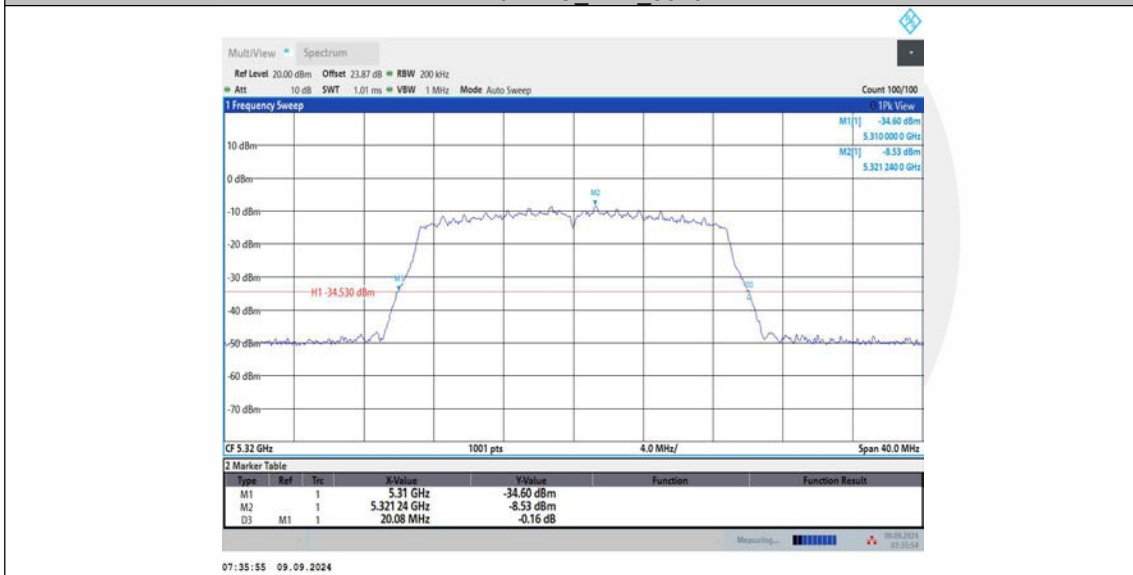

11N20MIMO\_Ant1\_5500

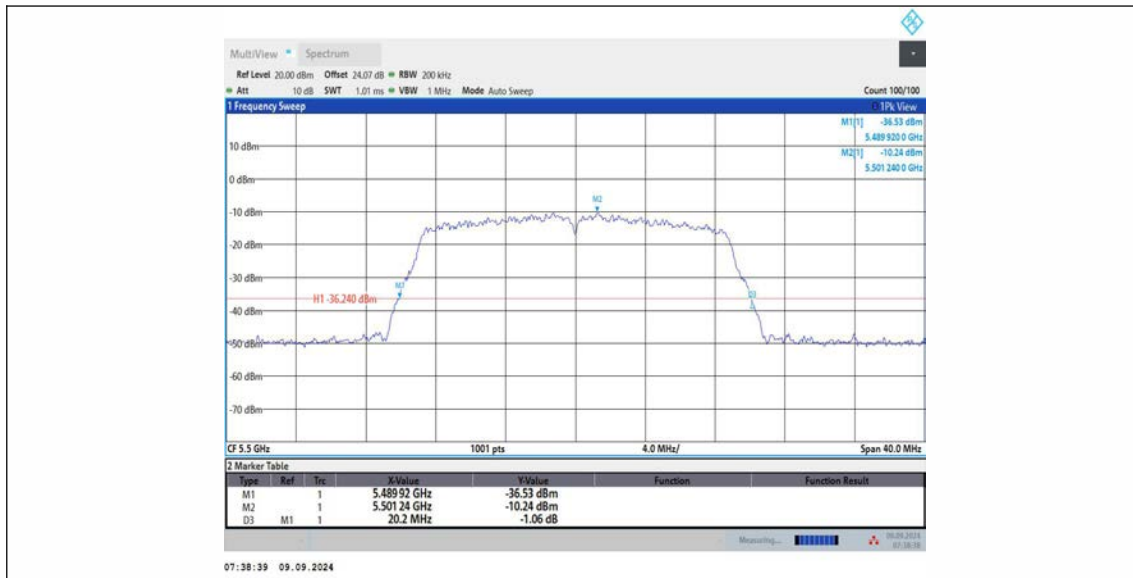

11N20MIMO\_Ant2\_5500

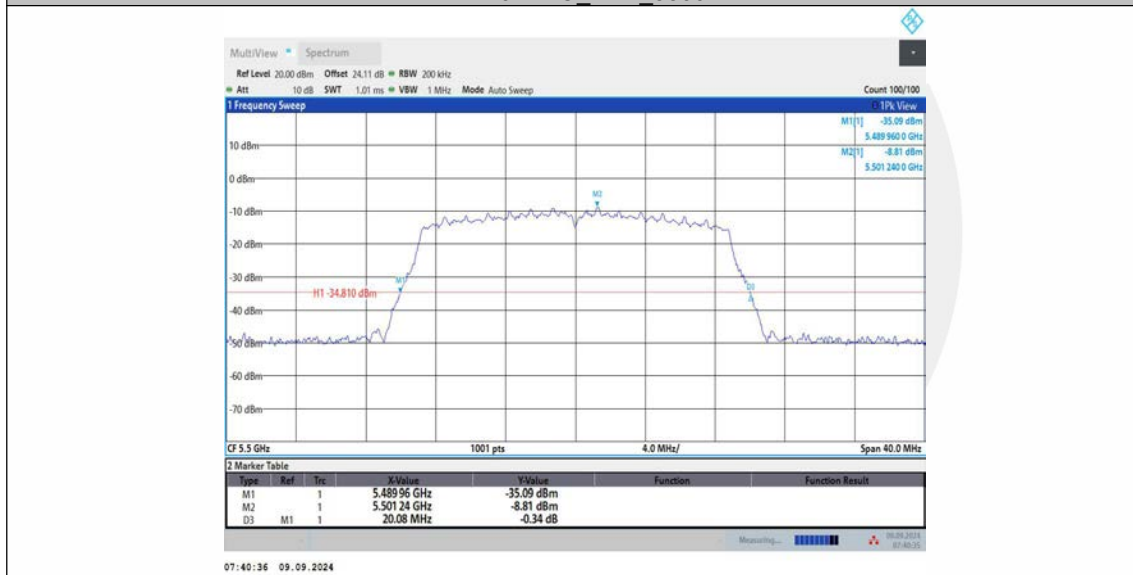

11N20MIMO\_Ant1\_5580

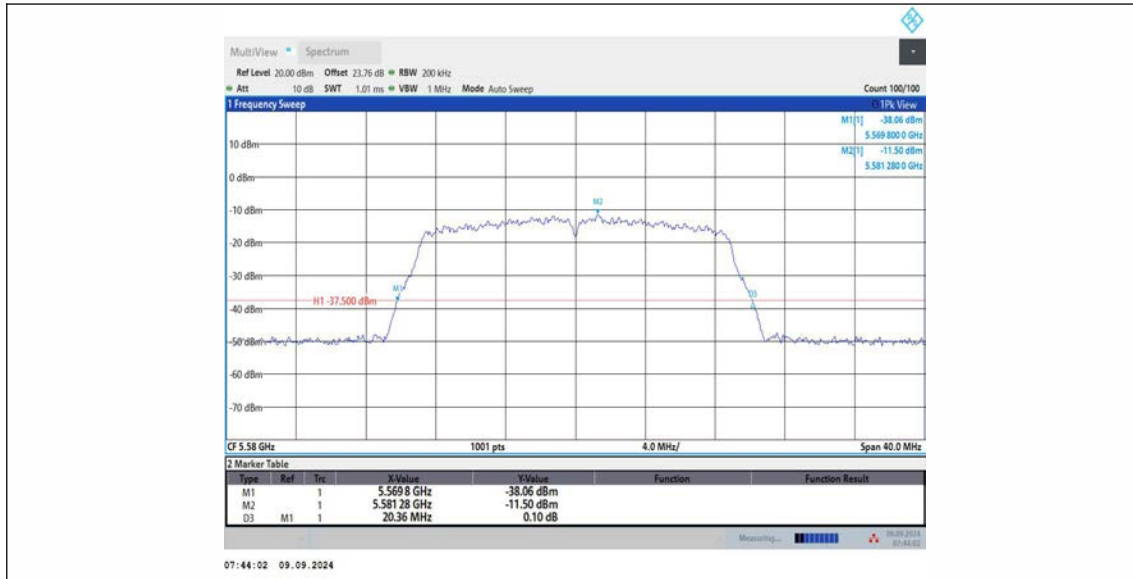

11N20MIMO\_Ant2\_5580

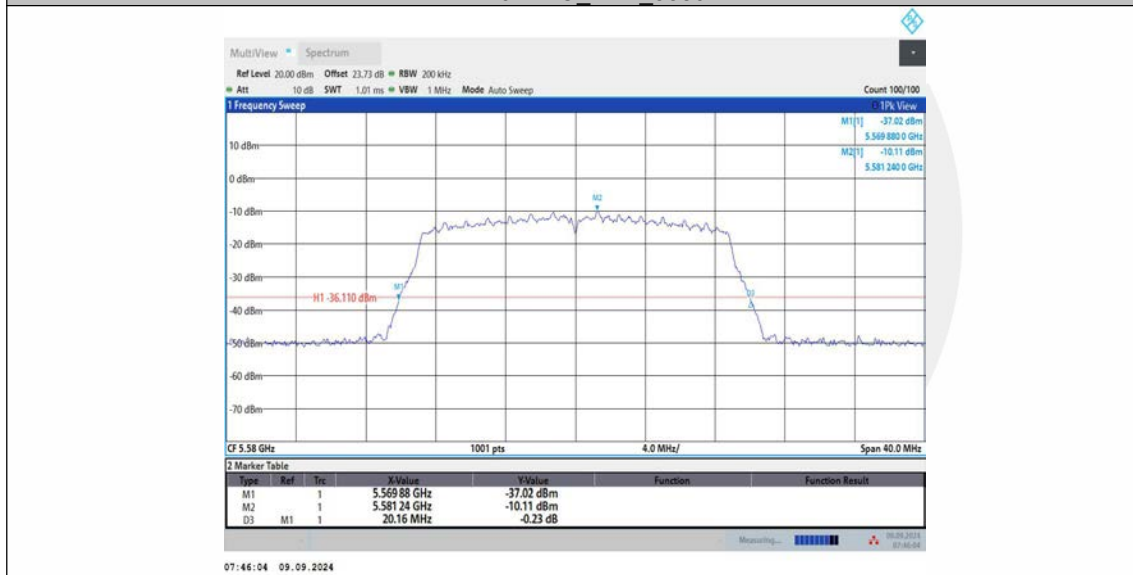

11N20MIMO Ant1\_5700

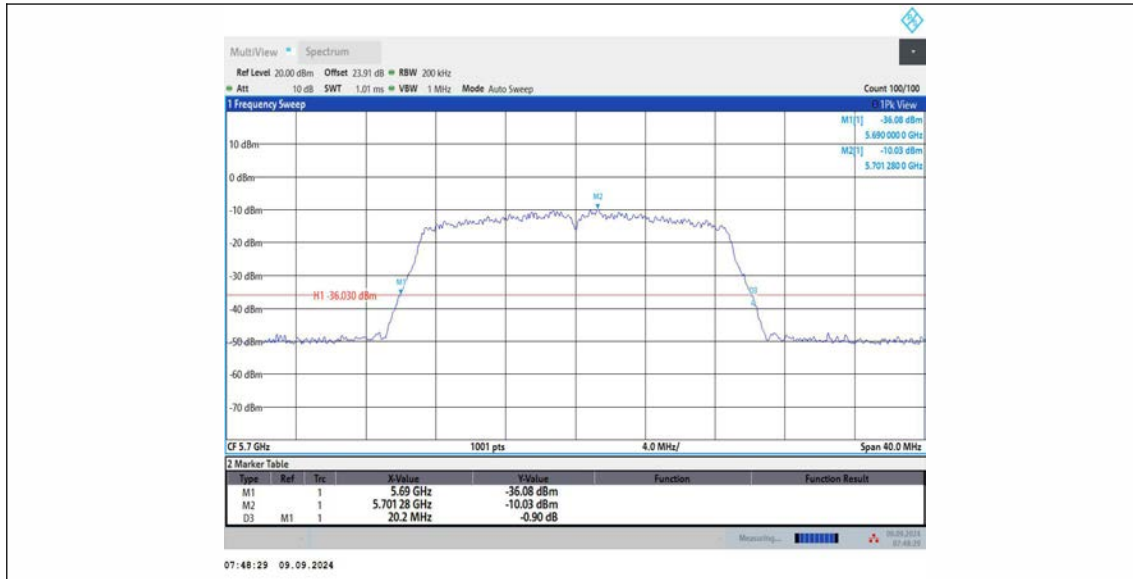

11N20MIMO\_Ant2\_5700

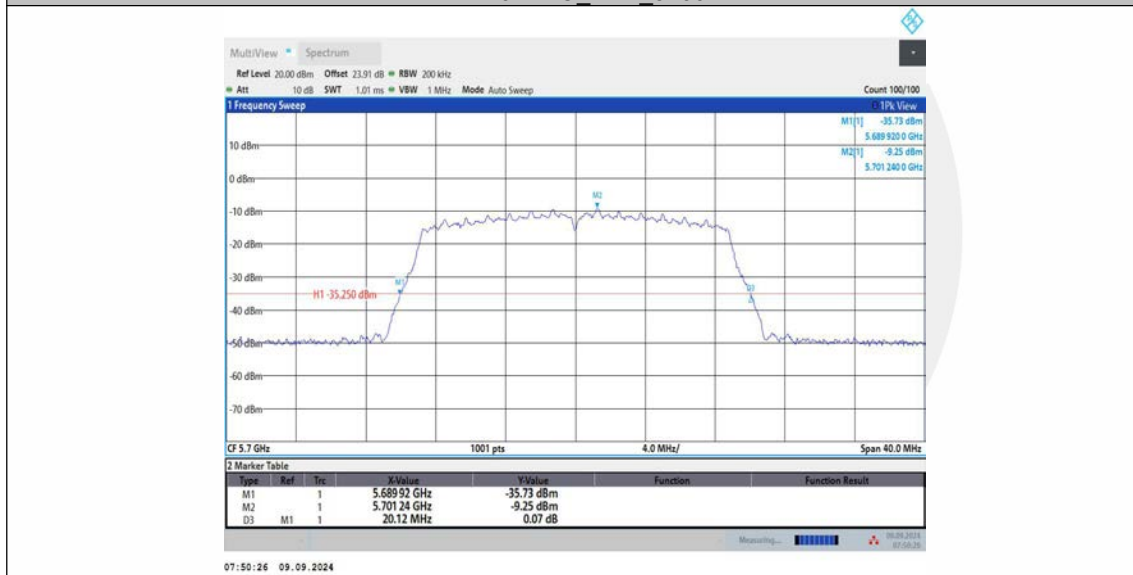

11N20MIMO\_Ant1\_5745



11N20MIMO\_Ant2\_5745

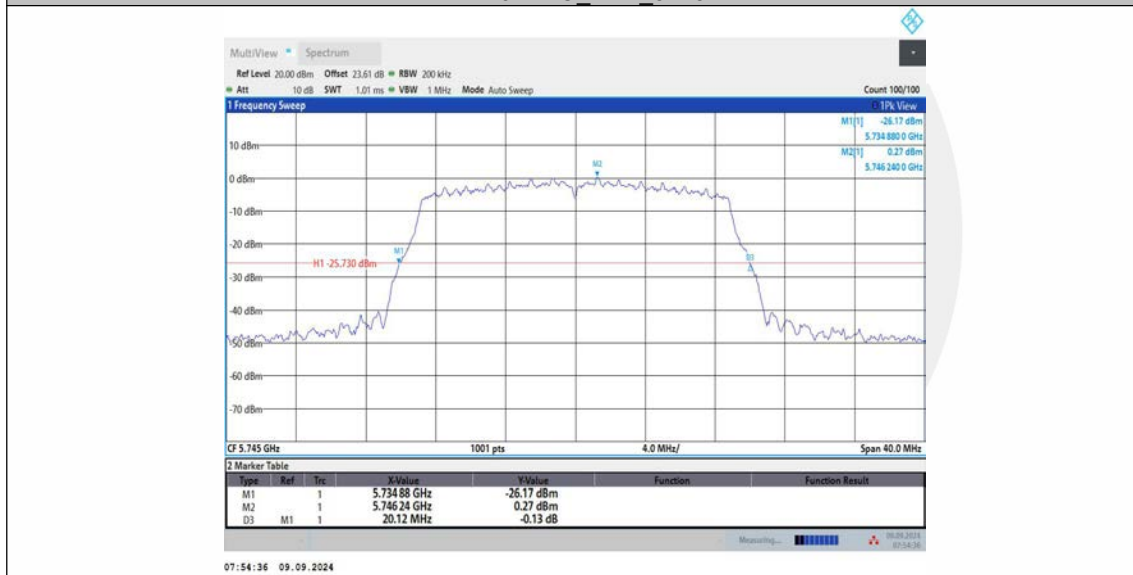

11N20MIMO\_Ant1\_5785

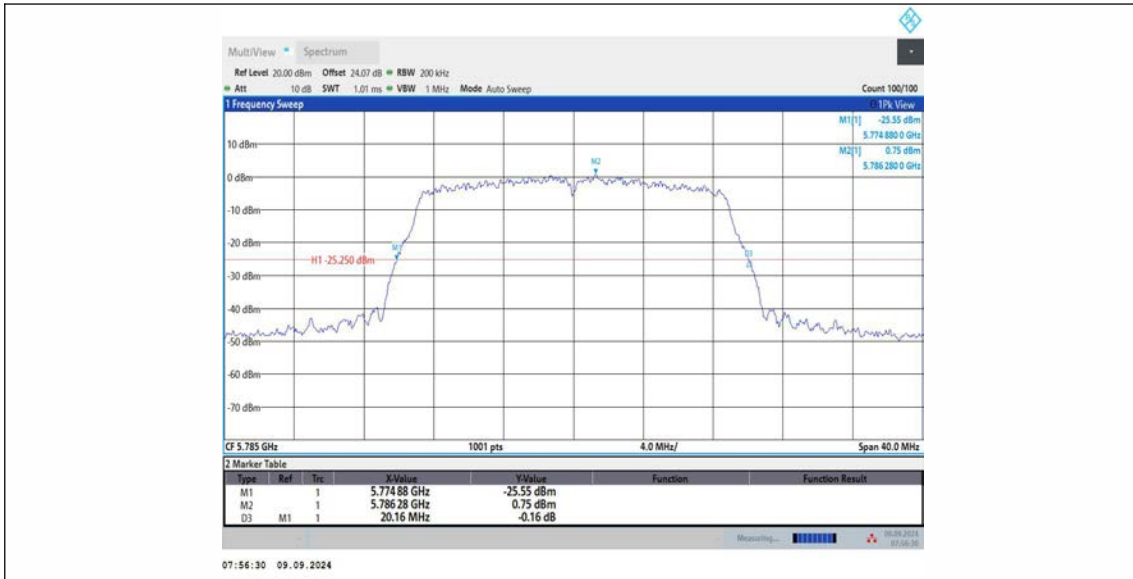

11N20MIMO\_Ant2\_5785

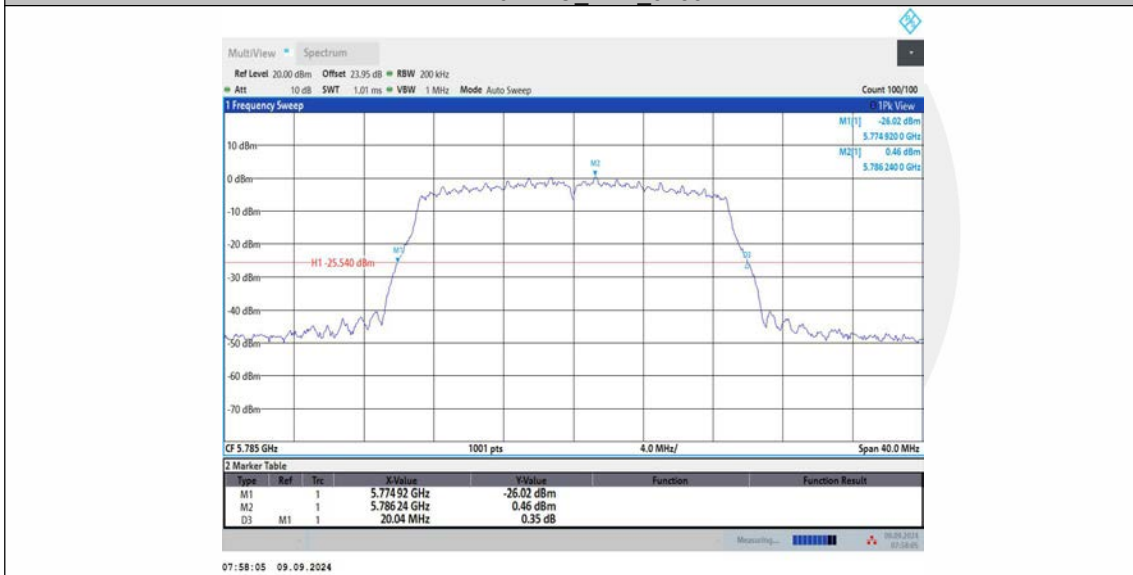

11N20MIMO\_Ant1\_5825

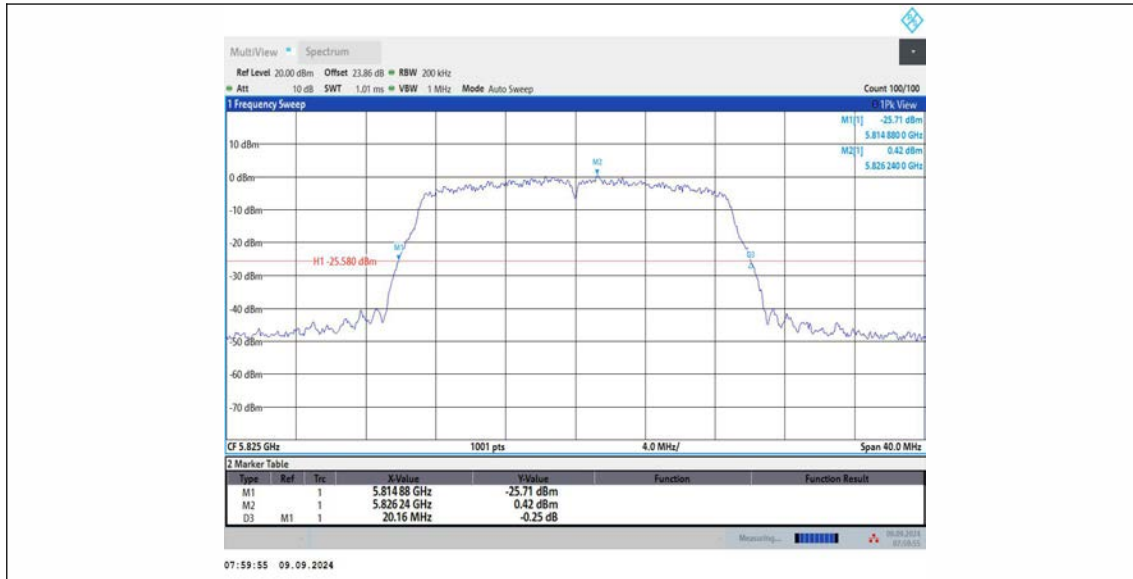

11N20MIMO\_Ant2\_5825

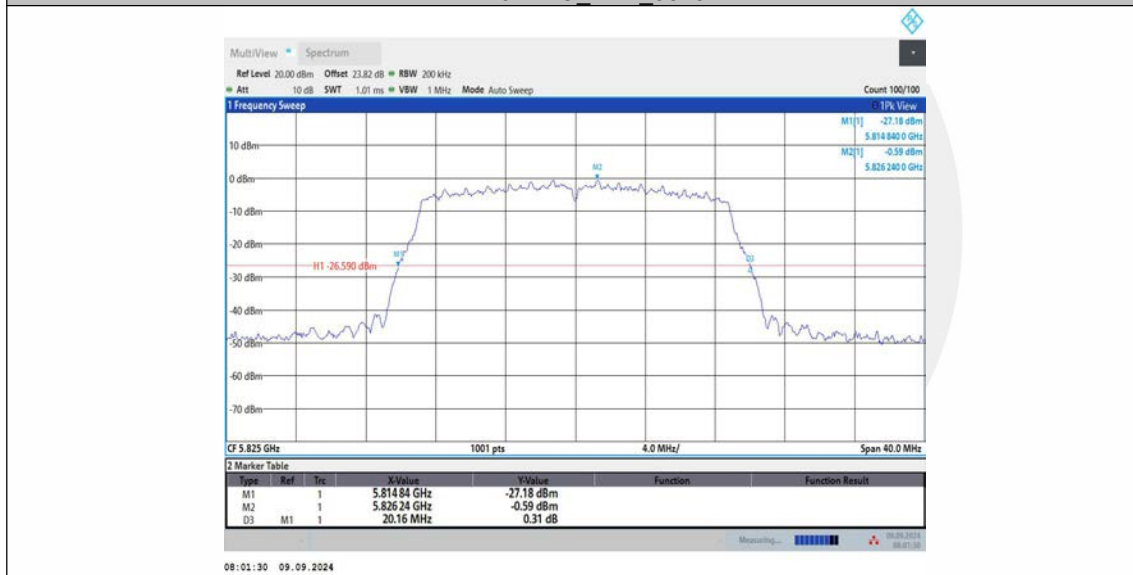

11N40MIMO\_Ant1\_5190



11N40MIMO\_Ant2\_5190

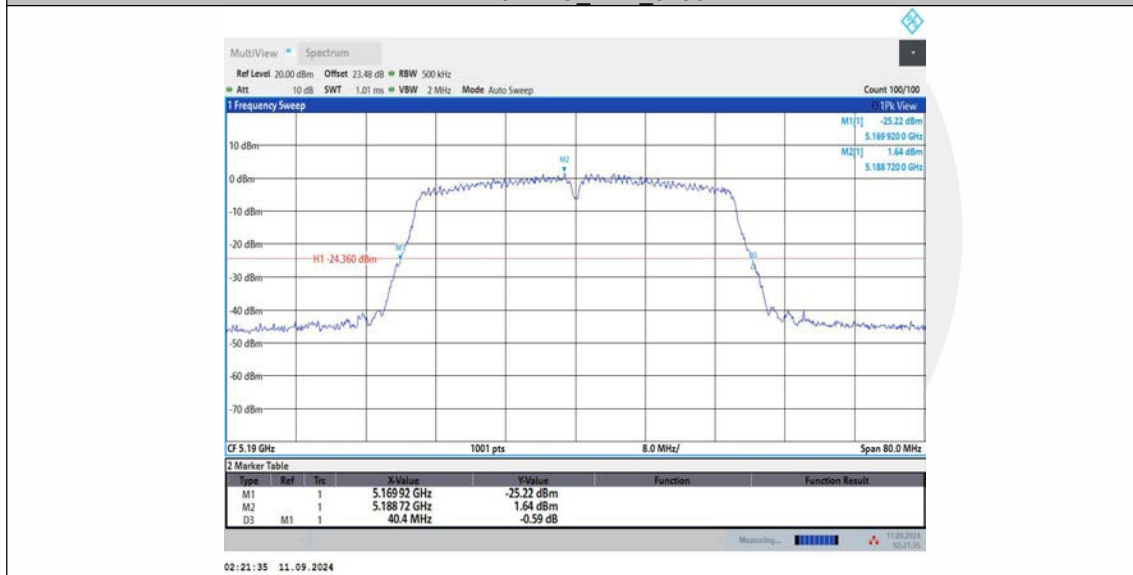

11N40MIMO\_Ant1\_5230



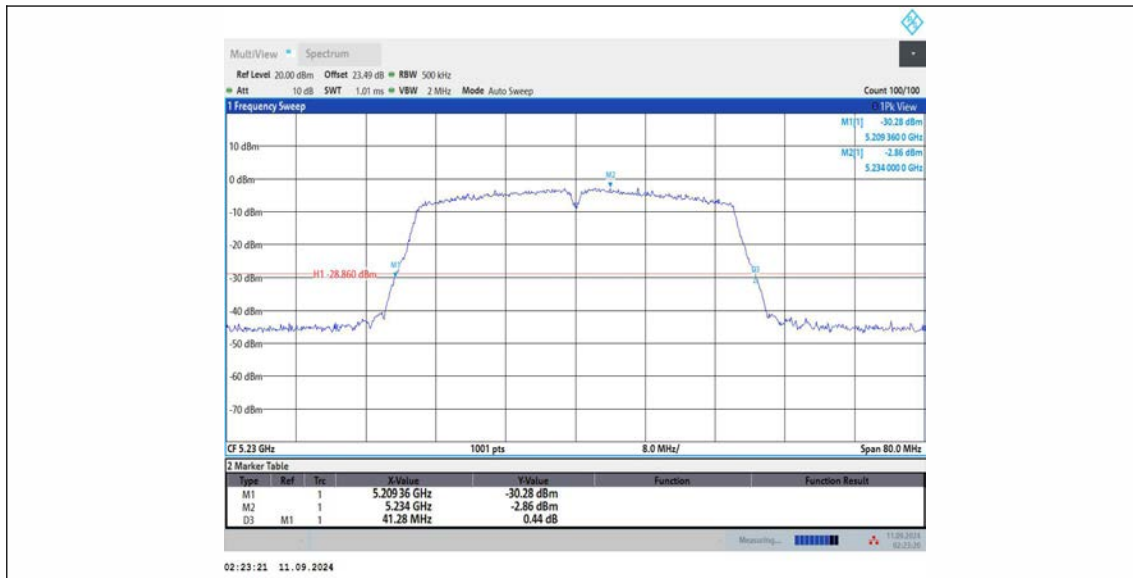

11N40MIMO\_Ant2\_5230

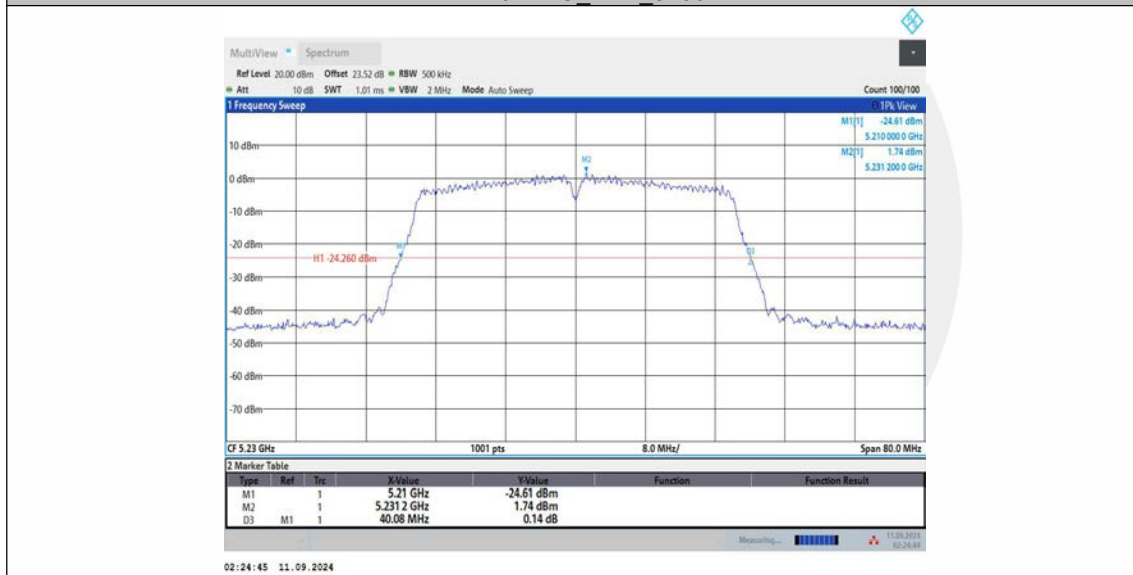

11N40MIMO\_Ant1\_5270

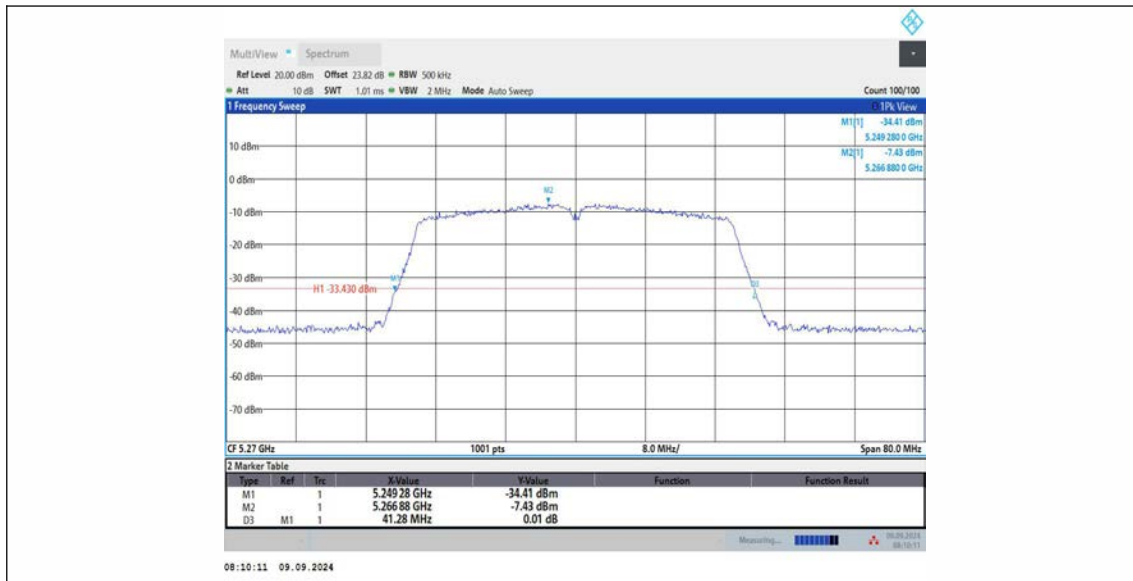

11N40MIMO\_Ant2\_5270

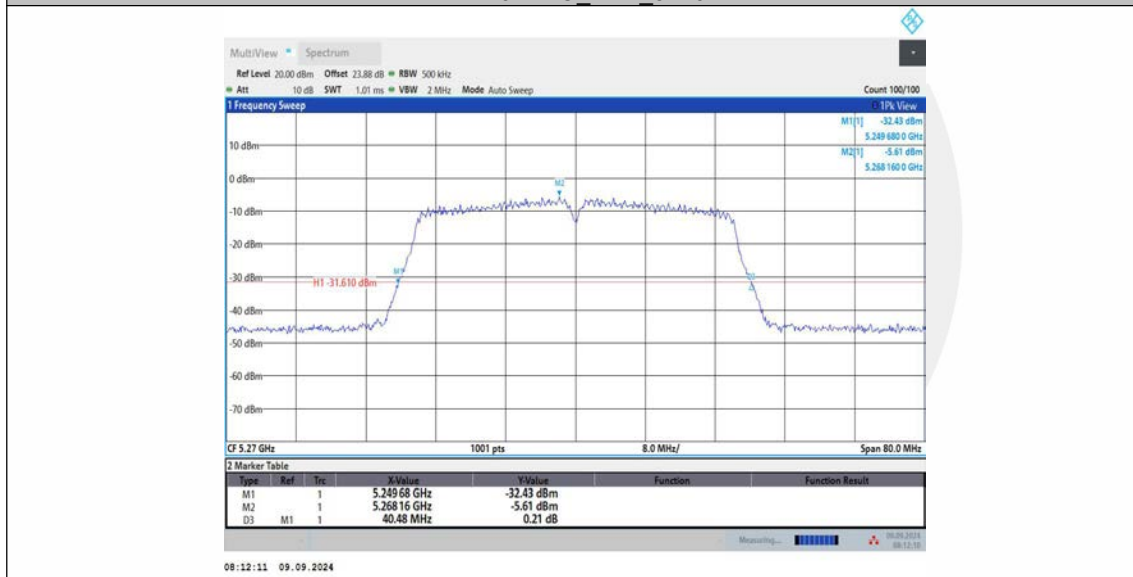

11N40MIMO\_Ant1\_5310

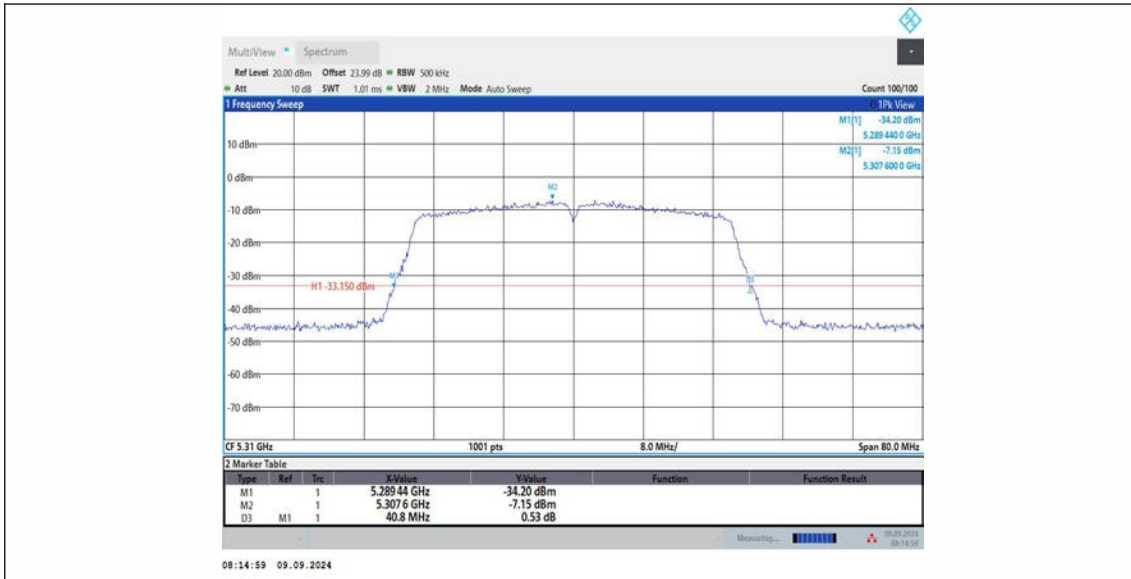

11N40MIMO\_Ant2\_5310

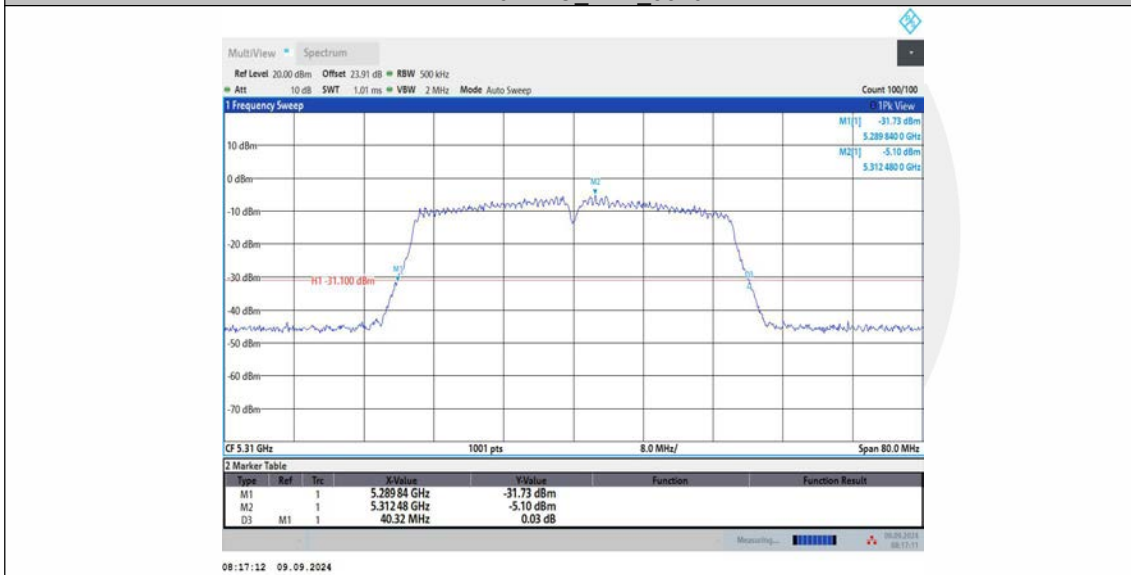

11N40MIMO Ant1\_5510

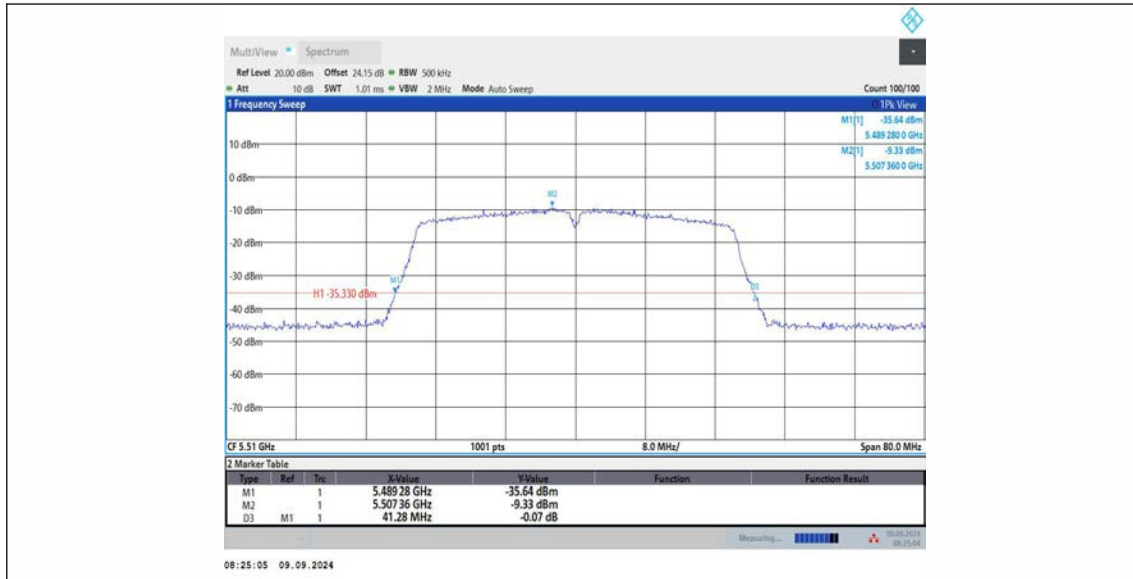

11N40MIMO\_Ant2\_5510

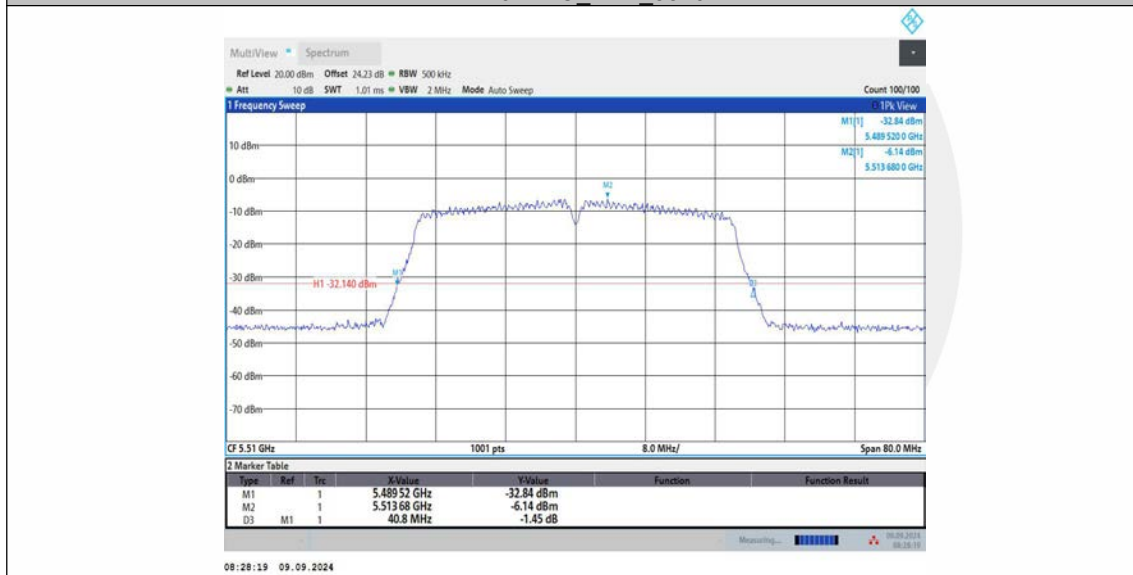

11N40MIMO\_Ant1\_5550

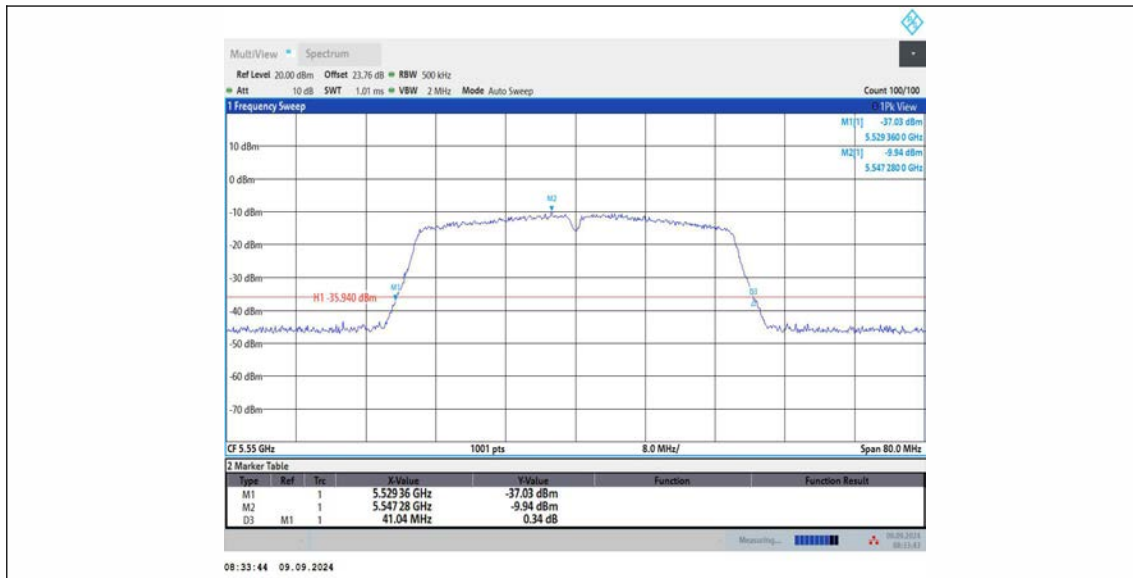

11N40MIMO\_Ant2\_5550

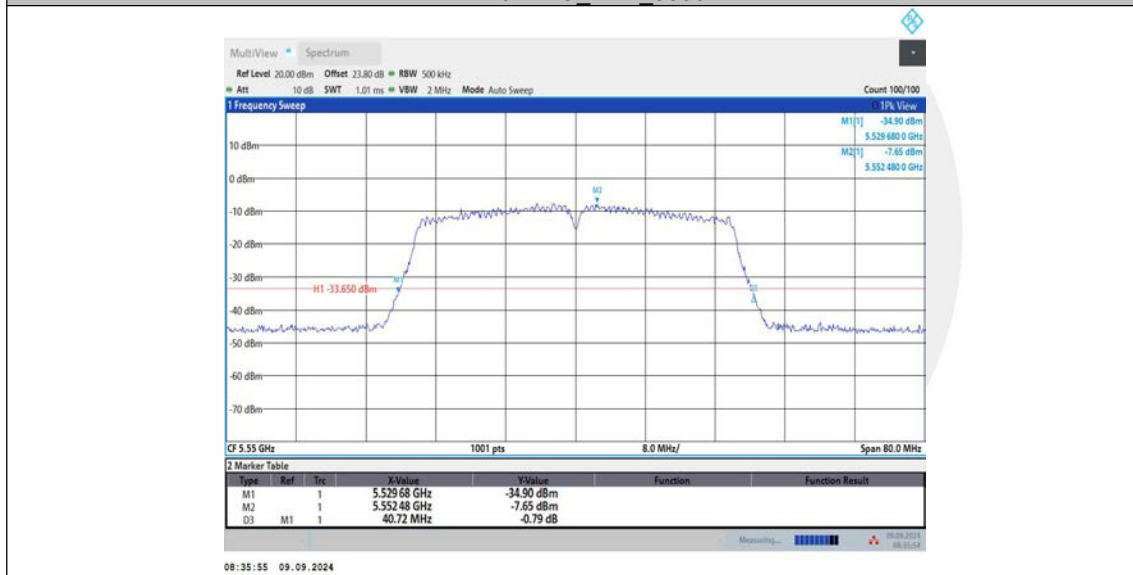

11N40MIMO\_Ant1\_5670

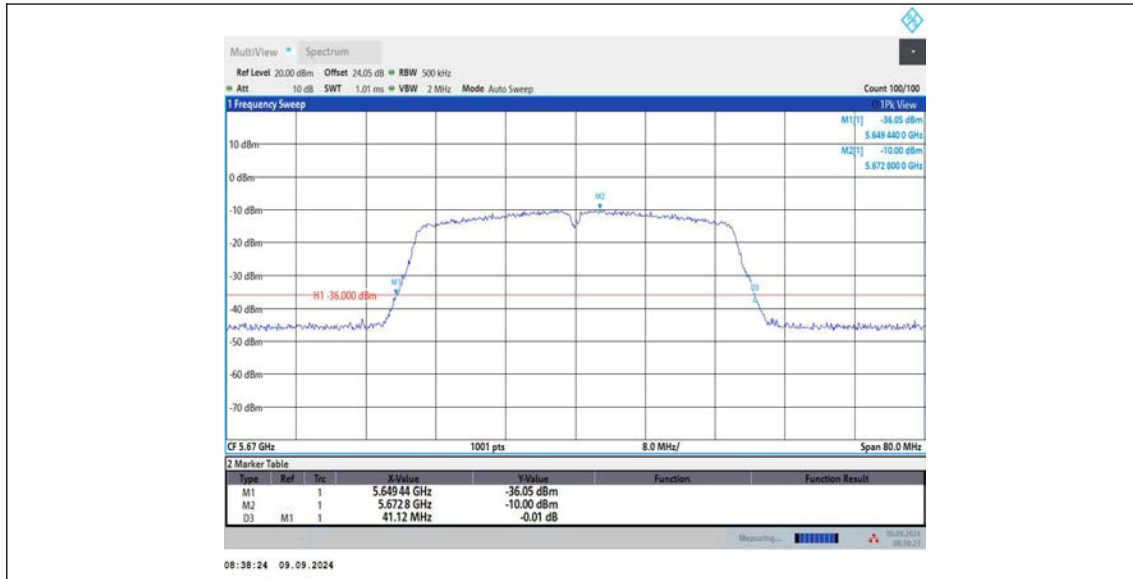

11N40MIMO\_Ant2\_5670

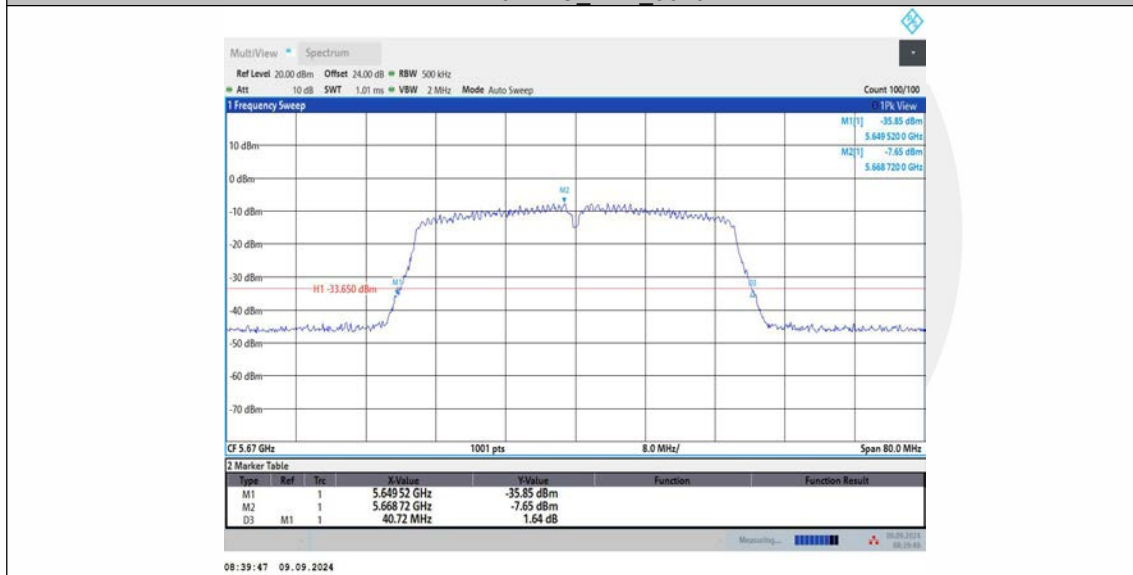

11N40MIMO\_Ant1\_5755

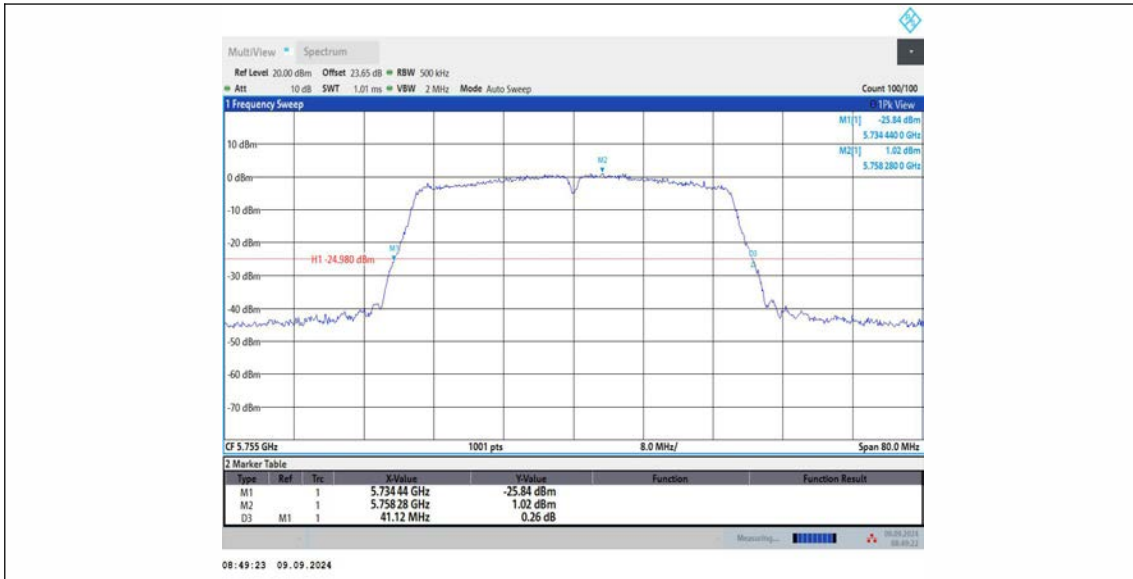

11N40MIMO\_Ant2\_5755



11N40MIMO\_Ant1\_5795

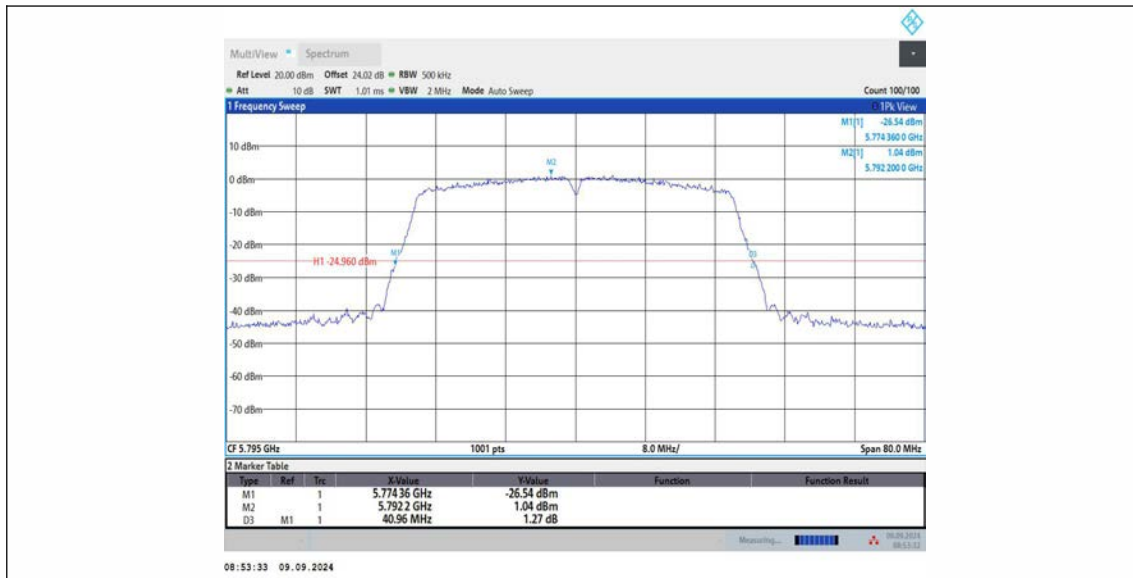

11N40MIMO\_Ant2\_5795



11AC20MIMO\_Ant1\_5180



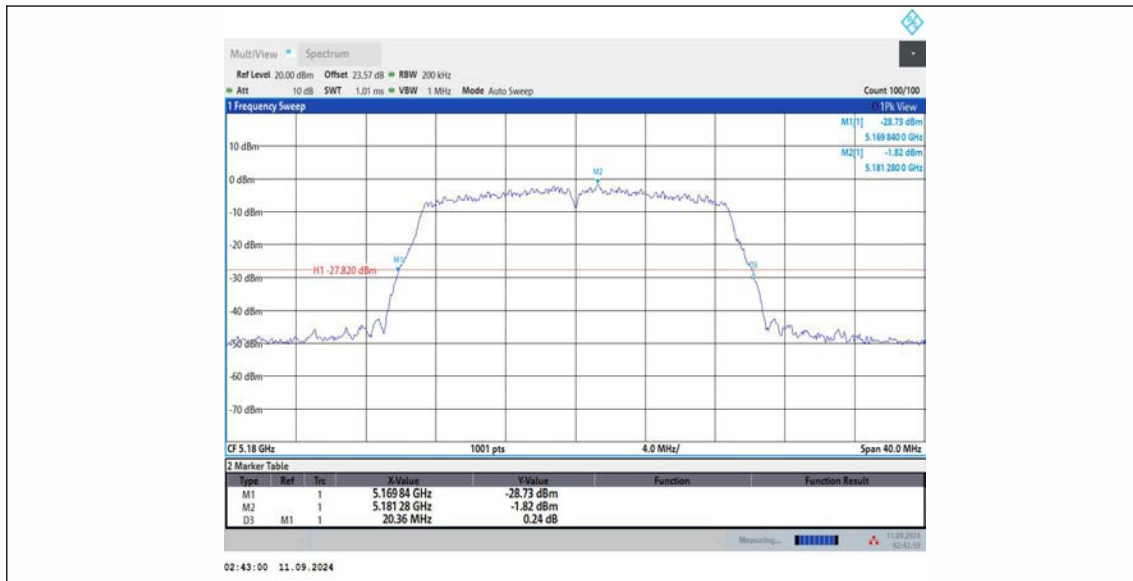

11AC20MIMO\_Ant2\_5180

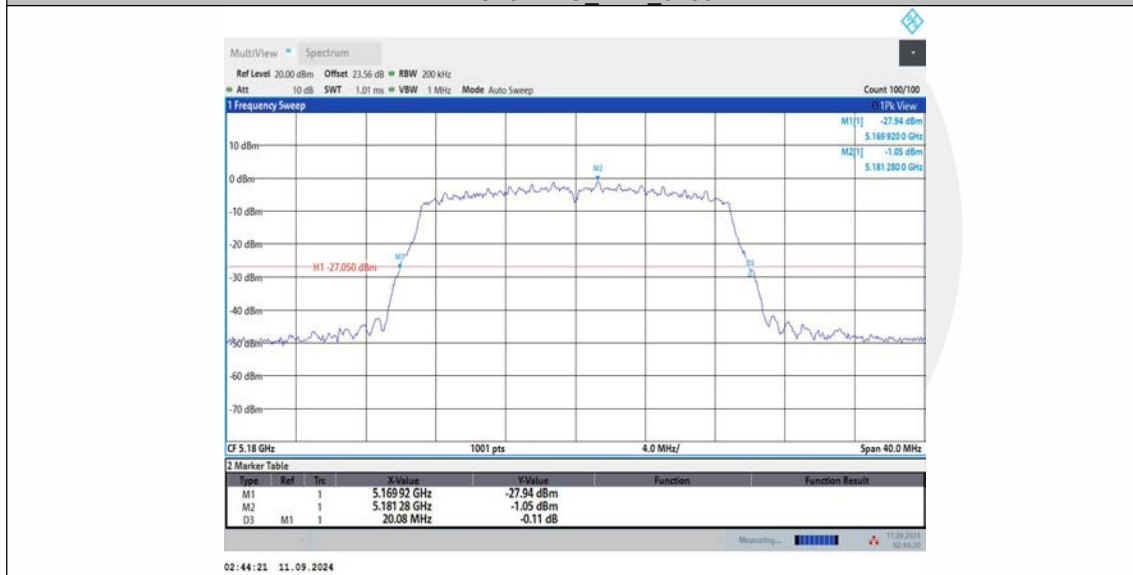

11AC20MIMO\_Ant1\_5200

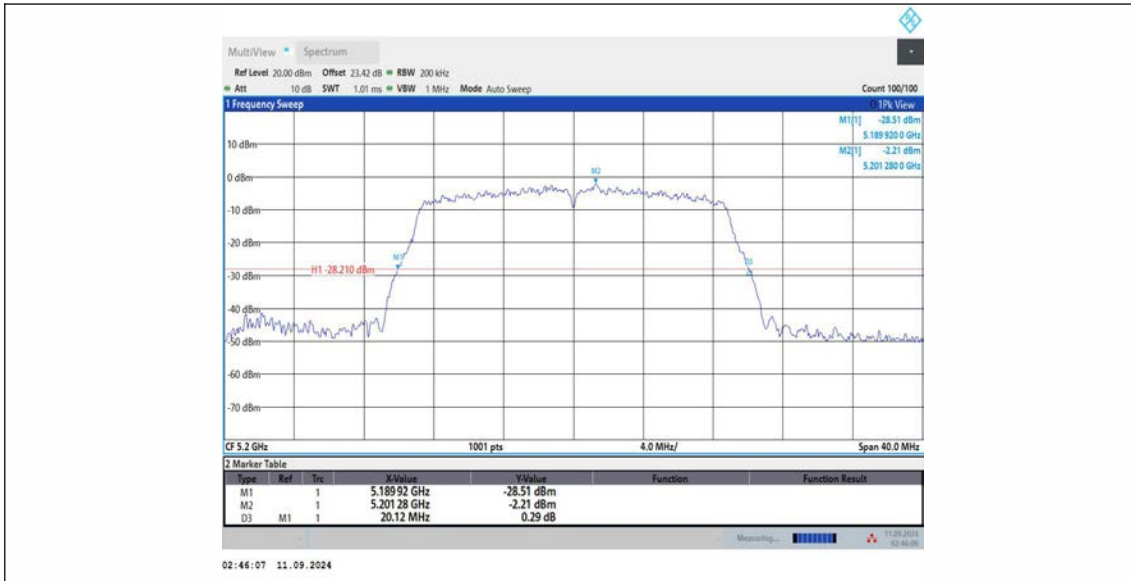

11AC20MIMO\_Ant2\_5200

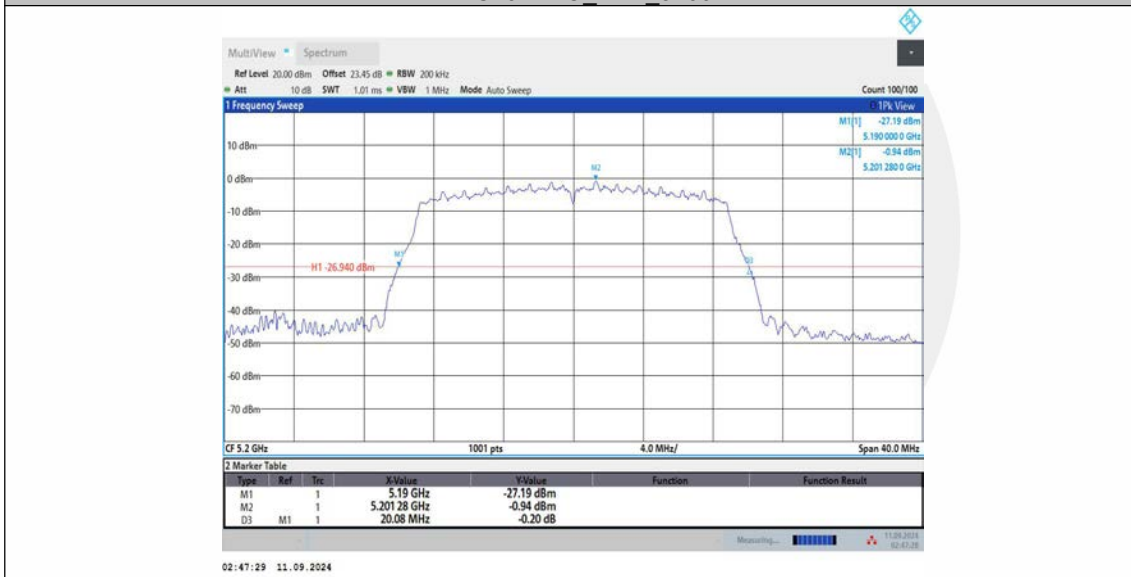

11AC20MIMO\_Ant1\_5240

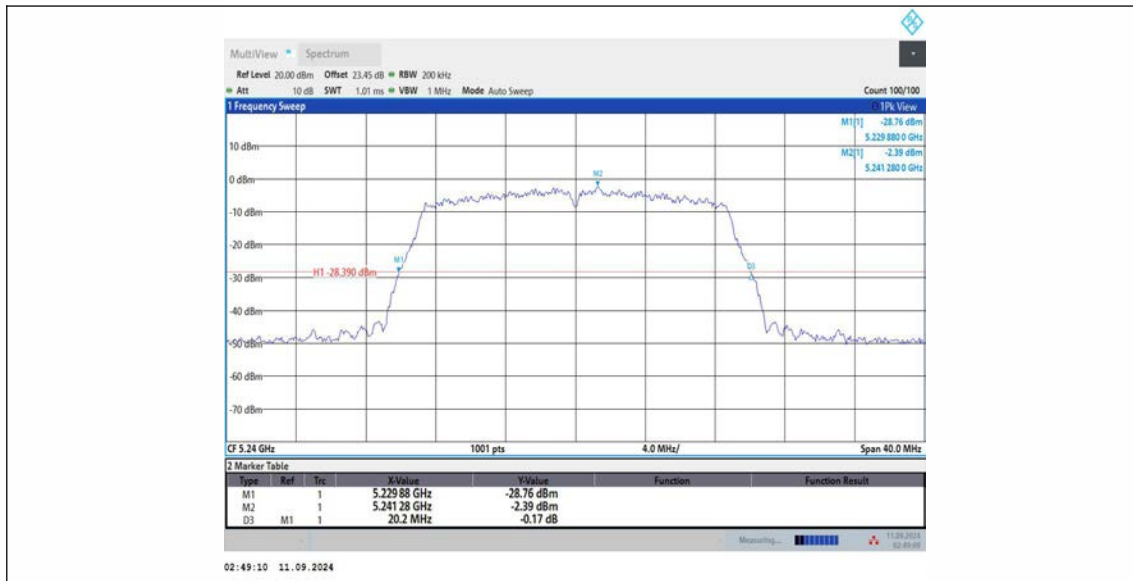

11AC20MIMO\_Ant2\_5240

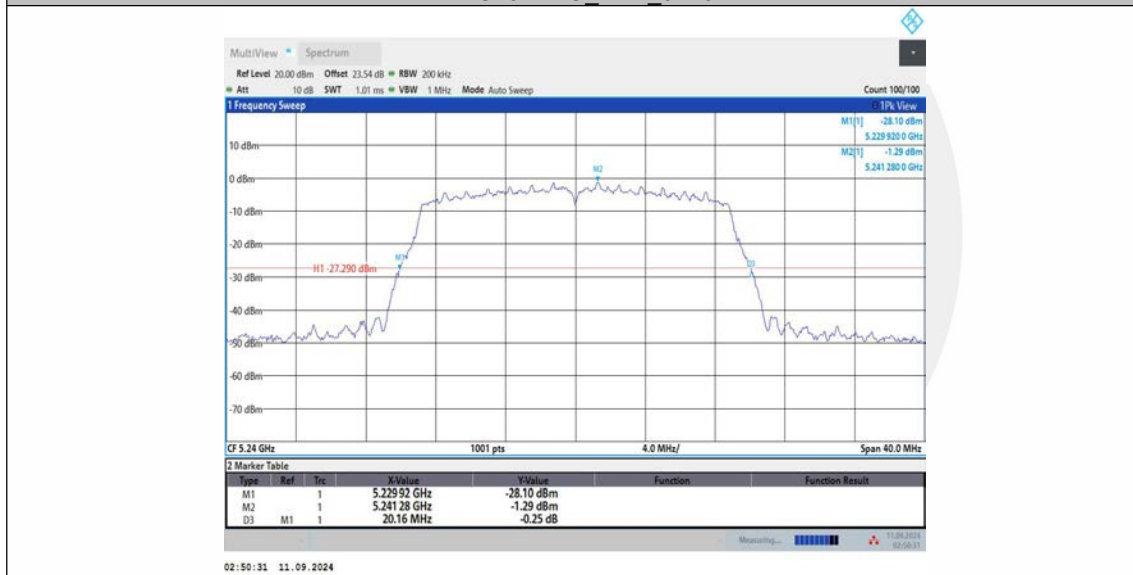

11AC20MIMO\_Ant1\_5260

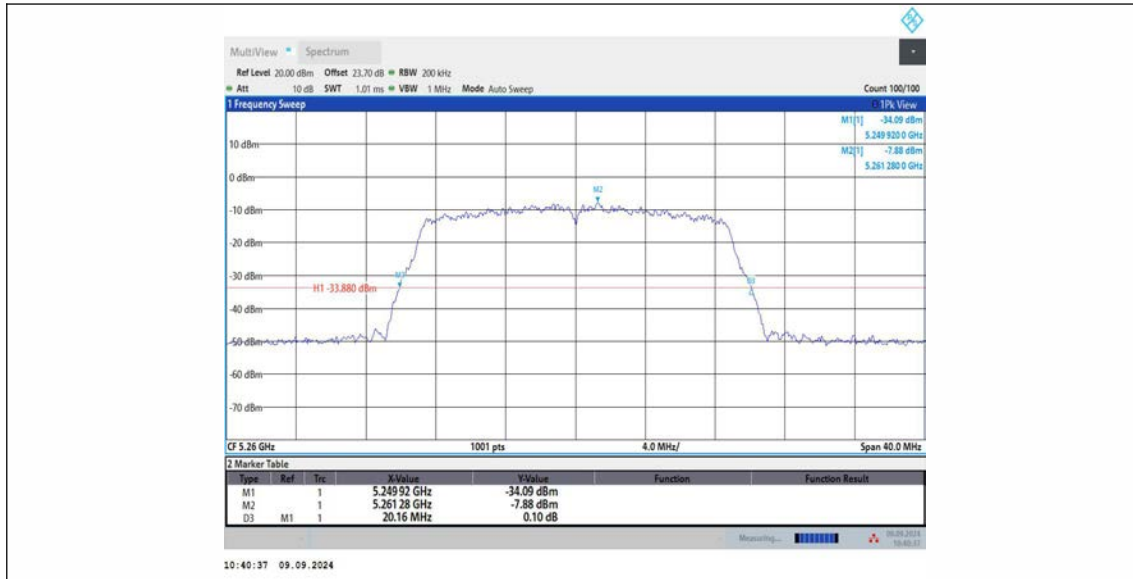

11AC20MIMO\_Ant2\_5260

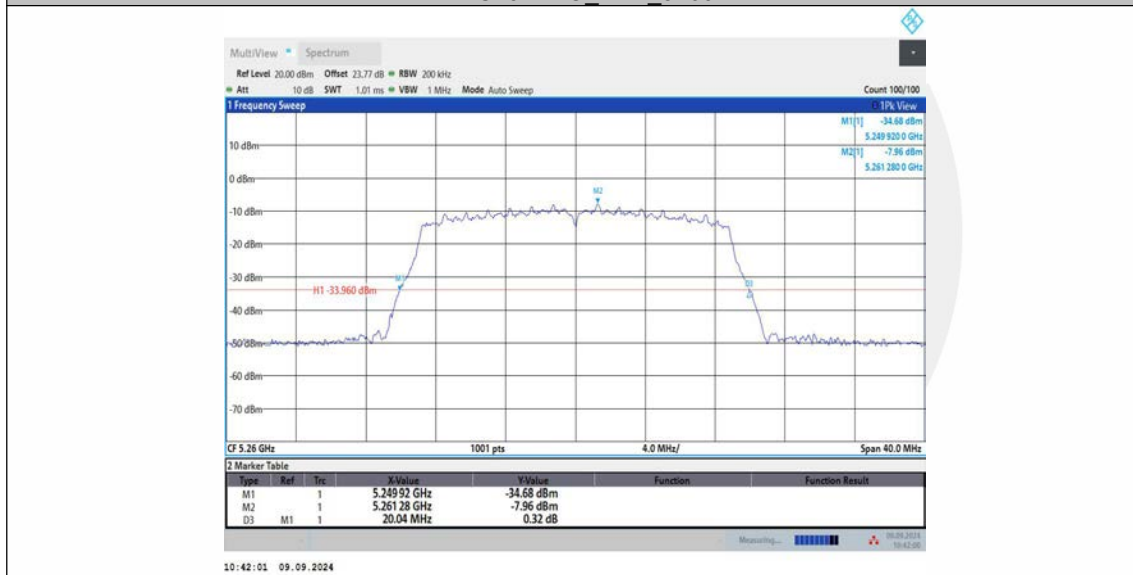

11AC20MIMO\_Ant1\_5280

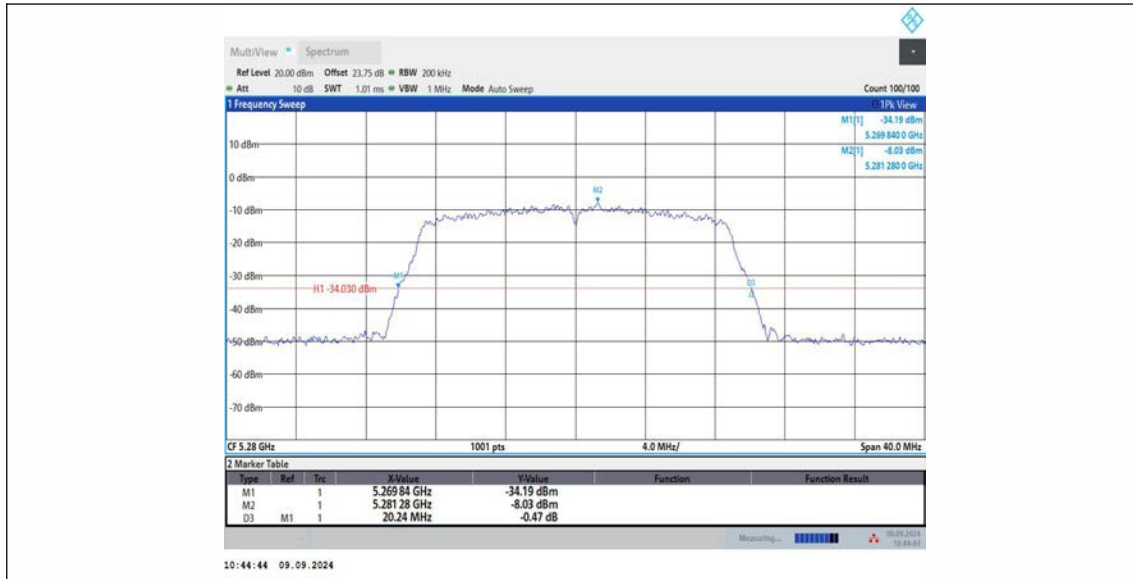

11AC20MIMO\_Ant2\_5280

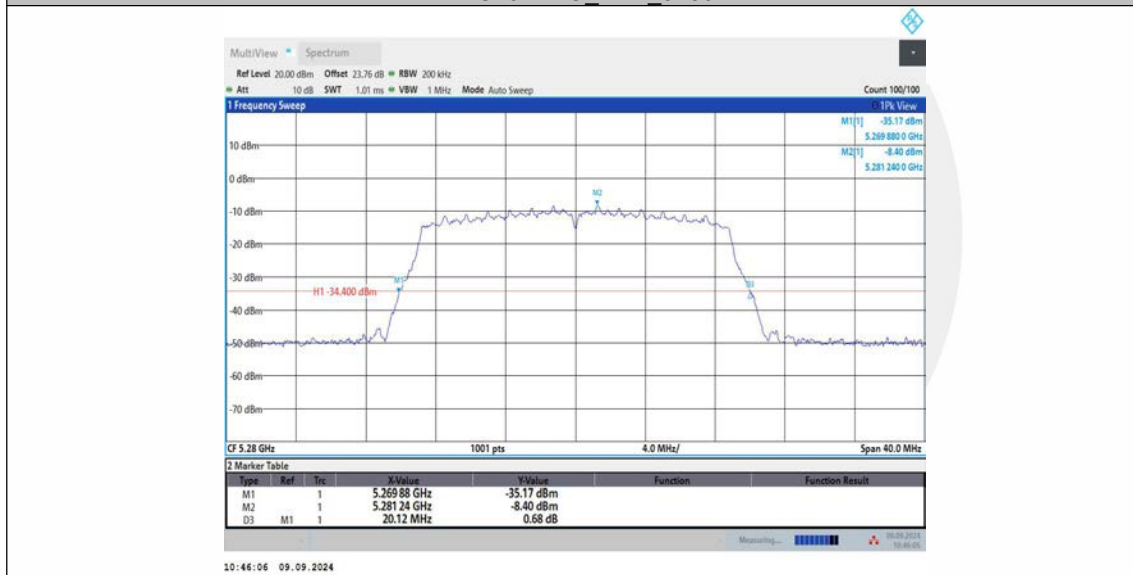

11AC20MIMO\_Ant1\_5320

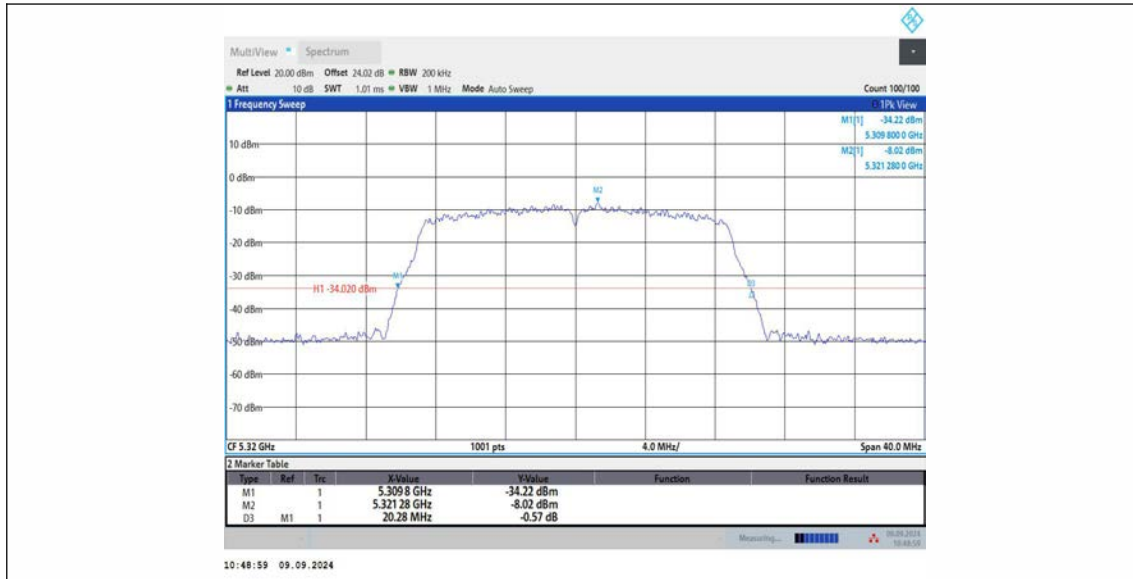

11AC20MIMO\_Ant2\_5320

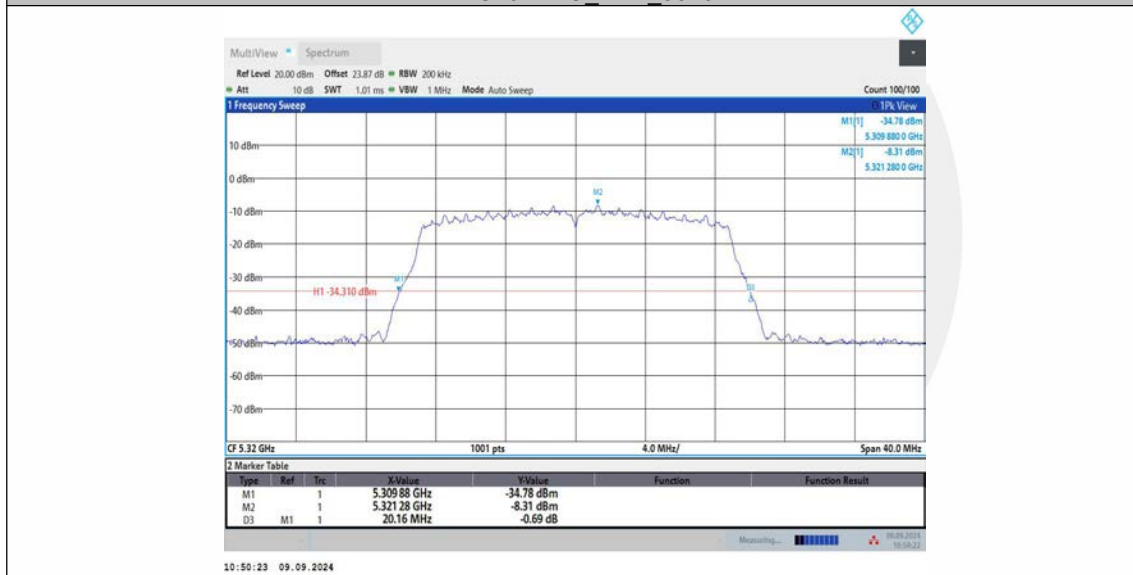

11AC20MIMO\_Ant1\_5500

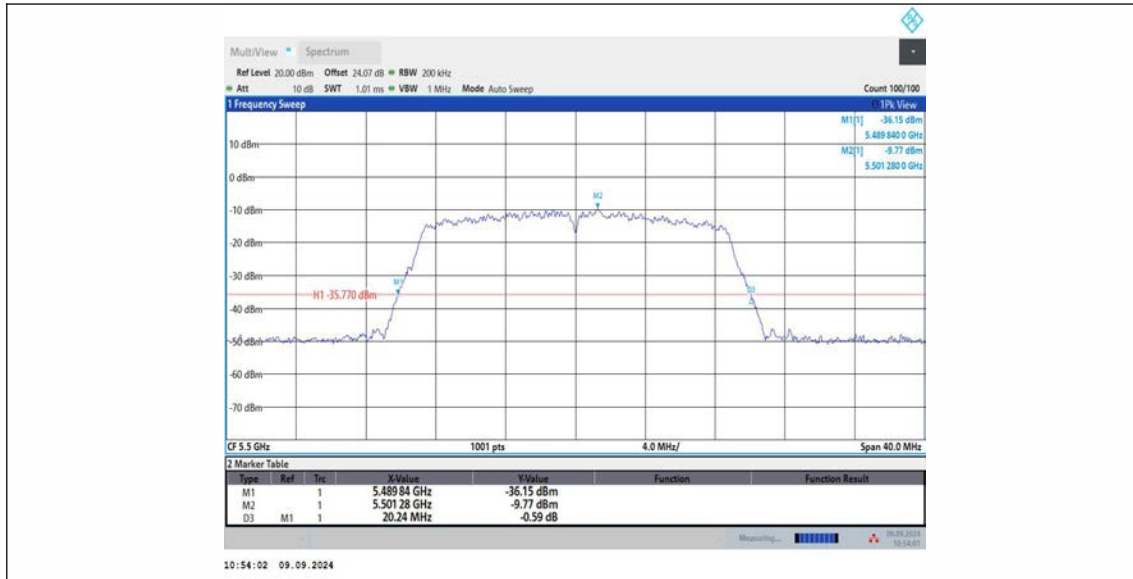

11AC20MIMO\_Ant2\_5500

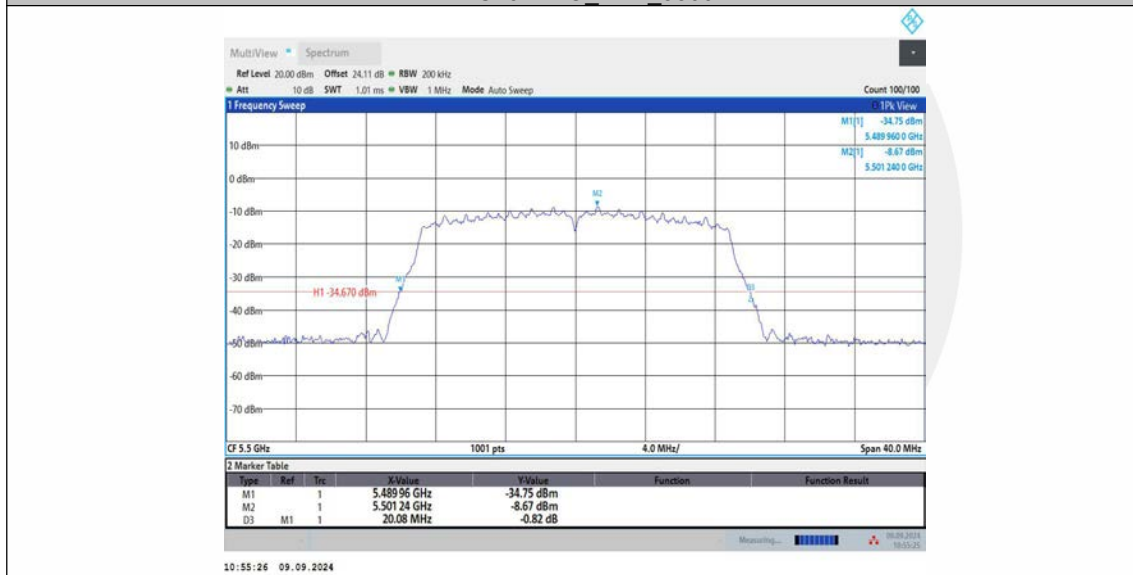

11AC20MIMO\_Ant1\_5580

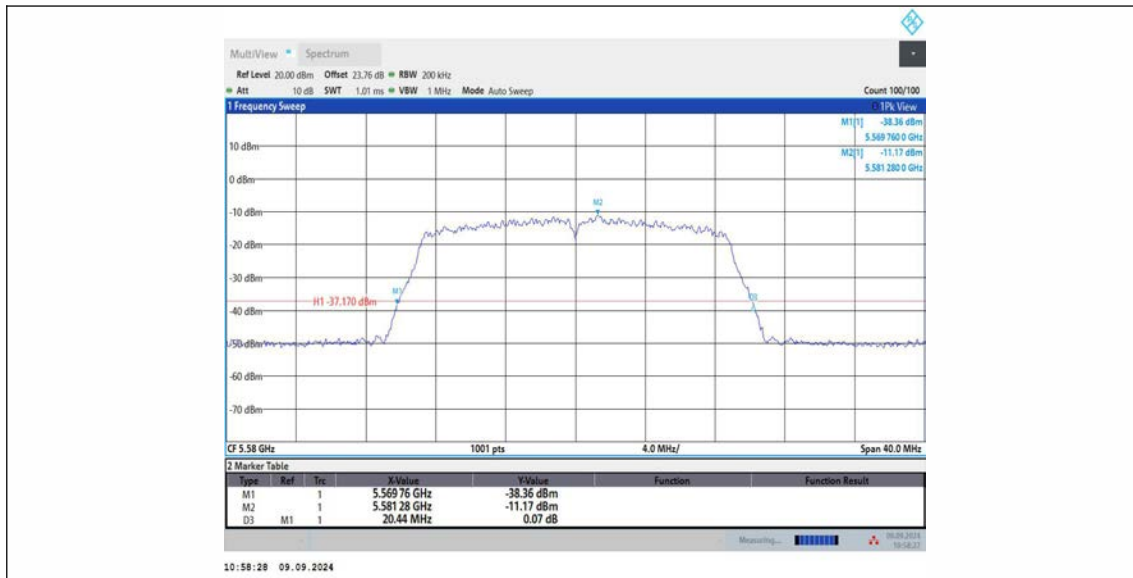

11AC20MIMO\_Ant2\_5580

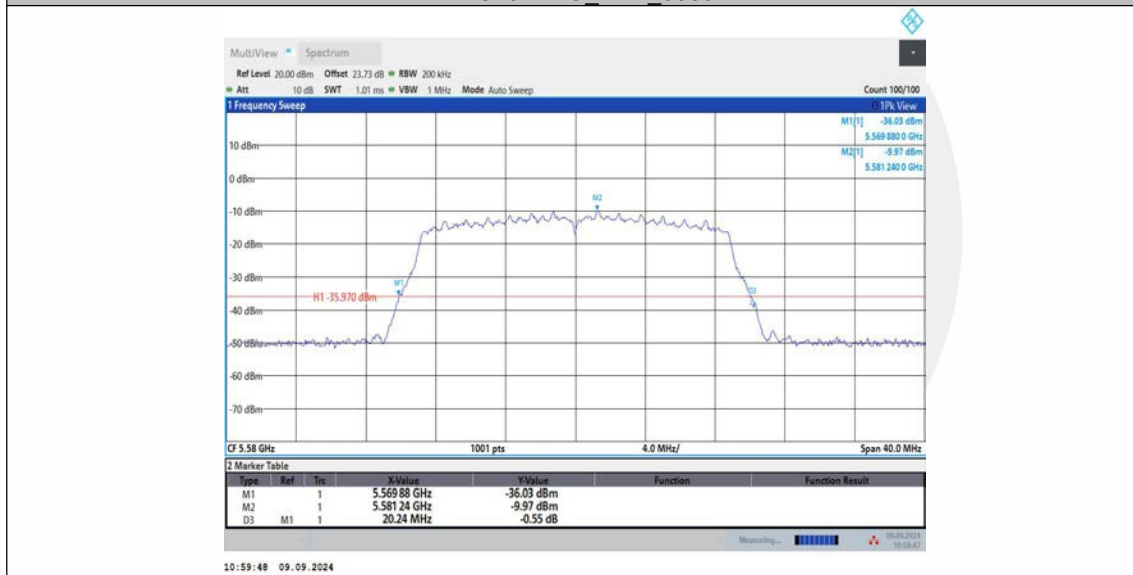

11AC20MIMO\_Ant1\_5700



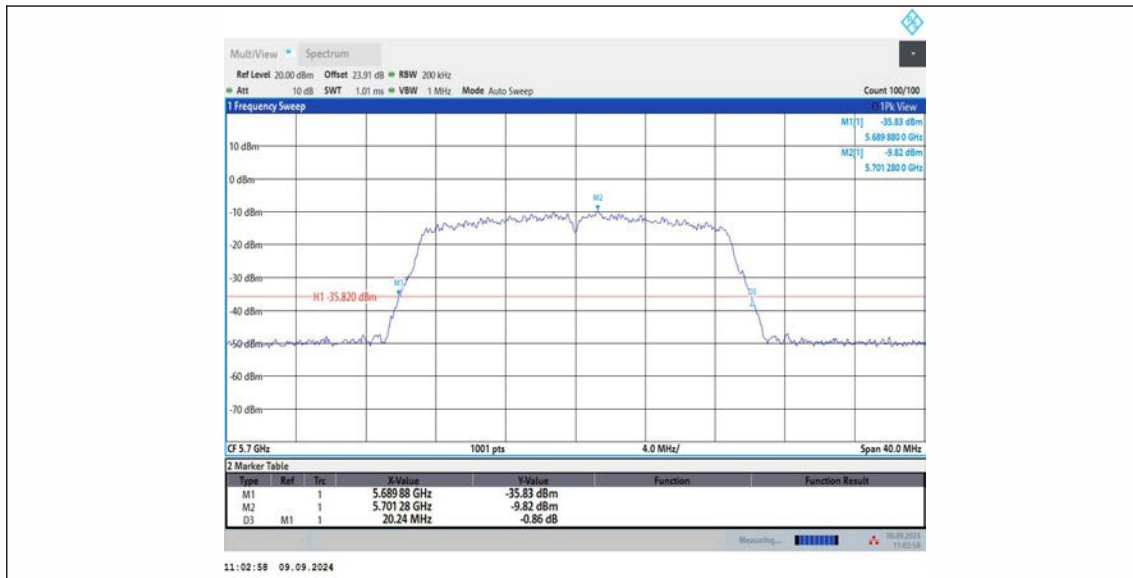

11AC20MIMO\_Ant2\_5700

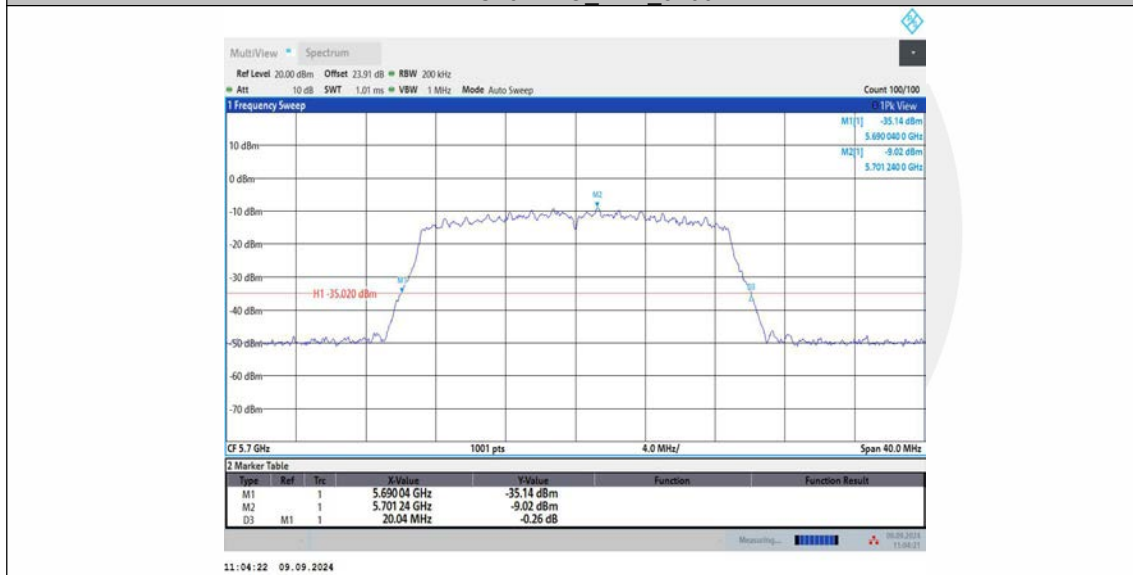

11AC20MIMO\_Ant1\_5745

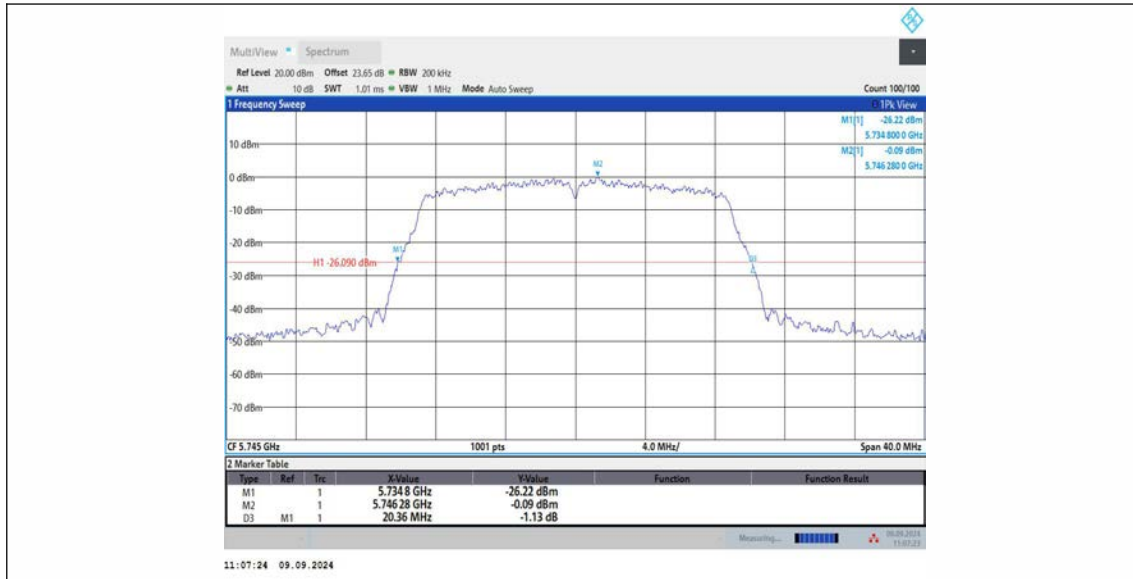

11AC20MIMO\_Ant2\_5745

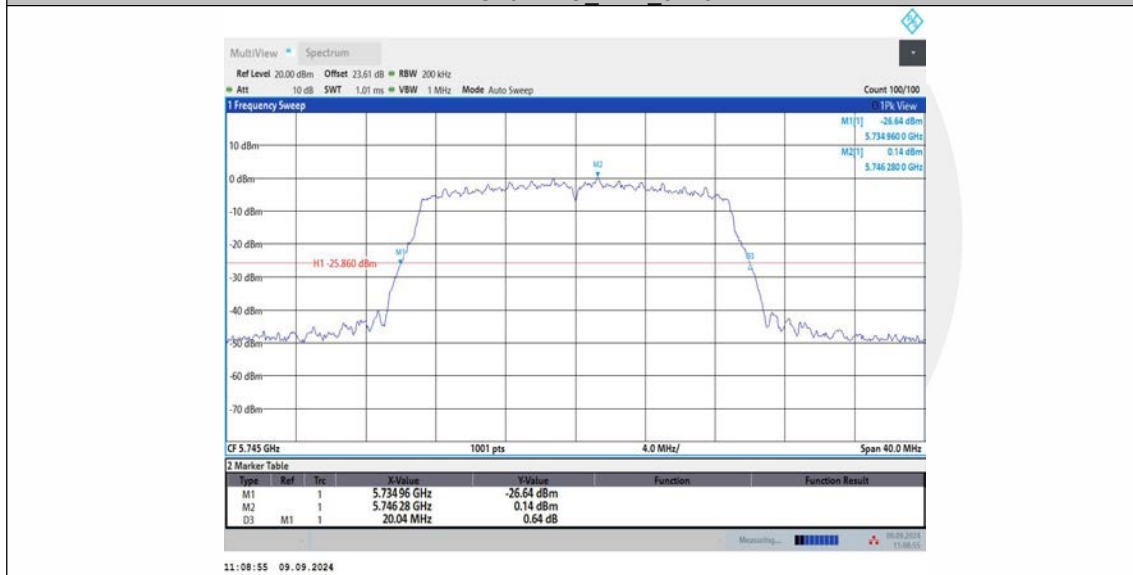

11AC20MIMO\_Ant1\_5785

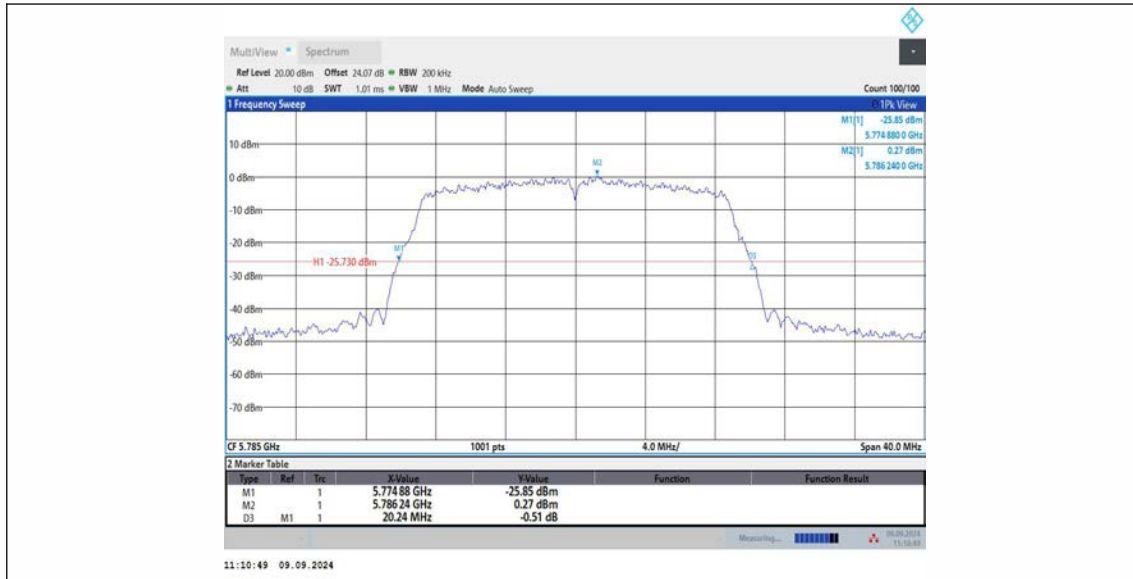

11AC20MIMO Ant2\_5785

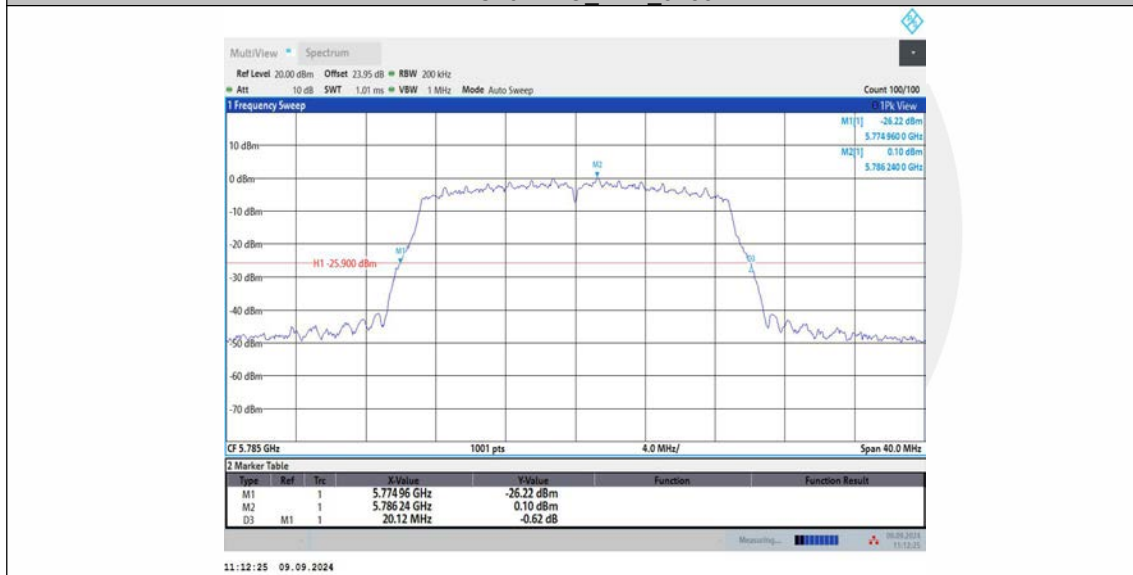

11AC20MIMO Ant1\_5825

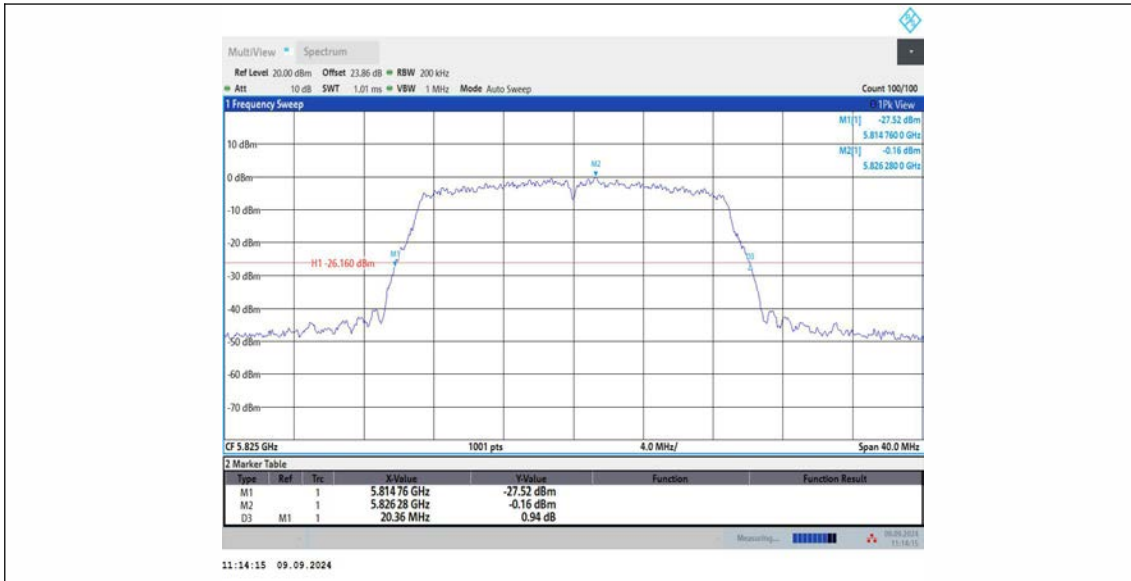

11AC20MIMO\_Ant2\_5825

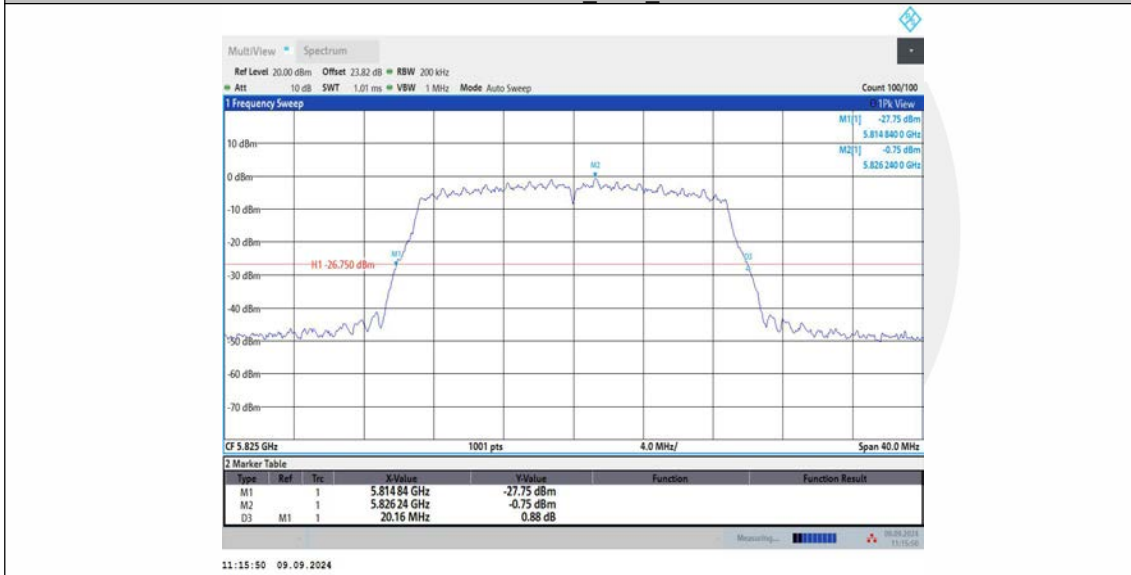

11AC40MIMO\_Ant1\_5190

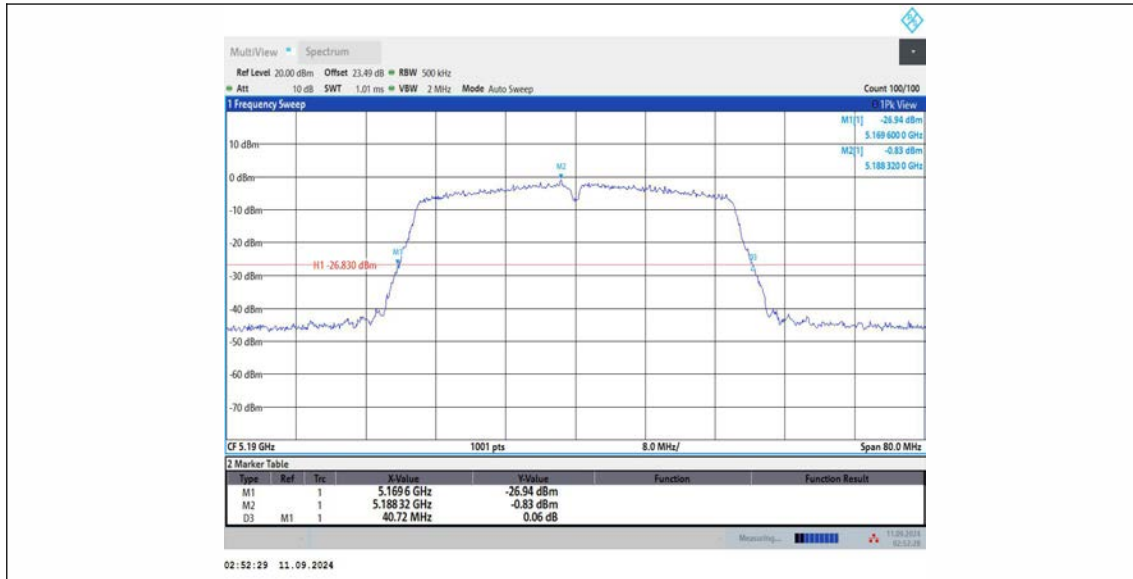

11AC40MIMO\_Ant2\_5190

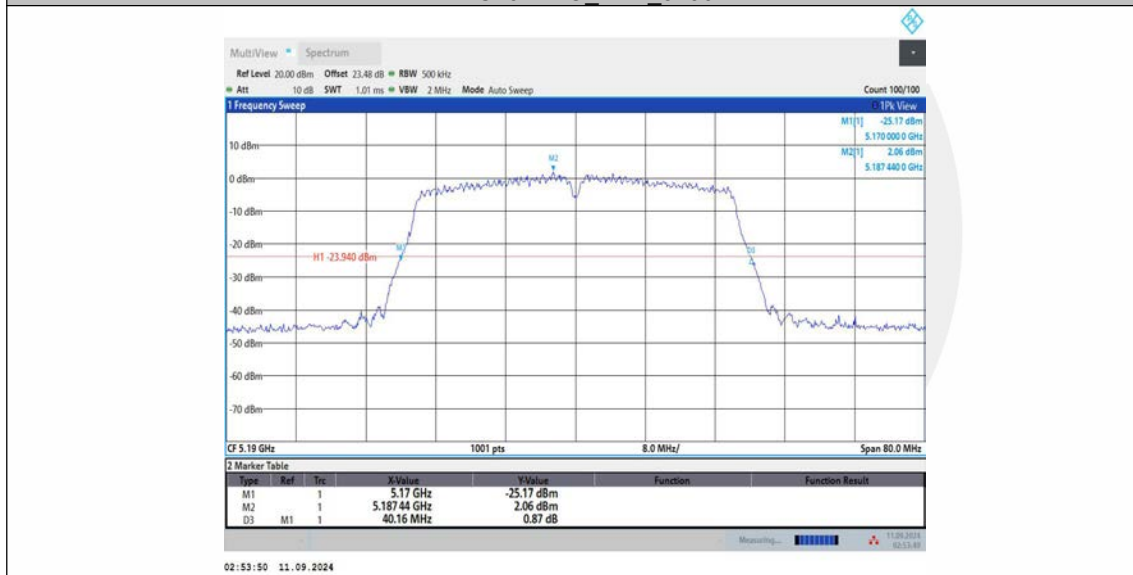

11AC40MIMO\_Ant1\_5230



11AC40MIMO\_Ant2\_5230



11AC40MIMO\_Ant1\_5270

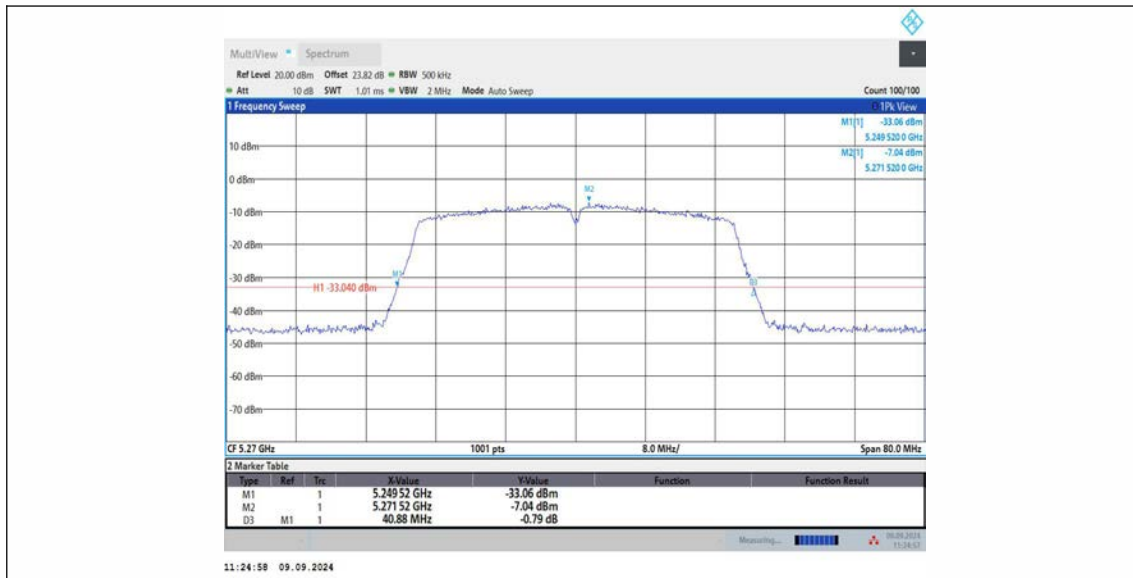

11AC40MIMO\_Ant2\_5270

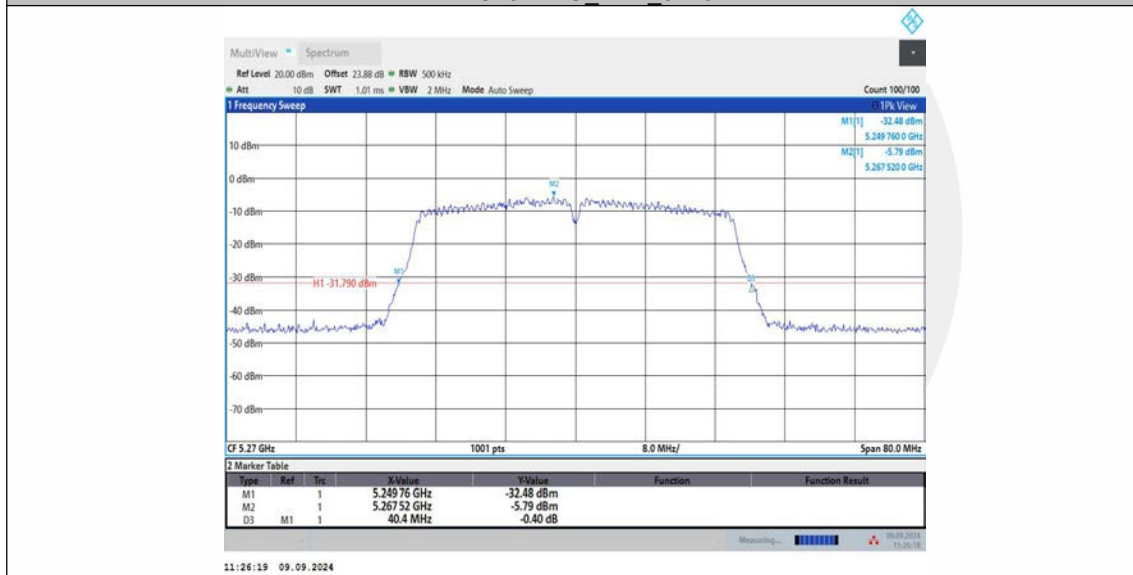

11AC40MIMO\_Ant1\_5310

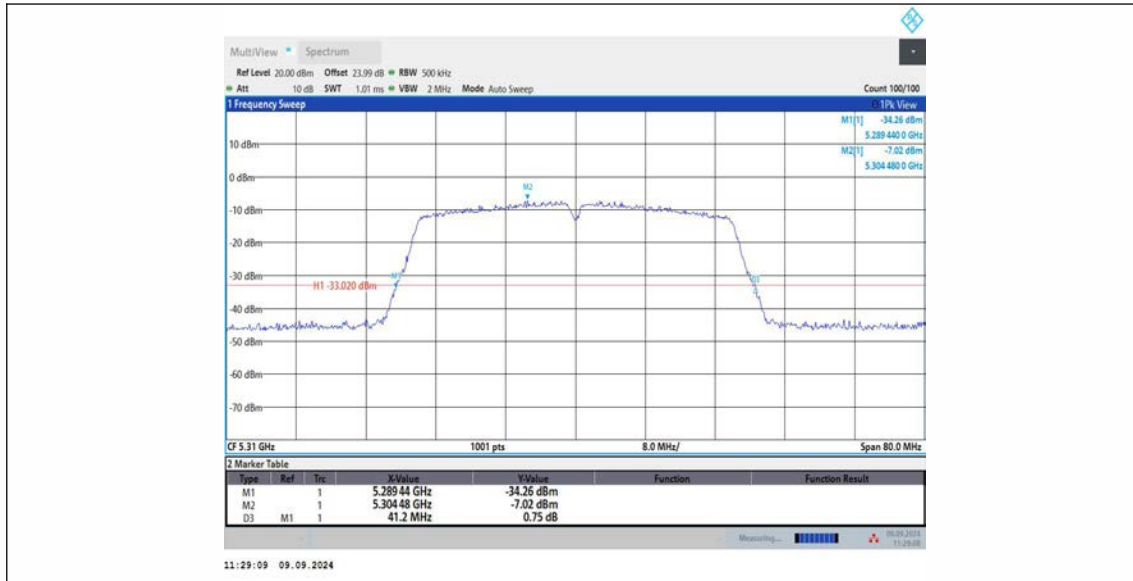

11AC40MIMO\_Ant2\_5310

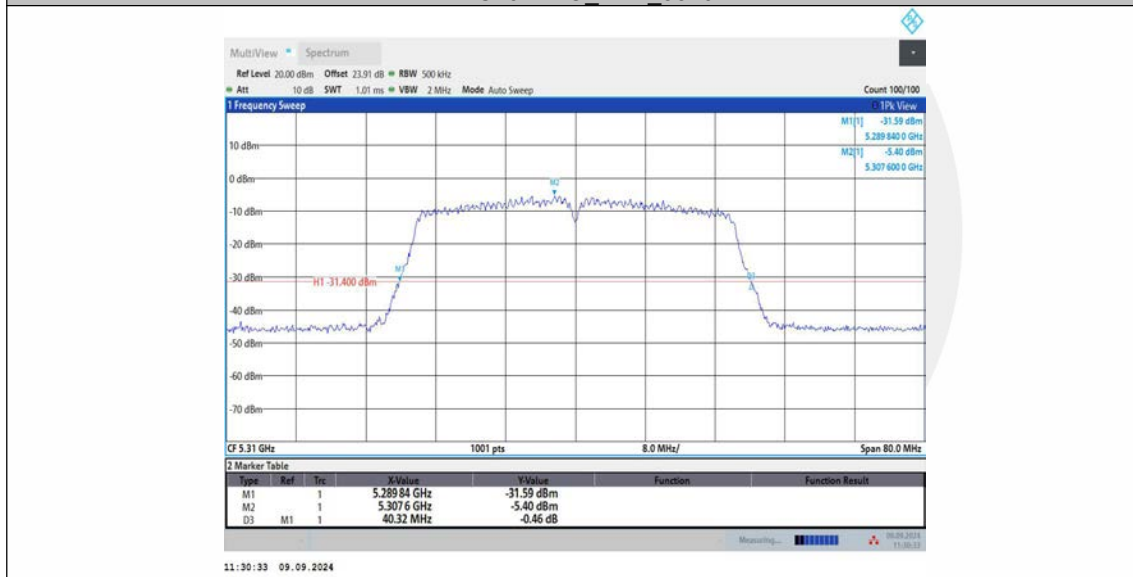

11AC40MIMO\_Ant1\_5510



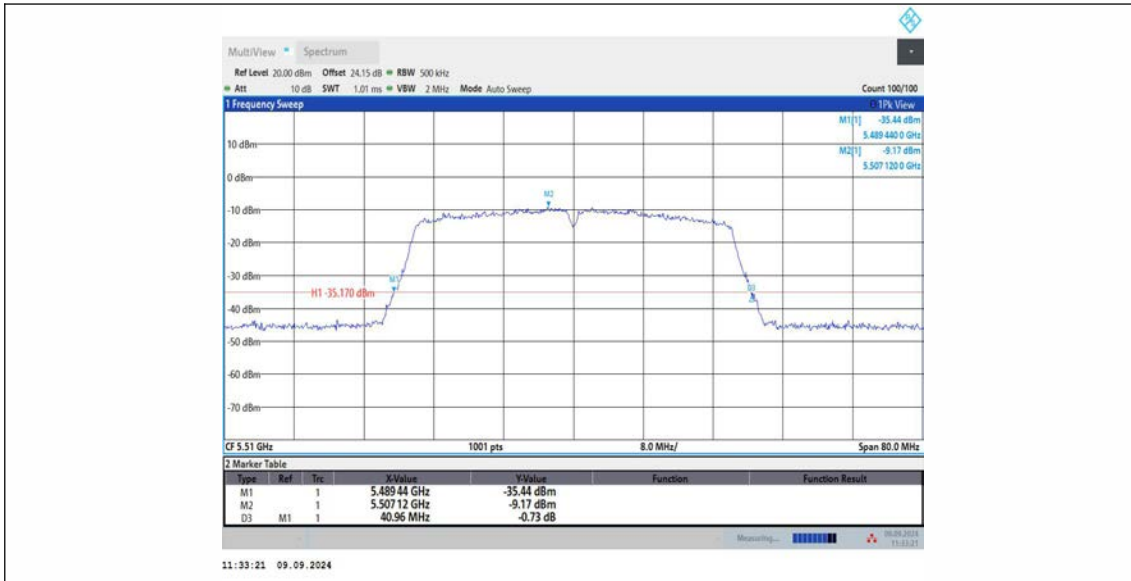

11AC40MIMO\_Ant2\_5510

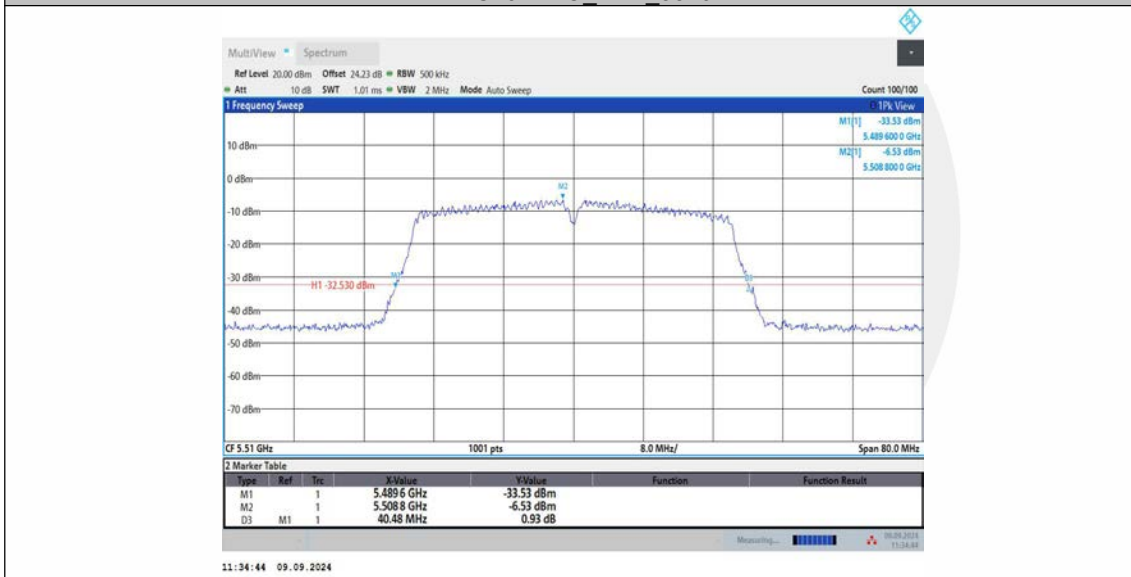

11AC40MIMO\_Ant1\_5550

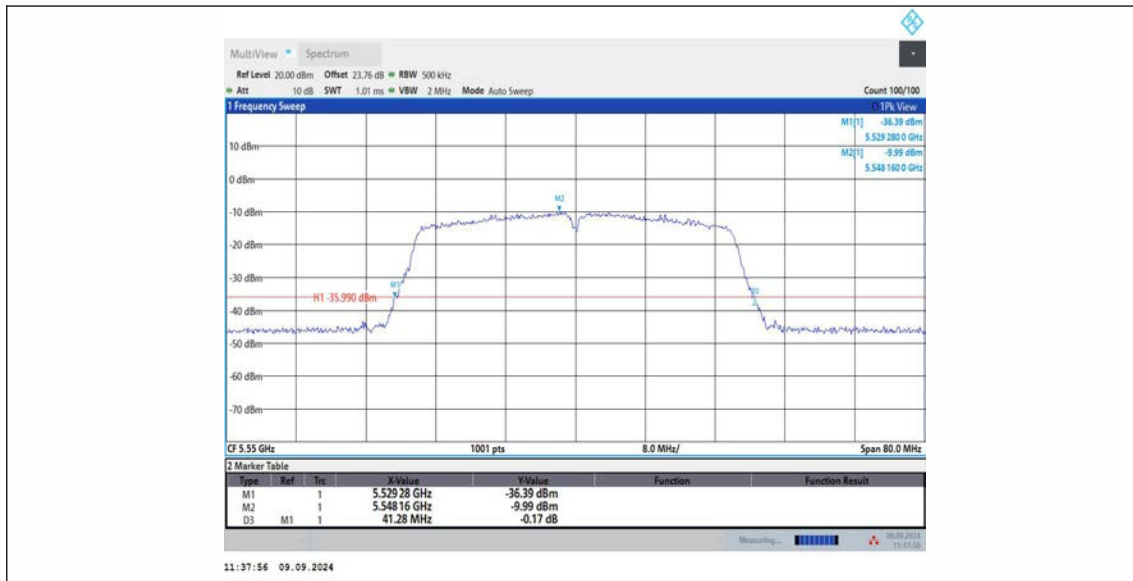

11AC40MIMO\_Ant2\_5550

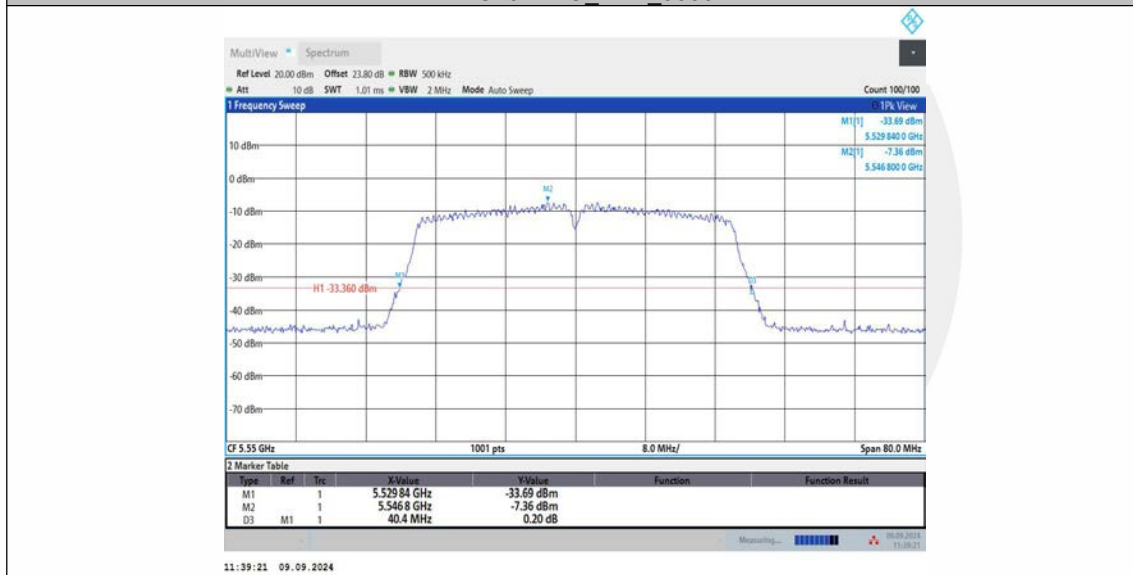

11AC40MIMO\_Ant1\_5670

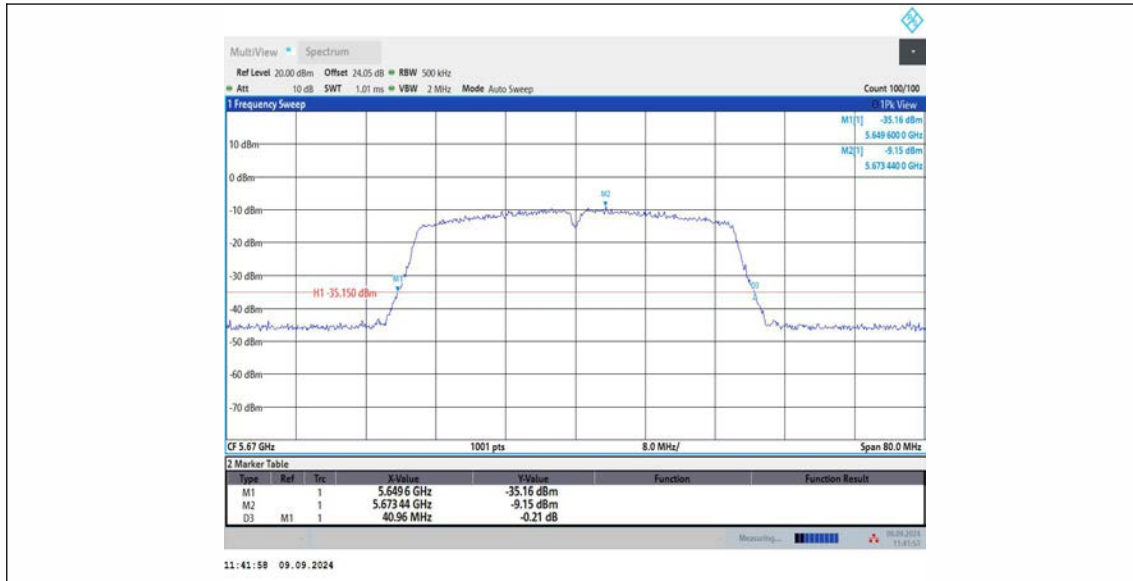

11AC40MIMO\_Ant2\_5670

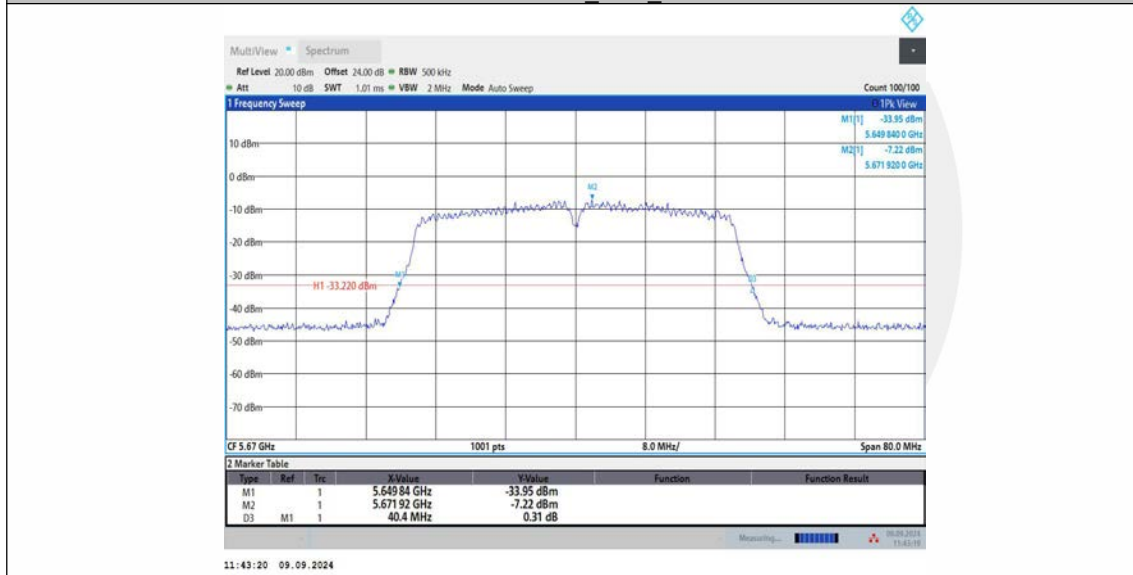

11AC40MIMO\_Ant1\_5755



11AC40MIMO\_Ant2\_5755

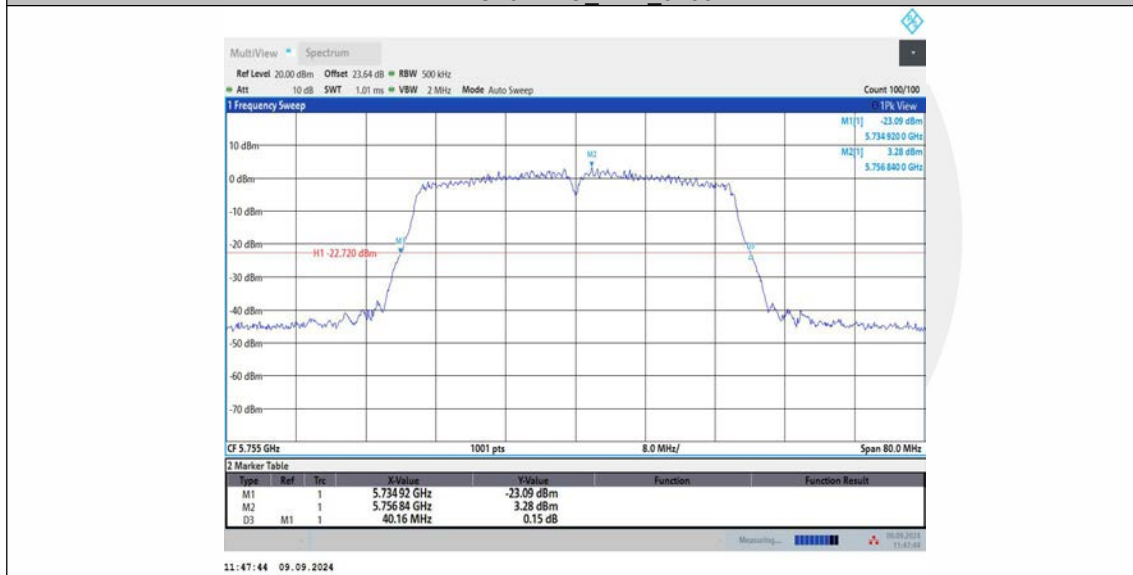

11AC40MIMO\_Ant1\_5795

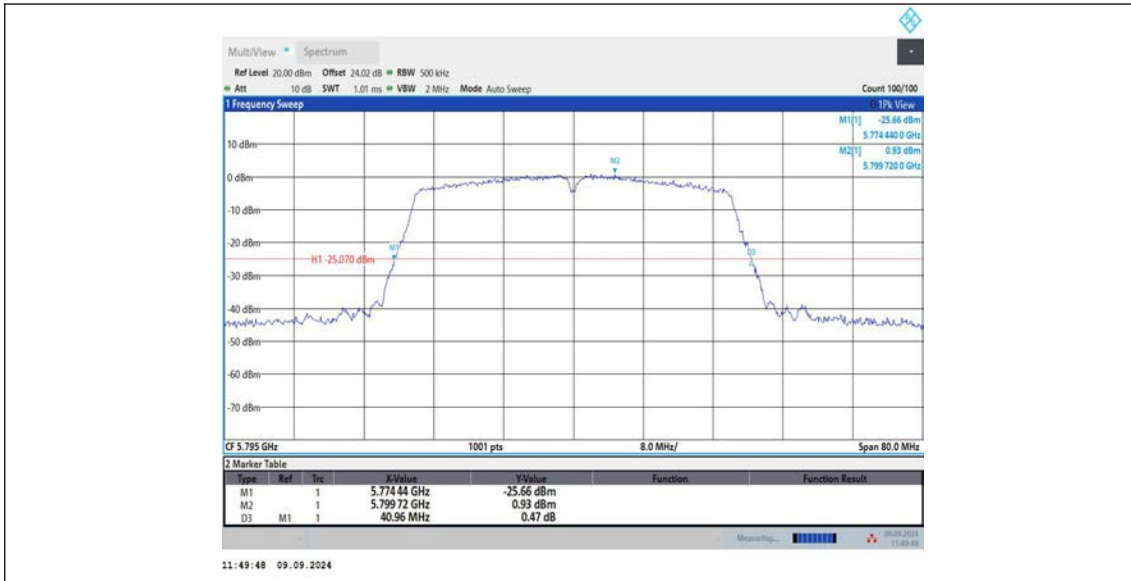

11AC40MIMO\_Ant2\_5795

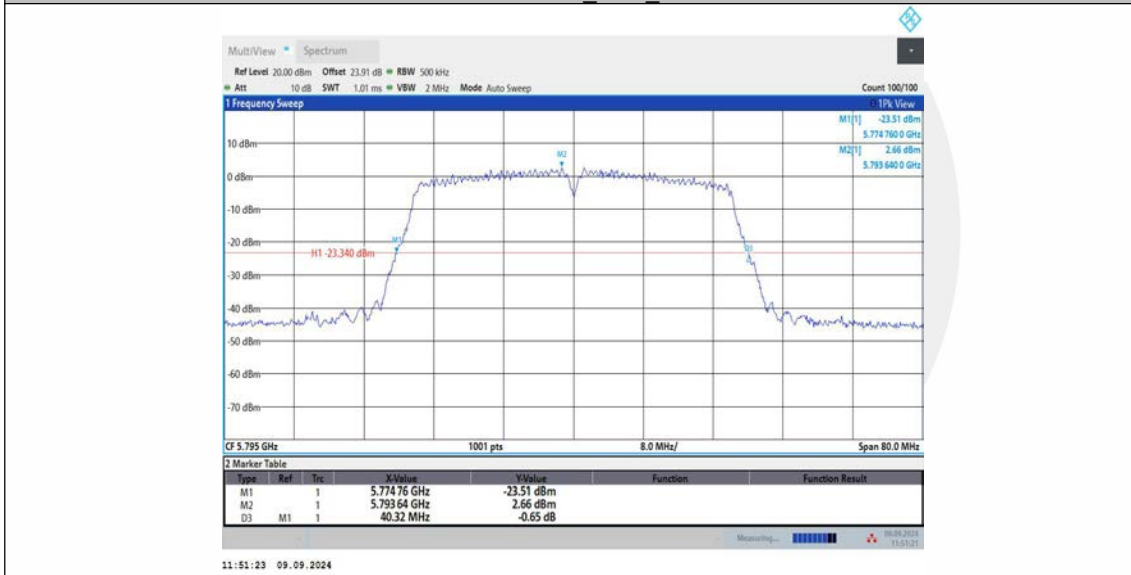

11AC80MIMO\_Ant1\_5210

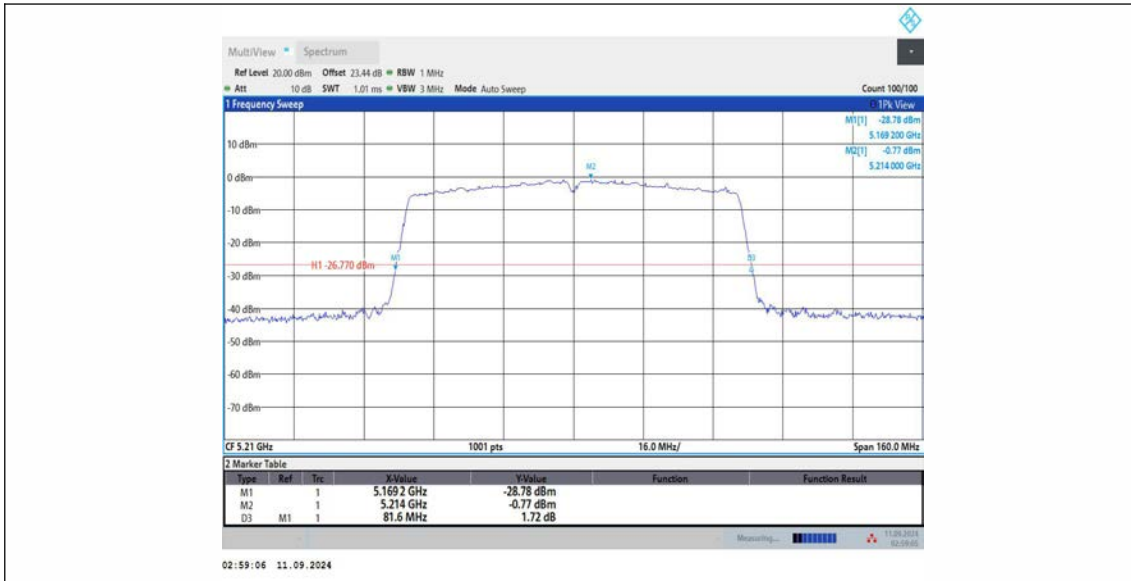

11AC80MIMO\_Ant2\_5210



11AC80MIMO\_Ant1\_5290

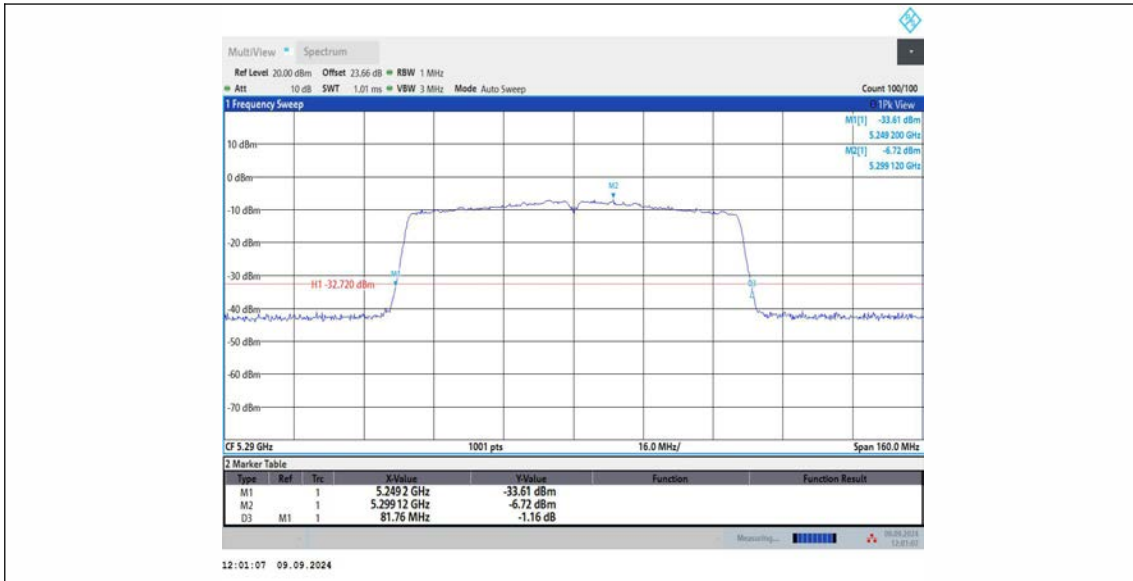

11AC80MIMO Ant2\_5290

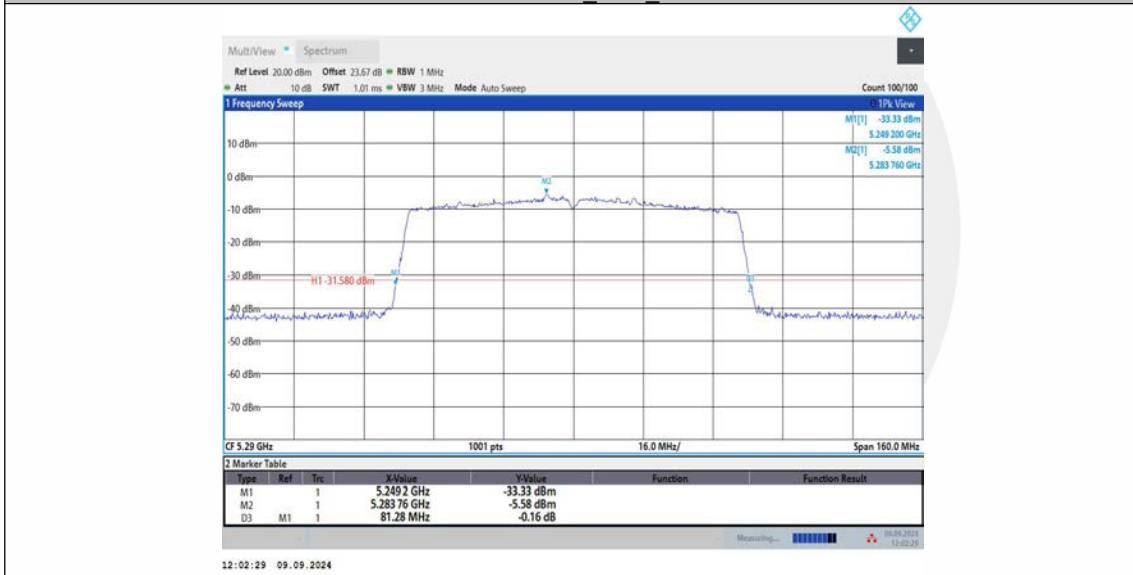

11AC80MIMO Ant1\_5530

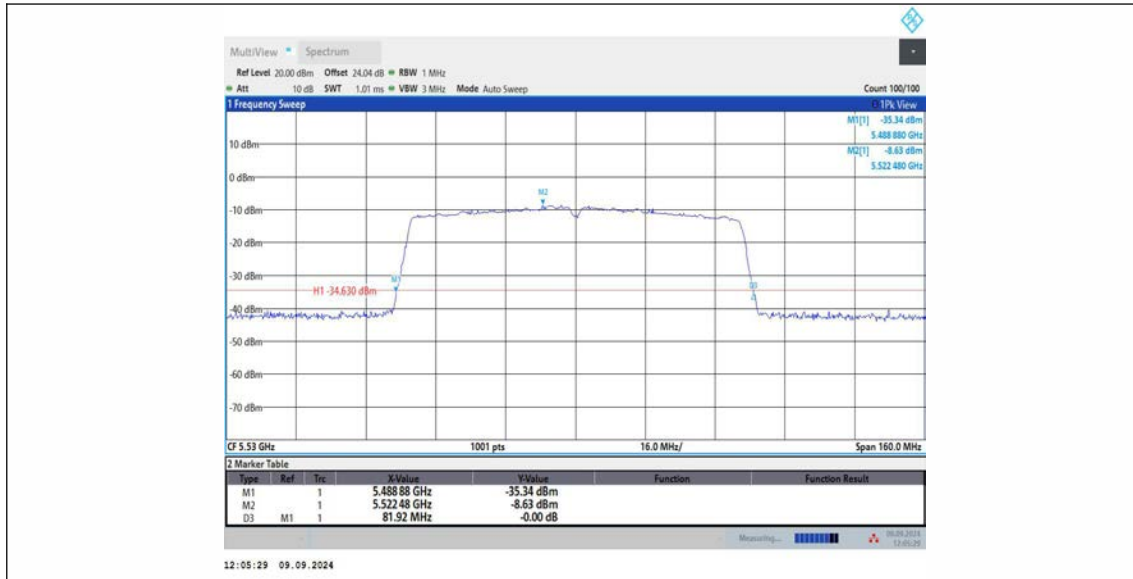

11AC80MIMO\_Ant2\_5530

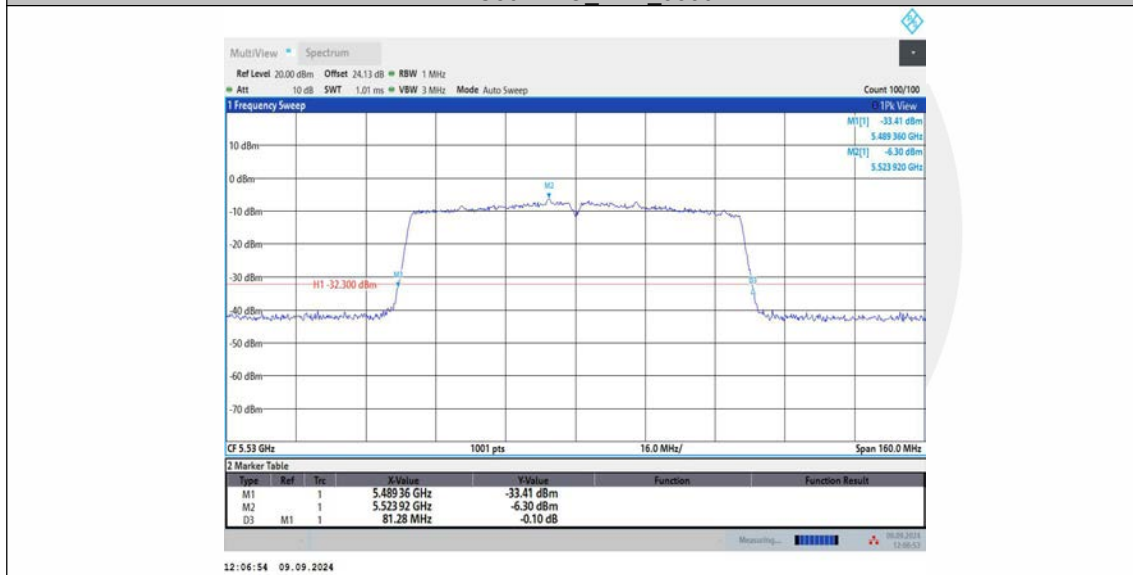

11AC80MIMO\_Ant1\_5610



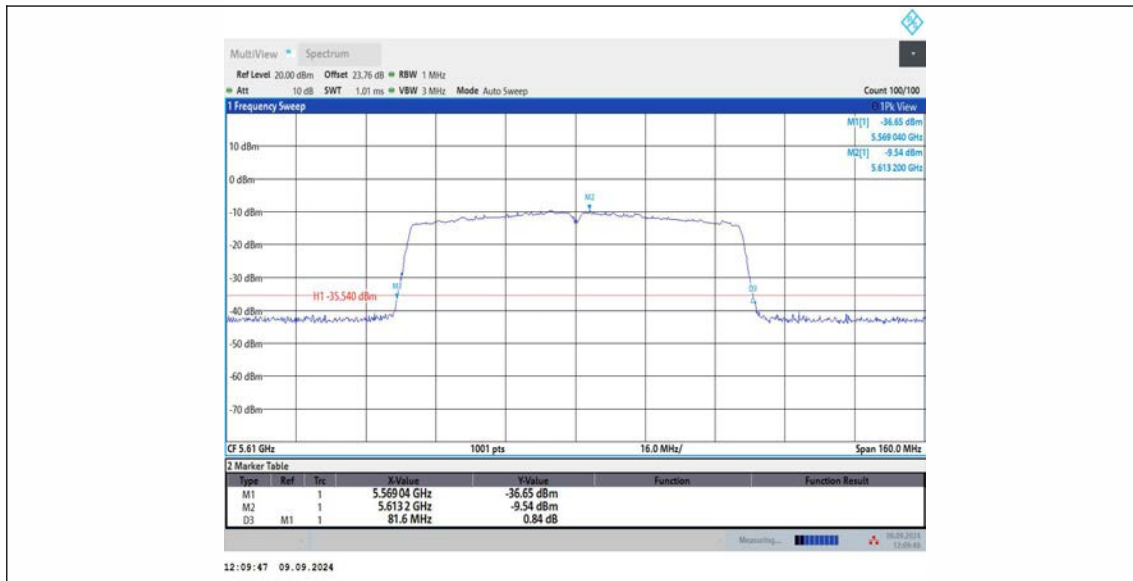

11AC80MIMO\_Ant2\_5610

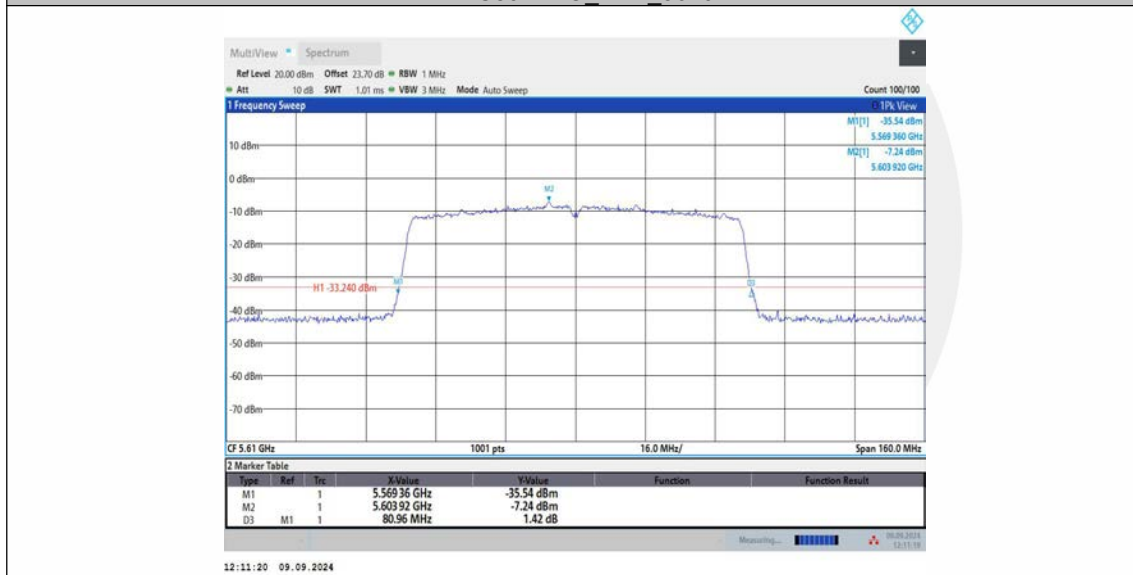

11AC80MIMO\_Ant1\_5775

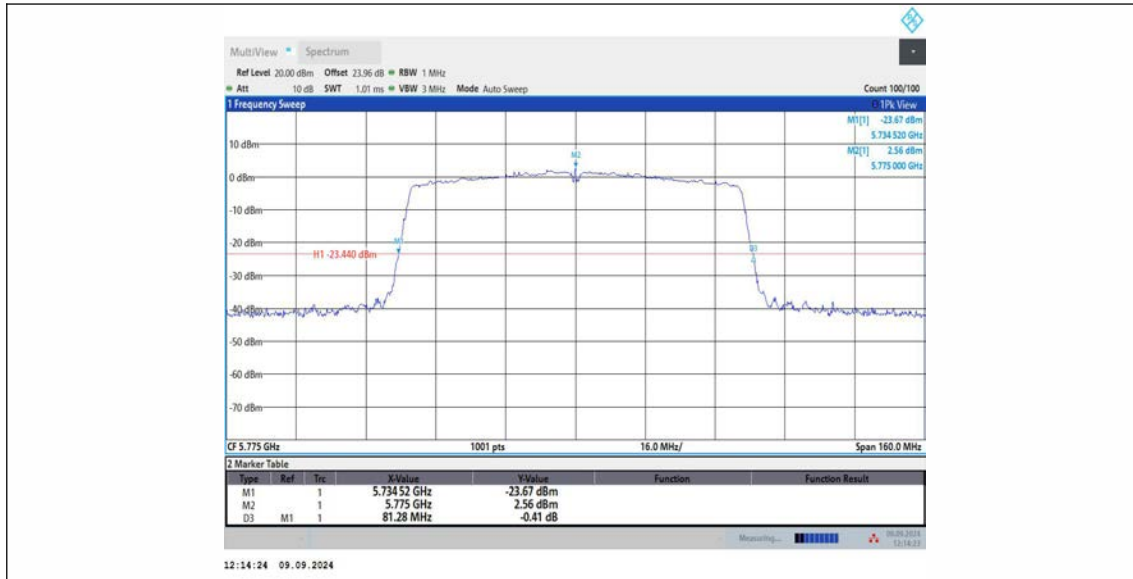

## 11AC80MIMO\_Ant2\_5775

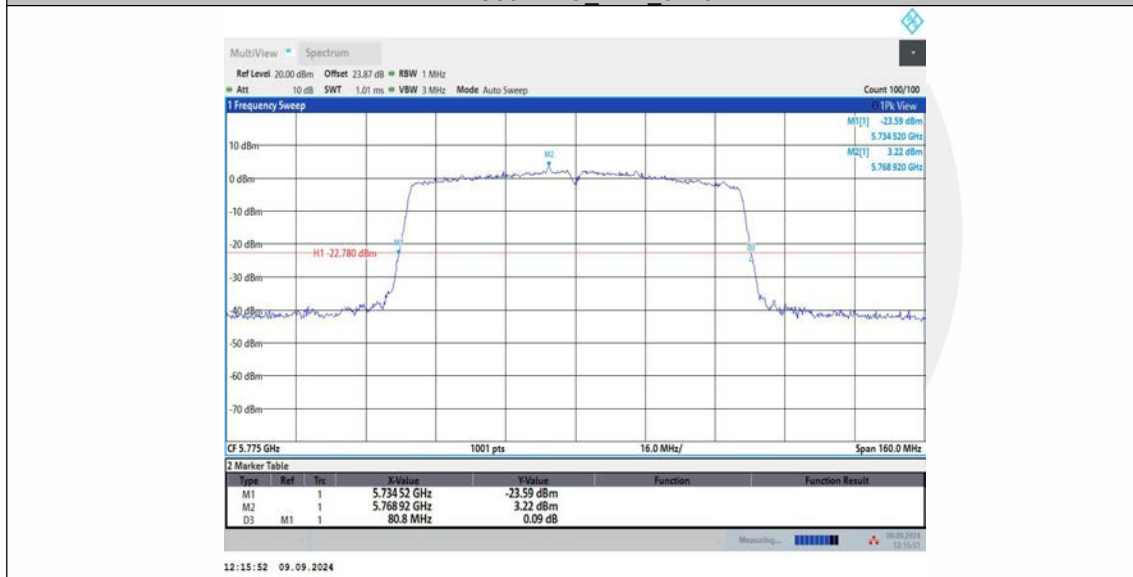

**Min emission bandwidth (6dB)**

TestMode	Antenna	Frequency[MHz]	6db EBW [MHz]	FL[MHz]	FH[MHz]	Limit[MHz]	Verdict
11A	Ant1	5745	15.12	5737.40	5752.52	0.5	PASS
	Ant2	5745	15.12	5737.40	5752.52	0.5	PASS
	Ant1	5785	15.12	5777.40	5792.52	0.5	PASS
	Ant2	5785	14.48	5778.04	5792.52	0.5	PASS
	Ant1	5825	15.12	5817.40	5832.52	0.5	PASS
11N20MIM O	Ant2	5825	15.12	5817.40	5832.52	0.5	PASS
	Ant1	5745	15.12	5737.40	5752.52	0.5	PASS
	Ant2	5745	16.32	5736.80	5753.12	0.5	PASS
	Ant1	5785	15.12	5777.40	5792.52	0.5	PASS
	Ant2	5785	15.92	5776.56	5792.48	0.5	PASS
11N40MIM O	Ant1	5825	15.12	5817.40	5832.52	0.5	PASS
	Ant2	5825	15.76	5816.76	5832.52	0.5	PASS
	Ant1	5755	35.12	5737.48	5772.60	0.5	PASS
	Ant2	5755	33.92	5738.68	5772.60	0.5	PASS
11AC20MI MO	Ant1	5795	35.20	5777.40	5812.60	0.5	PASS
	Ant2	5795	35.12	5777.40	5812.52	0.5	PASS
	Ant1	5745	15.12	5737.40	5752.52	0.5	PASS
	Ant2	5745	16.32	5736.80	5753.12	0.5	PASS
	Ant1	5785	15.12	5777.40	5792.52	0.5	PASS
11AC40MI MO	Ant2	5785	15.72	5776.80	5792.52	0.5	PASS
	Ant1	5825	15.12	5817.40	5832.52	0.5	PASS
	Ant2	5825	16.28	5816.80	5833.08	0.5	PASS
	Ant1	5755	35.12	5737.48	5772.60	0.5	PASS
	Ant2	5755	35.04	5737.48	5772.52	0.5	PASS
11AC80MI MO	Ant1	5795	35.04	5777.48	5812.52	0.5	PASS
	Ant2	5795	35.12	5777.40	5812.52	0.5	PASS
	Ant1	5610	75.20	5572.40	5647.60	0.5	PASS
	Ant2	5610	75.20	5572.40	5647.60	0.5	PASS
	Ant1	5775	75.20	5737.40	5812.60	0.5	PASS
	Ant2	5775	75.20	5737.40	5812.60	0.5	PASS

### Min emission bandwidth (6dB) Test Graphs



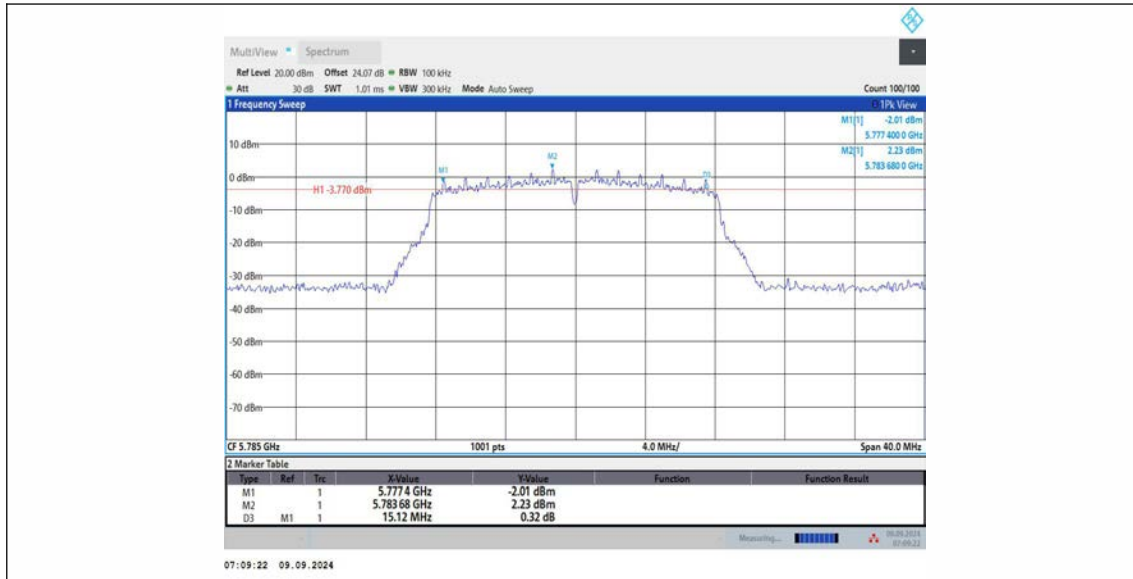

11A\_Ant2\_5785

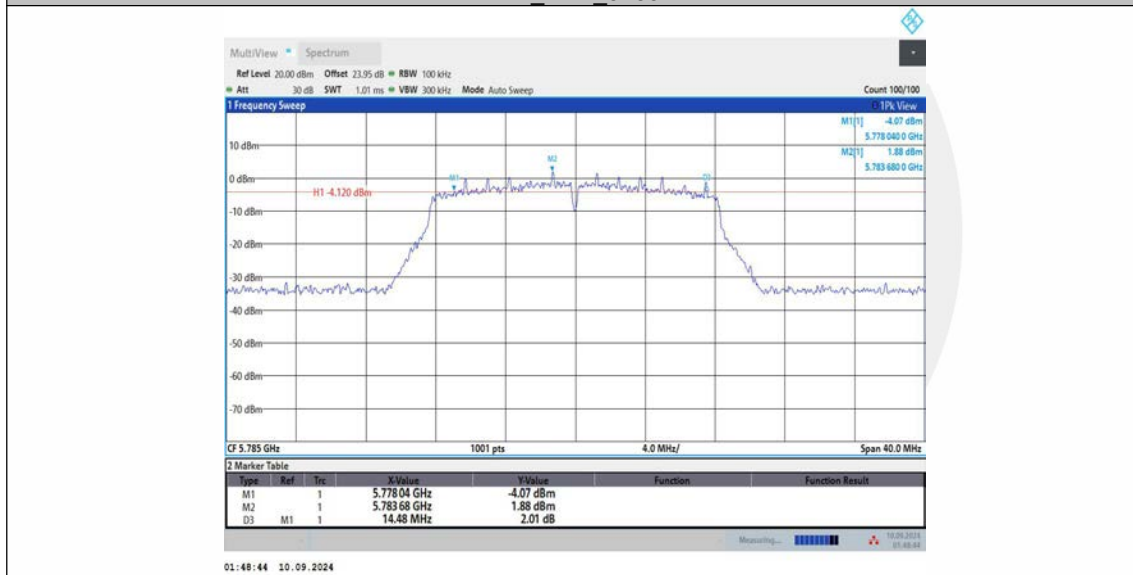

11A\_Ant1\_5825

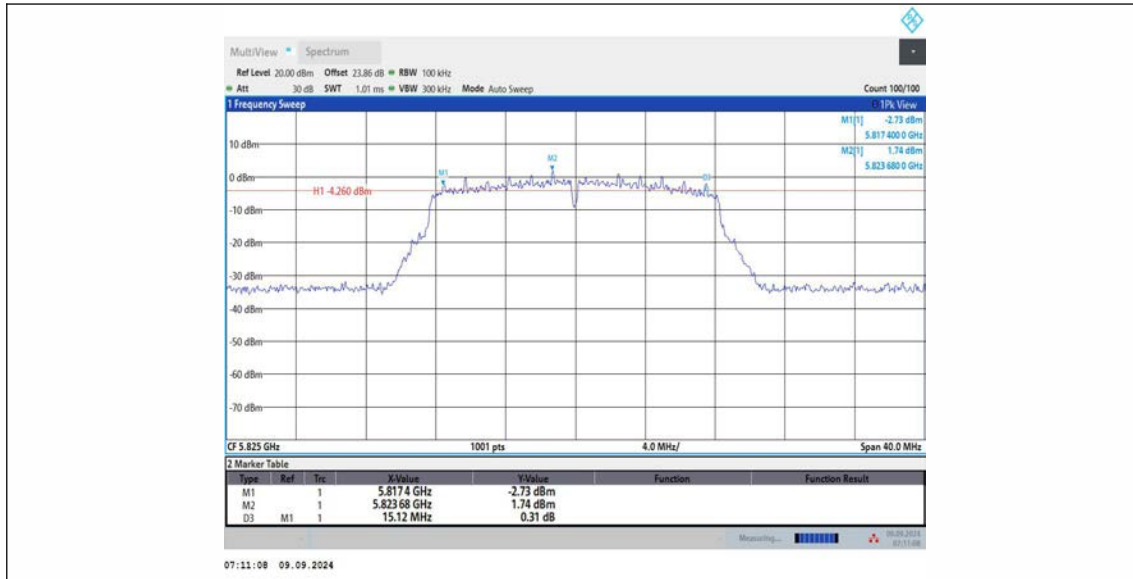

11A\_Ant2\_5825

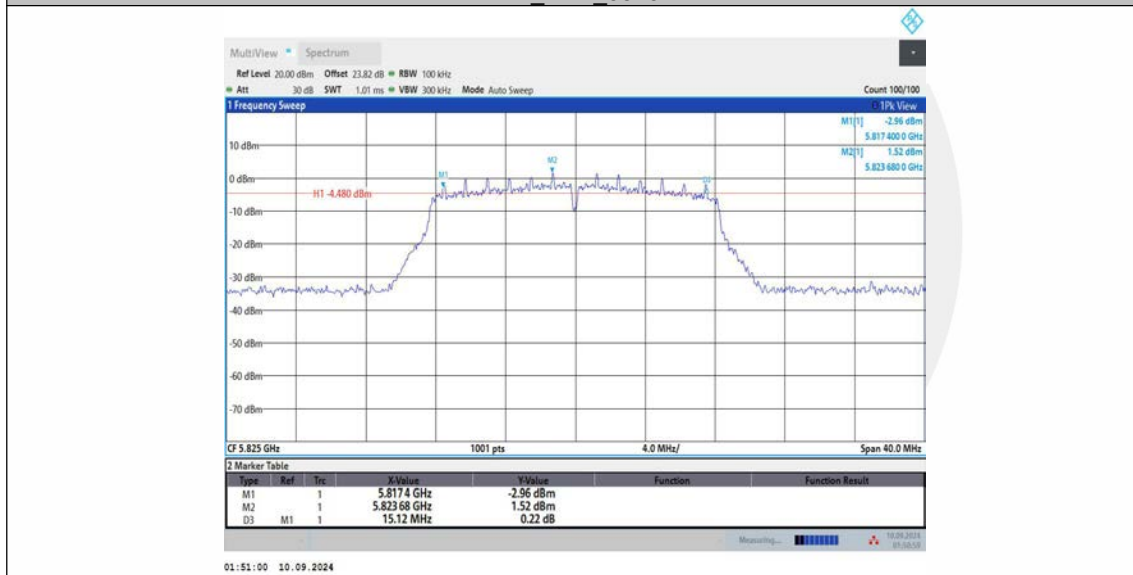

11N20MIMO Ant1\_5745

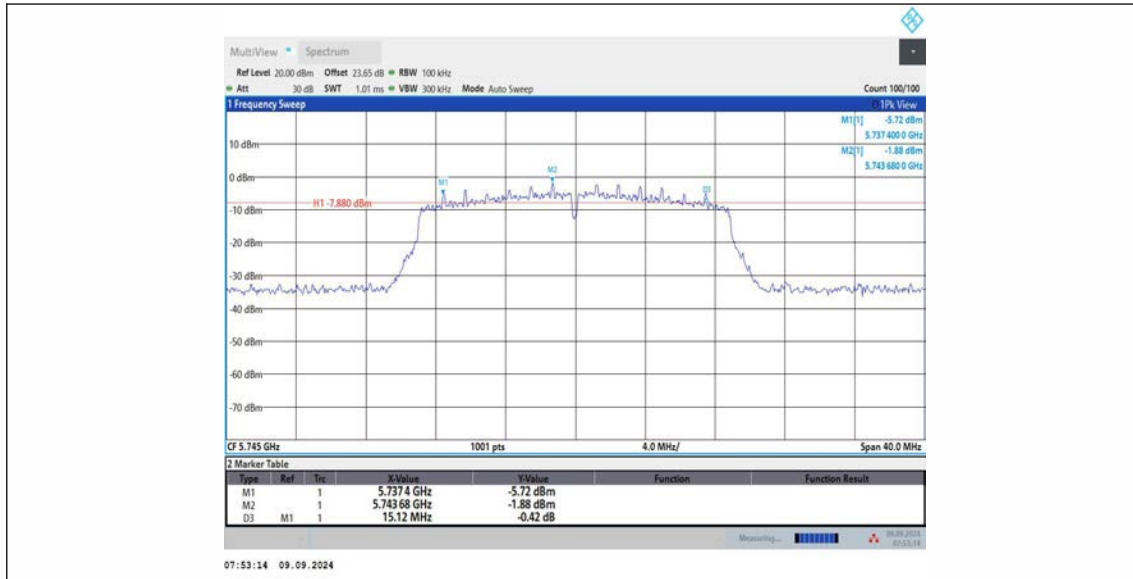

11N20MIMO\_Ant2\_5745

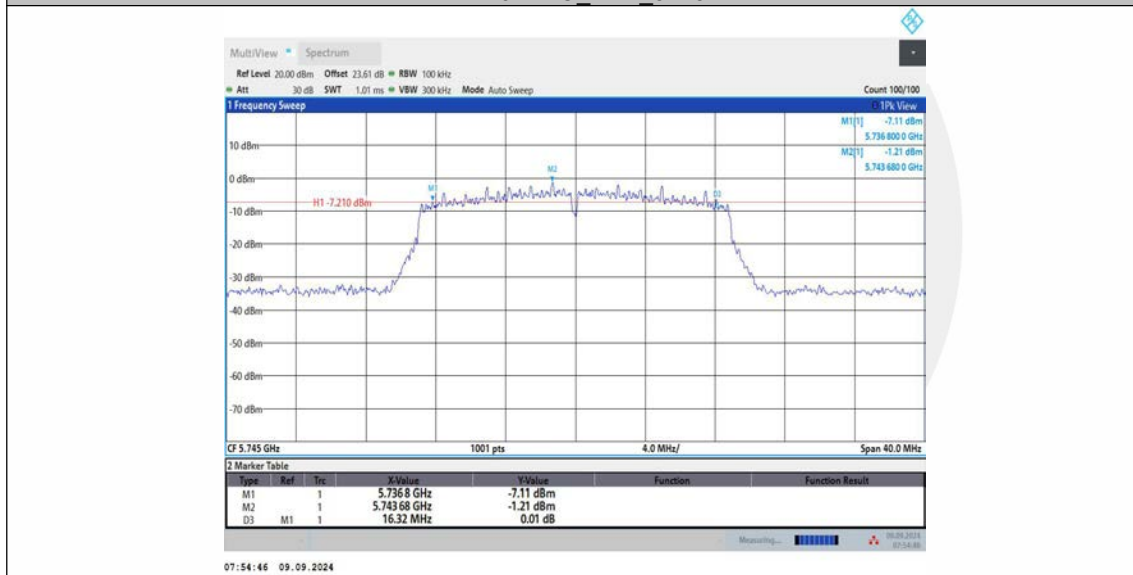

11N20MIMO\_Ant1\_5785

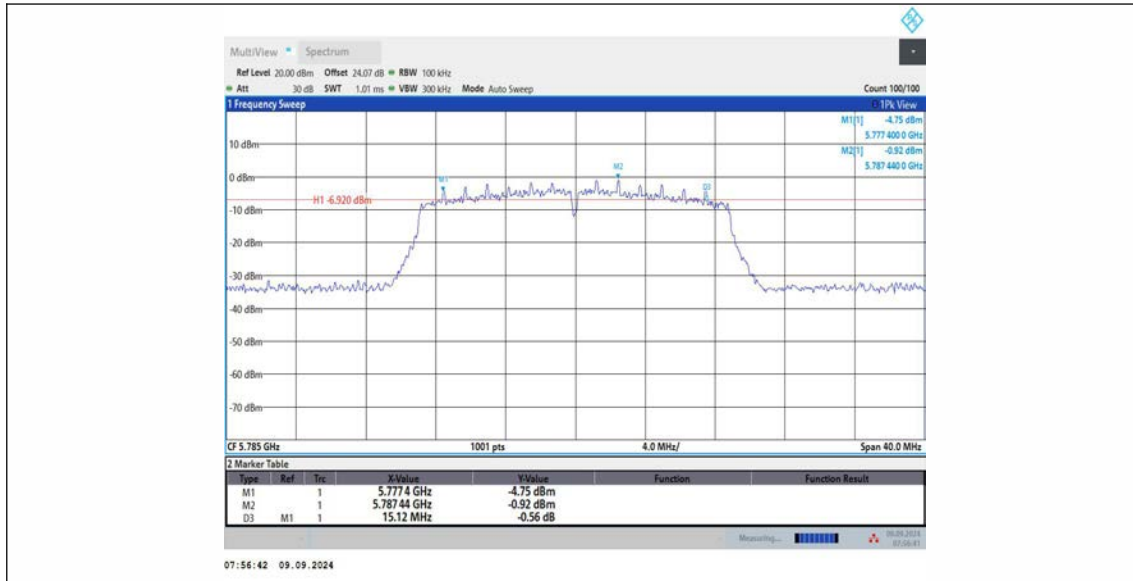

11N20MIMO\_Ant2\_5785

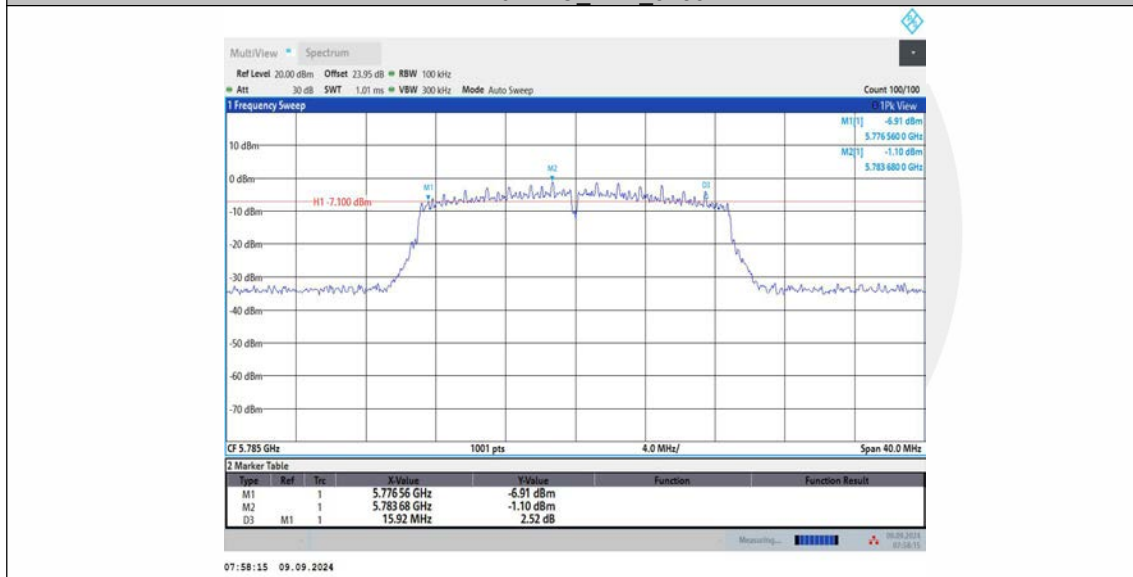

11N20MIMO\_Ant1\_5825



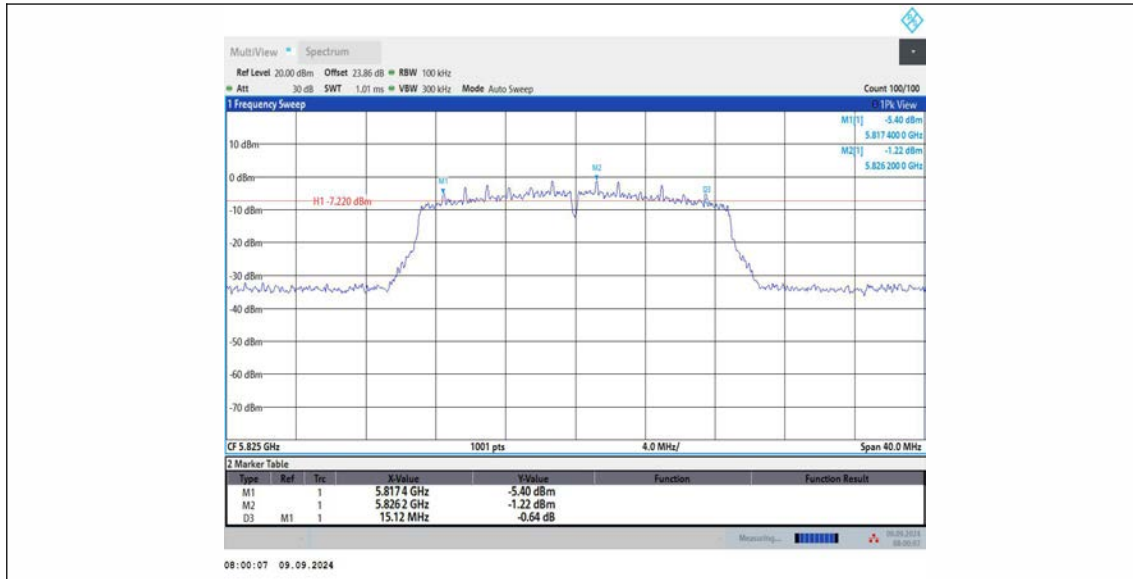

11N20MIMO\_Ant2\_5825

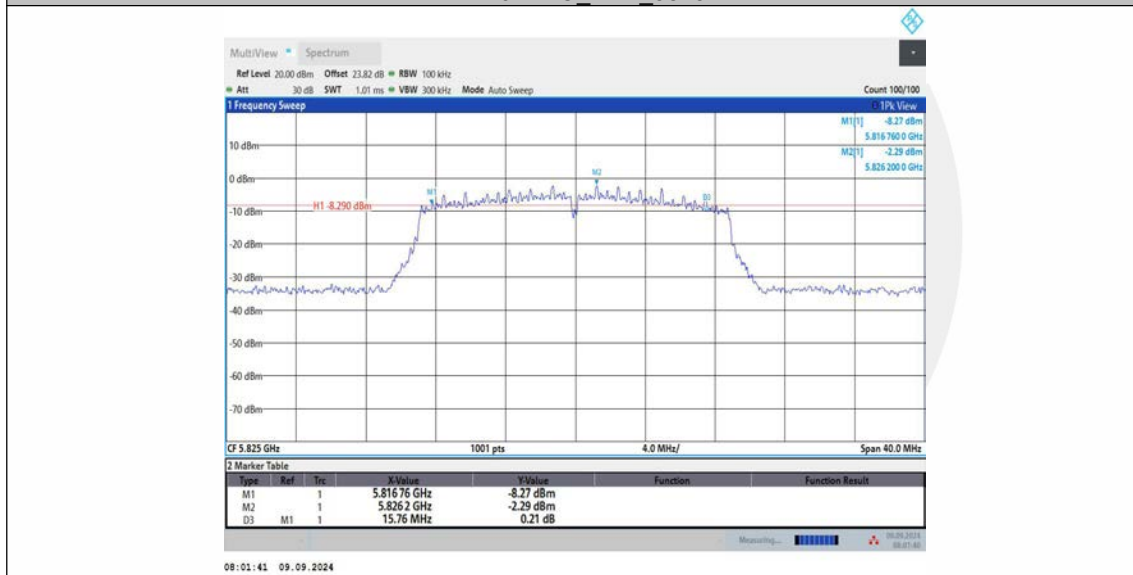

11N40MIMO\_Ant1\_5755

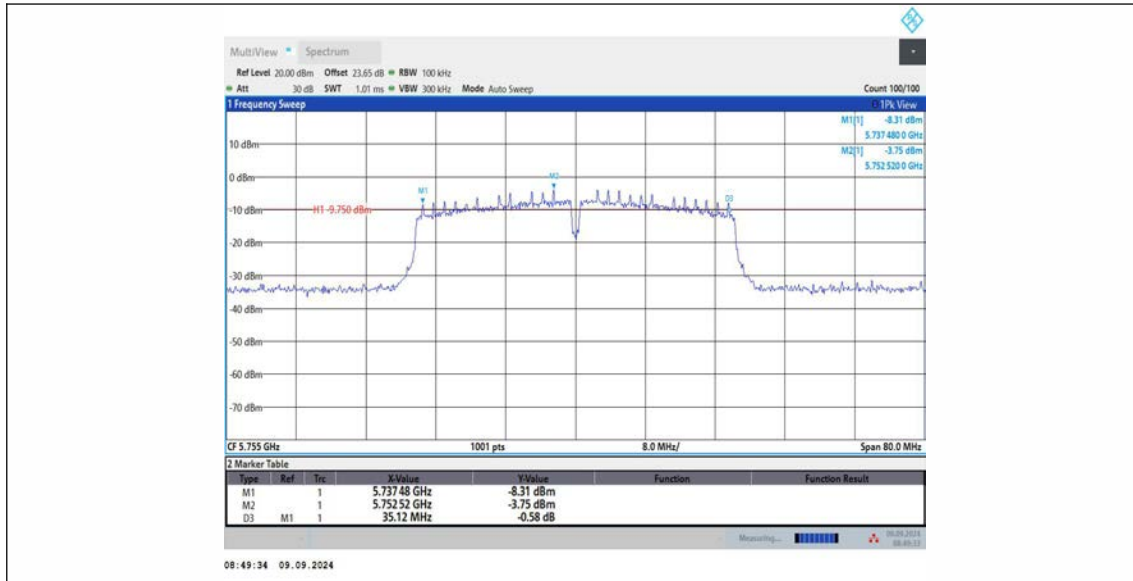

11N40MIMO\_Ant2\_5755

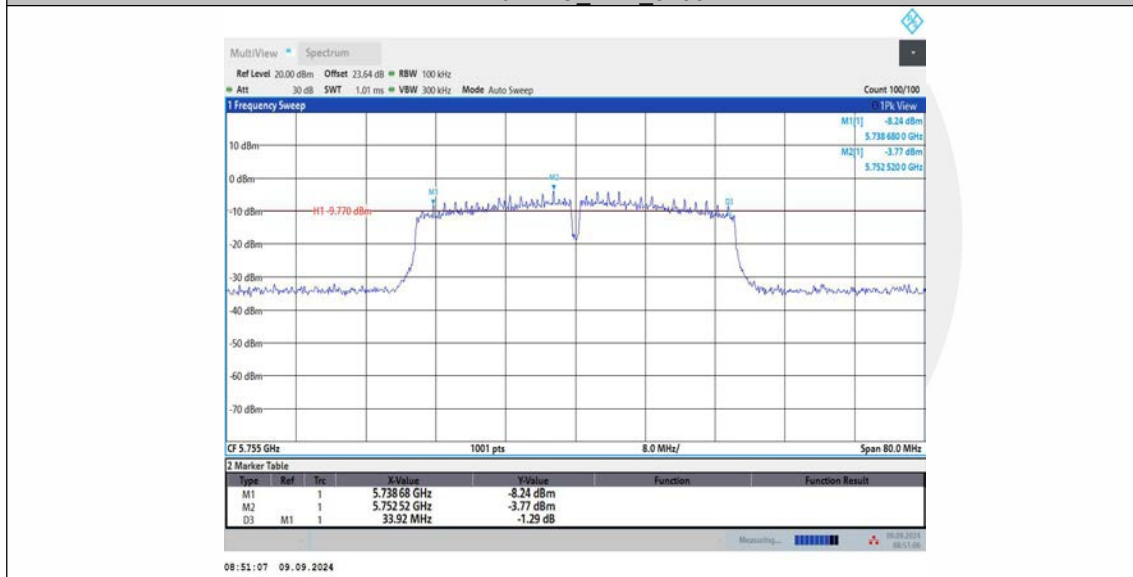

11N40MIMO\_Ant1\_5795

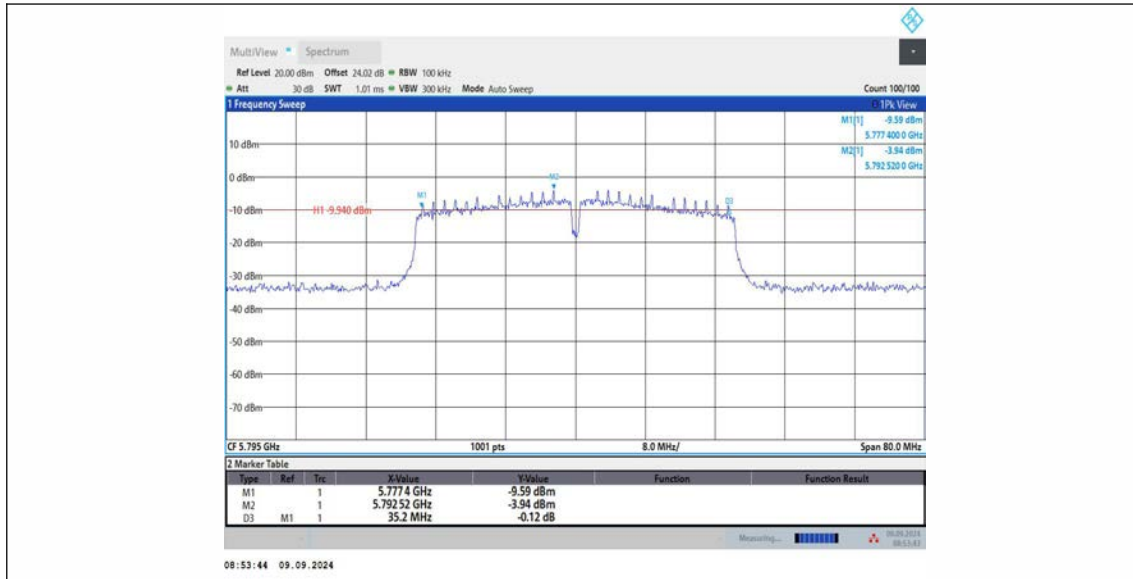

11N40MIMO\_Ant2\_5795

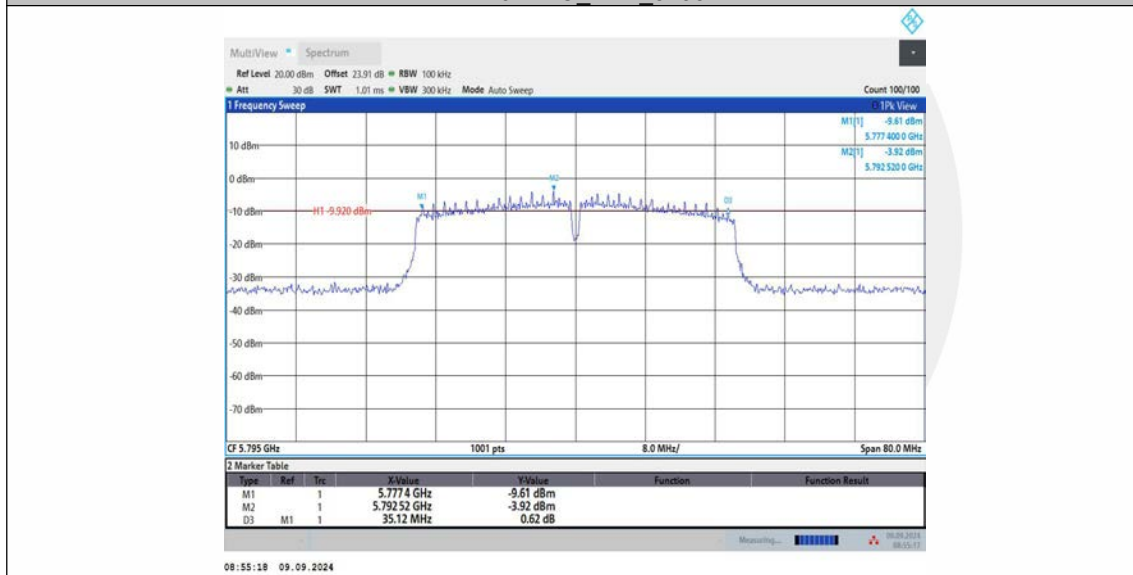

11AC20MIMO\_Ant1\_5745

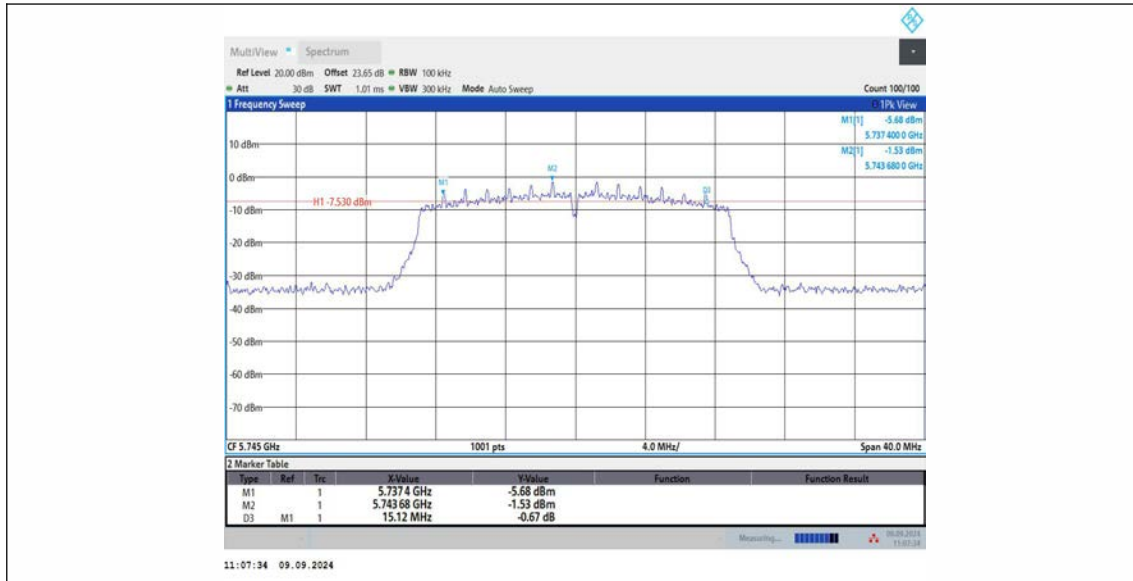

11AC20MIMO\_Ant2\_5745

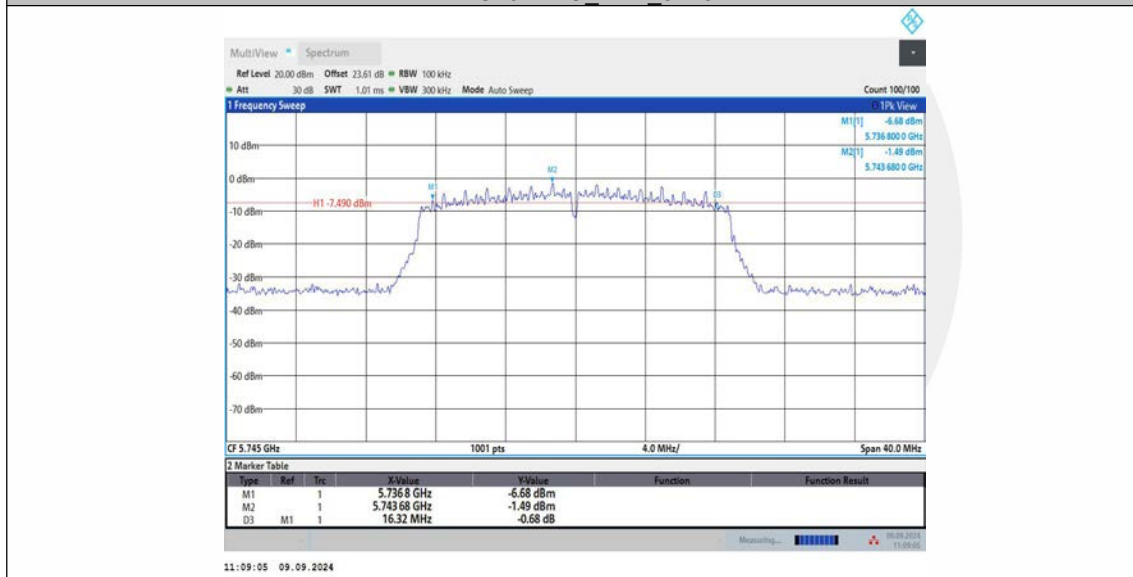

11AC20MIMO\_Ant1\_5785

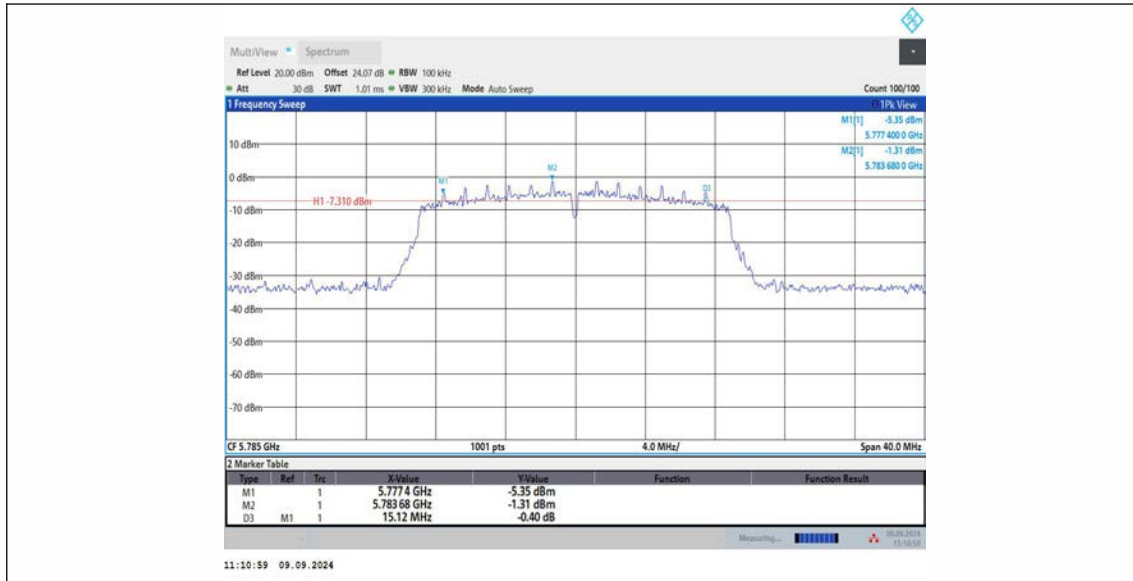

11AC20MIMO\_Ant2\_5785

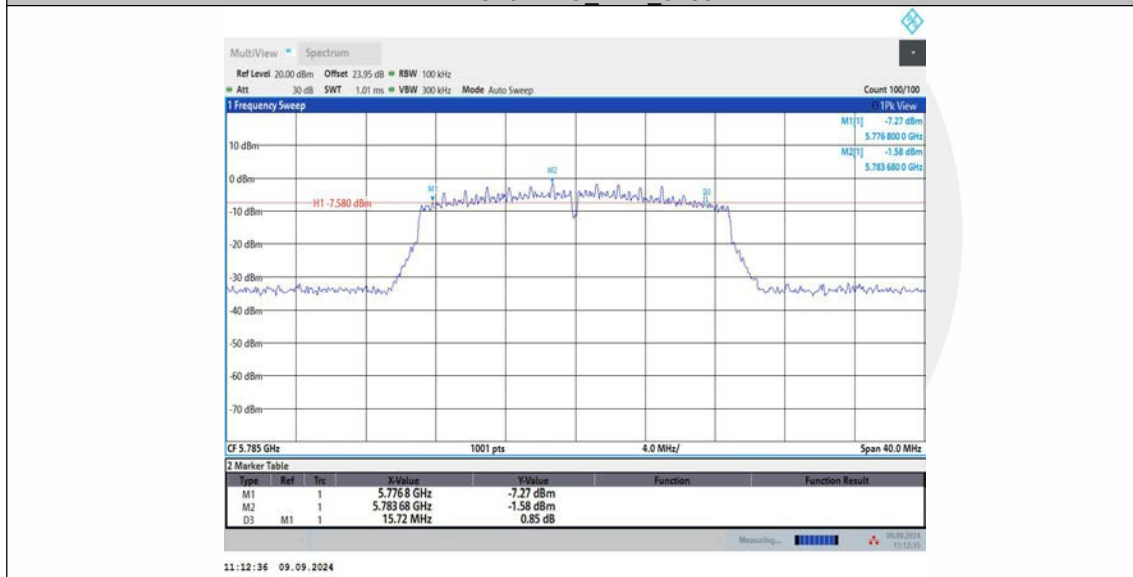

11AC20MIMO\_Ant1\_5825