

Report on the RF Testing of:

JRC Mobility Inc.
IT Controller, Model: JRN-430K
FCC ID: 2AX5HJRN-430K

In accordance with FCC Part 27 Subpart C
and FCC Part 27 Subpart H
and FCC Part 27 Subpart L

Prepared for: JRC Mobility Inc.
NAKANO CENTRAL PARK EAST,10-1, Nakano 4-
chome, Nakano-ku, Tokyo 164-8570, Japan
Phone: +81-26-214-0267 Fax: +81-26-214-5779



COMMERCIAL-IN-CONFIDENCE

Document Number: JPD-TR-20223-0

SIGNATURE			
NAME	JOB TITLE	RESPONSIBLE FOR	ISSUE DATE
Hiroaki Suzuki	Deputy Manager of RF Group	Approved Signatory	11 DEC 2020

Signatures in this approval box have checked this document in line with the requirements of TÜV SÜD Japan Ltd. document control rules.

EXECUTIVE SUMMARY - Result: Complied

A sample(s) of this product was tested and the result above was confirmed in accordance with FCC Part 27 Subpart C and FCC Part 27 Subpart H and FCC Part 27 Subpart L.



DISCLAIMER AND COPYRIGHT

The results in this report are applicable only to the equipment tested.
This report shall not be re-produced except in full without the written approval of TÜV SÜD Japan Ltd.

ACCREDITATION

This test report must not be used by the client to claim product certification, approval, or endorsement by A2LA or any agency of the federal government.

TÜV SÜD Japan Ltd.
Yonezawa Testing Center
5-4149-7 Hachimanpara,
Yonezawa-shi, Yamagata,
992-1128 Japan

Phone: +81 (0) 238 28 2881
Fax: +81 (0) 238 28 2888
www.tuv-sud.jp



Contents

1	Summary of Test	3
1.1	Modification history of the test report.....	3
1.2	Standards.....	3
1.3	Test methods.....	3
1.4	Deviation from standards.....	3
1.5	List of applied test(s) of the EUT.....	3
1.6	Test information.....	3
1.7	Test set up.....	3
1.8	Test period.....	3
2	Equipment Under Test	4
2.1	EUT information.....	4
2.2	Modification to the EUT.....	5
2.3	Variation of family model(s).....	5
2.4	Description of test mode.....	6
3	Configuration of Equipment	7
3.1	Equipment used.....	7
3.2	Cable(s) used.....	7
3.3	System configuration.....	7
4	Test Result	8
4.1	Effective Radiated Power.....	8
4.2	Effective Isotropic Radiated Power.....	12
4.3	Radiated Emissions and Harmonic Emissions.....	17
5	Measurement Uncertainty	30
6	Laboratory Information	31
	Appendix A. Test Equipment	32

1 Summary of Test

1.1 Modification history of the test report

Document Number	Modification History	Issue Date
JPD-TR-20223-0	First Issue	Refer to the cover page

1.2 Standards

CFR47 FCC Part 27 Subpart C
CFR47 FCC Part 27 Subpart H
CFR47 FCC Part 27 Subpart L

1.3 Test methods

KDB 971168 D01 Power Meas License Digital Systems v03r01
ANSI/TIA/EIA-603-E-2016
ANSI C63.26-2015

1.4 Deviation from standards

None

1.5 List of applied test(s) of the EUT

Test item section	Test item	Condition	Result	Remark
2.1046	Conducted Output Power	Conducted	N/A	*1
27.50	Effective Radiated Power	Radiated	PASS	-
27.50	Peak to Average Ratio	Conducted	N/A	*1
2.1049	Occupied Bandwidth	Conducted	N/A	*1
27.53 2.1051	Band Edge Spurious and Harmonic at Antenna Terminal	Conducted	N/A	*1
27.53 2.1053	Radiated emissions and Harmonic Emissions	Radiated	PASS	-
27.54 2.1055	Frequency Stability	Conducted	N/A	*1

*1: This product has a certified module inside it. (FCC ID: QIPPLS62-W)
Therefore, it was only measured radiated test.

1.6 Test information

None

1.7 Test set up

Table-top

1.8 Test period

12-November-2020 - 25-November-2020



2 Equipment Under Test

2.1 EUT information

Applicant	JRC Mobility Inc. NAKANO CENTRAL PARK EAST,10-1, Nakano 4-chome, Nakano-ku, Tokyo 164-8570, Japan Phone: +81-26-214-0267 Fax: +81-26-214-5779
Equipment Under Test (EUT)	IT Controller
Model number	JRN-430K
Serial number	N/A
Trade name	JRC
Number of sample(s)	1
EUT condition	Pre-Production
Power rating	Battery: DC 24 V
Size	(W) 160.0 × (D) 43.6 × (H) 220.0 mm
Environment	Indoor use
Terminal limitation	-30°C to 70°C
Hardware version	EE00-JRN-430K
Software version	1.00
Firmware version	Not applicable
RF Specification	
Frequency of Operation	Up Link WCDMA Band IV: 1712.4-1752.6 MHz LTE Band IV: 1710.0-1755.0 MHz LTE Band XII: 699.0-716.0 MHz Down Link WCDMA Band IV: 2112.4-2152.6 MHz LTE Band IV: 2110.0-2155.0 MHz LTE Band XII: 729.0-746.0 MHz
Modulation type	WCDMA Band IV: QPSK, 16QAM LTE Band IV: QPSK, 16QAM LTE Band XII: QPSK, 16QAM



Emission designator	WCDMA Band IV: 4M09F9W LTE Band IV: BW 1.4M QPSK: 1M10G7D, 16QAM: 1M10W7D BW 3M QPSK: 2M69G7D, 16QAM: 2M69W7D BW 5M QPSK: 4M50G7D, 16QAM: 4M50W7D BW 10M QPSK: 8M94G7D, 16QAM: 8M94W7D BW 15M QPSK: 13M6G7D, 16QAM: 13M5W7D BW 20M QPSK: 17M9G7D, 16QAM: 17M9W7D LTE Band XII: BW 1.4M QPSK: 1M10G7D, 16QAM: 1M10W7D BW 3M QPSK: 2M69G7D, 16QAM: 2M69W7D BW 5M QPSK: 4M50G7D, 16QAM: 4M47W7D BW 10M QPSK: 9M04G7D, 16QAM: 9M04W7D
Effective Radiated Power (E.R.P.)	WCDMA Band IV: 0.115 W (20.6 dBm) LTE Band IV: 0.288 W (24.6 dBm) LTE Band XII: 0.102 W (20.1 dBm)
Antenna type	External antenna
Antenna gain	WCDMA Band IV: 1.6 dBi LTE Band IV: 1.6 dBi LTE Band XII: -1.0 dBi

2.2 Modification to the EUT

The table below details modifications made to the EUT during the test project.

Modification State	Description of Modification	Modification fitted by	Date of Modification
Model: JRN-430K, Serial Number: N/A			
0	As supplied by the applicant	Not Applicable	Not Applicable

2.3 Variation of family model(s)

2.3.1 List of family model(s)

Not applicable

2.3.2 Reason for selection of EUT

Not applicable

2.4 Description of test mode

The EUT had been tested under operating condition.
There are three channels have been tested as following:

Band	Modulation	Bandwidth [MHz]	Channel	Frequency [MHz]
WCDMA Band IV	QPSK	-	1312, 1413, 1513	1712.4, 1732.6, 1752.6
	16QAM	-	1312, 1413, 1513	1712.4, 1732.6, 1752.6
LTE Band IV	QPSK, 16QAM	1.4	19957, 20175, 20393	1710.7, 1732.5, 1754.3
		3	19965, 20175, 20385	1711.5, 1732.5, 1753.5
		5	19975, 20175, 20375	1712.5, 1732.5, 1752.5
		10	20000, 20175, 20350	1715.0, 1732.5, 1750.0
		15	20025, 20175, 20325	1717.5, 1732.5, 1747.5
		20	20050, 20175, 20300	1720.0, 1732.5, 1745.0
LTE Band XII	QPSK, 16QAM	1.4	23017, 23095, 23173	699.7, 707.5, 715.3
		3	23025, 23095, 23165	700.5, 707.5, 714.5
		5	23035, 23095, 23155	701.5, 707.5, 713.5
		10	23060, 23095, 23130	704.0, 707.5, 711.0

The field strength of spurious emissions was measured at each position of all three axis X, Y and Z to compare the level, and the maximum noise.

The worst emission was found in X-axis (All Bands) and the worst case recorded.

Pre-scan has been conducted to determine the worst-case mode from all possible combinations between available modulations, data rates and antenna ports.

3 Configuration of Equipment

Numbers assigned to equipment on the diagram in “3.2 System configuration” correspond to the list in “3.1 Equipment used”.

This test configuration is based on the manufacture’s instruction.

Cabling and setup(s) were taken into consideration and test data was taken under worse case condition.

3.1 Equipment used

No.	Equipment	Company	Model No.	Serial No.	FCC ID/DoC	Comment
1	IT Controller	JRC Mobility	JRN-430K	N/A	2AX5HJRN-430K	EUT
2	Antenna	NIPPON ANTENNA	DP-BRO	N/A	-	Accessory
3	Antenna	NIPPON ANTENNA	DP-BRO	N/A	-	Accessory

3.2 Cable(s) used

No.	Equipment	Length[m]	Shield	Connector	Comment
a	Antenna cable	2.0	Yes	Metal	-
b	Antenna cable	2.0	Yes	Metal	-
c	DC cable	2.0	No	Plastic	-

3.3 System configuration

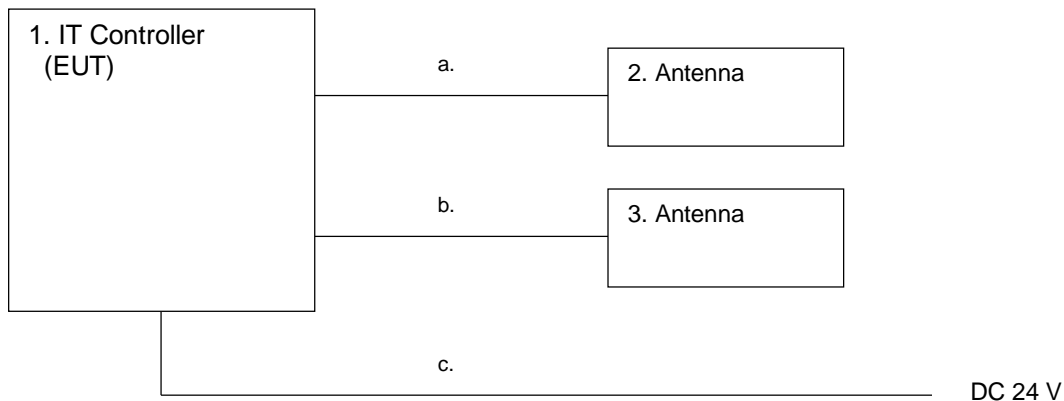

4 Test Result

4.1 Effective Radiated Power

4.1.1 Measurement procedure

[FCC 27.50]

<Step 1>

The EUT and support equipment are placed on a 1 meter x 1 meter surface, 0.8 meter (below or equal 1 GHz) and/or 1.5 meter (above 1 GHz) height styrene foam table. Radiated emission measurements are performed at 3 meter distance with the broadband antenna (Log periodic antenna). The antenna is positioned both the horizontal and vertical planes of polarization and height is varied 1 to 4 meters and stopped at height producing the maximum emission.

The bandwidth of the spectrum analyzer is set to 1 MHz. The turntable is rotated by 360 degrees and stopped at azimuth of producing the maximum emission.

<Step 2>

The substitution antenna is replaced by the transmitter antenna (EUT).

The frequency of the signal generator is adjusted to the measurement frequency.

Level of the signal generator is adjusted to the level that is obtained from step 1, and record the emission level of signal generator.

The spectrum analyzer is set to;

- a) Span = 1.5 times the OBW
- b) RBW = 1-5% of the expected OBW, not to exceed 1 MHz
- c) VBW $\geq 3 \times$ RBW
- d) Number of sweep points $\geq 2 \times$ span / RBW
- e) Sweep time = auto-couple
- f) Detector = RMS (power averaging)
- g) If the EUT can be configured to transmit continuously (i.e., burst duty cycle $\geq 98\%$), then set the trigger to free run.
- h) If the EUT cannot be configured to transmit continuously (i.e., burst duty cycle $< 98\%$), then use a sweep trigger with the level set to enable triggering only on full power bursts and configure the EUT to transmit at full power for the entire duration of each sweep. Ensure that the sweep time is less than or equal to the transmission burst duration.
- i) Trace average at least 100 traces in power averaging (i.e., RMS) mode.
- j) Compute the power by integrating the spectrum across the OBW of the signal using the instrument's band power measurement function, with the band limits set equal to the OBW band edges.

If the instrument does not have a band power function, then sum the spectrum levels (in linear power units) at intervals equal to the RBW extending across the entire OBW of the spectrum.

- Test configuration

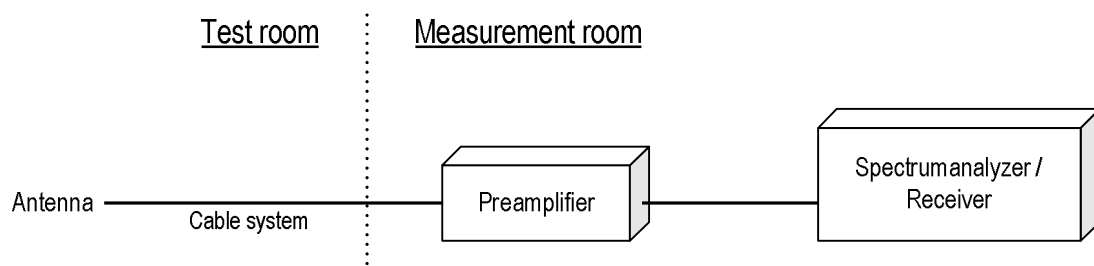

4.1.2 Calculation method

Result (ERP) = S.G Reading - Cable loss + Antenna Gain
 Margin = Limit – Result (ERP)

Example:

Limit @ 707.5 MHz : 34.7 dBm

Ant. Input = 33.3 dBm Cable loss = 0.7 dB Ant. Gain = -10.7 dBd

Result = 33.3 - 0.7 + (-10.7) = 21.9 dBm

Margin = 34.7 – 21.9= 12.8 dB

4.1.3 Limit

3 W (34.7 dBm)

4.1.4 Test data

Date	: 16-November-2020		
Temperature	: 22.6 [°C]		
Humidity	: 31.8 [%]	Test engineer	:
Test place	: 3m Semi-anechoic chamber		<u>Chiaki Kanno</u>
Date	: 17-November-2020		
Temperature	: 23.1 [°C]		
Humidity	: 26.6 [%]	Test engineer	:
Test place	: 3m Semi-anechoic chamber		<u>Tadahiro Seino, Chiaki Kanno</u>
Date	: 18-November-2020		
Temperature	: 23.5 [°C]		
Humidity	: 34.4 [%]	Test engineer	:
Test place	: 3m Semi-anechoic chamber		<u>Chiaki Kanno</u>
Date	: 19-November-2020		
Temperature	: 23.2 [°C]		
Humidity	: 34.9 [%]	Test engineer	:
Test place	: 3m Semi-anechoic chamber		<u>Chiaki Kanno</u>
Date	: 20-November-2020		
Temperature	: 24.8 [°C]		
Humidity	: 37.8 [%]	Test engineer	:
Test place	: 3m Semi-anechoic chamber		<u>Chiaki Kanno</u>
Date	: 24-November-2020		
Temperature	: 24.4 [°C]		
Humidity	: 24.8 [%]	Test engineer	:
Test place	: 3m Semi-anechoic chamber		<u>Tadahiro Seino</u>

**[LTE Band XII]
QPSK, BW 1.4MHz**

H/V	Frequency [MHz]	S.A Reading [dBm]	Ant. Input [dBm]	Cable loss [dB]	Ant.Gain [dBd]	Result [dBm]	Limit [dBm]	Margin [dB]
H	699.7	-15.3	25.3	0.7	-5.7	18.9	34.7	15.8
H	707.5	-15.5	25.2	0.7	-5.8	18.8	34.7	15.9
H	715.3	-15.3	25.8	0.7	-5.8	19.3	34.7	15.4

16QAM, BW 1.4MHz

H/V	Frequency [MHz]	S.A Reading [dBm]	Ant. Input [dBm]	Cable loss [dB]	Ant.Gain [dBd]	Result [dBm]	Limit [dBm]	Margin [dB]
H	699.7	-16.2	24.4	0.7	-5.7	18.0	34.7	16.7
H	707.5	-16.4	24.3	0.7	-5.8	17.9	34.7	16.8
H	715.3	-16.3	24.8	0.7	-5.8	18.3	34.7	16.4

QPSK, BW 3MHz

H/V	Frequency [MHz]	S.A Reading [dBm]	Ant. Input [dBm]	Cable loss [dB]	Ant.Gain [dBd]	Result [dBm]	Limit [dBm]	Margin [dB]
H	700.5	-14.9	25.7	0.7	-5.7	19.3	34.7	15.4
H	707.5	-15.5	25.2	0.7	-5.8	18.8	34.7	15.9
H	714.5	-14.5	26.6	0.7	-5.8	20.1	34.7	14.6

16QAM, BW 3MHz

H/V	Frequency [MHz]	S.A Reading [dBm]	Ant. Input [dBm]	Cable loss [dB]	Ant.Gain [dBd]	Result [dBm]	Limit [dBm]	Margin [dB]
H	700.5	-16.1	24.5	0.7	-5.7	18.1	34.7	16.6
H	707.5	-16.5	24.2	0.7	-5.8	17.8	34.7	16.9
H	714.5	-15.6	25.5	0.7	-5.8	19.0	34.7	15.7

QPSK, BW 5MHz

H/V	Frequency [MHz]	S.A Reading [dBm]	Ant. Input [dBm]	Cable loss [dB]	Ant.Gain [dBd]	Result [dBm]	Limit [dBm]	Margin [dB]
H	701.5	-15.3	25.3	0.7	-5.7	18.9	34.7	15.8
H	707.5	-15.5	25.2	0.7	-5.8	18.8	34.7	15.9
H	713.5	-14.7	26.4	0.7	-5.8	19.9	34.7	14.8

16QAM, BW 5MHz

H/V	Frequency [MHz]	S.A Reading [dBm]	Ant. Input [dBm]	Cable loss [dB]	Ant.Gain [dBd]	Result [dBm]	Limit [dBm]	Margin [dB]
H	701.5	-16.1	24.5	0.7	-5.7	18.1	34.7	16.6
H	707.5	-16.4	24.3	0.7	-5.8	17.9	34.7	16.8
H	713.5	-15.6	25.5	0.7	-5.8	19.0	34.7	15.7

QPSK, BW 10MHz

H/V	Frequency [MHz]	S.A Reading [dBm]	Ant. Input [dBm]	Cable loss [dB]	Ant. Gain [dBd]	Result [dBm]	Limit [dBm]	Margin [dB]
H	704.0	-15.5	25.1	0.7	-5.7	18.7	34.7	16.0
H	707.5	-15.5	25.2	0.7	-5.8	18.8	34.7	15.9
H	711.0	-15.0	26.2	0.7	-5.8	19.7	34.7	15.0

16QAM, BW 10MHz

H/V	Frequency [MHz]	S.A Reading [dBm]	Ant. Input [dBm]	Cable loss [dB]	Ant. Gain [dBd]	Result [dBm]	Limit [dBm]	Margin [dB]
H	704.0	-16.2	24.4	0.7	-5.7	18.0	34.7	16.7
H	707.5	-16.4	24.3	0.7	-5.8	17.9	34.7	16.8
H	711.0	-15.9	25.2	0.7	-5.8	18.7	34.7	16.0

4.2 Effective Isotropic Radiated Power

4.2.1 Measurement procedure

[FCC 27.50]

<Step 1>

The EUT and support equipment are placed on a 1 meter x 1 meter surface, 0.8 meter (below or equal 1 GHz) and/or 1.5 meter (above 1 GHz) height styrene foam table. Radiated emission measurements are performed at 3 meter distance with the broadband antenna (Log periodic antenna). The antenna is positioned both the horizontal and vertical planes of polarization and height is varied 1 to 4 meters and stopped at height producing the maximum emission.

The bandwidth of the spectrum analyzer is set to 1 MHz. The turntable is rotated by 360 degrees and stopped at azimuth of producing the maximum emission.

<Step 2>

The substitution antenna is replaced by the transmitter antenna (EUT).

The frequency of the signal generator is adjusted to the measurement frequency.

Level of the signal generator is adjusted to the level that is obtained from step 1, and record the emission level of signal generator.

The spectrum analyzer is set to;

- k) Span = 1.5 times the OBW
- l) RBW = 1-5% of the expected OBW, not to exceed 1 MHz
- m) VBW $\geq 3 \times$ RBW
- n) Number of sweep points $\geq 2 \times$ span / RBW
- o) Sweep time = auto-couple
- p) Detector = RMS (power averaging)
- q) If the EUT can be configured to transmit continuously (i.e., burst duty cycle $\geq 98\%$), then set the trigger to free run.
- r) If the EUT cannot be configured to transmit continuously (i.e., burst duty cycle $< 98\%$), then use a sweep trigger with the level set to enable triggering only on full power bursts and configure the EUT to transmit at full power for the entire duration of each sweep. Ensure that the sweep time is less than or equal to the transmission burst duration.
- s) Trace average at least 100 traces in power averaging (i.e., RMS) mode.
- t) Compute the power by integrating the spectrum across the OBW of the signal using the instrument's band power measurement function, with the band limits set equal to the OBW band edges.

If the instrument does not have a band power function, then sum the spectrum levels (in linear power units) at intervals equal to the RBW extending across the entire OBW of the spectrum.

- Test configuration

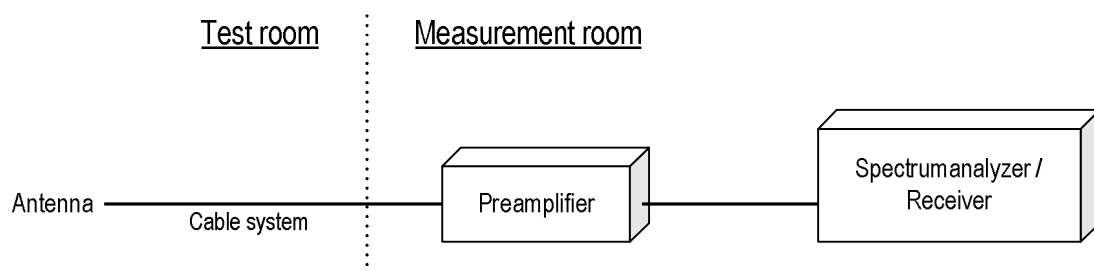

4.2.2 Calculation method

Result(EIRP) = Ant. Input - Cable loss + Antenna Gain
 Margin = Limit – Result (EIRP)

Example:

Limit @ 1732.5 MHz : 30.0 dBm
 Ant. Input = 19.3 dBm Cable loss = 1.1dB Ant. Gain = 8.3 dBi
 Result = 19.3 - 1.1 + 8.3 = 26.5 dBm
 Margin = 30.0 - 26.5 = 3.5 dB

4.2.3 Limit

1 W (30.0 dBm)

4.2.4 Test data

Date	: 12-November-2020		
Temperature	: 23.1 [°C]		
Humidity	: 23.6 [%]	Test engineer	:
Test place	: 3m Semi-anechoic chamber		<u>Tadahiro Seino</u>
Date	: 17-November-2020		
Temperature	: 23.1 [°C]		
Humidity	: 26.6 [%]	Test engineer	:
Test place	: 3m Semi-anechoic chamber		<u>Tadahiro Seino, Chiaki Kanno</u>
Date	: 18-November-2020		
Temperature	: 23.5 [°C]		
Humidity	: 34.4 [%]	Test engineer	:
Test place	: 3m Semi-anechoic chamber		<u>Chiaki Kanno</u>
Date	: 20-November-2020		
Temperature	: 24.8 [°C]		
Humidity	: 37.8 [%]	Test engineer	:
Test place	: 3m Semi-anechoic chamber		<u>Chiaki Kanno</u>
Date	: 24-November-2020		
Temperature	: 24.4 [°C]		
Humidity	: 24.8 [%]	Test engineer	:
Test place	: 3m Semi-anechoic chamber		<u>Tadahiro Seino</u>

[WCDMA Band IV]

H/V	Frequency [MHz]	S.A Reading [dBm]	Ant. Input [dBm]	Cable loss [dB]	Ant.Gain [dBi]	Result [dBm]	Limit [dBm]	Margin [dB]
H	1712.4	-34.4	10.8	1.1	5.5	15.2	30.0	14.8
H	1732.6	-32.9	11.8	1.1	5.2	15.9	30.0	14.1
H	1752.6	-29.6	16.7	1.1	5.0	20.6	30.0	9.4

[LTE Band IV]**QPSK, BW 1.4MHz**

H/V	Frequency [MHz]	S.A Reading [dBm]	Ant. Input [dBm]	Cable loss [dB]	Ant.Gain [dBi]	Result [dBm]	Limit [dBm]	Margin [dB]
H	1710.7	-24.4	20.0	1.1	5.5	24.4	30.0	5.6
H	1732.5	-24.1	20.5	1.1	5.2	24.6	30.0	5.4
H	1754.3	-25.8	20.0	1.1	5.0	23.9	30.0	6.1

16QAM, BW 1.4MHz

H/V	Frequency [MHz]	S.A Reading [dBm]	Ant. Input [dBm]	Cable loss [dB]	Ant.Gain [dBi]	Result [dBm]	Limit [dBm]	Margin [dB]
H	1710.7	-25.4	19.0	1.1	5.5	23.4	30.0	6.6
H	1732.5	-25.1	19.5	1.1	5.2	23.6	30.0	6.4
H	1754.3	-26.8	19.0	1.1	5.0	22.9	30.0	7.1

QPSK, BW 3MHz

H/V	Frequency [MHz]	S.A Reading [dBm]	Ant. Input [dBm]	Cable loss [dB]	Ant.Gain [dBi]	Result [dBm]	Limit [dBm]	Margin [dB]
H	1711.5	-24.6	20.1	1.1	5.5	24.5	30.0	5.5
H	1732.5	-24.4	20.2	1.1	5.2	24.3	30.0	5.7
H	1753.5	-25.3	20.7	1.1	5.0	24.6	30.0	5.4

16QAM, BW 3MHz

H/V	Frequency [MHz]	S.A Reading [dBm]	Ant. Input [dBm]	Cable loss [dB]	Ant.Gain [dBi]	Result [dBm]	Limit [dBm]	Margin [dB]
H	1711.5	-25.4	19.3	1.1	5.5	23.7	30.0	6.3
H	1732.5	-25.2	19.5	1.1	5.2	23.6	30.0	6.4
H	1753.5	-25.8	20.2	1.1	5.0	24.1	30.0	5.9

QPSK, BW 5MHz

H/V	Frequency [MHz]	S.A Reading [dBm]	Ant. Input [dBm]	Cable loss [dB]	Ant. Gain [dBi]	Result [dBm]	Limit [dBm]	Margin [dB]
H	1712.5	-24.6	20.0	1.1	5.5	24.4	30.0	5.6
H	1732.5	-24.4	20.3	1.1	5.2	24.4	30.0	5.6
H	1752.5	-26.4	19.4	1.1	5.0	23.3	30.0	6.7

16QAM, BW 5MHz

H/V	Frequency [MHz]	S.A Reading [dBm]	Ant. Input [dBm]	Cable loss [dB]	Ant. Gain [dBi]	Result [dBm]	Limit [dBm]	Margin [dB]
H	1712.5	-25.8	18.8	1.1	5.5	23.2	30.0	6.8
H	1732.5	-25.3	19.3	1.1	5.2	23.4	30.0	6.6
H	1752.5	-27.2	18.6	1.1	5.0	22.5	30.0	7.5

QPSK, BW 10MHz

H/V	Frequency [MHz]	S.A Reading [dBm]	Ant. Input [dBm]	Cable loss [dB]	Ant. Gain [dBi]	Result [dBm]	Limit [dBm]	Margin [dB]
H	1715.0	-24.9	19.6	1.1	5.4	23.9	30.0	6.1
H	1732.5	-24.7	20.0	1.1	5.2	24.1	30.0	5.9
H	1750.0	-26.1	19.9	1.1	5.0	23.9	30.0	6.1

16QAM, BW 10MHz

H/V	Frequency [MHz]	S.A Reading [dBm]	Ant. Input [dBm]	Cable loss [dB]	Ant. Gain [dBi]	Result [dBm]	Limit [dBm]	Margin [dB]
H	1715.0	-25.9	18.6	1.1	5.4	22.9	30.0	7.1
H	1732.5	-25.5	19.2	1.1	5.2	23.3	30.0	6.7
H	1750.0	-27.2	18.8	1.1	5.0	22.8	30.0	7.2

QPSK, BW 15MHz

H/V	Frequency [MHz]	S.A Reading [dBm]	Ant. Input [dBm]	Cable loss [dB]	Ant. Gain [dBi]	Result [dBm]	Limit [dBm]	Margin [dB]
H	1717.5	-24.7	19.6	1.1	5.4	23.9	30.0	6.1
H	1732.5	-25.9	18.7	1.1	5.2	22.8	30.0	7.2
H	1747.5	-25.6	20.6	1.1	5.1	24.6	30.0	5.4

16QAM, BW 15MHz

H/V	Frequency [MHz]	S.A Reading [dBm]	Ant. Input [dBm]	Cable loss [dB]	Ant. Gain [dBi]	Result [dBm]	Limit [dBm]	Margin [dB]
H	1717.5	-25.7	18.7	1.1	5.4	23.0	30.0	7.0
H	1732.5	-26.7	17.9	1.1	5.2	22.0	30.0	8.0
H	1747.5	-26.4	19.6	1.1	5.1	23.6	30.0	6.4

QPSK, BW 20MHz

H/V	Frequency [MHz]	S.A Reading [dBm]	Ant. Input [dBm]	Cable loss [dB]	Ant. Gain [dBi]	Result [dBm]	Limit [dBm]	Margin [dB]
H	1720.0	-24.7	19.5	1.1	5.4	23.8	30.0	6.2
H	1732.5	-25.2	19.4	1.1	5.2	23.5	30.0	6.5
H	1745.0	-26.1	19.9	1.1	5.1	23.9	30.0	6.1

16QAM, BW 20MHz

H/V	Frequency [MHz]	S.A Reading [dBm]	Ant. Input [dBm]	Cable loss [dB]	Ant. Gain [dBi]	Result [dBm]	Limit [dBm]	Margin [dB]
H	1720.0	-25.9	18.3	1.1	5.4	22.6	30.0	7.4
H	1732.5	-25.6	19.0	1.1	5.2	23.1	30.0	6.9
H	1745.0	-26.9	19.1	1.1	5.1	23.1	30.0	6.9

4.3 Radiated Emissions and Harmonic Emissions

4.3.1 Measurement procedure

[FCC 27.53, 2.1053]

<Step 1>

The EUT and support equipment are placed on a 1 meter x 1 meter surface, 0.8 meter (below or equal 1 GHz) and/or 1.5 meter (above 1 GHz) height styrene foam table. Radiated emission measurements are performed at 3 meter distance with the broadband antenna (Biconical antenna, Log periodic antenna and double ridged guide antenna). The antenna is positioned both the horizontal and vertical planes of polarization and height is varied 1 to 4 meters and stopped at height producing the maximum emission.

The bandwidth of the spectrum analyzer is set to 1 MHz. The turntable is rotated by 360 degrees and stopped at azimuth of producing the maximum emission. The frequency is investigated up to 20GHz.

<Step 2>

The substitution antenna is replaced by the transmitter antenna (EUT).

The frequency of the signal generator is adjusted to the measurement frequency.

Level of the signal generator is adjusted to the level that is obtained from step 1, and record the emission level of signal generator.

The spectrum analyzer is set to;

- RBW = 100 kHz for below 1GHz and 1MHz for above 1GHz / VBW $\geq 3 \times$ RBW
- Detector = Peak
- Trace mode = Max hold
- Sweep time = auto-couple

- Test configuration

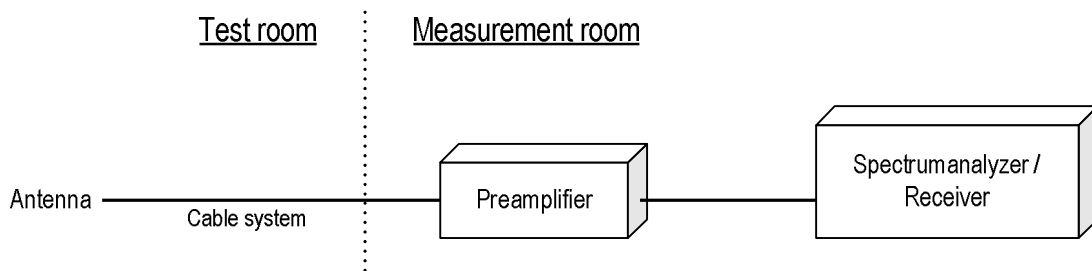



Japan

4.3.2 Calculation method

Result (EIRP) = Ant. Input - Cable loss + Antenna Gain
Margin = Limit - Result (EIRP)

Example:

Limit @ 3465.0 MHz : -13.0 dBm
Ant. Input = -50.7 dBm Cable loss = 1.6 dB Ant. Gain = 9.1 dBi
Result = $-50.7 - 1.6 + 9.1 = -43.2$ dBm
Margin = $-13.0 - (-43.2) = 30.2$ dB

4.3.3 Limit

-13 dBm or less

4.3.4 Test data

Date	: 12-November-2020	Test engineer	:	<u>Tadahiro Seino</u>
Temperature	: 23.1 [°C]			
Humidity	: 23.6 [%]			
Test place	: 3m Semi-anechoic chamber			
Date	: 13-November-2020	Test engineer	:	<u>Tadahiro Seino</u>
Temperature	: 23.0 [°C]			
Humidity	: 23.8 [%]			
Test place	: 3m Semi-anechoic chamber			
Date	: 17-November-2020	Test engineer	:	<u>Chiaki Kanno</u>
Temperature	: 23.7 [°C]			
Humidity	: 38.1 [%]			
Test place	: 3m Semi-anechoic chamber			
Date	: 20-21-November-2020	Test engineer	:	<u>Chiaki Kanno</u>
Temperature	: 24.9 [°C]			
Humidity	: 42.0 [%]			
Test place	: 3m Semi-anechoic chamber			
Date	: 24-25-November-2020	Test engineer	:	<u>Tadahiro Seino</u>
Temperature	: 24.4 [°C]			
Humidity	: 24.8 [%]			
Test place	: 3m Semi-anechoic chamber			

[WCDMA Band IV]**Channel: 1312**

H/V	Frequency [MHz]	S.A Reading [dBm]	Ant. Input [dBm]	Cable loss [dB]	Ant.Gain [dBi]	Result [dBm]	Limit [dBm]	Margin [dB]
H	3424.8	-54.3	-57.0	1.5	8.0	-50.5	-13.0	37.5 *NF

Channel: 1413

H/V	Frequency [MHz]	S.A Reading [dBm]	Ant. Input [dBm]	Cable loss [dB]	Ant.Gain [dBi]	Result [dBm]	Limit [dBm]	Margin [dB]
H	3465.2	-53.5	-57.1	1.6	8.2	-50.5	-13.0	37.5 *NF

Channel: 1513

H/V	Frequency [MHz]	S.A Reading [dBm]	Ant. Input [dBm]	Cable loss [dB]	Ant.Gain [dBi]	Result [dBm]	Limit [dBm]	Margin [dB]
H	3505.2	-54.6	-57.5	1.6	8.4	-50.7	-13.0	37.7 *NF

Note

The " *NF " in the RSE table above is used to indicate a noise floor measurement.

**[LTE Band IV]
QPSK, BW 1.4MHz
Channel: 19957**

H/V	Frequency [MHz]	S.A Reading [dBm]	Ant. Input [dBm]	Cable loss [dB]	Ant.Gain [dBi]	Result [dBm]	Limit [dBm]	Margin [dB]
H	3421.4	-54.3	-57.9	1.5	8.0	-51.5	-13.0	36.5 *NF

Channel: 20175

H/V	Frequency [MHz]	S.A Reading [dBm]	Ant. Input [dBm]	Cable loss [dB]	Ant.Gain [dBi]	Result [dBm]	Limit [dBm]	Margin [dB]
H	3465.0	-54.2	-57.5	1.6	8.2	-50.9	-13.0	37.9 *NF

Channel: 20393

H/V	Frequency [MHz]	S.A Reading [dBm]	Ant. Input [dBm]	Cable loss [dB]	Ant.Gain [dBi]	Result [dBm]	Limit [dBm]	Margin [dB]
H	3508.6	-54.7	-58.0	1.6	8.3	-51.2	-13.0	38.2 *NF

**16QAM, BW 1.4MHz
Channel: 19957**

H/V	Frequency [MHz]	S.A Reading [dBm]	Ant. Input [dBm]	Cable loss [dB]	Ant.Gain [dBi]	Result [dBm]	Limit [dBm]	Margin [dB]
H	3421.4	-55.0	-58.5	1.5	8.0	-52.1	-13.0	39.1 *NF

Channel: 20175

H/V	Frequency [MHz]	S.A Reading [dBm]	Ant. Input [dBm]	Cable loss [dB]	Ant.Gain [dBi]	Result [dBm]	Limit [dBm]	Margin [dB]
H	3465.0	-54.5	-58.6	1.6	8.2	-52.0	-13.0	39.0 *NF

Channel: 20393

H/V	Frequency [MHz]	S.A Reading [dBm]	Ant. Input [dBm]	Cable loss [dB]	Ant.Gain [dBi]	Result [dBm]	Limit [dBm]	Margin [dB]
H	3508.6	-55.0	-58.4	1.6	8.3	-51.6	-13.0	38.6 *NF

Note

The " *NF " in the RSE table above is used to indicate a noise floor measurement.

QPSK, BW 3MHz**Channel: 19965**

H/V	Frequency [MHz]	S.A Reading [dBm]	Ant. Input [dBm]	Cable loss [dB]	Ant. Gain [dBi]	Result [dBm]	Limit [dBm]	Margin [dB]
H	3423.0	-54.3	-58.3	1.5	8.0	-51.8	-13.0	38.8 *NF

Channel: 20175

H/V	Frequency [MHz]	S.A Reading [dBm]	Ant. Input [dBm]	Cable loss [dB]	Ant. Gain [dBi]	Result [dBm]	Limit [dBm]	Margin [dB]
H	3465.0	-54.6	-59.2	1.6	8.2	-52.6	-13.0	39.6 *NF

Channel: 20385

H/V	Frequency [MHz]	S.A Reading [dBm]	Ant. Input [dBm]	Cable loss [dB]	Ant. Gain [dBi]	Result [dBm]	Limit [dBm]	Margin [dB]
H	3507.0	-54.2	-58.2	1.6	8.3	-51.4	-13.0	38.4 *NF

16QAM, BW 3MHz**Channel: 19965**

H/V	Frequency [MHz]	S.A Reading [dBm]	Ant. Input [dBm]	Cable loss [dB]	Ant. Gain [dBi]	Result [dBm]	Limit [dBm]	Margin [dB]
H	3423.0	-54.5	-58.6	1.5	8.0	-52.1	-13.0	39.1 *NF

Channel: 20175

H/V	Frequency [MHz]	S.A Reading [dBm]	Ant. Input [dBm]	Cable loss [dB]	Ant. Gain [dBi]	Result [dBm]	Limit [dBm]	Margin [dB]
H	3465.0	-55.0	-59.3	1.6	8.2	-52.7	-13.0	39.7 *NF

Channel: 20385

H/V	Frequency [MHz]	S.A Reading [dBm]	Ant. Input [dBm]	Cable loss [dB]	Ant. Gain [dBi]	Result [dBm]	Limit [dBm]	Margin [dB]
H	3507.0	-54.5	-58.4	1.6	8.3	-51.6	-13.0	38.6 *NF

Note

The " *NF " in the RSE table above is used to indicate a noise floor measurement.

QPSK, BW 5MHz**Channel: 19975**

H/V	Frequency [MHz]	S.A Reading [dBm]	Ant. Input [dBm]	Cable loss [dB]	Ant. Gain [dBi]	Result [dBm]	Limit [dBm]	Margin [dB]
H	3425.0	-53.8	-58.1	1.6	8.0	-51.6	-13.0	38.6 *NF

Channel: 20175

H/V	Frequency [MHz]	S.A Reading [dBm]	Ant. Input [dBm]	Cable loss [dB]	Ant. Gain [dBi]	Result [dBm]	Limit [dBm]	Margin [dB]
H	3465.0	-54.0	-58.3	1.6	8.2	-51.7	-13.0	38.7 *NF

Channel: 20375

H/V	Frequency [MHz]	S.A Reading [dBm]	Ant. Input [dBm]	Cable loss [dB]	Ant. Gain [dBi]	Result [dBm]	Limit [dBm]	Margin [dB]
H	3505.0	-54.5	-58.4	1.6	8.4	-51.6	-13.0	38.6 *NF

16QAM, BW 5MHz**Channel: 19975**

H/V	Frequency [MHz]	S.A Reading [dBm]	Ant. Input [dBm]	Cable loss [dB]	Ant. Gain [dBi]	Result [dBm]	Limit [dBm]	Margin [dB]
H	3425.0	-54.2	-58.2	1.6	8.0	-51.7	-13.0	38.7 *NF

Channel: 20175

H/V	Frequency [MHz]	S.A Reading [dBm]	Ant. Input [dBm]	Cable loss [dB]	Ant. Gain [dBi]	Result [dBm]	Limit [dBm]	Margin [dB]
H	3465.0	-54.5	-58.8	1.6	8.2	-52.2	-13.0	39.2 *NF

Channel: 20375

H/V	Frequency [MHz]	S.A Reading [dBm]	Ant. Input [dBm]	Cable loss [dB]	Ant. Gain [dBi]	Result [dBm]	Limit [dBm]	Margin [dB]
H	3505.0	-54.8	-58.7	1.6	8.4	-51.9	-13.0	38.9 *NF

Note

The " *NF " in the RSE table above is used to indicate a noise floor measurement.

QPSK, BW 10MHz**Channel: 20000**

H/V	Frequency [MHz]	S.A Reading [dBm]	Ant. Input [dBm]	Cable loss [dB]	Ant. Gain [dBi]	Result [dBm]	Limit [dBm]	Margin [dB]
H	3430.0	-53.8	-58.1	1.6	8.0	-51.6	-13.0	38.6 *NF

Channel: 20175

H/V	Frequency [MHz]	S.A Reading [dBm]	Ant. Input [dBm]	Cable loss [dB]	Ant. Gain [dBi]	Result [dBm]	Limit [dBm]	Margin [dB]
H	3465.0	-54.6	-58.9	1.6	8.2	-52.3	-13.0	39.3 *NF

Channel: 20350

H/V	Frequency [MHz]	S.A Reading [dBm]	Ant. Input [dBm]	Cable loss [dB]	Ant. Gain [dBi]	Result [dBm]	Limit [dBm]	Margin [dB]
H	3500.0	-54.1	-58.0	1.6	8.4	-51.2	-13.0	38.2 *NF

16QAM, BW 10MHz**Channel: 20000**

H/V	Frequency [MHz]	S.A Reading [dBm]	Ant. Input [dBm]	Cable loss [dB]	Ant. Gain [dBi]	Result [dBm]	Limit [dBm]	Margin [dB]
H	3430.0	-54.7	-58.8	1.6	8.0	-52.3	-13.0	39.3 *NF

Channel: 20175

H/V	Frequency [MHz]	S.A Reading [dBm]	Ant. Input [dBm]	Cable loss [dB]	Ant. Gain [dBi]	Result [dBm]	Limit [dBm]	Margin [dB]
H	3465.0	-54.8	-59.1	1.6	8.2	-52.5	-13.0	39.5 *NF

Channel: 20350

H/V	Frequency [MHz]	S.A Reading [dBm]	Ant. Input [dBm]	Cable loss [dB]	Ant. Gain [dBi]	Result [dBm]	Limit [dBm]	Margin [dB]
H	3500.0	-54.5	-58.4	1.6	8.4	-51.6	-13.0	38.6 *NF

Note

The " *NF " in the RSE table above is used to indicate a noise floor measurement.

QPSK, BW 15MHz**Channel: 20025**

H/V	Frequency [MHz]	S.A Reading [dBm]	Ant. Input [dBm]	Cable loss [dB]	Ant. Gain [dBi]	Result [dBm]	Limit [dBm]	Margin [dB]
H	3435.0	-54.3	-58.4	1.6	8.1	-51.9	-13.0	38.9 *NF

Channel: 20175

H/V	Frequency [MHz]	S.A Reading [dBm]	Ant. Input [dBm]	Cable loss [dB]	Ant. Gain [dBi]	Result [dBm]	Limit [dBm]	Margin [dB]
H	3465.0	-54.5	-59.2	1.6	8.2	-52.6	-13.0	39.6 *NF

Channel: 20325

H/V	Frequency [MHz]	S.A Reading [dBm]	Ant. Input [dBm]	Cable loss [dB]	Ant. Gain [dBi]	Result [dBm]	Limit [dBm]	Margin [dB]
H	3495.0	-54.5	-58.4	1.6	8.3	-51.6	-13.0	38.6 *NF

16QAM, BW 15MHz**Channel: 20025**

H/V	Frequency [MHz]	S.A Reading [dBm]	Ant. Input [dBm]	Cable loss [dB]	Ant. Gain [dBi]	Result [dBm]	Limit [dBm]	Margin [dB]
H	3435.0	-54.4	-58.5	1.6	8.1	-52.0	-13.0	39.0 *NF

Channel: 20175

H/V	Frequency [MHz]	S.A Reading [dBm]	Ant. Input [dBm]	Cable loss [dB]	Ant. Gain [dBi]	Result [dBm]	Limit [dBm]	Margin [dB]
H	3465.0	-54.7	-59.1	1.6	8.2	-52.5	-13.0	39.5 *NF

Channel: 20325

H/V	Frequency [MHz]	S.A Reading [dBm]	Ant. Input [dBm]	Cable loss [dB]	Ant. Gain [dBi]	Result [dBm]	Limit [dBm]	Margin [dB]
H	3495.0	-54.7	-58.7	1.6	8.3	-51.9	-13.0	38.9 *NF

Note

The " *NF " in the RSE table above is used to indicate a noise floor measurement.

QPSK, BW 20MHz**Channel: 20050**

H/V	Frequency [MHz]	S.A Reading [dBm]	Ant. Input [dBm]	Cable loss [dB]	Ant. Gain [dBi]	Result [dBm]	Limit [dBm]	Margin [dB]
H	3440.0	-54.1	-58.2	1.6	8.1	-51.7	-13.0	38.7 *NF

Channel: 20175

H/V	Frequency [MHz]	S.A Reading [dBm]	Ant. Input [dBm]	Cable loss [dB]	Ant. Gain [dBi]	Result [dBm]	Limit [dBm]	Margin [dB]
H	3465.0	-54.3	-58.5	1.6	8.2	-51.9	-13.0	38.9 *NF

Channel: 20300

H/V	Frequency [MHz]	S.A Reading [dBm]	Ant. Input [dBm]	Cable loss [dB]	Ant. Gain [dBi]	Result [dBm]	Limit [dBm]	Margin [dB]
H	3490.0	-54.1	-58.0	1.6	8.3	-51.3	-13.0	38.3 *NF

16QAM, BW 20MHz**Channel: 20050**

H/V	Frequency [MHz]	S.A Reading [dBm]	Ant. Input [dBm]	Cable loss [dB]	Ant. Gain [dBi]	Result [dBm]	Limit [dBm]	Margin [dB]
H	3440.0	-54.3	-58.4	1.6	8.1	-51.9	-13.0	38.9 *NF

Channel: 20175

H/V	Frequency [MHz]	S.A Reading [dBm]	Ant. Input [dBm]	Cable loss [dB]	Ant. Gain [dBi]	Result [dBm]	Limit [dBm]	Margin [dB]
H	3465.0	-54.4	-58.7	1.6	8.2	-52.1	-13.0	39.1 *NF

Channel: 20300

H/V	Frequency [MHz]	S.A Reading [dBm]	Ant. Input [dBm]	Cable loss [dB]	Ant. Gain [dBi]	Result [dBm]	Limit [dBm]	Margin [dB]
H	3490.0	-54.5	-58.4	1.6	8.3	-51.7	-13.0	38.7 *NF

Note

The " *NF " in the RSE table above is used to indicate a noise floor measurement.

**[LTE Band XII]
QPSK, BW 1.4MHz
Channel: 23017**

H/V	Frequency [MHz]	S.A Reading [dBm]	Ant. Input [dBm]	Cable loss [dB]	Ant.Gain [dBi]	Result [dBm]	Limit [dBm]	Margin [dB]
H	1399.4	-53.6	-58.8	1.0	4.6	-55.2	-13.0	42.2 *NF

Channel: 23095

H/V	Frequency [MHz]	S.A Reading [dBm]	Ant. Input [dBm]	Cable loss [dB]	Ant.Gain [dBi]	Result [dBm]	Limit [dBm]	Margin [dB]
H	1415.0	-51.5	-52.0	1.0	4.7	-48.2	-13.0	35.2 *NF

Channel: 23173

H/V	Frequency [MHz]	S.A Reading [dBm]	Ant. Input [dBm]	Cable loss [dB]	Ant.Gain [dBi]	Result [dBm]	Limit [dBm]	Margin [dB]
H	1430.6	-54.0	-60.3	1.0	4.9	-56.4	-13.0	43.4 *NF

16QAM, BW 1.4MHz

Channel: 23017

H/V	Frequency [MHz]	S.A Reading [dBm]	Ant. Input [dBm]	Cable loss [dB]	Ant.Gain [dBi]	Result [dBm]	Limit [dBm]	Margin [dB]
H	1399.4	-53.0	-58.2	1.0	4.6	-54.6	-13.0	41.6 *NF

Channel: 23095

H/V	Frequency [MHz]	S.A Reading [dBm]	Ant. Input [dBm]	Cable loss [dB]	Ant.Gain [dBi]	Result [dBm]	Limit [dBm]	Margin [dB]
H	1415.0	-51.8	-52.3	1.0	4.7	-48.5	-13.0	35.5 *NF

Channel: 23173

H/V	Frequency [MHz]	S.A Reading [dBm]	Ant. Input [dBm]	Cable loss [dB]	Ant.Gain [dBi]	Result [dBm]	Limit [dBm]	Margin [dB]
H	1430.6	-54.1	-60.4	1.0	4.9	-56.5	-13.0	43.5 *NF

Note

The " *NF " in the RSE table above is used to indicate a noise floor measurement.

QPSK, BW 3MHz**Channel: 23025**

H/V	Frequency [MHz]	S.A Reading [dBm]	Ant. Input [dBm]	Cable loss [dB]	Ant. Gain [dBi]	Result [dBm]	Limit [dBm]	Margin [dB]
H	1401.0	-52.6	-57.8	1.0	4.6	-54.2	-13.0	41.2 *NF

Channel: 23095

H/V	Frequency [MHz]	S.A Reading [dBm]	Ant. Input [dBm]	Cable loss [dB]	Ant. Gain [dBi]	Result [dBm]	Limit [dBm]	Margin [dB]
H	1415.0	-52.0	-52.5	1.0	4.7	-48.7	-13.0	35.7 *NF

Channel: 23165

H/V	Frequency [MHz]	S.A Reading [dBm]	Ant. Input [dBm]	Cable loss [dB]	Ant. Gain [dBi]	Result [dBm]	Limit [dBm]	Margin [dB]
H	1429.0	-53.9	-60.2	1.0	4.9	-56.3	-13.0	43.3 *NF

16QAM, BW 3MHz**Channel: 23025**

H/V	Frequency [MHz]	S.A Reading [dBm]	Ant. Input [dBm]	Cable loss [dB]	Ant. Gain [dBi]	Result [dBm]	Limit [dBm]	Margin [dB]
H	1401.0	-52.9	-58.1	1.0	4.6	-54.5	-13.0	41.5 *NF

Channel: 23095

H/V	Frequency [MHz]	S.A Reading [dBm]	Ant. Input [dBm]	Cable loss [dB]	Ant. Gain [dBi]	Result [dBm]	Limit [dBm]	Margin [dB]
H	1415.0	-52.1	-52.6	1.0	4.7	-48.8	-13.0	35.8 *NF

Channel: 23165

H/V	Frequency [MHz]	S.A Reading [dBm]	Ant. Input [dBm]	Cable loss [dB]	Ant. Gain [dBi]	Result [dBm]	Limit [dBm]	Margin [dB]
H	1429.0	-54.3	-60.6	1.0	4.9	-56.7	-13.0	43.7 *NF

Note

The " *NF " in the RSE table above is used to indicate a noise floor measurement.

QPSK, BW 5MHz**Channel: 23035**

H/V	Frequency [MHz]	S.A Reading [dBm]	Ant. Input [dBm]	Cable loss [dB]	Ant. Gain [dBi]	Result [dBm]	Limit [dBm]	Margin [dB]
H	1403.0	-52.5	-57.7	1.0	4.6	-54.1	-13.0	41.1 *NF

Channel: 23095

H/V	Frequency [MHz]	S.A Reading [dBm]	Ant. Input [dBm]	Cable loss [dB]	Ant. Gain [dBi]	Result [dBm]	Limit [dBm]	Margin [dB]
H	1415.0	-51.7	-52.2	1.0	4.7	-48.4	-13.0	35.4 *NF

Channel: 23155

H/V	Frequency [MHz]	S.A Reading [dBm]	Ant. Input [dBm]	Cable loss [dB]	Ant. Gain [dBi]	Result [dBm]	Limit [dBm]	Margin [dB]
H	1427.0	-52.8	-59.1	1.0	4.9	-55.2	-13.0	42.2 *NF

16QAM, BW 5MHz**Channel: 23035**

H/V	Frequency [MHz]	S.A Reading [dBm]	Ant. Input [dBm]	Cable loss [dB]	Ant. Gain [dBi]	Result [dBm]	Limit [dBm]	Margin [dB]
H	1403.0	-53.6	-58.8	1.0	4.6	-55.2	-13.0	42.2 *NF

Channel: 23095

H/V	Frequency [MHz]	S.A Reading [dBm]	Ant. Input [dBm]	Cable loss [dB]	Ant. Gain [dBi]	Result [dBm]	Limit [dBm]	Margin [dB]
H	1415.0	-51.9	-52.4	1.0	4.7	-48.6	-13.0	35.6 *NF

Channel: 23155

H/V	Frequency [MHz]	S.A Reading [dBm]	Ant. Input [dBm]	Cable loss [dB]	Ant. Gain [dBi]	Result [dBm]	Limit [dBm]	Margin [dB]
H	1427.0	-52.7	-58.9	1.0	4.9	-55.0	-13.0	42.0 *NF

Note

The " *NF " in the RSE table above is used to indicate a noise floor measurement.

QPSK, BW 10MHz**Channel: 23060**

H/V	Frequency [MHz]	S.A Reading [dBm]	Ant. Input [dBm]	Cable loss [dB]	Ant. Gain [dBi]	Result [dBm]	Limit [dBm]	Margin [dB]
H	1408.0	-53.5	-58.6	1.0	4.7	-54.9	-13.0	41.9 *NF

Channel: 23095

H/V	Frequency [MHz]	S.A Reading [dBm]	Ant. Input [dBm]	Cable loss [dB]	Ant. Gain [dBi]	Result [dBm]	Limit [dBm]	Margin [dB]
H	1415.0	-52.3	-52.8	1.0	4.7	-49.0	-13.0	36.0 *NF

Channel: 23130

H/V	Frequency [MHz]	S.A Reading [dBm]	Ant. Input [dBm]	Cable loss [dB]	Ant. Gain [dBi]	Result [dBm]	Limit [dBm]	Margin [dB]
H	1422.0	-50.2	-49.5	1.0	4.8	-45.7	-13.0	32.7 *NF

16QAM, BW 10MHz**Channel: 23060**

H/V	Frequency [MHz]	S.A Reading [dBm]	Ant. Input [dBm]	Cable loss [dB]	Ant. Gain [dBi]	Result [dBm]	Limit [dBm]	Margin [dB]
H	1408.0	-53.7	-58.9	1.0	4.7	-55.2	-13.0	42.2 *NF

Channel: 23095

H/V	Frequency [MHz]	S.A Reading [dBm]	Ant. Input [dBm]	Cable loss [dB]	Ant. Gain [dBi]	Result [dBm]	Limit [dBm]	Margin [dB]
H	1415.0	-52.2	-52.7	1.0	4.7	-48.9	-13.0	35.9 *NF

Channel: 23130

H/V	Frequency [MHz]	S.A Reading [dBm]	Ant. Input [dBm]	Cable loss [dB]	Ant. Gain [dBi]	Result [dBm]	Limit [dBm]	Margin [dB]
H	1422.0	-50.8	-50.3	1.0	4.8	-46.5	-13.0	33.5 *NF

Note

The " *NF " in the RSE table above is used to indicate a noise floor measurement.

5 Measurement Uncertainty

Expanded uncertainties stated are calculated with a coverage Factor k=2.
 Please note that these results are not taken into account when measurement uncertainty considerations contained in ETSI TR 100 028 Parts 1 and 2 determining compliance or non-compliance with test result.

Test item	Measurement uncertainty
Conducted emission, AMN (9 kHz – 150 kHz)	±3.7 dB
Conducted emission, AMN (150 kHz – 30 MHz)	±3.3 dB
Radiated emission (9kHz – 30 MHz)	±3.7 dB
Radiated emission (30 MHz – 1000 MHz)	±5.3 dB
Radiated emission (1 GHz – 6 GHz)	±4.4 dB
Radiated emission (6 GHz – 18 GHz)	±4.7 dB
Radiated emission (18 GHz – 40 GHz)	±5.8 dB
Radio Frequency	±1.4 * 10 ⁻⁸
RF power, conducted	±0.8 dB
Temperature	±0.6 °C
Humidity	±1.2 %
Voltage (DC)	±0.4 %
Voltage (AC, <10kHz)	±0.2 %

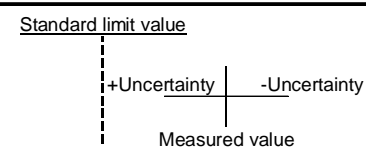
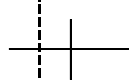
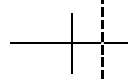
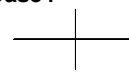
Judge	Measured value and standard limit value	
PASS	<p>Case1</p> 	Even if it takes uncertainty into consideration, a standard limit value is fulfilled.
	<p>Case2</p> 	Although measured value is in a standard limit value, a limit value won't be fulfilled if uncertainty is taken into consideration.
FAIL	<p>Case3</p> 	Although measured value exceeds a standard limit value, a limit value will be fulfilled if uncertainty is taken into consideration.
	<p>Case4</p> 	Even if it takes uncertainty into consideration, a standard limit value isn't fulfilled.



Japan

6 Laboratory Information

Testing was performed and the report was issued at:

TÜV SÜD Japan Ltd. Yonezawa Testing Center

Address: 5-4149-7 Hachimanpara, Yonezawa-shi, Yamagata, 992-1128 Japan

Phone: +81-238-28-2881

Fax: +81-238-28-2888

Accreditation and Registration

A2LA

Certificate #3686.03

VLAC

Accreditation No.: VLAC-013

BSMI

Laboratory Code: SL2-IN-E-6018, SL2-A1-E-6018

Innovation, Science and Economic Development Canada

ISED#: 4224A

VCCI Council

Registration number	Expiration date
A-0166	03-July-2021

Appendix A. Test Equipment

Radiated emission

Equipment	Company	Model No.	Serial No.	Cal. Due	Cal. Date
EMI Receiver	ROHDE&SCHWARZ	ESCI	100765	30-Sep-2021	28-Sep-2020
Spectrum analyzer	Agilent Technologies	E4447A	MY46180188	31-Mar-2021	27-Mar-2020
Spectrum analyzer	Agilent Technologies	E4440A	US44302655	31-Aug-2021	20-Aug-2020
Preamplifier	SONOMA	310	372170	30-Sep-2021	29-Sep-2020
Biconical antenna	Schwarzbeck	VHBB9124/BBA9106	1344	31-Dec-2020	04-Dec-2019
Log periodic antenna	Schwarzbeck	VUSLP9111B	344	30-Apr-2021	17-Apr-2020
Attenuator	TAMAGAWA.ELEC	CFA-01/6dB	N/A(S275)	30-Jun-2021	04-Jun-2020
Attenuator	TAMAGAWA.ELEC	CFA-10/3dB	N/A(S503)	31-Jul-2021	20-Jul-2020
Preamplifier	TSJ	MLA-100M18-B02-40	1929118	31-Jan-2021	08-Jan-2020
Attenuator	AEROFLEX	26A-10	081217-08	31-Jan-2021	10-Jan-2020
Double ridged guide antenna	ETS LINDGREN	3117	00209352	31-Dec-2020	16-Dec-2019
Double ridged guide antenna	ETS LINDGREN	3117	00052315	30-Apr-2021	08-Apr-2020
Attenuator	HUBER+SUHNER	6803.17.B	N/A(2341)	31-Dec-2020	18-Dec-2019
Double ridged guide antenna	A.H.Systems Inc.	SAS-574	469	30-Sep-2021	02-Sep-2020
Preamplifier	TSJ	MLA-1840-B03-35	1240332	30-Sep-2021	02-Sep-2020
Band rejection filter	Micro-Tronics	BRC50719	014	31-Dec-2020	18-Dec-2019
Notch Filter	Micro-Tronics	BRM50706	003	31-Jul-2021	21-Jul-2020
Signal generator	ROHDE&SCHWARZ	SMB100A	100341	31-Mar-2021	26-Mar-2020
Signal generator	ROHDE&SCHWARZ	SMR27	839256/034	31-Mar-2021	26-Mar-2020
RF power amplifier	R&K	CGA020M602-2633R	B40240	31-May-2021	15-May-2020
Microwave cable	HUBER+SUHNER	SUCOFLEX102/2m	31648	31-Mar-2021	26-Mar-2020
Dipole antenna	Schwarzbeck	VHAP	1020	31-Aug-2021	13-Aug-2020
Dipole antenna	Schwarzbeck	UHAP	994	31-Aug-2021	06-Aug-2020
Double ridged guide antenna	ETS LINDGREN	3117	00218815	31-Dec-2020	16-Dec-2019
Wideband Radio Frequency Tester	ROHDE&SCHWARZ	CMW500	126079	31-Oct-2021	21-Oct-2020
Wideband Radio Frequency Tester	ROHDE&SCHWARZ	CMW500	116338	30-Sep-2021	02-Sep-2020
Microwave cable	HUBER+SUHNER	SUCOFLEX104/9m	MY30037/4	31-Jan-2021	08-Jan-2020
		SUCOFLEX104/1m	my24610/4	31-Jan-2021	08-Jan-2020
		SUCOFLEX104/8m	SN MY30031/4	31-Jan-2021	09-Jan-2020
		SUCOFLEX104	MY32976/4	31-Jan-2021	08-Jan-2020
		SUCOFLEX104/1.5m	MY19309/4	31-Jan-2021	08-Jan-2020
		SUCOFLEX104/7m	41625/6	31-Jan-2021	08-Jan-2020
PC	DELL	DIMENSION E521	75465BX	N/A	N/A
Software	TOYO Corporation	EP5/RE-AJ	0611193/V5.6.0	N/A	N/A
Absorber	RIKEN	PPF30	N/A	N/A	N/A
3m Semi an-echoic Chamber	TOKIN	N/A	N/A(9002-NSA)	31-May-2021	29-May-2020
3m Semi an-echoic Chamber	TOKIN	N/A	N/A(9002-SVSWR)	31-May-2021	29-May-2020

*: The calibrations of the above equipment are traceable to NIST or equivalent standards of the reference organizations.