



中认信通
CHINA CERTIFICATION ICT CO., LTD (DONGGUAN)



TEST REPORT

Applicant: Shenzhen DOOGEE Hengtong Technology CO.,LTD

Address: B, 2/F, Building A4, Silicon Valley Power Digital Industrial Park,
No.22,Longhua New District, Shenzhen, China

FCC ID: 2AX4YX98PRO

Product Name: Smart Phone

Standard(s): 47 CFR Part 15, Subpart C(15.247)

ANSI C63.10-2013

KDB 558074 D01 15.247 Meas Guidance v05r02

The above equipment has been tested and found compliant with the requirement of the relative standards by China Certification ICT Co., Ltd (Dongguan)

Report Number: CR22090006-00C

Date Of Issue: 2022-09-20

Reviewed By: Sun Zhong

Sun Zhong

Title: Manager

Test Laboratory: China Certification ICT Co., Ltd (Dongguan)

No. 113, Pingkang Road, Dalang Town, Dongguan,

Guangdong, China

Tel: +86-769-82016888

Test Facility

The Test site used by China Certification ICT Co., Ltd (Dongguan) to collect test data is located on the No. 113, Pingkang Road, Dalang Town, Dongguan, Guangdong, China.

The lab has been recognized as the FCC accredited lab under the KDB 974614 D01 and is listed in the FCC Public Access Link (PAL) database, FCC Registration No. : 442868, the FCC Designation No. : CN1314.

The lab has been recognized by Innovation, Science and Economic Development Canada to test to Canadian radio equipment requirements, the CAB identifier: CN0123.

Declarations

China Certification ICT Co., Ltd (Dongguan) is not responsible for the authenticity of any test data provided by the applicant. Data included from the applicant that may affect test results are marked with a triangle symbol “▲”. Customer model name, addresses, names, trademarks etc. are not considered data.

Unless otherwise stated the results shown in this test report refer only to the sample(s) tested.

This report cannot be reproduced except in full, without prior written approval of the Company.

This report is valid only with a valid digital signature. The digital signature may be available only under the Adobe software above version 7.0.

This report may contain data that are not covered by the accreditation scope and shall be marked with an asterisk “★”.

CONTENTS

TEST FACILITY	2
DECLARATIONS.....	2
1. GENERAL INFORMATION	5
1.1 PRODUCT DESCRIPTION FOR EQUIPMENT UNDER TEST (EUT)	5
1.2 DESCRIPTION OF TEST CONFIGURATION.....	7
1.2.2 Support Equipment List and Details	7
1.2.3 Support Cable List and Details	7
1.2.4 Block Diagram of Test Setup.....	7
1.3 MEASUREMENT UNCERTAINTY	9
2. SUMMARY OF TEST RESULTS	10
3. REQUIREMENTS AND TEST PROCEDURES	11
3.1 AC LINE CONDUCTED EMISSIONS.....	11
3.1.1 Applicable Standard.....	11
3.1.2 EUT Setup.....	12
3.1.3 EMI Test Receiver Setup	12
3.1.4 Test Procedure	13
3.1.5 Corrected Amplitude & Margin Calculation.....	13
3.2 RADIATION SPURIOUS EMISSIONS	14
3.2.1 Applicable Standard.....	14
3.2.2 EUT Setup.....	14
3.2.3 EMI Test Receiver & Spectrum Analyzer Setup	15
3.2.4 Test Procedure	15
3.2.5 Corrected Amplitude & Margin Calculation.....	15
3.3 20 DB BANDWIDTH.....	16
3.3.1 Applicable Standard.....	16
3.3.2 EUT Setup.....	16
3.3.3 Test Procedure	16
3.4 CHANNEL SEPARATION	17
3.4.1 Applicable Standard.....	17
3.4.2 EUT Setup.....	17
3.4.3 Test Procedure	17
3.5 NUMBER OF HOPPING FREQUENCY	18
3.5.1 Applicable Standard.....	18
3.5.2 EUT Setup.....	18
3.5.3 Test Procedure	18
3.6 TIME OF OCCUPANCY(DWELL TIME).....	19
3.6.1 Applicable Standard.....	19
3.6.2 EUT Setup.....	19
3.6.3 Test Procedure	19
3.7 PEAK OUTPUT POWER.....	20
3.7.1 Applicable Standard.....	20

3.7.2 EUT Setup.....20

3.7.3 Test Procedure20

3.8 100 kHz BANDWIDTH OF FREQUENCY BAND EDGE.....21

3.8.1 Applicable Standard.....21

3.8.2 EUT Setup.....21

3.8.3 Test Procedure21

3.9 ANTENNA REQUIREMENT.....22

3.9.1 Applicable Standard.....22

3.9.2 Judgment.....22

4. TEST DATA AND RESULTS 23

4.1 AC LINE CONDUCTED EMISSIONS.....23

4.2 RADIATION SPURIOUS EMISSIONS26

4.3 20 dB EMISSION BANDWIDTH:32

4.4 CHANNEL SEPARATION:36

4.5 NUMBER OF HOPPING FREQUENCY:40

4.6 TIME OF OCCUPANCY(DWELL TIME):.....42

4.7 PEAK CONDUCTED OUTPUT POWER:46

4.8 100 kHz BANDWIDTH OF FREQUENCY BAND EDGE:47

5. RF EXPOSURE EVALUATION 54

5.1 APPLICABLE STANDARD.....54

5.2 PROCEDURE.....54

5.3 MEASUREMENT RESULT54

1. GENERAL INFORMATION

1.1 Product Description for Equipment under Test (EUT)

EUT Name:	Smart Phone
EUT Model:	X98Pro
Multiple Model:	X98T, X98, X98MAX
Operation Frequency:	2402-2480 MHz
Maximum Peak Output Power (Conducted):	3.13dBm
Modulation Type:	GFSK, $\pi/4$ -DQPSK, 8DPSK
Rated Input Voltage:	DC 3.87V from battery or DC 5V from adapter
Serial Number:	CR22090006-RF-S1
EUT Received Date:	2022.9.5
EUT Received Status:	Good

Note: The Multiple models are electrically identical with the test model. Please refer to the declaration letter for more detail, which was provided by manufacturer.

Operation Frequency Detail:

Channel	Frequency (MHz)	Channel	Frequency (MHz)
0	2402	40	2442
1	2403	41	2443
...
...
..	...	78	2480
39	2441	/	/

Per section 15.31(m), the below frequencies were performed the test as below:

Test Channel	Frequency (MHz)
Lowest	2402
Middle	2441
Highest	2480

Antenna Information Detail▲:

Antenna Manufacturer	Antenna Type	input impedance (Ohm)	Frequency Range	Antenna Gain
Shenzhen DOOGEE Hengtong Technology CO.,LTD	FPC	50	2.4~2.5GHz	1.23 dBi

The Method of §15.203 Compliance:

- Antenna must be permanently attached to the unit.
- Antenna must use a unique type of connector to attach to the EUT.
- Unit must be professionally installed, and installer shall be responsible for verifying that the correct antenna is employed with the unit.

Accessory Information:

Accessory Description	Manufacturer	Model	Parameters
Adapter	Shenzhen Flypower Technology Co., Ltd.	PS10UA050K2000UU	Input: 100-240V~50/60Hz 0.35A Output: 5.0V 2A

1.2 Description of Test Configuration

1.2.1 EUT Operation Condition:

EUT Operation Mode:	The system was configured for testing in Engineering Mode, which was provided by the manufacturer.		
Equipment Modifications:	No		
EUT Exercise Software:	Engineering mode		
The software was provided by manufacturer. The maximum power was configured as below, that was provided by the manufacturer ▲ :			
Test Modes	Power Level Setting		
	Lowest	Middle	Highest
GFSK	Default	Default	Default
$\pi/4$ -DQPSK	Default	Default	Default
8DPSK	Default	Default	Default

1.2.2 Support Equipment List and Details

Manufacturer	Description	Model	Serial Number
Unknown	Earphone	Unknown	Earphone 01

1.2.3 Support Cable List and Details

Cable Description	Shielding Type	Ferrite Core	Length (m)	From Port	To
USB Cable	Yes	No	1.2	Adapter	EUT
Earphone Cable	No	No	1.2	EUT	Earphone

1.2.4 Block Diagram of Test Setup

AC line conducted emissions:

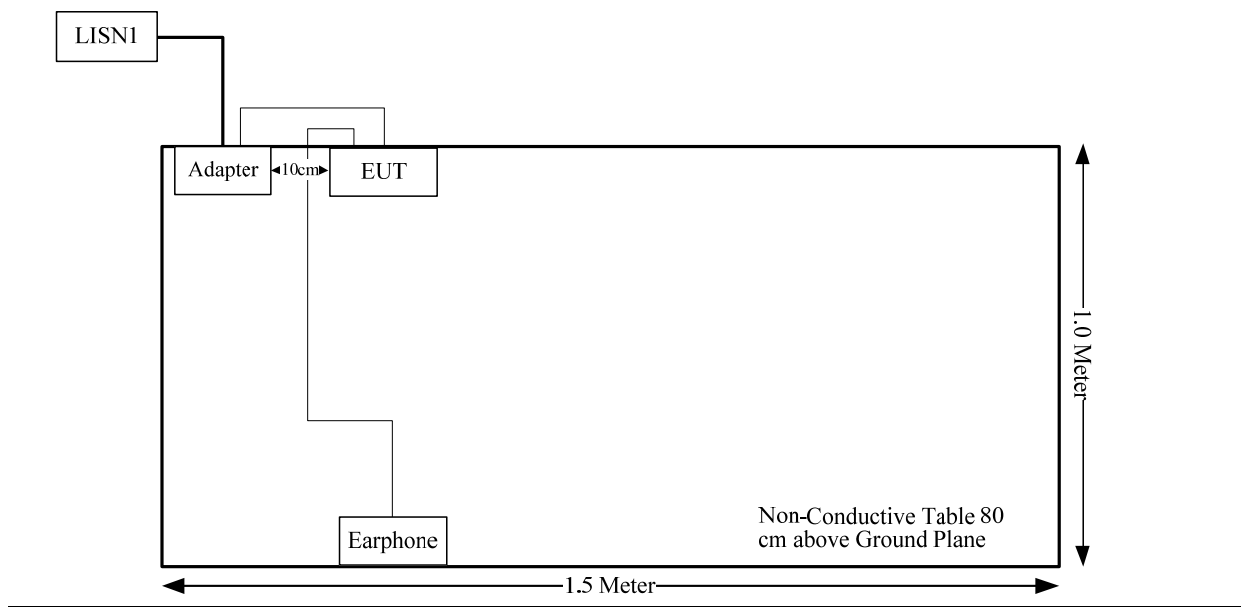

Spurious Emissions:
Below 1GHz:

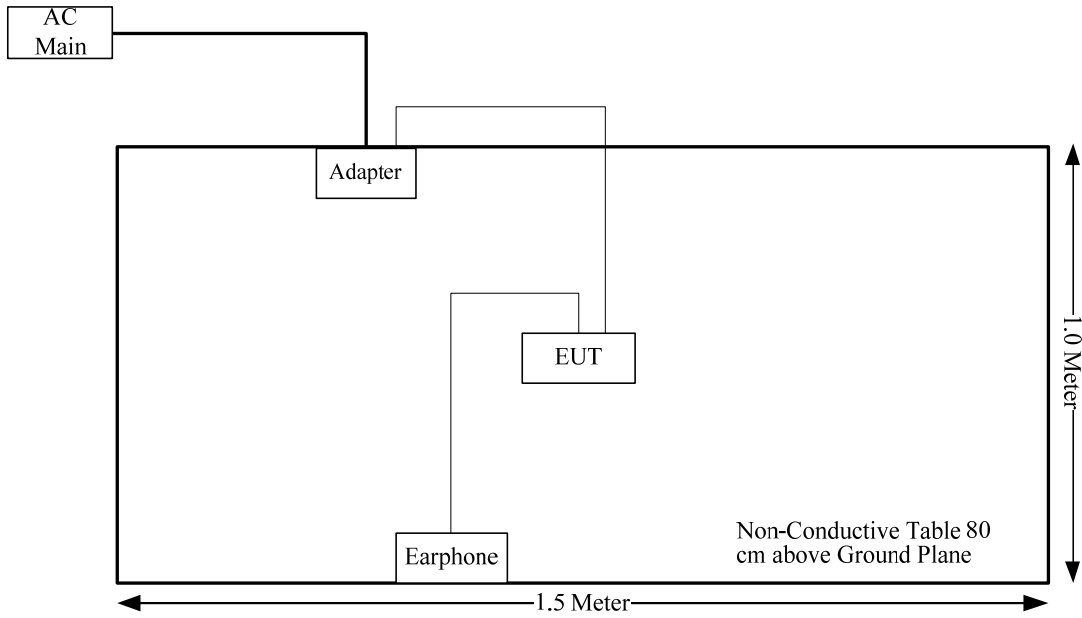

Above 1GHz:

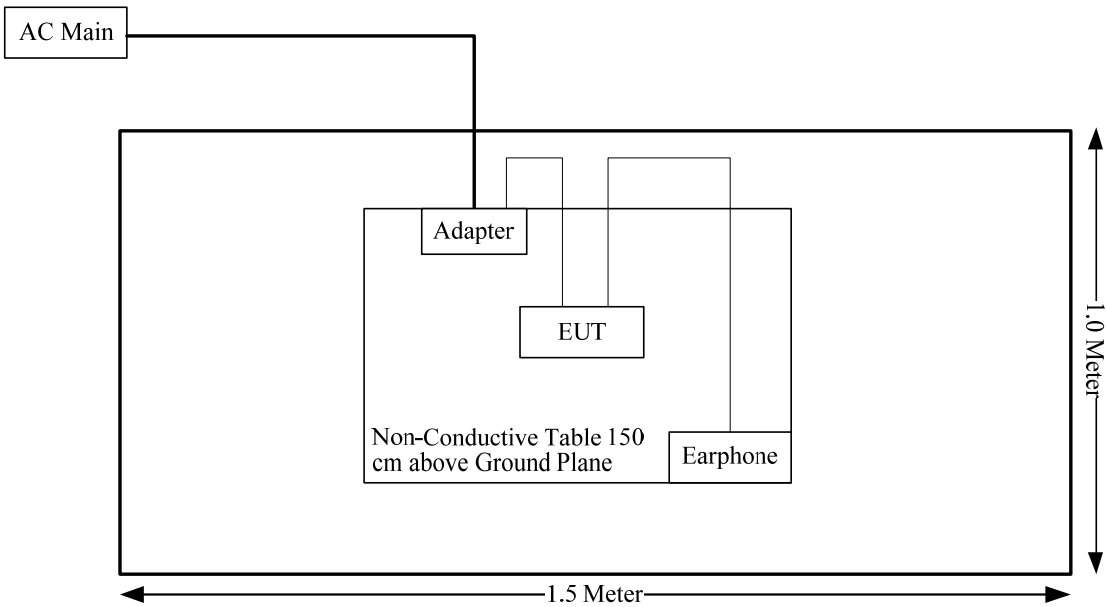

1.3 Measurement Uncertainty

Otherwise required by the applicant or Product Regulations, Decision Rule in this report did not consider the uncertainty. The extended uncertainty given in this report is obtained by combining the standard uncertainty times the coverage factor K with the 95% confidence interval.

Parameter	Measurement Uncertainty
Occupied Channel Bandwidth	±5 %
RF output power, conducted	±0.61dB
Power Spectral Density, conducted	±0.61 dB
Unwanted Emissions, radiated	30M~200MHz: 4.15 dB,200M~1GHz: 5.61 dB,1G~6GHz: 5.14 dB, 6G~18GHz: 5.93 dB,18G~26.5G:5.47 dB,26.5G~40G:5.63 dB
Unwanted Emissions, conducted	±1.26 dB
Temperature	±1 °C
Humidity	±5%
DC and low frequency voltages	±0.4%
Duty Cycle	1%
AC Power Lines Conducted Emission	2.8 dB (150 kHz to 30 MHz)

2. SUMMARY OF TEST RESULTS

FCC Rules	Description of Test	Result
FCC §15.207(a)	AC line conducted emissions	Compliant
FCC §15.205, §15.209, §15.247(d)	Radiated Spurious emissions	Compliant
FCC §15.247(a)(1)	20 dB bandwidth	Compliant
FCC §15.247(a)(1)	Channel separation	Compliant
FCC §15.247(a)(1)(iii)	Number of hopping Frequency	Compliant
FCC §15.247(a)(1)(iii)	Time of occupancy (dwell time)	Compliant
FCC §15.247(b)(1)	Peak output power measurement	Compliant
FCC §15.247(d)	Band edges	Compliant
FCC §15.203	Antenna requirement	Compliant
§15.247 (i) & §1.1307 & §2.1093	RF Exposure Evaluation	Compliant

3. REQUIREMENTS AND TEST PROCEDURES

3.1 AC Line Conducted Emissions

3.1.1 Applicable Standard

FCC§15.207(a).

(a) Except as shown in paragraphs (b) and (c) of this section, for an intentional radiator that is designed to be connected to the public utility (AC) power line, the radio frequency voltage that is conducted back onto the AC power line on any frequency or frequencies, within the band 150 kHz to 30 MHz, shall not exceed the limits in the following table, as measured using a 50 μ H/50 ohms line impedance stabilization network (LISN). Compliance with the provisions of this paragraph shall be based on the measurement of the radio frequency voltage between each power line and ground at the power terminal. The lower limit applies at the boundary between the frequency ranges.

Frequency of emission (MHz)	Conducted limit (dB μ V)	
	Quasi-peak	Average
0.15-0.5	66 to 56*	56 to 46*
0.5-5	56	46
5-30	60	50

*Decreases with the logarithm of the frequency.

(b) The limit shown in paragraph (a) of this section shall not apply to carrier current systems operating as intentional radiators on frequencies below 30 MHz. In lieu thereof, these carrier current systems shall be subject to the following standards:

(1) For carrier current system containing their fundamental emission within the frequency band 535-1705 kHz and intended to be received using a standard AM broadcast receiver: no limit on conducted emissions.

(2) For all other carrier current systems: 1000 μ V within the frequency band 535-1705 kHz, as measured using a 50 μ H/50 ohms LISN.

(3) Carrier current systems operating below 30 MHz are also subject to the radiated emission limits in §15.205, §15.209, §15.221, §15.223, or §15.227, as appropriate.

(c) Measurements to demonstrate compliance with the conducted limits are not required for devices which only employ battery power for operation and which do not operate from the AC power lines or contain provisions for operation while connected to the AC power lines. Devices that include, or make provisions for, the use of battery chargers which permit operating while charging, AC adapters or battery eliminators or that connect to the AC power lines indirectly, obtaining their power through another device which is connected to the AC power lines, shall be tested to demonstrate compliance with the conducted limits.

3.1.2 EUT Setup



- Note: 1. Support units were connected to second LISN.
 2. Both of LISNs (AMN) 80 cm from EUT and at the least 80 cm from other units and other metal planes support units.

The setup of EUT is according with per ANSI C63.10-2013 measurement procedure. The specification used was with the FCC Part 15.207 limits.

The spacing between the peripherals was 10 cm.

The adapter or EUT was connected to the main LISN with a 120 V/60 Hz AC power source.

3.1.3 EMI Test Receiver Setup

The EMI test receiver was set to investigate the spectrum from 150 kHz to 30 MHz.

During the conducted emission test, the EMI test receiver was set with the following configurations:

Frequency Range	IF B/W
150 kHz – 30 MHz	9 kHz

3.1.4 Test Procedure

The frequency and amplitude of the six highest ac power-line conducted emissions relative to the limit, measured over all the current-carrying conductors of the EUT power cords, and the operating frequency or frequency to which the EUT is tuned (if appropriate), should be reported, unless such emissions are more than 20 dB below the limit. AC power-line conducted emissions measurements are to be separately carried out only on each of the phase (“hot”) line(s) and (if used) on the neutral line(s), but not on the ground [protective earth] line(s). If less than six emission frequencies are within 20 dB of the limit, then the noise level of the measuring instrument at representative frequencies should be reported. The specific conductor of the power-line cord for each of the reported emissions should be identified. Measure the six highest emissions with respect to the limit on each current-carrying conductor of each power cord associated with the EUT (but not the power cords of associated or peripheral equipment that are part of the test configuration). Then, report the six highest emissions with respect to the limit from among all the measurements identifying the frequency and specific current-carrying conductor identified with the emission. The six highest emissions should be reported for each of the current-carrying conductors, or the six highest emissions may be reported over all the current-carrying conductors.

3.1.5 Corrected Amplitude & Margin Calculation

The basic equation is as follows:

Result = Reading + Factor

Factor = attenuation caused by cable loss + voltage division factor of AMN

The “**Margin**” column of the following data tables indicates the degree of compliance within the applicable limit. The equation for margin calculation is as follows:

Margin = Limit – Result

3.2 Radiation Spurious Emissions

3.2.1 Applicable Standard

FCC §15.247 (d);

In any 100 kHz bandwidth outside the frequency band in which the spread spectrum or digitally modulated intentional radiator is operating, the radio frequency power that is produced by the intentional radiator shall be at least 20 dB below that in the 100 kHz bandwidth within the band that contains the highest level of the desired power, based on either an RF conducted or a radiated measurement, provided the transmitter demonstrates compliance with the peak conducted power limits. If the transmitter complies with the conducted power limits based on the use of RMS averaging over a time interval, as permitted under paragraph (b)(3) of this section, the attenuation required under this paragraph shall be 30 dB instead of 20 dB. Attenuation below the general limits specified in §15.209(a) is not required. In addition, radiated emissions which fall in the restricted bands, as defined in §15.205(a), must also comply with the radiated emission limits specified in §15.209(a) (see §15.205(c)).

3.2.2 EUT Setup

Below 1GHz:



Above 1GHz:



The radiated emissions were performed in the 3 meters distance, using the setup accordance with the ANSI C63.10-2013. The specification used was the FCC 15.209, and FCC 15.247 limits.

The external I/O cables were draped along the test table and formed a bundle 30 to 40 cm long in the middle.

The spacing between the peripherals was 10 cm.

3.2.3 EMI Test Receiver & Spectrum Analyzer Setup

During the radiated emission test, the EMI test receiver & Spectrum Analyzer Setup were set with the following configurations:

Frequency Range	RBW	Video B/W	IF B/W	Measurement
30 MHz – 1000 MHz	120 kHz	300 kHz	120 kHz	QP
Above 1 GHz	1MHz	3 MHz	/	PK
	1MHz	10 Hz	/	AV

If the maximized peak measured value complies with under the QP/Average limit more than 6dB, then it is unnecessary to perform an QP/Average measurement.

3.2.4 Test Procedure

Maximizing procedure was performed on the highest emissions to ensure that the EUT complied with all installation combinations.

Data was recorded in Quasi-peak detection mode for frequency range of 30 MHz-1 GHz, peak and Average detection modes for frequencies above 1 GHz.

3.2.5 Corrected Amplitude & Margin Calculation

The basic equation is as follows:

Result = Reading + Factor

Factor = Antenna Factor + Cable Loss- Amplifier Gain

The “**Margin**” column of the following data tables indicates the degree of compliance within the applicable limit. The equation for margin calculation is as follows:

Margin = Limit – Result

3.3 20 dB Bandwidth

3.3.1 Applicable Standard

FCC §15.247 (a)(1)

Frequency hopping systems shall have hopping channel carrier frequencies separated by a minimum of 25 kHz or the 20 dB bandwidth of the hopping channel, whichever is greater. Alternatively, frequency hopping systems operating in the 2400-2483.5 MHz band may have hopping channel carrier frequencies that are separated by 25 kHz or two-thirds of the 20 dB bandwidth of the hopping channel, whichever is greater, provided the systems operate with an output power no greater than 125 mW. The system shall hop to channel frequencies that are selected at the system hopping rate from a pseudo randomly ordered list of hopping frequencies. Each frequency must be used equally on the average by each transmitter. The system receivers shall have input bandwidths that match the hopping channel bandwidths of their corresponding transmitters and shall shift frequencies in synchronization with the transmitted signals.

3.3.2 EUT Setup

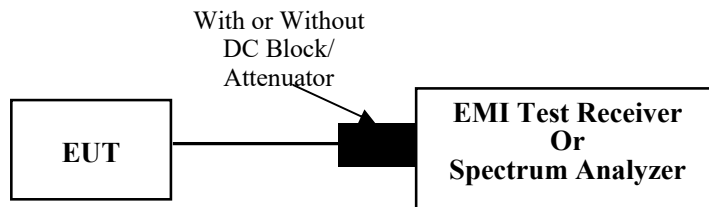

3.3.3 Test Procedure

1. Check the calibration of the measuring instrument using either an internal calibrator or a known signal from an external generator.
2. Position the EUT on the test table without connection to measurement instrument. Turn on the EUT. Then set it to any one convenient frequency within its operating range. Set a reference level on the measuring instrument equal to the highest peak value.
3. Measure the frequency difference of two frequencies that were attenuated 20 dB from the reference level. Record the frequency difference as the emission bandwidth.
4. Repeat above procedures until all frequencies measured were complete.

3.4 Channel Separation

3.4.1 Applicable Standard

FCC §15.247 (a)(1)

Frequency hopping systems shall have hopping channel carrier frequencies separated by a minimum of 25 kHz or the 20 dB bandwidth of the hopping channel, whichever is greater. Alternatively, frequency hopping systems operating in the 2400-2483.5 MHz band may have hopping channel carrier frequencies that are separated by 25 kHz or two-thirds of the 20 dB bandwidth of the hopping channel, whichever is greater, provided the systems operate with an output power no greater than 125 mW. The system shall hop to channel frequencies that are selected at the system hopping rate from a pseudo randomly ordered list of hopping frequencies. Each frequency must be used equally on the average by each transmitter. The system receivers shall have input bandwidths that match the hopping channel bandwidths of their corresponding transmitters and shall shift frequencies in synchronization with the transmitted signals.

3.4.2 EUT Setup

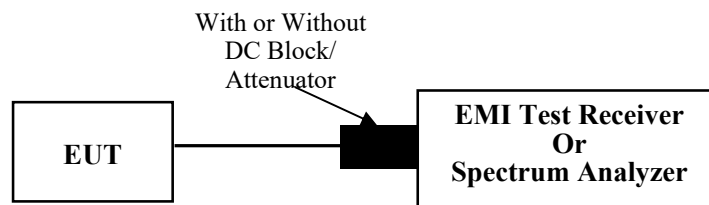

3.4.3 Test Procedure

According to ANSI C63.10-2013 Section 7.8.2

The EUT shall have its hopping function enabled. Use the following spectrum analyzer settings:

- a) Span: Wide enough to capture the peaks of two adjacent channels.
- b) RBW: Start with the RBW set to approximately 30% of the channel spacing; adjust as necessary to best identify the center of each individual channel.
- c) Video (or average) bandwidth (VBW) \geq RBW.
- d) Sweep: Auto.
- e) Detector function: Peak.
- f) Trace: Max hold.
- g) Allow the trace to stabilize.

Use the marker-delta function to determine the separation between the peaks of the adjacent channels. Compliance of an EUT with the appropriate regulatory limit shall be determined. A plot of the data shall be included in the test report.

3.5 Number Of Hopping Frequency

3.5.1 Applicable Standard

FCC §15.247 (a)(1)(iii)

Frequency hopping systems in the 2400–2483.5 MHz band shall use at least 15 channels. The average time of occupancy on any channel shall not be greater than 0.4 seconds within a period of 0.4 seconds multiplied by the number of hopping channels employed. Frequency hopping systems may avoid or suppress transmissions on a particular hopping frequency provided that a minimum of 15 channels are used.

3.5.2 EUT Setup

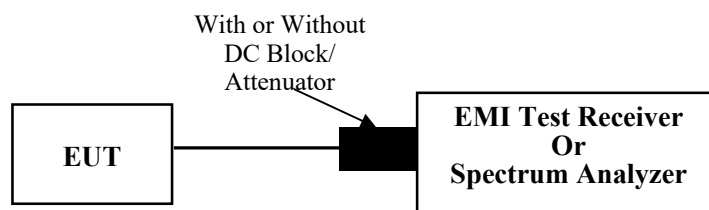

3.5.3 Test Procedure

According to ANSI C63.10-2013 Section 7.8.3

The EUT shall have its hopping function enabled. Use the following spectrum analyzer settings:

- a) Span: The frequency band of operation. Depending on the number of channels the device supports, it may be necessary to divide the frequency range of operation across multiple spans, to allow the individual channels to be clearly seen.
- b) RBW: To identify clearly the individual channels, set the RBW to less than 30% of the channel spacing or the 20 dB bandwidth, whichever is smaller.
- c) VBW \geq RBW.
- d) Sweep: Auto.
- e) Detector function: Peak.
- f) Trace: Max hold.
- g) Allow the trace to stabilize

It might prove necessary to break the span up into subranges to show clearly all of the hopping frequencies. Compliance of an EUT with the appropriate regulatory limit shall be determined for the number of hopping channels. A plot of the data shall be included in the test report.

3.6 Time Of Occupancy(Dwell Time)

3.6.1 Applicable Standard

Frequency hopping systems in the 2400-2483.5 MHz shall use at least 15 channels. The average time of occupancy on any channel shall not be greater than 0.4 seconds within a period of 0.4 seconds multiplied by the number of hopping channels employed. Frequency hopping systems may avoid or suppress transmissions on a particular hopping frequency provided that a minimum of 15 channels are used.

3.6.2 EUT Setup

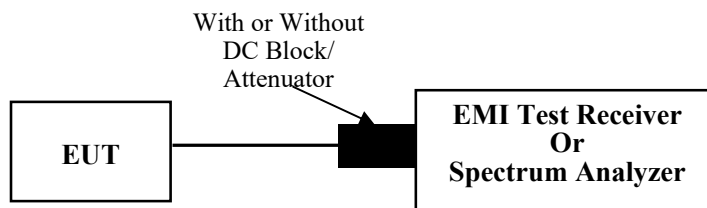

3.6.3 Test Procedure

The EUT was worked in channel hopping; the time of single pulses was tested.

3.7 Peak Output Power

3.7.1 Applicable Standard

FCC §15.247 (b)(1)

For frequency hopping systems operating in the 2400–2483.5 MHz band employing at least 75 non-overlapping hopping channels, and all frequency hopping systems in the 5725-5850 MHz band: 1 watt. For all other frequency hopping systems in the 2400–2483.5 MHz band: 0.125 watts

3.7.2 EUT Setup

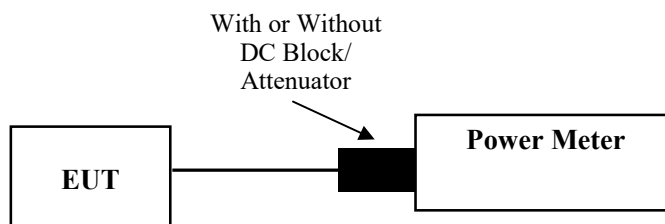

3.7.3 Test Procedure

1. Remove the antenna from the EUT and then connect a low loss RF cable from the antenna port to one test equipment.
2. Add a correction factor to the display.

3.8 100 kHz Bandwidth of Frequency Band Edge

3.8.1 Applicable Standard

FCC §15.247 (d);

In any 100 kHz bandwidth outside the frequency band in which the spread spectrum or digitally modulated intentional radiator is operating, the radio frequency power that is produced by the intentional radiator shall be at least 20 dB below that in the 100 kHz bandwidth within the band that contains the highest level of the desired power, based on either an RF conducted or a radiated measurement, provided the transmitter demonstrates compliance with the peak conducted power limits. If the transmitter complies with the conducted power limits based on the use of RMS averaging over a time interval, as permitted under paragraph (b)(3) of this section, the attenuation required under this paragraph shall be 30 dB instead of 20 dB. Attenuation below the general limits specified in §15.209(a) is not required. In addition, radiated emissions which fall in the restricted bands, as defined in §15.205(a), must also comply with the radiated emission limits specified in §15.209(a) (see §15.205(c)).

3.8.2 EUT Setup

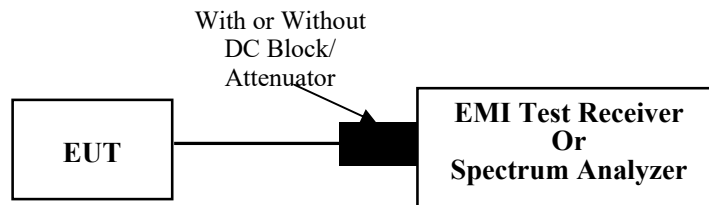

3.8.3 Test Procedure

- a) Set the center frequency and span to encompass frequency range to be measured.
- b) Set the RBW = 100 kHz.
- c) Set the VBW $\geq [3 \times \text{RBW}]$.
- d) Detector = peak.
- e) Sweep time = auto couple.
- f) Trace mode = max hold.
- g) Allow trace to fully stabilize.
- h) Use the peak marker function to determine the maximum amplitude level.

Ensure that the amplitude of all unwanted emissions outside of the authorized frequency band (excluding restricted frequency bands) is attenuated by at least the minimum requirements specified in 11.11. Report the three highest emissions relative to the limit.

3.9 Antenna Requirement

3.9.1 Applicable Standard

FCC §15.203

An intentional radiator shall be designed to ensure that no antenna other than that furnished by the responsible party shall be used with the device. The use of a permanently attached antenna or of an antenna that uses a unique coupling to the intentional radiator shall be considered sufficient to comply with the provisions of this section. The manufacturer may design the unit so that a broken antenna can be replaced by the user, but the use of a standard antenna jack or electrical connector is prohibited. This requirement does not apply to carrier current devices or to devices operated under the provisions of §§15.211, 15.213, 15.217, 15.219, 15.221, or §15.236. Further, this requirement does not apply to intentional radiators that must be professionally installed, such as perimeter protection systems and some field disturbance sensors, or to other intentional radiators which, in accordance with §15.31(d), must be measured at the installation site. However, the installer shall be responsible for ensuring that the proper antenna is employed so that the limits in this part are not exceeded.

3.9.2 Judgment

Compliant. Please refer to the Antenna Information detail in Section 1.

4. TEST DATA AND RESULTS

4.1 AC Line Conducted Emissions

Serial Number:	CR22090006-RF-S1	Test Date:	2022-09-13
Test Site:	CE	Test Mode:	Transmitting
Tester:	Vic Du	Test Result:	Pass

Environmental Conditions:					
Temperature: (°C)	27.6	Relative Humidity: (%)	68	ATM Pressure: (kPa)	100.2

Test Equipment List and Details:

Manufacturer	Description	Model	Serial Number	Calibration Date	Calibration Due Date
R&S	LISN	ENV216	101134	2022-04-01	2023-03-31
R&S	EMI Test Receiver	ESR3	102726	2022-07-15	2023-07-14
MICRO-COAX	Coaxial Cable	UTIFLEX	C-0200-01	2022-08-07	2023-08-06
Audix	Test Software	E3	190306 (V9)	N/A	N/A

* Statement of Traceability: China Certification ICT Co., Ltd (Dongguan) attests that all calibrations have been performed, traceable to National Primary Standards and International System of Units (SI).

Line:

Test Mode: transmitting
 Power Source: AC 120V/60Hz
 Port: Line
 Note:

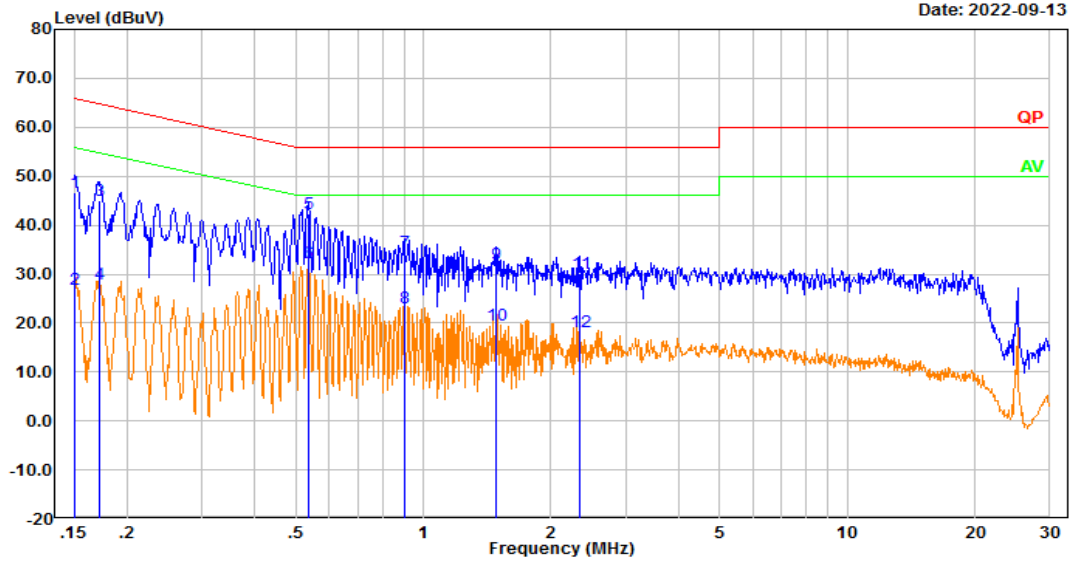

Date: 2022-09-13

No.	Frequency (MHz)	Reading (dBμV)	Factor (dB)	Result (dBμV)	Limit (dBμV)	Margin (dBμV)	Detector
1	0.150	36.93	9.61	46.54	66.00	19.46	QP
2	0.150	17.40	9.61	27.01	56.00	28.99	Average
3	0.172	35.51	9.61	45.12	64.87	19.75	QP
4	0.172	18.28	9.61	27.89	54.87	26.98	Average
5	0.537	32.84	9.61	42.45	56.00	13.55	QP
6	0.537	22.74	9.61	32.35	46.00	13.65	Average
7	0.904	24.95	9.62	34.57	56.00	21.43	QP
8	0.904	13.41	9.62	23.03	46.00	22.97	Average
9	1.485	22.30	9.62	31.92	56.00	24.08	QP
10	1.485	10.06	9.62	19.68	46.00	26.32	Average
11	2.342	20.55	9.64	30.19	56.00	25.81	QP
12	2.342	8.58	9.64	18.22	46.00	27.78	Average

Neutral:

Test Mode: transmitting
 Power Source: AC 120V/60Hz
 Port: neutral
 Note:

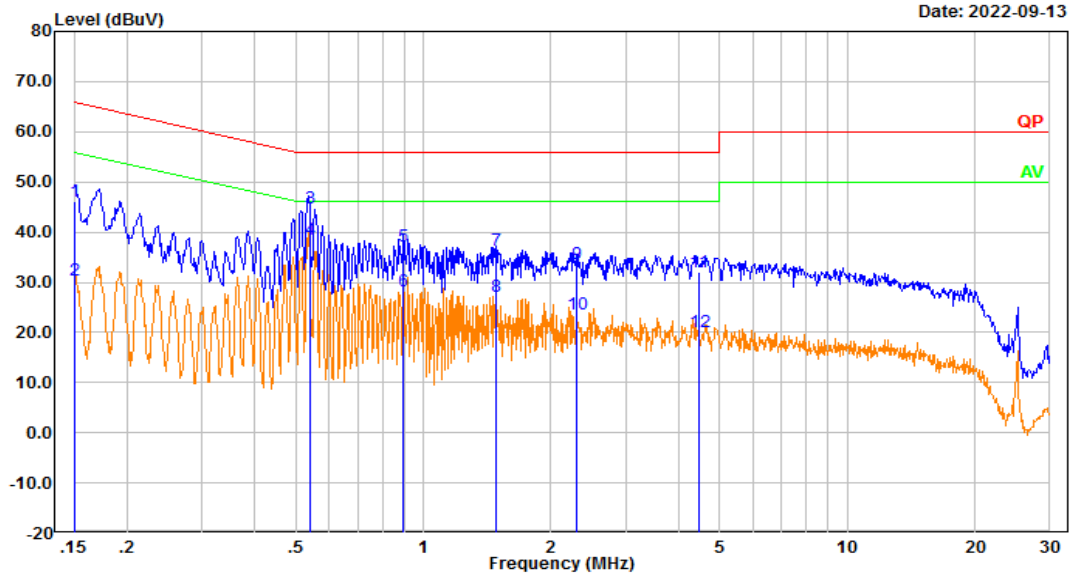

No.	Frequency (MHz)	Reading (dBμV)	Factor (dB)	Result (dBμV)	Limit (dBμV)	Margin (dBμV)	Detector
1	0.150	36.39	9.61	46.00	65.99	19.99	QP
2	0.150	20.78	9.61	30.39	55.99	25.60	Average
3	0.539	35.29	9.61	44.90	56.00	11.10	QP
4	0.539	29.03	9.61	38.64	46.00	7.36	Average
5	0.898	27.70	9.62	37.32	56.00	18.68	QP
6	0.898	18.56	9.62	28.18	46.00	17.82	Average
7	1.478	26.65	9.62	36.27	56.00	19.73	QP
8	1.478	17.64	9.62	27.26	46.00	18.74	Average
9	2.293	24.10	9.64	33.74	56.00	22.26	QP
10	2.293	14.11	9.64	23.75	46.00	22.25	Average
11	4.461	22.44	9.65	32.09	56.00	23.91	QP
12	4.461	10.33	9.65	19.98	46.00	26.02	Average

4.2 Radiation Spurious Emissions

Serial Number:	CR22090006-RF-S1	Test Date:	2022-09-08~2022-09-09
Test Site:	966-1/966-2	Test Mode:	Transmitting
Tester:	Carl Xue, Nick Tang	Test Result:	Pass

Environmental Conditions:

Temperature: (°C)	26.7~27.4	Relative Humidity: (%)	49~53	ATM Pressure: (kPa)	100.2~100.4
----------------------	-----------	---------------------------	-------	------------------------	-------------

Test Equipment List and Details:

Manufacturer	Description	Model	Serial Number	Calibration Date	Calibration Due Date
Sunol Sciences	Antenna	JB6	A082520-5	2020-10-19	2023-10-18
R&S	EMI Test Receiver	ESR3	102724	2022-07-15	2023-07-14
TIMES MICROWAVE	Coaxial Cable	LMR-600-UltraFlex	C-0470-02	2022-07-17	2023-07-16
TIMES MICROWAVE	Coaxial Cable	LMR-600-UltraFlex	C-0780-01	2022-07-17	2023-07-16
Sonoma	Amplifier	310N	186165	2022-07-17	2023-07-16
ETS-Lindgren	Horn Antenna	3115	9912-5985	2020-10-13	2023-10-12
R&S	Spectrum Analyzer	FSV40	101591	2022-07-15	2023-07-14
MICRO-COAX	Coaxial Cable	UFA210A-1-1200-70U300	217423-008	2022-08-07	2023-08-06
MICRO-COAX	Coaxial Cable	UFA210A-1-2362-300300	235780-001	2022-08-07	2023-08-06
Mini	Pre-amplifier	ZVA-183-S+	5969001149	2021-11-10	2022-11-09
Audix	Test Software	E3	201021 (V9)	N/A	N/A
PASTERNAK	Horn Antenna	PE9852/2F-20	112002	2021-02-05	2024-02-04
AH	Preamplifier	PAM-1840VH	190	2021-11-19	2022-11-18
MICRO-COAX	Coaxial Cable	UFB142A-1-2362-200200	235772-001	2022-08-07	2023-08-06
E-Microwave	Band Rejection Filter	2400-2483.5MHz	OE01902424	2022-08-07	2023-08-06
Mini Circuits	High Pass Filter	VHF-6010+	31119	2022-08-07	2023-08-06

* Statement of Traceability: China Certification ICT Co., Ltd (Dongguan) attests that all calibrations have been performed, traceable to National Primary Standards and International System of Units (SI).

Test Data:

Please refer to the below table and plots.

Note: The device can be mounted in multiple orientations, test was performed with X,Y, Z Axis according to C63.10 Figure 8, the worst orientation was photographed and it's data was recorded.

**1) 30MHz-1GHz(BDR Low channel was the worst)
Horizontal:**

Test Mode: transmitting
 Power Source: AC 120V/60Hz
 Polarization: horizontal
 Note:

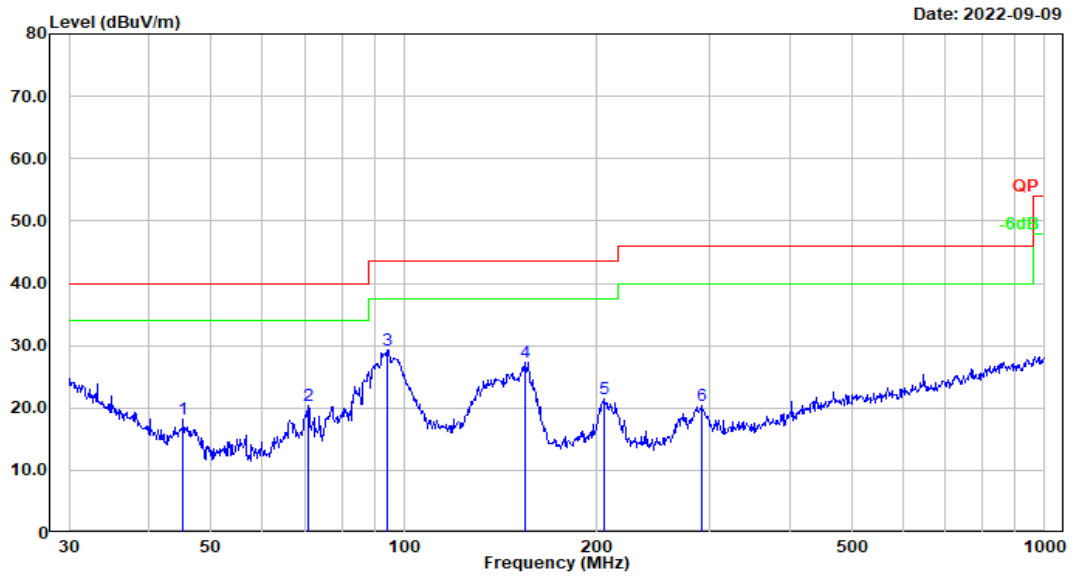

No.	Frequency (MHz)	Reading (dBμV)	Factor (dB/m)	Result (dBμV/m)	Limit (dBμV/m)	Margin (dB)	Detector
1	45.217	32.63	-14.36	18.27	40.00	21.73	Peak
2	70.832	36.91	-16.55	20.36	40.00	19.64	Peak
3	94.098	45.28	-15.90	29.38	43.50	14.12	Peak
4	154.279	39.30	-12.03	27.27	43.50	16.23	Peak
5	205.675	33.85	-12.37	21.48	43.50	22.02	Peak
6	291.036	31.40	-10.99	20.41	46.00	25.59	Peak

Vertical:

Test Mode: transmitting
 Power Source: AC 120V/60Hz
 Polarization: vertical
 Note:

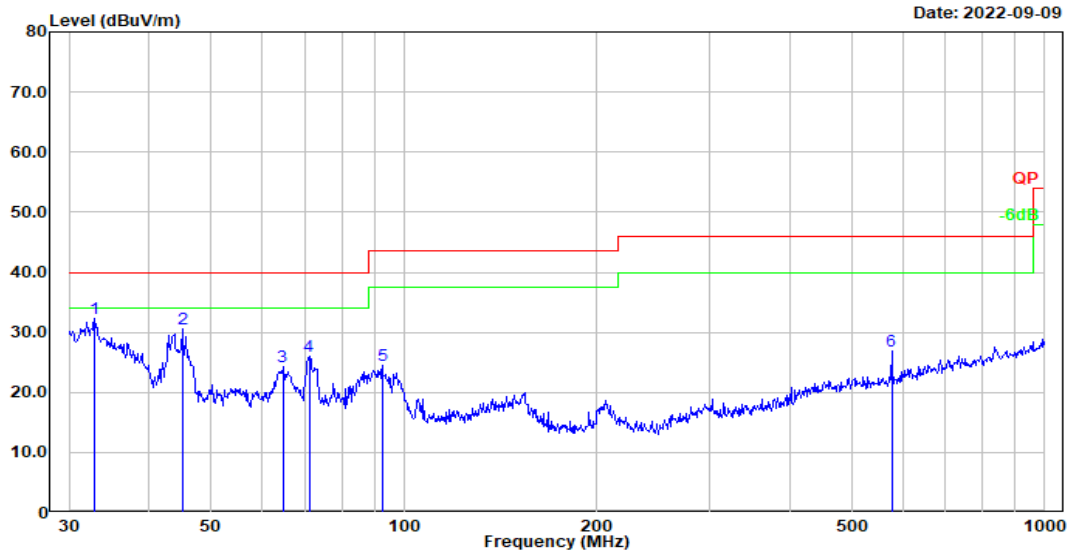

No.	Frequency (MHz)	Reading (dB μ V)	Factor (dB/m)	Result (dB μ V/m)	Limit (dB μ V/m)	Margin (dB)	Detector
1	32.864	38.15	-5.81	32.34	40.00	7.66	Peak
2	45.058	44.81	-14.25	30.56	40.00	9.44	Peak
3	64.659	41.28	-16.96	24.32	40.00	15.68	Peak
4	71.080	42.64	-16.59	26.05	40.00	13.95	Peak
5	92.462	40.83	-16.32	24.51	43.50	18.99	Peak
6	576.644	32.53	-5.58	26.95	46.00	19.05	Peak

2) 1-25GHz:*BDR Mode(GFSK) was the worst:*

Frequency (MHz)	Receiver		Polar (H/V)	Factor (dB/m)	Result (dB μ V/m)	Limit (dB μ V/m)	Margin (dB)
	Reading (dB μ V)	Detector					
Low Channel: 2402 MHz							
2390.00	26.99	PK	V	31.46	58.45	74.00	15.55
2390.00	13.59	AV	V	31.46	45.05	54.00	8.95
4804.00	36.44	PK	V	10.91	47.35	74.00	26.65
4804.00	22.07	AV	V	10.91	32.98	54.00	21.02
7206.00	36.31	PK	V	14.22	50.53	74.00	23.47
7206.00	23.25	AV	V	14.22	37.47	54.00	16.53
Middle Channel: 2441 MHz							
4882.00	36.76	PK	V	11.07	47.83	74.00	26.17
4882.00	22.39	AV	V	11.07	33.46	54.00	20.54
7323.00	35.84	PK	V	14.80	50.64	74.00	23.36
7323.00	22.72	AV	V	14.80	37.52	54.00	16.48
High Channel: 2480 MHz							
2483.50	27.31	PK	V	31.64	58.95	74.00	15.05
2483.50	13.87	AV	V	31.64	45.51	54.00	8.49
4960.00	36.48	PK	V	11.23	47.71	74.00	26.29
4960.00	22.11	AV	V	11.23	33.34	54.00	20.66
7440.00	35.23	PK	V	15.26	50.49	74.00	23.51
7440.00	22.17	AV	V	15.26	37.43	54.00	16.57

Worst Test plots(BDR Middle channel was the worst)

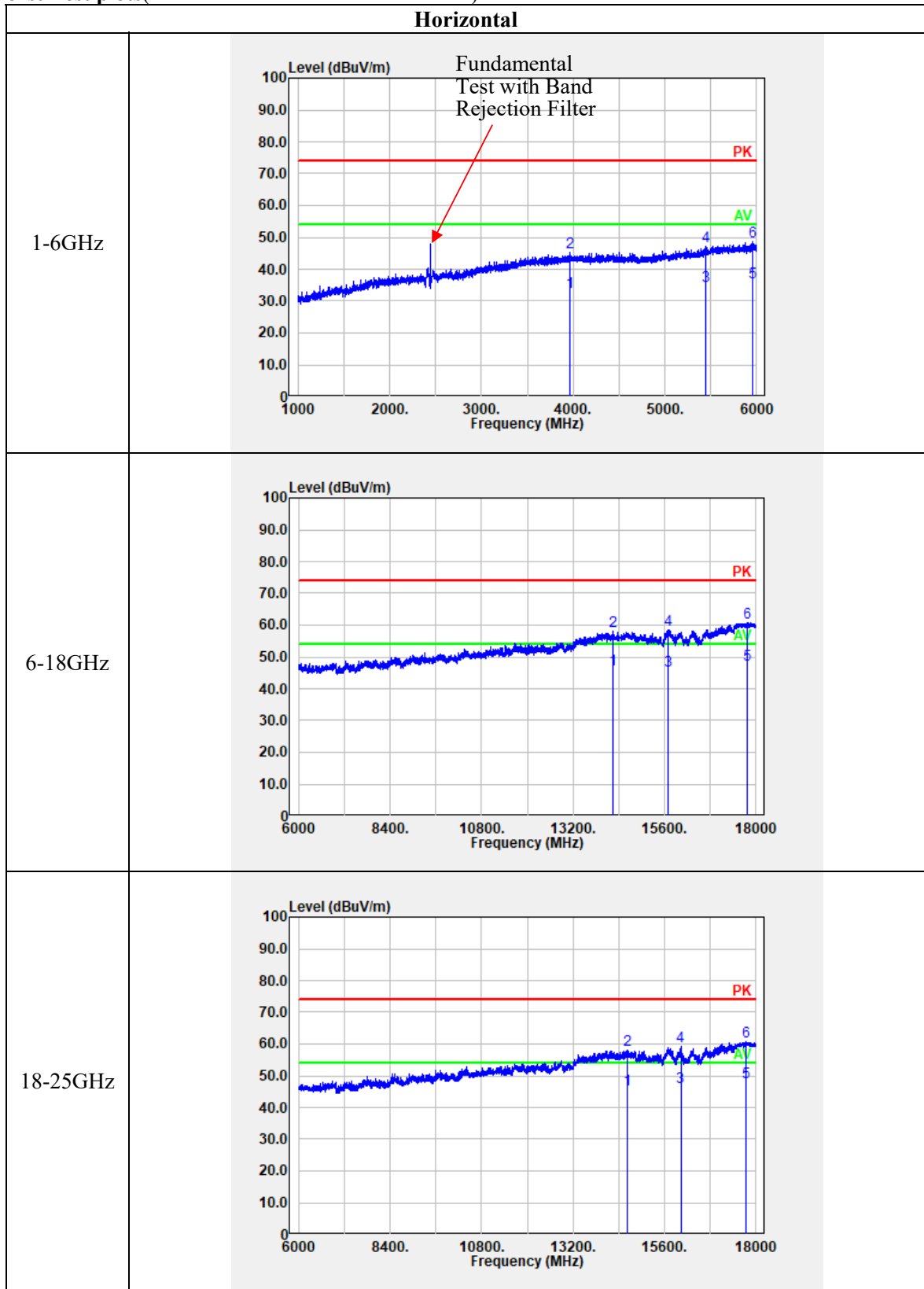

Vertical

<p>1-6GHz</p>	
<p>6-18GHz</p>	
<p>18-25GHz</p>	

4.3 20 dB Emission Bandwidth:

Serial Number:	CR22090006-RF-S1	Test Date:	2022/9/8
Test Site:	RF	Test Mode:	Transmitting
Tester:	Morpheus Shi	Test Result:	N/A

Environmental Conditions:

Temperature: (°C)	26.8	Relative Humidity: (%)	65	ATM Pressure: (kPa)	100.8
----------------------	------	------------------------------	----	------------------------	-------

Test Equipment List and Details:

Manufacturer	Description	Model	Serial Number	Calibration Date	Calibration Due Date
R&S	Spectrum Analyzer	FSU26	200256	2022-07-15	2023-07-14
zhuoxiang	Coaxial Cable	SMA-178	211001	Each time	N/A
HuiXunDa	DC Block	SMA-JK 18G	DCB181108043	Each time	N/A

* Statement of Traceability: China Certification ICT Co., Ltd (Dongguan) attests that all calibrations have been performed, traceable to National Primary Standards and International System of Units (SI).

Test Data:

Test Modes	Test Channel	Test Frequency (MHz)	20 dB Bandwidth (MHz)
BDR Mode (GFSK)	Lowest	2402	0.772
	Middle	2441	0.772
	Highest	2480	0.772
EDR Mode ($\pi/4$ -DQPSK)	Lowest	2402	1.2
	Middle	2441	1.188
	Highest	2480	1.184
EDR Mode (8DPSK)	Lowest	2402	1.216
	Middle	2441	1.212
	Highest	2480	1.208

BDR Mode (GFSK)

<p>Lowest Channel</p>	<p>Ref 20 dBm *Att 25 dB *RBW 20 kHz Delta 1 [T1] 0.41 dB *VBM 50 kHz 772.00000000 kHz SWT 20 ms</p> <p>Marker 1 [T1] -22.79 dBm 2.40161000 GHz</p> <p>D1 -2.14 dBm D2 -12.14 dBm</p> <p>Center 2.402 GHz 200 kHz/ Span 2 MHz</p> <p>Date: 8.SEP.2022 01:12:58</p>
<p>Middle Channel</p>	<p>Ref 20 dBm *Att 25 dB *RBW 20 kHz Delta 1 [T1] 0.23 dB *VBM 50 kHz 772.00000000 kHz SWT 20 ms</p> <p>Marker 1 [T1] -21.41 dBm 2.44061000 GHz</p> <p>D1 -1.27 dBm D2 -11.27 dBm</p> <p>Center 2.441 GHz 200 kHz/ Span 2 MHz</p> <p>Date: 8.SEP.2022 01:14:07</p>
<p>Highest Channel</p>	<p>Ref 20 dBm *Att 25 dB *RBW 20 kHz Delta 1 [T1] 0.11 dB *VBM 50 kHz 772.00000000 kHz SWT 20 ms</p> <p>Marker 1 [T1] -21.48 dBm 2.47961000 GHz</p> <p>D1 -0.41 dBm D2 -11.41 dBm</p> <p>Center 2.48 GHz 200 kHz/ Span 2 MHz</p> <p>Date: 8.SEP.2022 01:15:01</p>

EDR Mode ($\pi/4$ -DQPSK)

<p>Lowest Channel</p>	<p>Date: 8.SEP.2022 01:16:31</p>
<p>Middle Channel</p>	<p>Date: 8.SEP.2022 01:18:21</p>
<p>Highest Channel</p>	<p>Date: 8.SEP.2022 01:19:19</p>

EDR Mode (8DPSK)

<p>Lowest Channel</p>	<p>Ref 20 dBm *Att 25 dB *RBW 20 kHz Delta 1 [T1] -0.66 dB *VBM 50 kHz 1.216000000 MHz SWF 20 ms</p> <p>Marker 1 [T1] -21.49 dBm 2.401400000 GHz</p> <p>D1 -4.03 dBm D2 -21.49 dBm</p> <p>Center 2.402 GHz 200 kHz/ Span 2 MHz</p> <p>Date: 8.SEP.2022 01:20:32</p>
<p>Middle Channel</p>	<p>Ref 20 dBm *Att 25 dB *RBW 20 kHz Delta 1 [T1] 0.07 dB *VBM 50 kHz 1.212000000 MHz SWF 20 ms</p> <p>Marker 1 [T1] -22.94 dBm 2.440400000 GHz</p> <p>D1 -2.42 dBm D2 -22.94 dBm</p> <p>Center 2.441 GHz 200 kHz/ Span 2 MHz</p> <p>Date: 8.SEP.2022 01:21:38</p>
<p>Highest Channel</p>	<p>Ref 20 dBm *Att 25 dB *RBW 20 kHz Delta 1 [T1] 0.72 dB *VBM 50 kHz 1.208000000 MHz SWF 20 ms</p> <p>Marker 1 [T1] -22.01 dBm 2.479400000 GHz</p> <p>D1 -1.7 dBm D2 -22.01 dBm</p> <p>Center 2.48 GHz 200 kHz/ Span 2 MHz</p> <p>Date: 8.SEP.2022 01:22:30</p>

4.4 Channel Separation:

Serial Number:	CR22090006-RF-S1	Test Date:	2022/9/8
Test Site:	RF	Test Mode:	Transmitting
Tester:	Morpheus Shi	Test Result:	Pass

Environmental Conditions:

Temperature: (°C)	26.8	Relative Humidity: (%)	65	ATM Pressure: (kPa)	100.8
----------------------	------	------------------------------	----	------------------------	-------

Test Equipment List and Details:

Manufacturer	Description	Model	Serial Number	Calibration Date	Calibration Due Date
R&S	Spectrum Analyzer	FSU26	200256	2022/7/15	2023/7/14
zhuoxiang	Coaxial Cable	SMA-178	211001	Each time	N/A
HuiXunDa	DC Block	SMA-JK 18G	DCB181108043	Each time	N/A

* Statement of Traceability: China Certification ICT Co., Ltd (Dongguan) attests that all calibrations have been performed, traceable to National Primary Standards and International System of Units (SI).

Test Data:

Test Modes	Test Frequency (MHz)	Channel Separation (MHz)	Limits (MHz)
BDR Mode (GFSK)	2402	1.002	0.515
	2441	1.002	0.515
	2480	1.002	0.515
EDR Mode ($\pi/4$ -DQPSK)	2402	1.002	0.800
	2441	0.996	0.792
	2480	1.002	0.789
EDR Mode (8DPSK)	2402	1.002	0.811
	2441	0.996	0.808
	2480	1.002	0.805

BDR Mode (GFSK)

<p>Lowest Channel</p>	<p>Date: 8.SEP.2022 01:26:53</p>
<p>Middle Channel</p>	<p>Date: 8.SEP.2022 01:27:47</p>
<p>Highest Channel</p>	<p>Date: 8.SEP.2022 01:28:47</p>

EDR Mode ($\pi/4$ -DQPSK)

<p>Lowest Channel</p>	<p>Ref 20 dBm *Att 25 dB *RBW 30 kHz Delta 1 [T1] 0.03 dB *VBW 100 kHz SWT 15 ms 1.002000000 MHz</p> <p>Marker 1 [T1] -1.44 dBm 2.40183000 GHz</p> <p>Center 2.4025 GHz 300 kHz/ Span 3 MHz</p> <p>Date: 8.SEP.2022 01:29:45</p>
<p>Middle Channel</p>	<p>Ref 20 dBm *Att 25 dB *RBW 30 kHz Delta 1 [T1] 0.06 dB *VBW 100 kHz SWT 15 ms 996.000000000 MHz</p> <p>Marker 1 [T1] -0.39 dBm 2.44084000 GHz</p> <p>Center 2.4415 GHz 300 kHz/ Span 3 MHz</p> <p>Date: 8.SEP.2022 01:30:28</p>
<p>Highest Channel</p>	<p>Ref 20 dBm *Att 25 dB *RBW 30 kHz Delta 1 [T1] 0.06 dB *VBW 100 kHz SWT 15 ms 1.002000000 MHz</p> <p>Marker 1 [T1] 1.26 dBm 2.47883000 GHz</p> <p>Center 2.4795 GHz 300 kHz/ Span 3 MHz</p> <p>Date: 8.SEP.2022 01:31:22</p>

EDR Mode (8DPSK)

<p>Lowest Channel</p>	<p>Ref: 20 dBm *Att: 25 dB *RBW: 30 kHz Delta 1 [T1] 0.03 dB *VBW: 100 kHz 1.002000000 MHz *SWT: 15 ms</p> <p>Center: 2.4025 GHz 300 kHz/ Span: 3 MHz</p> <p>Date: 8.SEP.2022 01:32:15</p>
<p>Middle Channel</p>	<p>Ref: 20 dBm *Att: 25 dB *RBW: 30 kHz Delta 1 [T1] 0.11 dB *VBW: 100 kHz 996.000000000 kHz *SWT: 15 ms</p> <p>Center: 2.4415 GHz 300 kHz/ Span: 3 MHz</p> <p>Date: 8.SEP.2022 01:32:58</p>
<p>Highest Channel</p>	<p>Ref: 20 dBm *Att: 25 dB *RBW: 30 kHz Delta 1 [T1] -0.06 dB *VBW: 100 kHz 1.002000000 MHz *SWT: 15 ms</p> <p>Center: 2.4795 GHz 300 kHz/ Span: 3 MHz</p> <p>Date: 8.SEP.2022 01:33:49</p>

4.5 Number Of Hopping Frequency:

Serial Number:	CR22090006-RF-S1	Test Date:	2022/9/8
Test Site:	RF	Test Mode:	Transmitting
Tester:	Morpheus Shi	Test Result:	Pass

Environmental Conditions:

Temperature: (°C)	26.8	Relative Humidity: (%)	65	ATM Pressure: (kPa)	100.8
----------------------	------	------------------------------	----	------------------------	-------

Test Equipment List and Details:

Manufacturer	Description	Model	Serial Number	Calibration Date	Calibration Due Date
R&S	Spectrum Analyzer	FSU26	200256	2022/7/15	2023/7/14
zhuoxiang	Coaxial Cable	SMA-178	211001	Each time	N/A
HuiXunDa	DC Block	SMA-JK 18G	DCB181108043	Each time	N/A

* Statement of Traceability: China Certification ICT Co., Ltd (Dongguan) attests that all calibrations have been performed, traceable to National Primary Standards and International System of Units (SI).

Test Data:

Test Modes	Frequency Range (MHz)	Number of Hopping Channel	Limits
GFSK	2400-2483.5	79	≥15
$\pi/4$ -DQPSK	2400-2483.5	79	≥15
8DPSK	2400-2483.5	79	≥15

Number of Hopping Channel

**BDR Mode
(GFSK)**

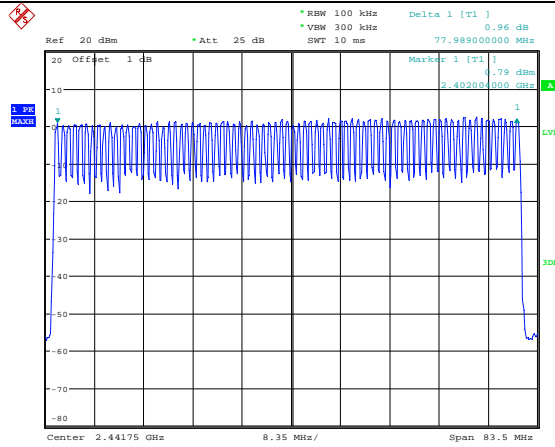

Date: 8.SEP.2022 01:44:04

**EDR Mode
($\pi/4$ -DQPSK)**

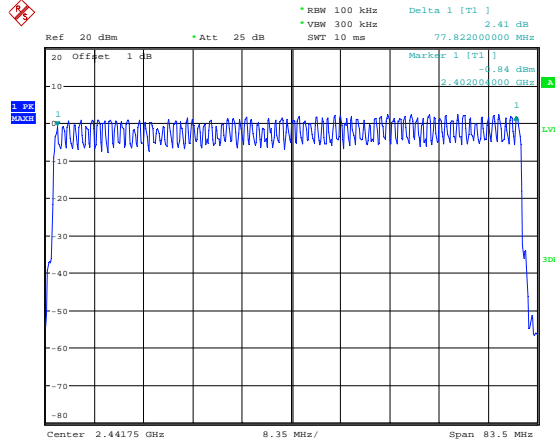

Date: 8.SEP.2022 01:49:33

**EDR Mode
(8DPSK)**

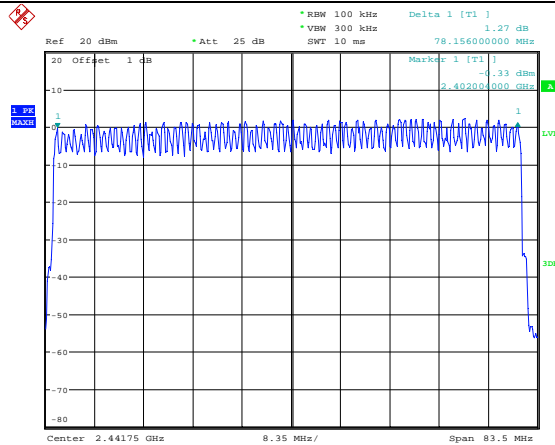

Date: 8.SEP.2022 01:55:00

4.6 Time Of Occupancy(Dwell Time):

Serial Number:	CR22090006-RF-S1	Test Date:	2022/9/8
Test Site:	RF	Test Mode:	Transmitting
Tester:	Morpheus Shi	Test Result:	Pass

Environmental Conditions:

Temperature: (°C)	26.8	Relative Humidity: (%)	65	ATM Pressure: (kPa)	100.8
----------------------	------	------------------------------	----	------------------------	-------

Test Equipment List and Details:

Manufacturer	Description	Model	Serial Number	Calibration Date	Calibration Due Date
R&S	Spectrum Analyzer	FSU26	200256	2022/7/15	2023/7/14
zhuoxiang	Coaxial Cable	SMA-178	211001	Each time	N/A
HuiXunDa	DC Block	SMA-JK 18G	DCB181108043	Each time	N/A

* Statement of Traceability: China Certification ICT Co., Ltd (Dongguan) attests that all calibrations have been performed, traceable to National Primary Standards and International System of Units (SI).

Test Data:

Test Modes	Packet Type	Test Frequency (MHz)	Pulse width (ms)	Result (s)	Limit (s)
BDR Mode (GFSK)	DH1	2441	0.398	0.127	0.400
	DH3	2441	1.680	0.269	0.400
	DH5	2441	2.941	0.314	0.400
EDR Mode ($\pi/4$ -DQPSK)	2DH1	2441	0.405	0.130	0.400
	2DH3	2441	1.704	0.273	0.400
	2DH5	2441	2.973	0.317	0.400
EDR Mode (8DPSK)	3DH1	2441	0.416	0.133	0.400
	3DH3	2441	1.689	0.270	0.400
	3DH5	2441	2.935	0.313	0.400

Note:

DH1:Dwell time=Pulse time (ms) \times (1600/2/79) \times 31.6 s

DH3:Dwell time=Pulse time (ms) \times (1600/4/79) \times 31.6 s

DH5:Dwell time=Pulse time (ms) \times (1600/6/79) \times 31.6 s

BDR Mode (GFSK)

DH1:

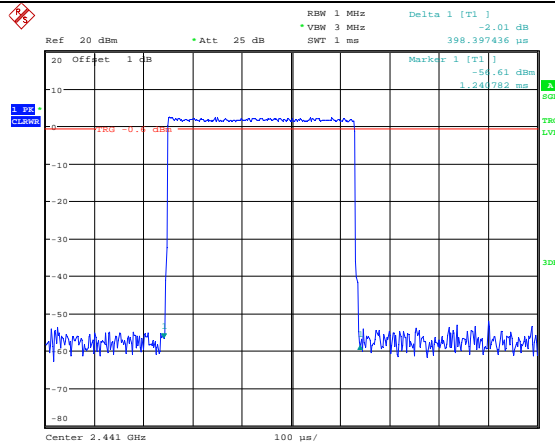

Date: 8.SEP.2022 02:06:52

DH3:

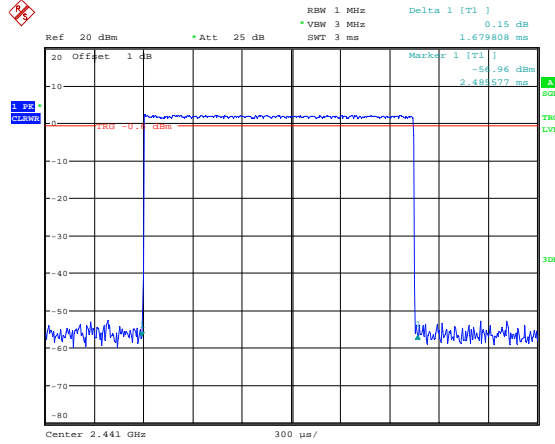

Date: 8.SEP.2022 02:08:07

DH5:

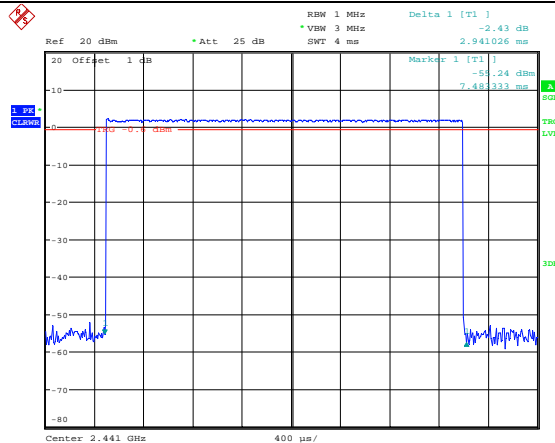

Date: 8.SEP.2022 02:11:25

EDR Mode ($\pi/4$-DQPSK)	
2DH1:	<p>Ref: 20 dBm *Att: 25 dB RBW: 1 MHz Delta: 4.85 dB *VBM: 3 MHz 405.448719 us SWT: 1 ms Marker 1 [T1]: -54.65 dBm, 1.241064 ms</p> <p>Center: 2.441 GHz 100 us/</p> <p>Date: 8.SEP.2022 02:12:28</p>
2DH3:	<p>Ref: 20 dBm *Att: 25 dB RBW: 1 MHz Delta: 1.54 dB *VBM: 3 MHz 1.703846 ms SWT: 3 ms Marker 1 [T1]: -55.15 dBm, 2.47154 ms</p> <p>Center: 2.441 GHz 300 us/</p> <p>Date: 8.SEP.2022 02:13:19</p>
2DH5:	<p>Ref: 20 dBm *Att: 25 dB RBW: 1 MHz Delta: -0.99 dB *VBM: 3 MHz 2.973077 ms SWT: 4 ms Marker 1 [T1]: -51.98 dBm, 6.23133 ms</p> <p>Center: 2.441 GHz 400 us/</p> <p>Date: 8.SEP.2022 02:14:07</p>

EDR Mode (8DPSK)

3DH1:

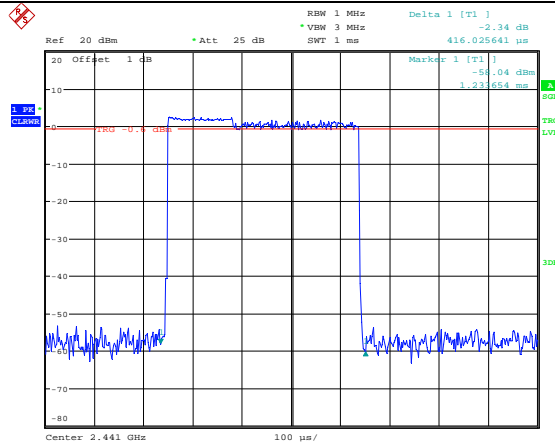

Date: 8.SEP.2022 02:15:10

3DH3:

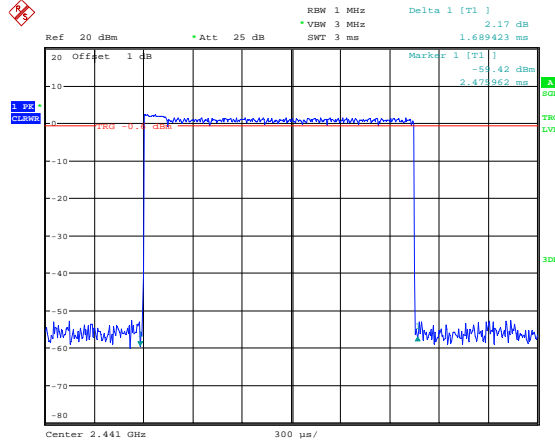

Date: 8.SEP.2022 02:16:00

3DH5:

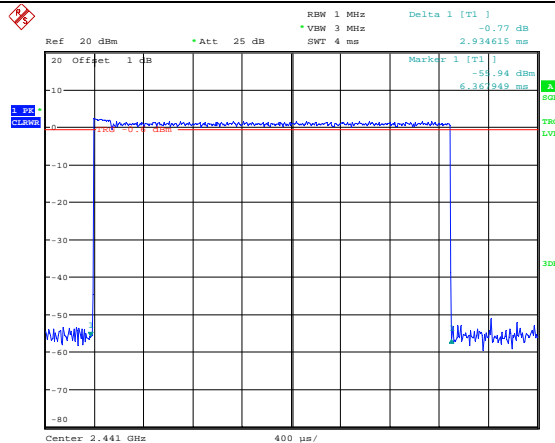

Date: 8.SEP.2022 02:16:49

4.7 Peak Conducted Output Power:

Serial Number:	CR22090006-RF-S1	Test Date:	2022/9/8
Test Site:	RF	Test Mode:	Transmitting
Tester:	Morpheus Shi	Test Result:	Pass

Environmental Conditions:

Temperature: (°C)	26.8	Relative Humidity: (%)	65	ATM Pressure: (kPa)	100.8
----------------------	------	------------------------------	----	------------------------	-------

Test Equipment List and Details:

Manufacturer	Description	Model	Serial Number	Calibration Date	Calibration Due Date
Agilent	USB Wideband Power Sensor	U2021XA	MY54080015	2022-07-15	2023-07-14
zhuoxiang	Coaxial Cable	SMA-178	211001	Each time	N/A
HuiXunDa	DC Block	SMA-JK 18G	DCB181108043	Each time	N/A

* Statement of Traceability: China Certification ICT Co., Ltd (Dongguan) attests that all calibrations have been performed, traceable to National Primary Standards and International System of Units (SI).

Test Data:

Test Modes	Test Frequency (MHz)	Peak Conducted Output Power (dBm)	Limits (dBm)
BDR Mode (GFSK)	2402	1.39	21
	2441	2.45	21
	2480	3.11	21
EDR Mode ($\pi/4$ -DQPSK)	2402	1.38	21
	2441	2.45	21
	2480	3.13	21
EDR Mode (8DPSK)	2402	1.36	21
	2441	2.44	21
	2480	3.12	21

4.8 100 kHz Bandwidth of Frequency Band Edge:

Serial Number:	CR22090006-RF-S1	Test Date:	2022/9/8
Test Site:	RF	Test Mode:	Transmitting
Tester:	Morpheus Shi	Test Result:	Pass

Environmental Conditions:

Temperature: (°C)	26.8	Relative Humidity: (%)	65	ATM Pressure: (kPa)	100.8
----------------------	------	---------------------------	----	------------------------	-------

Test Equipment List and Details:

Manufacturer	Description	Model	Serial Number	Calibration Date	Calibration Due Date
R&S	Spectrum Analyzer	FSU26	200256	2022/7/15	2023/7/14
zhuoxiang	Coaxial Cable	SMA-178	211001	Each time	N/A
HuiXunDa	DC Block	SMA-JK 18G	DCB181108043	Each time	N/A

* *Statement of Traceability: China Certification ICT Co., Ltd (Dongguan) attests that all calibrations have been performed, traceable to National Primary Standards and International System of Units (SI).*

BDR Mode (GFSK)

**Band Edge,
Left Side**

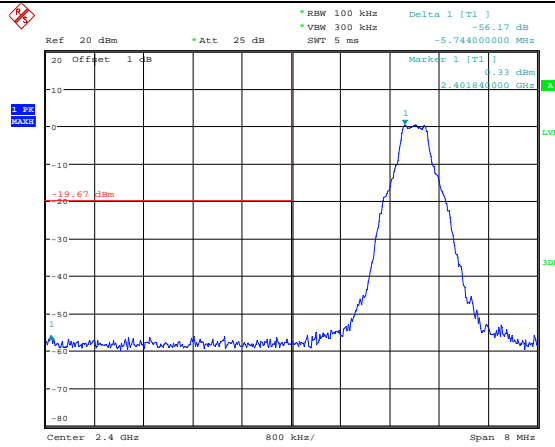

Date: 8.SEP.2022 01:13:42

**Band Edge,
Right Side**

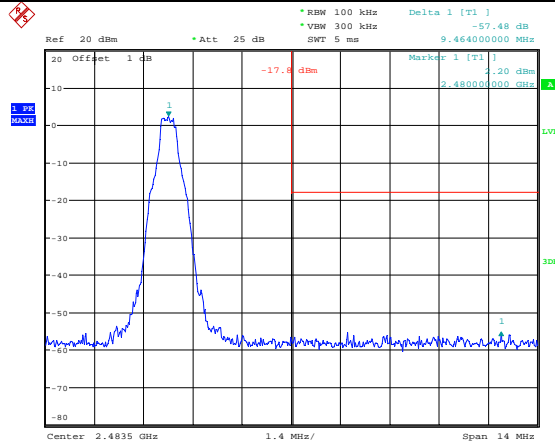

Date: 8.SEP.2022 01:15:48

EDR Mode ($\pi/4$ -DQPSK)

**Band Edge,
Left Side**

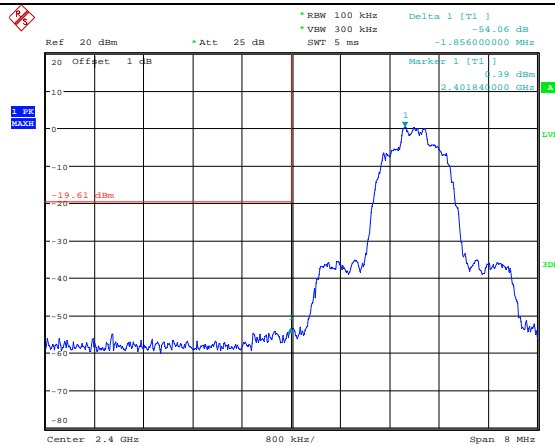

Date: 8.SEP.2022 01:17:15

**Band Edge,
Right Side**

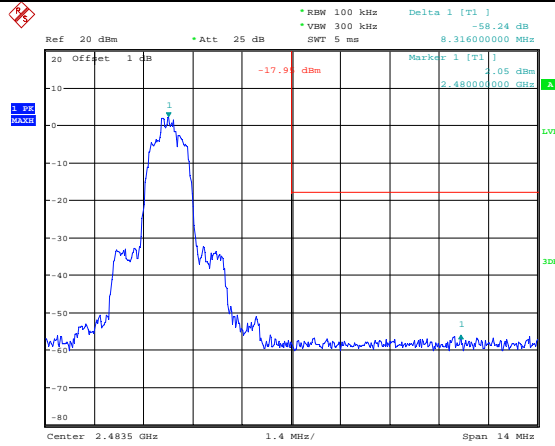

Date: 8.SEP.2022 01:20:00

EDR Mode (8DPSK)

**Band Edge,
Left Side**

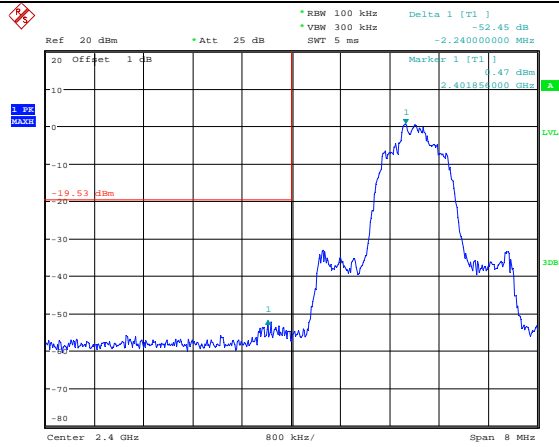

Date: 8.SEP.2022 01:21:13

**Band Edge,
Right Side**

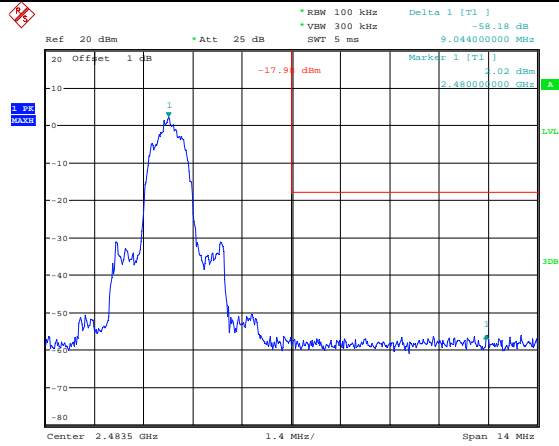

Date: 8.SEP.2022 01:23:11

Hopping Mode, BDR Mode (GFSK)

**Band Edge,
Left Side**

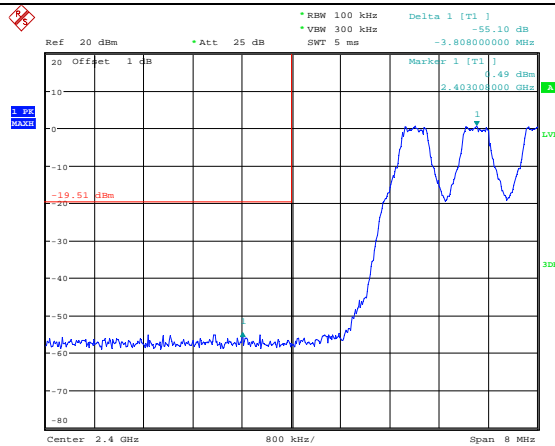

Date: 8.SEP.2022 01:56:38

**Band Edge,
Right Side**

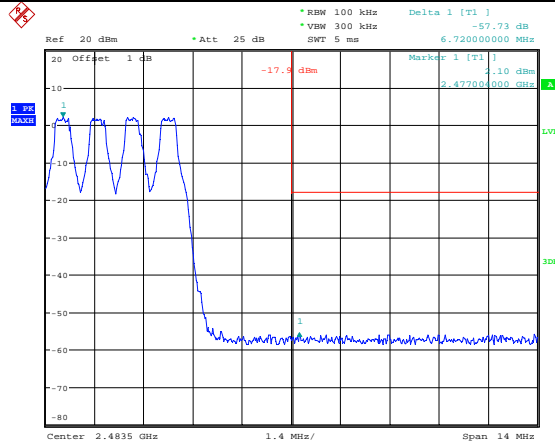

Date: 8.SEP.2022 01:57:37

Hopping Mode, EDR Mode ($\pi/4$ -DQPSK)

**Band Edge,
Left Side**

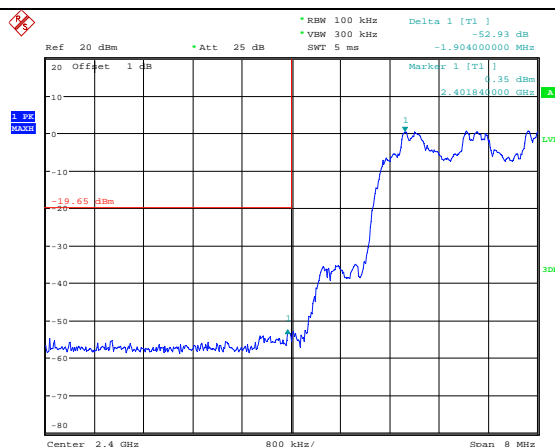

Date: 8.SEP.2022 01:58:36

**Band Edge,
Right Side**

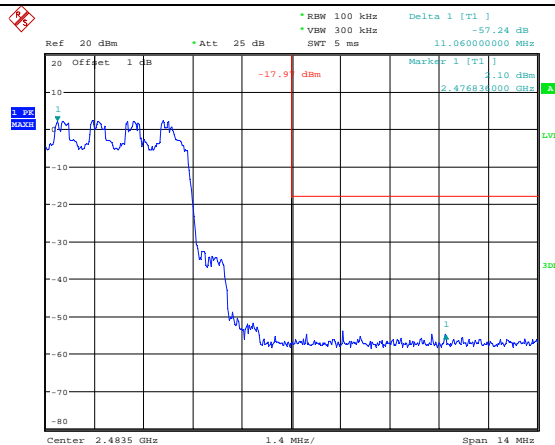

Date: 8.SEP.2022 02:00:04

Hopping Mode, EDR Mode (8DPSK)

**Band Edge,
Left Side**

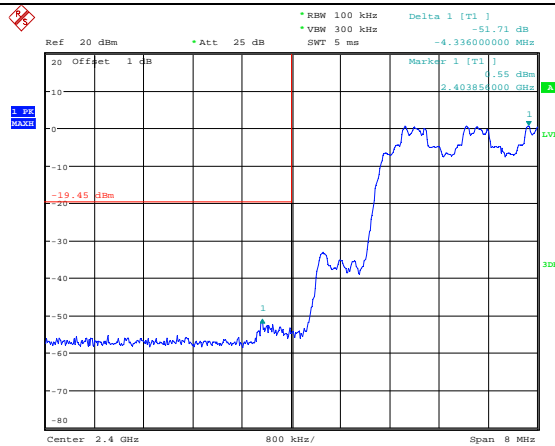

Date: 8.SEP.2022 02:01:25

**Band Edge,
Right Side**

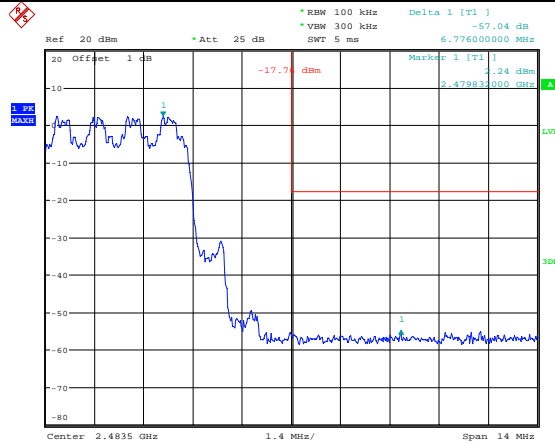

Date: 8.SEP.2022 02:02:44

5. RF EXPOSURE EVALUATION

5.1 Applicable Standard

FCC §15.247 (i)

Systems operating under the provisions of this section shall be operated in a manner that ensures that the public is not exposed to radio frequency energy levels in excess of the Commission's guidelines. See §1.1307(b)(1) of this chapter.

5.2 Procedure

According to 447498 D04 Interim General RF Exposure Guidance v01, clause 2.1.3 1- SAR-Based Exemption:

A more comprehensive exemption, considering a variable power threshold that depends on both the *separation distance* and power, is provided in §1.1307(b)(3)(ii)(B). This exemption is applicable to the frequency range between 300 MHz and 6 GHz, with *test separation distances* between 0.5 cm and 40 cm, and for all RF sources in fixed, mobile, and portable device exposure conditions.

Accordingly, a RF source is considered an *RF exempt device* if its available maximum time-averaged (matched conducted) power or its effective radiated power (ERP), whichever is greater, are below a specified threshold. This exemption threshold was derived based on general population 1-g SAR requirements and is detailed in Appendix C.

5.3 Measurement Result

Frequency (MHz)	EPR _{20cm}	Distance (cm)	SAR-Based Exemption Threshold		Conducted output power including Tune-up Tolerance (dBm)	Antenna Gain (dBi)	ERP (dBm)	SAR-Based Exemption
			(mW)	(dBm)				
2402-2480	3060	0.5	2.717	4.34	4.0	1.23	3.08	Compliant

Result: Compliant. RF Exposure is exemption.

===== END OF REPORT =====