

# Technical Specification

<b>AntennaMode</b>	ZN137	<b>Manufactured</b>	Shenzhen PIPA antenna design Co.,LTD.
<b>Address</b>	Unit F/4F, buildingA, Junxiangda, Plada, Zhongshanyuan Road, Nanshan District, Shenzhen		

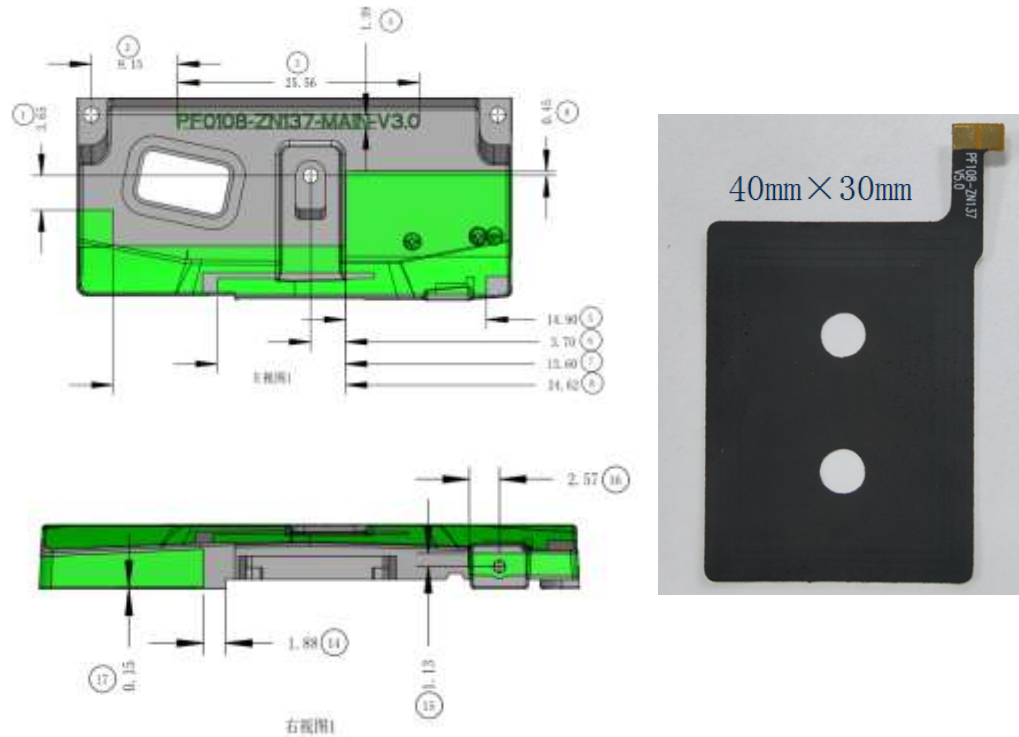

Ant0-GSM/WDMA/LTE main: PIFA

Size & Picture

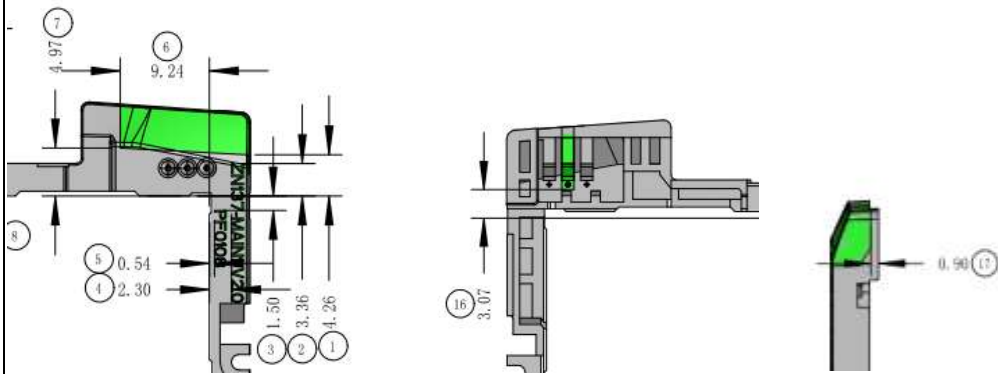

Ant1- GSM/WDMA/LTE div: Monopole

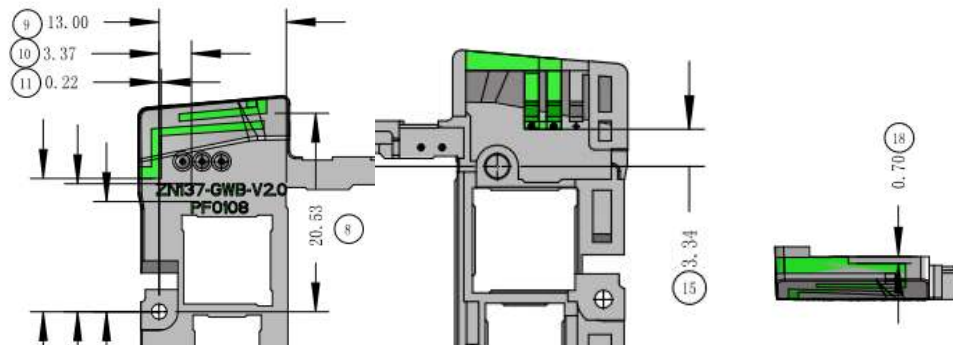

Ant2-GWB: PIFA





# Technical Specification

## Ant0 3-D Patten Plots

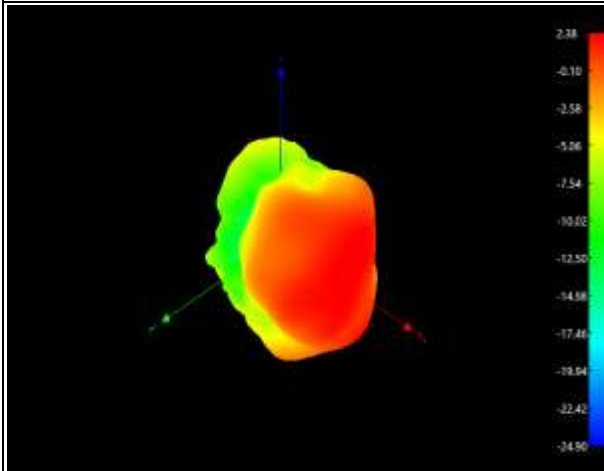

Ant0: 700Mhz

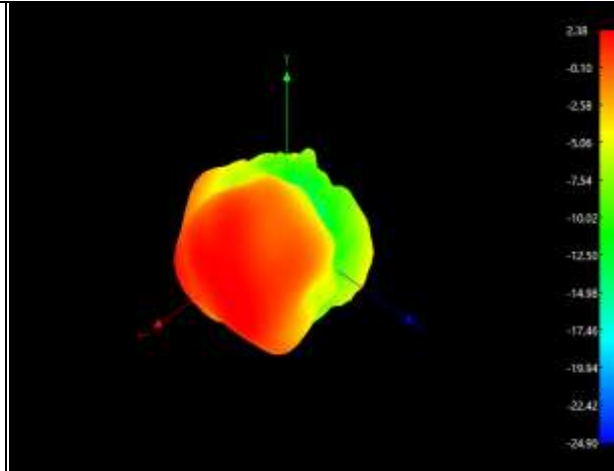

Ant0: 800Mhz

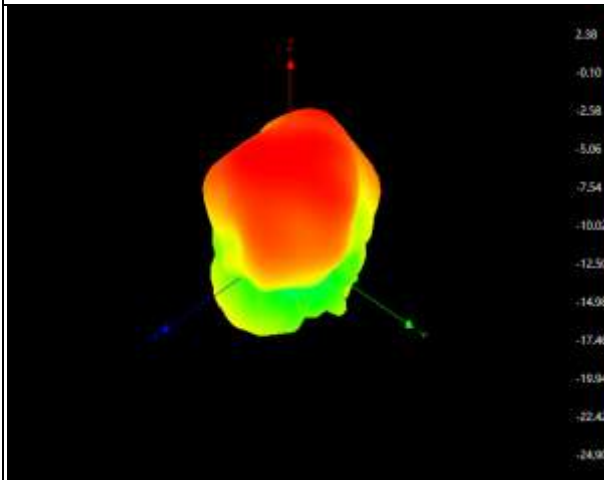

Ant0: 900Mhz

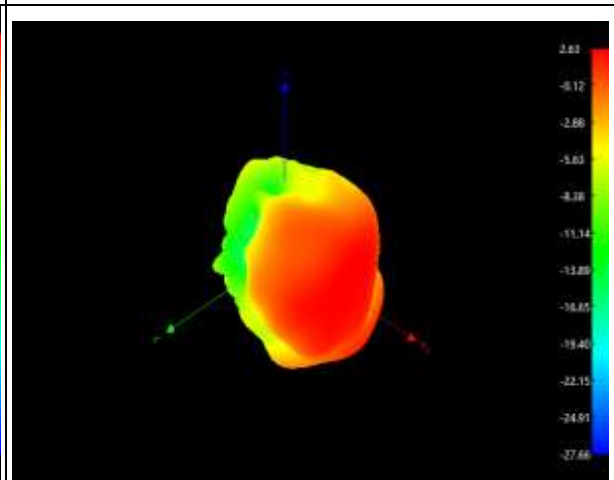

Ant0: 1700Mhz

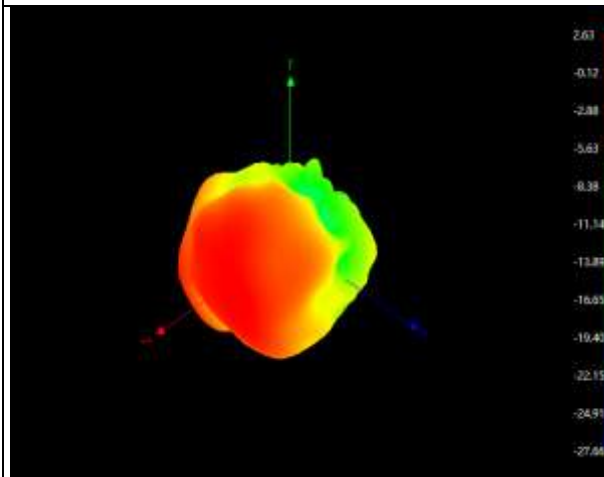

Ant0: 1900Mhz

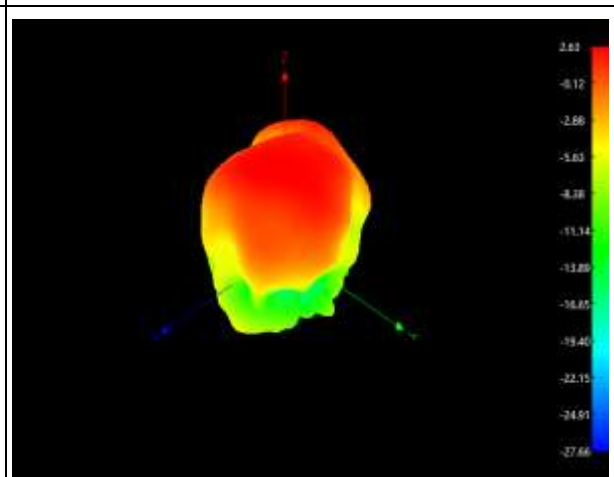

Ant0: 2100Mhz

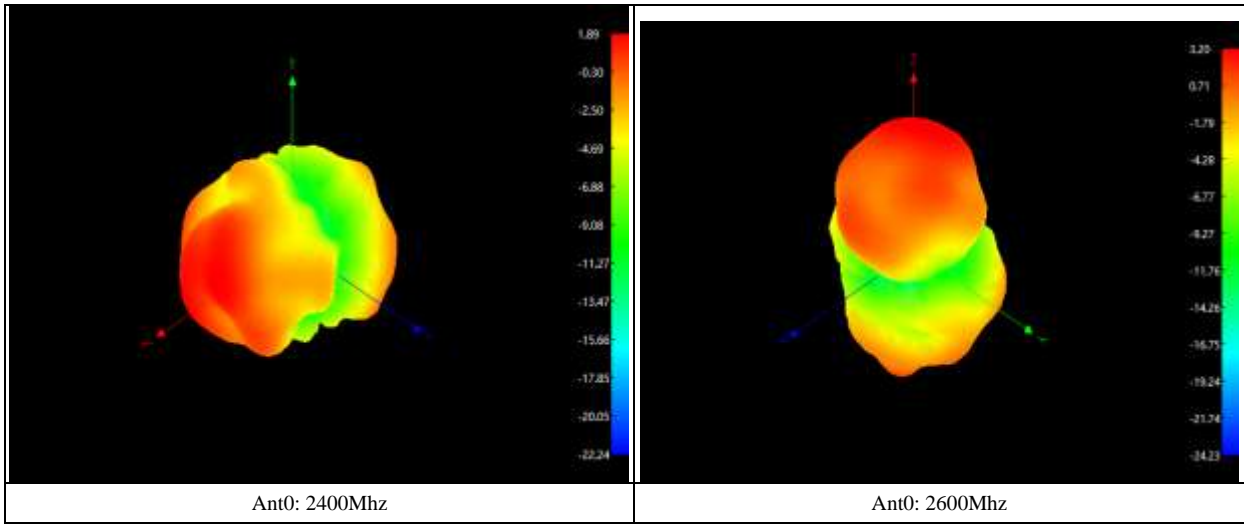

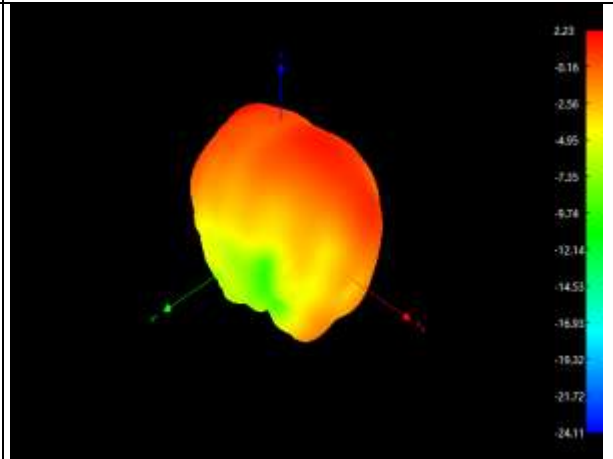
Technical Specification	
Ant1 3-D Patten Plots	
Ant1: 700Mhz	Ant1: 800Mhz
	
Ant1: 900Mhz	Ant1: 1700Mhz

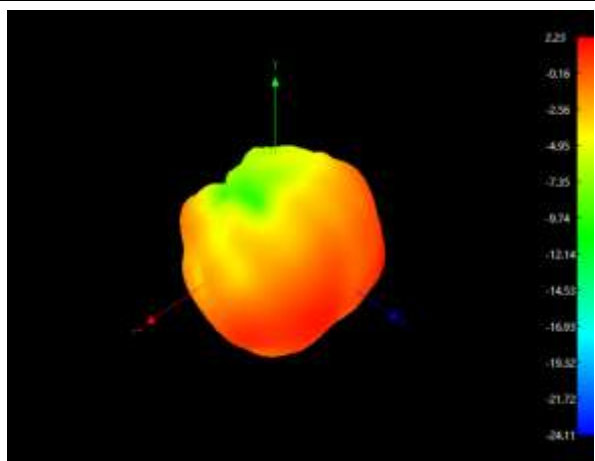

Ant1: 1900Mhz

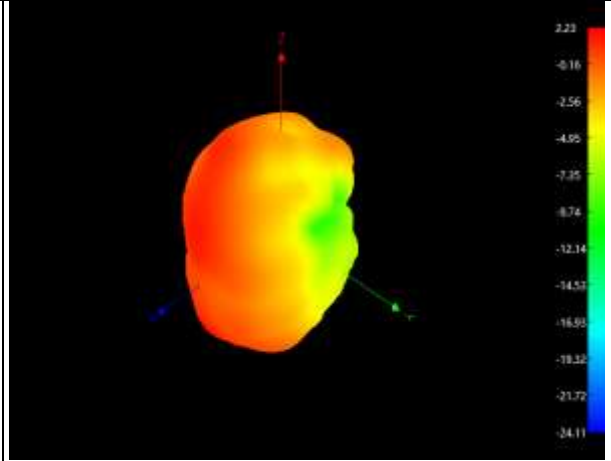

Ant1: 2100Mhz

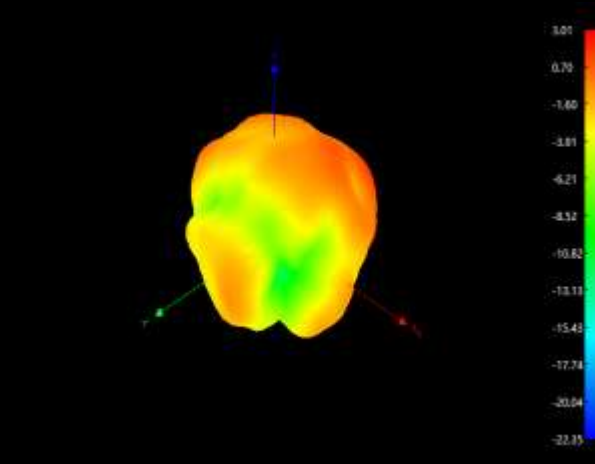

Ant1: 2400Mhz

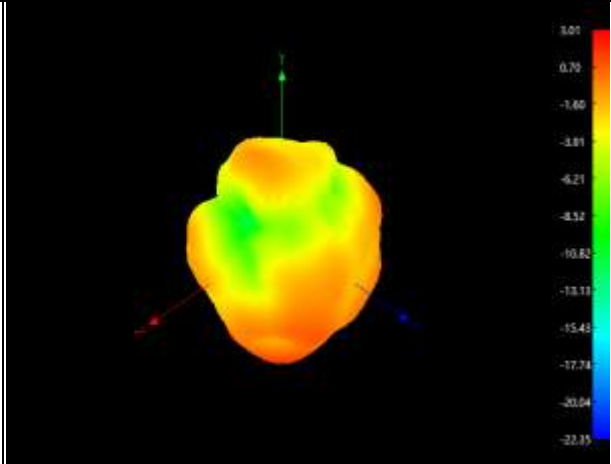

Ant1: 2600Mhz

# Technical Specification

## Ant2 3-D Patten Plots

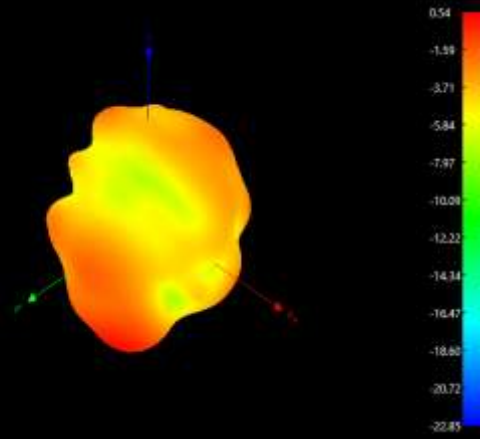
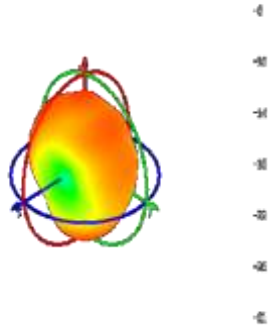

Ant7: 1575Mhz

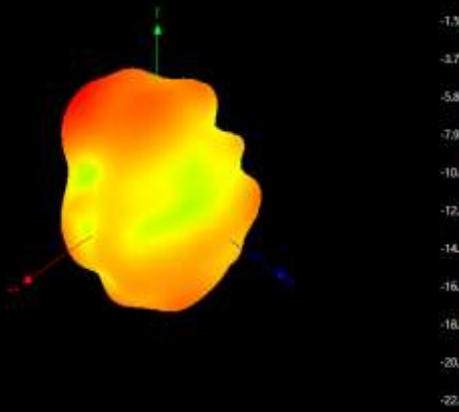

Ant7: 2450Mhz

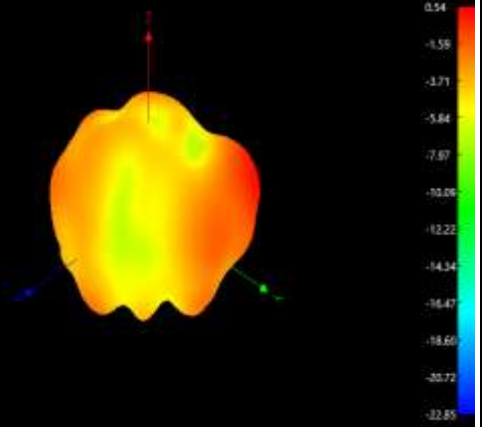

Ant7: 5500Mhz