

**DOOGEE**

# User Manual

Thanks for choosing DOOGEE products



Scan the QR code  
for more function information

## **Contents**

English.....	02
--------------	----

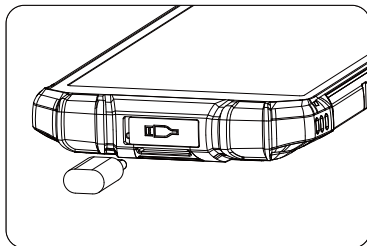
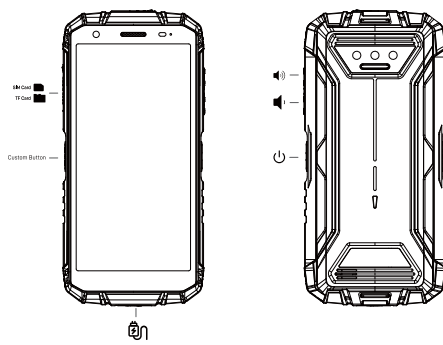

1

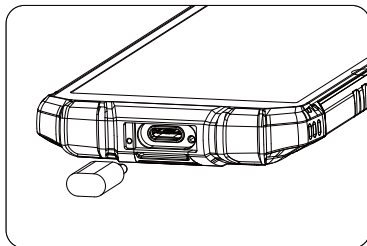

2

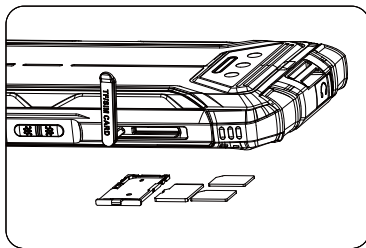

3

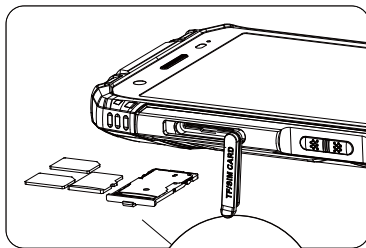

4

## WEEE



Special precautions must be taken to safely dispose of this product. This marking indicates that this product may not be discarded with other household waste in the EU.

To prevent harm to the environment or human health from inappropriate waste disposal, and to promote sustainable reuse of material resources, please recycle responsibly.

To safely recycle your device, please use return and collection systems or contact the retailer where the device was originally purchased.

To view our Environmental Declaration, please refer to the following link: [www.doogee.cc/page/environment.html](http://www.doogee.cc/page/environment.html)

## CAUTION

RISK OF EXPLOSION IF BATTERY IS REPLACED BY AN INCORRECT TYPE. DISPOSE OF USED BATTERIES ACCORDING TO INSTRUCTIONS.



To prevent possible hearing damage, do not listen at high volume levels for long periods.

## Important Safety Information

Read all safety information below before using your device:

- Use of unauthorized cables, power adapters, or batteries can cause fire, explosion, or pose other risks.
- Use only authorized accessories which are compatible with your device.
- This device's operating temperature range is -10°C to 40°C. Using this device in an environment outside of this temperature range may damage the device.
- If your device is provided with a built-in battery, to avoid damaging the battery or the device, do not attempt to replace the battery yourself.
- Charge this device only with the included or authorized cable and power adapter. Using other adapters may cause fire, electric shock, and damage the device and the adapter.
- After charging is complete, disconnect the adapter from both the device and the power outlet. Do not charge the device for more than 12 hours.

- The battery must be recycled or disposed of separately from household waste. Mishandling the battery may cause fire or explosion. Dispose of or recycle the device, its battery, and accessories according to your local regulations.
- Do not disassemble, hit, crush, or burn the battery. If the battery appears deformed or damaged, stop using it immediately.
- Do not short circuit the battery, as this may cause overheating, burns, or other injury.
- Do not place the battery in a high-temperature environment.
- Overheating may cause explosion.
- Do not disassemble, hit, or crush the battery, as this may cause the battery to leak, overheat, or explode.
- Do not burn the battery, as this may cause fire or explosion.
- If the battery appears deformed or damaged, stop using it immediately.
- User shall not remove or alter the battery. Removal or repair of the battery shall only be done by an authorized repair center of the manufacturer.
- Keep your device dry.
- Do not try to repair the device yourself. If any part of the device does not work properly, contact DOOGEE customer support or bring your device to an authorized repair center.
- Connect other devices according to their instruction manuals. Do not connect incompatible devices to this device.
- For AC/DC adapters, the socket-outlet shall be installed near the equipment and shall be easily accessible.

## Safety Precautions

· Observe all applicable laws and rules restricting use of mobile phones in specific situations and environments.

· Do not use your phone at petrol stations or in any explosive atmosphere or potentially explosive environment, including fueling areas, below decks on boats, fuel or chemical transfer or storage facilities, or areas where the air may contain chemicals or particles such as grain, dust, or metal powders.

Obey all posted signs to turn off wireless devices such as your phone or other radio equipment. Turn off your mobile phone or wireless device when in a blasting area or in areas requiring "two-way radios" or "electronic devices" to be turned off to prevent potential hazards.

Do not use your phone in hospital operating rooms, emergency rooms, or intensive care units. Always comply with all rules and regulations of hospitals and health centers. If you have a medical device, please consult your doctor and the device manufacturer to determine whether your phone may interfere with the device's operation. To avoid potential interference with a pacemaker, always maintain a minimum distance of 15 cm between your mobile phone and the pacemaker. This can be done by using your phone on the ear opposite to your pacemaker and not carrying your phone in a breast pocket. To avoid interference with medical equipment, do not use your phone near hearing aids, cochlear implants, or other similar devices.

- Observe all aircraft safety regulations and turn off your phone on board aircraft when required.
- When driving a vehicle, use your phone in accordance with relevant traffic laws and regulations.
- To avoid being struck by lightning, do not use your phone outdoors during thunderstorms.
- Do not use your phone to make calls while it is charging.
- Do not use your phone in places with high humidity, such as bathrooms. Doing so may result in electric shock, injury, fire, and charger damage.



## Security Statement

Please update your phone's operating system using the built-in software update feature, or visit any of our authorized service outlets. Updating software through other means may damage the device or result in data loss, security issues, and other risks.

## EU Regulations



## RED Declaration of Conformity

Shenzhen DOOGEE Hengtong Technology CO.,LTD hereby declares that this GSM /GPRS/WCDMA/ LTE Digital Mobile Phone with Bluetooth and Wi-Fi M2101K7AG is in compliance with the essential requirements and other relevant provisions of the RE Directive 2014/53/EU. The full text of the EU declaration of conformity is available at the following internet address: [www.doogee.cc/page/certification.html](http://www.doogee.cc/page/certification.html)

## RF Exposure Information (SAR)

This device is in compliance with Specific Absorption Rate (SAR) limits for general population/uncontrolled exposure (Localized 10-gram SAR for head and trunk, limit: 1.6W/kg) specified in Council Recommendation 1999/519/EC, ICNIRP Guidelines, and RED (Directive 2014/53/EU).

During SAR testing, this device was set to transmit at its highest certified power level in all tested frequency bands and placed in positions that simulate RF exposure during use against the head with no separation and near the body with a separation of 5 mm.

SAR compliance for body operation is based on a separation distance of 5 mm between the unit and the human body. This device should be carried at least 5 mm away from the body to ensure RF exposure level is compliant or lower than the reported level. When attaching the device near the body, a belt clip or holster should be used which does not contain metallic components and allows a separation of at least 5 mm to be maintained between the device and the body. RF exposure compliance was not tested or certified with any accessory containing metal worn on the body, and use of such an accessory should be avoided.

## Legal Information

This device may be operated in all member states of the EU. Observe national and local regulations where the device is used. This device is restricted to indoor use only when operating in the 5150 to 5350 MHz frequency range in the following countries:

				
AT	BE	CY	CZ	DK
EE	FI	FR	DE	EL
HU	IE	IT	LV	LT
LU	MT	NL	PL	PT
SK	SI	ES	SE	BG
RO	HR			

**W52 Indoor use only**



## FCC Compliance Notice

Specific Absorption Rate (SAR) information SAR tests are conducted using standard operating positions accepted by the FCC with the phone transmitting at its highest certified power level in all tested frequency bands, although the SAR is determined at the highest certified power level, the actual SAR level of the phone while operating can be well below the maximum value, in general, the closer you are to a wireless base station antenna, the lower the power output.

Before a new model phone is available for sale to the public, it must be tested and certified to the FCC that it does not exceed the exposure limit established by the FCC. Tests for each phone are performed in positions and locations (e.g. at the ear and worn on the body) as required by the FCC.

For body worn operation, this mobile phone has been tested and meets the FCC RF exposure guidelines when used with an accessory designated for this product or when used with an accessory that contains no metal and that positions the handset a minimum of 1cm from the body.

Any Changes or modifications not expressly approved by the party responsible for compliance could void the user's authority to operate the equipment.

This device complies with part 15 of the FCC Rules. Operation is subject to the following two conditions: (1) This device may not cause harmful interference, and (2) this device must accept any interference received, including interference that may cause undesired operation.

Note: This equipment has been tested and found to comply with the limits for a Class B digital device, pursuant to part 15 of the FCC Rules. These limits are designed to provide reasonable protection against harmful interference in a residential installation. This equipment generates uses and can radiate radio frequency energy and, if not installed and used in accordance with the instructions, may cause harmful interference to radio communications. However, there is no guarantee that interference will not occur in a particular installation. If this equipment does cause harmful interference to radio or television reception, which can be determined by turning the equipment off and on, the user is encouraged to try to correct the interference by one or more of the following measures:

- Reorient or relocate the receiving antenna.
- Increase the separation between the equipment and receiver.
- Connect the equipment into an outlet on a circuit different from that to which the receiver is connected.
- Consult the dealer or an experienced radio/TV technician for help.

## Certification Information (Highest SAR)

SAR 1g limit: 1.6W/Kg,

SAR Value:Head:0.8W/Kg,Body:0.79 W/Kg(10 mm distance).

## Disclaimer

This user guide is published by DOOGEE or its local affiliated company. Improvements and changes to this user guide necessitated by typographical errors, inaccuracies of current information, or improvements to programs and/or equipment, may be made by DOOGEE at any time and without notice. Such changes will, however, be incorporated into new online editions of the user guide ( please see details at [www.doogee.cc/page/manual.html](http://www.doogee.cc/page/manual.html) ). All illustrations are for illustration purposes only and may not accurately depict the actual device.

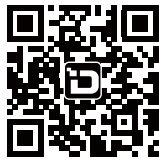

[www.doojee.cc](http://www.doojee.cc)

This user manual is for reference only.  
The specific functions and product pictures may be slightly  
different from the actual ones. Please prevail in kind.

 DOOGEE mobile  DOOGEE\_official  DOOGEE official