



SAR REFERENCE DIPOLE CALIBRATION REPORT

Ref. ACR.60.2.21.MVGB.A

1 INTRODUCTION

This document contains a summary of the requirements set forth by the IEEE 1528, FCC KDBs and CEI/IEC 62209 standards for reference dipoles used for SAR measurement system validations and the measurements that were performed to verify that the product complies with the fore mentioned standards.

2 DEVICE UNDER TEST

Device Under Test	
Device Type	COMOSAR 750 MHz REFERENCE DIPOLE
Manufacturer	MVG
Model	SID750
Serial Number	SN 03/15 DIP0G750-355
Product Condition (new / used)	Used

3 PRODUCT DESCRIPTION

3.1 GENERAL INFORMATION

MVG’s COMOSAR Validation Dipoles are built in accordance to the IEEE 1528, FCC KDBs and CEI/IEC 62209 standards. The product is designed for use with the COMOSAR test bench only.



Figure 1 – MVG COMOSAR Validation Dipole



SAR REFERENCE DIPOLE CALIBRATION REPORT

Ref: ACR.60.2.21.MVGB.A

4 MEASUREMENT METHOD

The IEEE 1528, FCC KDBs and CEI/IEC 62209 standards provide requirements for reference dipoles used for system validation measurements. The following measurements were performed to verify that the product complies with the fore mentioned standards.

4.1 RETURN LOSS REQUIREMENTS

The dipole used for SAR system validation measurements and checks must have a return loss of -20 dB or better. The return loss measurement shall be performed against a liquid filled flat phantom, with the phantom constructed as outlined in the fore mentioned standards. A direct method is used with a network analyser and its calibration kit, both with a valid ISO17025 calibration.

4.2 MECHANICAL REQUIREMENTS

The IEEE Std. 1528 and CEI/IEC 62209 standards specify the mechanical components and dimensions of the validation dipoles, with the dimension's frequency and phantom shell thickness dependent. The COMOSAR test bench employs a 2 mm phantom shell thickness therefore the dipoles sold for use with the COMOSAR test bench comply with the requirements set forth for a 2 mm phantom shell thickness. A direct method is used with a ISO17025 calibrated caliper.

5 MEASUREMENT UNCERTAINTY

All uncertainties listed below represent an expanded uncertainty expressed at approximately the 95% confidence level using a coverage factor of k=2, traceable to the Internationally Accepted Guides to Measurement Uncertainty.

5.1 RETURN LOSS

The following uncertainties apply to the return loss measurement:

Frequency band	Expanded Uncertainty on Return Loss
400-6000MHz	0.08 LIN

5.2 DIMENSION MEASUREMENT

The following uncertainties apply to the dimension measurements:

Length (mm)	Expanded Uncertainty on Length
0 - 300	0.20 mm
300 - 450	0.44 mm

5.3 VALIDATION MEASUREMENT

The guidelines outlined in the IEEE 1528, FCC KDBs, CENELEC EN50361 and CEI/IEC 62209 standards were followed to generate the measurement uncertainty for validation measurements.

Scan Volume	Expanded Uncertainty



SAR REFERENCE DIPOLE CALIBRATION REPORT

Ref: ACR.60.2.21.MVGB.A

1 g	19 % (SAR)
10 g	19 % (SAR)

6 CALIBRATION MEASUREMENT RESULTS

6.1 RETURN LOSS AND IMPEDANCE

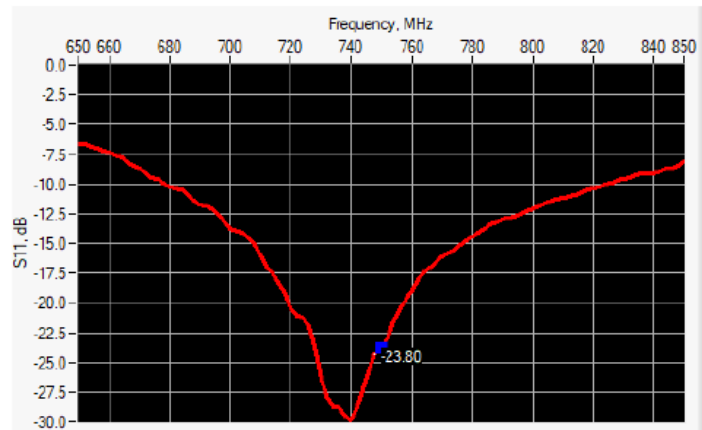

Frequency (MHz)	Return Loss (dB)	Requirement (dB)	Impedance
750	-23.80	-20	56.4 Ω - 0.1 jΩ

6.2 MECHANICAL DIMENSIONS

Frequency MHz	L mm		h mm		d mm	
	required	measured	required	measured	required	measured
300	420.0 ±1 %.		250.0 ±1 %.		6.35 ±1 %.	
450	290.0 ±1 %.		166.7 ±1 %.		6.35 ±1 %.	
750	176.0 ±1 %.	-	100.0 ±1 %.	-	6.35 ±1 %.	-
835	161.0 ±1 %.		89.8 ±1 %.		3.6 ±1 %.	
900	149.0 ±1 %.		83.3 ±1 %.		3.6 ±1 %.	
1450	89.1 ±1 %.		51.7 ±1 %.		3.6 ±1 %.	
1500	80.5 ±1 %.		50.0 ±1 %.		3.6 ±1 %.	
1640	79.0 ±1 %.		45.7 ±1 %.		3.6 ±1 %.	
1750	75.2 ±1 %.		42.9 ±1 %.		3.6 ±1 %.	
1800	72.0 ±1 %.		41.7 ±1 %.		3.6 ±1 %.	
1900	68.0 ±1 %.		39.5 ±1 %.		3.6 ±1 %.	
1950	66.3 ±1 %.		38.5 ±1 %.		3.6 ±1 %.	
2000	64.5 ±1 %.		37.5 ±1 %.		3.6 ±1 %.	
2100	61.0 ±1 %.		35.7 ±1 %.		3.6 ±1 %.	
2300	55.5 ±1 %.		32.6 ±1 %.		3.6 ±1 %.	
2450	51.5 ±1 %.		30.4 ±1 %.		3.6 ±1 %.	



SAR REFERENCE DIPOLE CALIBRATION REPORT

Ref. ACR.60.2.21.MVGB.A

2600	48.5 ±1 %.		28.8 ±1 %.		3.6 ±1 %.
3000	41.5 ±1 %.		25.0 ±1 %.		3.6 ±1 %.
3500	37.0±1 %.		26.4 ±1 %.		3.6 ±1 %.
3700	34.7±1 %.		26.4 ±1 %.		3.6 ±1 %.

7 VALIDATION MEASUREMENT

The IEEE Std. 1528, FCC KDBs and CEI/IEC 62209 standards state that the system validation measurements must be performed using a reference dipole meeting the fore mentioned return loss and mechanical dimension requirements. The validation measurement must be performed against a liquid filled flat phantom, with the phantom constructed as outlined in the fore mentioned standards. Per the standards, the dipole shall be positioned below the bottom of the phantom, with the dipole length centered and parallel to the longest dimension of the flat phantom, with the top surface of the dipole at the described distance from the bottom surface of the phantom.

7.1 MEASUREMENT CONDITION

Software	OPENSAR V5
Phantom	SN 13/09 SAM68
Probe	SN 41/18 EPGO333
Liquid	Head Liquid Values: eps' : 41.8 sigma : 0.82
Distance between dipole center and liquid	15.0 mm
Area scan resolution	dx=8mm/dy=8mm
Zoon Scan Resolution	dx=8mm/dy=8mm/dz=5mm
Frequency	750750 MHz
Input power	20 dBm
Liquid Temperature	20 +/- 1 °C
Lab Temperature	20 +/- 1 °C
Lab Humidity	30-70 %

7.2 HEAD LIQUID MEASUREMENT

Frequency MHz	Relative permittivity (ε _r)		Conductivity (σ) S/m	
	required	measured	required	measured
300	45.3 ±10 %		0.87 ±10 %	
450	43.5 ±10 %		0.87 ±10 %	
750	41.9 ±10 %	41.8	0.89 ±10 %	0.82
835	41.5 ±10 %		0.90 ±10 %	
900	41.5 ±10 %		0.97 ±10 %	
1450	40.5 ±10 %		1.20 ±10 %	
1500	40.4 ±10 %		1.23 ±10 %	
1640	40.2 ±10 %		1.31 ±10 %	
1750	40.1 ±10 %		1.37 ±10 %	
1800	40.0 ±10 %		1.40 ±10 %	
1900	40.0 ±10 %		1.40 ±10 %	
1950	40.0 ±10 %		1.40 ±10 %	
2000	40.0 ±10 %		1.40 ±10 %	



SAR REFERENCE DIPOLE CALIBRATION REPORT

Ref. ACR.60.2.21.MVGB.A

2100	39.8 ±10 %		1.49 ±10 %	
2300	39.5 ±10 %		1.67 ±10 %	
2450	39.2 ±10 %		1.80 ±10 %	
2600	39.0 ±10 %		1.96 ±10 %	
3000	38.5 ±10 %		2.40 ±10 %	
3500	37.9 ±10 %		2.91 ±10 %	

7.3 MEASUREMENT RESULT

The IEEE Std. 1528 and CEI/IEC 62209 standards state that the system validation measurements should produce the SAR values shown below (for phantom thickness of 2 mm), within the uncertainty for the system validation. All SAR values are normalized to 1 W forward power. In bracket, the measured SAR is given with the used input power.

Frequency MHz	1 g SAR (W/kg/W)		10 g SAR (W/kg/W)	
	required	measured	required	measured
300	2.85		1.94	
450	4.58		3.06	
750	8.49	8.53 (0.85)	5.55	5.56 (0.56)
835	9.56		6.22	
900	10.9		6.99	
1450	29		16	
1500	30.5		16.8	
1640	34.2		18.4	
1750	36.4		19.3	
1800	38.4		20.1	
1900	39.7		20.5	
1950	40.5		20.9	
2000	41.1		21.1	
2100	43.6		21.9	
2300	48.7		23.3	
2450	52.4		24	
2600	55.3		24.6	
3000	63.8		25.7	
3500	67.1		25	



SAR REFERENCE DIPOLE CALIBRATION REPORT

Ref. ACR.60.2.21.MVGB.A

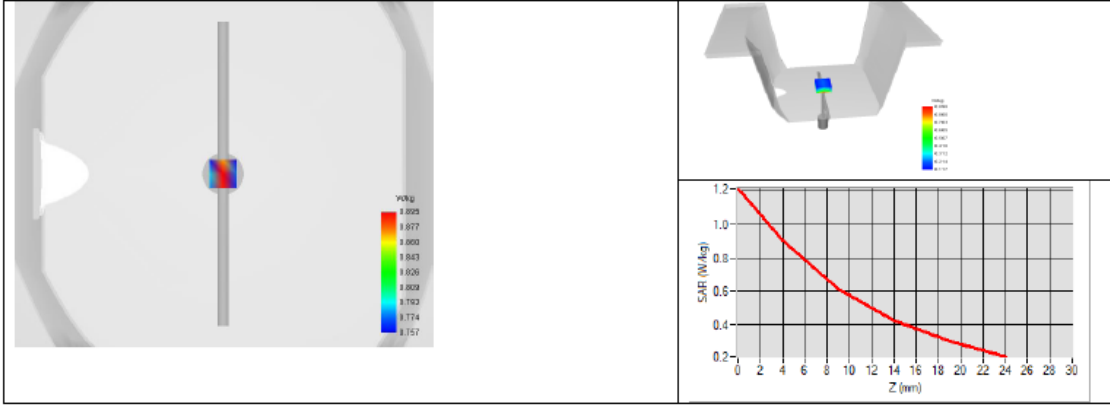



SAR REFERENCE DIPOLE CALIBRATION REPORT

Ref. ACR.60.2.21.MVGB.A

8 LIST OF EQUIPMENT

Equipment Summary Sheet				
Equipment Description	Manufacturer / Model	Identification No.	Current Calibration Date	Next Calibration Date
SAM Phantom	MVG	SN-13/09-SAM68	Validated. No cal required.	Validated. No cal required.
COMOSAR Test Bench	Version 3	NA	Validated. No cal required.	Validated. No cal required.
Network Analyzer	Rohde & Schwarz ZVM	100203	05/2019	05/2022
Network Analyzer – Calibration kit	Rohde & Schwarz ZV-Z235	101223	05/2019	05/2022
Calipers	Mitutoyo	SN 0009732	10/2019	10/2022
Reference Probe	MVG	EPGO333 SN 41/18	05/2020	05/2021
Multimeter	Keithley 2000	1160271	02/2020	02/2023
Signal Generator	Rohde & Schwarz SMB	106589	04/2019	04/2022
Amplifier	Aethercomm	SN 046	Characterized prior to test. No cal required.	Characterized prior to test. No cal required.
Power Meter	NI-USB 5680	170100013	05/2019	05/2022
Directional Coupler	Narda 4216-20	01386	Characterized prior to test. No cal required.	Characterized prior to test. No cal required.
Temperature / Humidity Sensor	Testo 184 H1	44220687	05/2020	05/2023



SAR Reference Dipole Calibration Report

Ref : ACR.60.3.21.MVGB.A

**SHENZHEN NTEK TESTING TECHNOLOGY
CO., LTD.**

**BUILDING E, FENDA SCIENCE PARK, SANWEI
COMMUNITY, XIXIANG STREET,
BAO'AN DISTRICT, SHENZHEN GUANGDONG, CHINA**

MVG COMOSAR REFERENCE DIPOLE

FREQUENCY: 835 MHZ

SERIAL NO.: SN 03/15 DIP0G835-347

Calibrated at MVG

Z.I. de la pointe du diable

Technopôle Brest Iroise – 295 avenue Alexis de Rochon

29280 PLOUZANE - FRANCE

Calibration date: 03/01/2021



Accreditations #2-6789 and #2-6814
Scope available on www.cofrac.fr

Summary:

This document presents the method and results from an accredited SAR reference dipole calibration performed at MVG, using the COMOSAR test bench. The test results covered by accreditation are traceable to the International System of Units (SI).



SAR REFERENCE DIPOLE CALIBRATION REPORT

Ref. ACR.60.3.21.MVGB.A

	Name	Function	Date	Signature
Prepared by :	Jérôme Luc	Technical Manager	3/1/2021	<i>JLS</i>
Checked by :	Jérôme Luc	Technical Manager	3/1/2021	<i>JLS</i>
Approved by :	Yann Toutain	Laboratory Director	3/1/2021	<i>Yann Toutain</i>

Made d'emploi 2021.03.0
1 13:09:12
+01'00'

PHILIPS

	Customer Name
Distribution :	SHENZHEN NTEK TESTING TECHNOLOGY CO., LTD.

Issue	Name	Date	Modifications
A	Jérôme Luc	3/1/2021	Initial release



SAR REFERENCE DIPOLE CALIBRATION REPORT

Ref. ACR.60.3.21.MVGB.A

TABLE OF CONTENTS

1 Introduction..... 4

2 Device Under Test 4

3 Product Description 4

 3.1 General Information 4

4 Measurement Method 5

 4.1 Return Loss Requirements 5

 4.2 Mechanical Requirements 5

5 Measurement Uncertainty..... 5

 5.1 Return Loss 5

 5.2 Dimension Measurement 5

 5.3 Validation Measurement 5

6 Calibration Measurement Results..... 6

 6.1 Return Loss and Impedance 6

 6.2 Mechanical Dimensions 6

7 Validation measurement 7

 7.1 Measurement Condition 7

 7.2 Head Liquid Measurement 7

 7.3 Measurement Result 8

8 List of Equipment 10



SAR REFERENCE DIPOLE CALIBRATION REPORT

Ref. ACR.60.3.21.MVGB.A

1 INTRODUCTION

This document contains a summary of the requirements set forth by the IEEE 1528, FCC KDBs and CEI/IEC 62209 standards for reference dipoles used for SAR measurement system validations and the measurements that were performed to verify that the product complies with the fore mentioned standards.

2 DEVICE UNDER TEST

Device Under Test	
Device Type	COMOSAR 835 MHz REFERENCE DIPOLE
Manufacturer	MVG
Model	SID835
Serial Number	SN 03/15 DIP0G835-347
Product Condition (new / used)	Used

3 PRODUCT DESCRIPTION

3.1 GENERAL INFORMATION

MVG's COMOSAR Validation Dipoles are built in accordance to the IEEE 1528, FCC KDBs and CEI/IEC 62209 standards. The product is designed for use with the COMOSAR test bench only.



Figure 1 – MVG COMOSAR Validation Dipole



SAR REFERENCE DIPOLE CALIBRATION REPORT

Ref ACR.60.3.21.MVGB.A

4 MEASUREMENT METHOD

The IEEE 1528, FCC KDBs and CEI/IEC 62209 standards provide requirements for reference dipoles used for system validation measurements. The following measurements were performed to verify that the product complies with the fore mentioned standards.

4.1 RETURN LOSS REQUIREMENTS

The dipole used for SAR system validation measurements and checks must have a return loss of -20 dB or better. The return loss measurement shall be performed against a liquid filled flat phantom, with the phantom constructed as outlined in the fore mentioned standards. A direct method is used with a network analyser and its calibration kit, both with a valid ISO17025 calibration.

4.2 MECHANICAL REQUIREMENTS

The IEEE Std. 1528 and CEI/IEC 62209 standards specify the mechanical components and dimensions of the validation dipoles, with the dimension's frequency and phantom shell thickness dependent. The COMOSAR test bench employs a 2 mm phantom shell thickness therefore the dipoles sold for use with the COMOSAR test bench comply with the requirements set forth for a 2 mm phantom shell thickness. A direct method is used with a ISO17025 calibrated caliper.

5 MEASUREMENT UNCERTAINTY

All uncertainties listed below represent an expanded uncertainty expressed at approximately the 95% confidence level using a coverage factor of k=2, traceable to the Internationally Accepted Guides to Measurement Uncertainty.

5.1 RETURN LOSS

The following uncertainties apply to the return loss measurement:

Frequency band	Expanded Uncertainty on Return Loss
400-6000MHz	0.08 LIN

5.2 DIMENSION MEASUREMENT

The following uncertainties apply to the dimension measurements:

Length (mm)	Expanded Uncertainty on Length
0 - 300	0.20 mm
300 - 450	0.44 mm

5.3 VALIDATION MEASUREMENT

The guidelines outlined in the IEEE 1528, FCC KDBs, CENELEC EN50361 and CEI/IEC 62209 standards were followed to generate the measurement uncertainty for validation measurements.

Scan Volume	Expanded Uncertainty



SAR REFERENCE DIPOLE CALIBRATION REPORT

Ref. ACR.60.3.21.MVGB.A

1 g	19 % (SAR)
10 g	19 % (SAR)

6 CALIBRATION MEASUREMENT RESULTS

6.1 RETURN LOSS AND IMPEDANCE

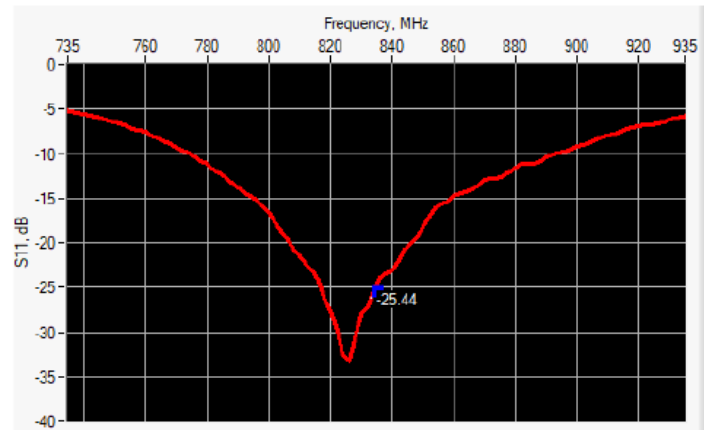

Frequency (MHz)	Return Loss (dB)	Requirement (dB)	Impedance
835	-25.44	-20	54.4 Ω - 2.9 jΩ

6.2 MECHANICAL DIMENSIONS

Frequency MHz	L mm		h mm		d mm	
	required	measured	required	measured	required	measured
300	420.0 ±1 %.		250.0 ±1 %.		6.35 ±1 %.	
450	290.0 ±1 %.		166.7 ±1 %.		6.35 ±1 %.	
750	176.0 ±1 %.		100.0 ±1 %.		6.35 ±1 %.	
835	161.0 ±1 %.	-	89.8 ±1 %.	-	3.6 ±1 %.	-
900	149.0 ±1 %.		83.3 ±1 %.		3.6 ±1 %.	
1450	89.1 ±1 %.		51.7 ±1 %.		3.6 ±1 %.	
1500	80.5 ±1 %.		50.0 ±1 %.		3.6 ±1 %.	
1640	79.0 ±1 %.		45.7 ±1 %.		3.6 ±1 %.	
1750	75.2 ±1 %.		42.9 ±1 %.		3.6 ±1 %.	
1800	72.0 ±1 %.		41.7 ±1 %.		3.6 ±1 %.	
1900	68.0 ±1 %.		39.5 ±1 %.		3.6 ±1 %.	
1950	66.3 ±1 %.		38.5 ±1 %.		3.6 ±1 %.	
2000	64.5 ±1 %.		37.5 ±1 %.		3.6 ±1 %.	
2100	61.0 ±1 %.		35.7 ±1 %.		3.6 ±1 %.	
2300	55.5 ±1 %.		32.6 ±1 %.		3.6 ±1 %.	
2450	51.5 ±1 %.		30.4 ±1 %.		3.6 ±1 %.	



SAR REFERENCE DIPOLE CALIBRATION REPORT

Ref: ACR.60.3.21.MVGB.A

2600	48.5 ±1 %.		28.8 ±1 %.		3.6 ±1 %.	
3000	41.5 ±1 %.		25.0 ±1 %.		3.6 ±1 %.	
3500	37.0±1 %.		26.4 ±1 %.		3.6 ±1 %.	
3700	34.7±1 %.		26.4 ±1 %.		3.6 ±1 %.	

7 VALIDATION MEASUREMENT

The IEEE Std. 1528, FCC KDBs and CEI/IEC 62209 standards state that the system validation measurements must be performed using a reference dipole meeting the fore mentioned return loss and mechanical dimension requirements. The validation measurement must be performed against a liquid filled flat phantom, with the phantom constructed as outlined in the fore mentioned standards. Per the standards, the dipole shall be positioned below the bottom of the phantom, with the dipole length centered and parallel to the longest dimension of the flat phantom, with the top surface of the dipole at the described distance from the bottom surface of the phantom.

7.1 MEASUREMENT CONDITION

Software	OPENSAR V5
Phantom	SN 13/09 SAM68
Probe	SN 41/18 EPG0333
Liquid	Head Liquid Values: eps' : 40.6 sigma : 0.89
Distance between dipole center and liquid	15.0 mm
Area scan resolution	dx=8mm/dy=8mm
Zoon Scan Resolution	dx=8mm/dy=8mm/dz=5mm
Frequency	835835 MHz
Input power	20 dBm
Liquid Temperature	20 +/- 1 °C
Lab Temperature	20 +/- 1 °C
Lab Humidity	30-70 %

7.2 HEAD LIQUID MEASUREMENT

Frequency MHz	Relative permittivity (ε _r)		Conductivity (σ) S/m	
	required	measured	required	measured
300	45.3 ±10 %		0.87 ±10 %	
450	43.5 ±10 %		0.87 ±10 %	
750	41.9 ±10 %		0.89 ±10 %	
835	41.5 ±10 %	40.6	0.90 ±10 %	0.89
900	41.5 ±10 %		0.97 ±10 %	
1450	40.5 ±10 %		1.20 ±10 %	
1500	40.4 ±10 %		1.23 ±10 %	
1640	40.2 ±10 %		1.31 ±10 %	
1750	40.1 ±10 %		1.37 ±10 %	
1800	40.0 ±10 %		1.40 ±10 %	
1900	40.0 ±10 %		1.40 ±10 %	
1950	40.0 ±10 %		1.40 ±10 %	
2000	40.0 ±10 %		1.40 ±10 %	



SAR REFERENCE DIPOLE CALIBRATION REPORT

Ref. ACR.60.3.21.MVGB.A

2100	39.8 ±10 %		1.49 ±10 %	
2300	39.5 ±10 %		1.67 ±10 %	
2450	39.2 ±10 %		1.80 ±10 %	
2600	39.0 ±10 %		1.96 ±10 %	
3000	38.5 ±10 %		2.40 ±10 %	
3500	37.9 ±10 %		2.91 ±10 %	

7.3 MEASUREMENT RESULT

The IEEE Std. 1528 and CEI/IEC 62209 standards state that the system validation measurements should produce the SAR values shown below (for phantom thickness of 2 mm), within the uncertainty for the system validation. All SAR values are normalized to 1 W forward power. In bracket, the measured SAR is given with the used input power.

Frequency MHz	1 g SAR (W/kg/W)		10 g SAR (W/kg/W)	
	required	measured	required	measured
300	2.85		1.94	
450	4.58		3.06	
750	8.49		5.55	
835	9.56	9.84 (0.98)	6.22	6.22 (0.62)
900	10.9		6.99	
1450	29		16	
1500	30.5		16.8	
1640	34.2		18.4	
1750	36.4		19.3	
1800	38.4		20.1	
1900	39.7		20.5	
1950	40.5		20.9	
2000	41.1		21.1	
2100	43.6		21.9	
2300	48.7		23.3	
2450	52.4		24	
2600	55.3		24.6	
3000	63.8		25.7	
3500	67.1		25	



SAR REFERENCE DIPOLE CALIBRATION REPORT

Ref. ACR.60.3.21.MVGB.A

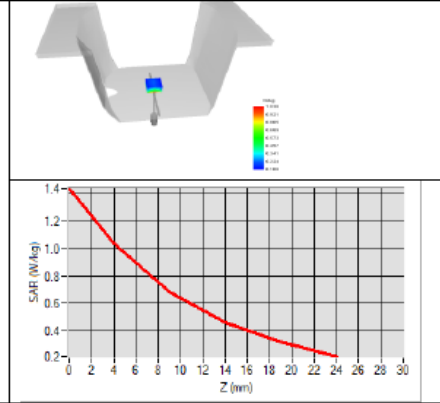
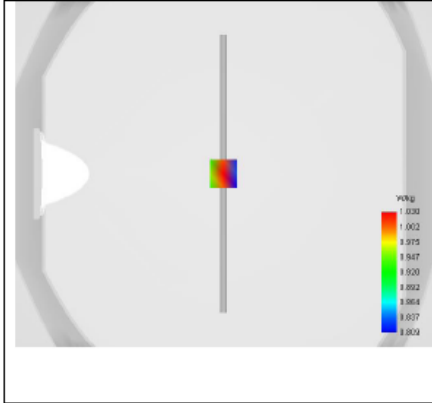



SAR REFERENCE DIPOLE CALIBRATION REPORT

Ref: ACR.60.3.21.MVGB.A

8 LIST OF EQUIPMENT

Equipment Summary Sheet				
Equipment Description	Manufacturer / Model	Identification No.	Current Calibration Date	Next Calibration Date
SAM Phantom	MVG	SN-13/09-SAM68	Validated. No cal required.	Validated. No cal required.
COMOSAR Test Bench	Version 3	NA	Validated. No cal required.	Validated. No cal required.
Network Analyzer	Rohde & Schwarz ZVM	100203	05/2019	05/2022
Network Analyzer – Calibration kit	Rohde & Schwarz ZV-Z235	101223	05/2019	05/2022
Calipers	Mitutoyo	SN 0009732	10/2019	10/2022
Reference Probe	MVG	EPGO333 SN 41/18	05/2020	05/2021
Multimeter	Keithley 2000	1160271	02/2020	02/2023
Signal Generator	Rohde & Schwarz SMB	106589	04/2019	04/2022
Amplifier	Aethercomm	SN 046	Characterized prior to test. No cal required.	Characterized prior to test. No cal required.
Power Meter	NI-USB 5680	170100013	05/2019	05/2022
Directional Coupler	Narda 4216-20	01386	Characterized prior to test. No cal required.	Characterized prior to test. No cal required.
Temperature / Humidity Sensor	Testo 184 H1	44220687	05/2020	05/2023



SAR Reference Dipole Calibration Report

Ref : ACR.60.5.21.MVGB.A

SHENZHEN NTEK TESTING TECHNOLOGY CO., LTD.

BUILDING E, FENDA SCIENCE PARK, SANWEI
COMMUNITY, XIXIANG STREET,
BAO'AN DISTRICT, SHENZHEN GUANGDONG, CHINA

MVG COMOSAR REFERENCE DIPOLE

FREQUENCY: 1800 MHZ

SERIAL NO.: SN 03/15 DIP1G800-349

Calibrated at MVG

Z.I. de la pointe du diable

Technopôle Brest Iroise – 295 avenue Alexis de Rochon

29280 PLOUZANE - FRANCE

Calibration date: 03/01/2021



Accreditations #2-6789 and #2-6814
Scope available on www.cofrac.fr

Summary:

This document presents the method and results from an accredited SAR reference dipole calibration performed at MVG, using the COMOSAR test bench. The test results covered by accreditation are traceable to the International System of Units (SI).



SAR REFERENCE DIPOLE CALIBRATION REPORT

Ref. ACR.60.5.21.MVGB.A

	<i>Name</i>	<i>Function</i>	<i>Date</i>	<i>Signature</i>
<i>Prepared by :</i>	Jérôme Luc	Technical Manager	3/1/2021	<i>JL</i>
<i>Checked by :</i>	Jérôme Luc	Technical Manager	3/1/2021	<i>JL</i>
<i>Approved by :</i>	Yann Toutain	Laboratory Director	3/1/2021	<i>Yann Toutain</i>

2021.03.0
1 13:10:48
+01'00'

	<i>Customer Name</i>
<i>Distribution :</i>	SHENZHEN NTEK TESTING TECHNOLOGY CO., LTD.

<i>Issue</i>	<i>Name</i>	<i>Date</i>	<i>Modifications</i>
A	Jérôme Luc	3/1/2021	Initial release



SAR REFERENCE DIPOLE CALIBRATION REPORT

Ref. ACR.60.5.21.MVGB.A

TABLE OF CONTENTS

1 Introduction..... 4

2 Device Under Test 4

3 Product Description 4

 3.1 General Information 4

4 Measurement Method 5

 4.1 Return Loss Requirements 5

 4.2 Mechanical Requirements 5

5 Measurement Uncertainty..... 5

 5.1 Return Loss 5

 5.2 Dimension Measurement 5

 5.3 Validation Measurement 5

6 Calibration Measurement Results..... 6

 6.1 Return Loss and Impedance 6

 6.2 Mechanical Dimensions 6

7 Validation measurement 7

 7.1 Measurement Condition 7

 7.2 Head Liquid Measurement 7

 7.3 Measurement Result 8

8 List of Equipment 10



SAR REFERENCE DIPOLE CALIBRATION REPORT

Ref: ACR.60.5.21.MVGB.A

1 INTRODUCTION

This document contains a summary of the requirements set forth by the IEEE 1528, FCC KDBs and CEI/IEC 62209 standards for reference dipoles used for SAR measurement system validations and the measurements that were performed to verify that the product complies with the fore mentioned standards.

2 DEVICE UNDER TEST

Device Under Test	
Device Type	COMOSAR 1800 MHz REFERENCE DIPOLE
Manufacturer	MVG
Model	SID1800
Serial Number	SN 03/15 DIP1G800-349
Product Condition (new / used)	Used

3 PRODUCT DESCRIPTION

3.1 GENERAL INFORMATION

MVG’s COMOSAR Validation Dipoles are built in accordance to the IEEE 1528, FCC KDBs and CEI/IEC 62209 standards. The product is designed for use with the COMOSAR test bench only.



Figure 1 – MVG COMOSAR Validation Dipole



SAR REFERENCE DIPOLE CALIBRATION REPORT

Ref: ACR.60.5.21.MVGB.A

4 MEASUREMENT METHOD

The IEEE 1528, FCC KDBs and CEI/IEC 62209 standards provide requirements for reference dipoles used for system validation measurements. The following measurements were performed to verify that the product complies with the fore mentioned standards.

4.1 RETURN LOSS REQUIREMENTS

The dipole used for SAR system validation measurements and checks must have a return loss of -20 dB or better. The return loss measurement shall be performed against a liquid filled flat phantom, with the phantom constructed as outlined in the fore mentioned standards. A direct method is used with a network analyser and its calibration kit, both with a valid ISO17025 calibration.

4.2 MECHANICAL REQUIREMENTS

The IEEE Std. 1528 and CEI/IEC 62209 standards specify the mechanical components and dimensions of the validation dipoles, with the dimension's frequency and phantom shell thickness dependent. The COMOSAR test bench employs a 2 mm phantom shell thickness therefore the dipoles sold for use with the COMOSAR test bench comply with the requirements set forth for a 2 mm phantom shell thickness. A direct method is used with a ISO17025 calibrated caliper.

5 MEASUREMENT UNCERTAINTY

All uncertainties listed below represent an expanded uncertainty expressed at approximately the 95% confidence level using a coverage factor of k=2, traceable to the Internationally Accepted Guides to Measurement Uncertainty.

5.1 RETURN LOSS

The following uncertainties apply to the return loss measurement:

Frequency band	Expanded Uncertainty on Return Loss
400-6000MHz	0.08 LIN

5.2 DIMENSION MEASUREMENT

The following uncertainties apply to the dimension measurements:

Length (mm)	Expanded Uncertainty on Length
0 - 300	0.20 mm
300 - 450	0.44 mm

5.3 VALIDATION MEASUREMENT

The guidelines outlined in the IEEE 1528, FCC KDBs, CENELEC EN50361 and CEI/IEC 62209 standards were followed to generate the measurement uncertainty for validation measurements.

Scan Volume	Expanded Uncertainty



SAR REFERENCE DIPOLE CALIBRATION REPORT

Ref. ACR.60.5.21.MVGB.A

1 g	19 % (SAR)
10 g	19 % (SAR)

6 CALIBRATION MEASUREMENT RESULTS

6.1 RETURN LOSS AND IMPEDANCE

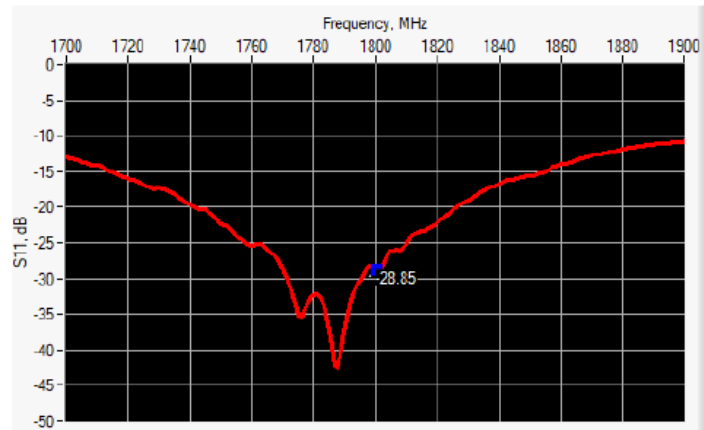

Frequency (MHz)	Return Loss (dB)	Requirement (dB)	Impedance
1800	-28.85	-20	47.9 Ω + 2.9 jΩ

6.2 MECHANICAL DIMENSIONS

Frequency MHz	L mm		h mm		d mm	
	required	measured	required	measured	required	measured
300	420.0 ±1 %.		250.0 ±1 %.		6.35 ±1 %.	
450	290.0 ±1 %.		166.7 ±1 %.		6.35 ±1 %.	
750	176.0 ±1 %.		100.0 ±1 %.		6.35 ±1 %.	
835	161.0 ±1 %.		89.8 ±1 %.		3.6 ±1 %.	
900	149.0 ±1 %.		83.3 ±1 %.		3.6 ±1 %.	
1450	89.1 ±1 %.		51.7 ±1 %.		3.6 ±1 %.	
1500	80.5 ±1 %.		50.0 ±1 %.		3.6 ±1 %.	
1640	79.0 ±1 %.		45.7 ±1 %.		3.6 ±1 %.	
1750	75.2 ±1 %.		42.9 ±1 %.		3.6 ±1 %.	
1800	72.0 ±1 %.	-	41.7 ±1 %.	-	3.6 ±1 %.	-
1900	68.0 ±1 %.		39.5 ±1 %.		3.6 ±1 %.	
1950	66.3 ±1 %.		38.5 ±1 %.		3.6 ±1 %.	
2000	64.5 ±1 %.		37.5 ±1 %.		3.6 ±1 %.	
2100	61.0 ±1 %.		35.7 ±1 %.		3.6 ±1 %.	
2300	55.5 ±1 %.		32.6 ±1 %.		3.6 ±1 %.	
2450	51.5 ±1 %.		30.4 ±1 %.		3.6 ±1 %.	



SAR REFERENCE DIPOLE CALIBRATION REPORT

Ref: ACR.60.5.21.MVGB.A

2600	48.5 ±1 %.		28.8 ±1 %.		3.6 ±1 %.	
3000	41.5 ±1 %.		25.0 ±1 %.		3.6 ±1 %.	
3500	37.0±1 %.		26.4 ±1 %.		3.6 ±1 %.	
3700	34.7±1 %.		26.4 ±1 %.		3.6 ±1 %.	

7 VALIDATION MEASUREMENT

The IEEE Std. 1528, FCC KDBs and CEI/IEC 62209 standards state that the system validation measurements must be performed using a reference dipole meeting the fore mentioned return loss and mechanical dimension requirements. The validation measurement must be performed against a liquid filled flat phantom, with the phantom constructed as outlined in the fore mentioned standards. Per the standards, the dipole shall be positioned below the bottom of the phantom, with the dipole length centered and parallel to the longest dimension of the flat phantom, with the top surface of the dipole at the described distance from the bottom surface of the phantom.

7.1 MEASUREMENT CONDITION

Software	OPENSAR V5
Phantom	SN 13/09 SAM68
Probe	SN 41/18 EPG0333
Liquid	Head Liquid Values: eps' : 43.7 sigma : 1.34
Distance between dipole center and liquid	10.0 mm
Area scan resolution	dx=8mm/dy=8mm
Zoon Scan Resolution	dx=8mm/dy=8mm/dz=5mm
Frequency	18001800 MHz
Input power	20 dBm
Liquid Temperature	20 +/- 1 °C
Lab Temperature	20 +/- 1 °C
Lab Humidity	30-70 %

7.2 HEAD LIQUID MEASUREMENT

Frequency MHz	Relative permittivity (ε _r)		Conductivity (σ) S/m	
	required	measured	required	measured
300	45.3 ±10 %		0.87 ±10 %	
450	43.5 ±10 %		0.87 ±10 %	
750	41.9 ±10 %		0.89 ±10 %	
835	41.5 ±10 %		0.90 ±10 %	
900	41.5 ±10 %		0.97 ±10 %	
1450	40.5 ±10 %		1.20 ±10 %	
1500	40.4 ±10 %		1.23 ±10 %	
1640	40.2 ±10 %		1.31 ±10 %	
1750	40.1 ±10 %		1.37 ±10 %	
1800	40.0 ±10 %	43.7	1.40 ±10 %	1.34
1900	40.0 ±10 %		1.40 ±10 %	
1950	40.0 ±10 %		1.40 ±10 %	
2000	40.0 ±10 %		1.40 ±10 %	



SAR REFERENCE DIPOLE CALIBRATION REPORT

Ref. ACR.60.5.21.MVGB.A

2100	39.8 ±10 %		1.49 ±10 %	
2300	39.5 ±10 %		1.67 ±10 %	
2450	39.2 ±10 %		1.80 ±10 %	
2600	39.0 ±10 %		1.96 ±10 %	
3000	38.5 ±10 %		2.40 ±10 %	
3500	37.9 ±10 %		2.91 ±10 %	

7.3 MEASUREMENT RESULT

The IEEE Std. 1528 and CEI/IEC 62209 standards state that the system validation measurements should produce the SAR values shown below (for phantom thickness of 2 mm), within the uncertainty for the system validation. All SAR values are normalized to 1 W forward power. In bracket, the measured SAR is given with the used input power.

Frequency MHz	1 g SAR (W/kg/W)		10 g SAR (W/kg/W)	
	required	measured	required	measured
300	2.85		1.94	
450	4.58		3.06	
750	8.49		5.55	
835	9.56		6.22	
900	10.9		6.99	
1450	29		16	
1500	30.5		16.8	
1640	34.2		18.4	
1750	36.4		19.3	
1800	38.4	37.96 (3.80)	20.1	19.81 (1.98)
1900	39.7		20.5	
1950	40.5		20.9	
2000	41.1		21.1	
2100	43.6		21.9	
2300	48.7		23.3	
2450	52.4		24	
2600	55.3		24.6	
3000	63.8		25.7	
3500	67.1		25	



SAR REFERENCE DIPOLE CALIBRATION REPORT

Ref. ACR.60.5.21.MVGB.A

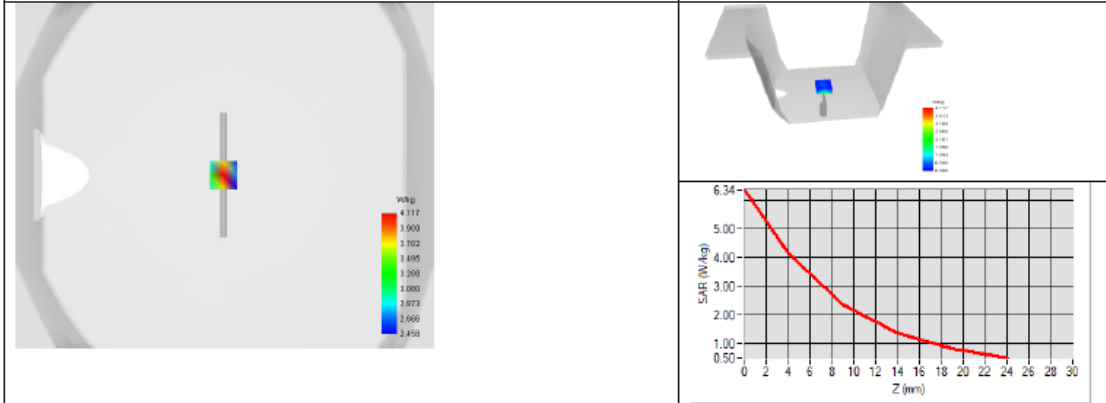



SAR REFERENCE DIPOLE CALIBRATION REPORT

Ref. ACR.60.5.21.MVGB.A

8 LIST OF EQUIPMENT

Equipment Summary Sheet				
Equipment Description	Manufacturer / Model	Identification No.	Current Calibration Date	Next Calibration Date
SAM Phantom	MVG	SN-13/09-SAM68	Validated. No cal required.	Validated. No cal required.
COMOSAR Test Bench	Version 3	NA	Validated. No cal required.	Validated. No cal required.
Network Analyzer	Rohde & Schwarz ZVM	100203	05/2019	05/2022
Network Analyzer – Calibration kit	Rohde & Schwarz ZV-Z235	101223	05/2019	05/2022
Calipers	Mitutoyo	SN 0009732	10/2019	10/2022
Reference Probe	MVG	EPGO333 SN 41/18	05/2020	05/2021
Multimeter	Keithley 2000	1160271	02/2020	02/2023
Signal Generator	Rohde & Schwarz SMB	106589	04/2019	04/2022
Amplifier	Aethercomm	SN 046	Characterized prior to test. No cal required.	Characterized prior to test. No cal required.
Power Meter	NI-USB 5680	170100013	05/2019	05/2022
Directional Coupler	Narda 4216-20	01386	Characterized prior to test. No cal required.	Characterized prior to test. No cal required.
Temperature / Humidity Sensor	Testo 184 H1	44220687	05/2020	05/2023



SAR Reference Dipole Calibration Report

Ref : ACR.60.6.21.MVGB.A

SHENZHEN NTEK TESTING TECHNOLOGY CO., LTD.

BUILDING E, FENDA SCIENCE PARK, SANWEI
COMMUNITY, XIXIANG STREET,
BAO'AN DISTRICT, SHENZHEN GUANGDONG, CHINA

MVG COMOSAR REFERENCE DIPOLE

FREQUENCY: 1900 MHZ

SERIAL NO.: SN 03/15 DIP1G900-350

Calibrated at MVG

Z.I. de la pointe du diable

Technopôle Brest Iroise – 295 avenue Alexis de Rochon
29280 PLOUZANE - FRANCE

Calibration date: 03/01/2021



Accreditations #2-6789 and #2-6814
Scope available on www.cofrac.fr

Summary:

This document presents the method and results from an accredited SAR reference dipole calibration performed at MVG, using the COMOSAR test bench. The test results covered by accreditation are traceable to the International System of Units (SI).



SAR REFERENCE DIPOLE CALIBRATION REPORT

Ref. ACR.60.6.21.MVGB.A

	<i>Name</i>	<i>Function</i>	<i>Date</i>	<i>Signature</i>
<i>Prepared by :</i>	Jérôme Luc	Technical Manager	3/1/2021	<i>JL</i>
<i>Checked by :</i>	Jérôme Luc	Technical Manager	3/1/2021	<i>JL</i>
<i>Approved by :</i>	Yann Toutain	Laboratory Director	3/1/2021	<i>Yann Toutain</i>

Mode d'emploi
2021.03.0
1 13:11:42
+01'00'

PHILIPS

	<i>Customer Name</i>
<i>Distribution :</i>	SHENZHEN NTEK TESTING TECHNOLOGY CO., LTD.

<i>Issue</i>	<i>Name</i>	<i>Date</i>	<i>Modifications</i>
A	Jérôme Luc	3/1/2021	Initial release



SAR REFERENCE DIPOLE CALIBRATION REPORT

Ref: ACR.60.6.21.MVGB.A

TABLE OF CONTENTS

1	Introduction.....	4
2	Device Under Test	4
3	Product Description	4
3.1	General Information	4
4	Measurement Method	5
4.1	Return Loss Requirements	5
4.2	Mechanical Requirements	5
5	Measurement Uncertainty.....	5
5.1	Return Loss	5
5.2	Dimension Measurement	5
5.3	Validation Measurement	5
6	Calibration Measurement Results.....	6
6.1	Return Loss and Impedance	6
6.2	Mechanical Dimensions	6
7	Validation measurement	7
7.1	Measurement Condition	7
7.2	Head Liquid Measurement	7
7.3	Measurement Result	8
8	List of Equipment	10



SAR REFERENCE DIPOLE CALIBRATION REPORT

Ref: ACR.60.6.21.MVGB.A

1 INTRODUCTION

This document contains a summary of the requirements set forth by the IEEE 1528, FCC KDBs and CEI/IEC 62209 standards for reference dipoles used for SAR measurement system validations and the measurements that were performed to verify that the product complies with the fore mentioned standards.

2 DEVICE UNDER TEST

Device Under Test	
Device Type	COMOSAR 1900 MHz REFERENCE DIPOLE
Manufacturer	MVG
Model	SID1900
Serial Number	SN 03/15 DIP1G900-350
Product Condition (new / used)	Used

3 PRODUCT DESCRIPTION

3.1 GENERAL INFORMATION

MVG’s COMOSAR Validation Dipoles are built in accordance to the IEEE 1528, FCC KDBs and CEI/IEC 62209 standards. The product is designed for use with the COMOSAR test bench only.



Figure 1 – MVG COMOSAR Validation Dipole



SAR REFERENCE DIPOLE CALIBRATION REPORT

Ref. ACR.60.6.21.MVGB.A

4 MEASUREMENT METHOD

The IEEE 1528, FCC KDBs and CEI/IEC 62209 standards provide requirements for reference dipoles used for system validation measurements. The following measurements were performed to verify that the product complies with the fore mentioned standards.

4.1 RETURN LOSS REQUIREMENTS

The dipole used for SAR system validation measurements and checks must have a return loss of -20 dB or better. The return loss measurement shall be performed against a liquid filled flat phantom, with the phantom constructed as outlined in the fore mentioned standards. A direct method is used with a network analyser and its calibration kit, both with a valid ISO17025 calibration.

4.2 MECHANICAL REQUIREMENTS

The IEEE Std. 1528 and CEI/IEC 62209 standards specify the mechanical components and dimensions of the validation dipoles, with the dimension's frequency and phantom shell thickness dependent. The COMOSAR test bench employs a 2 mm phantom shell thickness therefore the dipoles sold for use with the COMOSAR test bench comply with the requirements set forth for a 2 mm phantom shell thickness. A direct method is used with a ISO17025 calibrated caliper.

5 MEASUREMENT UNCERTAINTY

All uncertainties listed below represent an expanded uncertainty expressed at approximately the 95% confidence level using a coverage factor of k=2, traceable to the Internationally Accepted Guides to Measurement Uncertainty.

5.1 RETURN LOSS

The following uncertainties apply to the return loss measurement:

Frequency band	Expanded Uncertainty on Return Loss
400-6000MHz	0.08 LIN

5.2 DIMENSION MEASUREMENT

The following uncertainties apply to the dimension measurements:

Length (mm)	Expanded Uncertainty on Length
0 - 300	0.20 mm
300 - 450	0.44 mm

5.3 VALIDATION MEASUREMENT

The guidelines outlined in the IEEE 1528, FCC KDBs, CENELEC EN50361 and CEI/IEC 62209 standards were followed to generate the measurement uncertainty for validation measurements.

Scan Volume	Expanded Uncertainty



SAR REFERENCE DIPOLE CALIBRATION REPORT

Ref: ACR.60.6.21.MVGB.A

1 g	19 % (SAR)
10 g	19 % (SAR)

6 CALIBRATION MEASUREMENT RESULTS

6.1 RETURN LOSS AND IMPEDANCE

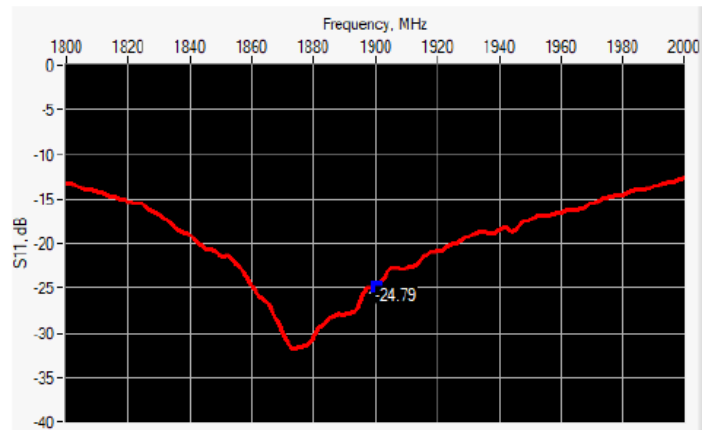

Frequency (MHz)	Return Loss (dB)	Requirement (dB)	Impedance
1900	-24.79	-20	50.8 Ω + 5.7 jΩ

6.2 MECHANICAL DIMENSIONS

Frequency MHz	L mm		h mm		d mm	
	required	measured	required	measured	required	measured
300	420.0 ±1 %.		250.0 ±1 %.		6.35 ±1 %.	
450	290.0 ±1 %.		166.7 ±1 %.		6.35 ±1 %.	
750	176.0 ±1 %.		100.0 ±1 %.		6.35 ±1 %.	
835	161.0 ±1 %.		89.8 ±1 %.		3.6 ±1 %.	
900	149.0 ±1 %.		83.3 ±1 %.		3.6 ±1 %.	
1450	89.1 ±1 %.		51.7 ±1 %.		3.6 ±1 %.	
1500	80.5 ±1 %.		50.0 ±1 %.		3.6 ±1 %.	
1640	79.0 ±1 %.		45.7 ±1 %.		3.6 ±1 %.	
1750	75.2 ±1 %.		42.9 ±1 %.		3.6 ±1 %.	
1800	72.0 ±1 %.		41.7 ±1 %.		3.6 ±1 %.	
1900	68.0 ±1 %.	-	39.5 ±1 %.	-	3.6 ±1 %.	-
1950	66.3 ±1 %.		38.5 ±1 %.		3.6 ±1 %.	
2000	64.5 ±1 %.		37.5 ±1 %.		3.6 ±1 %.	
2100	61.0 ±1 %.		35.7 ±1 %.		3.6 ±1 %.	
2300	55.5 ±1 %.		32.6 ±1 %.		3.6 ±1 %.	
2450	51.5 ±1 %.		30.4 ±1 %.		3.6 ±1 %.	



SAR REFERENCE DIPOLE CALIBRATION REPORT

Ref: ACR.60.6.21.MVGB.A

2600	48.5 ±1 %.		28.8 ±1 %.		3.6 ±1 %.	
3000	41.5 ±1 %.		25.0 ±1 %.		3.6 ±1 %.	
3500	37.0±1 %.		26.4 ±1 %.		3.6 ±1 %.	
3700	34.7±1 %.		26.4 ±1 %.		3.6 ±1 %.	

7 VALIDATION MEASUREMENT

The IEEE Std. 1528, FCC KDBs and CEI/IEC 62209 standards state that the system validation measurements must be performed using a reference dipole meeting the fore mentioned return loss and mechanical dimension requirements. The validation measurement must be performed against a liquid filled flat phantom, with the phantom constructed as outlined in the fore mentioned standards. Per the standards, the dipole shall be positioned below the bottom of the phantom, with the dipole length centered and parallel to the longest dimension of the flat phantom, with the top surface of the dipole at the described distance from the bottom surface of the phantom.

7.1 MEASUREMENT CONDITION

Software	OPENSAR V5
Phantom	SN 13/09 SAM68
Probe	SN 41/18 EPGO333
Liquid	Head Liquid Values: eps' : 43.3 sigma : 1.41
Distance between dipole center and liquid	10.0 mm
Area scan resolution	dx=8mm/dy=8mm
Zoon Scan Resolution	dx=8mm/dy=8mm/dz=5mm
Frequency	19001900 MHz
Input power	20 dBm
Liquid Temperature	20 +/- 1 °C
Lab Temperature	20 +/- 1 °C
Lab Humidity	30-70 %

7.2 HEAD LIQUID MEASUREMENT

Frequency MHz	Relative permittivity (ε _r)		Conductivity (σ) S/m	
	required	measured	required	measured
300	45.3 ±10 %		0.87 ±10 %	
450	43.5 ±10 %		0.87 ±10 %	
750	41.9 ±10 %		0.89 ±10 %	
835	41.5 ±10 %		0.90 ±10 %	
900	41.5 ±10 %		0.97 ±10 %	
1450	40.5 ±10 %		1.20 ±10 %	
1500	40.4 ±10 %		1.23 ±10 %	
1640	40.2 ±10 %		1.31 ±10 %	
1750	40.1 ±10 %		1.37 ±10 %	
1800	40.0 ±10 %		1.40 ±10 %	
1900	40.0 ±10 %	43.3	1.40 ±10 %	1.41
1950	40.0 ±10 %		1.40 ±10 %	
2000	40.0 ±10 %		1.40 ±10 %	



SAR REFERENCE DIPOLE CALIBRATION REPORT

Ref. ACR.60.6.21.MVGB.A

2100	39.8 ±10 %		1.49 ±10 %	
2300	39.5 ±10 %		1.67 ±10 %	
2450	39.2 ±10 %		1.80 ±10 %	
2600	39.0 ±10 %		1.96 ±10 %	
3000	38.5 ±10 %		2.40 ±10 %	
3500	37.9 ±10 %		2.91 ±10 %	

7.3 MEASUREMENT RESULT

The IEEE Std. 1528 and CEI/IEC 62209 standards state that the system validation measurements should produce the SAR values shown below (for phantom thickness of 2 mm), within the uncertainty for the system validation. All SAR values are normalized to 1 W forward power. In bracket, the measured SAR is given with the used input power.

Frequency MHz	1 g SAR (W/kg/W)		10 g SAR (W/kg/W)	
	required	measured	required	measured
300	2.85		1.94	
450	4.58		3.06	
750	8.49		5.55	
835	9.56		6.22	
900	10.9		6.99	
1450	29		16	
1500	30.5		16.8	
1640	34.2		18.4	
1750	36.4		19.3	
1800	38.4		20.1	
1900	39.7	40.37 (4.04)	20.5	20.48 (2.05)
1950	40.5		20.9	
2000	41.1		21.1	
2100	43.6		21.9	
2300	48.7		23.3	
2450	52.4		24	
2600	55.3		24.6	
3000	63.8		25.7	
3500	67.1		25	



SAR REFERENCE DIPOLE CALIBRATION REPORT

Ref. ACR.60.6.21.MVGB.A

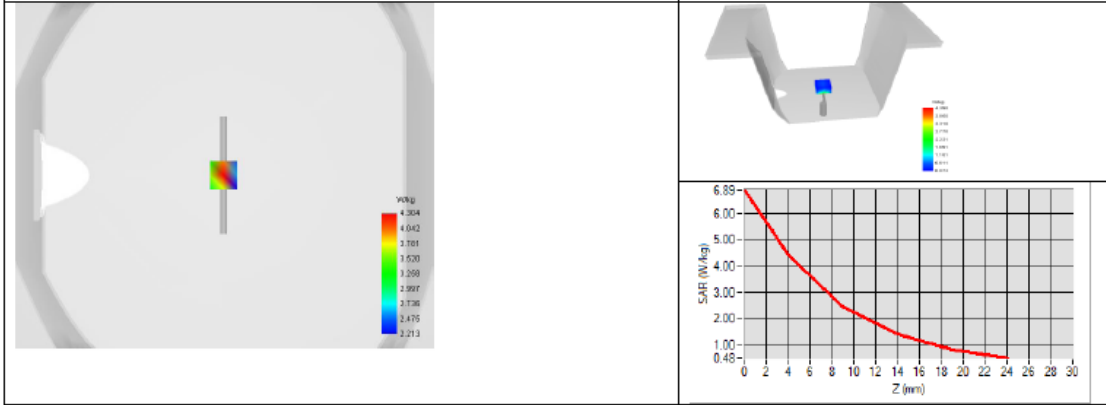



SAR REFERENCE DIPOLE CALIBRATION REPORT

Ref. ACR.60.6.21.MVGB.A

8 LIST OF EQUIPMENT

Equipment Summary Sheet				
Equipment Description	Manufacturer / Model	Identification No.	Current Calibration Date	Next Calibration Date
SAM Phantom	MVG	SN-13/09-SAM68	Validated. No cal required.	Validated. No cal required.
COMOSAR Test Bench	Version 3	NA	Validated. No cal required.	Validated. No cal required.
Network Analyzer	Rohde & Schwarz ZVM	100203	05/2019	05/2022
Network Analyzer – Calibration kit	Rohde & Schwarz ZV-Z235	101223	05/2019	05/2022
Calipers	Mitutoyo	SN 0009732	10/2019	10/2022
Reference Probe	MVG	EPGO333 SN 41/18	05/2020	05/2021
Multimeter	Keithley 2000	1160271	02/2020	02/2023
Signal Generator	Rohde & Schwarz SMB	106589	04/2019	04/2022
Amplifier	Aethercomm	SN 046	Characterized prior to test. No cal required.	Characterized prior to test. No cal required.
Power Meter	NI-USB 5680	170100013	05/2019	05/2022
Directional Coupler	Narda 4216-20	01386	Characterized prior to test. No cal required.	Characterized prior to test. No cal required.
Temperature / Humidity Sensor	Testo 184 H1	44220687	05/2020	05/2023



SAR Reference Dipole Calibration Report

Ref : ACR.60.8.21.MVGB.A

SHENZHEN NTEK TESTING TECHNOLOGY CO., LTD.

BUILDING E, FENDA SCIENCE PARK, SANWEI
COMMUNITY, XIXIANG STREET,
BAO'AN DISTRICT, SHENZHEN GUANGDONG, CHINA

MVG COMOSAR REFERENCE DIPOLE

FREQUENCY: 2450 MHZ

SERIAL NO.: SN 03/15 DIP2G450-352

Calibrated at MVG

Z.I. de la pointe du diable

Technopôle Brest Iroise – 295 avenue Alexis de Rochon

29280 PLOUZANE - FRANCE

Calibration date: 03/01/2021



Accreditations #2-6789 and #2-6814
Scope available on www.cofrac.fr

Summary:

This document presents the method and results from an accredited SAR reference dipole calibration performed at MVG, using the COMOSAR test bench. The test results covered by accreditation are traceable to the International System of Units (SI).



SAR REFERENCE DIPOLE CALIBRATION REPORT

Ref: ACR.60.8.21.MVGB.A

	Name	Function	Date	Signature
Prepared by :	Jérôme LUC	Technical Manager	3/1/2021	<i>JLS</i>
Checked by :	Jérôme LUC	Technical Manager	3/1/2021	<i>JLS</i>
Approved by :	Yann Toutain	Laboratory Director	3/1/2021	<i>Yann Toutain</i>

2021.03.01
13:13:40
+01'00'

	Customer Name
Distribution :	SHENZHEN NTEK TESTING TECHNOLOGY CO., LTD.

Issue	Name	Date	Modifications
A	Jérôme LE GALL	3/1/2021	Initial release



SAR REFERENCE DIPOLE CALIBRATION REPORT

Ref. ACR.60.8.21.MVGB.A

TABLE OF CONTENTS

1	Introduction.....	4
2	Device Under Test	4
3	Product Description	4
3.1	General Information	4
4	Measurement Method	5
4.1	Return Loss Requirements	5
4.2	Mechanical Requirements	5
5	Measurement Uncertainty.....	5
5.1	Return Loss	5
5.2	Dimension Measurement	5
5.3	Validation Measurement	5
6	Calibration Measurement Results.....	6
6.1	Return Loss and Impedance	6
6.2	Mechanical Dimensions	6
7	Validation measurement	7
7.1	Measurement Condition	7
7.2	Head Liquid Measurement	7
7.3	Measurement Result	8
8	List of Equipment	10



SAR REFERENCE DIPOLE CALIBRATION REPORT

Ref. ACR.60.8.21.MVGB.A

1 INTRODUCTION

This document contains a summary of the requirements set forth by the IEEE 1528, FCC KDBs and CEI/IEC 62209 standards for reference dipoles used for SAR measurement system validations and the measurements that were performed to verify that the product complies with the fore mentioned standards.

2 DEVICE UNDER TEST

Device Under Test	
Device Type	COMOSAR 2450 MHz REFERENCE DIPOLE
Manufacturer	MVG
Model	SID2450
Serial Number	SN 03/15 DIP2G450-352
Product Condition (new / used)	Used

3 PRODUCT DESCRIPTION

3.1 GENERAL INFORMATION

MVG’s COMOSAR Validation Dipoles are built in accordance to the IEEE 1528, FCC KDBs and CEI/IEC 62209 standards. The product is designed for use with the COMOSAR test bench only.



Figure 1 – MVG COMOSAR Validation Dipole



SAR REFERENCE DIPOLE CALIBRATION REPORT

Ref. ACR.60.8.21.MVGB.A

4 MEASUREMENT METHOD

The IEEE 1528, FCC KDBs and CEI/IEC 62209 standards provide requirements for reference dipoles used for system validation measurements. The following measurements were performed to verify that the product complies with the fore mentioned standards.

4.1 RETURN LOSS REQUIREMENTS

The dipole used for SAR system validation measurements and checks must have a return loss of -20 dB or better. The return loss measurement shall be performed against a liquid filled flat phantom, with the phantom constructed as outlined in the fore mentioned standards. A direct method is used with a network analyser and its calibration kit, both with a valid ISO17025 calibration.

4.2 MECHANICAL REQUIREMENTS

The IEEE Std. 1528 and CEI/IEC 62209 standards specify the mechanical components and dimensions of the validation dipoles, with the dimension's frequency and phantom shell thickness dependent. The COMOSAR test bench employs a 2 mm phantom shell thickness therefore the dipoles sold for use with the COMOSAR test bench comply with the requirements set forth for a 2 mm phantom shell thickness. A direct method is used with a ISO17025 calibrated caliper.

5 MEASUREMENT UNCERTAINTY

All uncertainties listed below represent an expanded uncertainty expressed at approximately the 95% confidence level using a coverage factor of k=2, traceable to the Internationally Accepted Guides to Measurement Uncertainty.

5.1 RETURN LOSS

The following uncertainties apply to the return loss measurement:

Frequency band	Expanded Uncertainty on Return Loss
400-6000MHz	0.08 LIN

5.2 DIMENSION MEASUREMENT

The following uncertainties apply to the dimension measurements:

Length (mm)	Expanded Uncertainty on Length
0 - 300	0.20 mm
300 - 450	0.44 mm

5.3 VALIDATION MEASUREMENT

The guidelines outlined in the IEEE 1528, FCC KDBs, CENELEC EN50361 and CEI/IEC 62209 standards were followed to generate the measurement uncertainty for validation measurements.

Scan Volume	Expanded Uncertainty



SAR REFERENCE DIPOLE CALIBRATION REPORT

Ref: ACR.60.8.21.MVGB.A

1 g	19 % (SAR)
10 g	19 % (SAR)

6 CALIBRATION MEASUREMENT RESULTS

6.1 RETURN LOSS AND IMPEDANCE

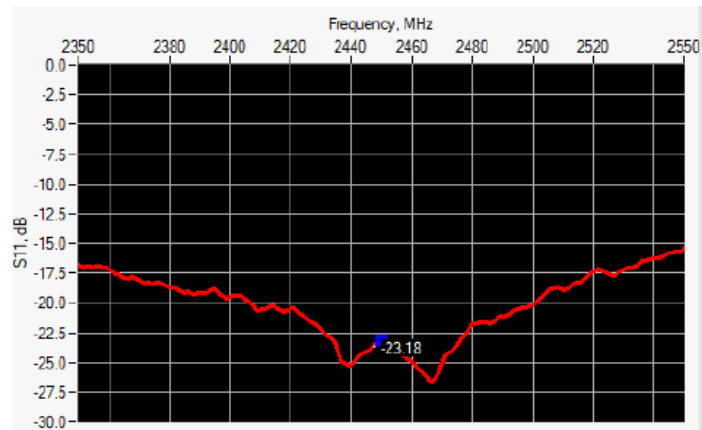

Frequency (MHz)	Return Loss (dB)	Requirement (dB)	Impedance
2450	-23.18	-20	56.3 Ω - 2.9 jΩ

6.2 MECHANICAL DIMENSIONS

Frequency MHz	L mm		h mm		d mm	
	required	measured	required	measured	required	measured
300	420.0 ±1 %.		250.0 ±1 %.		6.35 ±1 %.	
450	290.0 ±1 %.		166.7 ±1 %.		6.35 ±1 %.	
750	176.0 ±1 %.		100.0 ±1 %.		6.35 ±1 %.	
835	161.0 ±1 %.		89.8 ±1 %.		3.6 ±1 %.	
900	149.0 ±1 %.		83.3 ±1 %.		3.6 ±1 %.	
1450	89.1 ±1 %.		51.7 ±1 %.		3.6 ±1 %.	
1500	80.5 ±1 %.		50.0 ±1 %.		3.6 ±1 %.	
1640	79.0 ±1 %.		45.7 ±1 %.		3.6 ±1 %.	
1750	75.2 ±1 %.		42.9 ±1 %.		3.6 ±1 %.	
1800	72.0 ±1 %.		41.7 ±1 %.		3.6 ±1 %.	
1900	68.0 ±1 %.		39.5 ±1 %.		3.6 ±1 %.	
1950	66.3 ±1 %.		38.5 ±1 %.		3.6 ±1 %.	
2000	64.5 ±1 %.		37.5 ±1 %.		3.6 ±1 %.	
2100	61.0 ±1 %.		35.7 ±1 %.		3.6 ±1 %.	
2300	55.5 ±1 %.		32.6 ±1 %.		3.6 ±1 %.	
2450	51.5 ±1 %.	-	30.4 ±1 %.	-	3.6 ±1 %.	-



SAR REFERENCE DIPOLE CALIBRATION REPORT

Ref: ACR.60.8.21.MVGB.A

2600	48.5 ±1 %.		28.8 ±1 %.		3.6 ±1 %.	
3000	41.5 ±1 %.		25.0 ±1 %.		3.6 ±1 %.	
3500	37.0±1 %.		26.4 ±1 %.		3.6 ±1 %.	
3700	34.7±1 %.		26.4 ±1 %.		3.6 ±1 %.	

7 VALIDATION MEASUREMENT

The IEEE Std. 1528, FCC KDBs and CEI/IEC 62209 standards state that the system validation measurements must be performed using a reference dipole meeting the fore mentioned return loss and mechanical dimension requirements. The validation measurement must be performed against a liquid filled flat phantom, with the phantom constructed as outlined in the fore mentioned standards. Per the standards, the dipole shall be positioned below the bottom of the phantom, with the dipole length centered and parallel to the longest dimension of the flat phantom, with the top surface of the dipole at the described distance from the bottom surface of the phantom.

7.1 MEASUREMENT CONDITION

Software	OPENSAR V5
Phantom	SN 13/09 SAM68
Probe	SN 41/18 EPG0333
Liquid	Head Liquid Values: eps' : 41.9 sigma : 1.88
Distance between dipole center and liquid	10.0 mm
Area scan resolution	dx=8mm/dy=8mm
Zoon Scan Resolution	dx=5mm/dy=5mm/dz=5mm
Frequency	24502450 MHz
Input power	20 dBm
Liquid Temperature	20 +/- 1 °C
Lab Temperature	20 +/- 1 °C
Lab Humidity	30-70 %

7.2 HEAD LIQUID MEASUREMENT

Frequency MHz	Relative permittivity (ε _r)		Conductivity (σ) S/m	
	required	measured	required	measured
300	45.3 ±10 %		0.87 ±10 %	
450	43.5 ±10 %		0.87 ±10 %	
750	41.9 ±10 %		0.89 ±10 %	
835	41.5 ±10 %		0.90 ±10 %	
900	41.5 ±10 %		0.97 ±10 %	
1450	40.5 ±10 %		1.20 ±10 %	
1500	40.4 ±10 %		1.23 ±10 %	
1640	40.2 ±10 %		1.31 ±10 %	
1750	40.1 ±10 %		1.37 ±10 %	
1800	40.0 ±10 %		1.40 ±10 %	
1900	40.0 ±10 %		1.40 ±10 %	
1950	40.0 ±10 %		1.40 ±10 %	
2000	40.0 ±10 %		1.40 ±10 %	



SAR REFERENCE DIPOLE CALIBRATION REPORT

Ref. ACR.60.8.21.MVGB.A

2100	39.8 ±10 %		1.49 ±10 %	
2300	39.5 ±10 %		1.67 ±10 %	
2450	39.2 ±10 %	41.9	1.80 ±10 %	1.88
2600	39.0 ±10 %		1.96 ±10 %	
3000	38.5 ±10 %		2.40 ±10 %	
3500	37.9 ±10 %		2.91 ±10 %	

7.3 MEASUREMENT RESULT

The IEEE Std. 1528 and CEI/IEC 62209 standards state that the system validation measurements should produce the SAR values shown below (for phantom thickness of 2 mm), within the uncertainty for the system validation. All SAR values are normalized to 1 W forward power. In bracket, the measured SAR is given with the used input power.

Frequency MHz	1 g SAR (W/kg/W)		10 g SAR (W/kg/W)	
	required	measured	required	measured
300	2.85		1.94	
450	4.58		3.06	
750	8.49		5.55	
835	9.56		6.22	
900	10.9		6.99	
1450	29		16	
1500	30.5		16.8	
1640	34.2		18.4	
1750	36.4		19.3	
1800	38.4		20.1	
1900	39.7		20.5	
1950	40.5		20.9	
2000	41.1		21.1	
2100	43.6		21.9	
2300	48.7		23.3	
2450	52.4	53.69 (5.37)	24	23.94 (2.39)
2600	55.3		24.6	
3000	63.8		25.7	
3500	67.1		25	



SAR REFERENCE DIPOLE CALIBRATION REPORT

Ref. ACR.60.8.21.MVGB.A

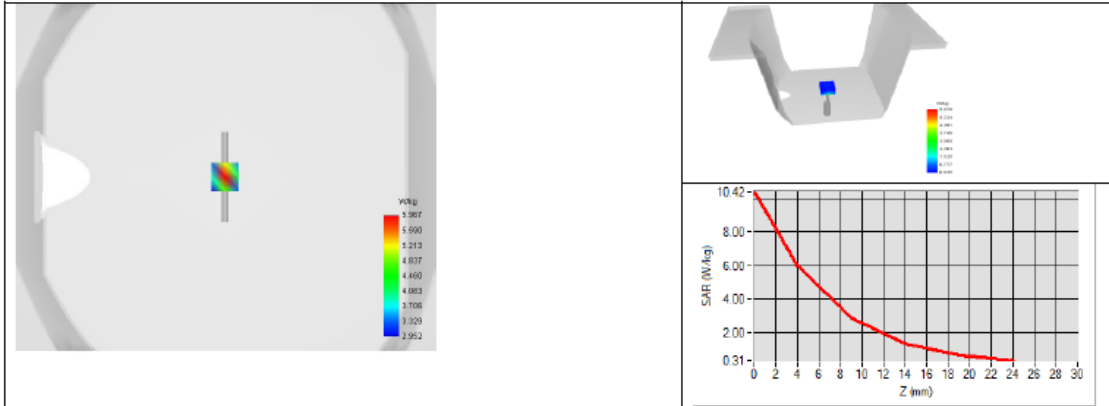



SAR REFERENCE DIPOLE CALIBRATION REPORT

Ref. ACR.60.8.21.MVGB.A

8 LIST OF EQUIPMENT

Equipment Summary Sheet				
Equipment Description	Manufacturer / Model	Identification No.	Current Calibration Date	Next Calibration Date
SAM Phantom	MVG	SN-13/09-SAM68	Validated. No cal required.	Validated. No cal required.
COMOSAR Test Bench	Version 3	NA	Validated. No cal required.	Validated. No cal required.
Network Analyzer	Rohde & Schwarz ZVM	100203	05/2019	05/2022
Network Analyzer – Calibration kit	Rohde & Schwarz ZV-Z235	101223	05/2019	05/2022
Calipers	Mitutoyo	SN 0009732	10/2019	10/2022
Reference Probe	MVG	EPGO333 SN 41/18	05/2020	05/2021
Multimeter	Keithley 2000	1160271	02/2020	02/2023
Signal Generator	Rohde & Schwarz SMB	106589	04/2019	04/2022
Amplifier	Aethercomm	SN 046	Characterized prior to test. No cal required.	Characterized prior to test. No cal required.
Power Meter	NI-USB 5680	170100013	05/2019	05/2022
Directional Coupler	Narda 4216-20	01386	Characterized prior to test. No cal required.	Characterized prior to test. No cal required.
Temperature / Humidity Sensor	Testo 184 H1	44220687	05/2020	05/2023



SAR Reference Dipole Calibration Report

Ref : ACR.60.9.21.MVGB.A

SHENZHEN NTEK TESTING TECHNOLOGY CO., LTD.

BUILDING E, FENDA SCIENCE PARK, SANWEI
COMMUNITY, XIXIANG STREET,
BAO'AN DISTRICT, SHENZHEN GUANGDONG, CHINA

MVG COMOSAR REFERENCE DIPOLE

FREQUENCY: 2600 MHZ

SERIAL NO.: SN 03/15 DIP2G600-356

Calibrated at MVG

Z.I. de la pointe du diable

Technopôle Brest Iroise – 295 avenue Alexis de Rochon

29280 PLOUZANE - FRANCE

Calibration date: 03/01/2021



Accreditations #2-6789 and #2-6814
Scope available on www.cofrac.fr

Summary:

This document presents the method and results from an accredited SAR reference dipole calibration performed at MVG, using the COMOSAR test bench. The test results covered by accreditation are traceable to the International System of Units (SI).



SAR REFERENCE DIPOLE CALIBRATION REPORT

Ref. ACR.60.9.21.MVGB.A

	<i>Name</i>	<i>Function</i>	<i>Date</i>	<i>Signature</i>
<i>Prepared by :</i>	Jérôme Luc	Technical Manager	3/1/2021	<i>JLS</i>
<i>Checked by :</i>	Jérôme Luc	Technical Manager	3/1/2021	<i>JLS</i>
<i>Approved by :</i>	Yann Toutain	Laboratory Director	3/1/2021	<i>Yann Toutain</i>

2021.03.01
13:14:51
+01'00'

	<i>Customer Name</i>
<i>Distribution :</i>	SHENZHEN NTEK TESTING TECHNOLOGY CO., LTD.

<i>Issue</i>	<i>Name</i>	<i>Date</i>	<i>Modifications</i>
A	Jérôme Luc	3/1/2021	Initial release



SAR REFERENCE DIPOLE CALIBRATION REPORT

Ref. ACR.60.9.21.MVGB.A

TABLE OF CONTENTS

1	Introduction.....	4
2	Device Under Test	4
3	Product Description	4
3.1	General Information	4
4	Measurement Method	5
4.1	Return Loss Requirements	5
4.2	Mechanical Requirements	5
5	Measurement Uncertainty.....	5
5.1	Return Loss	5
5.2	Dimension Measurement	5
5.3	Validation Measurement	5
6	Calibration Measurement Results.....	6
6.1	Return Loss and Impedance	6
6.2	Mechanical Dimensions	6
7	Validation measurement	7
7.1	Measurement Condition	7
7.2	Head Liquid Measurement	7
7.3	Measurement Result	8
8	List of Equipment	10



SAR REFERENCE DIPOLE CALIBRATION REPORT

Ref. ACR.60.9.21.MVGB.A

1 INTRODUCTION

This document contains a summary of the requirements set forth by the IEEE 1528, FCC KDBs and CEI/IEC 62209 standards for reference dipoles used for SAR measurement system validations and the measurements that were performed to verify that the product complies with the fore mentioned standards.

2 DEVICE UNDER TEST

Device Under Test	
Device Type	COMOSAR 2600 MHz REFERENCE DIPOLE
Manufacturer	MVG
Model	SID2600
Serial Number	SN 03/15 DIP2G600-356
Product Condition (new / used)	Used

3 PRODUCT DESCRIPTION

3.1 GENERAL INFORMATION

MVG’s COMOSAR Validation Dipoles are built in accordance to the IEEE 1528, FCC KDBs and CEI/IEC 62209 standards. The product is designed for use with the COMOSAR test bench only.



Figure 1 – MVG COMOSAR Validation Dipole



SAR REFERENCE DIPOLE CALIBRATION REPORT

Ref. ACR.60.9.21.MVGB.A

4 MEASUREMENT METHOD

The IEEE 1528, FCC KDBs and CEI/IEC 62209 standards provide requirements for reference dipoles used for system validation measurements. The following measurements were performed to verify that the product complies with the fore mentioned standards.

4.1 RETURN LOSS REQUIREMENTS

The dipole used for SAR system validation measurements and checks must have a return loss of -20 dB or better. The return loss measurement shall be performed against a liquid filled flat phantom, with the phantom constructed as outlined in the fore mentioned standards. A direct method is used with a network analyser and its calibration kit, both with a valid ISO17025 calibration.

4.2 MECHANICAL REQUIREMENTS

The IEEE Std. 1528 and CEI/IEC 62209 standards specify the mechanical components and dimensions of the validation dipoles, with the dimension's frequency and phantom shell thickness dependent. The COMOSAR test bench employs a 2 mm phantom shell thickness therefore the dipoles sold for use with the COMOSAR test bench comply with the requirements set forth for a 2 mm phantom shell thickness. A direct method is used with a ISO17025 calibrated caliper.

5 MEASUREMENT UNCERTAINTY

All uncertainties listed below represent an expanded uncertainty expressed at approximately the 95% confidence level using a coverage factor of k=2, traceable to the Internationally Accepted Guides to Measurement Uncertainty.

5.1 RETURN LOSS

The following uncertainties apply to the return loss measurement:

Frequency band	Expanded Uncertainty on Return Loss
400-6000MHz	0.08 LIN

5.2 DIMENSION MEASUREMENT

The following uncertainties apply to the dimension measurements:

Length (mm)	Expanded Uncertainty on Length
0 - 300	0.20 mm
300 - 450	0.44 mm

5.3 VALIDATION MEASUREMENT

The guidelines outlined in the IEEE 1528, FCC KDBs, CENELEC EN50361 and CEI/IEC 62209 standards were followed to generate the measurement uncertainty for validation measurements.

Scan Volume	Expanded Uncertainty



SAR REFERENCE DIPOLE CALIBRATION REPORT

Ref. ACR.60.9.21.MVGB.A

1 g	19 % (SAR)
10 g	19 % (SAR)

6 CALIBRATION MEASUREMENT RESULTS

6.1 RETURN LOSS AND IMPEDANCE

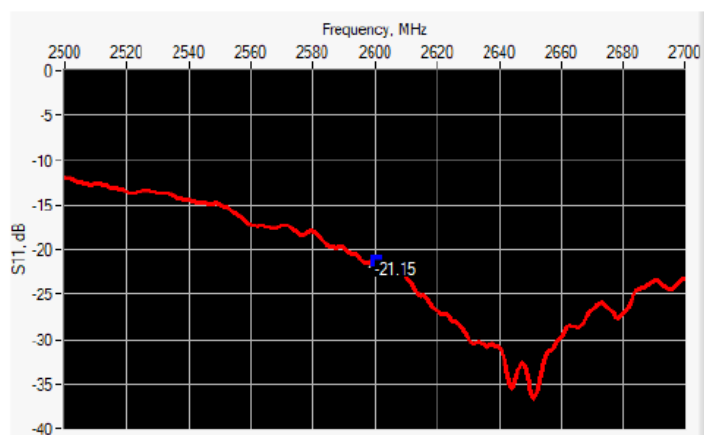

Frequency (MHz)	Return Loss (dB)	Requirement (dB)	Impedance
2600	-21.15	-20	52.7 Ω - 8.3 jΩ

6.2 MECHANICAL DIMENSIONS

Frequency MHz	L mm		h mm		d mm	
	required	measured	required	measured	required	measured
300	420.0 ±1 %.		250.0 ±1 %.		6.35 ±1 %.	
450	290.0 ±1 %.		166.7 ±1 %.		6.35 ±1 %.	
750	176.0 ±1 %.		100.0 ±1 %.		6.35 ±1 %.	
835	161.0 ±1 %.		89.8 ±1 %.		3.6 ±1 %.	
900	149.0 ±1 %.		83.3 ±1 %.		3.6 ±1 %.	
1450	89.1 ±1 %.		51.7 ±1 %.		3.6 ±1 %.	
1500	80.5 ±1 %.		50.0 ±1 %.		3.6 ±1 %.	
1640	79.0 ±1 %.		45.7 ±1 %.		3.6 ±1 %.	
1750	75.2 ±1 %.		42.9 ±1 %.		3.6 ±1 %.	
1800	72.0 ±1 %.		41.7 ±1 %.		3.6 ±1 %.	
1900	68.0 ±1 %.		39.5 ±1 %.		3.6 ±1 %.	
1950	66.3 ±1 %.		38.5 ±1 %.		3.6 ±1 %.	
2000	64.5 ±1 %.		37.5 ±1 %.		3.6 ±1 %.	
2100	61.0 ±1 %.		35.7 ±1 %.		3.6 ±1 %.	
2300	55.5 ±1 %.		32.6 ±1 %.		3.6 ±1 %.	
2450	51.5 ±1 %.		30.4 ±1 %.		3.6 ±1 %.	



SAR REFERENCE DIPOLE CALIBRATION REPORT

Ref. ACR.60.9.21.MVGB.A

2600	48.5 ±1 %.	-	28.8 ±1 %.	-	3.6 ±1 %.	-
3000	41.5 ±1 %.		25.0 ±1 %.		3.6 ±1 %.	
3500	37.0±1 %.		26.4 ±1 %.		3.6 ±1 %.	
3700	34.7±1 %.		26.4 ±1 %.		3.6 ±1 %.	

7 VALIDATION MEASUREMENT

The IEEE Std. 1528, FCC KDBs and CEI/IEC 62209 standards state that the system validation measurements must be performed using a reference dipole meeting the fore mentioned return loss and mechanical dimension requirements. The validation measurement must be performed against a liquid filled flat phantom, with the phantom constructed as outlined in the fore mentioned standards. Per the standards, the dipole shall be positioned below the bottom of the phantom, with the dipole length centered and parallel to the longest dimension of the flat phantom, with the top surface of the dipole at the described distance from the bottom surface of the phantom.

7.1 MEASUREMENT CONDITION

Software	OPENSAR V5
Phantom	SN 13/09 SAM68
Probe	SN 41/18 EPGO333
Liquid	Head Liquid Values: eps' : 41.5 sigma : 2.03
Distance between dipole center and liquid	10.0 mm
Area scan resolution	dx=8mm/dy=8mm
Zoon Scan Resolution	dx=5mm/dy=5mm/dz=5mm
Frequency	26002600 MHz
Input power	20 dBm
Liquid Temperature	20 +/- 1 °C
Lab Temperature	20 +/- 1 °C
Lab Humidity	30-70 %

7.2 HEAD LIQUID MEASUREMENT

Frequency MHz	Relative permittivity (ε _r)		Conductivity (σ) S/m	
	required	measured	required	measured
300	45.3 ±10 %		0.87 ±10 %	
450	43.5 ±10 %		0.87 ±10 %	
750	41.9 ±10 %		0.89 ±10 %	
835	41.5 ±10 %		0.90 ±10 %	
900	41.5 ±10 %		0.97 ±10 %	
1450	40.5 ±10 %		1.20 ±10 %	
1500	40.4 ±10 %		1.23 ±10 %	
1640	40.2 ±10 %		1.31 ±10 %	
1750	40.1 ±10 %		1.37 ±10 %	
1800	40.0 ±10 %		1.40 ±10 %	
1900	40.0 ±10 %		1.40 ±10 %	
1950	40.0 ±10 %		1.40 ±10 %	
2000	40.0 ±10 %		1.40 ±10 %	



SAR REFERENCE DIPOLE CALIBRATION REPORT

Ref. ACR.60.9.21.MVGB.A

2100	39.8 ±10 %		1.49 ±10 %	
2300	39.5 ±10 %		1.67 ±10 %	
2450	39.2 ±10 %		1.80 ±10 %	
2600	39.0 ±10 %	41.5	1.96 ±10 %	2.03
3000	38.5 ±10 %		2.40 ±10 %	
3500	37.9 ±10 %		2.91 ±10 %	

7.3 MEASUREMENT RESULT

The IEEE Std. 1528 and CEI/IEC 62209 standards state that the system validation measurements should produce the SAR values shown below (for phantom thickness of 2 mm), within the uncertainty for the system validation. All SAR values are normalized to 1 W forward power. In bracket, the measured SAR is given with the used input power.

Frequency MHz	1 g SAR (W/kg/W)		10 g SAR (W/kg/W)	
	required	measured	required	measured
300	2.85		1.94	
450	4.58		3.06	
750	8.49		5.55	
835	9.56		6.22	
900	10.9		6.99	
1450	29		16	
1500	30.5		16.8	
1640	34.2		18.4	
1750	36.4		19.3	
1800	38.4		20.1	
1900	39.7		20.5	
1950	40.5		20.9	
2000	41.1		21.1	
2100	43.6		21.9	
2300	48.7		23.3	
2450	52.4		24	
2600	55.3	55.83 (5.58)	24.6	24.19 (2.42)
3000	63.8		25.7	
3500	67.1		25	



SAR REFERENCE DIPOLE CALIBRATION REPORT

Ref. ACR.60.9.21.MVGB.A

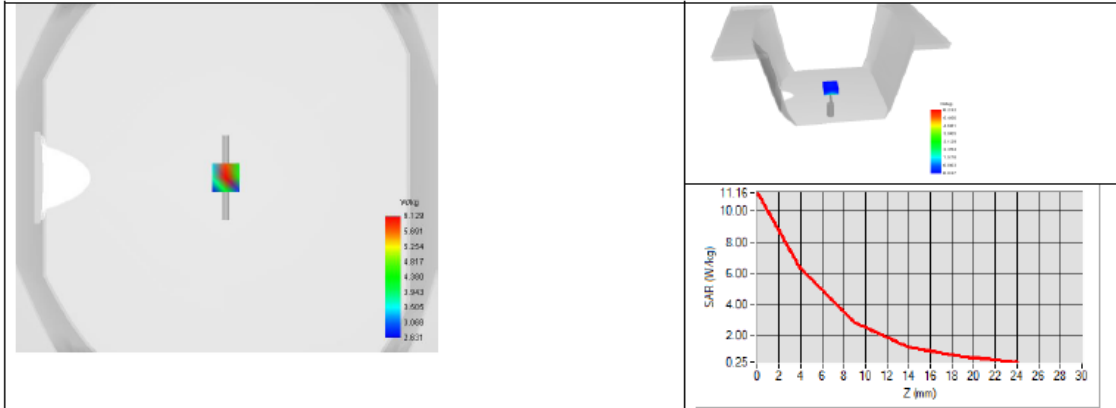



SAR REFERENCE DIPOLE CALIBRATION REPORT

Ref: ACR.60.9.21.MVGB.A

8 LIST OF EQUIPMENT

Equipment Summary Sheet				
Equipment Description	Manufacturer / Model	Identification No.	Current Calibration Date	Next Calibration Date
SAM Phantom	MVG	SN-13/09-SAM68	Validated. No cal required.	Validated. No cal required.
COMOSAR Test Bench	Version 3	NA	Validated. No cal required.	Validated. No cal required.
Network Analyzer	Rohde & Schwarz ZVM	100203	05/2019	05/2022
Network Analyzer – Calibration kit	Rohde & Schwarz ZV-Z235	101223	05/2019	05/2022
Calipers	Mitutoyo	SN 0009732	10/2019	10/2022
Reference Probe	MVG	EPGO333 SN 41/18	05/2020	05/2021
Multimeter	Keithley 2000	1160271	02/2020	02/2023
Signal Generator	Rohde & Schwarz SMB	106589	04/2019	04/2022
Amplifier	Aethercomm	SN 046	Characterized prior to test. No cal required.	Characterized prior to test. No cal required.
Power Meter	NI-USB 5680	170100013	05/2019	05/2022
Directional Coupler	Narda 4216-20	01386	Characterized prior to test. No cal required.	Characterized prior to test. No cal required.
Temperature / Humidity Sensor	Testo 184 H1	44220687	05/2020	05/2023



SAR Reference Waveguide Calibration Report

Ref : ACR.60.10.21.MVGB.A

SHENZHEN NTEK TESTING TECHNOLOGY CO., LTD.

**BUILDING E, FENDA SCIENCE PARK, SANWEI
COMMUNITY, XIXIANG STREET,
BAO'AN DISTRICT, SHENZHEN GUANGDONG, CHINA
SATIMO COMOSAR REFERENCE WAVEGUIDE**

**FREQUENCY: 5000-6000 MHZ
SERIAL NO.: SN 13/14 WGA33**

Calibrated at MVG

Z.I. de la pointe du diable

**Technopôle Brest Iroise – 295 avenue Alexis de Rochon
29280 PLOUZANE - FRANCE**

Calibration date: 03/01/2021



Accreditations #2-6789 and #2-6814
Scope available on www.cofrac.fr

Summary:

This document presents the method and results from an accredited SAR reference waveguide calibration performed at MVG, using the COMOSAR test bench. The test results covered by accreditation are traceable to the International System of Units (SI).



SAR REFERENCE WAVEGUIDE CALIBRATION REPORT

Ref: ACR.60.10.21.MVGB.A

	Name	Function	Date	Signature
Prepared by :	Jérôme Luc	Technical Manager	3/1/2021	<i>JL</i>
Checked by :	Jérôme Luc	Technical Manager	3/1/2021	<i>JL</i>
Approved by :	Yann Toutain	Laboratory Director	3/1/2021	<i>Yann Toutain</i>

2021.03.01 13:15:44 +01'00'

PHILIPS

	Customer Name
Distribution :	SHENZHEN NTEK TESTING TECHNOLOGY CO., LTD.

Issue	Name	Date	Modifications
A	Jérôme Luc	3/1/2021	Initial release



SAR REFERENCE WAVEGUIDE CALIBRATION REPORT

Ref: ACR.60.10.21.MVGB.A

TABLE OF CONTENTS

1	Introduction.....	4
2	Device Under Test	4
3	Product Description	4
3.1	General Information	4
4	Measurement Method	4
4.1	Return Loss Requirements	4
4.2	Mechanical Requirements	4
5	Measurement Uncertainty.....	5
5.1	Return Loss	5
5.2	Dimension Measurement	5
5.3	Validation Measurement	5
6	Calibration Measurement Results.....	5
6.1	Return Loss	5
6.2	Mechanical Dimensions	6
7	Validation measurement	6
7.1	Head Liquid Measurement	8
7.2	Measurement Result	8
8	List of Equipment	11



SAR REFERENCE WAVEGUIDE CALIBRATION REPORT

Ref. ACR.60.10.21.MVGB.A

1 INTRODUCTION

This document contains a summary of the requirements set forth by the IEEE 1528 and CEI/IEC 62209 standards for reference waveguides used for SAR measurement system validations and the measurements that were performed to verify that the product complies with the fore mentioned standards.

2 DEVICE UNDER TEST

Device Under Test	
Device Type	COMOSAR 5000-6000 MHz REFERENCE WAVEGUIDE
Manufacturer	MVG
Model	SWG5500
Serial Number	SN 13/14 WGA33
Product Condition (new / used)	Used

3 PRODUCT DESCRIPTION

3.1 GENERAL INFORMATION

MVG’s COMOSAR Validation Waveguides are built in accordance to the IEEE 1528 and CEI/IEC 62209 standards.

4 MEASUREMENT METHOD

The IEEE 1528 and CEI/IEC 62209 standards provide requirements for reference waveguides used for system validation measurements. The following measurements were performed to verify that the product complies with the fore mentioned standards.

4.1 RETURN LOSS REQUIREMENTS

The waveguide used for SAR system validation measurements and checks must have a return loss of -8 dB or better. The return loss measurement shall be performed with matching layer placed in the open end of the waveguide, with the waveguide and matching layer in direct contact with the phantom shell as outlined in the fore mentioned standards. A direct method is used with a network analyser and its calibration kit, both with a valid ISO17025 calibration.

4.2 MECHANICAL REQUIREMENTS

The IEEE 1528 and CEI/IEC 62209 standards specify the mechanical dimensions of the validation waveguide, the specified dimensions are as shown in Section 6.2. Figure 1 shows how the dimensions relate to the physical construction of the waveguide. A direct method is used with a ISO17025 calibrated caliper.



SAR REFERENCE WAVEGUIDE CALIBRATION REPORT

Ref: ACR.60.10.21.MVGB.A

5 MEASUREMENT UNCERTAINTY

All uncertainties listed below represent an expanded uncertainty expressed at approximately the 95% confidence level using a coverage factor of k=2, traceable to the Internationally Accepted Guides to Measurement Uncertainty.

5.1 RETURN LOSS

The following uncertainties apply to the return loss measurement:

Frequency band	Expanded Uncertainty on Return Loss
400-6000MHz	0.08 LIN

5.2 DIMENSION MEASUREMENT

The following uncertainties apply to the dimension measurements:

Length (mm)	Expanded Uncertainty on Length
0 - 300	0.20 mm

5.3 VALIDATION MEASUREMENT

The guidelines outlined in the IEEE 1528 and CEI/IEC 62209 standards were followed to generate the measurement uncertainty for validation measurements.

Scan Volume	Expanded Uncertainty
1 g	19 % (SAR)
10 g	19 % (SAR)

6 CALIBRATION MEASUREMENT RESULTS

6.1 RETURN LOSS

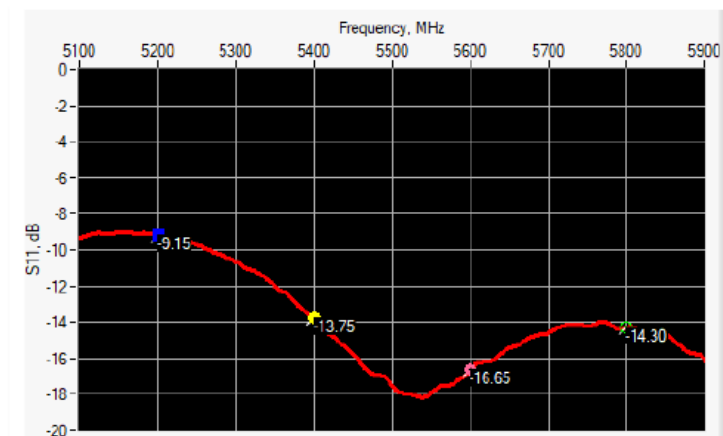



SAR REFERENCE WAVEGUIDE CALIBRATION REPORT

Ref. ACR.60.10.21.MVGB.A

Frequency (MHz)	Return Loss (dB)	Requirement (dB)	Impedance
5200	-9.15	-8	$21.17 \Omega + 13.26 j\Omega$
5400	-13.75	-8	$68.57 \Omega + 6.68 j\Omega$
5600	-16.65	-8	$35.76 \Omega - 2.15 j\Omega$
5800	-14.30	-8	$54.74 \Omega + 18.27 j\Omega$

6.2 MECHANICAL DIMENSIONS

Frequency (MHz)	L (mm)		W (mm)		Lr (mm)		Wr (mm)	
	Required	Measured	Required	Measured	Required	Measured	Required	Measured
5800	40.39 ± 0.13	-	20.19 ± 0.13	-	81.03 ± 0.13	-	61.98 ± 0.13	-

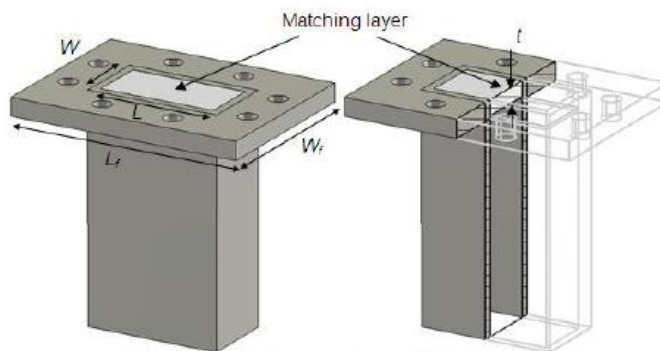

Figure 1: Validation Waveguide Dimensions

7 VALIDATION MEASUREMENT

The IEEE Std. 1528 and CEI/IEC 62209 standards state that the system validation measurements must be performed using a reference waveguide meeting the fore mentioned return loss and mechanical dimension requirements. The validation measurement must be performed with the matching layer placed in the open end of the waveguide, with the waveguide and matching layer in direct contact with the phantom shell.



SAR REFERENCE WAVEGUIDE CALIBRATION REPORT

Ref: ACR.60.10.21.MVGB.A

Measurement Condition

Software	OPENSAR V5
Phantom	SN 13/09 SAM68
Probe	SN 41/18 EPGO333
Liquid	Head Liquid Values 5200 MHz: eps' :34.06 sigma : 4.70 Head Liquid Values 5400 MHz: eps' :33.39 sigma : 4.91 Head Liquid Values 5600 MHz: eps' :32.77 sigma : 5.13 Head Liquid Values 5800 MHz: eps' :32.40 sigma : 5.34
Distance between dipole waveguide and liquid	0 mm
Area scan resolution	dx=8mm/dy=8mm
Zoon Scan Resolution	dx=4mm/dy=4m/dz=2mm
Frequency	5200 MHz 5400 MHz 5600 MHz 5800 MHz
Input power	20 dBm
Liquid Temperature	20 +/- 1 °C
Lab Temperature	20 +/- 1 °C
Lab Humidity	30-70 %



SAR REFERENCE WAVEGUIDE CALIBRATION REPORT

Ref. ACR.60.10.21.MVGB.A

7.1 HEAD LIQUID MEASUREMENT

Frequency MHz	Relative permittivity (ϵ_r')		Conductivity (σ) S/m	
	required	measured	required	measured
5000	36.2 ±10 %		4.45 ±10 %	
5100	36.1 ±10 %		4.56 ±10 %	
5200	36.0 ±10 %	34.06	4.66 ±10 %	4.70
5300	35.9 ±10 %		4.76 ±10 %	
5400	35.8 ±10 %	33.39	4.86 ±10 %	4.91
5500	35.6 ±10 %		4.97 ±10 %	
5600	35.5 ±10 %	32.77	5.07 ±10 %	5.13
5700	35.4 ±10 %		5.17 ±10 %	
5800	35.3 ±10 %	32.40	5.27 ±10 %	5.34
5900	35.2 ±10 %		5.38 ±10 %	
6000	35.1 ±10 %		5.48 ±10 %	

7.2 MEASUREMENT RESULT

At those frequencies, the target SAR value can not be generic. Hereunder is the target SAR value defined by Satimo, within the uncertainty for the system validation. All SAR values are normalized to 1 W net power. In bracket, the measured SAR is given with the used input power.

Frequency (MHz)	1 g SAR (W/kg)		10 g SAR (W/kg)	
	required	measured	required	measured
5200	159.00	162.34 (16.23)	56.90	55.42 (5.54)
5400	166.40	168.48 (16.85)	58.43	57.03 (5.70)
5600	173.80	174.92 (17.49)	59.97	58.63 (5.86)
5800	181.20	178.89 (17.89)	61.50	59.32 (5.93)