

Product Name: Smart Phone	Report No: ITEZA2-202400107RF3
Product Model: Blade10 Pro, Blade10, Blade10 Ultra, Blade10 S, Blade10 E, Blade10 SE, Blade10 Plus, Blade10 Max, Blade10 Power	Security Classification: Open
Version: V1.0	Total Page:82

# TIRT Testing Report

<b>Prepared By:</b>	<b>Checked By:</b>	<b>Approved By:</b>	
Aaron Long	Stone Tang	Joky Wang	
<i>Aaron Long</i>	<i>Stone Tang</i>	<i>Joky Wang</i>	

# FCC Radio Test Report

## FCC ID: 2AX4YBLADE10PRO

According to

**47 CFR FCC Part 15, Subpart C(Section 15.247)**

**ANSI C63.10:2013**

Applicant:	Shenzhen DOOGEE Hengtong Technology CO.,LTD
Address:	B, 2/F, Building A4, Silicon Valley Power Digital Industrial Park, No. 22, Longhua New District, Shenzhen, China
Manufacturer:	Shenzhen DOOGEE Hengtong Technology CO.,LTD
Address:	B, 2/F, Building A4, Silicon Valley Power Digital Industrial Park, No. 22, Longhua New District, Shenzhen, China
Sample No:	1000032108
Product Name:	Smart Phone
Brand Name:	DOOGEE
Model No.:	Blade10 Pro, Blade10, Blade10 Ultra, Blade10 S, Blade10 E, Blade10 SE, Blade10 Plus, Blade10 Max, Blade10 Power
Test No.:	Blade10 Pro

Date of Receipt:	2024/04/23
Date of Test:	2024/04/23~2024/05/22
Issued Date:	2024/05/27
Testing Lab:	TIRT

**Note:** This report shall not be reproduced except in full, without the written approval of Beijing TIRT Technology Service Co.,Ltd Shenzhen.Laboratory.  
This document may be altered or revised by Beijing TIRT Technology Service Co.,Ltd Shenzhen. Laboratory.Personnel only, and shall be noted in the revision section of the document. The test results of this report relate only to the tested sample identified in this report.

**Table of Contents****Page**

<b>REPORT ISSUED HISTORY</b>	<b>5</b>
<b>1 . SUMMARY OF TEST RESULTS</b>	<b>6</b>
1.1 TEST FACILITY	7
1.2 MEASUREMENT UNCERTAINTY	7
1.3 TEST ENVIRONMENT CONDITIONS	7
<b>2 . GENERAL INFORMATION</b>	<b>8</b>
2.1 GENERAL DESCRIPTION OF EUT	8
2.2 DESCRIPTION OF TEST MODES	9
2.3 DUTY CYCLE	11
2.4 BLOCKDIAGRAMSHOWINGTHECONFIGURATIONOFSYSTEMTESTED	16
2.5 SUPPORT UNITS	16
<b>3 .AC POWER LINE CONDUCTED EMISSIONS</b>	<b>17</b>
3.1 LIMIT	17
3.2 TEST PROCEDURE	17
3.3 DEVIATIONFROMTESTSTANDARD	17
3.4 TESTSETUP	18
3.5 EUT OPERATION CONDITIONS	18
3.6 TEST RESULTS	18
<b>4 . RADIATED EMISSIONS</b>	<b>19</b>
4.1 LIMIT	19
4.2 TEST PROCEDURE	20
4.3 DEVIATIONFROMTESTSTANDARD	21
4.4 TESTSETUP	21
4.5 EUT OPERATIONCONDITIONS	23
4.6 TEST RESULTS - 9 KHZ TO 30MHZ	23
4.7 TEST RESULTS - 30 MHZTO 1000MHZ	23
4.8 TEST RESULTS- ABOVE 1000MHZ	23
<b>5 .BANDWIDTH</b>	<b>24</b>
5.1 LIMIT	24
5.2 TEST PROCEDURE	24
5.3 DEVIATION FROM STANDARD	24
5.4 TEST SETUP	24
5.5 EUT OPERATION CONDITIONS	24
5.6 TESTRESULTS	24

<b>Table of Contents</b>	<b>Page</b>
<b>6 .MAXIMUM OUTPUT POWER</b>	<b>25</b>
6.1 LIMIT	25
6.2 TEST PROCEDURE	25
6.3 DEVIATION FROM STANDARD	25
6.4 TEST SETUP	25
6.5 EUT OPERATION CONDITIONS	25
6.6 TESTRESULTS	25
<b>7 .CONDUCTED SPURIOUS EMISSIONS</b>	<b>26</b>
7.1 LIMIT	26
7.2 TEST PROCEDURE	26
7.3 DEVIATION FROM STANDARD	26
7.4 TEST SETUP	26
7.5 EUT OPERATION CONDITIONS	26
7.6 TESTRESULTS	26
<b>8 .POWER SPECTRAL DENSITY</b>	<b>27</b>
8.1 LIMIT	27
8.2 TEST PROCEDURE	27
8.3 DEVIATION FROM STANDARD	27
8.4 TEST SETUP	27
8.5 EUT OPERATION CONDITIONS	27
8.6 TESTRESULTS	27
<b>9 . MEASUREMENT INSTRUMENTS LIST</b>	<b>28</b>
<b>10 .EUT TEST PHOTO</b>	<b>29</b>
<b>11. PHOTOS OF EUT</b>	<b>31</b>
<b>APPENDIX A - AC POWER LINE CONDUCTED EMISSIONS</b>	<b>39</b>
<b>APPENDIX B - RADIATED EMISSION - 9 KHZ TO 30 MHZ</b>	<b>41</b>
<b>APPENDIX C - RADIATED EMISSION - 30 MHZ TO 1000 MHZ</b>	<b>42</b>
<b>APPENDIXD -RADIATED EMISSION- ABOVE 1000MHZ</b>	<b>44</b>
<b>APPENDIXE - BANDWIDTH</b>	<b>49</b>
<b>APPENDIXF - MAXIMUMOUTPUT POWER</b>	<b>54</b>
<b>APPENDIXG - CONDUCTED SPURIOUS EMISSIONS</b>	<b>59</b>
<b>APPENDIXH - POWER SPECTRAL DENSITY</b>	<b>78</b>

**REPORT ISSUED HISTORY**

Report No.	Version	Description	Issued Date	Note
ITEZA2-202400107RF3	V1.0	OriginalReport.	2024.05.27	Valid

### 1. SUMMARY OF TEST RESULTS

Test procedures according to the technical standard(s):

FCC CFR Title 47, Part 15, Subpart C				
Standard(s) Section	Test Item	Test Result	Judgment	Remark
15.207	AC Power Line Conducted Emissions	APPENDIX A	PASS	-----
15.247(d) 15.205(a) 15.209(a)	Radiated Emissions	APPENDIX B APPENDIX C APPENDIX D	PASS	-----
15.247(a)(2)	Bandwidth	APPENDIX E	PASS	-----
15.247(b)(3)	Maximum Output Power	APPENDIX F	PASS	-----
15.247(d)	Conducted Spurious Emissions	APPENDIX G	PASS	-----
15.247(e)	Power Spectral Density	APPENDIX H	PASS	-----
15.203	Antenna Requirement	-----	PASS	Note(2)

Note:

- (1) "N/A" denotes test is not applicable in this test report.
- (2) The device what use a permanently attached antenna were considered sufficient to comply with the provisions of 15.203.

### 1.1 TEST FACILITY

Company:	Beijing TIRT Technology Service Co.,Ltd Shenzhen
Address:	104 Building C, Xinmingsheng Industrial Park No.132, Zhangge Old Village East Zone, Zhangge Community, Fucheng Street, Longhua District, Shenzhen, Guangdong, P. R. China
CNAS Registration Number:	CNAS L14158
A2LA Registration Number:	6049.01
FCC Accredited Lab.Designation Number:	CN1366
FCC Test Firm Registration Number:	820690
Telephone:	+86-0755-27087573

### 1.2 MEASUREMENT UNCERTAINTY

ISO/IEC 17025 requires that an estimate of the measurement uncertainties associated with the emissions test results be included in the report. The measurement uncertainties given below are based on a 95% confidence level (based on a coverage factor (k=2))

The TIRT measurement uncertainty as below table:

Uncertainty	
Parameter	Uncertainty
Occupied Channel Bandwidth	±142.12 KHz
RF power conducted	±0.74 dB
RF power radiated	±3.25dB
Spurious emissions, conducted	±1.78dB
Spurious emissions, radiated (30MHz~1GHz)	±4.6dB
Spurious emissions, radiated (1GHz~18GHz)	±4.9dB
Conduction Emissions(150kHz~30MHz)	±3.1 dB
Humidity	±4.6%
Temperature	±0.7°C
Time	±1.2%

Note: Unless specifically mentioned, the uncertainty of measurement has not been taken into account to declare the compliance or non-compliance to the specification.

### 1.3 TEST ENVIRONMENT CONDITIONS

Test Item	Temperature	Humidity	Test Voltage	Tested By
AC Power Line Conducted Emissions	25.1°C	52%	AC 120V/60Hz	Stone Tang
Radiated Emissions-9kHz to 30 MHz	24.5°C	50%	AC 120V/60Hz	Stone Tang
Radiated Emissions-30MHz to 1000MHz	24.2°C	53%	AC 120V/60Hz	Stone Tang
Radiated Emissions-Above 1000MHz	26.0°C	53%	AC 120V/60Hz	Stone Tang
Bandwidth	25.0°C	56%	AC 120V/60Hz	Stone Tang
Maximum Output Power	24.9°C	54%	AC 120V/60Hz	Stone Tang
Conducted Spurious Emissions	25.1°C	62%	AC 120V/60Hz	Stone Tang
Power Spectral Density	26.0°C	60%	AC 120V/60Hz	Stone Tang

## 2. GENERAL INFORMATION

### 2.1 GENERAL DESCRIPTION OF EUT

Equipment	Smart Phone
Brand Name	DOOGEE
Test Model	Blade10 Pro
Series Model	Blade10 Pro, Blade10, Blade10 Ultra, Blade10 S, Blade10 E, Blade10 SE, Blade10 Plus, Blade10 Max, Blade10 Power
Model Difference(s)	There is no difference except the name of the model
Software Version	DOOGEE-Blade10Pro-EEA-Android14.0-20240512
Hardware Version	SC6020LU-MB-1.0.1-20240411
Power Rating	DC 3.87V from battery or DC 5V from adapter
Operation Frequency	2412 MHz~ 2462 MHz
Modulation Type	IEEE 802.11b: DSSS(CCK,DQPSK,DBPSK) IEEE 802.11g: OFDM(64QAM, 16QAM, QPSK, BPSK) IEEE 802.11n :OFDM(64QAM, 16QAM, QPSK, BPSK)
Bit Rate of Transmitter	IEEE 802.11b: 11/5.5/2/1 Mbps IEEE 802.11g: 54/48/36/24/18/12/9/6 Mbps IEEE 802.11n: up to 300 Mbps
Maximum Output Average Power	IEEE 802.11g: 12.59dBm (0.018155W)

Note:

- For a more detailed features description, please refer to the manufacturer's specifications or the user's manual.

#### 2. Channel List:

CH01 - CH11 for IEEE 802.11b, IEEE 802.11g, IEEE 802.11n(HT20) CH03 - CH09 for IEEE 802.11n(HT40)							
Channel	Frequency (MHz)	Channel	Frequency (MHz)	Channel	Frequency (MHz)	Channel	Frequency (MHz)
01	2412	04	2427	07	2442	10	2457
02	2417	05	2432	08	2447	11	2462
03	2422	06	2437	09	2452		

#### 3. Antenna Specification:

Ant.	Manufactured	Model Name	Antenna Type	Connector	Gain (dBi)
1	SHENZHEN HENGXIANGTONG ANTENNA TECHNOLOGY CO., LTD.	F1C	PIFA	N/A	0.45

Note:

- The antenna gain is provided by the manufacturer.
- The antenna is for testing purposes only.



## 2.2 DESCRIPTION OF TEST MODES

The test system was pre-tested based on the consideration of all possible combinations of EUT operation mode.

Pretest Mode	Description
Mode 1	TX B Mode Channel 01/06/11
Mode 2	TX G Mode Channel 01/06/11
Mode 3	TX N(HT20) Mode Channel 01/06/11
Mode 4	TX N(HT40) Mode Channel 03/06/09
Mode 5	TX G Mode Channel 01

Following mode(s) was (were) found to be the worst case(s) and selected for the final test.

<b>AC power line conducted emissions test</b>	
Final Test Mode	Description
Mode 5	TX G Mode Channel 01

<b>Radiated emissions test - Below 1GHz</b>	
Final Test Mode	Description
Mode 5	TX GMode Channel 01

<b>Radiated emissions test- Above 1GHz</b>	
Final Test Mode	Description
Mode 1	TX B Mode Channel 01/06/11
Mode 2	TX G Mode Channel 01/06/11
Mode 3	TX N(HT20) Mode Channel 01/06/11
Mode 4	TX N(HT40) Mode Channel 03/06/09

Conducted test	
Final Test Mode	Description
Mode 1	TX B Mode Channel 01/06/11
Mode 2	TX G Mode Channel 01/06/11
Mode 3	TX N(HT20) Mode Channel 01/06/11
Mode 4	TX N(HT40) Mode Channel 03/06/09

**NOTE:**

- (1) All the bit rate of transmitter have been tested and found the lowest rate is found to be the worst case and recorded.
- (2) For radiated emission above 1 GHz test, the spurious points of 1GHz~18GHz and 18GHz~26.5GHz have been pre-tested and in this report only recorded the worst case. The remaining spurious points are all below the limit value of 20dB.

**2.3 DUTY CYCLE**

TestMode	Antenna	Frequency[MHz]	Transmission Duration [ms]	Transmission Period [ms]	Duty Cycle [%]
11B	Ant1	2412	8.39	8.41	99.76
		2437	8.38	8.41	99.64
		2462	8.39	8.41	99.76
11G	Ant1	2412	1.39	1.43	97.20
		2437	1.39	1.42	97.89
		2462	1.39	1.43	97.20
11N20SISO	Ant1	2412	1.30	1.34	97.01
		2437	1.30	1.33	97.74
		2462	1.31	1.34	97.76
11N40SISO	Ant1	2422	0.65	0.69	94.20
		2437	0.65	0.68	95.59
		2452	0.64	0.68	94.12

## 11B\_Ant1\_2412

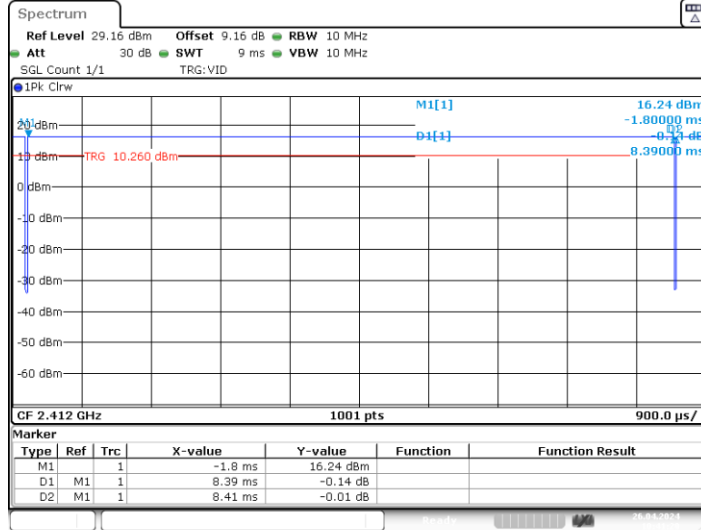

## 11B\_Ant1\_2437

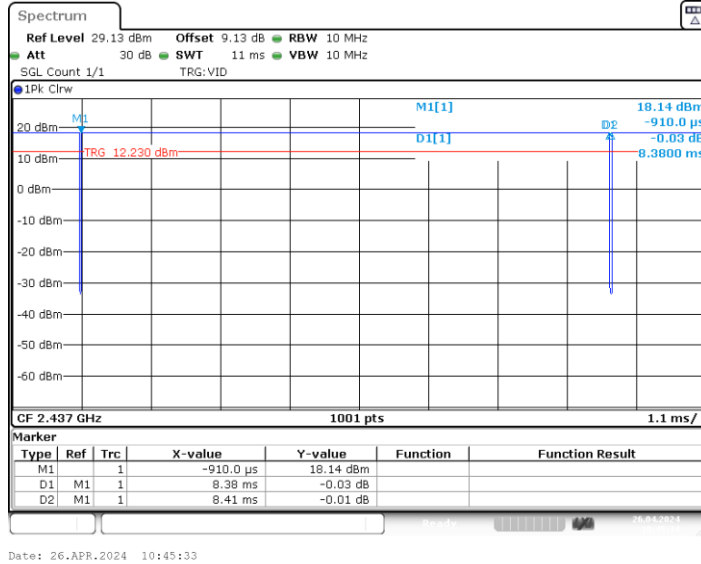

## 11B\_Ant1\_2462

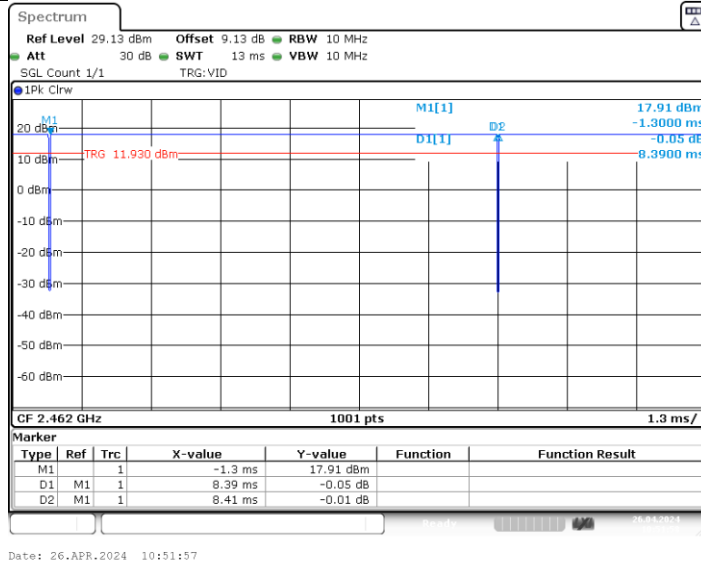

## 11G\_Ant1\_2412

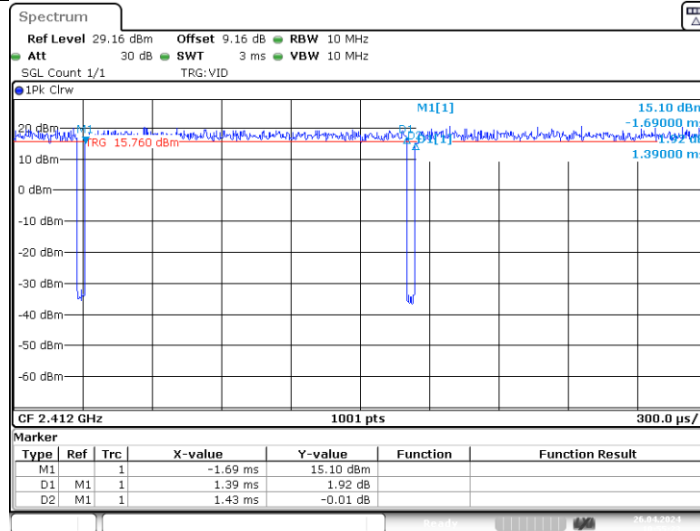

## 11G\_Ant1\_2437

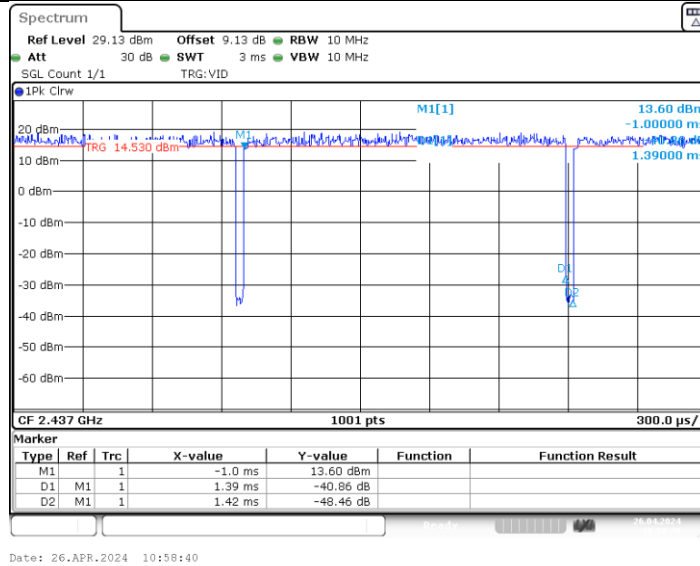

## 11G\_Ant1\_2462

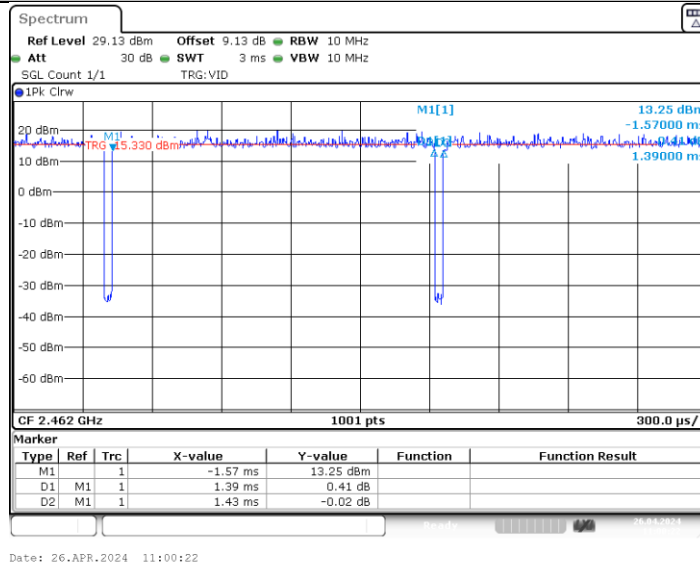

## 11N20SISO\_Ant1\_2412

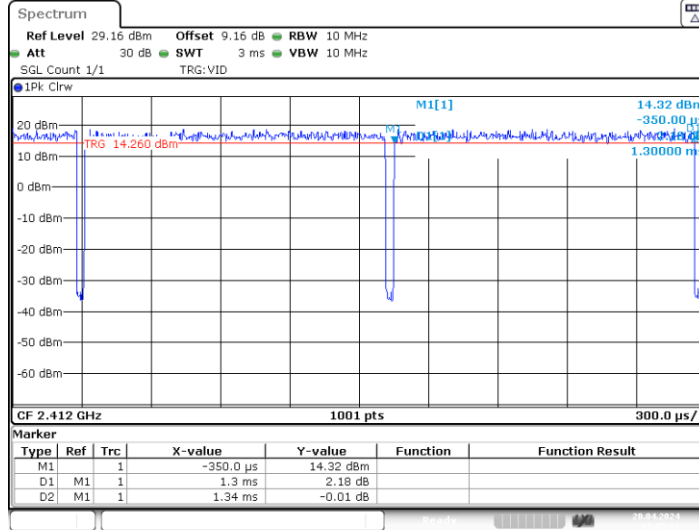

## 11N20SISO\_Ant1\_2437

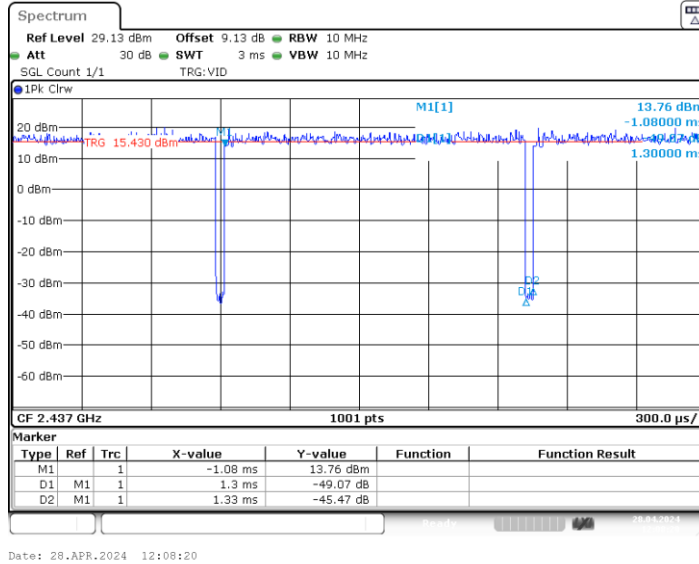

## 11N20SISO\_Ant1\_2462

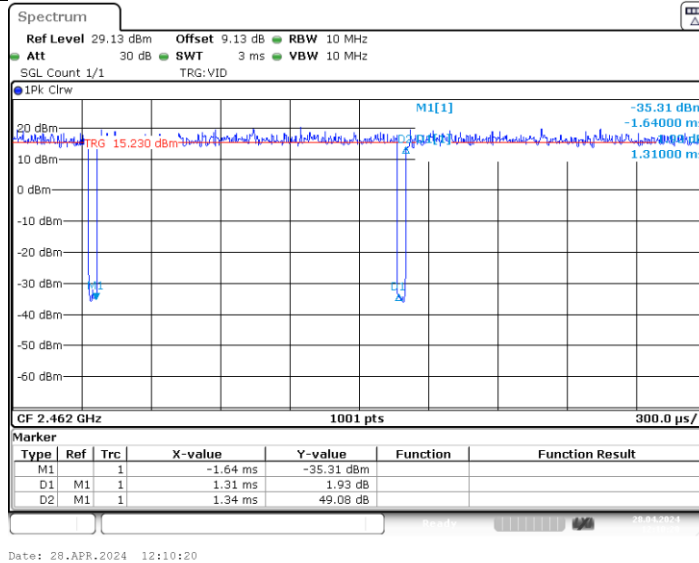

## 11N40SISO\_Ant1\_2422

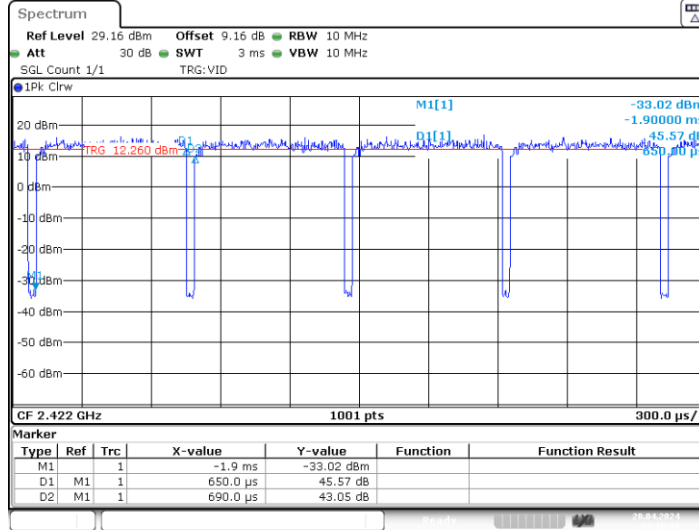

## 11N40SISO\_Ant1\_2437

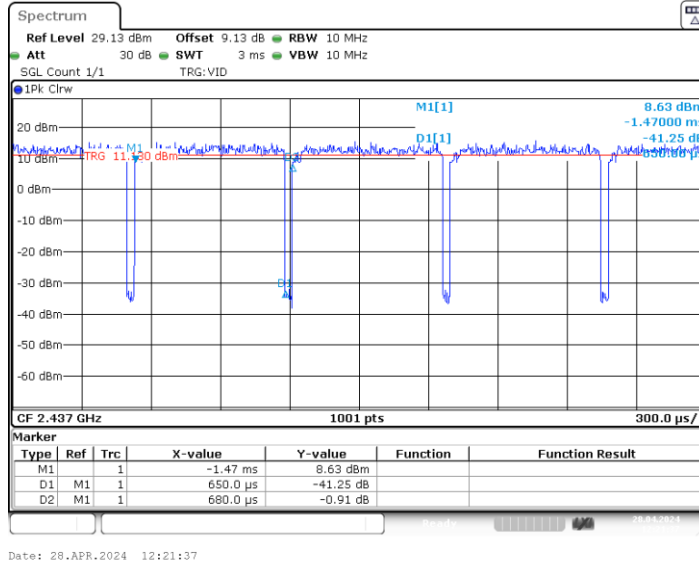

## 11N40SISO\_Ant1\_2452

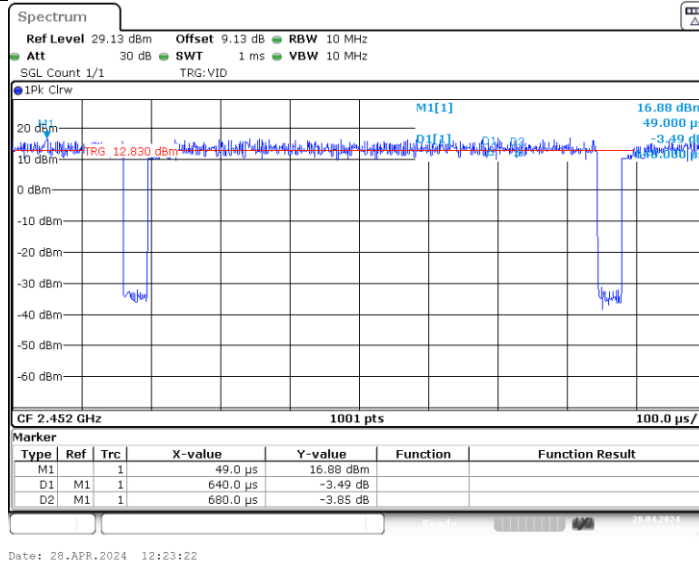

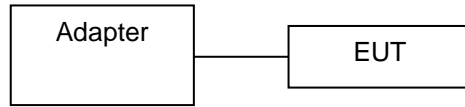
**2.4 BLOCK DIAGRAM SHOWING THE CONFIGURATION OF SYSTEM TESTED****2.5 SUPPORT UNITS**

Support Equipment				
No.	Equipment	Brand Name	Model Name	Remarks
1	/	/	/	/



### 3.AC POWER LINE CONDUCTED EMISSIONS

#### 3.1LIMIT

Frequency of Emission (MHz)	Limit (dB $\mu$ V)	
	Quasi-peak	Average
0.15 -0.5	66to 56*	56 to 46*
0.5-5.0	56	46
5.0 -30.0	60	50

NOTE:

- (1) The tighter limit applies at the band edges.
- (2) The limit of " \* " marked band means the limitation decreases linearly with the logarithm of the frequency in the range.

#### 3.2TEST PROCEDURE

- a. The EUT was placed 0.8 meters from the horizontal ground plane with EUT being connected to the power mains through a line impedance stabilization network (LISN). All other support equipment powered from additional LISN(s). The LISN provide 50 Ohm/ 50uH of coupling impedance for the measuring instrument.
- b. Interconnecting cables that hang closer than 40 cm to the groundplane shall be folded back and forth in the center forming a bundle 30 to 40 cm long.
- c. I/O cables that are not connected to a peripheral shall be bundled in the center. The end of the cable may be terminated, if required, using the correct terminating impedance. The overall length shall not exceed 1 m.
- d. LISN at least 80 cm from nearest part of EUT chassis.
- e. For the actual test configuration, please refer to the related Item -EUT Test Photos.

The following table is the setting of the receiver:

Receiver Parameters	Setting
Start Frequency	0.15 MHz
Stop Frequency	30 MHz
IF Bandwidth	9 kHz

#### 3.3DEVIATIONFROMTESTSTANDARD

No deviation.

### 3.4 TEST SETUP

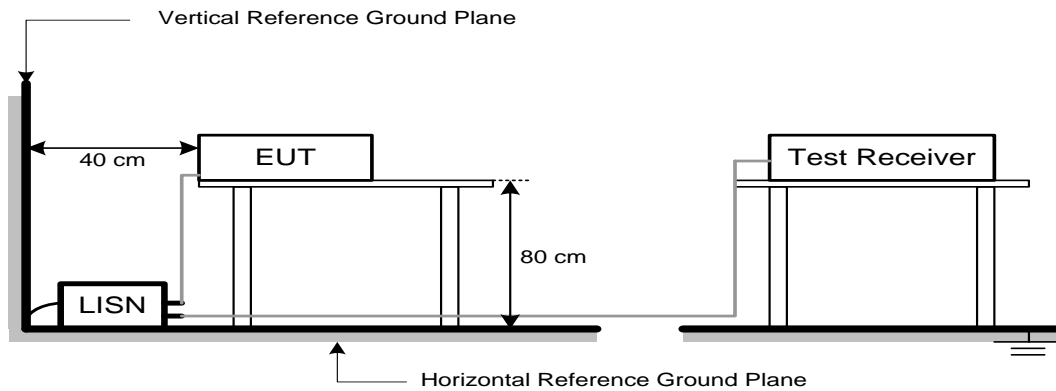

The LISN edge is arranged parallel to the edge of the test table

The vertical conducting plane or wall of an RF-shielded (screened) room shall be located 40 cm to the rear of the EUT

### 3.5 EUT OPERATION CONDITIONS

EUT was programmed to be in continuously transmitting mode.

### 3.6 TEST RESULTS

Please refer to the APPENDIX A.

## 4. RADIATED EMISSIONS

### 4.1 LIMIT

In case the emission fall within the restricted band specified on 15.205(a), then the 15.209(a) limit in the table below has to be followed.

#### LIMITS OF RADIATED EMISSION MEASUREMENT (9 kHz-1000MHz)

Frequency (MHz)	Field Strength (microvolts/meter)	Measurement Distance (meters)
0.009-0.490	2400/F(kHz)	300
0.490-1.705	24000/F(kHz)	30
1.705-30.0	30	30
30-88	100	3
88-216	150	3
216-960	200	3
Above 960	500	3

#### LIMITS OF RADIATED EMISSION MEASUREMENT (Above 1000MHz)

Frequency (MHz)	(dBuV/m at 3 m)	
	Peak	Average
Above 1000	74	54

**NOTE:**

- (1) The limit for radiated test was performed according to FCC CFR Title 47, Part 15, Subpart C.
- (2) The tighter limit applies at the band edges.
- (3) Emission level (dBuV/m)=20log Emission level (uV/m).

#### 4.2 TEST PROCEDURE

- a. The measuring distance of 3 m shall be used for measurements. The EUT was placed on the top of a rotating table 0.8 meter above the ground at a 3 meter semi-anechoic chamber. The table was rotated 360 degrees to determine the position of the highest radiation.(below 1GHz)
- b. The measuring distance of 3 m shall be used for measurements. The EUT was placed on the top of a rotating table 1.5 meter above the ground at a 3 meter semi-anechoic chamber. The table was rotated 360 degrees to determine the position of the highest radiation.(above 1GHz)
- c. The height of the equipment or of the substitution antenna shall be 0.8m or 1.5m; the height of the test antenna shall vary between 1 m to 4 m. Both horizontal and vertical polarizations of the antenna are set to make the measurement.
- d. For each suspected emission, the EUT was arranged to its worst case and then the antenna was tuned to heights find the maximum reading (used Bore sight function).
- e. The receiver system was set to peak and average detect function and specified bandwidth with maximum hold mode when the test frequency is above 1GHz.
- f. The initial step in collecting radiated emission data is a receiver peak detector mode pre-scanning the measurement frequency range. Significant peaks are then marked and then Quasi Peak detector mode re-measured.
- g. All readings are Peak unless otherwise stated QP in column of Note. Peak denotes that the Peak reading compliance with the QP Limits and then QP Mode measurement didn't perform.  
(below 1GHz)
- h. All readings are Peak Mode value unless otherwise stated AVG in column of Note. If the Peak Mode Measured value compliance with the Peak Limits and lower than AVG Limits, the EUT shall be deemed to meet both Peak & AVG Limits and then only Peak Mode was measured, but AVG Mode didn't perform. (above 1GHz)
- i. For the actual test configuration, please refer to the related Item -EUT Test Photos.

The following table is the setting of the receiver:

Spectrum Parameters	Setting
Start ~ Stop Frequency	9 kHz~150 kHz for RBW 200 Hz
Start ~ Stop Frequency	0.15 MHz~30 MHz for RBW 9 kHz
Start ~ Stop Frequency	30 MHz~1000 MHz for RBW 100 kHz

Spectrum Parameters	Setting
Start Frequency	1000 MHz
Stop Frequency	10th carrier harmonic
RBW / VBW (Emission in restricted band)	1MHz / 3MHz for PK value 1MHz / 1/THz for AVG value

Receiver Parameters	Setting
Start ~ Stop Frequency	9 kHz~90 kHz for PK/AVG detector
Start ~ Stop Frequency	90 kHz~110 kHz for QP detector
Start ~ Stop Frequency	110 kHz~490 kHz for PK/AVG detector
Start ~ Stop Frequency	490 kHz~30 MHz for QP detector
Start ~ Stop Frequency	30MHz~1000MHz for QP detector
Start ~ Stop Frequency	1 GHz~26.5GHz for PK/AVG detector

**4.3 DEVIATION FROM TEST STANDARD**

No deviation.

**4.4 TEST SETUP**

**9 kHz to 30 MHz**

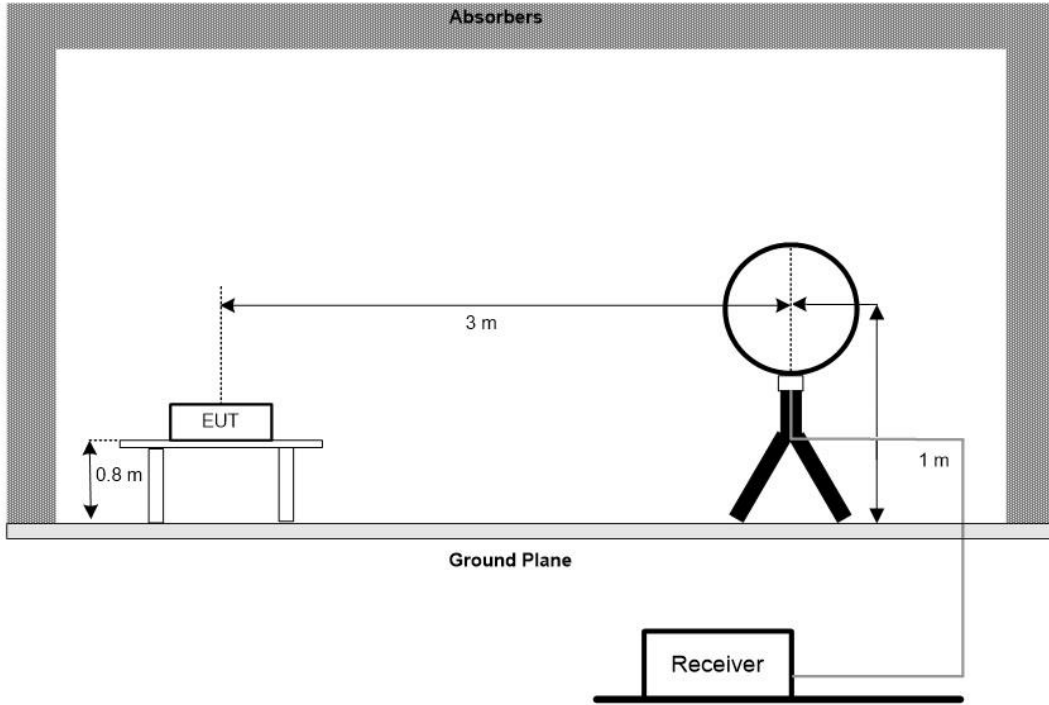

**30 MHz to 1 GHz**

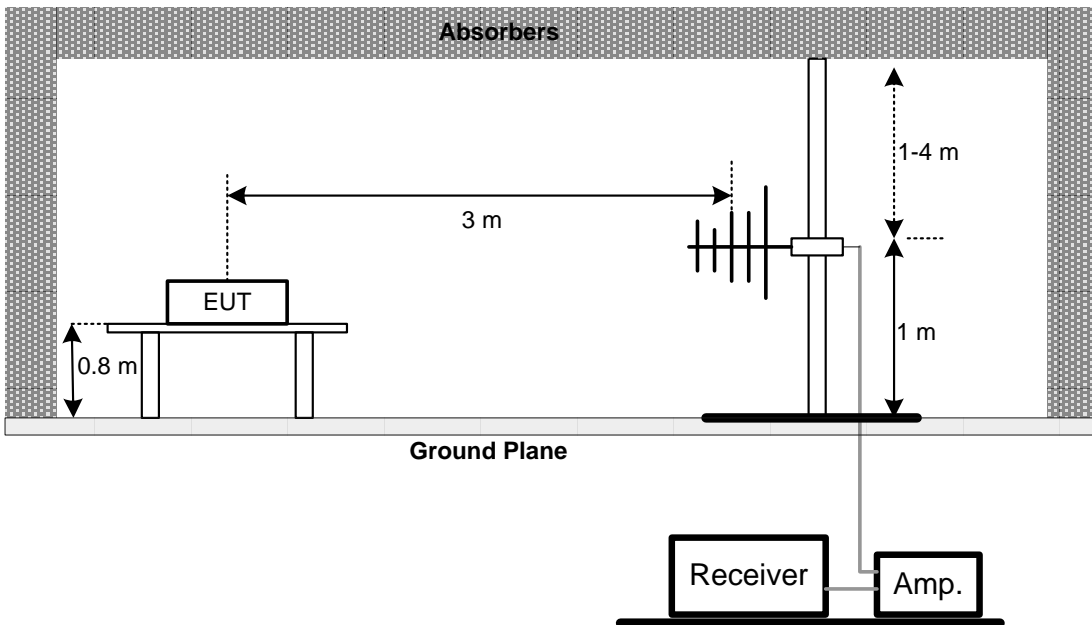

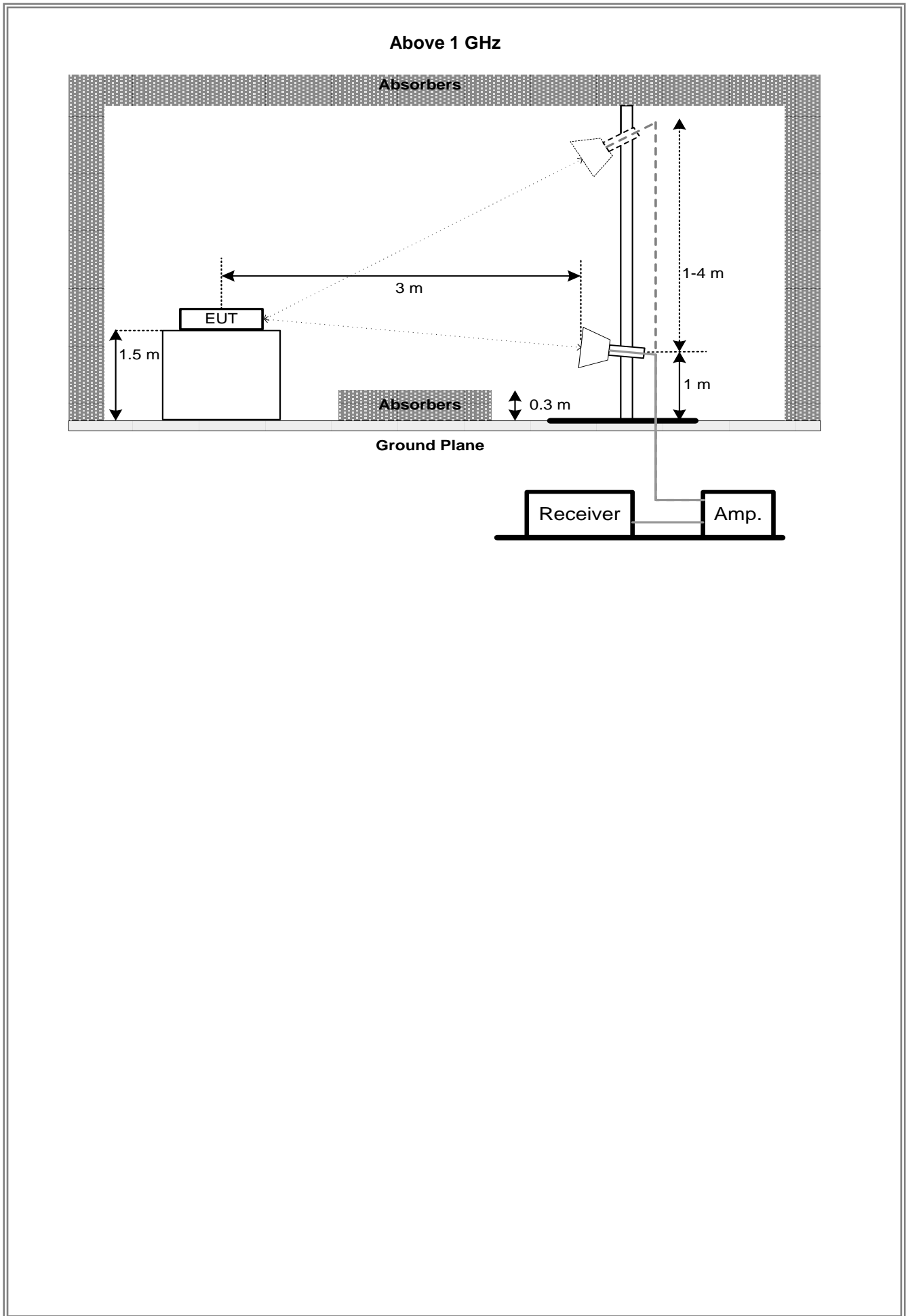

#### **4.5 EUT OPERATION CONDITIONS**

The EUT was programmed to be in continuously transmitting mode.

#### **4.6 TEST RESULTS - 9 KHZ TO 30MHZ**

Please refer to the APPENDIX B.

Remark:

- (1) Distance extrapolation factor =  $40 \log(\text{specific distance} / \text{test distance})$  (dB).
- (2) Limit line = specific limits (dBuV) + distance extrapolation factor.

#### **4.7 TEST RESULTS - 30 MHZ TO 1000MHZ**

Please refer to the APPENDIX C.

#### **4.8 TEST RESULTS- ABOVE 1000MHZ**

Please refer to the APPENDIX D.

Remark:

- (1) No limit: This is fundamental signal, the judgment is not applicable.  
For fundamental signal judgment was referred to Peak output test.

## 5.BANDWIDTH

### 5.1LIMIT

Section	Test Item	Limit
FCC 15.247(a)(2)	6dB Bandwidth	Minimum 500 kHz
	99% Emission Bandwidth	-

### 5.2TEST PROCEDURE

- The EUT was directly connected to the tonscend test system and antenna output port as show in the block diagram below.
- The following table is the setting of the spectrum analyzer:

For 6 dB Bandwidth:

Spectrum Parameters	Setting
Span Frequency	> Measurement Bandwidth
RBW	100 kHz
VBW	300 kHz
Detector	Peak
Trace	Max Hold
Sweep Time	Auto

For 99% Emission Bandwidth:

Spectrum Parameters	Setting
Span Frequency	Between 1.5 times and 5.0 times the OBW
RBW	300 kHz For 20MHz 1 MHz For 40MHz
VBW	1 MHz For 20MHz 3 MHz For 40MHz
Detector	Peak
Trace	Max Hold
Sweep Time	Auto

### 5.3DEVIATION FROM STANDARD

No deviation.

### 5.4TEST SETUP

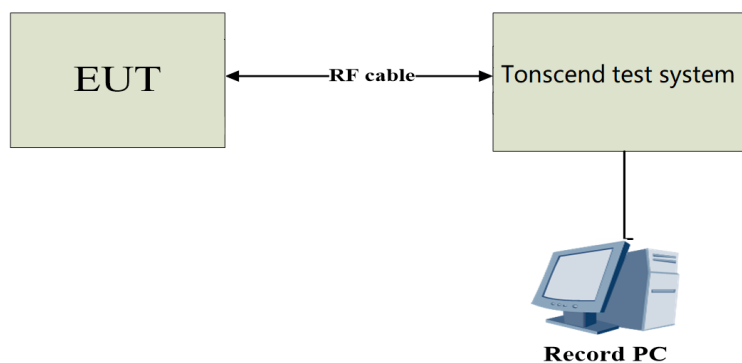

### 5.5EUT OPERATION CONDITIONS

The EUT was programmed to be in continuously transmitting mode.

### 5.6TESTRESULTS

Please refer to the APPENDIX E.



**6. MAXIMUM OUTPUT POWER**

**6.1 LIMIT**

Section	Test Item	Limit
FCC 15.247(b)(3)	Maximum Output Power	1.0000Watt or 30.00 dBm

**6.2 TEST PROCEDURE**

- a. The EUT was directly connected to the tonscend test system and antenna output port as show in the block diagram below.
- b. The maximum conducted output power was performed in accordance with method 11.9.1.3(for Average power)of ANSI C63.10-2013 and FCC KDB 662911 D01 v02r01 Multiple Transmitter Output.

**6.3 DEVIATION FROM STANDARD**

No deviation.

**6.4 TEST SETUP**

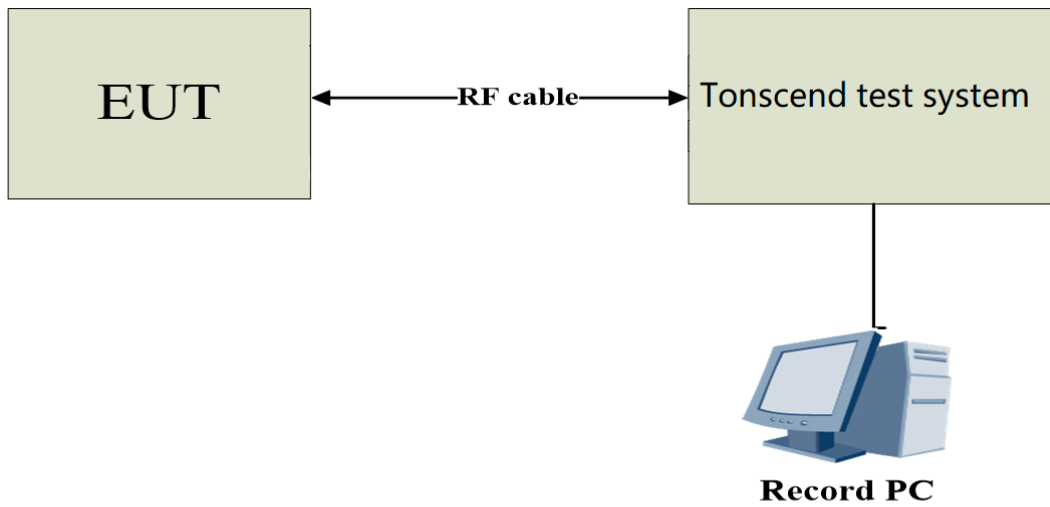

**6.5 EUT OPERATION CONDITIONS**

The EUT was programmed to be in continuously transmitting mode.

**6.6 TEST RESULTS**

Please refer to the APPENDIX F.

## 7.CONDUCTED SPURIOUS EMISSIONS

### 7.1 LIMIT

In any 100 kHz bandwidth outside the frequency band in which the spread spectrum or digitally modulated intentional radiator is operating, the radio frequency power that is produced by the intentional radiator shall be at least 20 dB below that in the 100 kHz bandwidth within the band that contains the highest level of the desired power, based on either an RF conducted or a radiated measurement, provided the transmitter demonstrates compliance with the peak Output Power limits. If the transmitter complies with the Output Power limits based on the use of RMS averaging over a time interval, as permitted under paragraph (b)(3) of this section, the attenuation required under this paragraph shall be 30 dB instead of 20 dB. Attenuation below the general limits specified in Section 15.209(a) is not required.

### 7.2TEST PROCEDURE

- a. The EUT was directly connected to the tonscend test system and antenna output port as show in the block diagram below.
- b. The following table is the setting of the spectrum analyzer:

Spectrum Parameters	Setting
Start Frequency	30 MHz
Stop Frequency	26.5 GHz
RBW	100 kHz
VBW	300 kHz
Detector	Peak
Trace	Max Hold
Sweep Time	Auto

### 7.3DEVIATION FROM STANDARD

No deviation.

### 7.4TEST SETUP

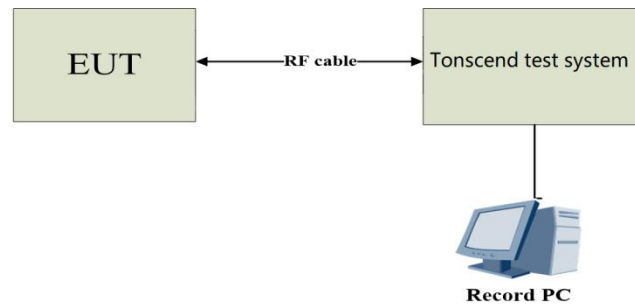

### 7.5EUT OPERATION CONDITIONS

The EUT was programmed to be in continuously transmitting mode.

### 7.6TESTRESULTS

Please refer to the APPENDIX G.

## 8.POWER SPECTRAL DENSITY

### 8.1LIMIT

Section	Test Item	Limit
FCC 15.247(e)	Power Spectral Density	8 dBm (in any 3 kHz)

### 8.2TEST PROCEDURE

- The EUT was directly connected to the tonscend test system and antenna output port as show in the block diagram below.
- The following table is the setting of the spectrum analyzer:

Spectrum Parameters	Setting
Span Frequency	1.5 times the DTS bandwidth
RBW	3 kHz
VBW	10 kHz
Detector	RMS
Trace	Max Hold
Sweep Time	Auto

### 8.3DEVIATION FROM STANDARD

No deviation.

### 8.4TEST SETUP

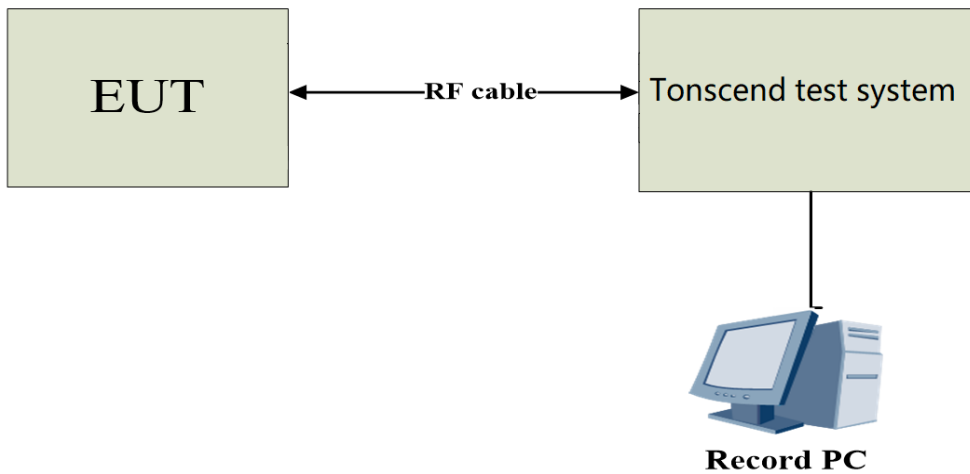

### 8.5EUT OPERATION CONDITIONS

The EUT was programmed to be in continuously transmitting mode.

### 8.6TESTRESULTS

Please refer to the APPENDIX H.

## 9. MEASUREMENT INSTRUMENTS LIST

Name of Equipment	Manufacturer	Model Number	Serial Number	Last Calibration	Due Calibration
EMI Receiver	Rohde&Schwarz	ESIB 40	YH-TIRT-SAC-966 -20220911	2024/01/05	2025/01/04
Integral Antenna	Schwarzbeck	VULB 9163	01314	2022.12.11	2024.12.10
Integral Antenna	Rohde&Schwarz	HF907	RSM2991424	2022.12.11	2024.12.10
Preamplifier	Emtrace	RP01A	'02017	2024/01/05	2025/01/04
Preamplifier	Schwarzbeck	BBV9744	00143	2024/01/05	2025/01/04
Loop Antenna	ZHINAN	ZN30900A	12024	2024/01/05	2025/01/04
Horn Antenna	Schwarzbeck	BBHA9170	00956	2024/01/05	2025/01/04
RF Cable	/	LMR400UF-NMNM-7. 0M	/	2024/01/05	2025/01/04
RF Cable	/	SFT2050PUR-NMNM -7.0M	/	2024/01/05	2025/01/04
EMI Receiver	Rohde&Schwarz	ESR7	1316.3003K07-10 2611-mk	2023/11/02	2024/11/01
LISN	Rohde&Schwarz	ENV216	3560.655.12-1029 15-Bp	2023/11/02	2024/11/01
RF Cable	\	SFT2050PUR-NMNM -2.0M	\	2024/01/05	2025/01/04
Spectrum analyzer	ROHDE&SCHWARZ	FSU26	200732	2024/01/05	2025/01/04
Spectrum analyzer	ROHDE&SCHWARZ	FSV40-N	101722	2024/01/05	2025/01/04
Filter	HEWLETT PACKARD	JS0806-F	19K8060209	2024/01/05	2025/01/04

Remark: "N/A" denotes no model name, serial no. or calibration specified.

**10.EUT TEST PHOTO**

**AC Power Line Conducted Emissions Test Photos**

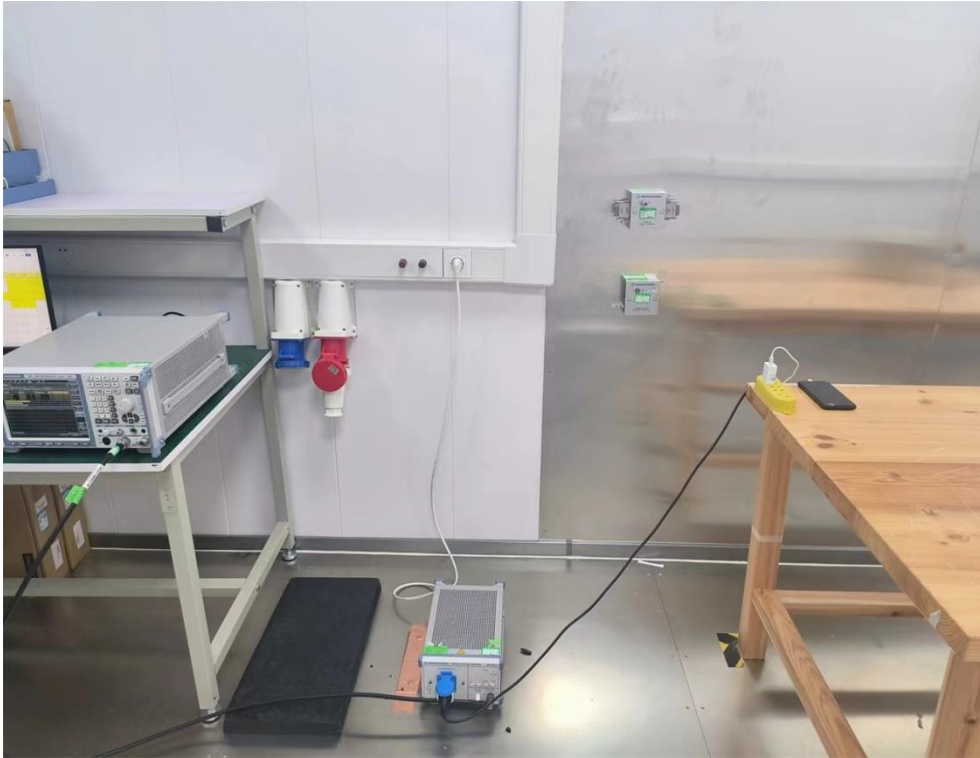

**Radiated Emissions Test Photos**

**30 MHz to 1 GHz**

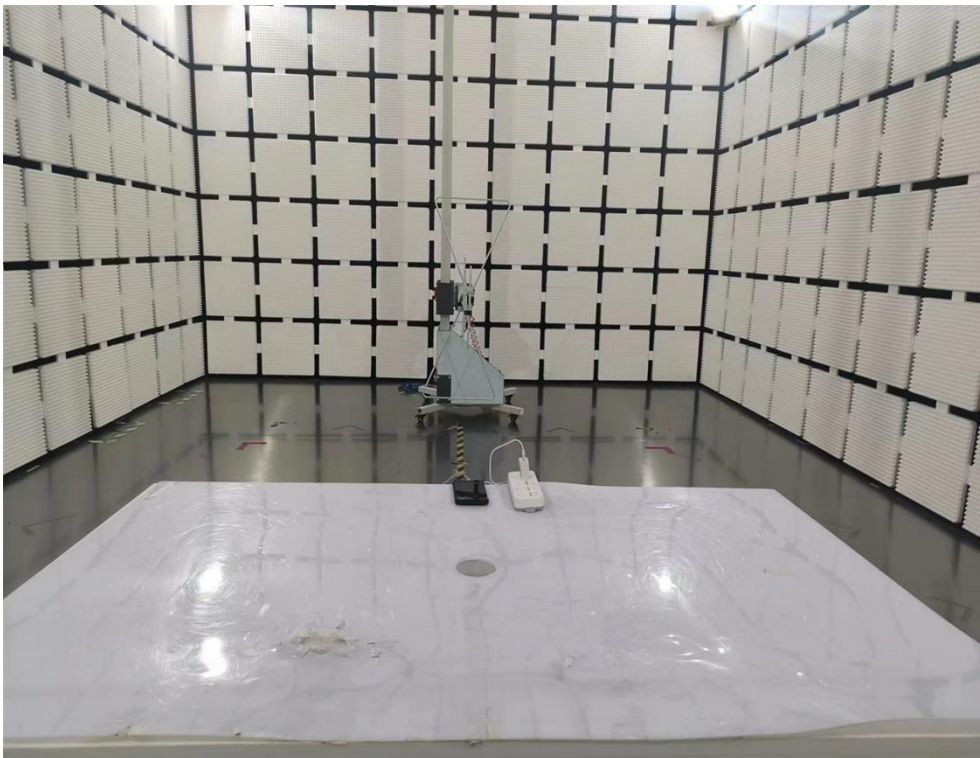



**Radiated Emissions Test Photos**

**Above 1 GHz**



**Conducted Test Photos**



**11. PHOTOS OF EUT**





















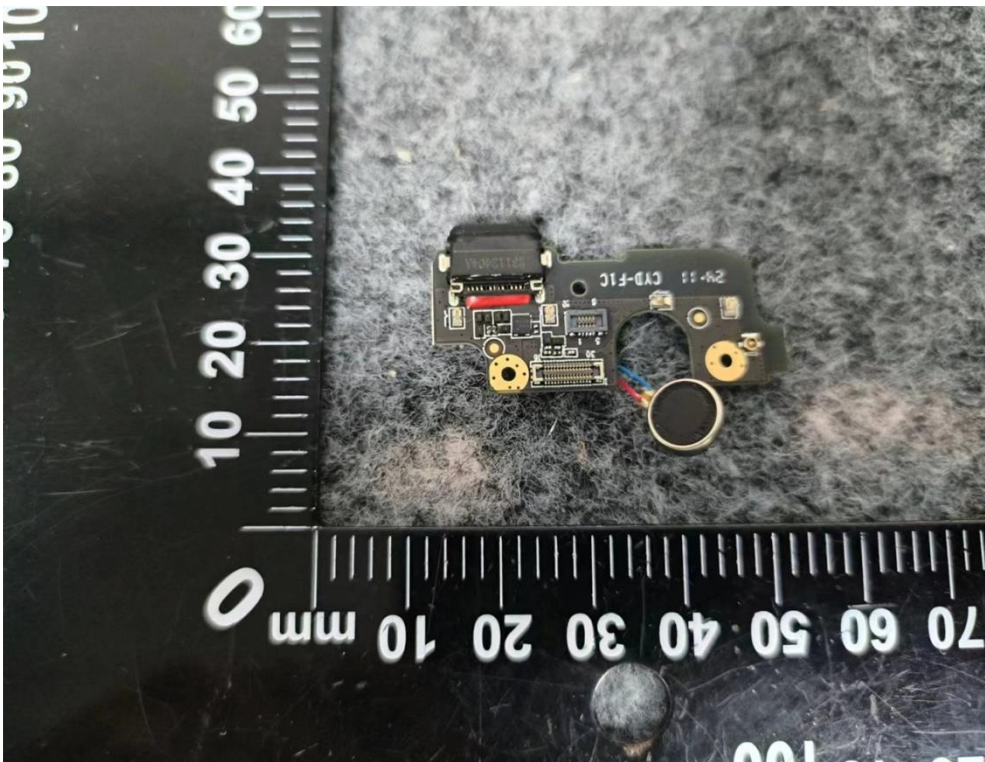
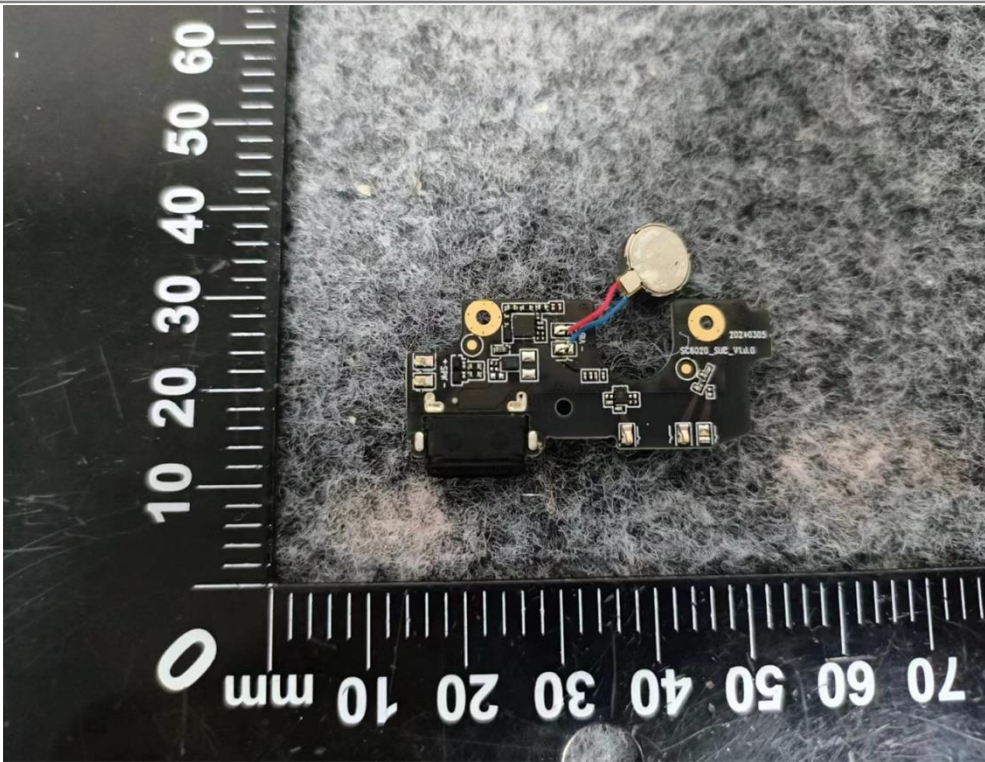





## APPENDIX A - AC POWER LINE CONDUCTED EMISSIONS

Test Mode	TX G Mode Channel 01	Phase	Line
-----------	----------------------	-------	------

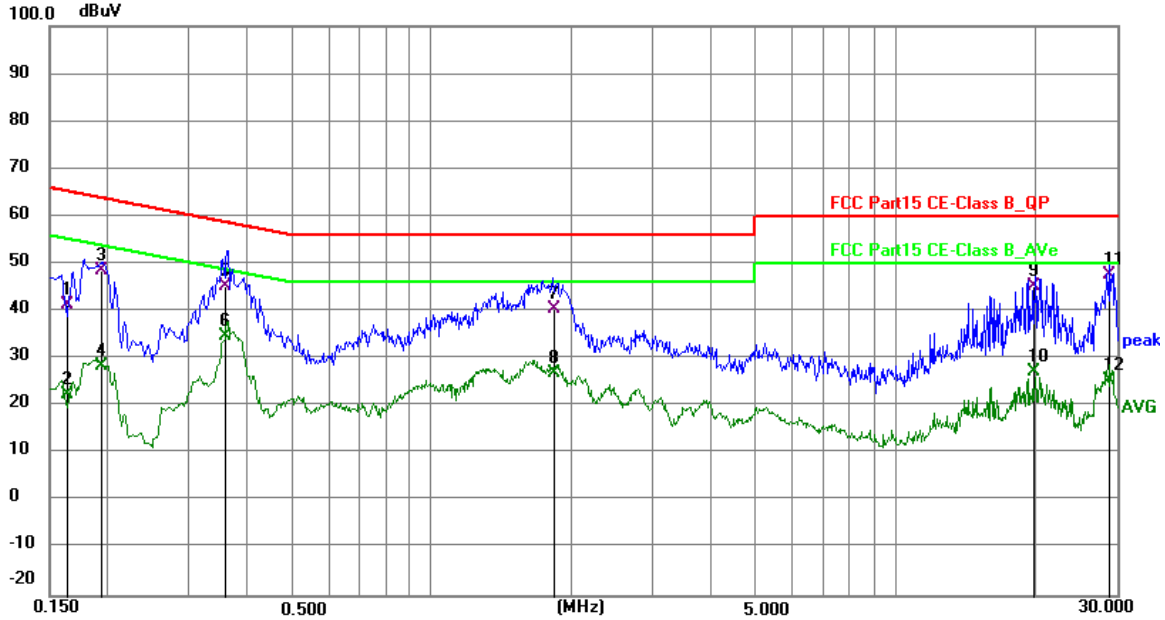

No.	Frequency (MHz)	Reading (dBuV)	Factor (dB)	Level (dBuV)	Limit (dBuV)	Margin (dB)	Detector	P/F	Remark
1	0.1643	31.79	9.63	41.42	65.24	-23.82	QP	P	
2	0.1643	12.96	9.63	22.59	55.24	-32.65	AVG	P	
3	0.1949	38.99	9.63	48.62	63.83	-15.21	QP	P	
4	0.1949	18.68	9.63	28.31	53.83	-25.52	AVG	P	
5	0.3588	35.68	9.63	45.31	58.76	-13.45	QP	P	
6	0.3588	25.26	9.63	34.89	48.76	-13.87	AVG	P	
7	1.8371	30.68	9.65	40.33	56.00	-15.67	QP	P	
8	1.8371	17.41	9.65	27.06	46.00	-18.94	AVG	P	
9	19.9814	35.50	9.78	45.28	60.00	-14.72	QP	P	
10	19.9814	17.34	9.78	27.12	50.00	-22.88	AVG	P	
11 *	28.9095	37.95	9.73	47.68	60.00	-12.32	QP	P	
12	28.9095	15.63	9.73	25.36	50.00	-24.64	AVG	P	

**REMARKS:**

- (1) Measurement Value = Reading Level + Correct Factor.
- (2) Margin Level = Measurement Value - Limit Value.

Test Mode	TX G Mode Channel 01	Phase	Neutral
-----------	----------------------	-------	---------

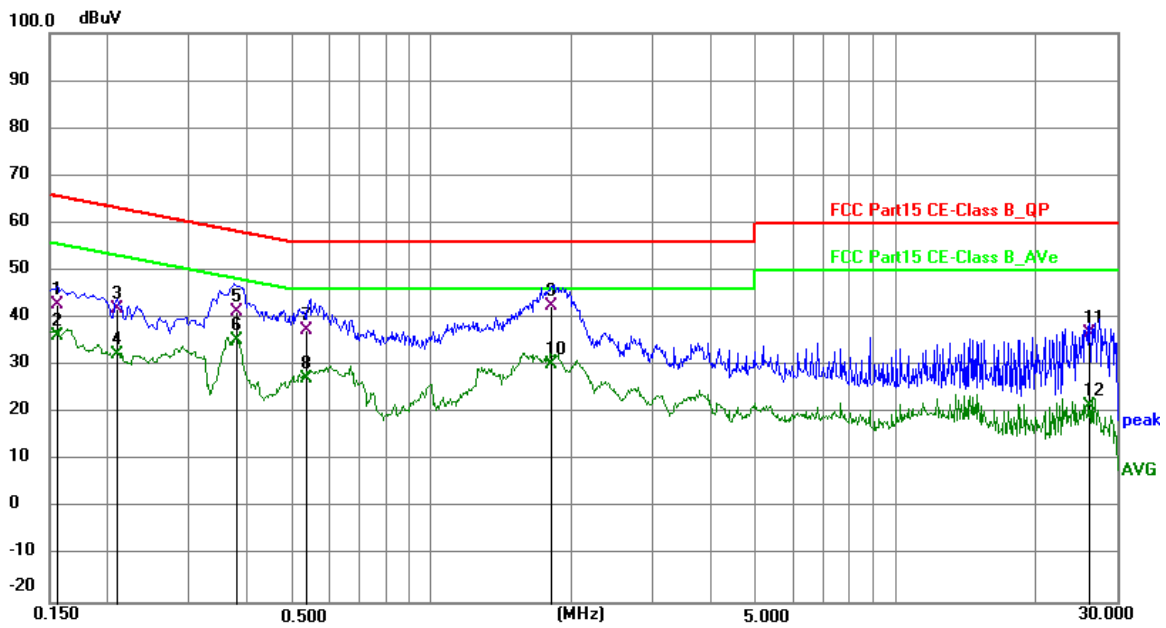

No.	Frequency (MHz)	Reading (dBuV)	Factor (dB)	Level (dBuV)	Limit (dBuV)	Margin (dB)	Detector	P/F	Remark
1	0.1556	33.29	9.62	42.91	65.70	-22.79	QP	P	
2	0.1556	26.63	9.62	36.25	55.70	-19.45	AVG	P	
3	0.2084	32.42	9.63	42.05	63.27	-21.22	QP	P	
4	0.2084	22.82	9.63	32.45	53.27	-20.82	AVG	P	
5	0.3792	31.78	9.62	41.40	58.30	-16.90	QP	P	
6 *	0.3792	25.61	9.62	35.23	48.30	-13.07	AVG	P	
7	0.5412	27.73	9.62	37.35	56.00	-18.65	QP	P	
8	0.5412	17.70	9.62	27.32	46.00	-18.68	AVG	P	
9	1.8190	32.94	9.65	42.59	56.00	-13.41	QP	P	
10	1.8190	20.63	9.65	30.28	46.00	-15.72	AVG	P	
11	26.2590	27.09	9.82	36.91	60.00	-23.09	QP	P	
12	26.2590	11.69	9.82	21.51	50.00	-28.49	AVG	P	

**REMARKS:**

- (1) Measurement Value = Reading Level + Correct Factor.
- (2) Margin Level = Measurement Value - Limit Value.



## **APPENDIX B - RADIATED EMISSION - 9 KHZ TO 30 MHZ**

The low frequency, which started from 9 kHz to 30MHz, was pre-scanned and the result which was 20dB lower than the limit line was not reported.

There is a comparison data of both open-field test site and semi-Anechoic chamber, and the result came out very similar.