

# DATA SHEET

## WIRELESS COMPONENTS

Ceramic Chip Antenna

ANT1005LL14R2400A

2.4 - 2.5GHz

I005 Series



FEATURES

- Compact size
- Omni-directional Radiation
- Tape & reel automatic mounting
- Reflow process compatible
- RoHS compliant

APPLICATIONS

- 2.4GHz WiFi device
- Bluetooth gadget
- Zigbee device
- ISM band equipment

ORDERING INFORMATION

All part numbers are identified by the series, packing type, material, size, antenna type, working frequency and packing quantity.

**PART NUMBER**

**ANT 1005 L L14 R 2400A**  
 (1) (2) (3) (4) (5) (6)

---

**(1) PRODUCT**

ANT = Antenna

---

**(2) SIZE**

1005 = 1.0 × 0.5 mm

---

**(3) ANTENNA TYPE**

L,F,A = Chip Antenna

---

**(4) SERIAL NO.**

L14

---

**(5) PACKING STYLE**

R = Tape and Reel

---

**(6) WORKING FREQUENCY**

2400 = 2.4GHz

**SPECIFICATION**

Table 1

DESCRIPTION	VALUE
Working Frequency	2.4 ~ 2.484 GHz
Bandwidth	120 MHz(Typ.)
VSWR	3.0 Max
Polarization	Linear
Azimuth Beamwidth	Omni-directional
Peak Gain	3.5 dBi(Typ.)
Impedance	50 Ω
Operating Temperature	- 40~105 °C
Maximum Power	1 W
Termination	Ag (Environmentally-Friendly Leadless)
Resistance to Soldering Heats	260°C , 5sec.

**NOTE**

1. The specification is defined on Yageo evaluation board

**DIMENSIONS**

Table 2 Mechanical Dimension

	DIMENSION
L (mm)	1.0 ±0.10
W (mm)	0.5 ±0.10
T (mm)	0.37(max)
P1 (mm)	0.25 +0.1/-0.05
P2 (mm)	0.15 +0.1/-0.05
P3 (mm)	0.25 +0.1/-0.05
P4 (mm)	0.15 +0.1/-0.05

**OUTLINES**

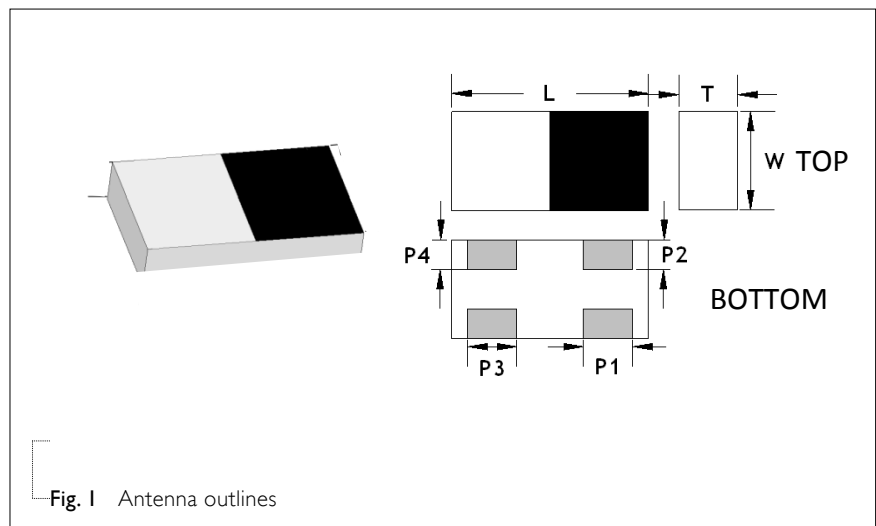

Fig. 1 Antenna outlines

Table 3 Termination configuration

TERMINAL NAME	FUNCTION
P1	Ground Point
P2	Ground Point
P3	Feeding Point
P4	Feeding Point

REFERENCE DESIGN OF EVALUATION BOARD

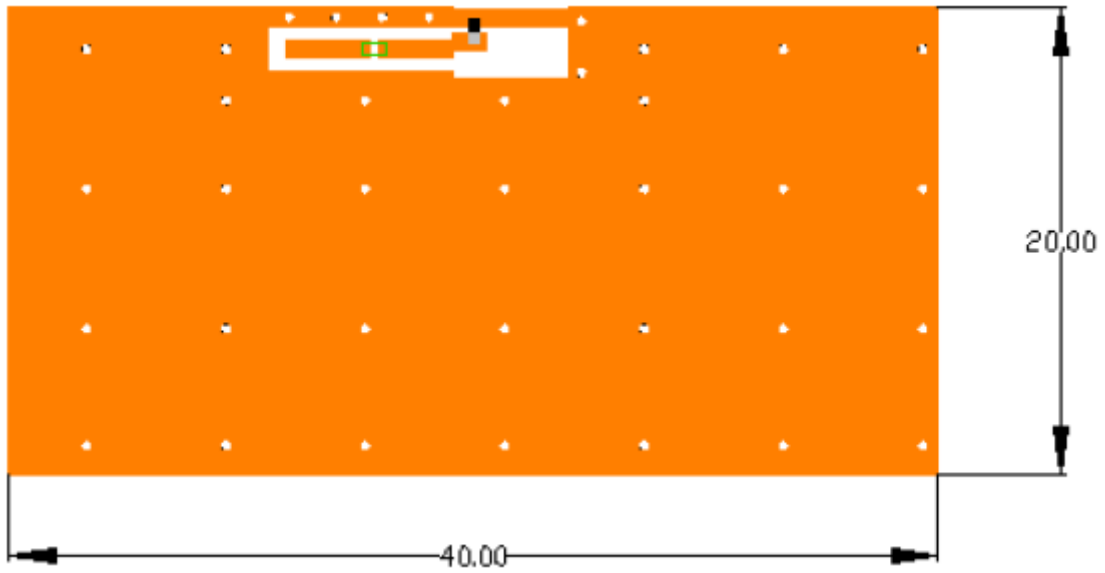
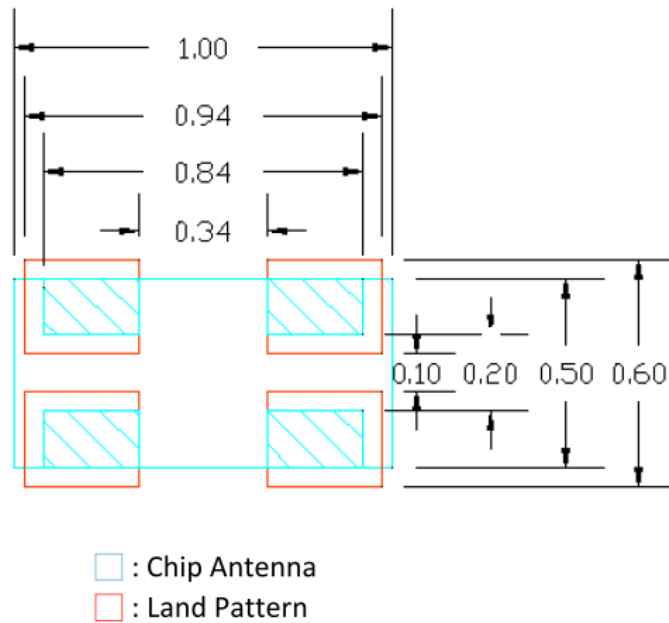

Fig. 2 Outlook and dimension of evaluation board



**Unit:mm**

Fig. 3 Footprint

**Clearance size: 5x 3mm**

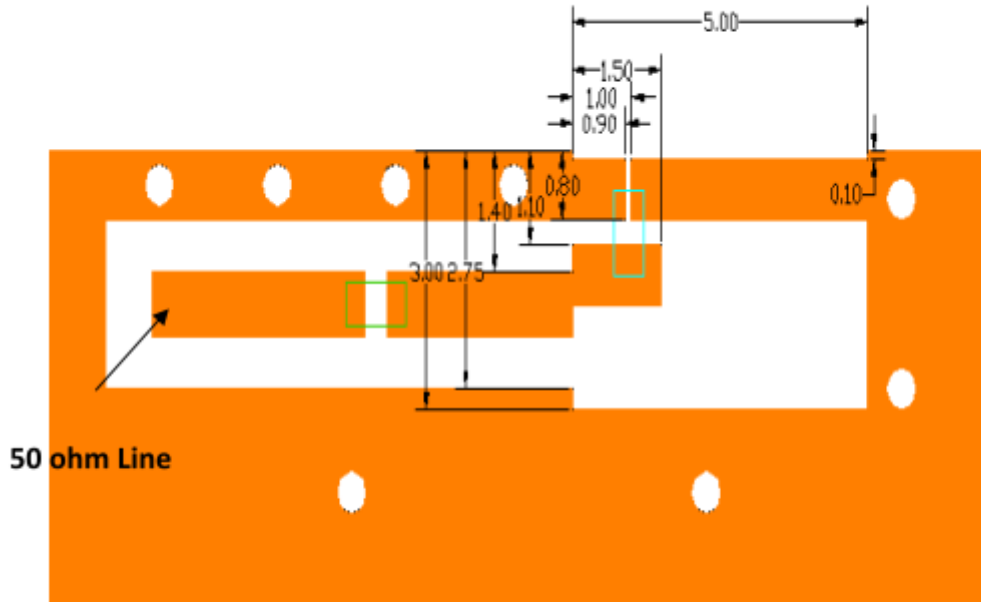

Unit : mm

- : Chip Antenna
- : L/C matching components
- : Land Pattern

Fig. 4 Details of soldering Pad

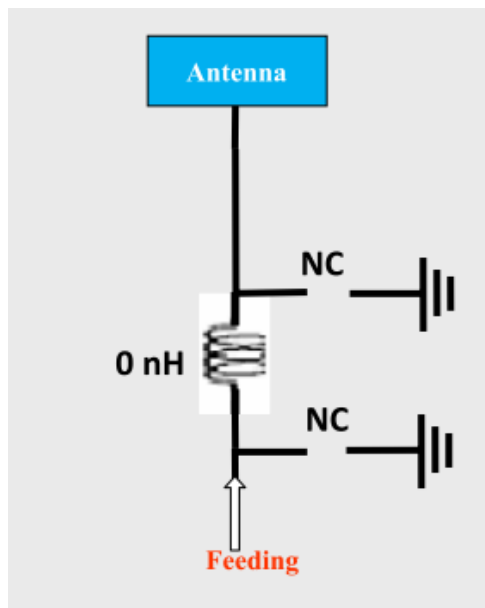

**ELECTRICAL PERFORMANCES**

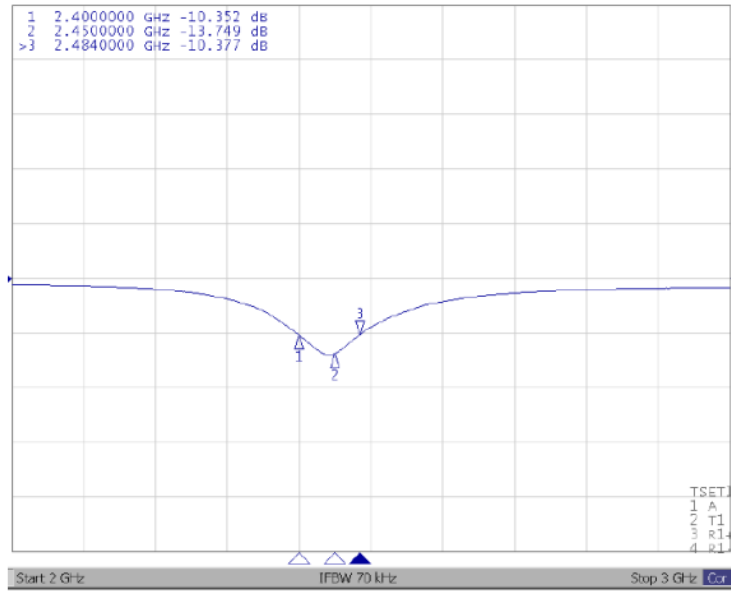

**Fig. 5** Return loss

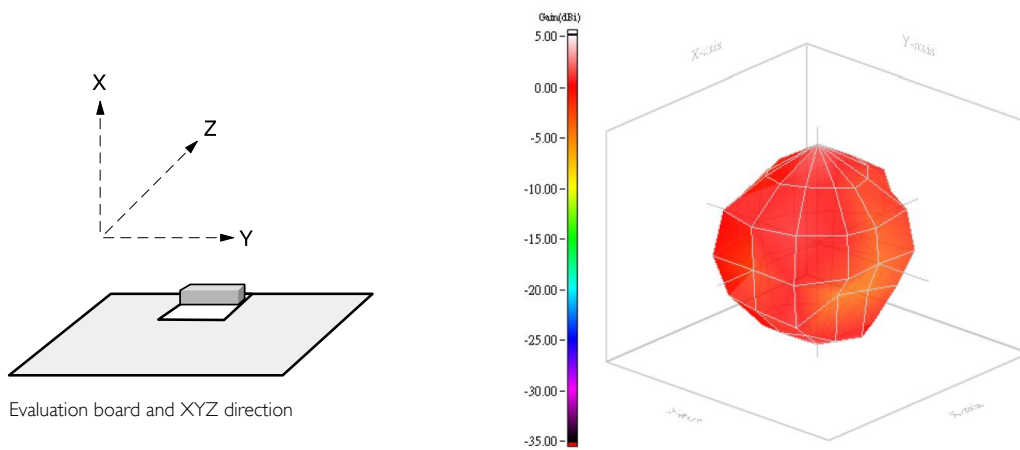

**Fig. 6** Radiation pattern

REVISION HISTORY

REVISION	DATE	CHANGE NOTIFICATION	DESCRIPTION
Version 0	Feb. 14, 2017	-	- New data sheet for SMD type antenna, 2.45GHz application, I005 series PIFA mode