



# FCC Radio Test Report

## FCC ID: 2AX2V-A1799

### Original Grant

**Report No.** : TB-FCC176513  
**Applicant** : Shenzhen Tilv Technology Co., Ltd  
**Equipment Under Test (EUT)**  
**EUT Name** : 360°object tracking holder  
**Model No.** : A1799,  
**Series Model No.** : TRACK AI, TRACK ROBOT, T-1799, IJOY TRACK,  
IJPSTRK01, 360 VIEW, 360 TRACK, SMART TRIPOD,  
SMART HOLDER, A2252  
**Brand Name** : N/A  
**Sample ID** : TBBJ-20200923-12-1#& TBBJ-20200923-12-2#  
**Receipt Date** : 2020-10-15  
**Test Date** : 2020-10-15 to 2020-11-02  
**Issue Date** : 2020-11-02  
**Standards** : FCC Part 15, Subpart C 15.247  
**Test Method** : ANSI C63.10: 2013  
**Conclusions** : **PASS**

In the configuration tested, the EUT complied with the standards specified above,  
The EUT technically complies with the FCC requirements

**Test/Witness Engineer** :   
**Engineer Supervisor** :   
**Engineer Manager** : 

Jack Deng

Ivan Su

Ray Lai

This report details the results of the testing carried out on one sample. The results contained in this test report do not relate to other samples of the same product. The manufacturer should ensure that all products in series production are in conformity with the product sample detailed in the report.

## Contents

<b>CONTENTS</b> .....	<b>2</b>
<b>1. GENERAL INFORMATION ABOUT EUT</b> .....	<b>5</b>
1.1 Client Information.....	5
1.2 General Description of EUT (Equipment Under Test) .....	5
1.3 Block Diagram Showing the Configuration of System Tested.....	7
1.4 Description of Support Units .....	7
1.5 Description of Test Mode.....	8
1.6 Description of Test Software Setting .....	9
1.7 Measurement Uncertainty .....	9
1.8 Test Facility.....	10
<b>2. TEST SUMMARY</b> .....	<b>11</b>
<b>3. TEST SOFTWARE</b> .....	<b>11</b>
<b>4. TEST EQUIPMENT</b> .....	<b>12</b>
<b>5. CONDUCTED EMISSION TEST</b> .....	<b>13</b>
5.1 Test Standard and Limit.....	13
5.2 Test Setup.....	13
5.3 Test Procedure.....	14
5.4 Deviation From Test Standard.....	14
5.5 EUT Operating Mode .....	14
5.6 Test Data.....	14
<b>6. RADIATED EMISSION TEST</b> .....	<b>15</b>
6.1 Test Standard and Limit.....	15
6.2 Test Setup.....	16
6.3 Test Procedure.....	17
6.4 Deviation From Test Standard.....	17
6.4 EUT Operating Condition .....	17
6.5 Test Data.....	17
<b>7. RESTRICTED BANDS REQUIREMENT</b> .....	<b>18</b>
7.1 Test Standard and Limit.....	18
7.2 Test Setup.....	18
7.3 Test Procedure.....	19
7.4 Deviation From Test Standard.....	19
7.5 EUT Operating Condition .....	19
7.6 Test Data.....	19
<b>8. NUMBER OF HOPPING CHANNEL</b> .....	<b>20</b>
8.1 Test Standard and Limit.....	20
8.2 Test Setup.....	20
8.3 Test Procedure.....	20
8.4 Deviation From Test Standard.....	20
8.5 EUT Operating Condition .....	20

---

---

8.6 Test Data.....	20
<b>9. AVERAGE TIME OF OCCUPANCY.....</b>	<b>21</b>
9.1 Test Standard and Limit.....	21
9.2 Test Setup.....	21
9.3 Test Procedure.....	21
9.4 EUT Operating Condition .....	21
9.4 Deviation From Test Standard.....	22
9.5 EUT Operating Condition .....	22
9.6 Test Data.....	22
<b>10. CHANNEL SEPARATION AND BANDWIDTH TEST.....</b>	<b>23</b>
10.1 Test Standard and Limit .....	23
10.2 Test Setup.....	23
10.3 Test Procedure.....	23
10.4 Deviation From Test Standard.....	24
10.5 EUT Operating Condition .....	24
10.6 Test Data.....	24
<b>11. PEAK OUTPUT POWER TEST.....</b>	<b>25</b>
11.1 Test Standard and Limit .....	25
11.2 Test Setup.....	25
11.3 Test Procedure.....	25
11.4 Deviation From Test Standard.....	25
11.5 EUT Operating Condition .....	25
11.6 Test Data.....	25
<b>12. ANTENNA REQUIREMENT.....</b>	<b>26</b>
12.1 Standard Requirement.....	26
12.2 Deviation From Test Standard.....	26
12.3 Antenna Connected Construction.....	26
12.4 Result.....	26
<b>ATTACHMENT A-- RADIATED EMISSION TEST DATA .....</b>	<b>27</b>
<b>ATTACHMENT B-- RESTRICTED BANDS REQUIREMENT AND BAND EDGE TEST DATA</b> <b>.....</b>	<b>32</b>
<b>ATTACHMENT C-- NUMBER OF HOPPING CHANNEL TEST DATA.....</b>	<b>38</b>
<b>ATTACHMENT D-- AVERAGE TIME OF OCCUPANCY TEST DATA.....</b>	<b>39</b>
<b>ATTACHMENT E-- CHANNEL SEPARATION AND BANDWIDTH TEST DATA .....</b>	<b>41</b>
<b>ATTACHMENT F-- PEAK OUTPUT POWER TEST DATA.....</b>	<b>44</b>



# 1. General Information about EUT

## 1.1 Client Information

<b>Applicant</b>	:	Shenzhen Tilv Technology Co., Ltd
<b>Address</b>	:	4/F Dongshan No.8 factory, Difu Rd., Gushu Community, Xixiang St., Baoan District, Shenzhen, China
<b>Manufacturer</b>	:	Shenzhen Tilv Technology Co., Ltd
<b>Address</b>	:	4/F Dongshan No.8 factory, Difu Rd., Gushu Community, Xixiang St., Baoan District, Shenzhen, China

## 1.2 General Description of EUT (Equipment Under Test)

<b>EUT Name</b>	:	360°object tracking holder	
<b>Models No.</b>	:	A1799, TRACK AI, TRACK ROBOT, T-1799, IJOY TRACK, IJPSTRK01, 360 VIEW, 360 TRACK, SMART TRIPOD, SMART HOLDER, A2252	
<b>Model Difference</b>	:	All these models are identical in the same PCB, layout and electrical circuit, the only difference is Housing.	
<b>Product Description</b>	:	Operation Frequency:	Bluetooth V5.0: 2402~2480 MHz
		Number of Channel:	79 Channels <small>See Note 2</small>
		Max Peak Output Power:	GFSK: 3.757dBm
		Antenna Gain:	0 dBi PCB Antenna
		Modulation Type:	GFSK
<b>Power Supply</b>	:	Input: 3*1.5 AA Battery	
<b>Software Version</b>	:	V1.2	
<b>Hardware Version</b>	:	V2.0	
<b>Connecting I/O Port(S)</b>	:	Please refer to the User's Manual	

**Note:**

(1) This Test Report is FCC Part 15.247 for Bluetooth.

(2) For a more detailed features description, please refer to the manufacturer’s specifications or the User’s Manual.

(3) Channel List:

Bluetooth Channel List					
Channel	Frequency (MHz)	Channel	Frequency (MHz)	Channel	Frequency (MHz)
<b>00</b>	<b>2402</b>	27	2429	54	2456
01	2403	28	2430	55	2457
02	2404	29	2431	56	2458
03	2405	30	2432	57	2459
04	2406	31	2433	58	2460
05	2407	32	2434	59	2461
06	2408	33	2435	60	2462
07	2409	34	2436	61	2463
08	2410	35	2437	62	2464
09	2411	36	2438	63	2465
10	2412	37	2439	64	2466
11	2413	38	2440	65	2467
12	2414	<b>39</b>	<b>2441</b>	66	2468
13	2415	40	2442	67	2469
14	2416	41	2443	68	2470
15	2417	42	2444	69	2471
16	2418	43	2445	70	2472
17	2419	44	2446	71	2473
18	2420	45	2447	72	2474
19	2421	46	2448	73	2475
20	2422	47	2449	74	2476
21	2423	48	2450	75	2477
22	2424	49	2451	76	2478
23	2425	50	2452	77	2479
24	2426	51	2453	<b>78</b>	<b>2480</b>
25	2427	52	2454		
26	2428	53	2455		

(4) The Antenna information about the equipment is provided by the applicant.

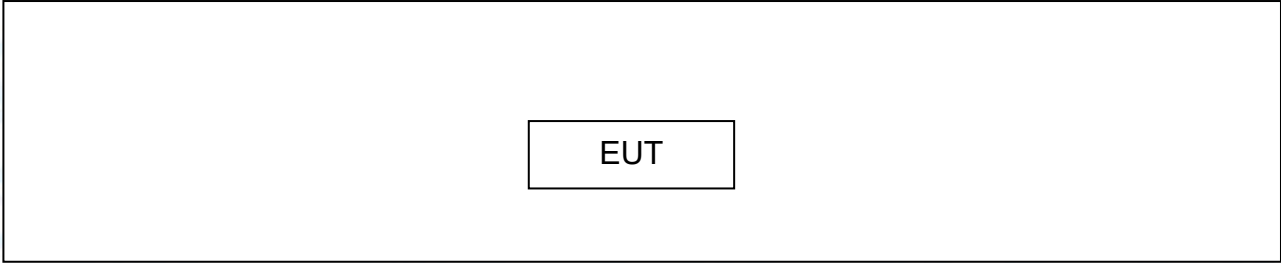
**1.3 Block Diagram Showing the Configuration of System Tested****TX Mode****1.4 Description of Support Units**

<b>Equipment Information</b>				
<b>Name</b>	<b>Model</b>	<b>FCC ID/VOC</b>	<b>Manufacturer</b>	<b>Used “√”</b>
----	-----	---	----	----
<b>Cable Information</b>				
<b>Number</b>	<b>Shielded Type</b>	<b>Ferrite Core</b>	<b>Length</b>	<b>Note</b>
----	-----	----	-----	----

### 1.5 Description of Test Mode

To investigate the maximum EMI emission characteristics generates from EUT, the test system was pre-scanning tested base on the consideration of following EUT operation mode or test configuration mode which possible have effect on EMI emission level. Each of these EUT operation mode(s) or test configuration mode(s) mentioned follow was evaluated respectively.

For Conducted Test	
Final Test Mode	Description
Mode 1	TX Mode Channel 00
For Radiated Test	
Final Test Mode	Description
Mode 1	TX GFSK Mode Channel 00
Mode 2	TX Mode(GFSK) Channel 00/39/78
Mode 3	Hopping Mode(GFSK)
<b>Note : (1)The adapter and antenna gain provided by the applicant, the verified for the RF conduction test provided by TOBY test lab.</b>	

**Note:**

- (1) For all test, we have verified the construction and function in typical operation. And all the test modes were carried out with the EUT in transmitting operation in maximum power with all kinds of data rate. We have pretested all the test modes above.  
According to ANSI C63.10 standards, the measurements are performed at the highest, middle, lowest available channels, and the worst case data rate as follows:  
TX Mode: GFSK (1 Mbps)
- (2) The EUT is considered a portable unit; it was pre-tested on the positioned of each 3 axis, X-plane, Y-plane and Z-plane. The worst case was found positioned on X-plane as the normal use. Therefore only the test data of this X-plane was used for radiated emission measurement test.



## 1.6 Description of Test Software Setting

During testing channel power controlling software provided by the customer was used to control the operating channel as well as the output power level. The RF output power selection is for the setting of RF output power expected by the customer and is going to be fixed on the firmware of the final end product power parameters of Bluetooth mode.

Test Software Version	FCC_assist		
Frequency	2402 MHz	2441MHz	2480 MHz
GFSK	DEF	DEF	DEF

## 1.7 Measurement Uncertainty

The reported uncertainty of measurement  $y \pm U$ , where expanded uncertainty  $U$  is based on a standard uncertainty multiplied by a coverage factor of  $k=2$ , providing a level of confidence of approximately 95 %.

Test Item	Parameters	Expanded Uncertainty ( $U_{Lab}$ )
Conducted Emission	Level Accuracy: 9kHz~150kHz 150kHz to 30MHz	$\pm 3.50$ dB $\pm 3.10$ dB
Radiated Emission	Level Accuracy: 9kHz to 30 MHz	$\pm 4.60$ dB
Radiated Emission	Level Accuracy: 30MHz to 1000 MHz	$\pm 4.50$ dB
Radiated Emission	Level Accuracy: Above 1000MHz	$\pm 4.20$ dB

## 1.8 Test Facility

The testing report were performed by the Shenzhen Toby Technology Co., Ltd., in their facilities located at 1A/F., Bldg.6, Yusheng Industrial Zone, The National Road No.107 Xixiang Section 467, Xixiang, Bao'an, Shenzhen, Guangdong, China. At the time of testing, the following bodies accredited the Laboratory:

### **CNAS (L5813)**

The Laboratory has been accredited by CNAS to ISO/IEC 17025: 2017 General Requirements for the Competence of Testing and Calibration Laboratories for the competence in the field of testing. And the Registration No.: CNAS L5813.

### **A2LA Certificate No.: 4750.01**

The laboratory has been accredited by American Association for Laboratory Accreditation(A2LA) to ISO/IEC 17025: 2017 General Requirements for the Competence of Testing and Calibration Laboratories for the technical competence in the field of Electrical Testing. And the A2LA Certificate No.: 4750.01. FCC Accredited Test Site Number: 854351.

### **IC Registration No.: (11950A)**

The Laboratory has been registered by Certification and Engineering Bureau of Industry Canada for radio equipment testing. The site registration: Site# 11950A.

## 2. Test Summary

FCC Part 15 Subpart C(15.247)/ RSS 247 Issue 2					
Standard Section		Test Item	Test Sample(s)	Judgment	Remark
FCC	IC				
15.203		Antenna Requirement	TBBJ-20200923-12-1#	PASS	N/A
15.207	RSS-GEN 7.2.2	Conducted Emission	TBBJ-20200923-12-2#	N/A	Note2
15.205	RSS-Gen 7.2.3	Restricted Bands	TBBJ-20200923-12-1#	PASS	N/A
15.247(a)(1)	RSS 247 5.1 (2)	Hopping Channel Separation	TBBJ-20200923-12-1#	PASS	N/A
15.247(a)(1)	RSS 247 5.1 (4)	Dwell Time	TBBJ-20200923-12-1#	PASS	N/A
15.247(b)(1)	RSS 247 5.4 (2)	Peak Output Power	TBBJ-20200923-12-1#	PASS	N/A
15.247(b)(1)	RSS 247 5.1 (4)	Number of Hopping Frequency	TBBJ-20200923-12-1#	PASS	N/A
15.247(d)	RSS 247 5.5	Band Edge	TBBJ-20200923-12-1#	PASS	N/A
15.247(c)& 15.209	RSS 247 5.5	Radiated Spurious Emission	TBBJ-20200923-12-1# TBBJ-20200923-12-2#	PASS	N/A
15.247(a)	RSS 247 5.1 (1)	99% Occupied Bandwidth & 20dB Bandwidth	TBBJ-20200923-12-1#	PASS	N/A

**Note1:** N/A is an abbreviation for Not Applicable.

**Note2:** The EUT is powered by AA battery, no requirement for this test item.

## 3. Test Software

Test Item	Test Software	Manufacturer	Version No.
Conducted Emission	EZ-EMC	EZ	CDI-03A2
Radiation Emission	EZ-EMC	EZ	FA-03A2RE
RF Conducted Measurement	MTS-8310	MWRfTest	V2.0.0.0

## 4. Test Equipment

Conducted Emission Test					
Equipment	Manufacturer	Model No.	Serial No.	Last Cal.	Cal. Due Date
EMI Test Receiver	Rohde & Schwarz	ESCI	100321	Jul. 06, 2020	Jul. 05, 2021
RF Switching Unit	Compliance Direction Systems Inc	RSU-A4	34403	Jul. 06, 2020	Jul. 05, 2021
AMN	SCHWARZBECK	NNBL 8226-2	8226-2/164	Jul. 06, 2020	Jul. 05, 2021
LISN	Rohde & Schwarz	ENV216	101131	Jul. 06, 2020	Jul. 05, 2021
Radiation Emission Test					
Equipment	Manufacturer	Model No.	Serial No.	Last Cal.	Cal. Due Date
Spectrum Analyzer	Agilent	E4407B	MY45106456	Jul. 06, 2020	Jul. 05, 2021
EMI Test Receiver	Rohde & Schwarz	ESPI	100010/007	Jul. 06, 2020	Jul. 05, 2021
Spectrum Analyzer	Rohde & Schwarz	FSV40-N	102197	Jul. 06, 2020	Jul. 05, 2021
Bilog Antenna	ETS-LINDGREN	3142E	00117537	Mar.01, 2020	Feb. 28, 2022
Horn Antenna	ETS-LINDGREN	3117	00143207	Mar.01, 2020	Feb. 28, 2022
Horn Antenna	ETS-LINDGREN	BBHA 9170	BBHA9170582	Mar.01, 2020	Feb. 28, 2022
Loop Antenna	SCHWARZBECK	FMZB 1519 B	1519B-059	Jul. 07, 2020	Jul. 06, 2021
Pre-amplifier	Sonoma	310N	185903	Mar.01, 2020	Feb. 28, 2021
Pre-amplifier	HP	8449B	3008A00849	Mar.01, 2020	Feb. 28, 2021
Pre-amplifier	SKET	LNPA_1840G-50	SK201904032	Mar.01, 2020	Feb. 28, 2021
Cable	HUBER+SUHNER	100	SUCOFLEX	Mar.01, 2020	Feb. 28, 2021
Positioning Controller	ETS-LINDGREN	2090	N/A	N/A	N/A
Antenna Conducted Emission					
Equipment	Manufacturer	Model No.	Serial No.	Last Cal.	Cal. Due Date
Spectrum Analyzer	Agilent	E4407B	MY45106456	Jul. 06, 2020	Jul. 05, 2021
Spectrum Analyzer	Rohde & Schwarz	ESPI	100010/007	Jul. 06, 2020	Jul. 05, 2021
MXA Signal Analyzer	Agilent	N9020A	MY49100060	Sep. 11, 2020	Sep. 10, 2021
Vector Signal Generator	Agilent	N5182A	MY50141294	Sep. 11, 2020	Sep. 10, 2021
Analog Signal Generator	Agilent	N5181A	MY50141953	Sep. 11, 2020	Sep. 10, 2021
RF Power Sensor	DARE!! Instruments	RadiPowerRPR3006W	17100015SNO26	Sep. 11, 2020	Sep. 10, 2021
	DARE!! Instruments	RadiPowerRPR3006W	17100015SNO29	Sep. 11, 2020	Sep. 10, 2021
	DARE!! Instruments	RadiPowerRPR3006W	17100015SNO31	Sep. 11, 2020	Sep. 10, 2021
	DARE!! Instruments	RadiPowerRPR3006W	17100015SNO33	Sep. 11, 2020	Sep. 10, 2021

## 5. Conducted Emission Test

### 5.1 Test Standard and Limit

5.1.1 Test Standard  
FCC Part 15.207

5.1.2 Test Limit

**Conducted Emission Test Limit**

Frequency	Maximum RF Line Voltage (dB $\mu$ V)	
	Quasi-peak Level	Average Level
150kHz~500kHz	66 ~ 56 *	56 ~ 46 *
500kHz~5MHz	56	46
5MHz~30MHz	60	50

Notes:

- (1) \*Decreasing linearly with logarithm of the frequency.
- (2) The lower limit shall apply at the transition frequencies.
- (3) The limit decrease in line with the logarithm of the frequency in the range of 0.15 to 0.50MHz.

### 5.2 Test Setup

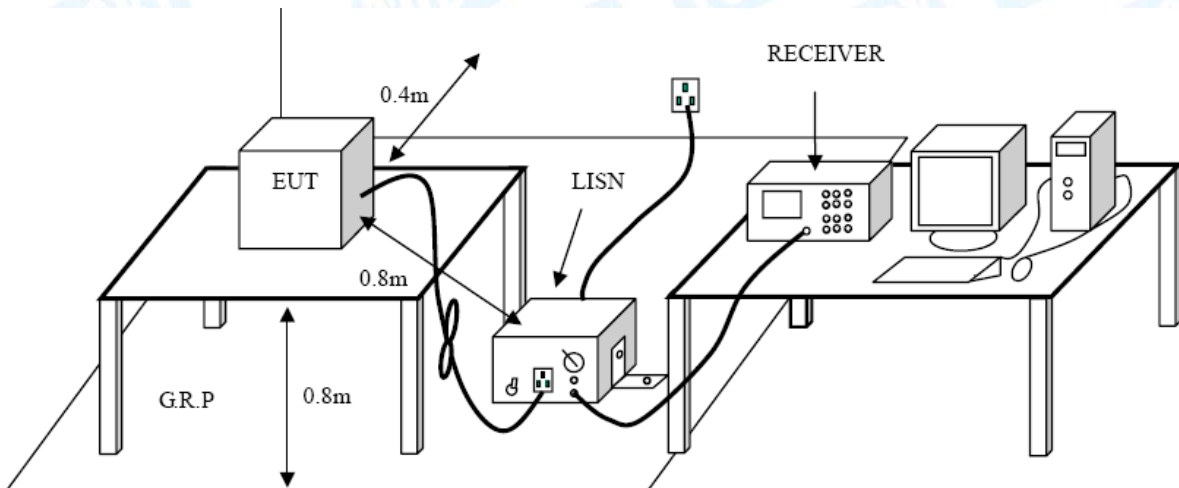

### 5.3 Test Procedure

The EUT was placed 0.8 meters from the horizontal ground plane with EUT being connected to the power mains through a line impedance stabilization network (LISN). All other support equipments powered from additional LISN(s). The LISN provide 50 Ohm/50uH of coupling impedance for the measuring instrument.

Interconnecting cables that hang closer than 40 cm to the ground plane shall be folded back and forth in the center forming a bundle 30 to 40 cm long.

I/O cables that are not connected to a peripheral shall be bundled in the center. The end of the cable may be terminated, if required, using the correct terminating impedance. The overall length shall not exceed 1 m.

LISN at least 80 cm from nearest part of EUT chassis

The bandwidth of EMI test receiver is set at 9kHz, and the test frequency band is from 0.15MHz to 30MHz.

### 5.4 Deviation From Test Standard

No deviation

### 5.5 EUT Operating Mode

Please refer to the description of test mode.

### 5.6 Test Data

The EUT is powered by AA battery, no requirement for this test item.

## 6. Radiated Emission Test

### 6.1 Test Standard and Limit

- 6.1.1 Test Standard  
FCC Part 15.209
- 6.1.2 Test Limit

#### Radiated Emission Limit (9 kHz~1000MHz)

Frequency (MHz)	Field Strength (microvolt/meter)	Measurement Distance (meters)
0.009~0.490	2400/F(KHz)	300
0.490~1.705	24000/F(KHz)	30
1.705~30.0	30	30
30~88	100	3
88~216	150	3
216~960	200	3
Above 960	500	3

#### Radiated Emission Limit (Above 1000MHz)

Frequency (MHz)	Distance of 3m (dBuV/m)	
	Peak	Average
Above 1000	74	54

**Note:**

- (1) The tighter limit applies at the band edges.
- (2) Emission Level (dBuV/m)=20log Emission Level (uV/m)

6.2 Test Setup

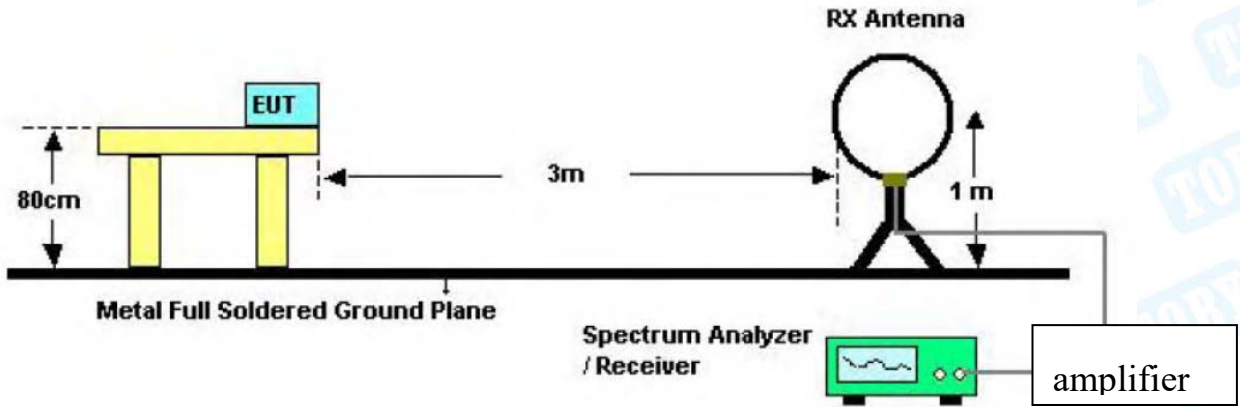

Below 30MHz Test Setup

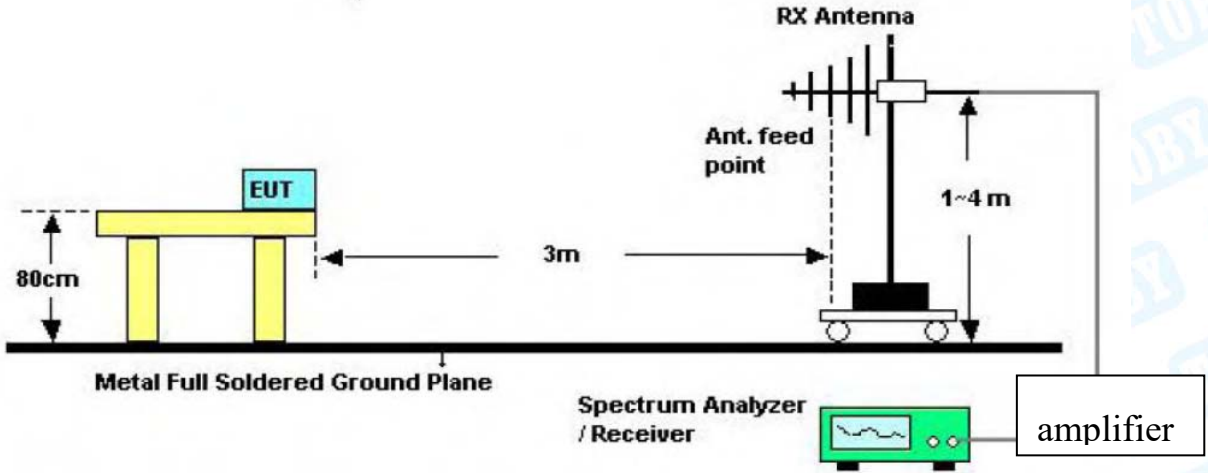

Below 1000MHz Test Setup

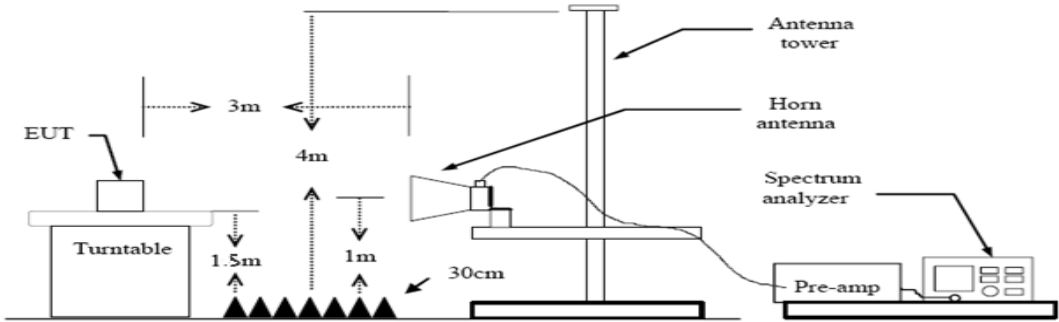

Above 1GHz Test Setup



### 6.3 Test Procedure

- (1) The measuring distance of 3m shall be used for measurements at frequency up to 1GHz and above 1 GHz. The EUT was placed on a rotating 0.8m high above ground, the table was rotated 360 degrees to determine the position of the highest radiation.
- (2) Measurements at frequency above 1GHz. The EUT was placed on a rotating 1.5m high above the ground. RF absorbers covered the ground plane with a minimum area of 3.0m by 3.0m between the EUT and measurement receiver antenna. The RF absorber shall not exceed 30cm in high above the conducting floor. The table was rotated 360 degrees to determine the position of the highest radiation.
- (3) The Test antenna shall vary between 1m and 4m, Both Horizontal and Vertical antenna are set to make measurement.
- (4) The initial step in collecting conducted emission data is a spectrum analyzer peak detector mode pre-scanning the measurement frequency range. Significant peaks are then marked and then Quasi Peak detector mode re-measured.
- (5) If the Peak Mode measured value compliance with and lower than Quasi Peak Mode Limit Bellow 1 GHz, the EUT shall be deemed to meet QP Limits and then no additional QP Mode measurement performed. But the Peak Value and average value both need to comply with applicable limit above 1 GHz.
- (6) Testing frequency range below 1GHz the measuring instrument use VBW=120 kHz with Quasi-peak detection.
- (7) Testing frequency range above 1GHz the measuring instrument use RBW=1 MHz and VBW=3 MHz with Peak Detector for Peak Values, and use RBW=1 MHz and VBW=10 Hz with Peak Detector for Average Values.
- (8) For the actual test configuration, please see the test setup photo.

### 6.4 Deviation From Test Standard

No deviation

### 6.4 EUT Operating Condition

The Equipment Under Test was set to Continual Transmitting in maximum power in TX mode.

### 6.5 Test Data

Remark: During testing above 1GHz the measuring instrument use RBW=1 MHz and VBW=3 MHz with Peak Detector for Peak Values, and use RBW=1 MHz and VBW=10 Hz with Peak Detector for Average Values.

Please refer to the Attachment A.

## 7. Restricted Bands Requirement

### 7.1 Test Standard and Limit

- 7.1.1 Test Standard
  - FCC Part 15.209
  - FCC Part 15.205
- 7.1.2 Test Limit

Restricted Frequency Band (MHz)	Distance of 3m (dBuV/m)	
	Peak	Average
2310 ~2390	74	54
2483.5 ~2500	74	54

**Note: All restriction bands have been tested, only the worst case is reported.**

### 7.2 Test Setup

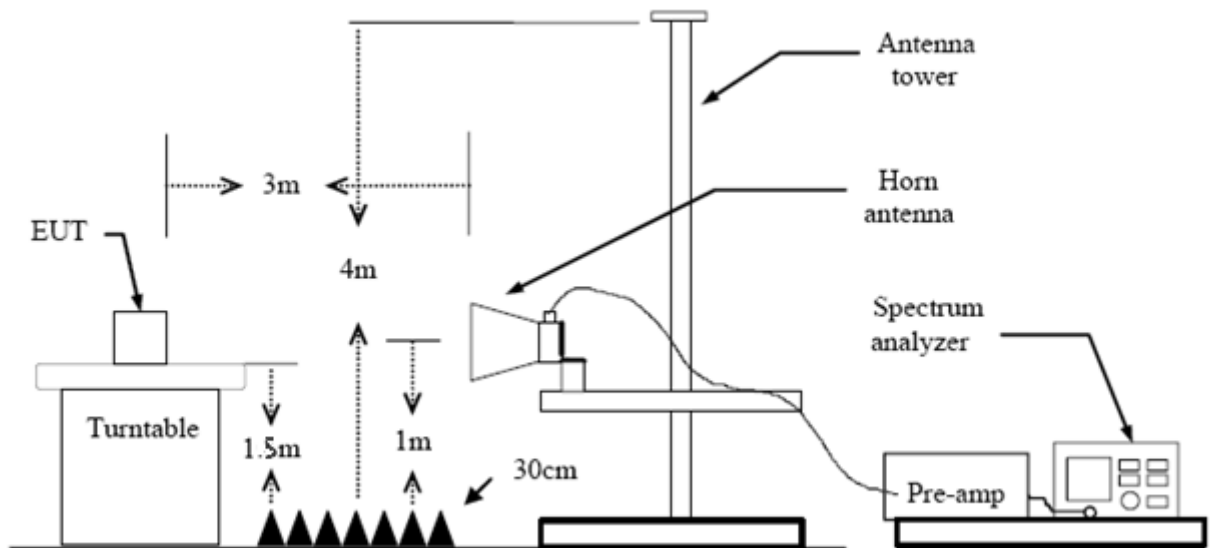

### 7.3 Test Procedure

- (1) The measuring distance of 3m shall be used for measurements at frequency up to 1GHz and above 1 GHz. The EUT was placed on a rotating 0.8m high above ground, the table was rotated 360 degrees to determine the position of the highest radiation.
- (2) Measurements at frequency above 1GHz. The EUT was placed on a rotating 1.5m high above the ground. RF absorbers covered the ground plane with a minimum area of 3.0m by 3.0m between the EUT and measurement receiver antenna. The RF absorber shall not exceed 30cm in high above the conducting floor. The table was rotated 360 degrees to determine the position of the highest radiation.
- (3) The Test antenna shall vary between 1m and 4m, Both Horizontal and Vertical antenna are set to make measurement.
- (4) The initial step in collecting conducted emission data is a spectrum analyzer peak detector mode pre-scanning the measurement frequency range. Significant peaks are then marked and then Quasi Peak detector mode re-measured.
- (5) If the Peak Mode measured value compliance with and lower than Quasi Peak Mode Limit Bellow 1 GHz, the EUT shall be deemed to meet QP Limits and then no additional QP Mode measurement performed. But the Peak Value and average value both need to comply with applicable limit above 1 GHz.
- (6) Testing frequency range below 1GHz the measuring instrument use VBW=120 kHz with Quasi-peak detection.
- (7) Testing frequency range above 1GHz the measuring instrument use RBW=1 MHz and VBW=3 MHz with Peak Detector for Peak Values, and use RBW=1 MHz and VBW=10 Hz with AVG Detector for Average Values.
- (8) For the actual test configuration, please see the test setup photo.

### 7.4 Deviation From Test Standard

No deviation

### 7.5 EUT Operating Condition

The Equipment Under Test was set to Continual Transmitting in maximum power.

### 7.6 Test Data

Remark: During testing above 1GHz the measuring instrument use RBW=1 MHz and VBW=3 MHz with Peak Detector for Peak Values, and use RBW=1 MHz and VBW=10 Hz with Peak Detector for Average Values.

All restriction bands have been tested, only the worst case is reported.

Please refer to the Attachment B.

## 8. Number of Hopping Channel

### 8.1 Test Standard and Limit

- 8.1.1 Test Standard  
FCC Part 15.247 (a)(1)
- 8.1.2 Test Limit

Section	Test Item	Limit
15.247	Number of Hopping Channel	>15

### 8.2 Test Setup

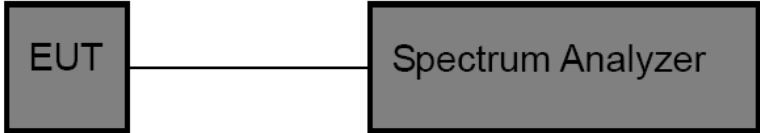

### 8.3 Test Procedure

- (1) The EUT was directly connected to the spectrum analyzer and antenna output port as show in the block diagram above.
- (2) Spectrum Setting: RBW=100 KHz, VBW=300 KHz, Sweep time= Auto.

### 8.4 Deviation From Test Standard

No deviation

### 8.5 EUT Operating Condition

The EUT was set to the Hopping Mode by the Customer.

### 8.6 Test Data

Please refer to the Attachment C.

## 9. Average Time of Occupancy

### 9.1 Test Standard and Limit

- 9.1.1 Test Standard  
FCC Part 15.247 (a)(1)
- 9.1.2 Test Limit

Section	Test Item	Limit
15.247(a)(1)	Average Time of Occupancy	0.4 sec

### 9.2 Test Setup

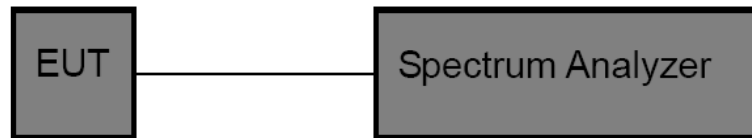

### 9.3 Test Procedure

- (1) The EUT was directly connected to the spectrum analyzer and antenna output port as show in the block diagram above.
- (2) Spectrum Setting: RBW=1MHz, VBW=3MHz.
- (3) Use video trigger with the trigger level set to enable triggering only on full pulses.
- (4) Sweep Time is more than once pulse time.
- (5) Set the centre frequency on any frequency would be measure and set the frequency span to zero.
- (6) Measure the maximum time duration of one single pulse.
- (7) Set the EUT for packet transmitting.
- (8) Measure the maximum time duration of one single pulse.

### 9.4 EUT Operating Condition

The average time of occupancy on any channel within the Period can be calculated with formulas:

$$\{Total\ of\ Dwell\} = \{Pulse\ Time\} * (1600 / X) / \{Number\ of\ Hopping\ Frequency\} * \{Period\}$$

$$\{Period\} = 0.4s * \{Number\ of\ Hopping\ Frequency\}$$

Note: X=2 or 4 or 6 (1DH1=2, 1DH3=4, 1DH5=6. 2DH1=2, 2DH3=4, 2DH5=6. 3DH1=2, 3DH3=4, 3DH5=6)

The lowest, middle and highest channels are selected to perform testing to record the dwell time of each occupation measured in this channel, which is called Pulse Time here.

#### 9.4 Deviation From Test Standard

No deviation

#### 9.5 EUT Operating Condition

The EUT was set to the Hopping Mode by the Customer.

#### 9.6 Test Data

Please refer to the Attachment D.

## 10. Channel Separation and Bandwidth Test

### 10.1 Test Standard and Limit

#### 10.1.1 Test Standard

FCC Part 15.247

#### 10.1.2 Test Limit

Test Item	Limit	Frequency Range(MHz)
Bandwidth	$\leq 1$ MHz (20dB bandwidth)	2400~2483.5
Channel Separation	$>25$ KHz or $>$ two-thirds of the 20 dB bandwidth Which is greater	2400~2483.5

### 10.2 Test Setup

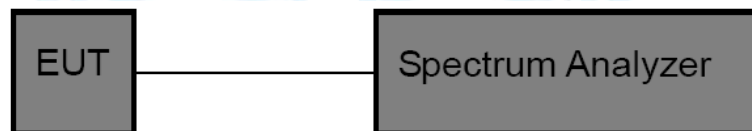

### 10.3 Test Procedure

- (1) The EUT was directly connected to the spectrum analyzer and antenna output port as show in the block diagram above.
- (2) Spectrum Setting:  
Channel Separation: RBW=30 kHz, VBW=100 kHz.  
Bandwidth: RBW=30 kHz, VBW=100 kHz.
- (3) The bandwidth is measured at an amplitude level reduced 20dB from the reference level. The reference level is the level of the highest amplitude signal observed from the transmitter at the fundamental frequency. Once the reference level is established, the equipment is conditioned with typical modulating signal to produce the worst –case (i.e the widest) bandwidth.
- (4) Measure the channel separation the spectrum analyzer was set to Resolution Bandwidth:30 kHz, and Video Bandwidth:100 kHz. Sweep Time set auto.

#### 10.4 Deviation From Test Standard

No deviation

#### 10.5 EUT Operating Condition

The EUT was set to the Hopping Mode for Channel Separation Test and continuously transmitting for the Bandwidth Test.

#### 10.6 Test Data

Please refer to the Attachment E.



## 11. Peak Output Power Test

### 11.1 Test Standard and Limit

#### 11.1.1 Test Standard

FCC Part 15.247 (b) (1)

#### 11.1.2 Test Limit

Test Item	Limit	Frequency Range(MHz)
Peak Output Power	Hopping Channels>75 Power<1W(30dBm) Other <125 mW(21dBm)	2400~2483.5

### 11.2 Test Setup

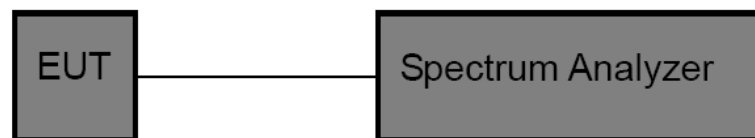

### 11.3 Test Procedure

(1) The EUT was directly connected to the spectrum analyzer and antenna output port as show in the block diagram above.

(2) Spectrum Setting:

Peak Detector: RBW=2 MHz, VBW=6 MHz for bandwidth less than 1MHz.

RBW=3 MHz, VBW ≥ RBW for bandwidth more than 1MHz.

### 11.4 Deviation From Test Standard

No deviation

### 11.5 EUT Operating Condition

The EUT was set to continuously transmitting in the max power during the test.

### 11.6 Test Data

Please refer to the Attachment F.

## 12. Antenna Requirement

### 12.1 Standard Requirement

#### 12.1.1 Standard

FCC Part 15.203

#### 12.1.2 Requirement

An intentional radiator shall be designed to ensure that no antenna other than that furnished by the responsible party shall be used with the device. The use of a permanently attached antenna or of an antenna that uses a unique coupling to the intentional radiator shall be considered sufficient to comply with the provisions of this Section. The manufacturer may design the unit so that a broken antenna can be replaced by the user, but the use of a standard antenna jack or electrical connector is prohibited.

### 12.2 Deviation From Test Standard

No deviation

### 12.3 Antenna Connected Construction

The gains of the antenna used for transmitting is 0dBi, and the antenna connector is de-signed with permanent attachment and no consideration of replacement. Please see the EUT photo for details.

### 12.4 Result

The EUT antenna is a PCB Antenna. It complies with the standard requirement.

Antenna Type
<input checked="" type="checkbox"/> Permanent attached antenna
<input type="checkbox"/> Unique connector antenna
<input type="checkbox"/> Professional installation antenna

## Attachment A-- Radiated Emission Test Data

### 9KHz~30MHz

From 9KHz to 30MHz: Conclusion: PASS

Note: The amplitude of spurious emissions which are attenuated by more than 20dB below the permissible value has no need to be reported.

### 30MHz~1GHz

Temperature:	23.5°C	Relative Humidity:	43%
Test Voltage:	DC 4.5V		
Ant. Pol.	Horizontal		
Test Mode:	Mode 1 GFSK 2402MHz		
Remark:	Only worse case is reported		

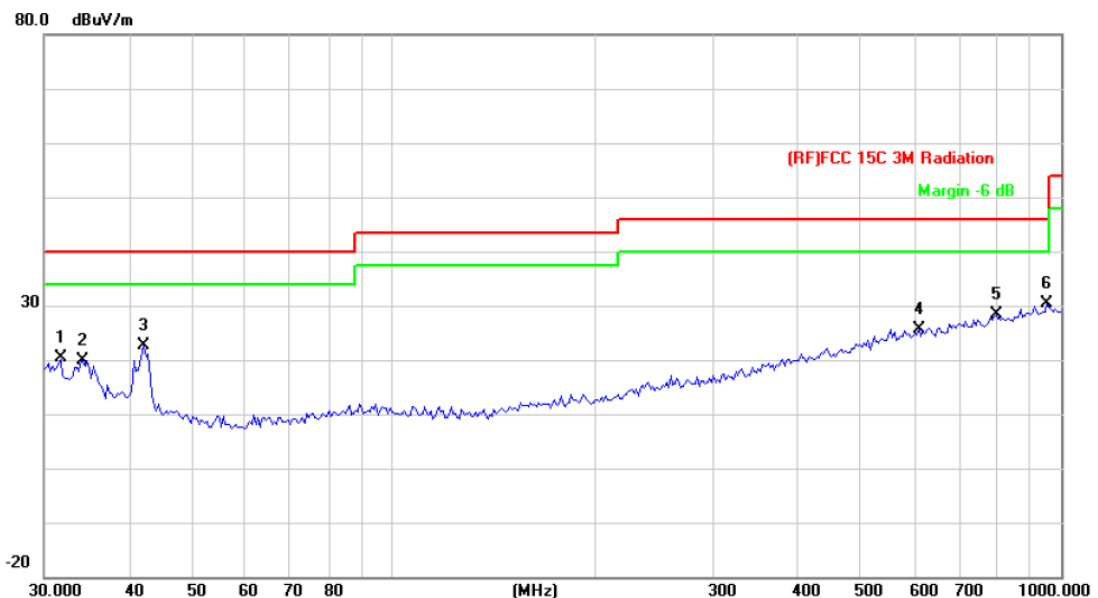

No.	Mk.	Freq. MHz	Reading Level dBuV	Correct Factor dB/m	Measure- ment dBuV/m	Limit dBuV/m	Over dB	Detector
1		31.7313	34.66	-14.25	20.41	40.00	-19.59	peak
2		34.2760	35.98	-16.14	19.84	40.00	-20.16	peak
3		42.3022	42.72	-20.11	22.61	40.00	-17.39	peak
4		612.0642	33.84	-8.23	25.61	46.00	-20.39	peak
5		798.9797	34.14	-5.67	28.47	46.00	-17.53	peak
6	*	952.0937	34.55	-4.26	30.29	46.00	-15.71	peak

\*:Maximum data    x:Over limit    !:over margin

**Remark:**

1. Corr. = Antenna Factor (dB/m) + Cable Loss (dB)
2. QuasiPeak (dBμV/m)= Corr. (dB/m)+ Read Level (dBμV)
3. Margin (dB) = QuasiPeak (dBμV/m)-Limit QPK(dBμV/m)

Temperature:	23.5°C	Relative Humidity:	43%
Test Voltage:	DC 4.5V		
Ant. Pol.	Vertical		
Test Mode:	Mode 1 GFSK 2402MHz		
Remark:	Only worse case is reported		

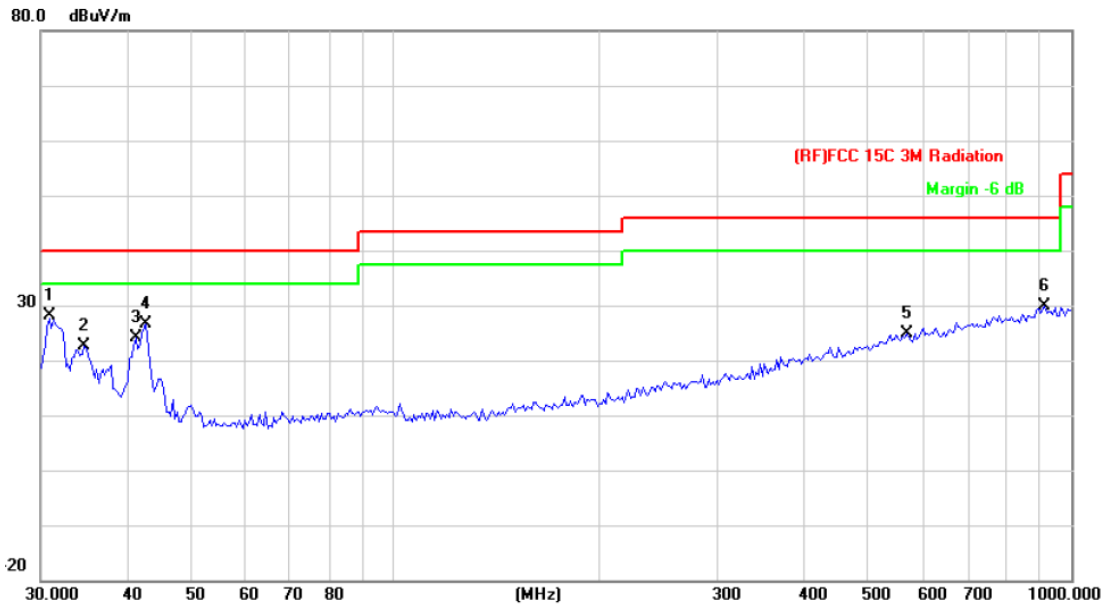

No.	Mk.	Freq. MHz	Reading Level dBuV	Correct Factor dB/m	Measure- ment dBuV/m	Limit dBuV/m	Over dB	Detector
1	*	30.8535	41.69	-13.58	28.11	40.00	-11.89	peak
2		34.7602	39.10	-16.49	22.61	40.00	-17.39	peak
3		41.4215	43.85	-19.68	24.17	40.00	-15.83	peak
4		42.8998	46.92	-20.40	26.52	40.00	-13.48	peak
5		570.6100	33.51	-8.67	24.84	46.00	-21.16	peak
6		912.8620	34.06	-4.26	29.80	46.00	-16.20	peak

\*:Maximum data    x:Over limit    !:over margin

**Emission Level= Read Level+ Correct Factor**

**Above 1GHz(Only worse case is reported)**

<b>Temperature:</b>	23.3°C	<b>Relative Humidity:</b>	43%
<b>Test Voltage:</b>	DC 4.5V		
<b>Ant. Pol.</b>	Horizontal		
<b>Test Mode:</b>	TX GFSK Mode 2402MHz		
<b>Remark:</b>	No report for the emission which more than 20 dB below the prescribed limit.		

No.	Mk.	Freq.	Reading Level	Correct Factor	Measurement	Limit	Over	Detector
		MHz	dBuV	dB/m	dBuV/m	dBuV/m	dB	
1	*	4804.370	28.06	13.02	41.08	54.00	-12.92	AVG
2		4804.410	42.35	13.02	55.37	74.00	-18.63	peak

**Remark:**  
 1. Corr. = Antenna Factor (dB/m) + Cable Loss (dB)  
 2. Peak/AVG (dBμV/m)= Corr. (dB/m)+ Read Level (dBμV)  
 3. Margin (dB) = Peak/AVG (dBμV/m)-Limit PK/AVG(dBμV/m)

<b>Temperature:</b>	23.3°C	<b>Relative Humidity:</b>	43%
<b>Test Voltage:</b>	DC 4.5V		
<b>Ant. Pol.</b>	Vertical		
<b>Test Mode:</b>	TX GFSK Mode 2402MHz		
<b>Remark:</b>	No report for the emission which more than 20 dB below the prescribed limit.		

No.	Mk.	Freq.	Reading Level	Correct Factor	Measurement	Limit	Over	Detector
		MHz	dBuV	dB/m	dBuV/m	dBuV/m	dB	
1	*	4803.624	26.57	13.01	39.58	54.00	-14.42	AVG
2		4804.268	42.47	13.02	55.49	74.00	-18.51	peak

**Remark:**  
 1. Corr. = Antenna Factor (dB/m) + Cable Loss (dB)  
 2. Peak/AVG (dBμV/m)= Corr. (dB/m)+ Read Level (dBμV)  
 3. Margin (dB) = Peak/AVG (dBμV/m)-Limit PK/AVG(dBμV/m)

<b>Temperature:</b>	23.3°C	<b>Relative Humidity:</b>	43%
<b>Test Voltage:</b>	DC 4.5V		
<b>Ant. Pol.</b>	Horizontal		
<b>Test Mode:</b>	TX GFSK Mode 2441MHz		
<b>Remark:</b>	No report for the emission which more than 20 dB below the prescribed limit.		

No.	Mk.	Freq.	Reading Level	Correct Factor	Measurement	Limit	Over	Detector
		MHz	dBuV	dB/m	dBuV/m	dBuV/m	dB	
1	*	4884.880	27.61	13.61	41.22	54.00	-12.78	AVG
2		4885.046	41.55	13.61	55.16	74.00	-18.84	peak

**Remark:**

1. Corr. = Antenna Factor (dB/m) + Cable Loss (dB)
2. Peak/AVG (dBμV/m)= Corr. (dB/m)+ Read Level (dBμV)
3. Margin (dB) = Peak/AVG (dBμV/m)-Limit PK/AVG(dBμV/m)

<b>Temperature:</b>	23.3°C	<b>Relative Humidity:</b>	43%
<b>Test Voltage:</b>	DC 4.5V		
<b>Ant. Pol.</b>	Vertical		
<b>Test Mode:</b>	TX GFSK Mode 2441MHz		
<b>Remark:</b>	No report for the emission which more than 20 dB below the prescribed limit.		

No.	Mk.	Freq.	Reading Level	Correct Factor	Measurement	Limit	Over	Detector
		MHz	dBuV	dB/m	dBuV/m	dBuV/m	dB	
1		4884.130	41.82	13.60	55.42	74.00	-18.58	peak
2	*	4884.130	26.74	13.60	40.34	54.00	-13.66	AVG

**Remark:**

1. Corr. = Antenna Factor (dB/m) + Cable Loss (dB)
2. Peak/AVG (dBμV/m)= Corr. (dB/m)+ Read Level (dBμV)
3. Margin (dB) = Peak/AVG (dBμV/m)-Limit PK/AVG(dBμV/m)

<b>Temperature:</b>	23.3°C	<b>Relative Humidity:</b>	43%
<b>Test Voltage:</b>	DC 4.5V		
<b>Ant. Pol.</b>	Horizontal		
<b>Test Mode:</b>	TX GFSK Mode 2480MHz		
<b>Remark:</b>	No report for the emission which more than 20 dB below the prescribed limit.		

No.	Mk.	Freq.	Reading Level	Correct Factor	Measurement	Limit	Over	Detector
		MHz	dBuV	dB/m	dBuV/m	dBuV/m	dB	
1	*	4958.370	26.67	14.15	40.82	54.00	-13.18	AVG
2		4958.430	41.49	14.15	55.64	74.00	-18.36	peak

**Remark:**

1. Corr. = Antenna Factor (dB/m) + Cable Loss (dB)
2. Peak/AVG (dBuV/m)= Corr. (dB/m)+ Read Level (dBuV)
3. Margin (dB) = Peak/AVG (dBuV/m)-Limit PK/AVG(dBuV/m)

<b>Temperature:</b>	23.3°C	<b>Relative Humidity:</b>	43%
<b>Test Voltage:</b>	DC 4.5V		
<b>Ant. Pol.</b>	Vertical		
<b>Test Mode:</b>	TX GFSK Mode 2480MHz		
<b>Remark:</b>	No report for the emission which more than 20 dB below the prescribed limit.		

No.	Mk.	Freq.	Reading Level	Correct Factor	Measurement	Limit	Over	Detector
		MHz	dBuV	dB/m	dBuV/m	dBuV/m	dB	
1		4960.120	42.34	14.15	56.49	74.00	-17.51	peak
2	*	4960.300	26.46	14.15	40.61	54.00	-13.39	AVG

**Remark:**

1. Corr. = Antenna Factor (dB/m) + Cable Loss (dB)
2. Peak/AVG (dBuV/m)= Corr. (dB/m)+ Read Level (dBuV)
3. Margin (dB) = Peak/AVG (dBuV/m)-Limit PK/AVG(dBuV/m)

# Attachment B-- Restricted Bands Requirement and Band Edge Test Data

## (1) Radiation Test

Temperature:	23.3°C	Relative Humidity:	43%
Test Voltage:	DC 4.5V		
Ant. Pol.	Horizontal		
Test Mode:	TX GFSK Mode 2402MHz		
Remark:	Only worse case is reported		

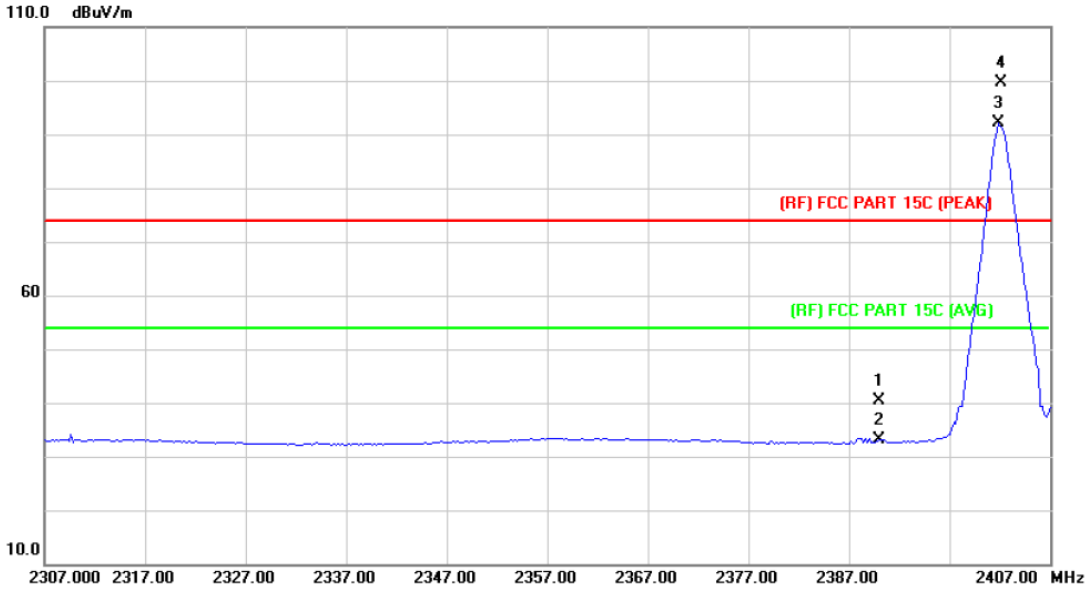

No.	Mk.	Freq. MHz	Reading Level dBuV	Correct Factor dB/m	Measure- ment dBuV/m	Limit dBuV/m	Over dB	Detector
1		2390.000	39.10	1.28	40.38	74.00	-33.62	peak
2		2390.000	31.82	1.28	33.10	54.00	-20.90	AVG
3	*	2401.800	90.90	1.33	92.2	Fundamental Frequency		AVG
4	X	2402.200	98.24	1.33	99.57	Fundamental Frequency		peak

- Remark:
1. Corr. = Antenna Factor (dB/m) + Cable Loss (dB)
  2. Peak/AVG (dBμV/m)= Corr. (dB/m)+ Read Level (dBμV)
  3. Margin (dB) = Peak/AVG (dBμV/m)-Limit PK/AVG(dBμV/m)



<b>Temperature:</b>	23.3°C	<b>Relative Humidity:</b>	43%
<b>Test Voltage:</b>	DC 4.5V		
<b>Ant. Pol.</b>	Vertical		
<b>Test Mode:</b>	TX GFSK Mode 2402MHz		
<b>Remark:</b>	Only worse case is reported		

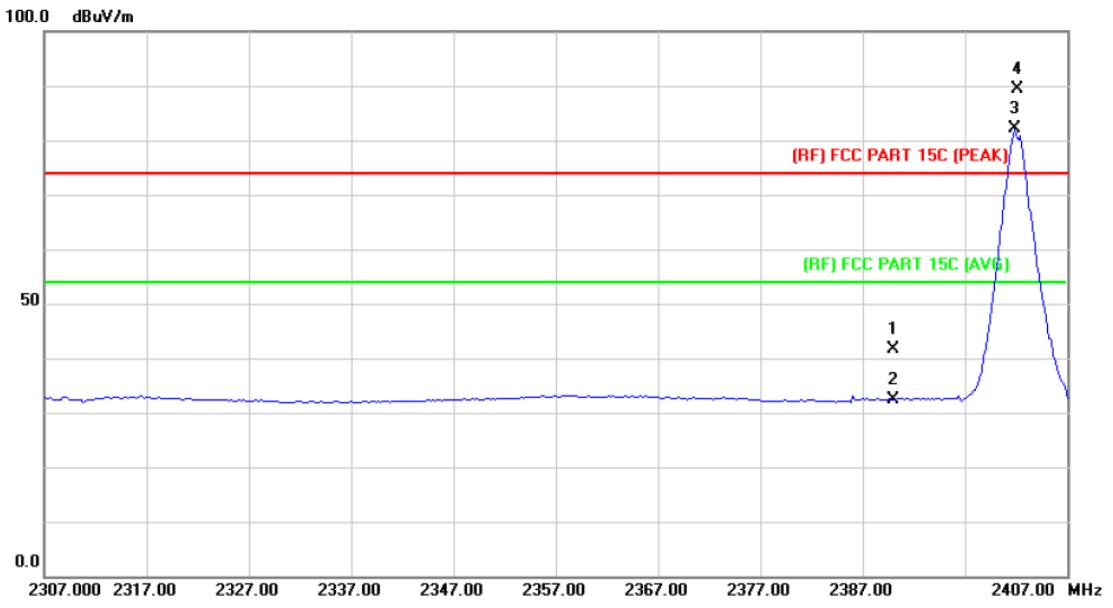

No.	Mk.	Freq. MHz	Reading Level dBuV	Correct Factor dB/m	Measure- ment dBuV/m	Limit dBuV/m	Over dB	Detector
1		2390.000	40.23	1.28	41.51	74.00	-32.49	peak
2		2390.000	31.21	1.28	32.49	54.00	-21.51	AVG
3	*	2401.800	80.71	1.33	82.04	Fundamental Frequency		AVG
4	X	2402.200	88.09	1.33	89.42	Fundamental Frequency		peak

**Remark:**  
 1. Corr. = Antenna Factor (dB/m) + Cable Loss (dB)  
 2. Peak/AVG (dBμV/m)= Corr. (dB/m)+ Read Level (dBμV)  
 3. Margin (dB) = Peak/AVG (dBμV/m)-Limit PK/AVG(dBμV/m)

<b>Temperature:</b>	23.3°C	<b>Relative Humidity:</b>	43%
<b>Test Voltage:</b>	DC 4.5V		
<b>Ant. Pol.</b>	Horizontal		
<b>Test Mode:</b>	TX GFSK Mode 2480 MHz		
<b>Remark:</b>	Only worse case is reported		

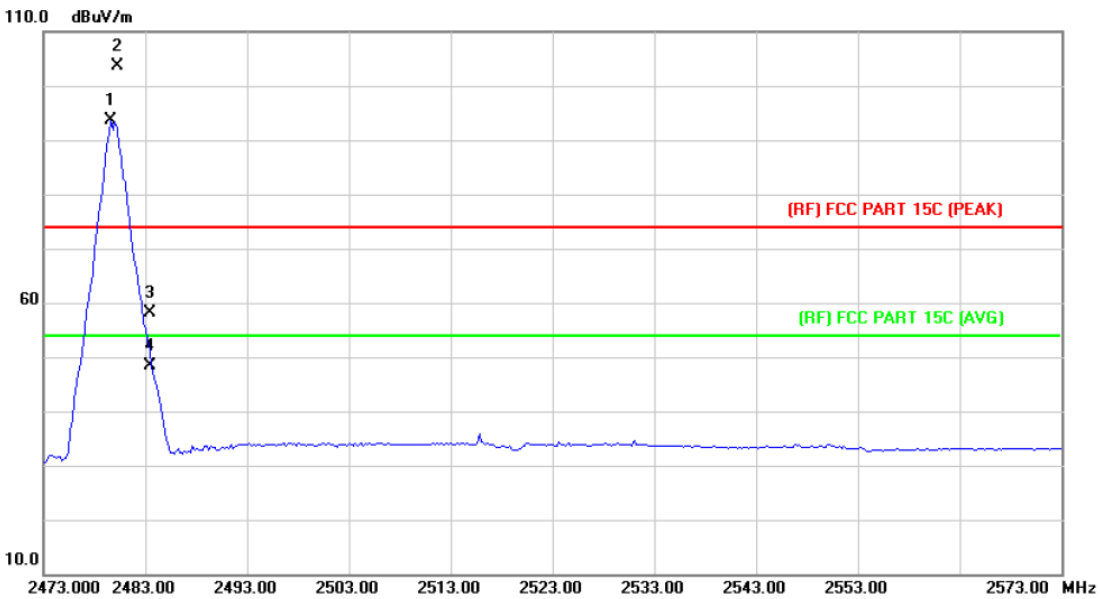

No.	Mk.	Freq. MHz	Reading Level dBuV	Correct Factor dB/m	Measure- ment dBuV/m	Limit dBuV/m	Over dB	Detector
1	*	2479.600	91.75	1.85	93.60	Fundamental Frequency		AVG
2	X	2480.300	101.89	1.85	103.74	Fundamental Frequency		peak
3		2483.500	56.34	1.88	58.22	74.00	-15.78	peak
4		2483.500	46.52	1.88	48.40	54.00	-5.60	AVG

**Remark:**

1. Corr. = Antenna Factor (dB/m) + Cable Loss (dB)
2. Peak/AVG (dBμV/m)= Corr. (dB/m)+ Read Level (dBμV)
3. Margin (dB) = Peak/AVG (dBμV/m)-Limit PK/AVG(dBμV/m)

Temperature:	23.3°C	Relative Humidity:	43%
Test Voltage:	DC 4.5V		
Ant. Pol.	Vertical		
Test Mode:	TX GFSK Mode 2480 MHz		
Remark:	Only worse case is reported		

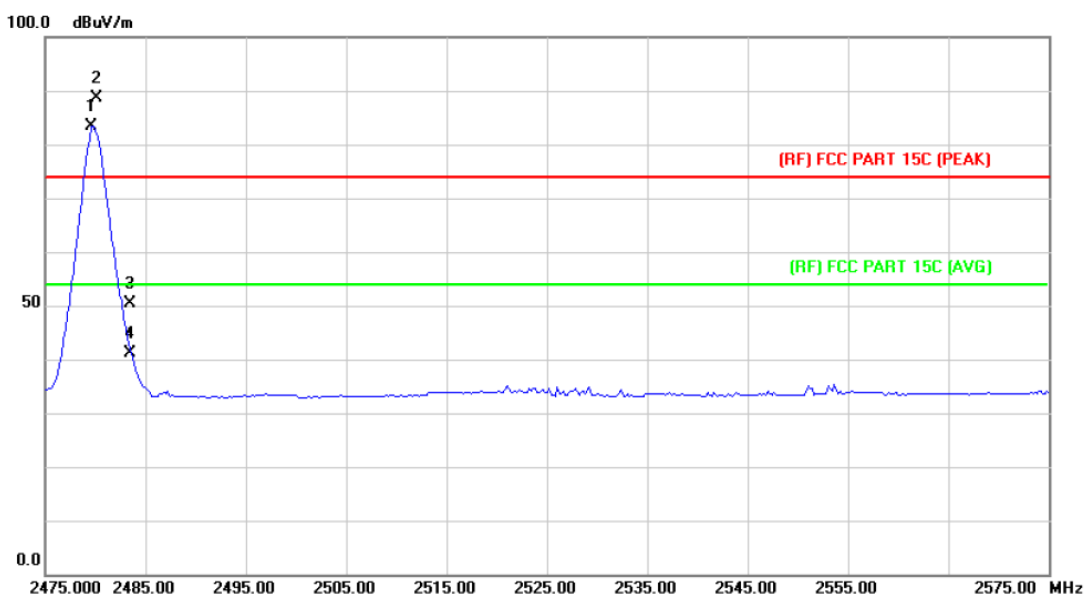

No.	Mk.	Freq. MHz	Reading Level dBuV	Correct Factor dB/m	Measure- ment dBuV/m	Limit dBuV/m	Over dB	Detector
1	*	2479.600	81.51	1.85	83.36	Fundamental Frequency		AVG
2	X	2480.200	86.76	1.85	88.61	Fundamental Frequency		peak
3		2483.500	48.61	1.88	50.49	74.00	-23.51	peak
4		2483.500	39.29	1.88	41.17	54.00	-12.83	AVG

**Remark:**  
 1. Corr. = Antenna Factor (dB/m) + Cable Loss (dB)  
 2. Peak/AVG (dBuV/m) = Corr. (dB/m) + Read Level (dBuV)  
 3. Margin (dB) = Peak/AVG (dBuV/m) - Limit PK/AVG (dBuV/m)

**(2) Conducted Test**

Temperature:	25°C	Relative Humidity:	55%
Test Voltage:	DC 4.5V		
Test Mode:	TX GFSK Mode 2402MHz/2480 MHz		
Remark:	Only worse case is reported		

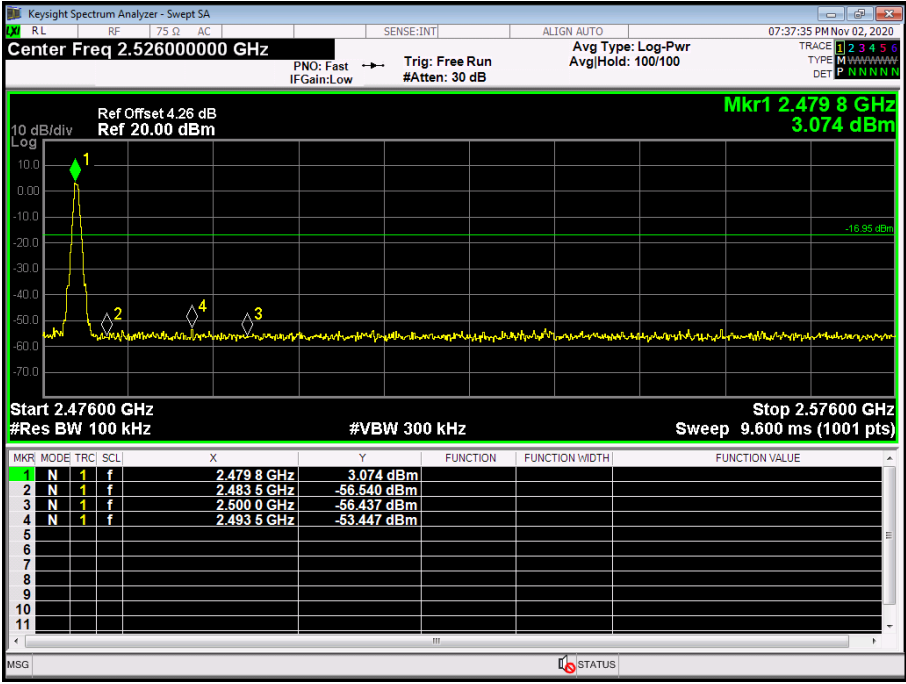
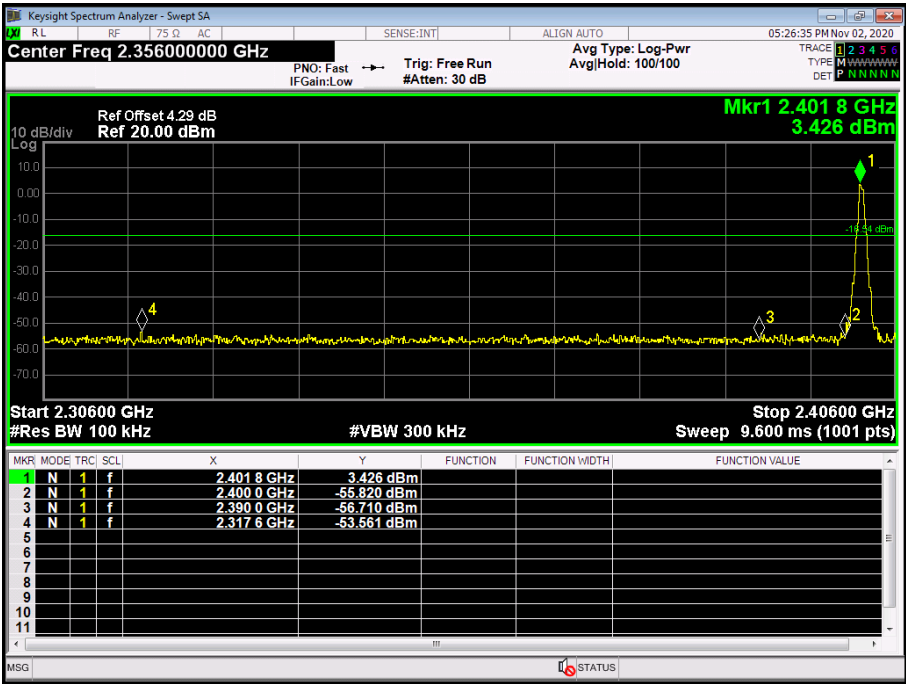

Temperature:	25°C	Relative Humidity:	55%
Test Voltage:	DC 4.5V		
Test Mode:	GFSK Hopping Mode		
Remark:	Only worse case is reported		

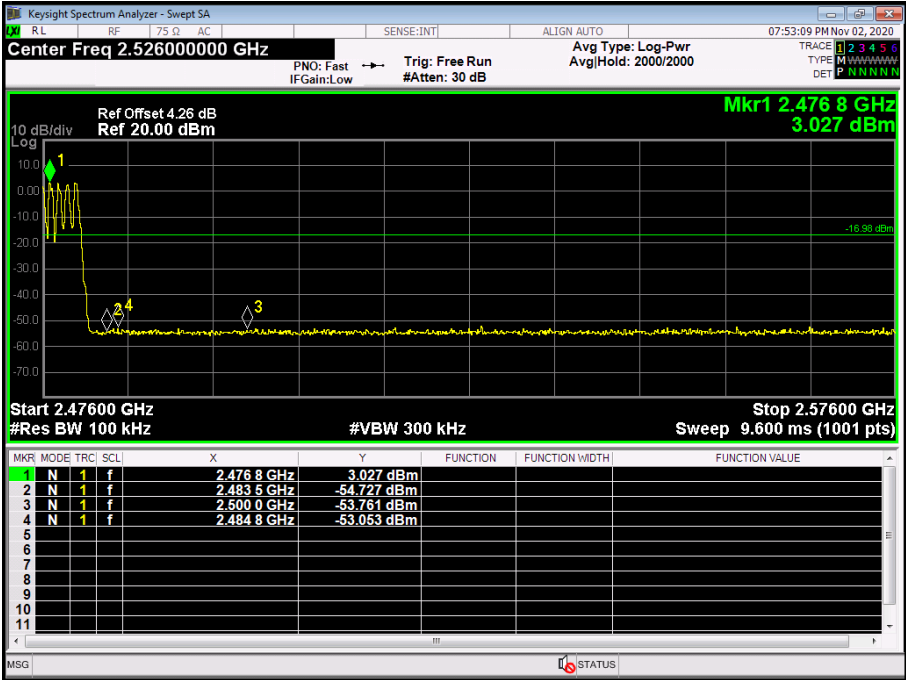
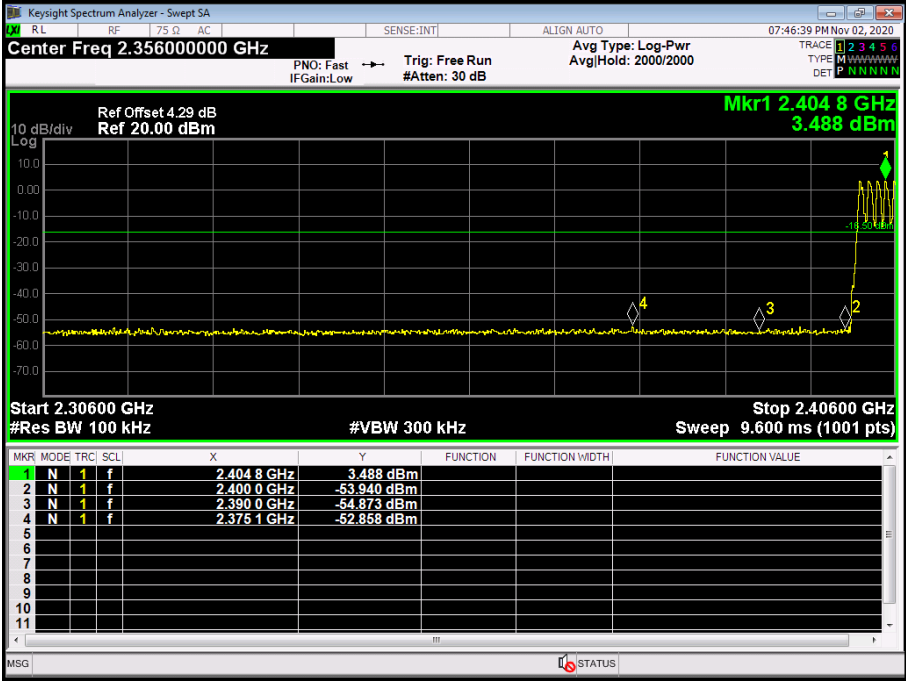

**Attachment C-- Number of Hopping Channel Test Data**

Temperature:	25°C	Relative Humidity:	55%
Test Voltage:	DC 4.5V		
Test Mode:	Hopping Mode		
Frequency Range	Test Mode	Quantity of Hopping Channel	Limit
2402MHz~2480MHz	GFSK	79	>15
<b>GFSK Mode</b>			

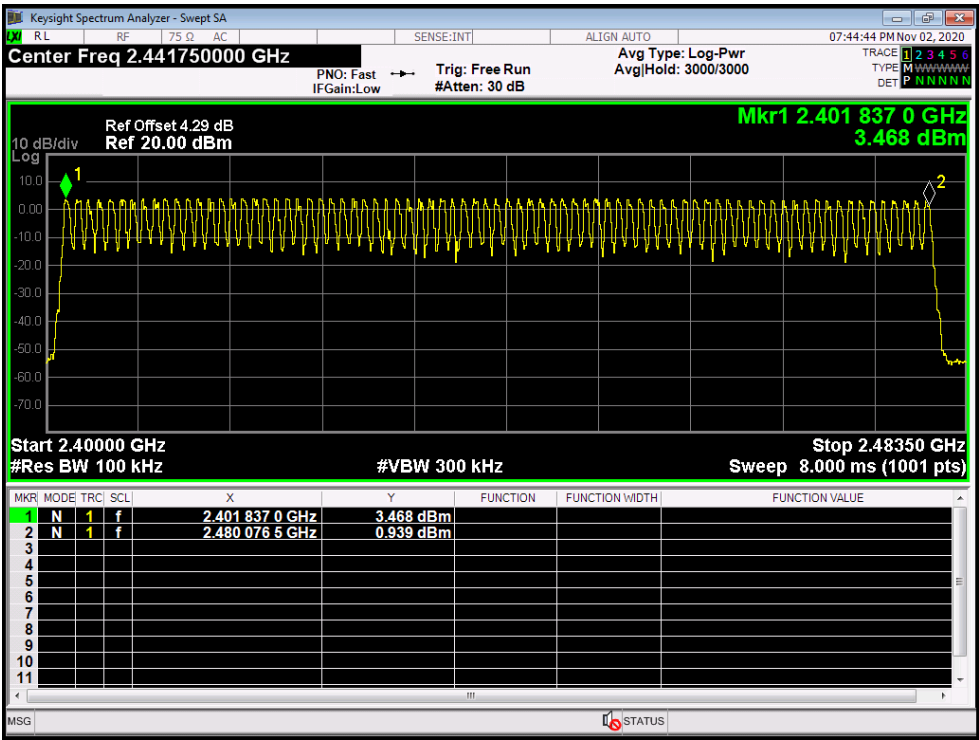

## Attachment D-- Average Time of Occupancy Test Data

<b>Temperature:</b>		25°C		<b>Relative Humidity:</b>		55%	
<b>Test Voltage:</b>		DC 4.5V					
<b>Test Mode:</b>		Hopping Mode (GFSK)					
Test Mode	Channel (MHz)	Pulse Time (ms)	Total of Dwell (ms)	Period Time (s)	Limit (ms)	Result	
1DH1	2441	0.371	118.72	31.60	400	PASS	
1DH3	2441	1.626	260.16	31.60	400	PASS	
1DH5	2441	2.875	306.667	31.60	400	PASS	

1DH1 Total of Dwell= Pulse Time\*(1600/2)\*31.6/79  
 1DH3 Total of Dwell= Pulse Time\*(1600/4)\*31.6/79  
 1DH5 Total of Dwell= Pulse Time\*(1600/6)\*31.6/79

### GFSK Hopping Mode 1DH1

2441 MHz

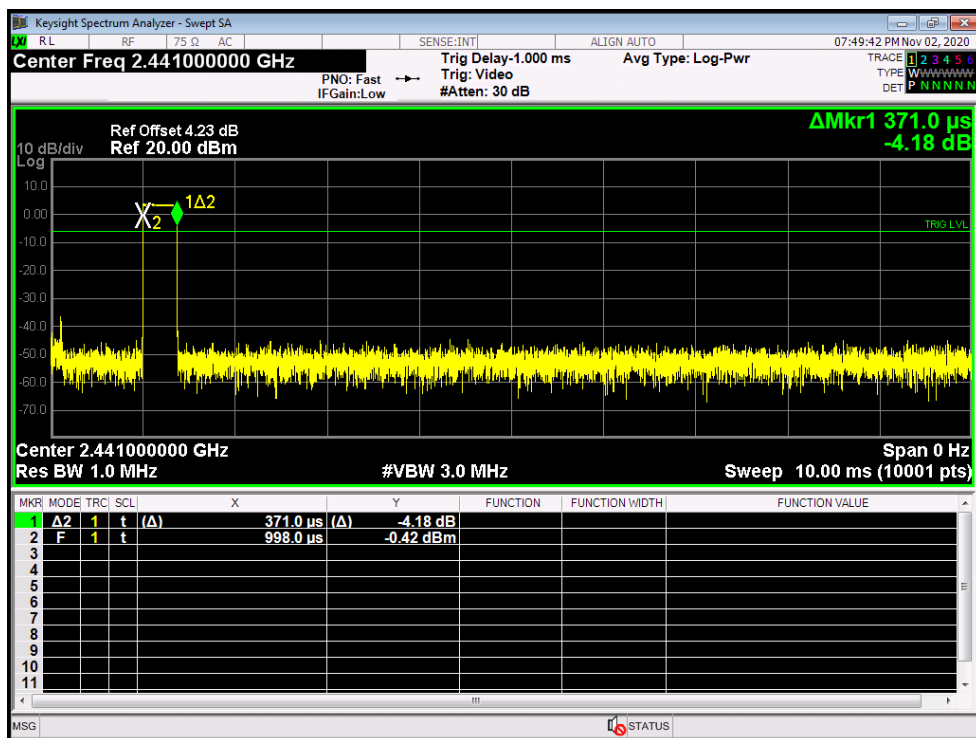

**GFSK Hopping Mode 1DH3**

**2441 MHz**

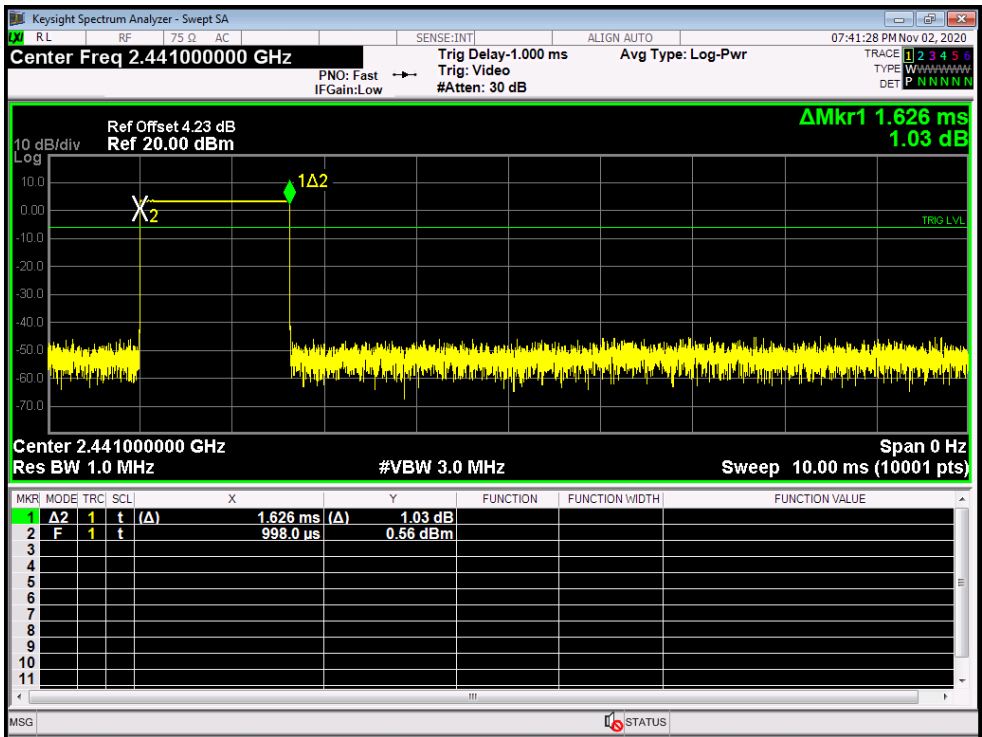

**GFSK Hopping Mode 1DH5**

**2441 MHz**

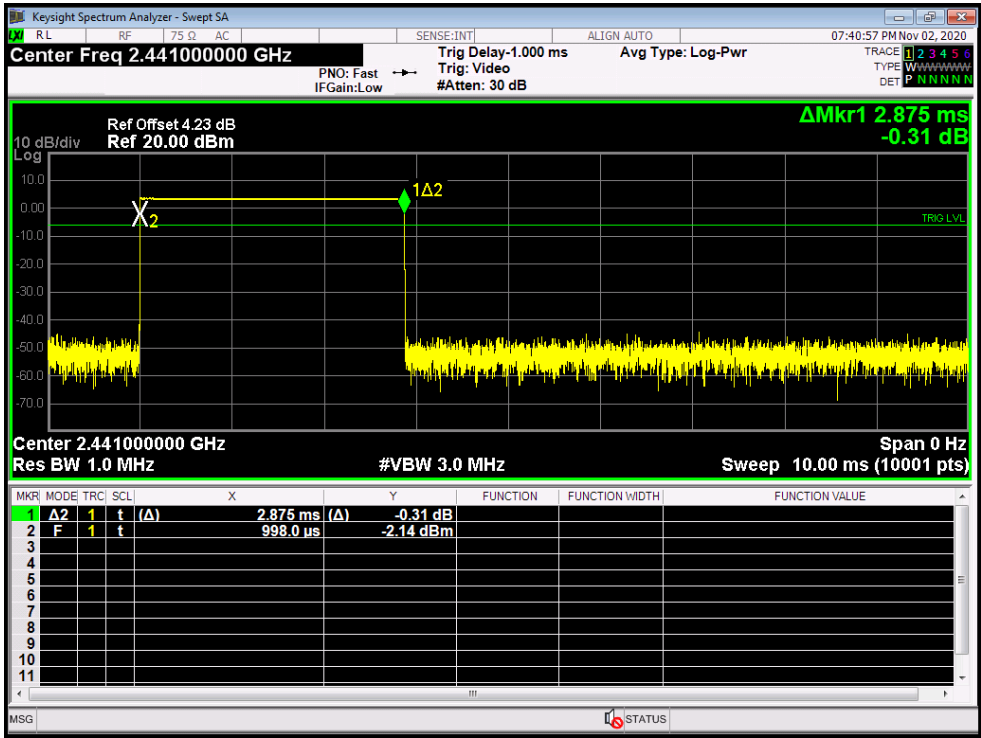



# Attachment E-- Channel Separation and Bandwidth Test Data

Temperature:	25°C	Relative Humidity:	55%
Test Voltage:	DC 4.5V		
Test Mode:	TX Mode (GFSK)		
Channel frequency (MHz)	99% OBW (kHz)	20dB Bandwidth (kHz)	20dB Bandwidth *2/3 (kHz)
2402	833.51	817.9	
2441	844.77	828.2	
2480	823.20	829.1	

**GFSK TX Mode**

**2402 MHz**

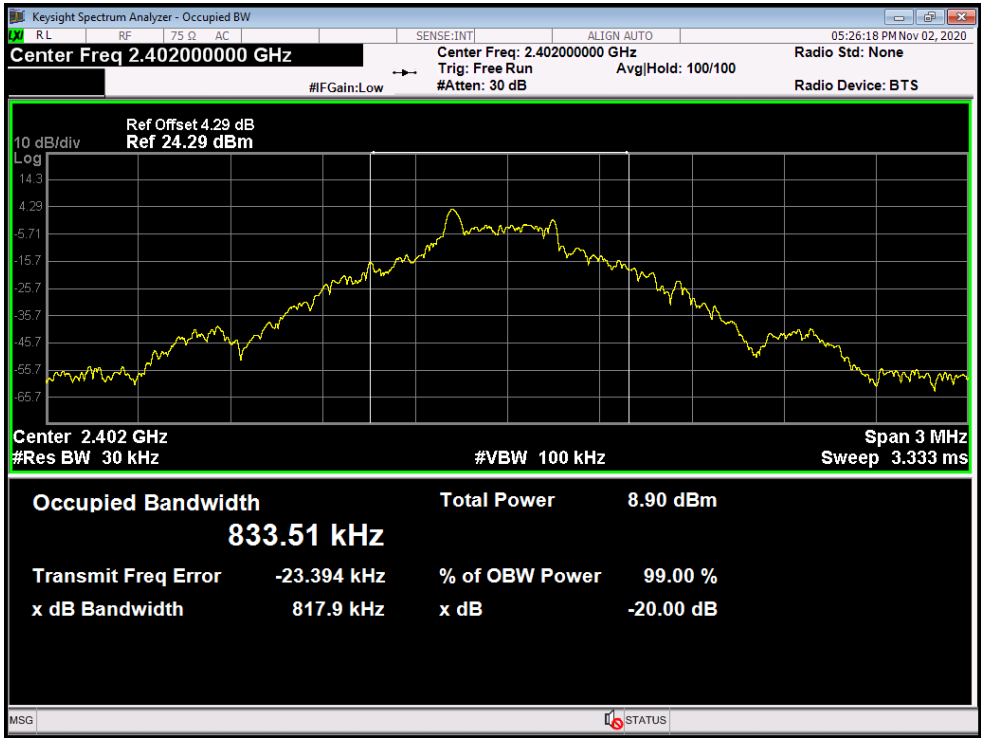

**GFSK TX Mode**

**2441 MHz**

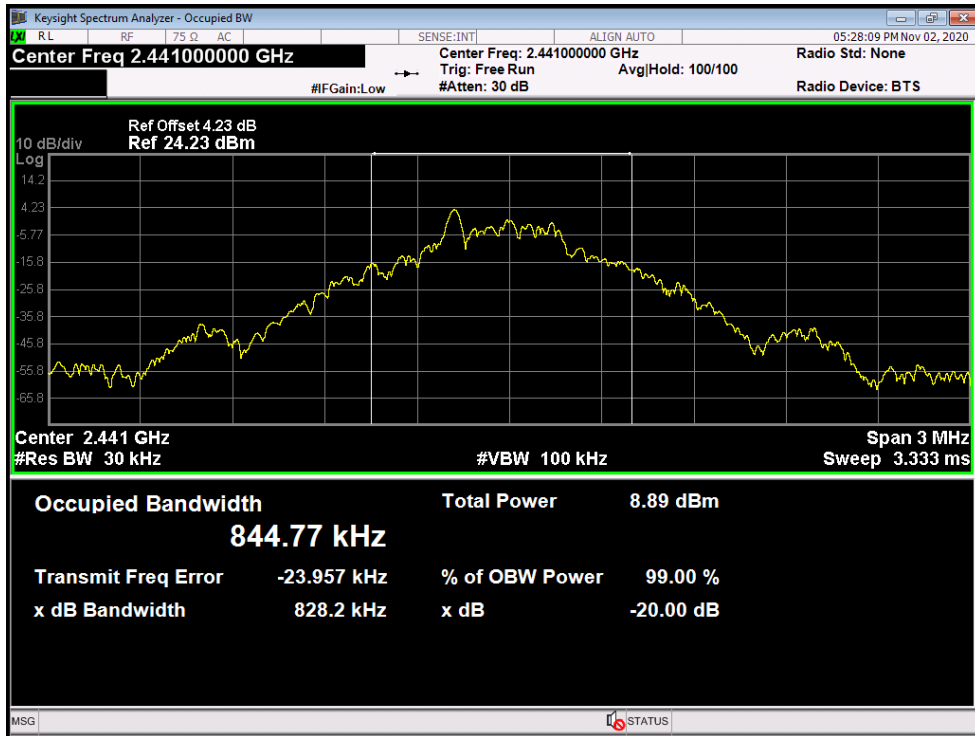

**GFSK TX Mode**

**2480 MHz**

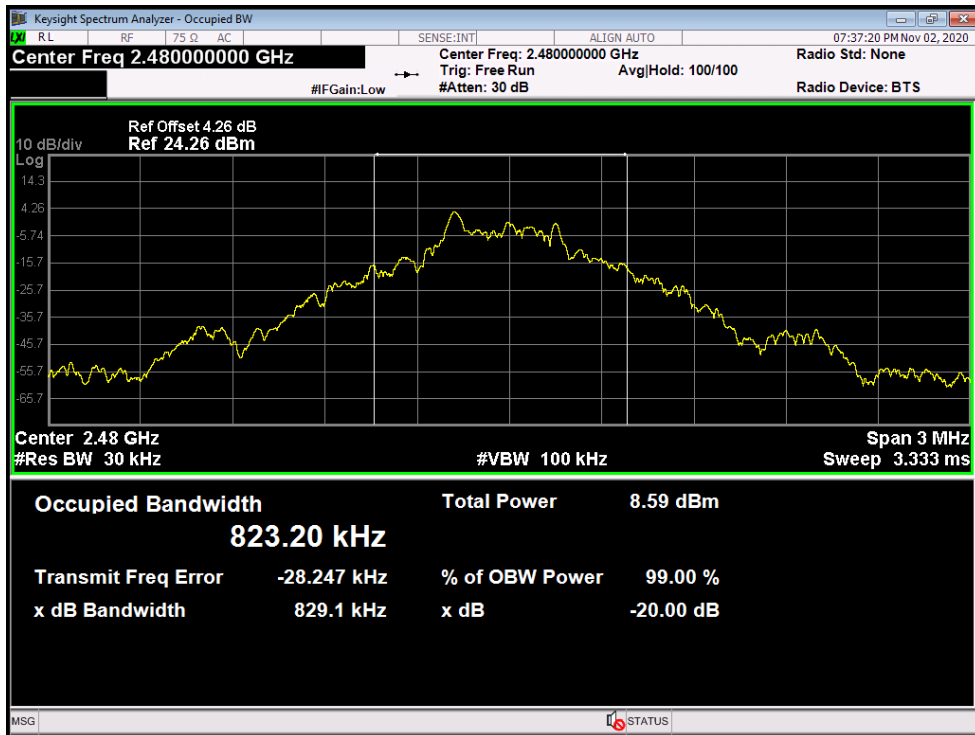

<b>Temperature:</b>	25°C	<b>Relative Humidity:</b>	55%
<b>Test Voltage:</b>	DC 4.5V		
<b>Test Mode:</b>	Hopping Mode (GFSK)		
<b>Channel frequency (MHz)</b>	<b>Separation Read Value (kHz)</b>	<b>Separation Limit (kHz)</b>	
2441	1002	828.2	

**GFSK Hopping Mode**

**2441 MHz**

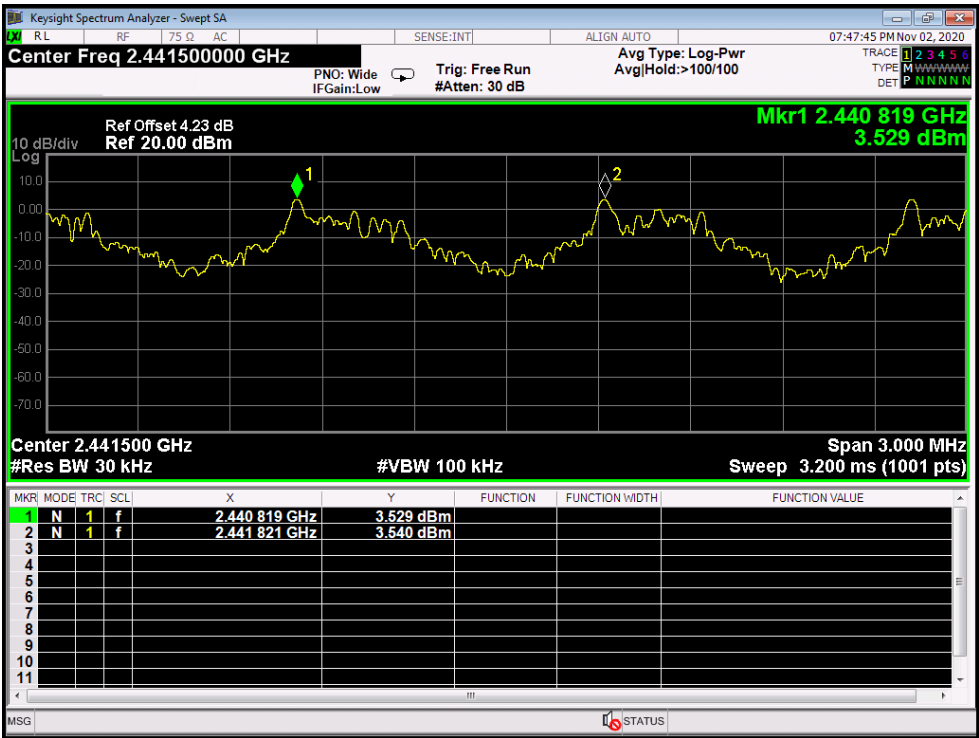

**Attachment F-- Peak Output Power Test Data**

<b>Temperature:</b>	25°C	<b>Relative Humidity:</b>	55%
<b>Test Voltage:</b>	DC 4.5V		
<b>Test Mode:</b>	TX Mode (GFSK)		
<b>Channel frequency (MHz)</b>	<b>Test Result (dBm)</b>	<b>Limit (dBm)</b>	
2402	3.661	21	
2441	3.757		
2480	3.235		
<b>GFSK TX Mode</b>			

**2402 MHz**

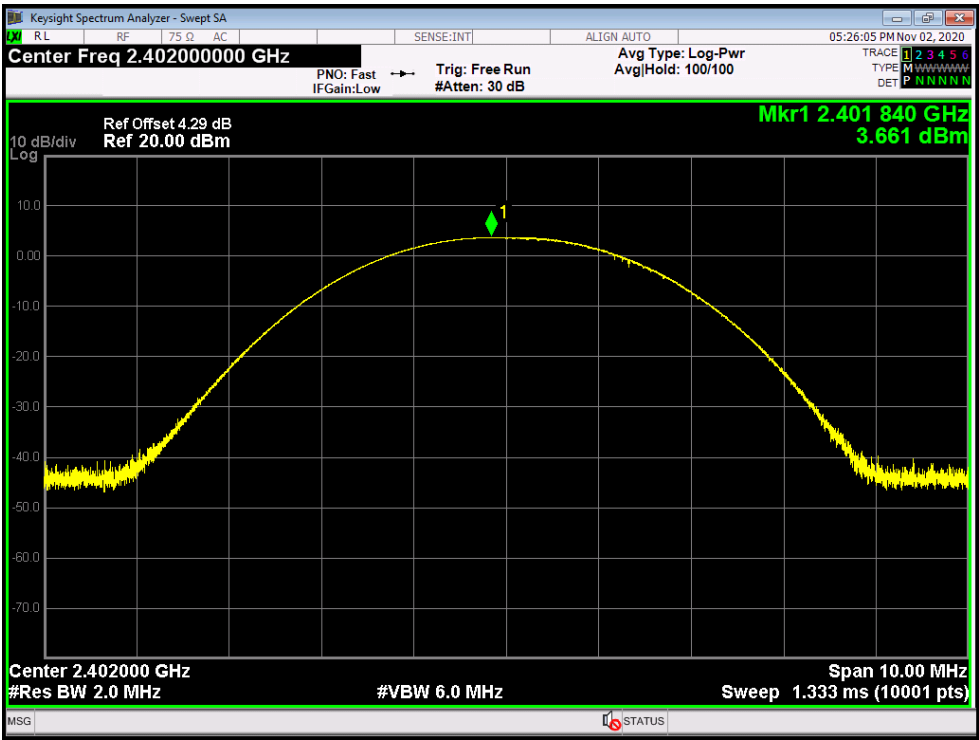

**GFSK TX Mode**

**2441 MHz**

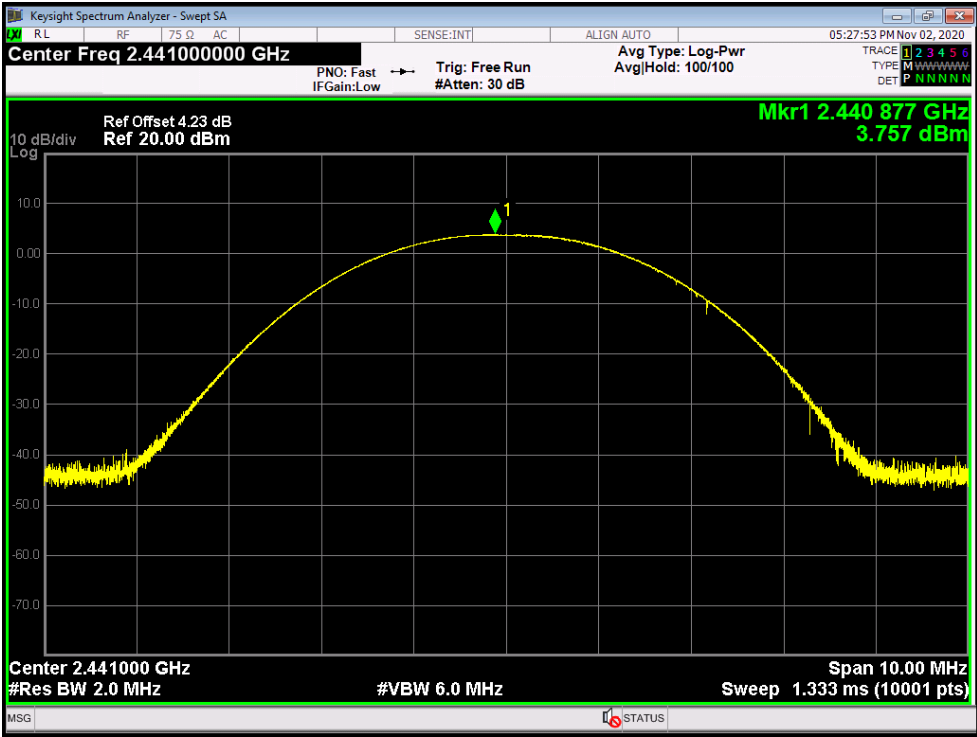

**GFSK TX Mode**

**2480 MHz**

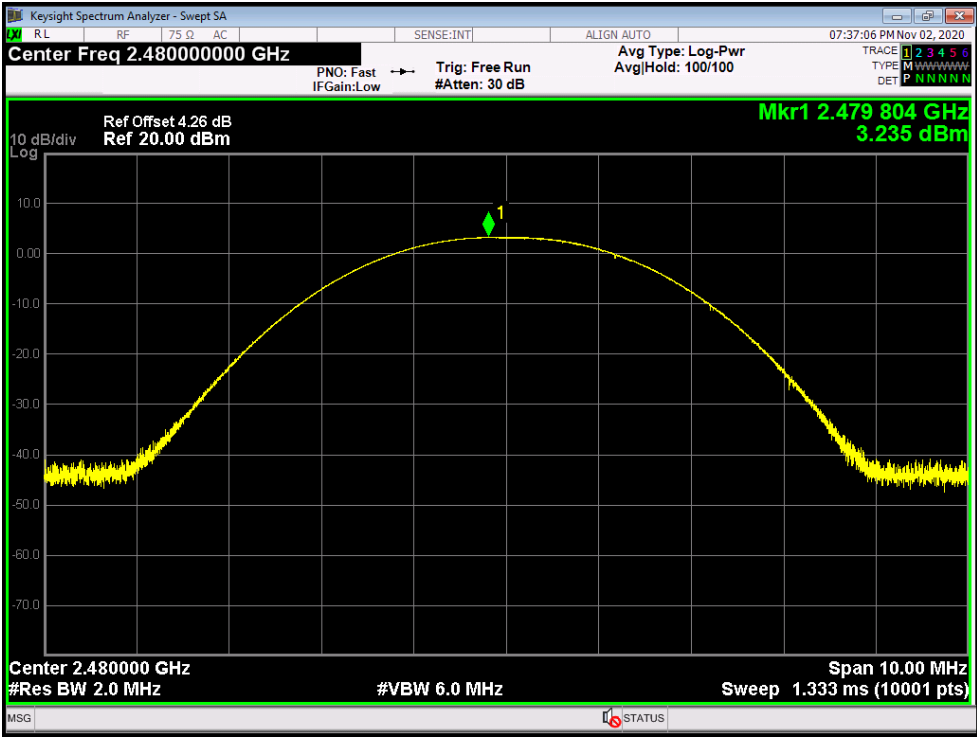

-----END OF REPORT-----