

Fly+Drive Drone — 5-inch

14+

Getting to Know Your Drone

PLEASE READ ALL WARNINGS AND INSTRUCTIONS PRIOR TO USE. KEEP THIS DOCUMENT AS IT CONTAINS IMPORTANT INFORMATION ABOUT YOUR DRONE.

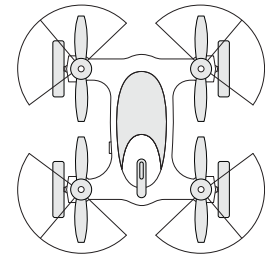
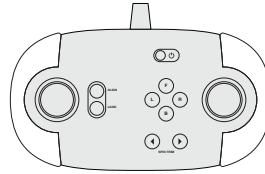

1. PREPARE FOR FLIGHT

- Drone must be charged before each use (Cable included)
- Indicator light will turn off once fully charged
- Install batteries in remote

2. PAIR YOUR DRONE

Before each flight pair the remote with the drone:

1. Turn your drone on and place on a flat, level surface
2. Turn on the remote on and move the left joystick up, then down
3. The beep will indicate successful pairing
4. Repeat steps 1 and 2 if necessary

3. REMOTE CONTROL OVERVIEW

Practice flying your drone below 10 feet and at low speeds until comfortable with all controls to avoid unnecessary damage or injury

- Left joystick: left/right controls spin and Up/Down controls elevation
- Right joystick: controls flight direction
- Direction Trim: use to eliminate drift

To cut power to drone, move left joystick to down position

**QUESTIONS OR CONCERNS?
PLEASE GIVE US A CALL ... WE'RE HERE TO HELP**

**ADULT ASSEMBLY, CHARGING, AND
BATTERY INSTALLATION IS REQUIRED.
ADULT SUPERVISION IS REQUIRED.**

CUSTOMER SUPPORT

(800) 374-2744

Before calling please locate the 10-digit code printed on the back of your remote



WARNING:
CHOKING HAZARD - Small Parts.
Not for Children under 3 years.

Sharper Image® name and logo are registered trademarks. Distributed by and © 2022 MerchSource, LLC. Irvine, CA 92618. All rights reserved.

Distributed by MerchSource, LLC, Irvine, CA 92618.
For technical support, please visit www.merchsource.com or call 1-800-374-2744.

The artwork and design of this manual are protected by US copyright law and may not be reproduced, distributed, displayed, published or used for any purpose without prior written permission. It is not permitted to alter, remove or reproduce any trademarks or copyright notice from this manual.

KEEP THIS INSTRUCTION MANUAL AS IT CONTAINS IMPORTANT INFORMATION FOR FUTURE REFERENCE.

Due to continuous product improvements, the picture on the manual may differ slightly from the actual product.

PATENT PENDING

Model Number: 1014342

Fly+Drive Drone — 5-inch

INTRODUCTION

Congratulations on your purchase of the Rechargeable 2.4 GHz Fly+Drive Drone. Get ready to soar to new heights. Master the art of drone flying with remote control maneuverability. This lightweight drone will provide hours of fun.

SPECIFICATIONS

Drone Battery: 800 mAh Li-po
Remote Controller Battery: 4 x 1.5V “AA”
Charging Time: 120 minutes
Maximum Recommended Altitude: 100 ft.

TABLE OF CONTENTS

General Warnings	Page 1
Contents, Remote Battery Installation, Battery Warnings	Page 2
Charging LiPo Battery and Replacing Propellers	Page 3
Remote Overview	Page 4
Operating Drone	Page 5
Align and Tips	Page 6

Fly+Drive Drone — 5-inch

READ ALL WARNINGS AND PRECAUTIONS BEFORE USE

SAFETY WARNINGS

- Not recommended for children under 14 years of age. As with all electrical products, precautions should be observed during handling and use to reduce the risk of electrical shock.
- Adult supervision is required at all times.
- Drive drone only on smooth flat surfaces.
- Never fly drones above or near people, sudden changes in wind or other conditions could lead to unexpected crashes.
- Always use caution when flying drone vehicles, obey relevant laws, respect the privacy and property rights of others.
- The drone shall never be modified or used for anything except its intended purpose.
- Before each use, an adult should review the product and battery to determine that no damage or hazards exist.
- **DO NOT TOUCH SPINNING PROPELLERS.**
- Do not allow anything to intentionally make contact in any way with spinning propellers
 - Prevent contact with spinning blades by turning off remote prior to handling drone.
- **Use caution and pay attention to your surroundings while operating drone.**
- **Do not fly drone into animals, people, or inanimate objects.**
- Keep drone away from power lines, buildings, trees, public areas, and any other potentially hazardous areas.
- Do not operate in rain, heavy wind, and or any type of severe weather.
- Do not land drone on wet surfaces.
- Never touch or allow others to touch drone while it is flying.
- Always turn drone off when it is not in use.
- Always fly drone in large open areas.
- The drone will lose controlling capabilities if fly distance is more than maximum recommended altitude of 100 ft. Keep below 100 ft. to avoid potential crashing risk.

WARNING: Changes or modifications to this unit not expressly approved by the party responsible for compliance could void the user's authority to operate the equipment.

Fly-aways are the responsibility of the individual pilot and will not be replaced by the manufacturer.

This drone weighs 0.163 (74g). As of December 21, 2015, the Federal Aviation Administration (FAA) only requires registration on unmanned aircrafts weighing more than .55 lbs. Visit www.faa.gov/uas/registration/ for more information. Although the FAA does not require this drone to be registered, ongoing compliance with federal, state, and local laws is an owner's sole responsibility. Always fly safely and respect the privacy of others.

This device complies with Part 15 of the FCC Rules. Operation is subject to the following two conditions: (1) this device may not cause harmful interference, and (2) this device must accept any interference received, including interference that may cause undesired operation.

Note: This equipment has been tested and found to comply with the limits for a Class B digital device, pursuant to part 15 of the FCC Rules. These limits are designed to provide reasonable protection against harmful interference in a residential installation. This equipment generates, uses and can radiate radio frequency energy and, if not installed and used in accordance with the instructions, may cause harmful interference to radio communications.

However, there is no guarantee that interference will not occur in a particular installation. If this equipment does cause harmful interference to radio or television reception, which can be determined by turning the equipment off and on, the user is encouraged to try to correct the interference by one or more of the following measures:

- Reorient or relocate the receiving antenna.
- Increase the separation between the equipment and receiver.
- Connect the equipment into an outlet on a circuit different from that to which the receiver is connected.
- Consult the dealer or an experienced radio/TV technician for help.

TROUBLESHOOTING:

When remote switch is turned on, the remote light does not illuminate:

- 1) Check that batteries in the remote are installed correctly OR
- 2) Replace with new batteries

When the remote is switched on, the remote LED is flashing:

- 1) Remote batteries are low.
- 2) Replace them with new batteries.

Drone and remote properly pair, but the drone will not lift-off:

- 1) Drone Li-Po needs charging. Use charging cable to connect the drone to power source.

After trimming the drone, the drone flight is very unstable and cannot fly properly:

- 1) One or more blades are most likely damaged;
- 2) Turn off the drone and remote.
- 3) Replace with the proper number replacement blade and try flying again.

After impact, the drone is unstable:

- 1) Put the left tremote control lever to the left bottom and put the right remote control lever to the right bottom at the same time which resets the drone (lights will flash quickly).
- 2) If the above does not resolve the issue, reboot the drone and controller and pair again.

Remote Controller and Drone can not be paired:

- 1) Check Point: Remote Controller must be close to Drone, do not exceed 4 meters.

Note: If there are 2 sets of Drones within 4 meters for Pairing, you must pair one successfully before pairing the second set.

Fly+Drive Drone — 5-inch

CONTENTS

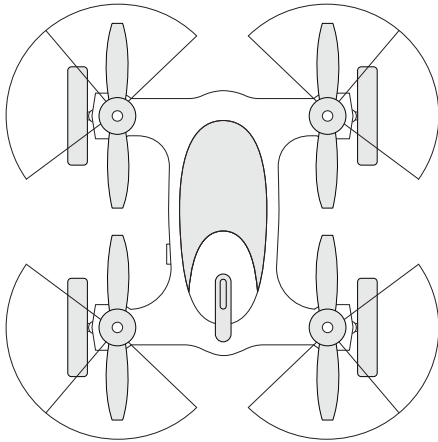

Drone - 5in. Fly+Drive Drone

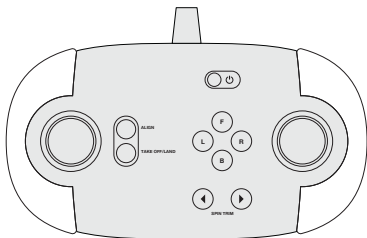

Drone Controller

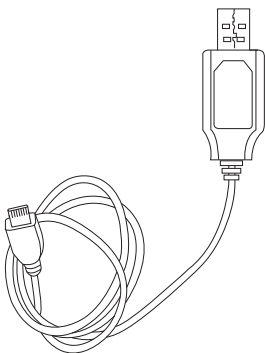

Charge Cable

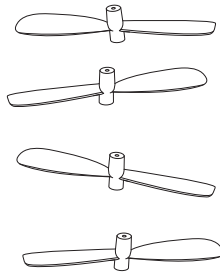

Propellers

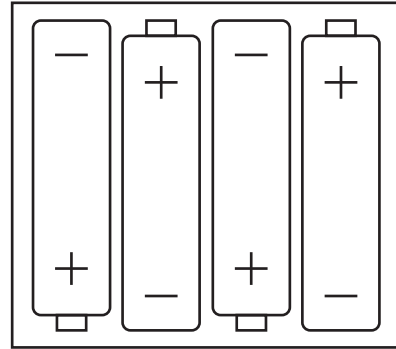

REMOTE BATTERY INFORMATION

1. Unscrew the remote battery door using a Philips head screwdriver (not included).
2. Install 4 “AA” batteries as shown in the diagram above.
3. Replace and close battery compartment.

⚠ LITHIUM-POLYMER BATTERY WARNING

There is a risk of fire and personal injury if Li-Po battery is punctured, damaged or misused.

- Never expose battery to extreme temperatures or moisture.
- Do not subject battery to strong impacts.
- Always keep battery away from flammable materials.
- Only use manufacturer specified batter(ies), charger(s), and/or adapters, if applicable.
- Battery is not serviceable.
- Let battery cool to room temperature before charging.
- While charging, never leave battery unattended.
- Recycle or dispose of battery according to federal, state and local laws.

KEEP THIS INSTRUCTION MANUAL FOR REFERENCE

BATTERY WARNING - ALKALINE (AA)

- Do not mix old and new batteries.
- Do not mix alkaline, standard (carbon-zinc), or rechargeable batteries.
- Insert batteries using the correct polarity. Do not short-circuit the supply terminal.
- Only use manufacturer specified batter(ies), charger(s), and/or adapters, if applicable, specified by the manufacturer.
- Always use, replace, and recharge (if applicable) batteries under adult supervision.

Fly+Drive Drone – 5-inch

CHARGING BATTERY

Note: The Battery Charger will light up when it is charging the battery and turn off when the battery is fully charged. Charge time is approximately 120 minutes.

1. Turn off the drone before charging.
2. Connect the Battery Charger Cable to the port found on the side of the drone.
3. Connect USB connector to the power source.

Connect the Charge Cable to the Drone

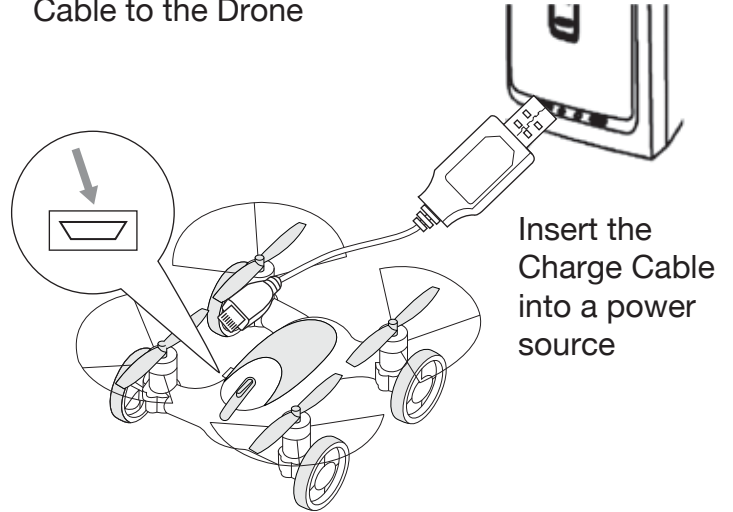

Replacing Propellers

1. Pull firmly to remove broken propeller. Replace with a new one. Push firmly and carefully.
2. Replace propellers by following the diagram on the right.
3. Each blade spins differently. Blade A1 turns clockwise and Blade B1 turns counter clockwise.

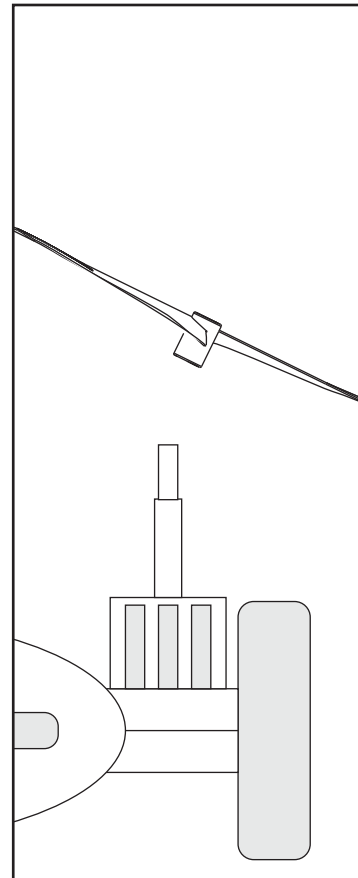
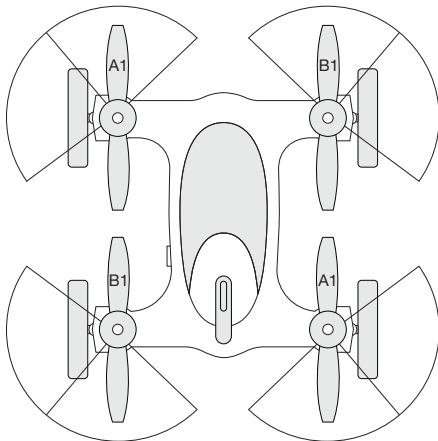

Fly+Drive Drone — 5-inch

REMOTE OVERVIEW

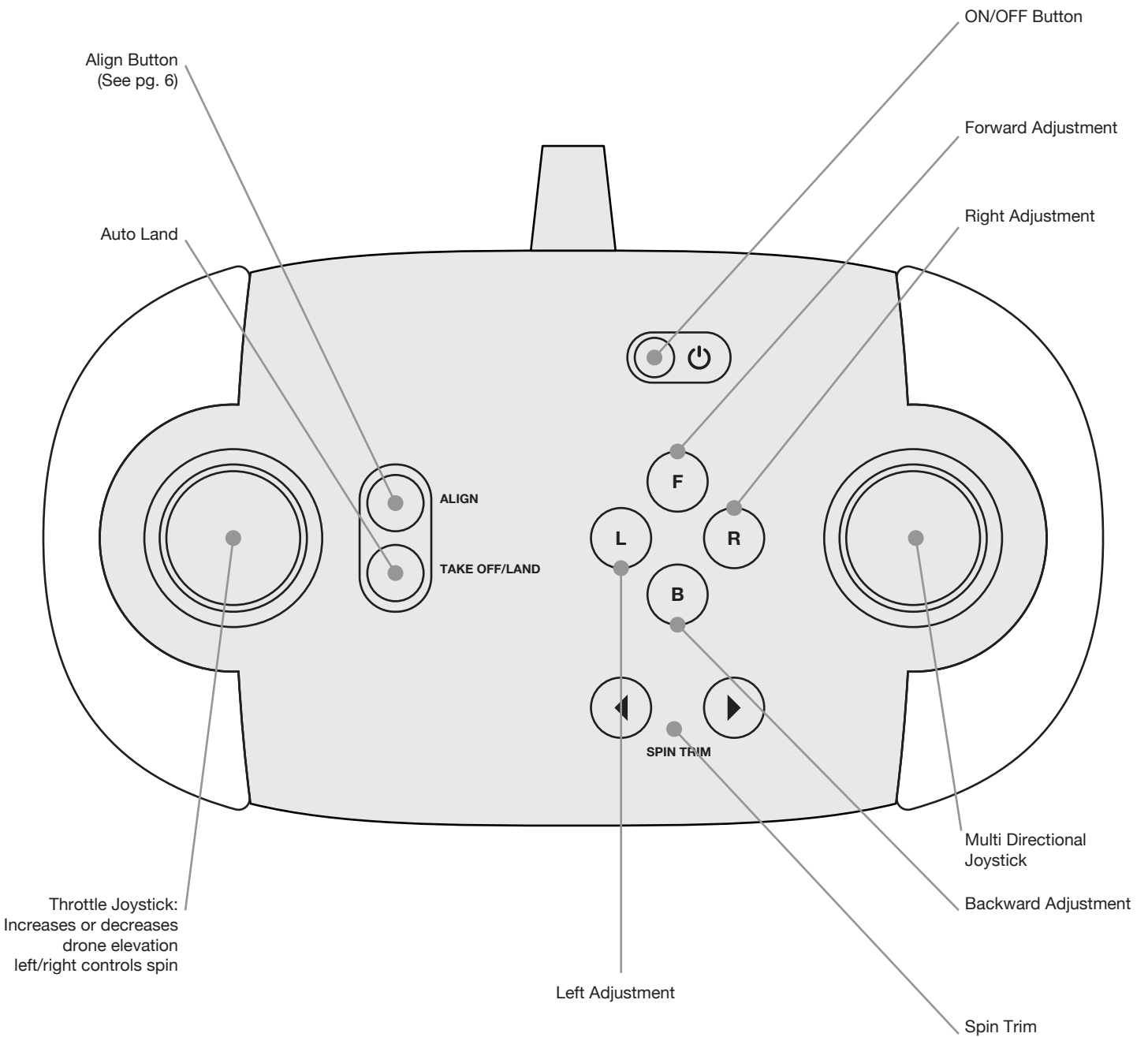

Fly+Drive Drone – 5-inch

OPERATING DRONE

Step 1 – Pre-Flight Checklist

- Read all warnings and instructions.
- Install remote batteries, page 2.
- Charge batteries, page 3.
- Make sure that drone and remote are powered off.

Step 2 – Choosing a location

- Drone is designed to be flown/driven indoors and outdoors.
- Always make sure you have enough space to fly drone.
- Always follow warnings, page 1.

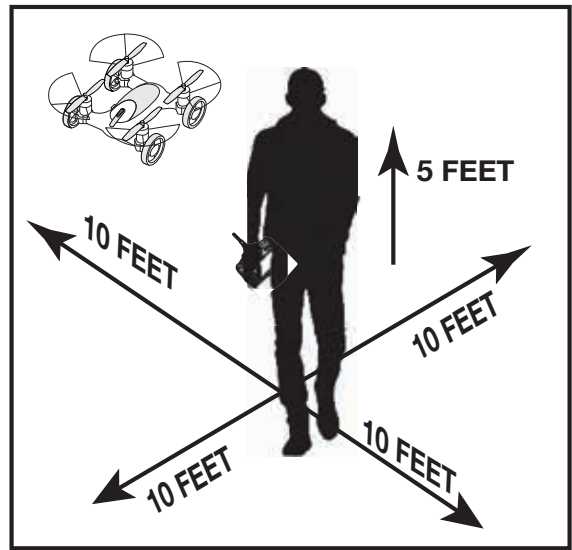

Step 3 – Driving Mode

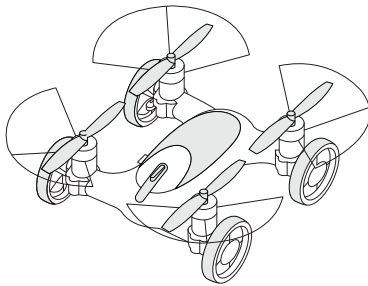

1. Turn the drone and remote on then place the drone on a hard flat surface and allow to sit for 4 seconds.

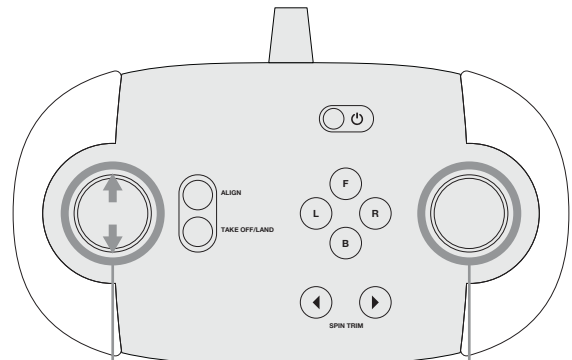

2. Pair remote to drone: Bring the Throttle all the way up then bring it all the way down, remote will beep once paired.

3. Use the right joystick to move the car forwards, backwards and turn left or right.

Note: After pair is successful, keep the throttle in center to enter driving mode. After pair is successful, you can enter flying mode by following step 4 (shown below).

Step 4 – Lift Off

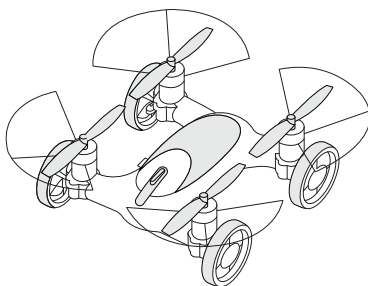

1. Bring the car to a stop.

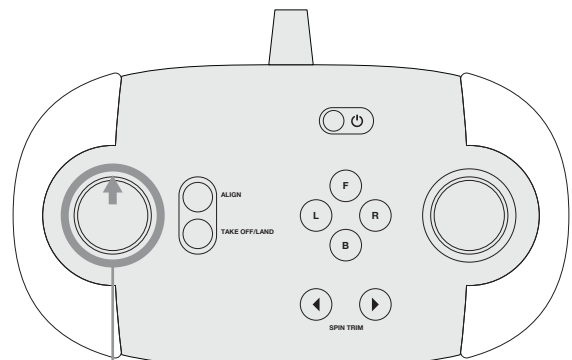

2. Press TAKE OFF/LAND button OR slowly press the Throttle Joystick stick up. Drone will begin to elevate. You can compensate for some of the drone's drifting by using the Multi Directional Button or by following step 5. You may need to practice this step several times before successfully getting drone into the air.

Fly+Drive Drone – 5-inch

OPERATING DRONE (Cont.)

Step 5 – Operating Drone in Flight

Follow this step if your drone begins to drift while take off or during flight.

- F. Drone drifts backwards: Press the Forward Adjustment Button.
- B. Drone drifts forwards: Press the Backwards Adjustment Button.
- L. Drone drifts right: Press the Left Adjustment Button.
- R. Drone drifts Left: Press the Right Adjustment Button.

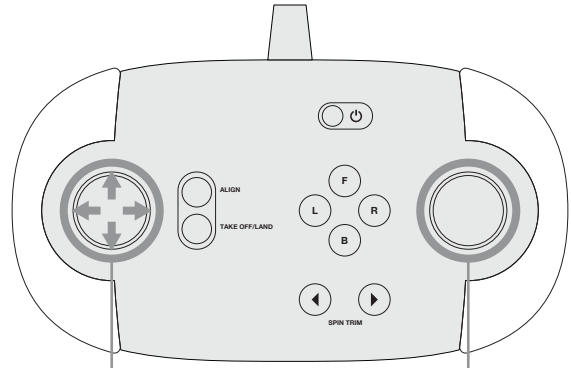

Use the Throttle Joystick to increase or decrease your elevation. Push the throttle to left, make the drone to rotate counterclockwise. Push the throttle to right, make the drone to rotate clockwise.

Use the Multi Directional Joystick to move forwards, backwards or side to side.

Step 6 – Landing Drone

1. Lower drone to 20 feet or less then press the Take Off Land button. Use the Multi Directional Joystick to maneuver drone. Or Push the left joystick down until the drone landing.
2. In the event the blades will not stop spinning, you can perform an emergency stop by pressing and holding the TAK OFF/LAND button.

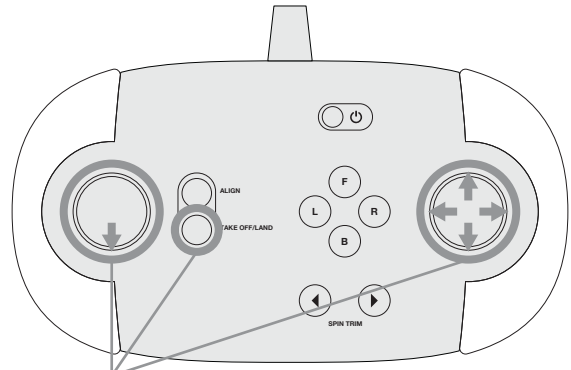

Lower drone to 20 feet or less then press the Auto Land button. Use the Multi Directional Joystick to maneuver drone. Press the Auto Land Button a second time to deactivate auto land.

Step 7 – Retrieving Drone

1. Turn off your remote by pressing the Power Button. This will stop you from accidentally turning the propellers on.
2. Make sure the propellers have stopped spinning then pick up your drone.
Note: You will need to pair your drone again before your next flight.

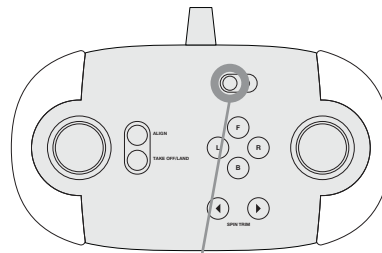

Turn off your remote by pressing the Power Button.

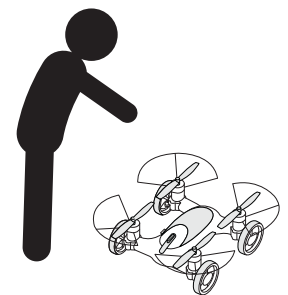

Align

Press the Align Button to turn Align mode ON and then again to turn off.

- In this mode, the drone will always move in the direction you press the Multi Directional Button no matter which way the drone faces.

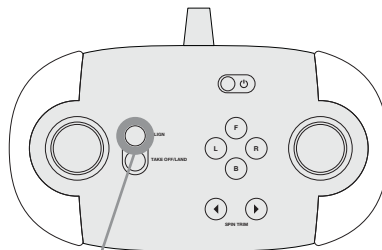

Align Button

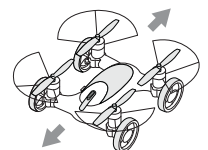

Tips

- Do not crash drone into sand or dirt. Drone gears may become clogged.
- When first learning to fly, practice lifting off and hovering.
- Stay several feet from walls and buildings.