

# SKYHAWK

## FOLDABLE VIDEO GPS DRONE



APP CONTROL



ARTICULATING VIEW



FLIGHT RANGE



FOLLOW ME MODE



AUTO HOVER



1 EXTRA SET OF PROPELLERS



ONE KEY RETURN



DRC442-BLK  
USER MANUAL

# PRE-FLIGHT CHECKLIST

Before attempting to fly your drone, make sure that you have done all of the following:



## **Inserted 3 AA Batteries in Your Remote**

See page 6 of this manual for more information.



## **Charged Your Drone's Battery**

See page 6 of this manual for more information.



## **Checked That the Propellers are Firmly Attached**

See page 17 of this manual for more information.



## **Connecting Your Drone with the Remote Control**

See page 7 of this manual for more information.



## **Calibrated Your Drone's GPS**

See pages 8-9 of this manual for more information.



## **Calibrated Your Drone's Gyroscope**

See page 9 of this manual for more information.



## **Prepare Your Drone For Take-off**

See page 12 of this manual for more information.



### **WARNING!**

Failure to calibrate your drone before flight can lead to severe flight malfunctions and potential damage to your drone. Always fly carefully!

# 1. Introduction

Thank you for purchasing the Sky Hawk GPS Video Drone, item DRC442. The included remote controlled aircraft is designed specifically for outdoor flying. In order to get the best possible results, please read this user's manual carefully before using. In addition, be sure to keep this manual in a safe place for future reference.

## IMPORTANT NOTE: FAA REGISTRATION

Owners of a drone that weighs more than 0.55 lbs. (250 g) and less than 55 lbs. (25 kg) must register their UAS online at the FAA website, <https://www.faa.gov/uas/registration>.

After receiving the certificate of registration, a unique FAA registration number will be provided and it must be marked on the Drone by any means, such as permanent marker, label, engraving, or other means, as long as the number is readily accessible and maintained in a condition that is readable and legible upon close visual inspection.

### Drone Safety Tips

- Register your drone
- Fly your drone at or below 300 feet
- Keep your drone within your line of sight
- Be aware of FAA Airspace Restrictions
- Respect privacy
- Never fly near other aircraft, especially near airports
- Never fly over groups of people, public events, or stadiums full of people
- Never fly near emergencies such as fires or hurricane recovery efforts
- Never fly under the influence of drugs or alcohol

# 2. Features

- 15 Minute Flight Time
- Follow Me Technology
- Auto Take off and Landing
- Real Time Transmission
- Coreless Motors
- 1080P HD Video
- Headless Mode Directional Lock
- Charging Time Approximately **200** minutes
- Variable Speed Settings
- Altitude Hover
- GPS
- 500Ft Range

# 3. Package Contents

- Sky Hawk GPS video Drone
- Remote Control
- 3.7V Li-polymer Battery For Drone
- Drone Guards
- Extra Rotor Blades
- USB Charging Cable
- Screwdriver
- User's Manual with Warranty Information

## 4. Important Safety Precautions

When using your Sky Hawk GPS Video Drone, basic safety precautions should always be followed, including the following:

1. Do not allow children or the infirm to operate your drone without adult supervision. For safety purposes, only allow experienced pilots aged 14 and up fly your drone.
2. To avoid choking hazards, keep all small parts and pieces away from children.
3. Your drone is not a toy. Makes sure that it is properly assembled before use, and operated safely.
4. Keep your drone away from obstacles, crowds, power lines, trees, and bodies of water while it is in flight. Always fly your drone in a wide open spacious environment. Avoid flying your drone directly above people or animals. Maintain a 7ft (2m) distance from the aircraft when taking off and landing.
5. Only use your drone in a dry environment. Your drone is composed of sophisticated electronic components and parts. To avoid damage to your drone, please keep your drone away from water and moisture. Use a soft dry cloth to wipe the surface of your drone and keep it clean.
6. Beginner and novice level pilots should practice flying with experienced pilots until suitably experienced in flight.
7. To ensure safety, only use the included parts when using your drones.
8. Make sure to keep your ears and eyes protected when using your drone. When your drone's blades are spinning, make sure to keep people and objects at a distance from rotating parts.
9. Keep your drone away from excessive heat or flames, especially while charging the battery.
10. Please recycle or dispose of your drone properly based on the laws and rules of your municipality.
11. Contact local recycling facilities and/or the manufacturer of your drone for further information.
- 12. Your drone is specifically designed for outdoor flying. Do not attempt to fly your drone or calibrate it indoors.**

### BATTERY SAFETY WARNING

- When handled incorrectly, lithium polymer batteries can be dangerous and can potentially harm and do damage to persons or property. The manufacturer of your drone does not accept any liability for damage to persons or property if the battery is not correctly charged, stored or protected.
- Always unwind all cables before charging.
- Do not over charge the battery. Once the charging process is completed, remove the battery from the charger as soon as possible.
- Only use the included or replacement Sky Hawk charging cable and batteries.
- You must charge the lithium polymer battery in a safe area away from flammable materials.
- The battery is only to be charged under adult supervision, do not leave charging batteries unattended. You should always remain in constant observation to monitor the charging process and react immediately to any potential problems that may occur.
- Do not charge the battery in temperatures hotter than 40°C or colder than 0°C.
- Do not cover the batteries when charging. Do not leave batteries in direct sunlight.
- After each flight and/or crash, please check the battery for any damage or swelling. If the battery is damaged, leaking, making noise, punctured or malformed in any way DO NOT attempt to use it. Please dispose of the battery immediately and safely.
- Do not bend, puncture, crush or scratch the drone's battery. Do not store batteries in your pockets, on your person or in extreme temperatures.
- After flying/discharging the battery you must allow it to cool to ambient room temperature before recharging.
- If at any time during the charge or discharge process the battery begins to balloon or swell, discontinue charging or discharging immediately. Quickly and safely disconnect the battery, then place it in a safe, open area away from flammable materials to observe it for at least 15 minutes. Continuing to charge or discharge a battery that has begun to balloon or swell can result in a fire. A battery that has ballooned or swollen even a small amount must be removed from service completely.
- Never plug in a battery and leave it to charge unattended overnight.
- Non-compliance with the above warnings may result in the failure of the battery.

## 5. A Quick Look at Your Remote Control

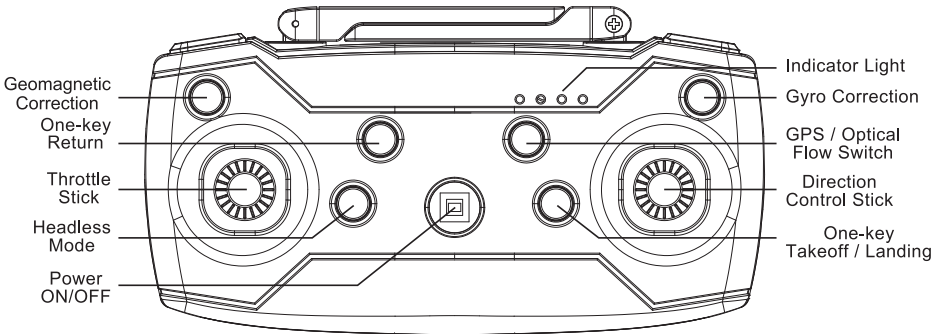
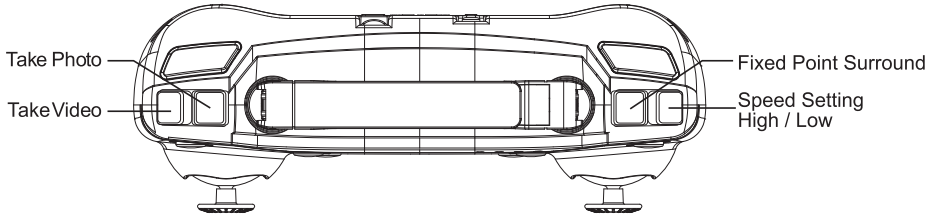

## 6. A Quick Look at Your Drone

### Top View

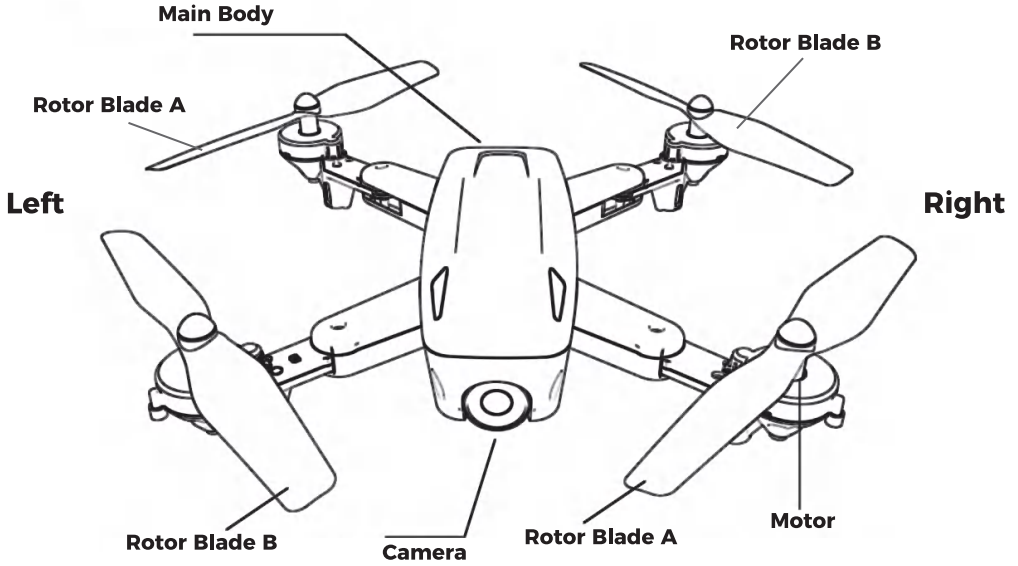

Note: When changing rotor blades the A/B labels should correspond with the diagram above.

### Bottom View

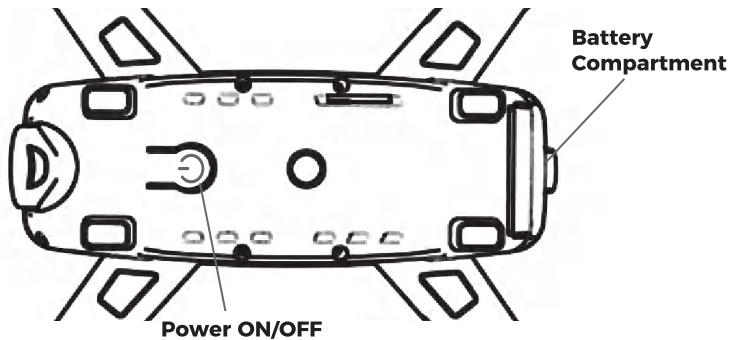

## 7. Powering Your Drone & Remote

### Inserting Batteries Into Your Remote

- Use a screwdriver (included) and turn it counterclockwise. Take out the screw and press the tab down to open up the battery compartment located on the rear of your remote control.
- Insert 3 AA 1.5V batteries, making sure that the batteries are inserted with the correct polarity (+,-) as displayed in the battery compartment.
- Once the batteries are inserted, put the battery compartment covers back on the battery compartments, and use a screwdriver to close them securely.

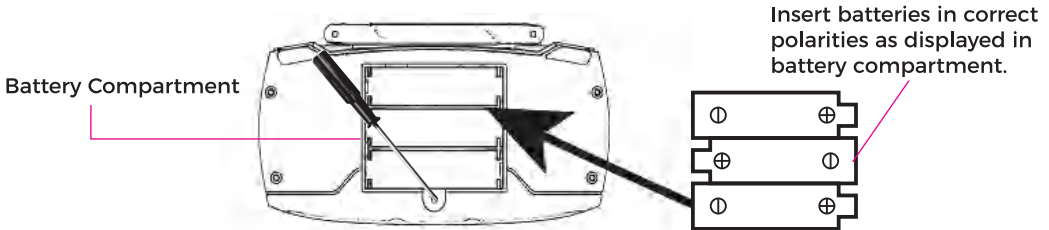

- Do not mix rechargeable and non-rechargeable batteries.
- Do not mix old and new batteries or different types of batteries.
- Remove exhausted batteries and dispose of them based on the rules of your local municipality.
- Remove the batteries from your remote control if it will not be in use for an extended period of time.

### Charging the Drone's Battery

- Connect the battery to one end of the included charging cable. Then plug the other end into a USB charging adapter (not included).
- USB charging cable will light up red while charging and turn off once battery is full.
- Insert the battery into the drone's battery socket. Close the battery compartment.

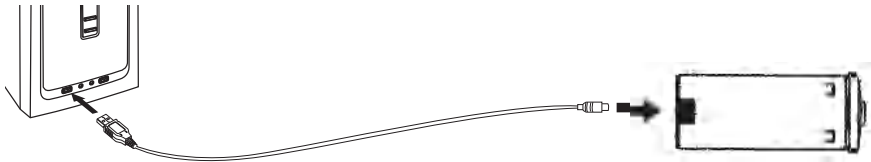

### **WARNING:**

1. The charging plug can overheat if overcharged. If this occurs unplug the charger immediately to avoid damaging the battery.
2. Do not leave the battery unattended when charging.
3. Do not use other chargers other than the one supplied.
4. Wait at least 30 minutes after using your drone before charging the battery. The battery's temperature can become elevated during use and charging it immediately could damage the battery.
5. Remove the drone's battery when the drone is not in use. Store it in a cool dry place.
6. Do not leave the battery exposed to excessive heat, flame or fire.
7. Do not short circuit the battery. Do not leave the battery in contact with any metal parts.

## 8. Connecting Your Drone & Remote

To connect your drone to the remote controller, press the Power ON/OFF button located at the bottom of the drone. The lights on the drone will flash quickly, indicating that the drone is powering on.

-Press the Power ON/OFF button located at the center of the remote control. Once the light emitting from the light indicator on your remote control is steady, the lights on the drones change to flash slowly to indicate a successful connection.

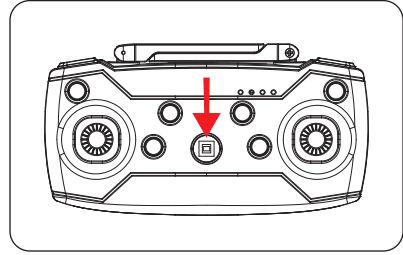
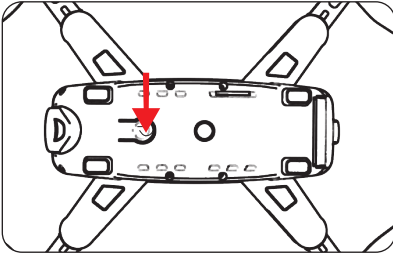



## 9. Calibrating Your Drone (Preparing for Flight)

Before preparing your drone for flight, first make sure that you have a suitable environment for flight. Avoid flying in rain or snow, or in windy conditions. Stay away from people, trees, power lines, tall buildings, airports and signal towers. **Your drone is specifically designed for outdoor flying. Do not attempt to fly your drone or calibrate it indoors.**

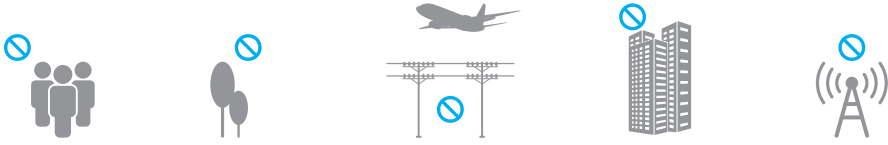

### Ideal flying conditions:



Fly in a open unobstructed environment

+



Strong GPS signal

+



Fly within Visual range

+

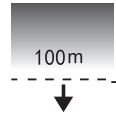

Control flight Height below 100m

To power on your remote control, press the Power ON/OFF button. You will hear a beep when it powers on. To power on your drone, press and hold the power button. The LED light on the drone flashes rapidly. Once your drone and remote control are powered on, follow the calibration steps below in order to prepare your drone for flight.

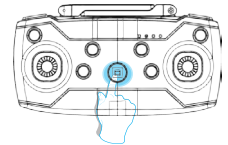
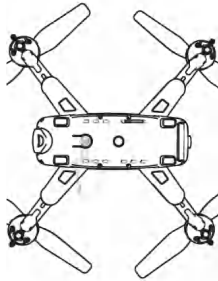

# 10. Geomagnetic Calibration

Before you start, make sure your drone is placed on a flat, stable surface.

-To begin the geomagnetic calibration process, press the Geomagnetic Correction button located at the top left of your controller. The front white lights on your drone will start to flash and rear red lights is shine steadily.

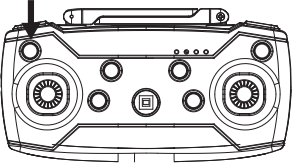

**Note:** When in GPS mode, please make sure to go through the geomagnetic calibration process each time you fly your drone (once the drone is turned on)!

-Rotate your drone horizontally, spinning it in a clockwise direction continuously until the controller beep.

-Turn the head downwards and rotate your drone clockwise vertically, spinning it continuously until the controller beep-beep, and the front & rear lights on your drone flash together, calibration is complete.

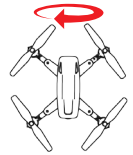

## WARNING

- When flying your drone in GPS mode, make sure you are in a wide open space.
- Do not calibrate your drone in areas where there are strong magnetic fields.
- When calibrating, do not carry ferromagnetic materials such as keys or cell phones.
- Do not calibrate near large sheets of metal.

## Calibrating Your Drone's Internal Gyroscope

Calibrate your drone's internal gyroscope to ensure smooth and balanced flight. Before you start, make sure your drone is placed on a flat, stable surface.

-Press and hold the Gyro Correction button. Calibration is successful when lights from drone persistently flash.

Note: If your drone takes off and flies without corresponding remote control command, you may need to retry calibrating the gyroscope.

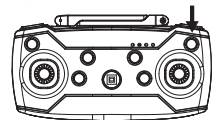
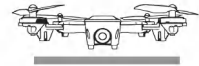

# 11. Flight Modes

## Outdoor Flight: GPS Mode

After successfully connecting to the remote controller and taking your drone to an open outdoor field, your drone will automatically go into the GPS mode. Your drone's front and rear lights will flash at the same time while it takes a few minutes to connect to a GPS signal. When GPS signal is obtained, drone's lights will stabilize.

If the drone lights flash three times, it means there is a GPS signal interference due to obstructing objects in the current flying environment. To remedy this, re-locate your drone to an environment where it can fly unobstructed.

## Indoor and Closed Spaces Flight: Optical Flow Mode

When flying your drone indoors or in closed spaces, press the GPS/Optical Flow Switch button to change the flight mode to optical flow mode. When you hear a beep from the remote controller, the front white lights on your drone will flash and rear red lights is shine steadily, it means the aircraft has entered indoor optical flow mode.

To re-enter GPS mode for outdoor flight, press the GPS/Optical Flow Switch button again and a beep will emit from the remote controller to indicate the aircraft has entered outdoor GPS mode.

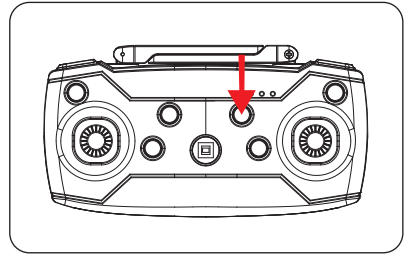

# 12. Flying Your Drone

## Pre-Flight Preparation

If you have never used a drone before and you are not an experienced pilot, make sure to read these instructions carefully before flying. Get familiar with all of the controls. If necessary, read through these instructions many times and practice handling the remote control until you feel completely comfortable and ready.

1. Place your drone in a clear, open field. Make sure that it is resting on a secure, flat surface.
2. Practice using the throttle stick and the directional control stick (see below).
3. By simulating the use of the remote and both sticks, you will grow more comfortable with the natural motions required during flight and you will learn to react more rapidly to unexpected circumstances.

### UP AND DOWN

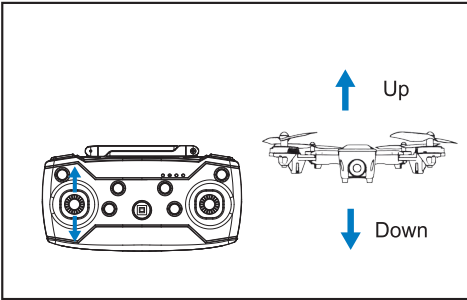

### FORWARD AND BACKWARD

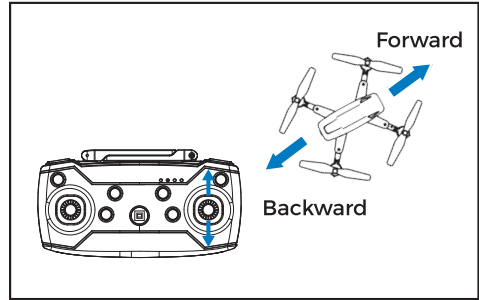

### LEFT AND RIGHT TURN

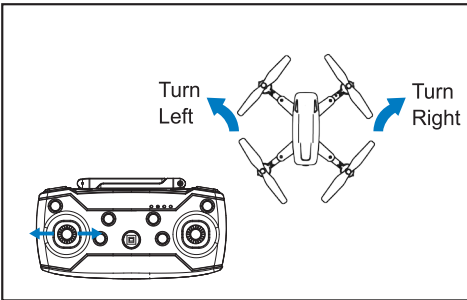

### LEFT AND RIGHT SHIFT

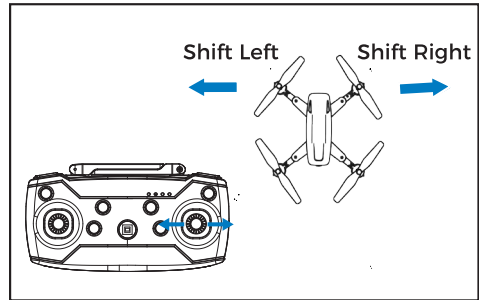

## ALTITUDE HOLD

Altitude hold works while you are flying your drone to help the drone hover and maintain a constant height making aerial photography easy.

To implement altitude hold, allow the left thumb stick to fall back to its default middle position while flying, and the drone will balance itself to hold its altitude.

# 13. Take-off & Landing

## Manual Take-Off

Once the remote is paired and your drone is calibrated, the drone will automatically search for a GPS signal. Once sufficient GPS connection is achieved, the lights on the aircraft will be steady. Push the left throttle stick to the bottom left and push the right direction stick to the bottom right simultaneously (↙↘). The blades will start to rotate. Push the throttle up, the aircraft will start to take off.

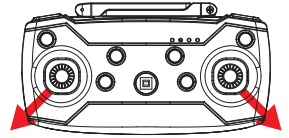

## One Key Take-off and Landing

For easy take-off, press the One Key Take-off button on the controller and the drone will automatically hover above the ground. Move your left control stick up and the drone will fly up.

By pressing the One Key Landing button, your drone will automatically land on the ground.

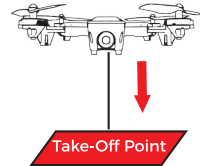
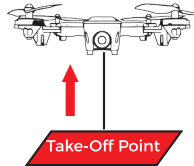
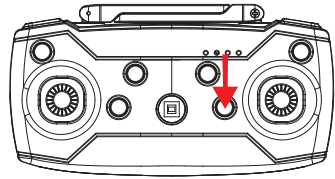

NOTE: Make sure your drone is properly calibrated before attempting to fly.

## 14. One Key Return

Press and hold the Return button located at the left side of your controller to start a return flight. The drone will travel back and land on the take-off point.

**PLEASE NOTE:** It is important that the GPS is correctly calibrated before launch and before activating one key return. Failing to do so may result in the drone flying away when one key return is attempted.

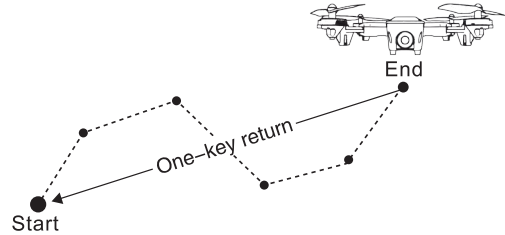
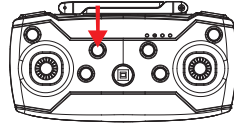

## 15. Speed Adjustment

Your drone has two speed modes: high speed and low speed.

To switch between speed modes, press down the speed button. Each mode will be identifiable by a series of beeps.

Low Speed Mode: One beep

High Speed Mode: Two beeps

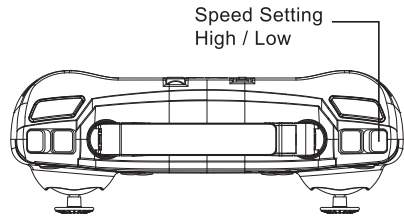

## 16. Motor Lockdown

When the rotor-blades are stopped by an obstacle the motors will go into a protective lock down mode.

To unlock the motors make sure the rotor-blades are clear from debris and put the drone back on the ground. Once you are ready to fly again please unlock the drone and the motors will release.

## 17. Headless Mode

Headless mode allows you to fly your drone without worrying about the drone's orientation. Regardless of which way the drone is facing, this function ensures that the drone will always follow controls from your perspective.

To enter Headless mode, before your drone takes off, stand in front of your drone and press the Headless mode button on your remote control. A beep will emit from your controller when headless mode is activated or deactivated. To turn off Headless mode, press the headless mode button again.

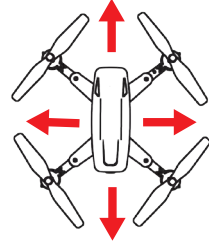
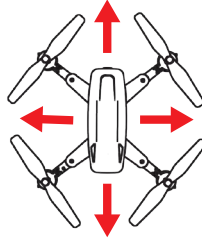
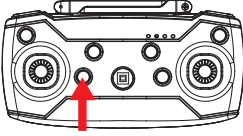

## 18. Emergency Landing

When the drone battery is low, its LED lights will slowly flash. When this happens, you should immediately fly the drone back to your location, otherwise the drone will begin flying automatically towards the take-off point and slowly lower itself to the ground.

The drone may not respond to commands from remote controller when drone battery is extremely low.

### CONTROLLER ALERTS

When the remote control battery is low, it will emit a slow series of beeps, signaling that the batteries need to be replaced.

**PLEASE NOTE:** Do not ignore low power warnings. Doing so may result in unplanned landings.

## 19. Wi-Fi Connection

### Using Wi-Fi to Connect the Drone to Your Phone

Press the power button on your drone to power it on.

When the drone is powered on (without the remote control powered on), the lights on the arms of the drone will flash. While these lights are flashing the WiFi signal will become available for connection.

In your Smartphone's Wi-Fi settings menu, make sure that Wi-Fi is turned on, and find and select the network named **SKYVIEW 2-XXXXX**.

## 20. VTI 360 Skyview 2 APP

### Download the VTI 360 Skyview 2 App

Use the VTI 360 Skyview 2 app to fly your VTI SKY HAWK Drone. Scan the QR Code below to download the app.



You can also download the VTI 360 Skyview 2 app from the Apple App Store or Google Play Store.  
The Android version is compatible with 6.0 and later.  
The iOS version is compatible with iOS 9.0 or later.



## 21. Using the VTI 360 Skyview 2 APP

Open the VTI 360 Skyview 2 application on your phone. Press the “GO” option on the menu screen in order to open the control interface.



Read Introduction for Beginner before opening the control interface. Press the “Next” button.

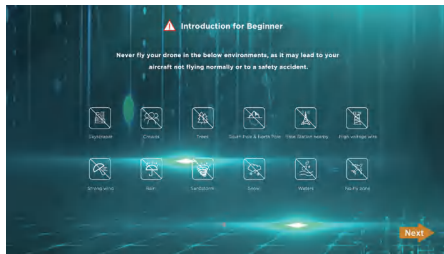

### Control Interface Functions

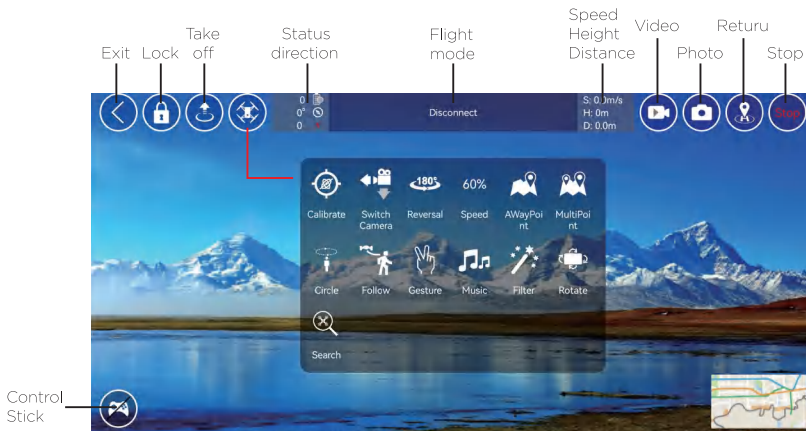

## 22. Follow Me

When activated, the Follow Me function will make the drone follow your smart phone's GPS location.

To activate Follow Me, press the follow button the control interface app.

**NOTE:** It is important that the GPS and smart phone are correctly connected to the drone.

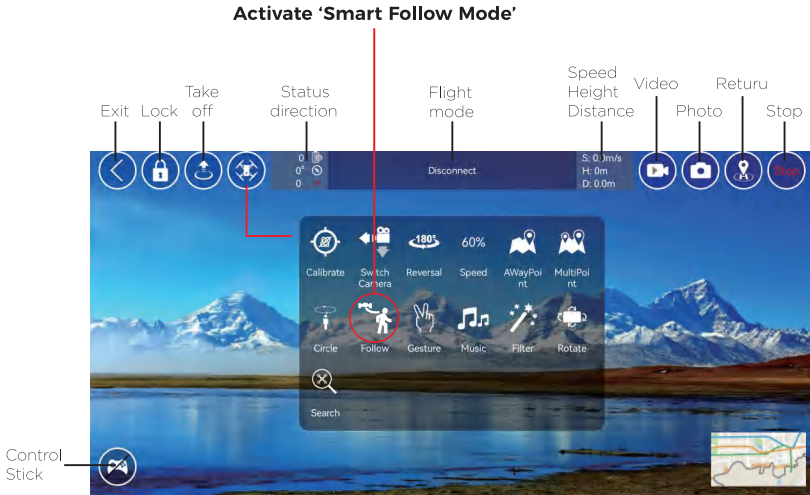

## 23. Propeller Blade Installation

If your rotor blades become damaged or the drone is no longer flying straight the rotor-blades may need to be replaced. To replace the rotor blades please follow the directions below.

1. Remove the motor cap and the screw securing the rotor blade, and lift the blade off taking note whether the blade that is being replaced is an 'A' blade or a 'B' blade.
2. Push the replacement blade onto the stem making sure that the screw holes align and the replacement rotor blade is the same ('A' or 'B') as the original rotor blade.
3. Once the rotor blade is in position replace the securing screw.

## Vivitar One Year Warranty

This warranty covers the original consumer purchaser only and is not transferable.

This warranty covers products that fail to function properly UNDER NORMAL USAGE, due to defects in material or workmanship. Your product will be repaired or replaced at no charge for parts or labor for a period of one year.

### What Is Not Covered by Warranty

Damages or malfunctions not resulting from defects in material or workmanship and damages or malfunctions from other than normal use, including but limited to, repair by unauthorized parties, tampering, modification or accident.

### To Obtain Warranty Service and Troubleshooting Information:

Call 1-800-592-9541 in the U.S. or visit our website at [www.vivitar.com](http://www.vivitar.com).

To receive Warranty service along with the name and address of an authorized product service center, the original consumer purchaser must contact us for problem determination and service procedures. Proof of purchase in the form of a bill of sale or receipted invoice, evidencing that the product is within the applicable Warranty period(s), MUST be presented in order to obtain the requested service. It is your responsibility to properly package and send any defective products along with a dated copy of proof of purchase, a written explanation of the problem, and a valid return address to the authorized service center at your expense. Do not include any other items or accessories with the defective product. Any products received by the authorized service center that are not covered by warranty will be returned unrepared.

## FCC Compliance Statement

Changes or modifications not expressly approved by the party responsible for compliance could void the user's authority to operate the equipment.

This device complies with Part 15 of the FCC Rules. Operation is subject to the following two conditions: (1) this device may not cause harmful interference, and (2) this device must accept any interference received, including interference that may cause undesired operation.

This equipment has been tested and found to comply with the limits for a Class B digital device, pursuant to Part 15 of the FCC Rules. These limits are designed to provide reasonable protection against harmful interference in a residential installation. This equipment generates, uses and can radiate radio frequency energy and, if not installed and used in accordance with the instructions, may cause harmful interference to radio communications. However, there is no guarantee that interference will not occur in a particular installation.

If this equipment does cause harmful interference to radio or television reception, which can be determined by turning the equipment off and on, the user is encouraged to try to correct the interference by one or more of the following measures:

- Reorient or relocate the receiving antenna.
- Increase the separation between the equipment and receiver.
- Connect the equipment into an outlet on a circuit different from that to which the receiver is connected.
- Consult the dealer or an experienced radio/TV technician for help.

### FCC Radiation Exposure Statement

#### Remote control:

The device has been evaluated to meet general RF exposure requirement.

The device can be used in the portable exposure condition without restriction.

#### Drone:

The equipment complies with FCC Radiation exposure limits set forth for uncontrolled environment. This equipment should be installed and operated with minimum distance 20cm between the radiator and your body.



©2023 CSI  
Edison, NJ 08817  
Tech Support  
800.592.9541