

SMD CERAMIC ANTENNA

Data Sheet

CA-2450-31

For 2400-2484MHz
3.2x1.6mm [EIA1206]

■ FEATURES

- Light weight,compact
- Wide bandwidth,lowcost
- Built-in antenna with high gain

■ APPLICATIONS

- Bluetooth
- IEEE802.11g/b
- Zigbee systems,etc...

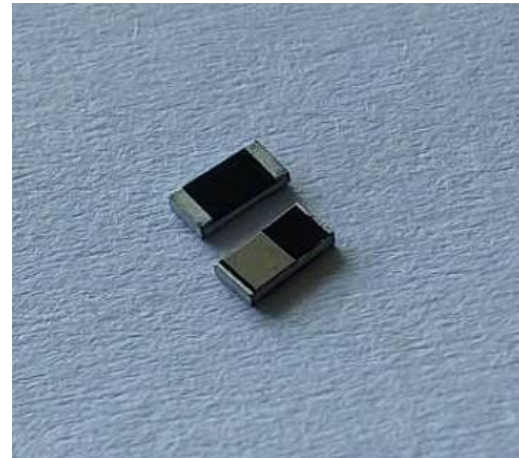

■ SHAPES AND DIMENSIONS Dimensions in mm

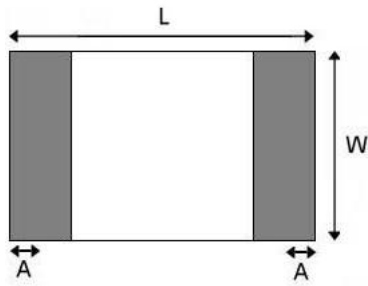

L	W	A	H
3.10±0.10	1.55±0.10	0.40±0.20	0.50±0.10



ELECTRIC SPECIFICATIONS

Product type	CA-2450-31
Center Frequency Range	2450MHZ
Input Impedance	50 Ω

PART NUMBERING SYSTEM

CA - **2450** - **31** - **A**
 Material Frequency Size Type

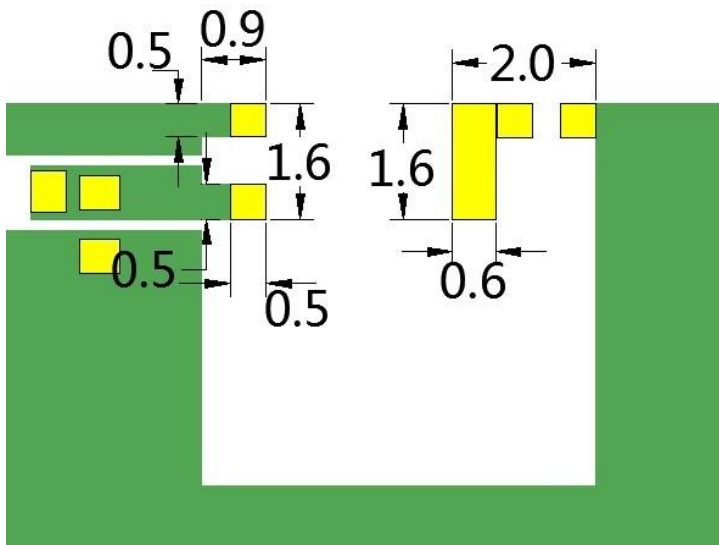

EVALUATION BOARD

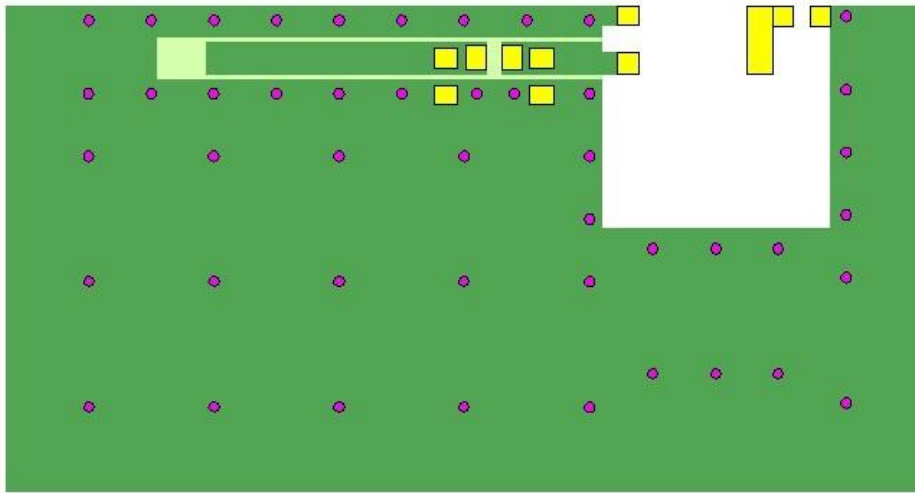

- 天线
- PAD
- 底层铺铜
- 顶层铺铜
- 打孔

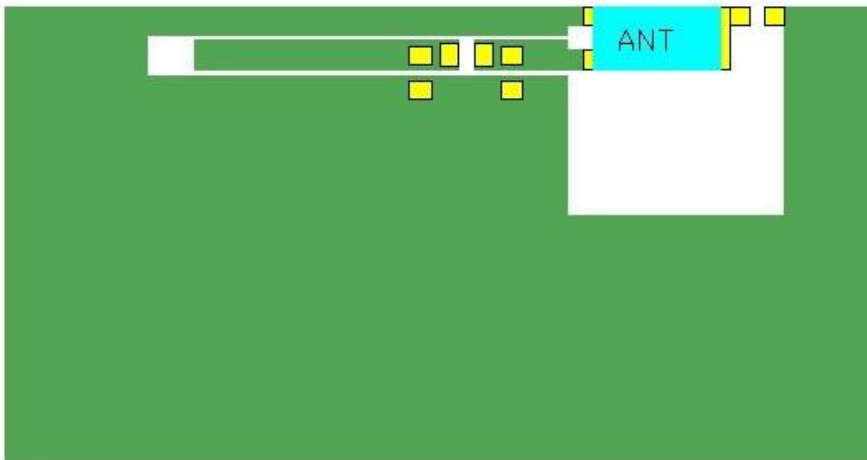

- 天线
- PAD
- 底层铺铜
- 顶层铺铜

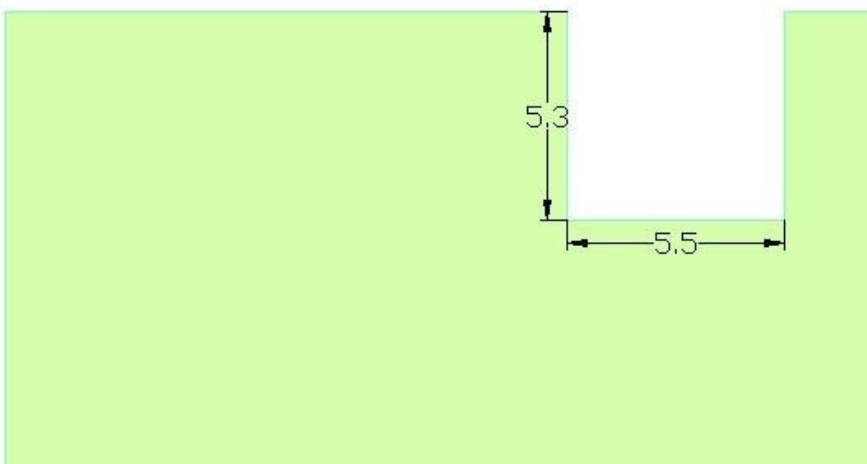

■ RADIATION PATTERNS

□ 2.4GHz WLAN BAND

◎ 3D Gain Pattern (2400 MHz)

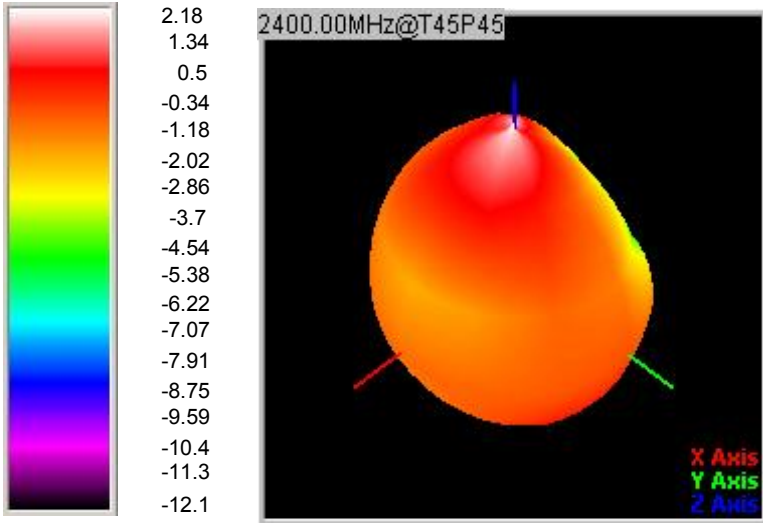

◎ 3D Gain Pattern (2440 MHz)

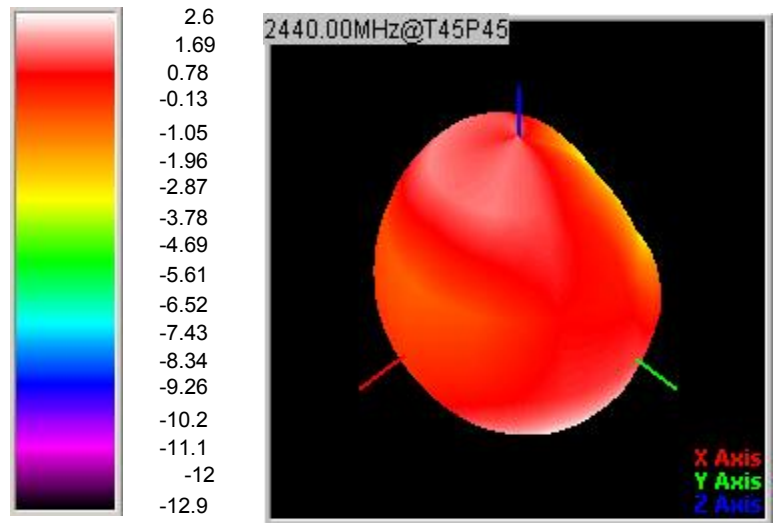

◎ 3D Gain Pattern (2480 MHz)

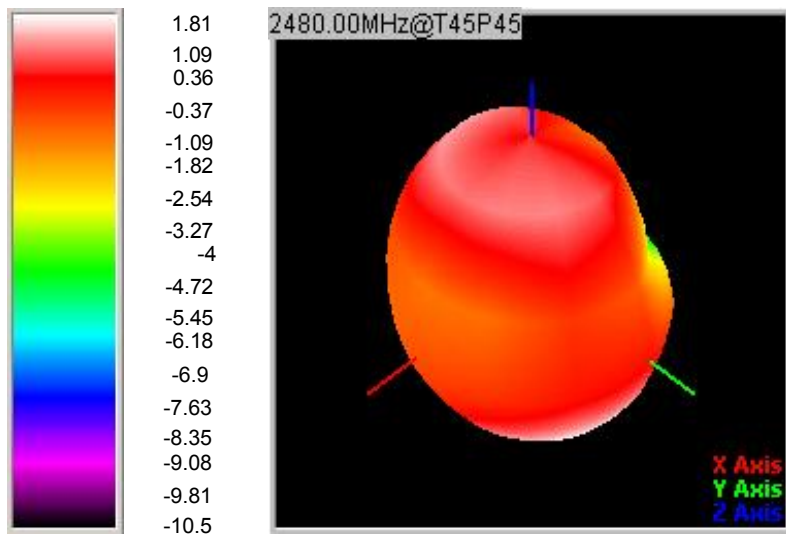

FREQUENCY CHARACTERISTICS

EFFICIENCY AND VSWR

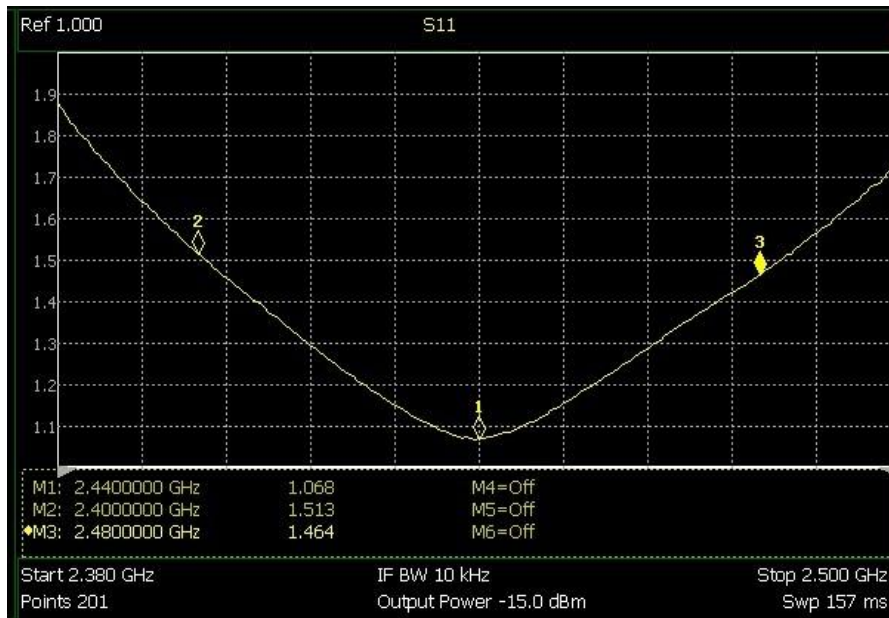
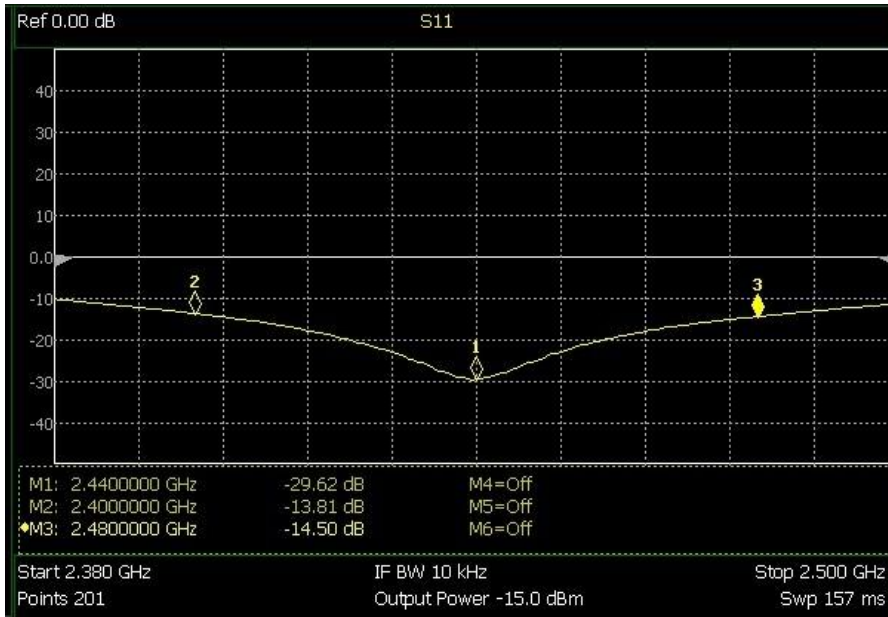

■ RECOMMENDED REFLOW PROFILE

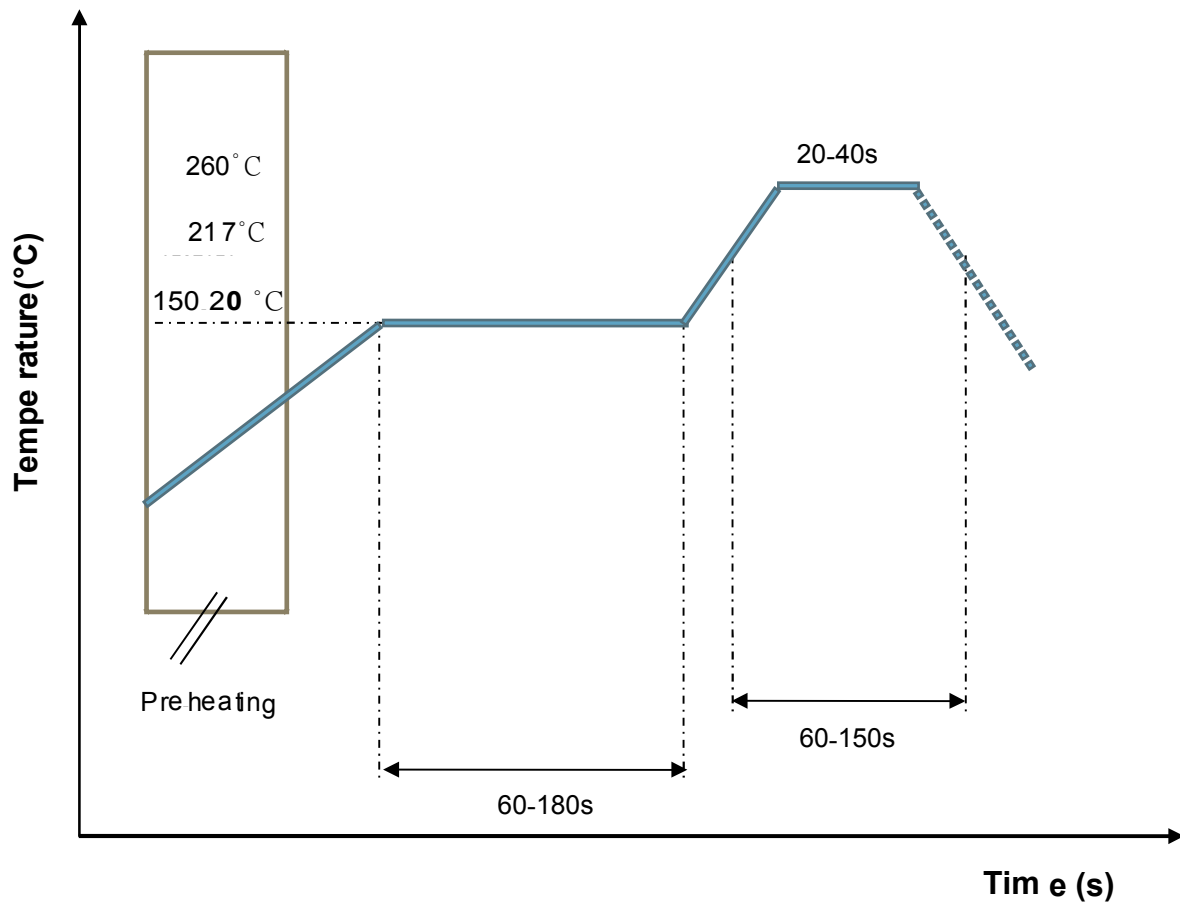

■ PACKAGING STYLE

□ REEL DIMENSIONS

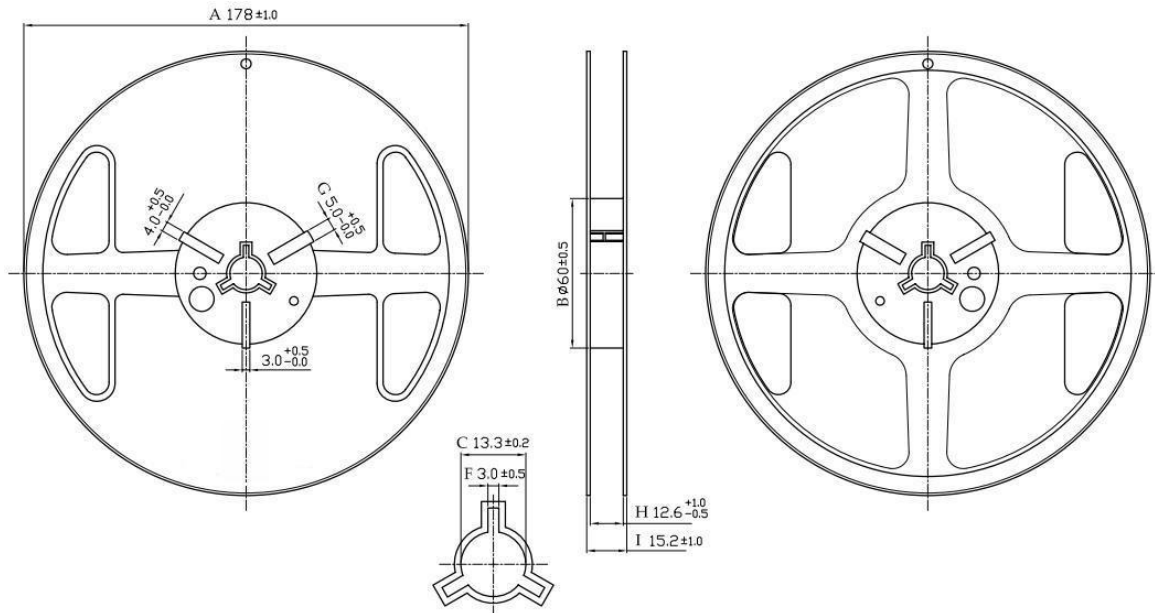

□ TAPE DIMENSIONS

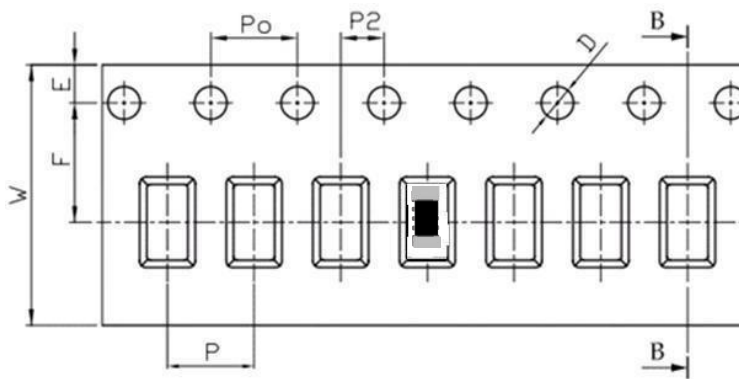

Feature	Specifications	Tolerances
W	8.00	±0.30
P	4.00	±0.10
E	1.75	±0.10
F	3.50	±0.10
P ₂	2.00	±0.10
D	1.50	+0.10 -0.00
P ₀	4.00	±0.10
10P ₀	40.00	±0.20

Typing Quantity: 5000 pieces per 7" reel