

### Application:

WLAN, 802.11b/g, Bluetooth, WLAN, etc...

### Features

SMD, high reliability, ultra Impact, Omni-directional.

### Part number Information

RANT 2012 F 245 C 07  
 (A) (B) (C) (D) (E) (F)



(A)Product Type	Chip Antenna
(B) Size Code	2.0x1.2mm(+0.2mm)
(C) Material	High K material
(D) Frequency	2.4 ~ 2.5GHz
(E) Feeding mode	PIFA & Single Feeding
(F) Antenna type	Type=07

### Electrical Specification

Working Frequency Range	2400 ~2484 MHz
Bandwidth	84 (Min.)
Peak Gain	1.7 dBi (Typ.)
Impedance	50 Ohm
Return loss	10 dB ( Min)
Polarization	Linear
Azimuth Beamwidth	Omni-directional
Operation Temperature(°C)	-40 ~85°C
Resistance to Soldering Heats	10sec. ( @ 280°C)
Termination	Ni / Au (Leadless)

The specification is defined on EVB.

### Dimension and Terminal Configuration

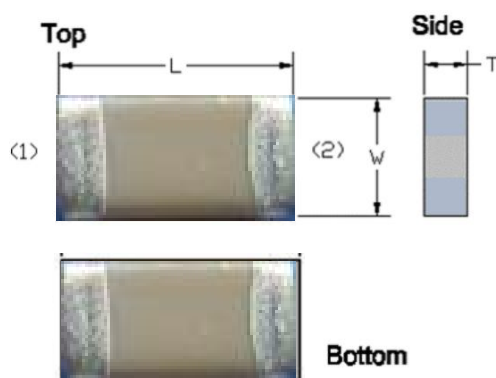

Dimension (mm)	
L	2.05+0.10
W	1.20+0.10
T	0.65+0.10

No.	Terminal Name
1	Feeding/GNG
2	GND

咏成國際科技有限公司

電話: 13530576606

RAIN International Technology Co., Ltd.



**2.4GHz 2012 Chip Antenna: RANT2012F245C07**

## Evaluation Board Reference

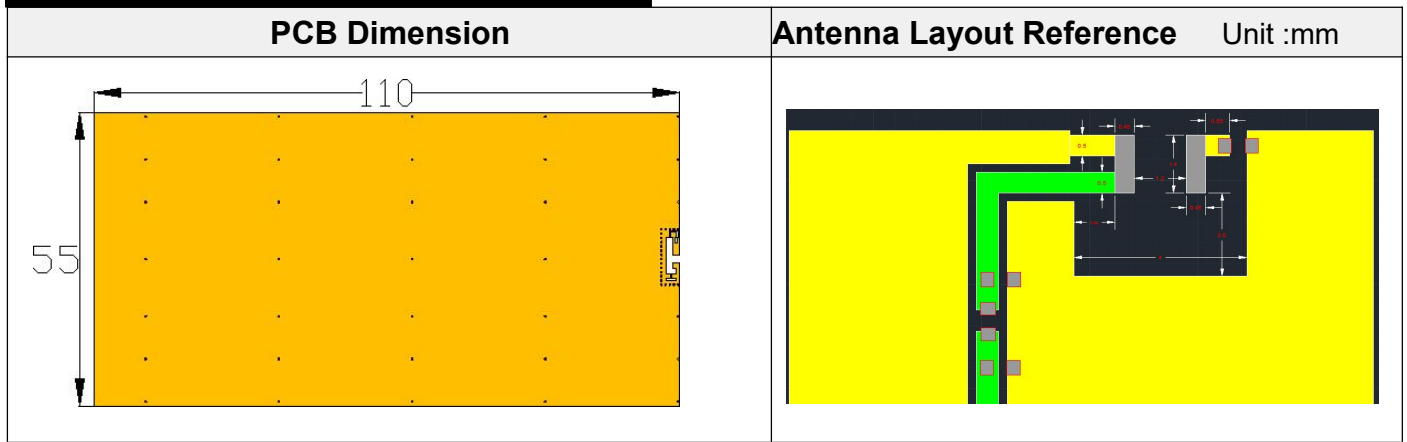

## Electrical Characteristics

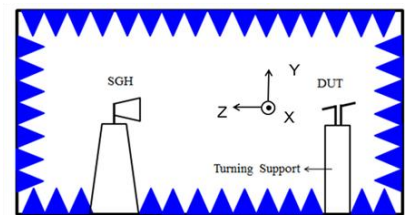
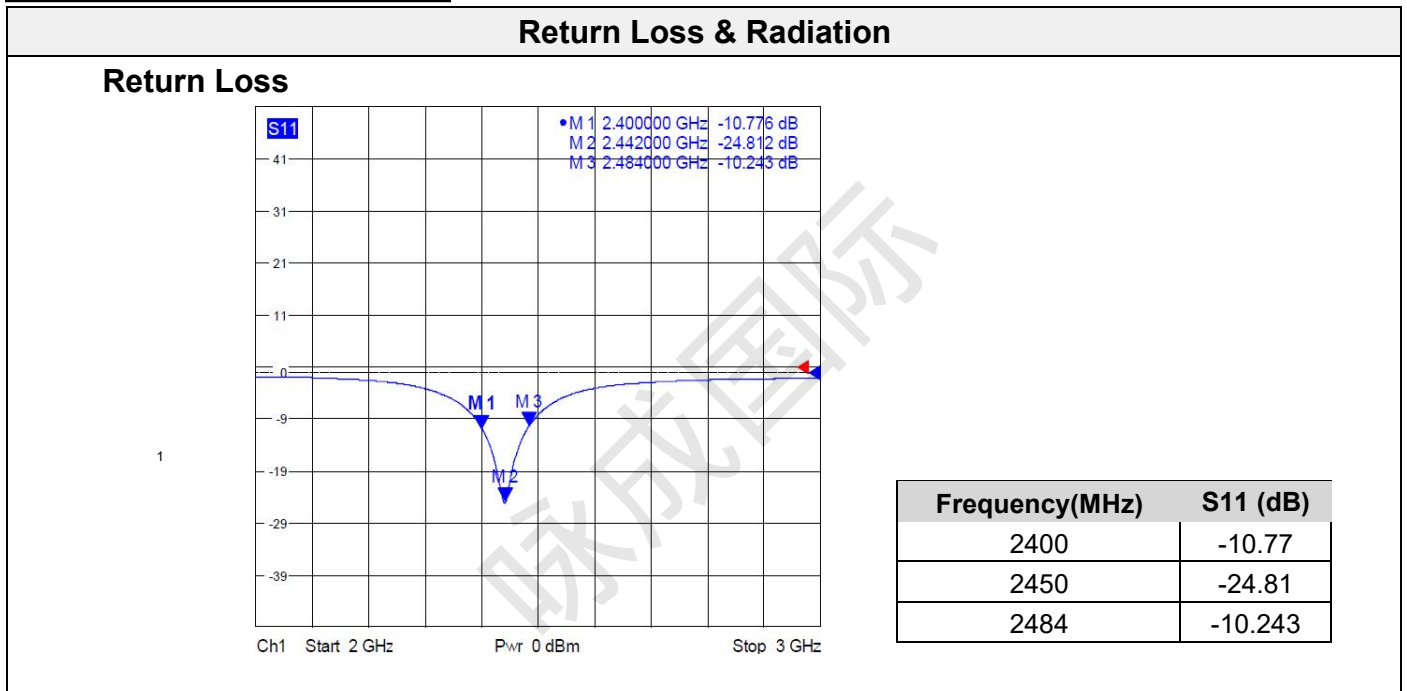

# Taping Specifications

## Reel and Taping Specification

### Reel Specification

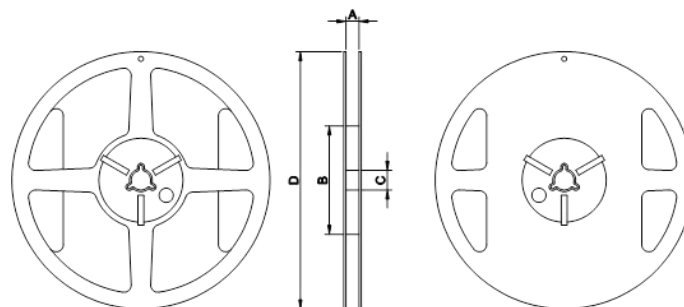

7" x 8 mm

TYPE	SIZE		A	B	C	D
2012	7"	5K/Reel	9.0±0.5	60±2	13.5±0.5	178±2

### Taping Specification

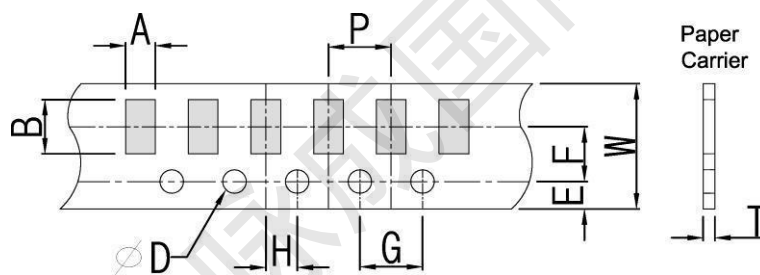

Packaging	Type	A	B	W	E	F	G	H	T	D	P
Paper Type	2012	1.50±0.20	2.30±0.20	8.0±0.20	1.75±0.10	3.5±0.05	4.0±0.10	2.0±0.05	0.75±0.10	1.57±0.10	4.0±0.1

## Reliability Table

Test Item	Procedure	Requirements Ceramic Type	Remark (Reference)
<b>Electrical Characterization</b>		Fulfill the electrical specification	User Spec.
<b>Thermal Shock</b>	1. Preconditioning: $50 \pm 10^{\circ}\text{C}$ / 1 hr , then keep for $24 \pm 1$ hrs at room temp. 2. Initial measure: Spec: refer Initial spec. 3. Rapid change of temperature test: $-30^{\circ}\text{C}$ to $+85^{\circ}\text{C}$ ; 100 cycles; 15 minutes at Lower category temperature; 15 minutes at Upper category temperature.	No Visible Damage. Fulfill the electrical specification.	MIL-STD-202 107
<b>Temperature Cycling</b>	1. Initial measure: Spec: refer Initial spec. 2. 100 Cycles ( $-30^{\circ}\text{C}$ to $+85^{\circ}\text{C}$ ), Soak Mode=1(2 Cycle/hours). 3. Measurement at $24 \pm 2$ Hours after test condition.	No Visible Damage. Fulfill the electrical specification.	JESD22 JA104
<b>High Temperature Exposure</b>	1. Initial measure: Spec: refer Initial spec. 2. Unpowered; 500hours @ $T=+85^{\circ}\text{C}$ . 3. Measurement at $24 \pm 2$ hours after test.	No Visible Damage. Fulfill the electrical specification.	MIL-STD-202 108
<b>Low Temperature Storage</b>	1. Initial measure: Spec: refer Initial spec. 2. Unpowered: 500hours @ $T=-30^{\circ}\text{C}$ . 3. Measurement at $24 \pm 2$ hours after test.	No Visible Damage. Fulfill the electrical specification.	MIL-STD-202 108
<b>Solderability (SMD Bottom Side)</b>	Dipping method: a. Temperature: $235 \pm 5^{\circ}\text{C}$ b. Dipping time: $3 \pm 0.5\text{s}$	The solder should cover over 95% of the critical area of bottom side.	IEC 60384-21/22 4.10
<b>Soldering Heat Resistance (RSH)</b>	Preheating temperature: $150 \pm 10^{\circ}\text{C}$ . Preheating time: 1~2 min. Solder temperature: $260 \pm 5^{\circ}\text{C}$ . Dipping time: $5 \pm 0.5\text{s}$	No Visible Damage.	IEC 60384-21/22 4.10
<b>Vibration</b>	5g's for 20 min., 12 cycles each of 3 orientations Note: Use 8"X5" PCB .031" thick 7 secure points on, one long side and 2 secure points at corners of opposite sides. Parts mounted within 2" from any secure point. Test from 10-2000 Hz.	No Visible Damage.	MIL-STD-202 Method 204
<b>Mechanical Shock</b>	Three shocks in each direction shall be applied along the three mutually perpendicular axes of the test specimen (18 shocks) Peak value: 1,500g's Duration: 0.5ms Velocity change: 15.4 ft/s Waveform: Half-sine	No Visible Damage.	MIL-STD-202 Method 213
<b>Humidity Bias</b>	1. Humidity: 85% R.H., Temperature: $85 \pm 2^{\circ}\text{C}$ . 2. Time: $500 \pm 24$ hours. 3. Measurement at $24 \pm 2$ hrs after testcondition.	No Visible Damage. Fulfill the electrical specification.	MIL-STD-202 Method 106

## 2.4GHz 2012 Chip Antenna: RANT2012F245C07

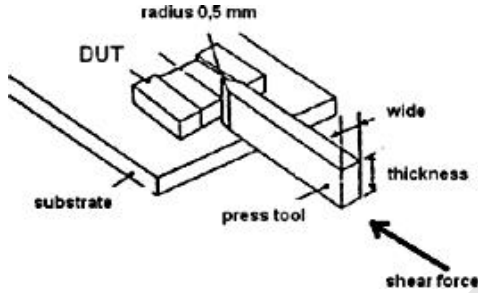
<b>Board Flex (SMD)</b>	<p>1. Mounting method: IR-Reflow. PCB Size (L:100 × W:40 × T:1.6mm)</p> <p>2. Apply the load in direction of the arrow until bending reaches 2 mm.</p>	<p>No Visible Damage.</p>	<p>AEC-Q200 005</p>
<b>Adhesion</b>	<p>Force of 1.8Kg for 60 seconds.</p> 	<p>No Visible Damage Magnification of 20X or greater may be employed for inspection of the mechanical integrity of the device body terminals and body/terminal junction.</p>	<p>AEC-Q200 006</p>
<b>Physical Dimension</b>	<p>Any applicable method using x10 magnification, micrometers, calipers, gauges, contour projectors, or other measuring equipment, capable of determining the actual specimen dimensions.</p>	<p>In accordance with specification.</p>	<p>JESD22 JB100</p>

### Revision History

Revision	Date	Content
1	2020/10/15	New Datasheet