



**CFR 47 FCC PART 15 SUBPART C  
ISED RSS-247 ISSUE 2**

**CERTIFICATION TEST REPORT**

*For*

**IEEE 802.11b/g/n/a/ac 2T2R USB Wifi module Integrated BT 2.1+EDR/4.2/5.0**

**MODEL NUMBER: EL.MT7663BUN-WF**

**FCC ID: 2AWY6-ELMT7663BUN**

**IC: 26332-ELMT7663BUN**

**REPORT NUMBER: 4790147134.1-3**

**ISSUE DATE: November 08, 2021**

**Prepared for**

**EXPRESS LUCK INDUSTRIAL (SHENZHEN) LIMITED  
Floor1, Workshop1, NO.88, SOUTH BAOTONG ROAD, XIKENG  
COMMUNITY, YUANSAN STREET, LONGGANG DISTRICT, Shenzhen, China**

*Prepared by*

**UL Verification Services (Guangzhou) Co., Ltd, Song Shan Lake Branch**

**Building 10, Innovation Technology Park, No. 1, Li Bin Road, Song Shan Lake Hi-Tech Development Zone Dongguan, 523808, People's Republic of China**

**Tel: +86 769 22038881**

**Fax: +86 769 33244054**

**Website: [www.ul.com](http://www.ul.com)**



Revision History

<u>Rev.</u>	<u>Issue Date</u>	<u>Revisions</u>	<u>Revised By</u>
V0	11/08/2021	Initial Issue	



Summary of Test Results			
Clause	Test Items	FCC/ISED Rules	Test Results
1	6dB Bandwidth and 99% Occupied Bandwidth	FCC Part 15.247 (a) (2) RSS-247 Clause 5.2 (a) ISED RSS-Gen Clause 6.7	Pass
2	Conducted Output Power	FCC Part 15.247 (b) (3) RSS-247 Clause 5.4 (d)	Pass
3	Power Spectral Density	FCC Part 15.247 (e) RSS-247 Clause 5.2 (b)	Pass
4	Conducted Bandedge and Spurious Emission	FCC Part 15.247 (d) RSS-247 Clause 5.5	Pass
5	Radiated Bandedge and Spurious Emission	FCC Part 15.247 (d) FCC Part 15.209 FCC Part 15.205 RSS-247 Clause 5.5 RSS-GEN Clause 8.9	Pass
6	Conducted Emission Test for AC Power Port	FCC Part 15.207 RSS-GEN Clause 8.8	Pass
7	Antenna Requirement	FCC Part 15.203 RSS-GEN Clause 6.8	Pass
<b>Note:</b> 1. This test report is only published to and used by the applicant, and it is not for evidence purpose in China. 2. The measurement result for the sample received is <Pass> according to < CFR 47 FCC PART 15 SUBPART C >< ISED RSS-247 > when <Accuracy Method> decision rule is applied.			



## TABLE OF CONTENTS

<b>1. ATTESTATION OF TEST RESULTS .....</b>	<b>6</b>
<b>2. TEST METHODOLOGY .....</b>	<b>7</b>
<b>3. FACILITIES AND ACCREDITATION .....</b>	<b>7</b>
<b>4. CALIBRATION AND UNCERTAINTY .....</b>	<b>8</b>
4.1. <i>MEASURING INSTRUMENT CALIBRATION .....</i>	<i>8</i>
4.2. <i>MEASUREMENT UNCERTAINTY .....</i>	<i>8</i>
<b>5. EQUIPMENT UNDER TEST .....</b>	<b>9</b>
5.1. <i>DESCRIPTION OF EUT .....</i>	<i>9</i>
5.2. <i>CHANNEL LIST .....</i>	<i>9</i>
5.3. <i>MAXIMUM OUTPUT POWER.....</i>	<i>9</i>
5.4. <i>TEST CHANNEL CONFIGURATION.....</i>	<i>10</i>
5.5. <i>THE WORSE CASE POWER SETTING PARAMETER.....</i>	<i>10</i>
5.6. <i>THE WORSE CASE CONFIGURATIONS .....</i>	<i>11</i>
5.7. <i>DESCRIPTION OF AVAILABLE ANTENNAS .....</i>	<i>12</i>
5.8. <i>DESCRIPTION OF TEST SETUP.....</i>	<i>13</i>
<b>6. MEASURING INSTRUMENT AND SOFTWARE USED .....</b>	<b>14</b>
<b>7. ANTENNA PORT TEST RESULTS .....</b>	<b>16</b>
7.1. <i>ON TIME AND DUTY CYCLE.....</i>	<i>16</i>
7.2. <i>6 dB DTS BANDWIDTH AND 99 % OCCUPIED BANDWIDTH .....</i>	<i>17</i>
7.3. <i>CONDUCTED OUTPUT POWER.....</i>	<i>19</i>
7.4. <i>POWER SPECTRAL DENSITY .....</i>	<i>20</i>
7.5. <i>CONDUCTED BANDEDGE AND SPURIOUS EMISSIONS.....</i>	<i>22</i>
<b>8. RADIATED TEST RESULTS.....</b>	<b>24</b>
8.1. <i>RESTRICTED BANDEDGE .....</i>	<i>30</i>
8.1.1. <i>802.11b SISO MODE.....</i>	<i>30</i>
8.1.2. <i>802.11g SISO MODE.....</i>	<i>32</i>
8.1.3. <i>802.11n HT20 MIMO MODE.....</i>	<i>35</i>
8.1.4. <i>802.11n HT40 MIMO MODE.....</i>	<i>39</i>
8.2. <i>SPURIOUS EMISSIONS (1 GHz ~ 3 GHz).....</i>	<i>43</i>
8.2.1. <i>802.11b SISO MODE.....</i>	<i>43</i>
8.3. <i>SPURIOUS EMISSIONS (3 GHz ~ 18 GHz).....</i>	<i>49</i>
8.3.1. <i>802.11b SISO MODE.....</i>	<i>49</i>
8.3.2. <i>802.11g SISO MODE.....</i>	<i>55</i>
8.3.3. <i>802.11n HT20 MIMO MODE.....</i>	<i>61</i>
8.3.4. <i>802.11n HT40 MIMO MODE.....</i>	<i>67</i>



8.5.	SPURIOUS EMISSIONS (18 GHz ~ 26 GHz)	73
8.5.1.	802.11n HT20 MIMO MODE	73
8.6.	SPURIOUS EMISSIONS (30 MHz ~ 1 GHz)	75
8.6.1.	802.11n HT20 MIMO MODE	75
8.7.	SPURIOUS EMISSIONS BELOW 30 MHz	77
8.7.1.	802.11n HT20 MIMO MODE	77
<b>9.</b>	<b>AC POWER LINE CONDUCTED EMISSIONS</b>	<b>80</b>
9.1.1.	802.11n HT20 MIMO MODE	81
<b>10.</b>	<b>ANTENNA REQUIREMENTS</b>	<b>83</b>
<b>11.</b>	<b>Appendix</b>	<b>84</b>
11.1.	Appendix A: DTS Bandwidth	84
11.1.1.	Test Result	84
11.1.2.	Test Graphs	85
11.2.	Appendix B: Occupied Channel Bandwidth	93
11.2.1.	Test Result	93
11.2.2.	Test Graphs	94
11.3.	Appendix C: Maximum conducted output power	102
11.3.1.	Test Result	102
11.4.	Appendix D: Maximum power spectral density	103
11.4.1.	Test Result	103
11.4.2.	Test Graphs	104
11.5.	Appendix E: Band edge measurements	112
11.5.1.	Test Result	112
11.5.2.	Test Graphs	113
11.6.	Appendix F: Conducted Spurious Emission	119
11.6.1.	Test Result	119
11.6.2.	Test Graphs	121
11.7.	Appendix G: Duty Cycle	145
11.7.1.	Test Result	145
11.7.2.	Test Graphs	146



# 1. ATTESTATION OF TEST RESULTS

## Applicant Information

Company Name: EXPRESS LUCK INDUSTRIAL (SHENZHEN) LIMITED  
 Address: Floor1, Workshop1, NO.88, SOUTH BAOTONG ROAD, XIKENG COMMUNITY, YUANSHAN STREET, LONGGANG DISTRICT, Shenzhen, China

## Manufacturer Information

Company Name: EXPRESS LUCK INDUSTRIAL (SHENZHEN) LIMITED  
 Address: Floor1, Workshop1, NO.88, SOUTH BAOTONG ROAD, XIKENG COMMUNITY, YUANSHAN STREET, LONGGANG DISTRICT, Shenzhen, China

## EUT Information

EUT Name: IEEE 802.11b/g/n/a/ac 2T2R USB Wifi module Integrated BT 2.1+EDR/4.2/5.0  
 Model: EL.MT7663BUN-WF  
 Sample Received Date: October 18, 2021  
 Sample Status: Normal  
 Sample ID: 4295515  
 Date of Tested: October 18, 2021~ October 30, 2021

APPLICABLE STANDARDS	
STANDARD	TEST RESULTS
CFR 47 FCC PART 15 SUBPART C	PASS
ISED RSS-247 Issue 2	PASS
ISED RSS-GEN Issue 5	PASS

Prepared By:

Kebo Zhang  
Project Engineer

Checked By:

Shawn Wen  
Laboratory Leader

Approved By:

Stephen Guo  
Laboratory Manager



## 2. TEST METHODOLOGY

The tests documented in this report were performed in accordance with KDB 558074 D01 15.247 Meas Guidance v05r02, KDB 414788 D01 Radiated Test Site v01r01, KDB 662911 D01 Multiple Transmitter Output v02r01, CFR 47 FCC Part 2, CFR 47 FCC Part 15, ANSI C63.10-2013, ISED RSS-247 Issue 2 and ISED RSS-GEN Issue 5.

## 3. FACILITIES AND ACCREDITATION

Accreditation Certificate	<p><b>A2LA (Certificate No.: 4102.01)</b> UL Verification Services (Guangzhou) Co., Ltd. Song Shan Lake Branch. has been assessed and proved to be in compliance with A2LA.</p> <p><b>FCC (FCC Designation No.: CN1187)</b> UL Verification Services (Guangzhou) Co., Ltd. Song Shan Lake Branch. Has been recognized to perform compliance testing on equipment subject to the Commission's Declaration of Conformity (DoC) and Certification rules</p> <p><b>ISED (Company No.: 21320)</b> UL Verification Services (Guangzhou) Co., Ltd. Song Shan Lake Branch. has been registered and fully described in a report filed with ISED. The Company Number is 21320 and the test lab Conformity Assessment Body Identifier (CABID) is CN0046.</p> <p><b>VCCI (Registration No.: G-20019, R-20004, C-20012 and T-20011)</b> UL Verification Services (Guangzhou) Co., Ltd. Song Shan Lake Branch. has been assessed and proved to be in compliance with VCCI, the Membership No. is 3793. Facility Name: Chamber D, the VCCI registration No. is G-20019 and R-20004 Shielding Room B, the VCCI registration No. is C-20012 and T-20011</p>
---------------------------	--

Note 1: All tests measurement facilities use to collect the measurement data are located at Building 10, Innovation Technology Park, Song Shan Lake Hi tech Development Zone, Dongguan, 523808, China

Note 2: The test anechoic chamber in UL Verification Services (Guangzhou) Co., Ltd. Song Shan Lake Branch had been calibrated and compared to the open field sites and the test anechoic chamber is shown to be equivalent to or worst case from the open field site.

Note 3: For below 30 MHz, lab had performed measurements at test anechoic chamber and comparing to measurements obtained on an open field site. And these measurements below 30 MHz had been correlated to measurements performed on an OFS.



## 4. CALIBRATION AND UNCERTAINTY

### 4.1. MEASURING INSTRUMENT CALIBRATION

The measuring equipment utilized to perform the tests documented in this report has been calibrated in accordance with the manufacturer's recommendations and is traceable to recognize national standards.

### 4.2. MEASUREMENT UNCERTAINTY

Where relevant, the following measurement uncertainty levels have been estimated for tests performed on the apparatus:

Test Item	Uncertainty
Conduction emission	3.62 dB
Radiated Emission (Included Fundamental Emission) (9 kHz ~ 30 MHz)	2.2 dB
Radiated Emission (Included Fundamental Emission) (30 MHz ~ 1 GHz)	4.00 dB
Radiated Emission (Included Fundamental Emission) (1 GHz to 26 GHz)	5.78 dB (1 GHz ~ 18 GHz)
	5.23 dB (18 GHz ~ 26 GHz)
Duty Cycle	±0.028%
DTS and 99% Occupied Bandwidth	±0.0196%
Maximum Conducted Output Power	±0.686 dB
Maximum Power Spectral Density Level	±0.743 dB
Conducted Band-edge Compliance	±1.328 dB
Conducted Unwanted Emissions In Non-restricted Frequency Bands	±0.746 dB (9 kHz ~ 1 GHz)
	±1.328dB (1 GHz ~ 26 GHz)
Note: This uncertainty represents an expanded uncertainty expressed at approximately the 95% confidence level using a coverage factor of k=2.	





## 5. EQUIPMENT UNDER TEST

### 5.1. DESCRIPTION OF EUT

EUT Name	IEEE 802.11b/g/n/a/ac 2T2R USB Wifi module Integrated BT 2.1+EDR/4.2/5.0
Model Name	EL.MT7663BUN-WF
Radio Technology	IEEE802.11b/g/n HT20/n HT40
Operation frequency	IEEE 802.11b: 2412MHz—2462MHz IEEE 802.11g: 2412MHz—2462MHz IEEE 802.11n HT20: 2412MHz—2462MHz IEEE 802.11n HT40: 2422MHz—2452MHz
Modulation	IEEE 802.11b: DSSS(CCK) IEEE 802.11g: OFDM(64QAM, 16QAM, QPSK, BPSK) IEEE 802.11n HT20: OFDM (64QAM, 16QAM, QPSK,BPSK) IEEE 802.11n HT40: OFDM (64QAM, 16QAM, QPSK,BPSK)
Power Supply	DC 3.3 V

### 5.2. CHANNEL LIST

Channel List for 802.11b/g/n (20 MHz)							
Channel	Frequency (MHz)	Channel	Frequency (MHz)	Channel	Frequency (MHz)	Channel	Frequency (MHz)
1	2412	4	2427	7	2442	10	2457
2	2417	5	2432	8	2447	11	2462
3	2422	6	2437	9	2452	/	/

Channel List for 802.11n (40 MHz)							
Channel	Frequency (MHz)	Channel	Frequency (MHz)	Channel	Frequency (MHz)	Channel	Frequency (MHz)
3	2422	5	2432	7	2442	9	2452
4	2427	6	2437	8	2447	/	/

### 5.3. MAXIMUM OUTPUT POWER

IEEE Std. 802.11	Frequency (MHz)	Channel Number	Maximum Conducted AVG Output Power (dBm)	Maximum AVG EIRP (dBm)
b	2412 ~ 2462	1-11[11]	15.42	18.06
g	2412 ~ 2462	1-11[11]	14.95	17.59
n HT20 MIMO	2412 ~ 2462	1-11[11]	18.00	20.64
n HT40 MIMO	2422 ~ 2452	3-9[7]	17.60	20.24

**5.4. TEST CHANNEL CONFIGURATION**

IEEE Std. 802.11	Test Channel Number	Frequency
b	CH 1(Low Channel), CH 6(MID Channel), CH 11(High Channel)	2412 MHz, 2437 MHz, 2462 MHz
g	CH 1(Low Channel), CH 6(MID Channel), CH 11(High Channel)	2412 MHz, 2437 MHz, 2462 MHz
n HT20	CH 1(Low Channel), CH 6(MID Channel), CH 11(High Channel)	2412 MHz, 2437 MHz, 2462 MHz
n HT40	CH 3(Low Channel), CH 6(MID Channel), CH 9(High Channel)	2422 MHz, 2437 MHz, 2452 MHz

**5.5. THE WORSE CASE POWER SETTING PARAMETER**

The Worst Case Power Setting Parameter under 2400 ~ 2483.5MHz Band							
Test Software		QA Tool					
Modulation Mode	Transmit Antenna Number	Test Channel					
		NCB: 20MHz			NCB: 40MHz		
		CH 1	CH 6	CH 11	CH 3	CH 6	CH 9
802.11b	1	22	20	1F	/		
	2	22	20	1F			
802.11g	1	22	22	22			
	2	22	22	22			
802.11n HT20	1	24	24	24			
	2	24	24	24			
802.11n HT40	1	/			22	22	22
	2	/			22	22	22



## 5.6. THE WORSE CASE CONFIGURATIONS

The EUT was tested in the following configuration(s):

Controlled in test mode using a software application on the EUT supplied by customer. The application was used to enable a continuous transmission and to select the mode, test channels, bandwidth, data rates as required.

Test channels referring to section 5.4.

Maximum power setting referring to section 5.5.

Worst-case data rates as provided by the client were:

802.11b mode: 1 Mbps

802.11g mode: 6 Mbps

802.11n HT20 mode: MCS0

802.11n HT40 mode: MCS0

802.11b/g only support SISO mode.

802.11 n HT20/HT40 support SISO and MIMO mode.

802.11a SISO mode, Antenna 1 and Antenna 2 has the same power setting, so only Antenna 1 worst case test data were recorded in the report.

802.11n SISO mode and MIMO mode have the same power setting, so only the worst case power mode(MIMO) will be record in the report.

The EUT has 2 separate antennas which correspond to 2 separate antenna ports. Core 0 and Core 1 correspond to antenna 1 and antenna 2 respectively.

The measured additional path loss was included in any path loss calculations for all RF cable used during tested.

Conducted output power, power spectral density tests separately on each port with all supported SISO & MIMO port combinations.

The EUT support Cyclic Shift Diversity(CDD), Space Time Coding(STBC), Spatial Division Multiplexing(SDM) modes. They use the same conducted power per chain in any given mode, CDD mode have the maximum power setting, so we only chose the worst case mode CDD for final testing.

**5.7. DESCRIPTION OF AVAILABLE ANTENNAS**

Antenna	Frequency (MHz)	Antenna Type	MAX Antenna Gain (dBi)
1	2412-2462	PCB	2.64
2	2412-2462	PCB	2.64

The EUT support Cyclic Shift Diversity(CDD) mode.

MIMO output power port and MIMO PSD port summing was performed in accordance with KDB 662911 D01. For the CDD results the Directional Gain was calculated in accordance with the following method.

For output power measurements:

Directional gain=  $G_{ANT} + \text{Array Gain} = 2.64\text{dBi}$

$G_{ANT}$  : equal to the gain of the antenna having the highest gain

Array Gain = 0 dB (i.e., no array gain) for  $N_{ANT} \leq 4$

For power spectral density (PSD) measurements:

Directional gain=  $G_{ANT} + \text{Array Gain} = 5.64\text{ dBi}$

Array Gain =  $10 \log(N_{ANT}/N_{SS})\text{ dB}$ .

$N_{ANT}$  : number of transmit antennas

$N_{SS}$  : number of spatial streams, The worst case directional gain will occur when  $N_{SS} = 1$

Test Mode	Transmit and Receive Mode	Description
IEEE 802.11b	<input checked="" type="checkbox"/> 2TX, 2RX	ANT 1 and ANT 2 can be used as transmitting/receiving antenna.
IEEE 802.11g	<input checked="" type="checkbox"/> 2TX, 2RX	ANT 1 and ANT 2 can be used as transmitting/receiving antenna.
IEEE 802.11n HT20	<input checked="" type="checkbox"/> 2TX, 2RX	ANT 1 and ANT 2 can be used as transmitting/receiving antenna.
IEEE 802.11n HT40	<input checked="" type="checkbox"/> 2TX, 2RX	ANT 1 and ANT 2 can be used as transmitting/receiving antenna.

Note:

1. BT&WLAN 2.4G, BT & WLAN 5G can transmit simultaneously. (declared by client)
2. WLAN 2.4G & WLAN 5G can't transmit simultaneously. (declared by client)

Note: The value of the antenna gain was declared by customer.

## 5.8. DESCRIPTION OF TEST SETUP

### SUPPORT EQUIPMENT

Item	Equipment	Brand Name	Model Name	Remarks
1	Laptop	Lenovo	XIAOXIN 5000	/
2	UART	/	/	/
3	AC Adapter	Lenovo	ADLX65YCC3D	Input: 100-240 Vac, 50/60 Hz Output: 20 Vdc, 3.25A

### I/O CABLES

Cable No	Port	Connector Type	Cable Type	Cable Length(m)	Remarks
1	USB	N/A	N/A	1	N/A

### ACCESSORIES

Item	Accessory	Brand Name	Model Name	Description
/	/	/	/	/

### TEST SETUP

The EUT can work in engineering mode with a software through a Laptop.

### SETUP DIAGRAM FOR TESTS

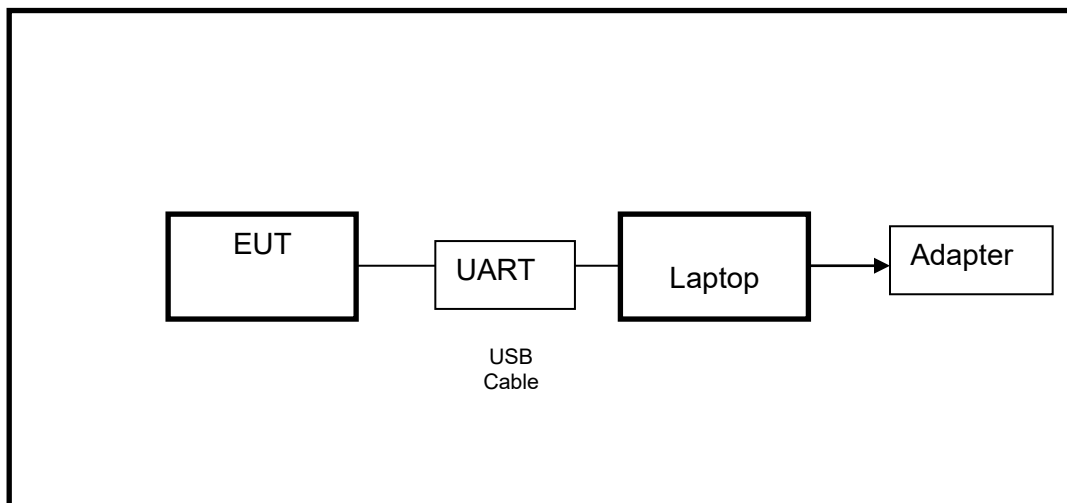

Note: AC adapter only use for AC POWER LINE CONDUCTED EMISSIONS testing.

**6. MEASURING INSTRUMENT AND SOFTWARE USED**

Conducted Emissions					
Equipment	Manufacturer	Model No.	Serial No.	Last Cal.	Due Date
EMI Test Receiver	R&S	ESR3	101961	Nov. 12, 2020	Nov. 11, 2021
Two-Line V-Network	R&S	ENV216	101983	Nov. 12, 2020	Nov. 11, 2021
Artificial Mains Networks	Schwarzbeck	NSLK 8126	8126465	Nov. 12, 2020	Nov. 11, 2021
Software					
Description			Manufacturer	Name	Version
Test Software for Conducted Emissions			Farad	EZ-EMC	Ver. UL-3A1

Radiated Emissions					
Equipment	Manufacturer	Model No.	Serial No.	Last Cal.	Due Date
MXE EMI Receiver	KESIGHT	N9038A	MY56400036	Nov. 12, 2020	Nov. 11, 2021
Hybrid Log Periodic Antenna	TDK	HLP-3003C	130959	April 24, 2020	April 23, 2023
Preamplifier	HP	8447D	2944A09099	Nov. 12, 2020	Nov. 11, 2021
EMI Measurement Receiver	R&S	ESR26	101377	Nov. 12, 2020	Nov. 11, 2021
Horn Antenna	TDK	HRN-0118	130940	Jul. 20, 2021	Jul. 19, 2024
Preamplifier	TDK	PA-02-0118	TRS-305-00067	Nov. 20, 2020	Nov. 19, 2021
Horn Antenna	Schwarzbeck	BBHA9170	#697	July 20, 2021	July 19, 2024
Preamplifier	TDK	PA-02-2	TRS-307-00003	Nov. 12, 2020	Nov. 11, 2021
Preamplifier	TDK	PA-02-3	TRS-308-00002	Nov. 12, 2020	Nov. 11, 2021
Loop antenna	Schwarzbeck	1519B	00008	Jan.17, 2019	Jan.17,2022
Preamplifier	TDK	PA-02-001-3000	TRS-302-00050	Nov. 12, 2020	Nov. 11, 2021
Preamplifier	Mini-Circuits	ZX60-83LN-S+	SUP01201941	Nov. 20, 2020	Nov. 19, 2021
High Pass Filter	Wi	WHKX10-2700-3000-18000-40SS	23	Nov. 12, 2020	Nov. 11, 2021
Band Reject Filter	Wainwright	WRCJV8-2350-2400-2483.5-2533.5-40SS	4	Nov. 12, 2020	Nov. 11, 2021
Software					



Description	Manufacturer	Name	Version
Test Software for Radiated Emissions	Farad	EZ-EMC	Ver. UL-3A1

R&S TS 8997 Test System					
Equipment	Manufacturer	Model No.	Serial No.	Last Cal.	Due. Date
Power sensor, Power Meter	R&S	OSP120	100921	Mar.23,2021	Mar.24,2022
Vector Signal Generator	R&S	SMBV100A	261637	Nov.20,2020	Nov.19,2021
Signal Generator	R&S	SMB100A	178553	Nov.20,2020	Nov.19,2021
Signal Analyzer	R&S	FSV40	101118	Nov.20,2020	Nov.19,2021
Software					
Description	Manufacturer	Name	Version		
For R&S TS 8997 Test System	Rohde & Schwarz	EMC 32	10.60.10		



## 7. ANTENNA PORT TEST RESULTS

### 7.1. ON TIME AND DUTY CYCLE

#### LIMITS

None; for reporting purposes only

#### PROCEDURE

Refer to ANSI C63.10-2013 clause 11.6 Zero – Span Spectrum Analyzer method.

#### TEST SETUP

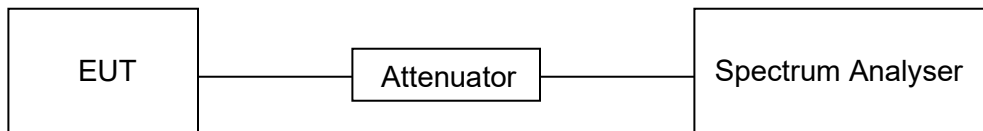

#### TEST ENVIRONMENT

Temperature	26.3 °C	Relative Humidity	55.1 %
Atmosphere Pressure	101 kPa	Test Voltage	DC 3.3 V

#### RESULTS

Please refer to appendix G.



## 7.2. 6 dB DTS BANDWIDTH AND 99 % OCCUPIED BANDWIDTH

### LIMITS

CFR 47 FCC Part15 (15.247) Subpart C ISED RSS-247 ISSUE 2			
Section	Test Item	Limit	Frequency Range (MHz)
CFR 47 FCC 15.247(a)(2) ISED RSS-247 5.2 (a)	6 dB Bandwidth	≥ 500 kHz	2400-2483.5
ISED RSS-Gen Clause 6.7	99 % Occupied Bandwidth	For reporting purposes only.	2400-2483.5

### TEST PROCEDURE

Connect the EUT to the spectrum analyser and use the following settings:

Center Frequency	The center frequency of the channel under test
Frequency Span	Between 1.5 times and 5.0 times the OBW
Detector	Peak
RBW	For 6 dB Bandwidth: 100 kHz For 99 % Occupied Bandwidth: 1 % to 5 % of the occupied bandwidth
VBW	For 6 dB Bandwidth: ≥3 × RBW For 99 % Occupied Bandwidth: ≥3 × RBW
Trace	Max hold
Sweep	Auto couple

a) Use the 99 % power bandwidth function of the instrument, allow the trace to stabilize and report the measured bandwidth.

b) Allow the trace to stabilize and measure the maximum width of the emission that is constrained by the frequencies associated with the two outermost amplitude points (upper and lower frequencies) that are attenuated by 6 dB relative to the maximum level measured in the fundamental emission.

### TEST SETUP

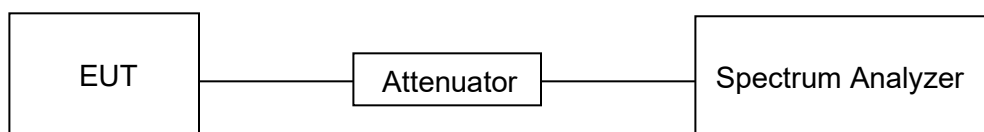

**TEST ENVIRONMENT**

Temperature	26.3 °C	Relative Humidity	55.1 %
Atmosphere Pressure	101 kPa	Test Voltage	DC 3.3 V

**RESULTS**

Please refer to appendix A & B.

### 7.3. CONDUCTED OUTPUT POWER

#### LIMITS

CFR 47 FCC Part15 (15.247) Subpart C ISED RSS-247 ISSUE 2			
Section	Test Item	Limit	Frequency Range (MHz)
CFR 47 FCC 15.247(b)(3) ISED RSS-247 5.4 (d)	AVG Output Power	1 watt or 30 dBm	2400-2483.5

#### TEST PROCEDURE

Connect the EUT to a low loss RF cable from the antenna port to the power sensor (video bandwidth is greater than the occupied bandwidth).  
Measure peak emission level, the indicated level is the average output power, after any corrections for external attenuators and cables.

#### TEST SETUP

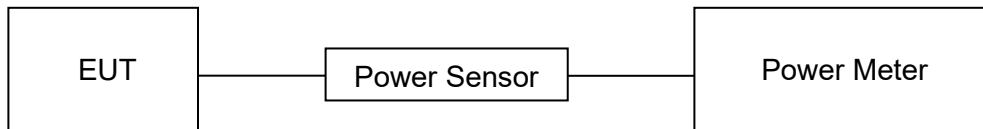

#### TEST ENVIRONMENT

Temperature	26.3 °C	Relative Humidity	55.1 %
Atmosphere Pressure	101 kPa	Test Voltage	DC 3.3 V

#### RESULTS

Please refer to appendix C.

## 7.4. POWER SPECTRAL DENSITY

### LIMITS

CFR 47 FCC Part15 (15.247) Subpart C ISED RSS-247 ISSUE 2			
Section	Test Item	Limit	Frequency Range (MHz)
CFR 47 FCC §15.247 (e) ISED RSS-247 5.2 (b)	Power Spectral Density	8 dBm/3 kHz	2400-2483.5

### TEST PROCEDURE

Refer to ANSI C63.10-2013 clause 11.10.

Connect the EUT to the spectrum analyser and use the following settings:

Center Frequency	The center frequency of the channel under test
Detector	PEAK
RBW	$3 \text{ kHz} \leq \text{RBW} \leq 100 \text{ kHz}$
VBW	$\geq 3 \times \text{RBW}$
Span	$1.5 \times \text{DTS bandwidth}$
Trace	Max hold
Sweep time	Auto couple

Allow trace to fully stabilize and use the peak marker function to determine the maximum amplitude level within the RBW.

If measured value exceeds limit, reduce RBW (no less than 3 kHz) and repeat.

### TEST SETUP

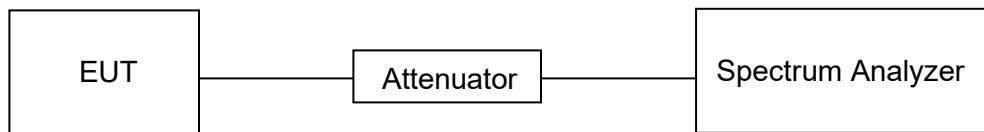

### TEST ENVIRONMENT

Temperature	26.3 °C	Relative Humidity	55.1 %
Atmosphere Pressure	101 kPa	Test Voltage	DC 3.3 V



---

**RESULTS**

Please refer to appendix D.



## 7.5. CONDUCTED BANDEGE AND SPURIOUS EMISSIONS

### LIMITS

CFR 47 FCC Part15 (15.247) Subpart C ISED RSS-247 ISSUE 2		
Section	Test Item	Limit
CFR 47 FCC §15.247 (d) ISED RSS-247 5.5	Conducted Bandedge and Spurious Emissions	at least 30 dB below that in the 100 kHz bandwidth within the band that contains the highest level of the desired power

### TEST PROCEDURE

Refer to ANSI C63.10-2013 clause 11.11 and 11.13.

Connect the EUT to the spectrum analyser and use the following settings for reference level measurement:

Center Frequency	The center frequency of the channel under test
Detector	Peak
RBW	100 kHz
VBW	$\geq 3 \times \text{RBW}$
Span	1.5 x DTS bandwidth
Trace	Max hold
Sweep time	Auto couple.

Allow trace to fully stabilize and use the peak marker function to determine the maximum PSD level.

Change the settings for emission level measurement:

Span	Set the center frequency and span to encompass frequency range to be measured
Detector	Peak
RBW	100 kHz
VBW	$\geq 3 \times \text{RBW}$
measurement points	$\geq \text{span}/\text{RBW}$
Trace	Max hold
Sweep time	Auto couple.

Allow trace to fully stabilize and use the peak marker function to determine the maximum PSD level. Ensure that the amplitude of all unwanted emissions outside of the authorized frequency band (excluding restricted frequency bands) is attenuated by at least the minimum requirements specified in 11.11.

### TEST SETUP

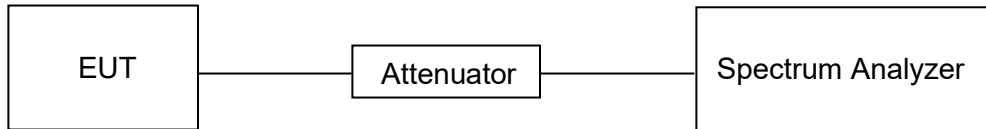

### **TEST ENVIRONMENT**

Temperature	26.2 °C	Relative Humidity	50 %
Atmosphere Pressure	101 kPa	Test Voltage	DC 3.3 V

### **RESULTS**

Please refer to appendix E & F.



## 8. RADIATED TEST RESULTS

### LIMITS

Please refer to CFR 47 FCC §15.205 and §15.209.

Please refer to ISED RSS-GEN Clause 8.9 and Clause 8.10.

Radiation Disturbance Test Limit for FCC (Class B) (9 kHz ~ 1 GHz)

Emissions radiated outside of the specified frequency bands above 30 MHz			
Frequency Range (MHz)	Field Strength Limit (uV/m) at 3 m	Field Strength Limit (dBuV/m) at 3 m	
		Quasi-Peak	
30 - 88	100	40	
88 - 216	150	43.5	
216 - 960	200	46	
Above 960	500	54	
Above 1000	500	Peak	Average
		74	54

FCC Emissions radiated outside of the specified frequency bands below 30 MHz		
Frequency (MHz)	Field strength (microvolts/meter)	Measurement distance (meters)
0.009-0.490	2400/F(kHz)	300
0.490-1.705	24000/F(kHz)	30
1.705-30.0	30	30

ISED General field strength limits at frequencies below 30 MHz

Table 6 – General field strength limits at frequencies below 30 MHz		
Frequency	Magnetic field strength (H-Field) (µA/m)	Measurement distance (m)
9 - 490 kHz <sup>Note 1</sup>	6.37/F (F in kHz)	300
490 - 1705 kHz	63.7/F (F in kHz)	30
1.705 - 30 MHz	0.08	30

**Note 1:** The emission limits for the ranges 9-90 kHz and 110-490 kHz are based on measurements employing a linear average detector.





ISED Restricted bands please refer to ISED RSS-GEN Clause 8.10

Table 7 – Restricted frequency bands <sup>Note 1</sup>		
MHz	MHz	GHz
0.090 - 0.110	149.9 - 150.05	9.0 - 9.2
0.495 - 0.505	156.52475 - 156.52525	9.3 - 9.5
2.1735 - 2.1905	156.7 - 156.9	10.6 - 12.7
3.020 - 3.026	162.0125 - 167.17	13.25 - 13.4
4.125 - 4.128	167.72 - 173.2	14.47 - 14.5
4.17725 - 4.17775	240 - 285	15.35 - 16.2
4.20725 - 4.20775	322 - 335.4	17.7 - 21.4
5.677 - 5.683	399.9 - 410	22.01 - 23.12
6.215 - 6.218	608 - 614	23.6 - 24.0
6.26775 - 6.26825	960 - 1427	31.2 - 31.8
6.31175 - 6.31225	1435 - 1626.5	36.43 - 36.5
8.291 - 8.294	1645.5 - 1646.5	Above 38.6
8.362 - 8.366	1660 - 1710	
8.37625 - 8.38675	1718.8 - 1722.2	
8.41425 - 8.41475	2200 - 2300	
12.29 - 12.293	2310 - 2390	
12.51975 - 12.52025	2483.5 - 2500	
12.57675 - 12.57725	2655 - 2900	
13.36 - 13.41	3260 - 3267	
16.42 - 16.423	3332 - 3339	
16.69475 - 16.69525	3345.8 - 3358	
16.80425 - 16.80475	3500 - 4400	
25.5 - 25.67	4500 - 5150	
37.5 - 38.25	5350 - 5460	
73 - 74.6	7250 - 7750	
74.8 - 75.2	8025 - 8500	
108 - 138		

Note 1: Certain frequency bands listed in table 7 and in bands above 38.6 GHz are designated for licence-exempt applications. These frequency bands and the requirements that apply to related devices are set out in the 200 and 300 series of RSSs.

FCC Restricted bands of operation refer to FCC §15.205 (a):

MHz	MHz	MHz	GHz
0.090-0.110	16.42-16.423	399.9-410	4.5-5.15
<sup>1</sup> 0.495-0.505	16.69475-16.69525	608-614	5.35-5.46
2.1735-2.1905	16.80425-16.80475	960-1240	7.25-7.75
4.125-4.128	25.5-25.67	1300-1427	8.025-8.5
4.17725-4.17775	37.5-38.25	1435-1626.5	9.0-9.2
4.20725-4.20775	73-74.6	1645.5-1646.5	9.3-9.5
6.215-6.218	74.8-75.2	1660-1710	10.6-12.7
6.26775-6.26825	108-121.94	1718.8-1722.2	13.25-13.4
6.31175-6.31225	123-138	2200-2300	14.47-14.5
8.291-8.294	149.9-150.05	2310-2390	15.35-16.2
8.362-8.366	156.52475-156.52525	2483.5-2500	17.7-21.4
8.37625-8.38675	156.7-156.9	2690-2900	22.01-23.12
8.41425-8.41475	162.0125-167.17	3260-3267	23.6-24.0
12.29-12.293	167.72-173.2	3332-3339	31.2-31.8
12.51975-12.52025	240-285	3345.8-3358	36.43-36.5
12.57675-12.57725	322-335.4	3600-4400	( <sup>2</sup> )
13.36-13.41			

Note: <sup>1</sup>Until February 1, 1999, this restricted band shall be 0.490-0.510 MHz.

<sup>2</sup>Above 38.6c

## TEST SETUP AND PROCEDURE

Below 30 MHz

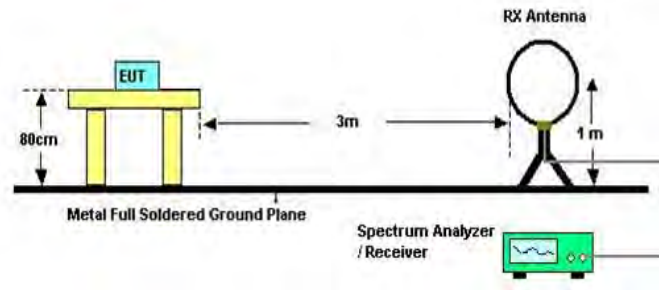

The setting of the spectrum analyser

RBW	200 Hz (From 9 kHz to 0.15 MHz)/ 9 kHz (From 0.15 MHz to 30 MHz)
VBW	200 Hz (From 9 kHz to 0.15 MHz)/ 9 kHz (From 0.15 MHz to 30 MHz)
Sweep	Auto

1. The testing follows the guidelines in ANSI C63.10-2013 clause 6.4.
2. The EUT was arranged to its worst case and then turntable (from 0 degree to 360 degrees) to find the maximum reading. A pre-amp and a high pass filter are used for the test in order to get better signal level. Both Horizontal, Face-on and Face-off polarizations of the antenna are set to make the measurement.
3. The EUT was placed on a turntable with 80 cm above ground.
4. The EUT was set 3 meters from the interference receiving antenna, which was mounted on the top of a 1 m height antenna tower.
5. The radiated emission limits are based on measurements employing a CISPR quasi-peak detector except for the frequency bands 9-90 kHz, 110-490 kHz and above 1000 MHz Radiated emission limits in these three bands are based on measurements employing an average detector.
6. For measurement below 1 GHz, the initial step in collecting conducted emission data is a spectrum analyzer peak detector mode pre-scanning the measurement frequency range. Significant peaks are then marked and then Quasi Peak and average detector mode re-measured. If the emission level of the EUT measured by the peak detector is 3 dB lower than the applicable limit, the peak emission level will be reported. Otherwise, the emission measurement will be repeated using the quasi-peak and average detector and reported.
7. Although these tests were performed other than open field site, adequate comparison measurements were confirmed against 30m open field site. Therefore sufficient tests were made to demonstrate that the alternative site produces results that correlate with the ones of tests made in an open field site based on KDB 414788.
8. The limits in CFR 47, Part 15, Subpart C, paragraph 15.209 (a), are identical to those in RSS-GEN Section 8.9, Table 6, since the measurements are performed in terms of magnetic field strength and converted to electric field strength levels (as reported in the table) using the free space impedance of  $377\Omega$ . For example, the measurement frequency X KHz resulted in a level of Y dBuV/m, which is equivalent to  $Y-51.5 = Z$  dBuA/m, which has the same margin, W dB, to the corresponding RSS-GEN Table 6 limit as it has to be 15.209(a) limit.

Below 1 GHz and above 30 MHz

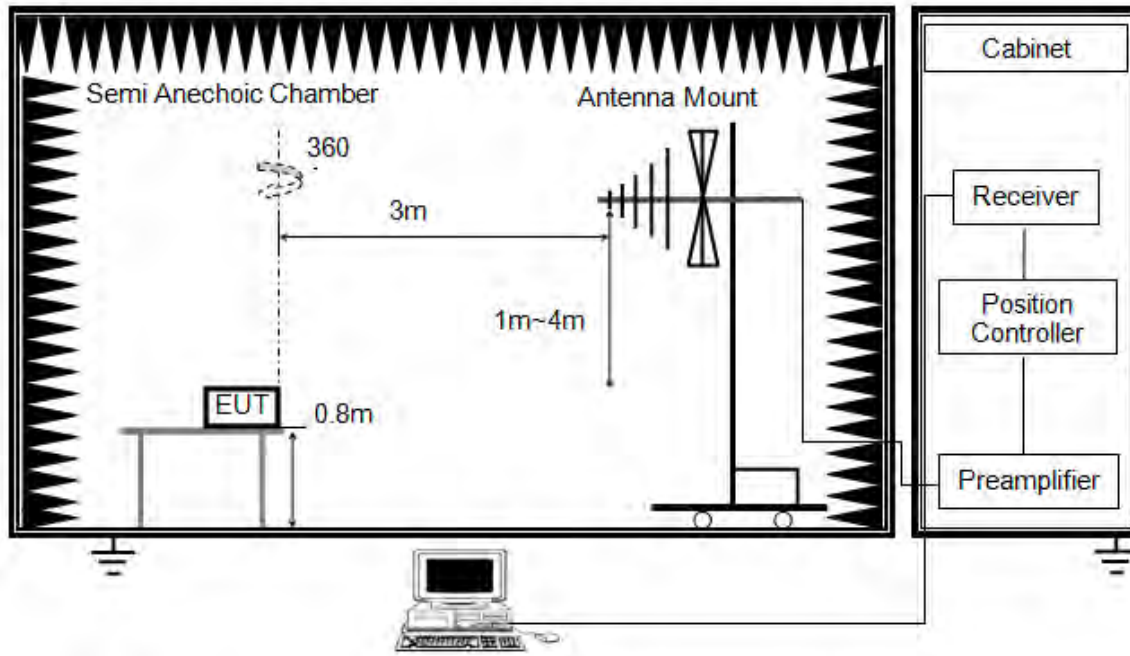

The setting of the spectrum analyser

RBW	120 kHz
VBW	300 kHz
Sweep	Auto
Detector	Peak/QP
Trace	Max hold

1. The testing follows the guidelines in ANSI C63.10-2013 clause 6.5.
2. The EUT was arranged to its worst case and then tune the antenna tower (from 1 m to 4 m) and turntable (from 0 degree to 360 degrees) to find the maximum reading. A pre-amp and a high pass filter are used for the test in order to get better signal level. Both horizontal and vertical polarizations of the antenna are set to make the measurement.
3. The EUT was placed on a turntable with 80 cm above ground.
4. The EUT was set 3 meters from the interference receiving antenna, which was mounted on the top of a variable height antenna tower.
5. For measurement below 1 GHz, the initial step in collecting conducted emission data is a spectrum analyzer peak detector mode pre-scanning the measurement frequency range. Significant peaks are then marked and then Quasi Peak detector mode re-measured. If the emission level of the EUT measured by the peak detector is 3 dB lower than the applicable limit, the peak emission level will be reported. Otherwise, the emission measurement will be repeated using the quasi-peak detector and reported.

Above 1 GHz

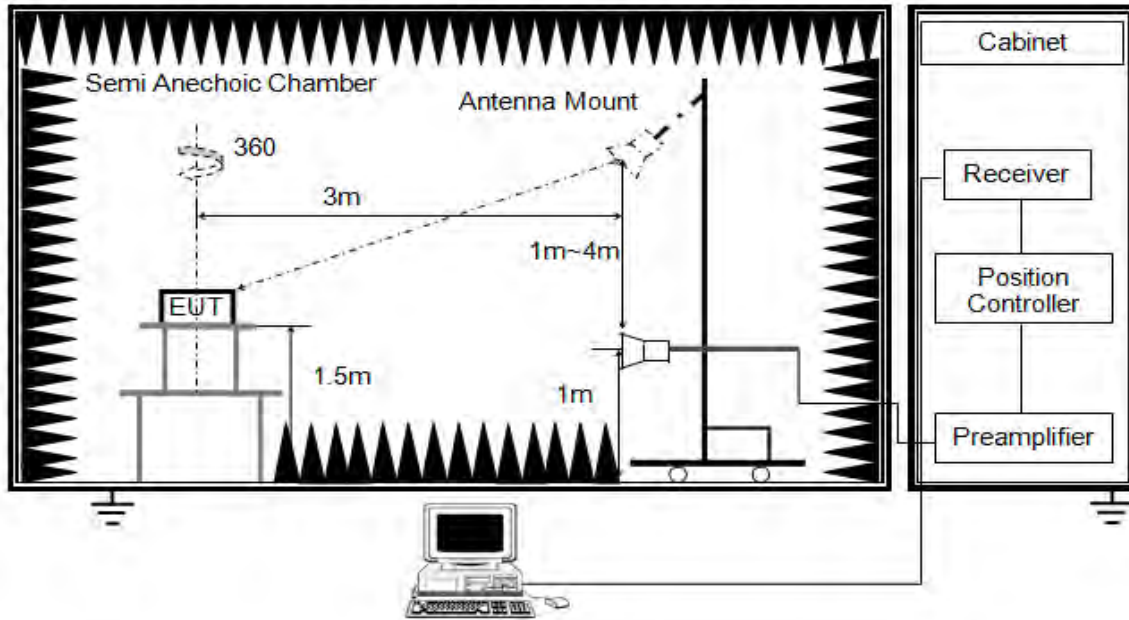

The setting of the spectrum analyser

RBW	1 MHz
VBW	PEAK: 3 MHz AVG: see note 6
Sweep	Auto
Detector	Peak
Trace	Max hold

1. The testing follows the guidelines in ANSI C63.10-2013 clause 6.6.
2. The EUT was arranged to its worst case and then tune the antenna tower (from 1 m to 4 m) and turntable (from 0 degree to 360 degrees) to find the maximum reading. A pre-amp and a high pass filter are used for the test in order to get better signal level. Both horizontal and vertical polarizations of the antenna are set to make the measurement.
3. The EUT was placed on a turntable with 1.5 m above ground.
4. The EUT was set 3 meters from the interference receiving antenna, which was mounted on the top of a variable height antenna tower.
5. For measurement above 1 GHz, the emission measurement will be measured by the peak detector. This peak level, once corrected, must comply with the limit specified in Section 15.209.
6. For measurements above 1 GHz the resolution bandwidth is set to 1 MHz, then the video bandwidth is set to 3 MHz for peak measurements and 1 MHz resolution bandwidth with 1/T video bandwidth with peak detector for average measurements. For the Duty Cycle please refer to clause 7.1.ON TIME AND DUTY CYCLE.

X axis, Y axis, Z axis positions:

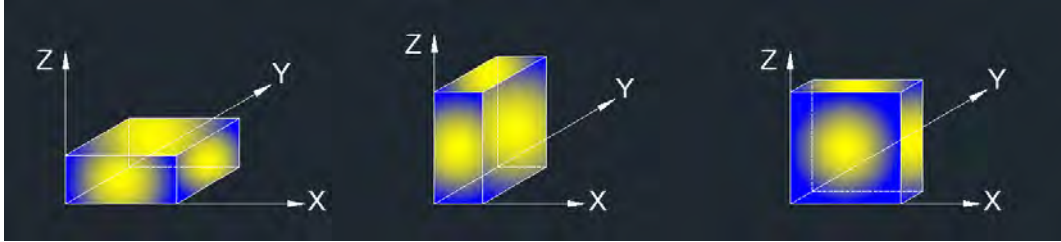

Note 1: For all radiated test, EUT in each of three orthogonal axis emissions had been tested, but only the worst case (X axis) data recorded in the report.

Note 2: Simultaneous transmission had been evaluated with the 5 GHz WLAN / 2.4 GHz WLAN and BT / BLE transmitter and has no additional or worse emissions found.

### TEST ENVIRONMENT

Temperature	23.3 °C	Relative Humidity	61 %
Atmosphere Pressure	101 kPa	Test Voltage	DC 3.3 V

### RESULTS



### 8.1. RESTRICTED BANDEDGE

#### 8.1.1. 802.11b SISO MODE

#### ANTENNA 2 TEST RESULTS (WORST CASE)

#### RESTRICTED BANDEDGE (LOW CHANNEL, HORIZONTAL)

#### PEAK

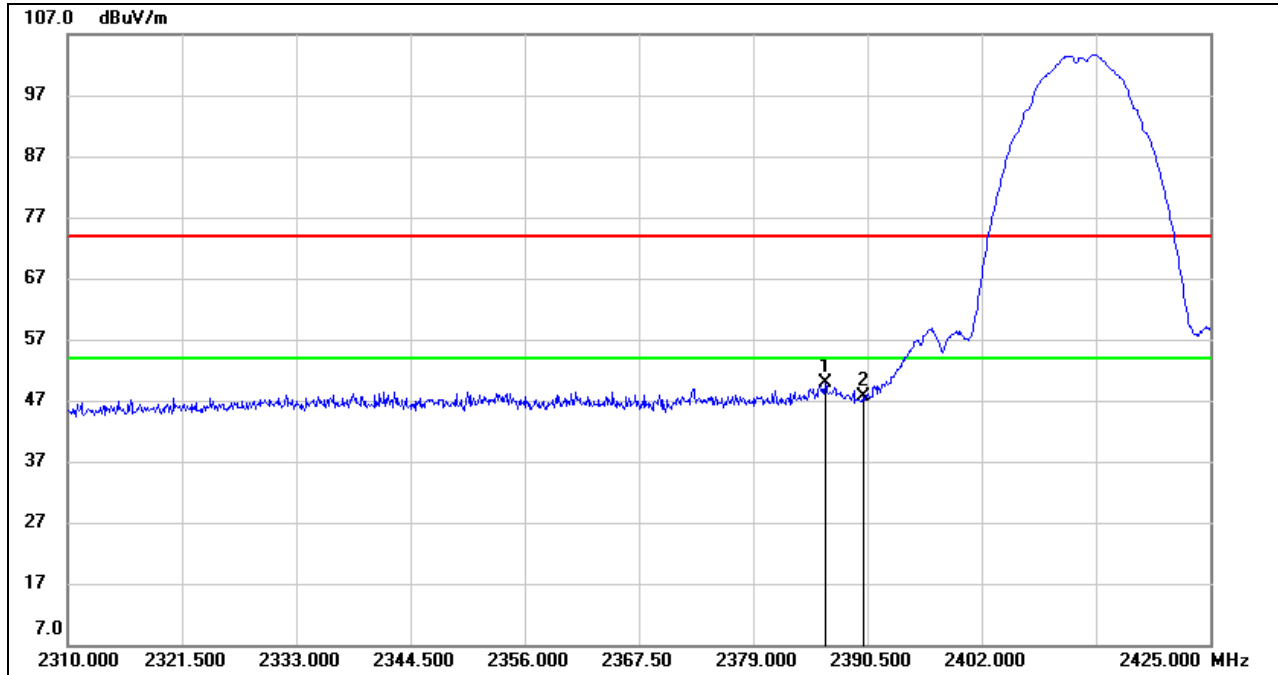

No.	Frequency (MHz)	Reading (dBuV)	Correct (dB/m)	Result (dBuV/m)	Limit (dBuV/m)	Margin (dB)	Remark
1	2386.245	17.31	32.63	49.94	74.00	-24.06	peak
2	2390.000	15.04	32.66	47.70	74.00	-26.30	peak

Note: 1. Measurement = Reading Level + Correct Factor.

2. Peak: Peak detector.

3. Only the worst data was recorded, if it complies with the limit, the other emissions deemed to comply with the limit.

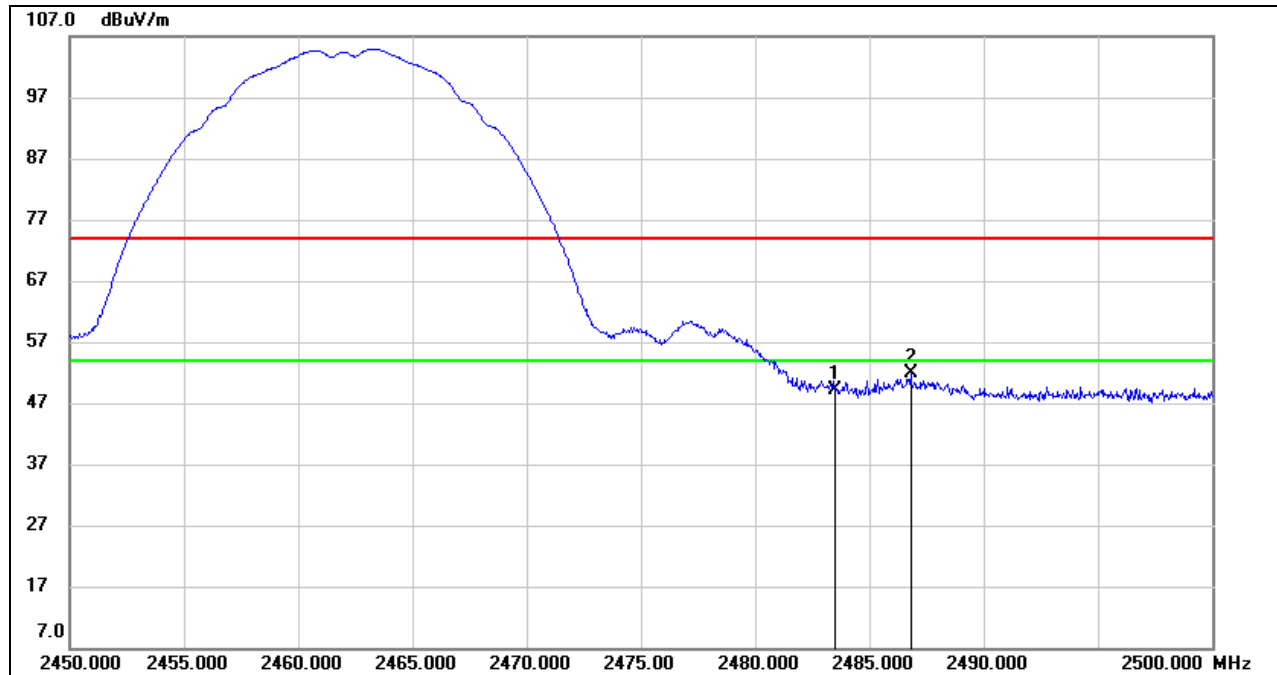
**RESTRICTED BANDEDGE (HIGH CHANNEL, HORIZONTAL)****PEAK**

No.	Frequency (MHz)	Reading (dBuV)	Correct (dB/m)	Result (dBuV/m)	Limit (dBuV/m)	Margin (dB)	Remark
1	2483.500	16.08	33.10	49.18	74.00	-24.82	peak
2	2486.800	18.71	33.11	51.82	74.00	-22.18	peak

Note: 1. Measurement = Reading Level + Correct Factor.

2. Peak: Peak detector.

3. Only the worst data was recorded, if it complies with the limit, the other emissions deemed to comply with the limit.

Note: Horizontal and Vertical have been tested, only the worst data was recorded in the report.

Note: Both antennas have been tested, only the worst data was recorded in the report.

8.1.2. 802.11g SISO MODE

ANTENNA 2 TEST RESULTS (WORST CASE)

RESTRICTED BANDEDGE (LOW CHANNEL, HORIZONTAL)

PEAK

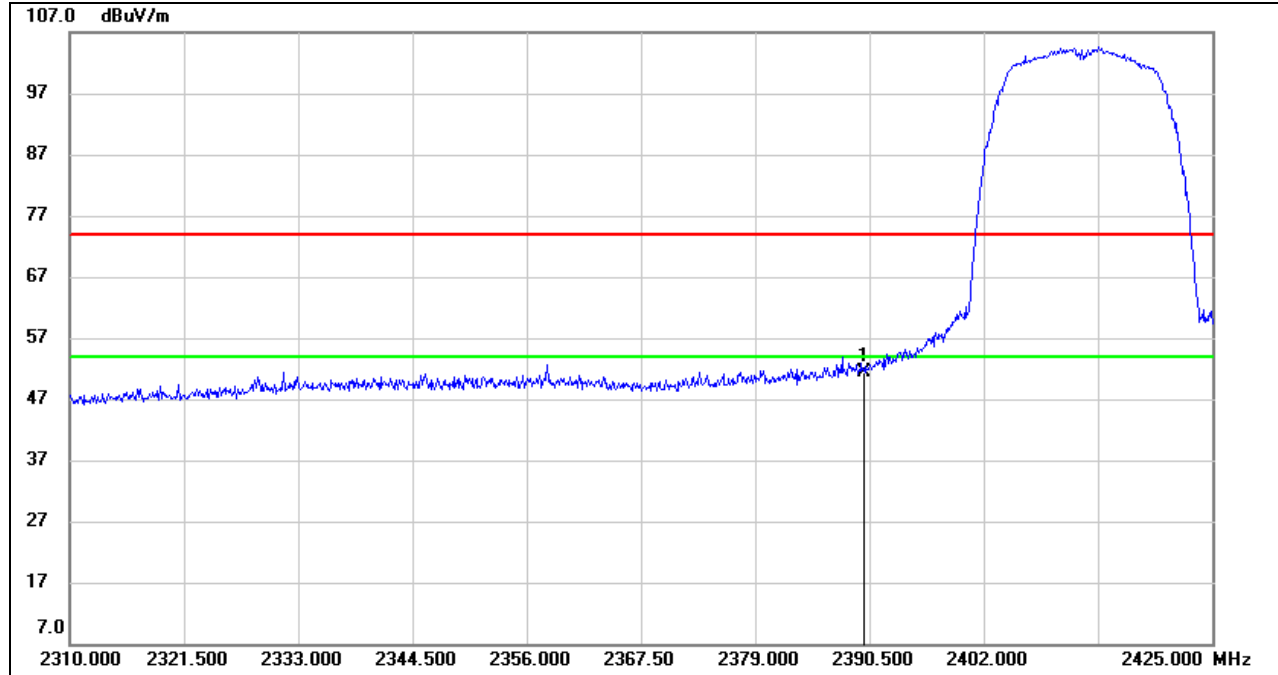

No.	Frequency (MHz)	Reading (dBuV)	Correct (dB/m)	Result (dBuV/m)	Limit (dBuV/m)	Margin (dB)	Remark
1	2390.000	18.80	32.66	51.46	74.00	-22.54	peak

Note: 1. Measurement = Reading Level + Correct Factor.

2. Peak: Peak detector.

3. Only the worst data was recorded, if it complies with the limit, the other emissions deemed to comply with the limit.

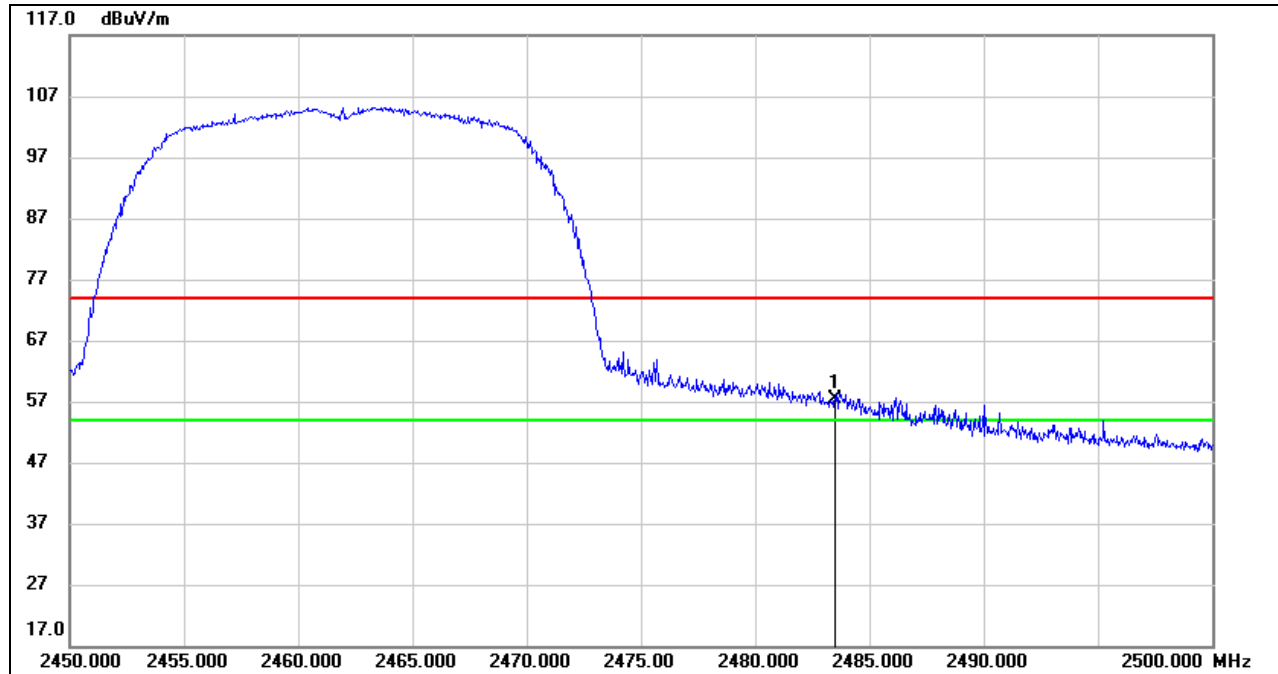

**RESTRICTED BANDEDGE (HIGH CHANNEL, HORIZONTAL)****PEAK**

No.	Frequency (MHz)	Reading (dBuV)	Correct (dB/m)	Result (dBuV/m)	Limit (dBuV/m)	Margin (dB)	Remark
1	2483.500	24.16	33.10	57.26	74.00	-16.74	peak

Note: 1. Measurement = Reading Level + Correct Factor.

2. Peak: Peak detector.

3. Only the worst data was recorded, if it complies with the limit, the other emissions deemed to comply with the limit.

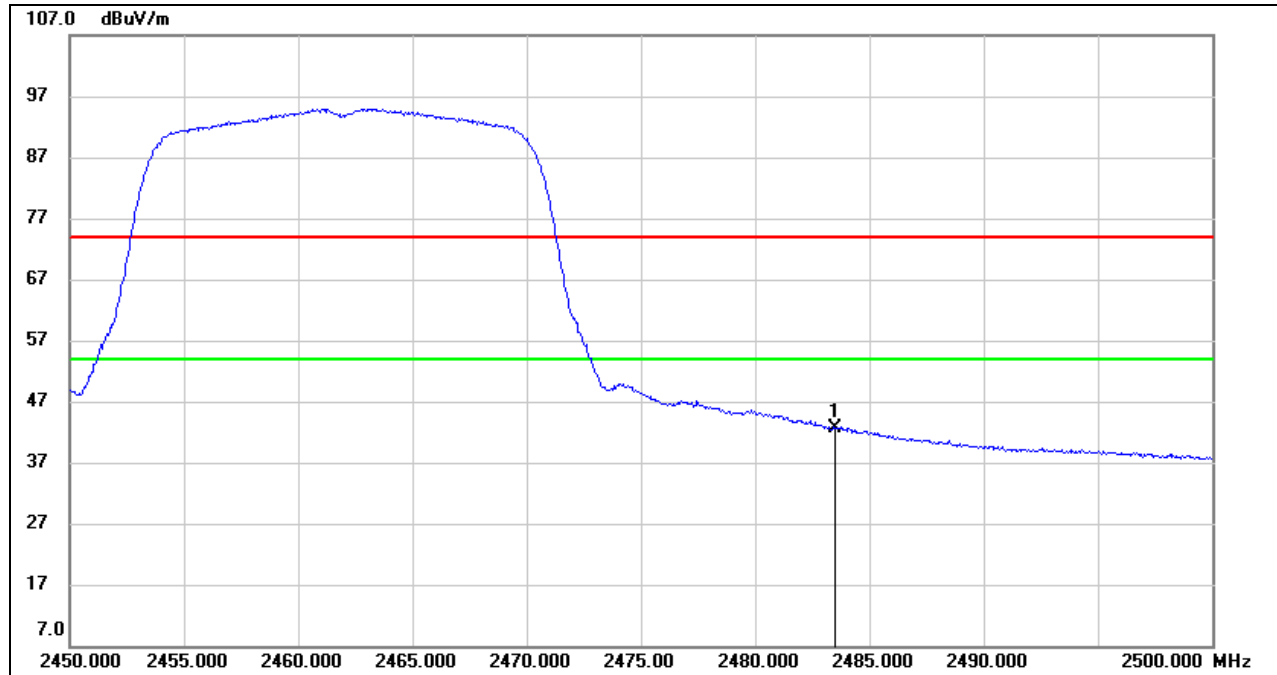
**AVG**

No.	Frequency (MHz)	Reading (dBuV)	Correct (dB/m)	Result (dBuV/m)	Limit (dBuV/m)	Margin (dB)	Remark
1	2483.500	9.50	33.10	42.60	54.00	-11.40	AVG

- Note: 1. Measurement = Reading Level + Correct Factor.  
 2. AVG:  $VBW=1/T_{on}$ , where:  $T_{on}$  is the transmitting duration.  
 3. For the transmitting duration, please refer to clause 7.1.  
 4. Only the worst data was recorded, if it complies with the limit, the other emissions deemed to comply with the limit.

Note: Horizontal and Vertical have been tested, only the worst data was recorded in the report.  
 Note: Both antennas have been tested, only the worst data was recorded in the report.

8.1.3. 802.11n HT20 MIMO MODE

RESTRICTED BANDEDGE (LOW CHANNEL, HORIZONTAL)

PEAK

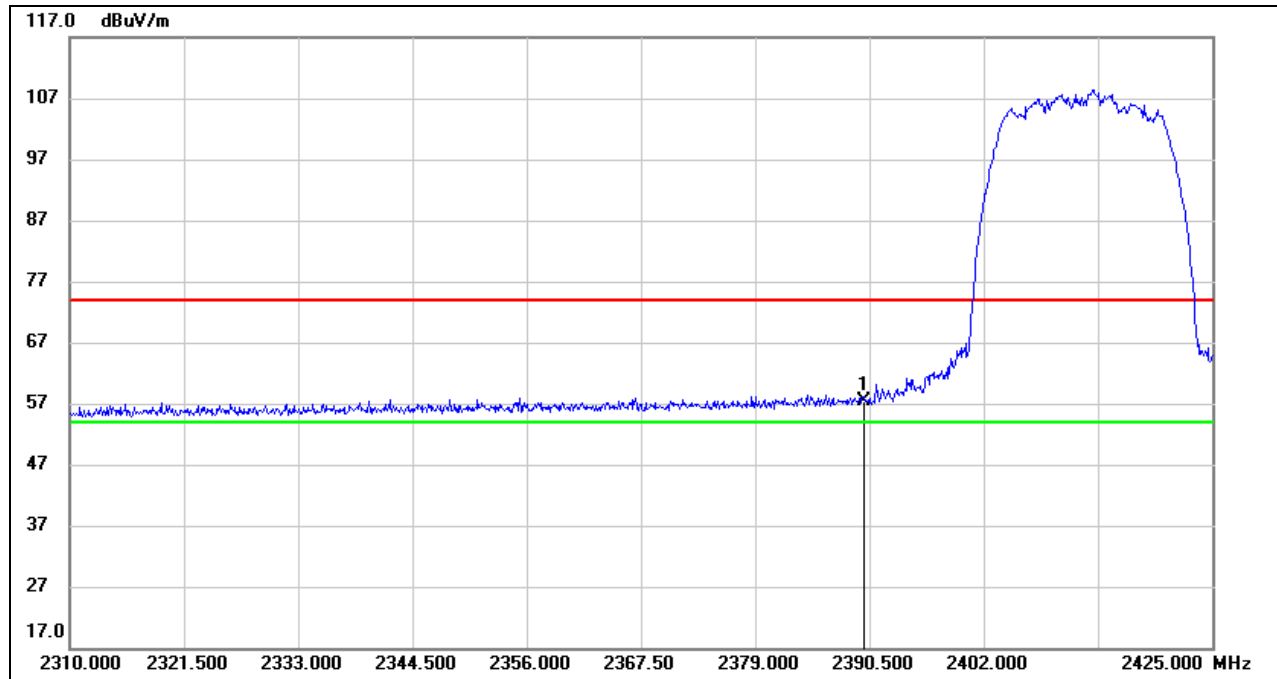

No.	Frequency (MHz)	Reading (dBuV)	Correct (dB/m)	Result (dBuV/m)	Limit (dBuV/m)	Margin (dB)	Remark
1	2390.000	24.84	32.66	57.50	74.00	-16.50	peak

Note: 1. Measurement = Reading Level + Correct Factor.  
 2. Peak: Peak detector.  
 3. Only the worst data was recorded, if it complies with the limit, the other emissions deemed to comply with the limit.



**AVG**

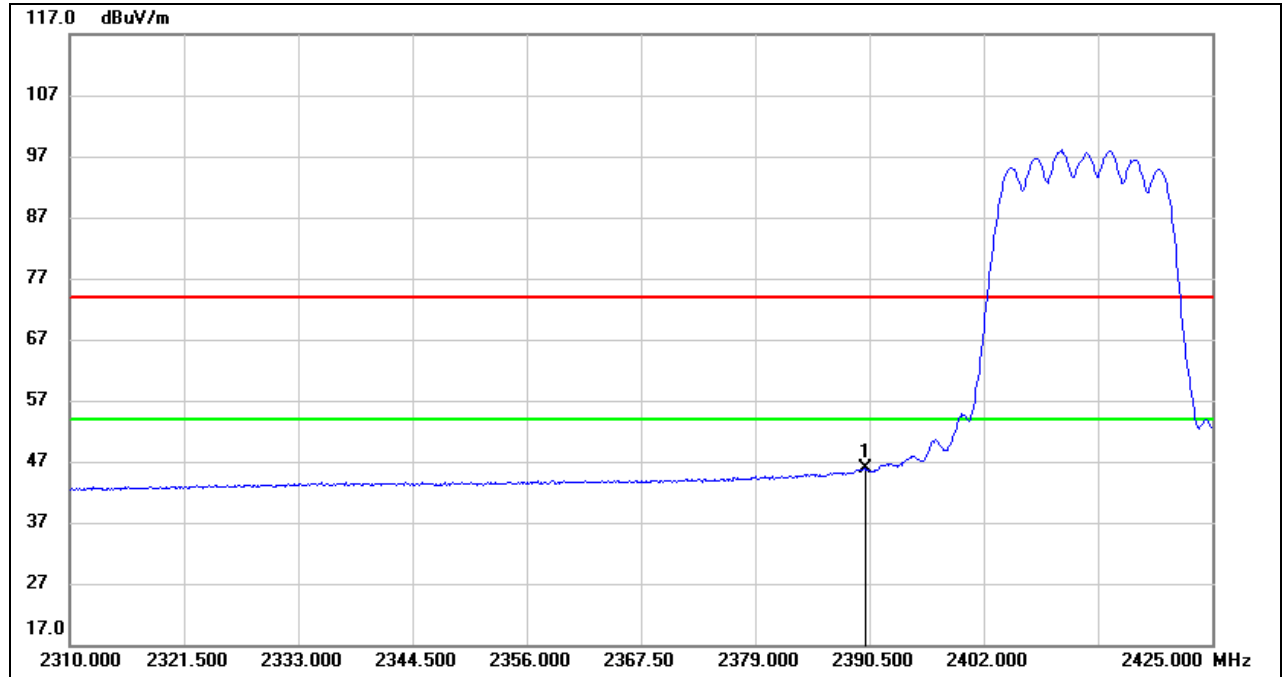

No.	Frequency (MHz)	Reading (dBuV)	Correct (dB/m)	Result (dBuV/m)	Limit (dBuV/m)	Margin (dB)	Remark
1	2390.000	13.31	32.66	45.97	54.00	-8.03	AVG

- Note:
1. Measurement = Reading Level + Correct Factor.
  2. AVG:  $VBW=1/T_{on}$ , where:  $T_{on}$  is the transmitting duration.
  3. For the transmitting duration, please refer to clause 7.1.
  4. Only the worst data was recorded, if it complies with the limit, the other emissions deemed to comply with the limit.



**RESTRICTED BANDEDGE (HIGH CHANNEL, HORIZONTAL)**

**PEAK**

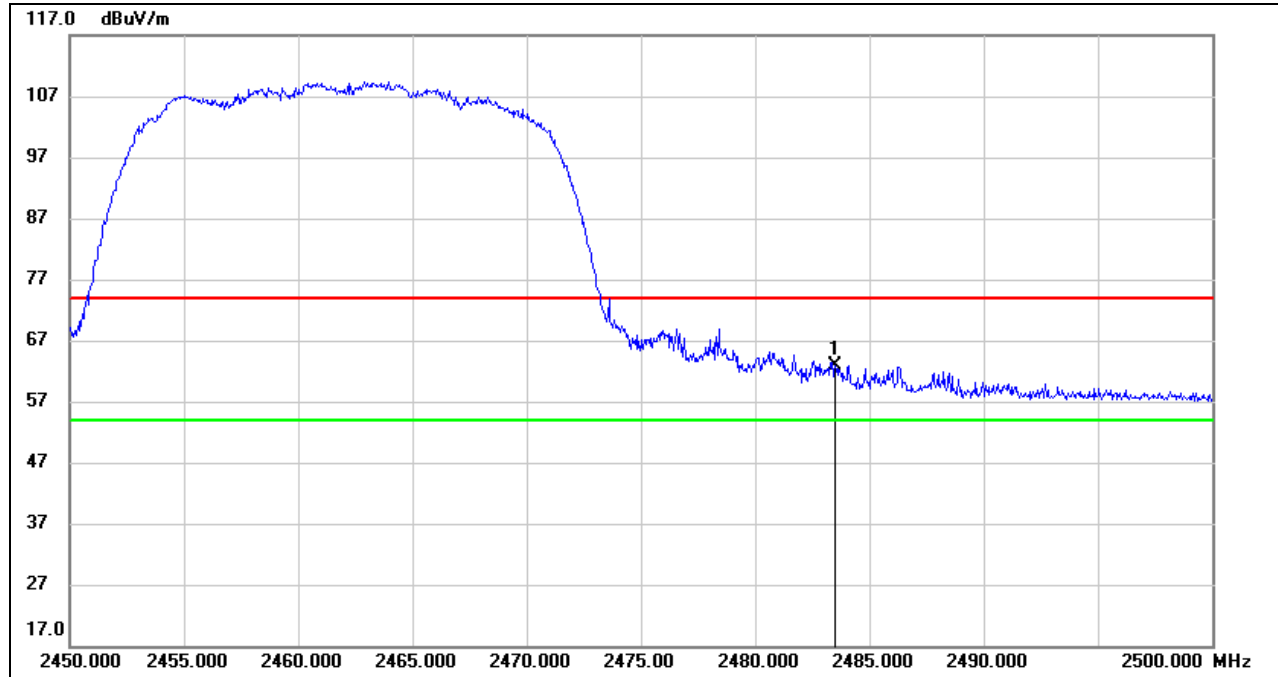

No.	Frequency (MHz)	Reading (dBuV)	Correct (dB/m)	Result (dBuV/m)	Limit (dBuV/m)	Margin (dB)	Remark
1	2483.500	29.83	33.10	62.93	74.00	-11.07	peak

- Note: 1. Measurement = Reading Level + Correct Factor.  
 2. Peak: Peak detector.  
 3. Only the worst data was recorded, if it complies with the limit, the other emissions deemed to comply with the limit.



**AVG**

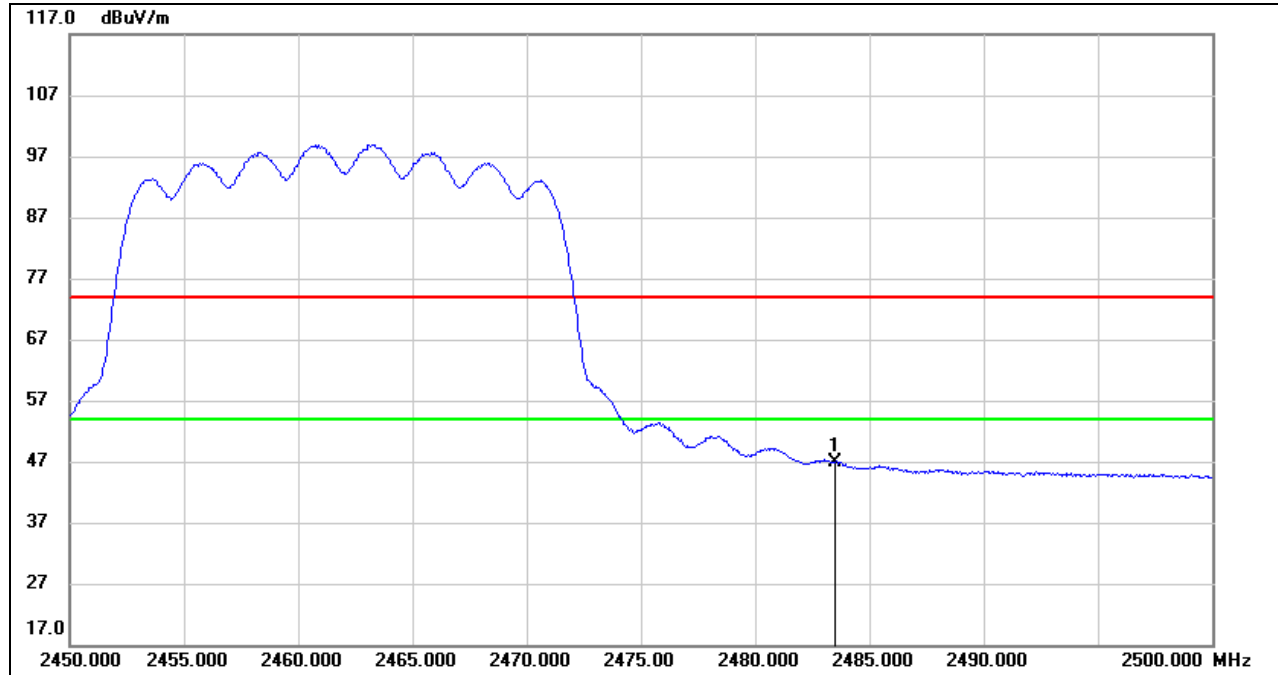

No.	Frequency (MHz)	Reading (dBuV)	Correct (dB/m)	Result (dBuV/m)	Limit (dBuV/m)	Margin (dB)	Remark
1	2483.500	13.86	33.10	46.96	54.00	-7.04	AVG

- Note: 1. Measurement = Reading Level + Correct Factor.  
 2. AVG:  $VBW=1/Ton$ , where: Ton is the transmitting duration.  
 3. For the transmitting duration, please refer to clause 7.1.  
 4. Only the worst data was recorded, if it complies with the limit, the other emissions deemed to comply with the limit.

Note: Horizontal and Vertical have been tested, only the worst data was recorded in the report.

Note: All modes have been tested, only the worst data was recorded in the report.



8.1.4. 802.11n HT40 MIMO MODE

RESTRICTED BANDEDGE (LOW CHANNEL, HORIZONTAL)

PEAK

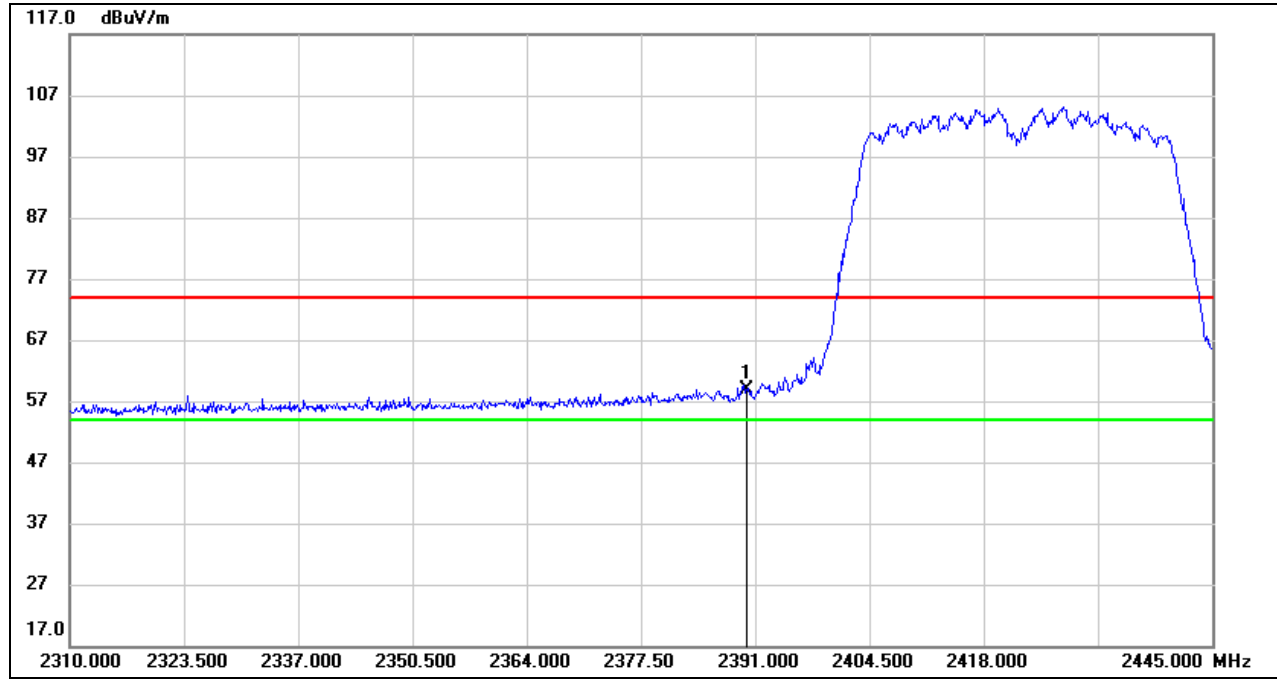

No.	Frequency (MHz)	Reading (dBuV)	Correct (dB/m)	Result (dBuV/m)	Limit (dBuV/m)	Margin (dB)	Remark
1	2390.000	26.32	32.66	58.98	74.00	-15.02	peak

Note: 1. Measurement = Reading Level + Correct Factor.  
 2. Peak: Peak detector.  
 3. Only the worst data was recorded, if it complies with the limit, the other emissions deemed to comply with the limit.

### AVG

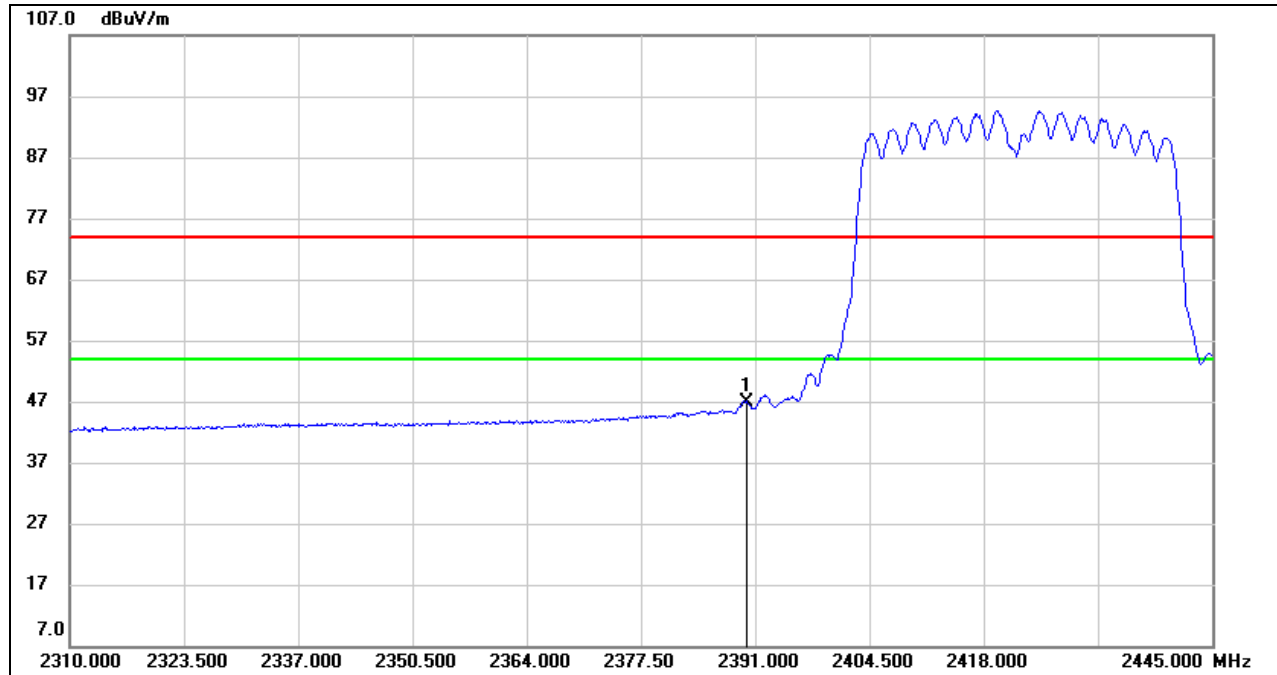

No.	Frequency (MHz)	Reading (dBuV)	Correct (dB/m)	Result (dBuV/m)	Limit (dBuV/m)	Margin (dB)	Remark
1	2390.000	14.12	32.66	46.78	54.00	-7.22	AVG

- Note:
1. Measurement = Reading Level + Correct Factor.
  2. AVG:  $VBW=1/Ton$ , where:  $Ton$  is the transmitting duration.
  3. For the transmitting duration, please refer to clause 7.1.
  4. Only the worst data was recorded, if it complies with the limit, the other emissions deemed to comply with the limit.





**RESTRICTED BANDEDGE (HIGH CHANNEL, HORIZONTAL)**

**PEAK**

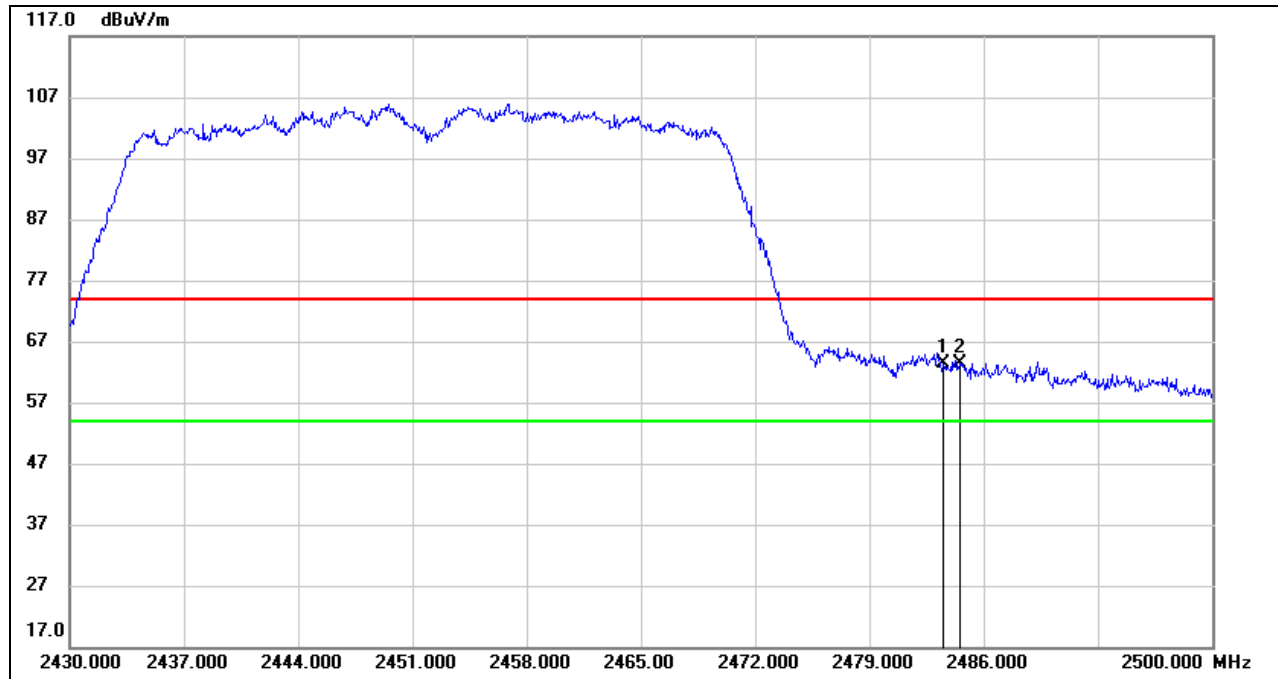

No.	Frequency (MHz)	Reading (dBuV)	Correct (dB/m)	Result (dBuV/m)	Limit (dBuV/m)	Margin (dB)	Remark
1	2483.500	30.38	33.10	63.48	74.00	-10.52	peak
2	2484.530	30.18	33.10	63.28	74.00	-10.72	peak

Note: 1. Measurement = Reading Level + Correct Factor.

2. Peak: Peak detector.

3. Only the worst data was recorded, if it complies with the limit, the other emissions deemed to comply with the limit.

**AVG**

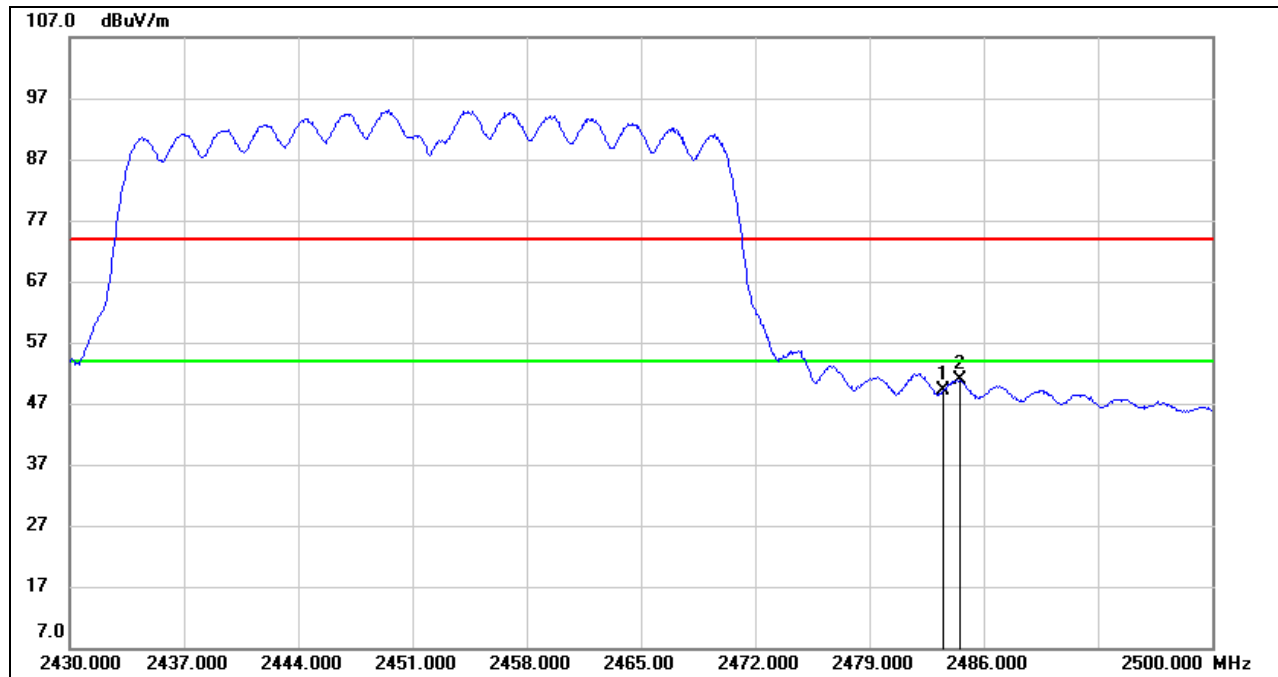

No.	Frequency (MHz)	Reading (dBuV)	Correct (dB/m)	Result (dBuV/m)	Limit (dBuV/m)	Margin (dB)	Remark
1	2483.500	15.95	33.10	49.05	54.00	-4.95	AVG
2	2484.530	17.83	33.10	50.93	54.00	-3.07	AVG

- Note: 1. Measurement = Reading Level + Correct Factor.  
 2. AVG:  $VBW=1/Ton$ , where: Ton is the transmitting duration.  
 3. For the transmitting duration, please refer to clause 7.1.  
 4. Only the worst data was recorded, if it complies with the limit, the other emissions deemed to comply with the limit.

Note: Horizontal and Vertical have been tested, only the worst data was recorded in the report.  
 Note: All modes have been tested, only the worst data was recorded in the report.



## 8.2. SPURIOUS EMISSIONS (1 GHz ~ 3 GHz)

### 8.2.1. 802.11b SISO MODE

#### ANTENNA 1 TEST RESULTS (WORST CASE)

#### HARMONICS AND SPURIOUS EMISSIONS (LOW CHANNEL, HORIZONTAL)

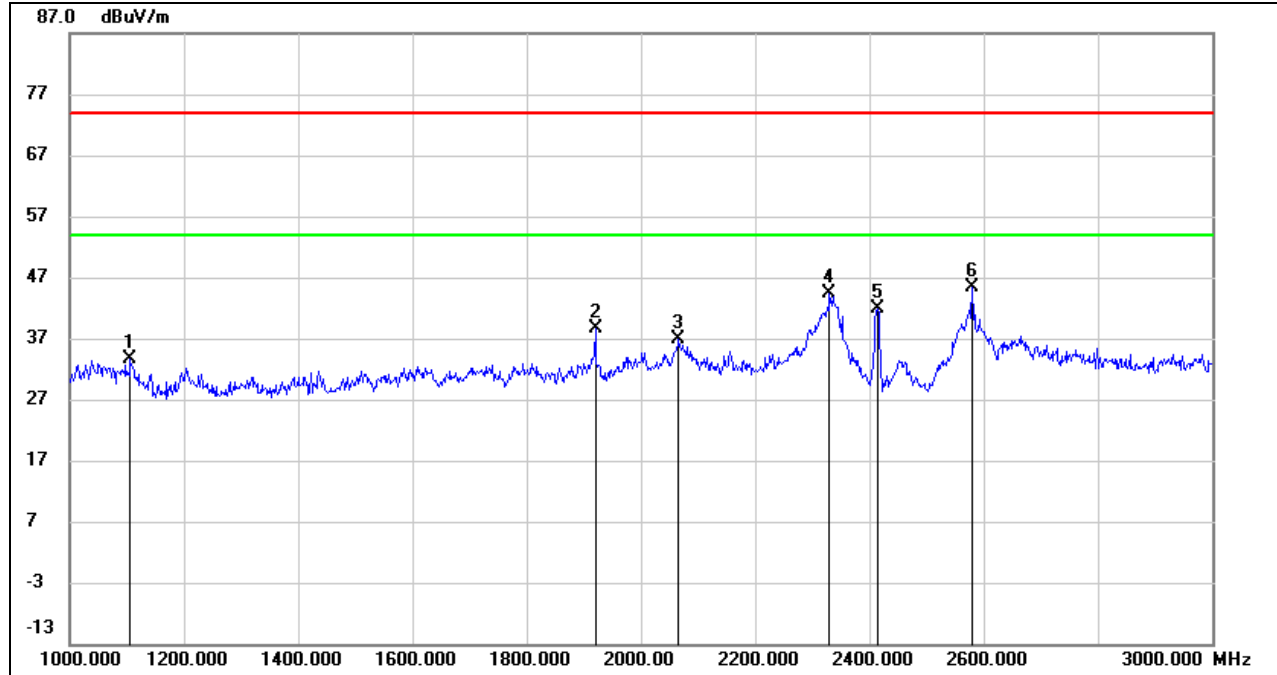

No.	Frequency (MHz)	Reading (dBuV)	Correct (dB/m)	Result (dBuV/m)	Limit (dBuV/m)	Margin (dB)	Remark
1	1106.000	47.92	-14.39	33.53	74.00	-40.47	peak
2	1920.000	49.60	-11.02	38.58	74.00	-35.42	peak
3	2066.000	47.59	-10.77	36.82	74.00	-37.18	peak
4	2330.000	53.65	-9.36	44.29	74.00	-29.71	peak
5	2412.000	51.01	-9.03	41.98	/	/	Fundamental
6	2580.000	54.08	-8.68	45.40	74.00	-28.60	peak

Note: 1. Measurement = Reading Level + Correct Factor.

2. If Peak Result complies with AV limit, AV Result is deemed to comply with AV limit.

3. Peak: Peak detector.

4. Filter losses were only considered in the spurious frequency bands and the authorized band was not corrected for Band reject filter losses.

5. Proper operation of the transmitter prior to adding the filter to the measurement chain.

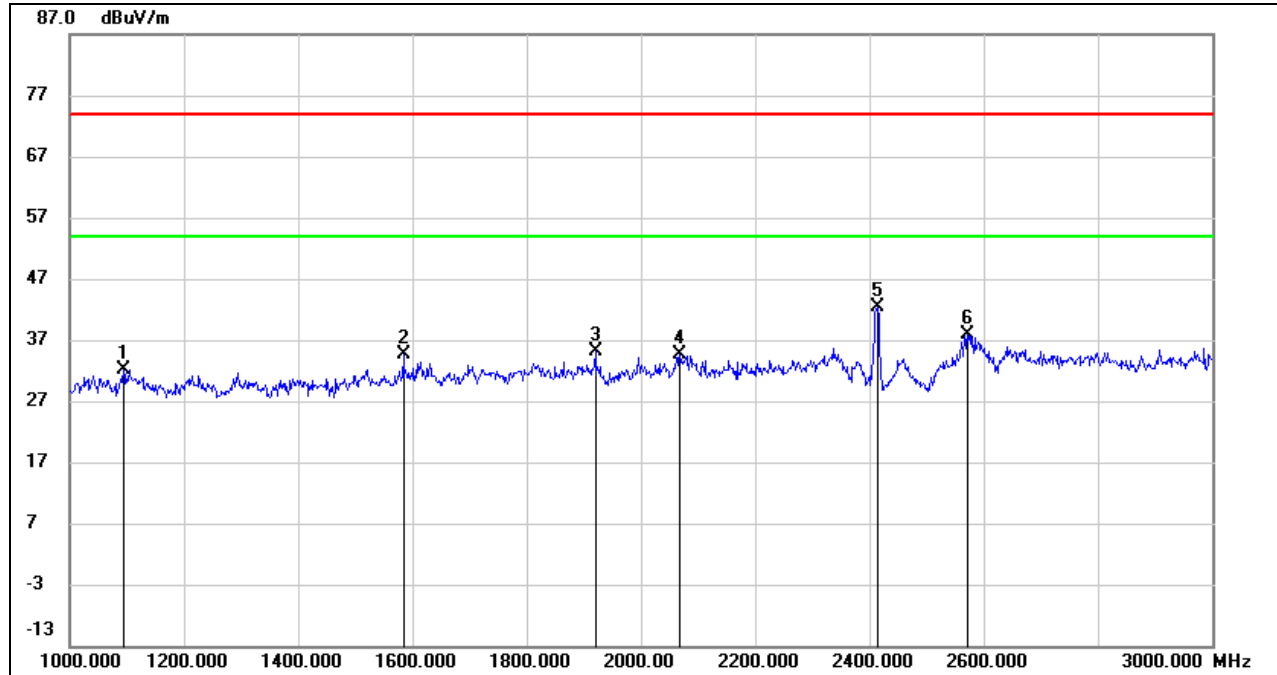
**HARMONICS AND SPURIOUS EMISSIONS (LOW CHANNEL, VERTICAL)**

No.	Frequency (MHz)	Reading (dBuV)	Correct (dB/m)	Result (dBuV/m)	Limit (dBuV/m)	Margin (dB)	Remark
1	1094.000	46.67	-14.47	32.20	74.00	-41.80	peak
2	1584.000	46.82	-12.08	34.74	74.00	-39.26	peak
3	1920.000	46.08	-11.02	35.06	74.00	-38.94	peak
4	2068.000	45.30	-10.74	34.56	74.00	-39.44	peak
5	2412.000	51.30	-9.03	42.27	/	/	Fundamental
6	2572.000	46.46	-8.69	37.77	74.00	-36.23	peak

Note: 1. Measurement = Reading Level + Correct Factor.

2. If Peak Result complies with AV limit, AV Result is deemed to comply with AV limit.

3. Peak: Peak detector.

4. Filter losses were only considered in the spurious frequency bands and the authorized band was not corrected for Band reject filter losses.

5. Proper operation of the transmitter prior to adding the filter to the measurement chain.

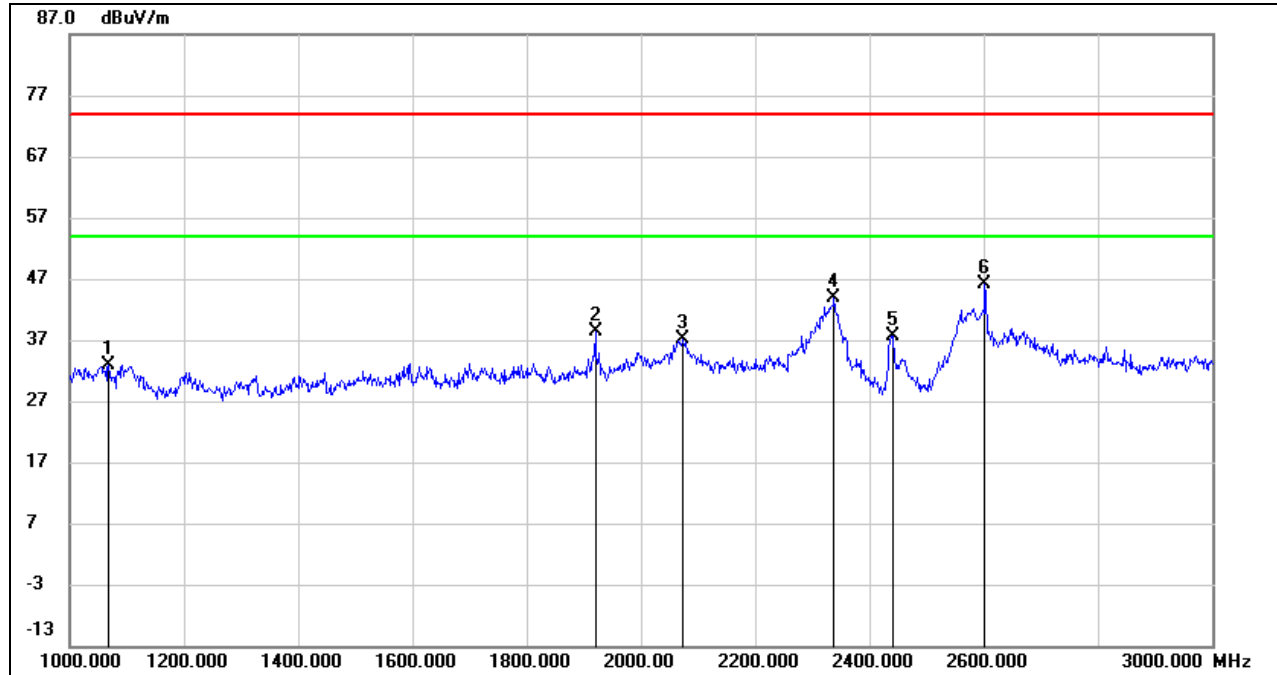
**HARMONICS AND SPURIOUS EMISSIONS (MID CHANNEL, HORIZONTAL)**

No.	Frequency (MHz)	Reading (dBuV)	Correct (dB/m)	Result (dBuV/m)	Limit (dBuV/m)	Margin (dB)	Remark
1	1068.000	47.56	-14.63	32.93	74.00	-41.07	peak
2	1920.000	49.33	-11.02	38.31	74.00	-35.69	peak
3	2074.000	47.89	-10.71	37.18	74.00	-36.82	peak
4	2338.000	53.11	-9.33	43.78	74.00	-30.22	peak
5	2437.000	46.65	-8.98	37.67	/	/	Fundamental
6	2602.000	54.85	-8.64	46.21	74.00	-27.79	peak

Note: 1. Measurement = Reading Level + Correct Factor.

2. If Peak Result complies with AV limit, AV Result is deemed to comply with AV limit.

3. Peak: Peak detector.

4. Filter losses were only considered in the spurious frequency bands and the authorized band was not corrected for Band reject filter losses.

5. Proper operation of the transmitter prior to adding the filter to the measurement chain.

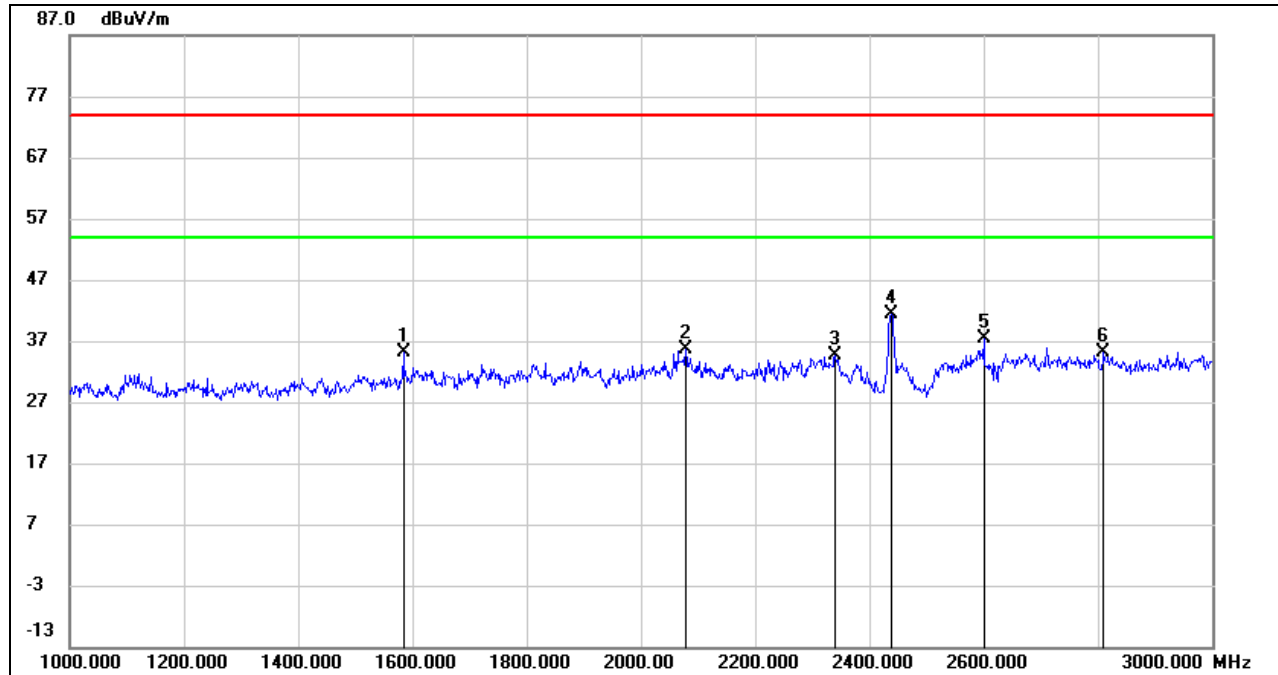
**HARMONICS AND SPURIOUS EMISSIONS (MID CHANNEL, VERTICAL)**

No.	Frequency (MHz)	Reading (dBuV)	Correct (dB/m)	Result (dBuV/m)	Limit (dBuV/m)	Margin (dB)	Remark
1	1584.000	47.11	-12.08	35.03	74.00	-38.97	peak
2	2078.000	46.37	-10.69	35.68	74.00	-38.32	peak
3	2340.000	43.89	-9.32	34.57	74.00	-39.43	peak
4	2437.000	50.28	-8.98	41.30	/	/	Fundamental
5	2600.000	46.09	-8.64	37.45	74.00	-36.55	peak
6	2810.000	42.80	-7.66	35.14	74.00	-38.86	peak

Note: 1. Measurement = Reading Level + Correct Factor.

2. If Peak Result complies with AV limit, AV Result is deemed to comply with AV limit.

3. Peak: Peak detector.

4. Filter losses were only considered in the spurious frequency bands and the authorized band was not corrected for Band reject filter losses.

5. Proper operation of the transmitter prior to adding the filter to the measurement chain.

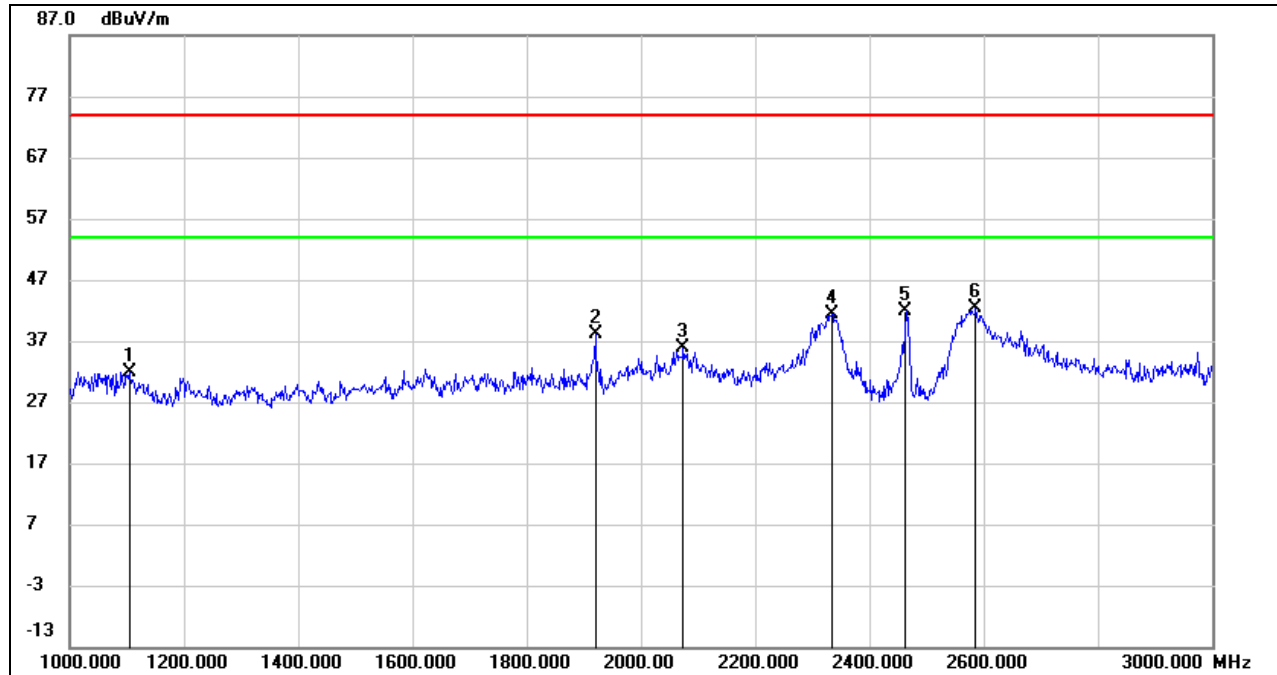
**HARMONICS AND SPURIOUS EMISSIONS (HIGH CHANNEL, HORIZONTAL)**

No.	Frequency (MHz)	Reading (dBuV)	Correct (dB/m)	Result (dBuV/m)	Limit (dBuV/m)	Margin (dB)	Remark
1	1104.000	46.32	-14.40	31.92	74.00	-42.08	peak
2	1920.000	49.13	-11.02	38.11	74.00	-35.89	peak
3	2074.000	46.65	-10.71	35.94	74.00	-38.06	peak
4	2334.000	50.69	-9.34	41.35	74.00	-32.65	peak
5	2462.000	50.88	-8.92	41.96	74.00	-32.04	peak
6	2586.000	51.10	-8.68	42.42	74.00	-31.58	peak

- Note: 1. Measurement = Reading Level + Correct Factor.  
 2. If Peak Result complies with AV limit, AV Result is deemed to comply with AV limit.  
 3. Peak: Peak detector.  
 4. Filter losses were only considered in the spurious frequency bands and the authorized band was not corrected for Band reject filter losses.  
 5. Proper operation of the transmitter prior to adding the filter to the measurement chain.

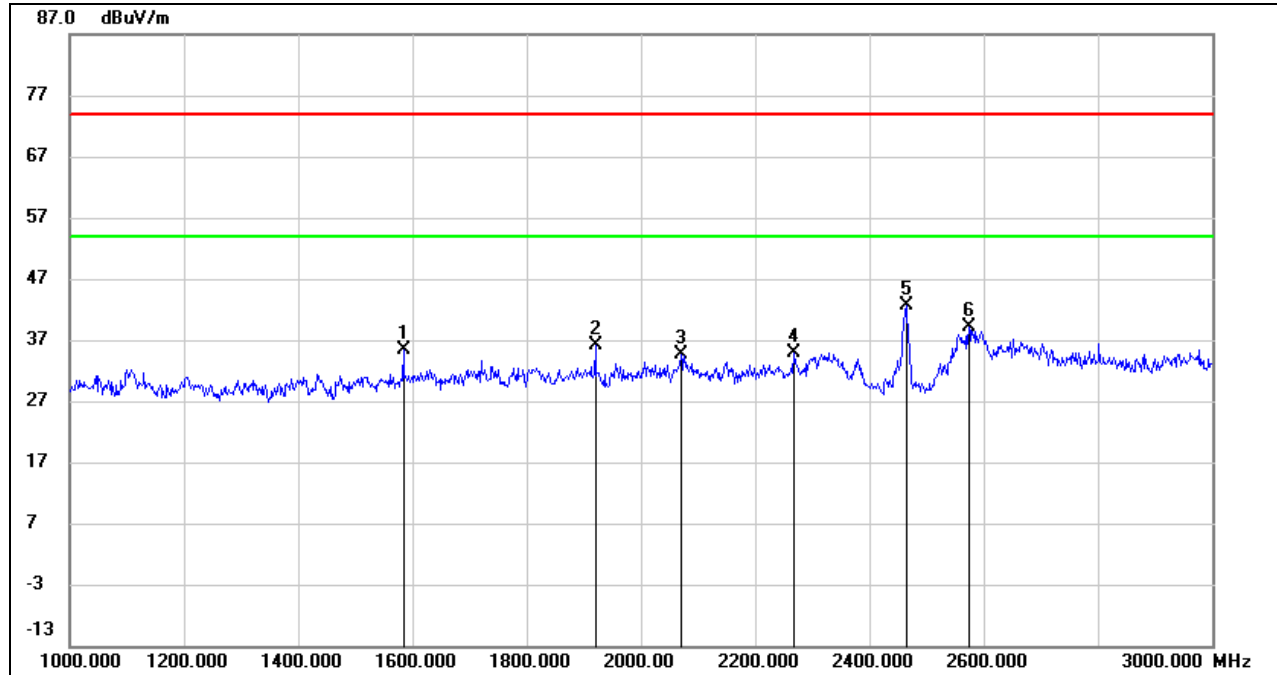
**HARMONICS AND SPURIOUS EMISSIONS (HIGH CHANNEL, VERTICAL)**

No.	Frequency (MHz)	Reading (dBuV)	Correct (dB/m)	Result (dBuV/m)	Limit (dBuV/m)	Margin (dB)	Remark
1	1584.000	47.41	-12.08	35.33	74.00	-38.67	peak
2	1920.000	47.24	-11.02	36.22	74.00	-37.78	peak
3	2070.000	45.26	-10.73	34.53	74.00	-39.47	peak
4	2268.000	44.44	-9.61	34.83	74.00	-39.17	peak
5	2462.000	51.44	-8.90	42.54	/	/	Fundamental
6	2574.000	47.93	-8.69	39.24	74.00	-34.76	peak

- Note: 1. Measurement = Reading Level + Correct Factor.  
 2. If Peak Result complies with AV limit, AV Result is deemed to comply with AV limit.  
 3. Peak: Peak detector.  
 4. Filter losses were only considered in the spurious frequency bands and the authorized band was not corrected for Band reject filter losses.  
 5. Proper operation of the transmitter prior to adding the filter to the measurement chain.

Note: Both the two antennas had been tested, but only the worst data was recorded in the report.

Note: All modes, channels and antenna have been tested, only the worst data was recorded in the report.



### 8.3. SPURIOUS EMISSIONS (3 GHz ~ 18 GHz)

#### 8.3.1. 802.11b SISO MODE

##### ANTENNA 2 TEST RESULTS (WORST CASE)

##### HARMONICS AND SPURIOUS EMISSIONS (LOW CHANNEL, HORIZONTAL)

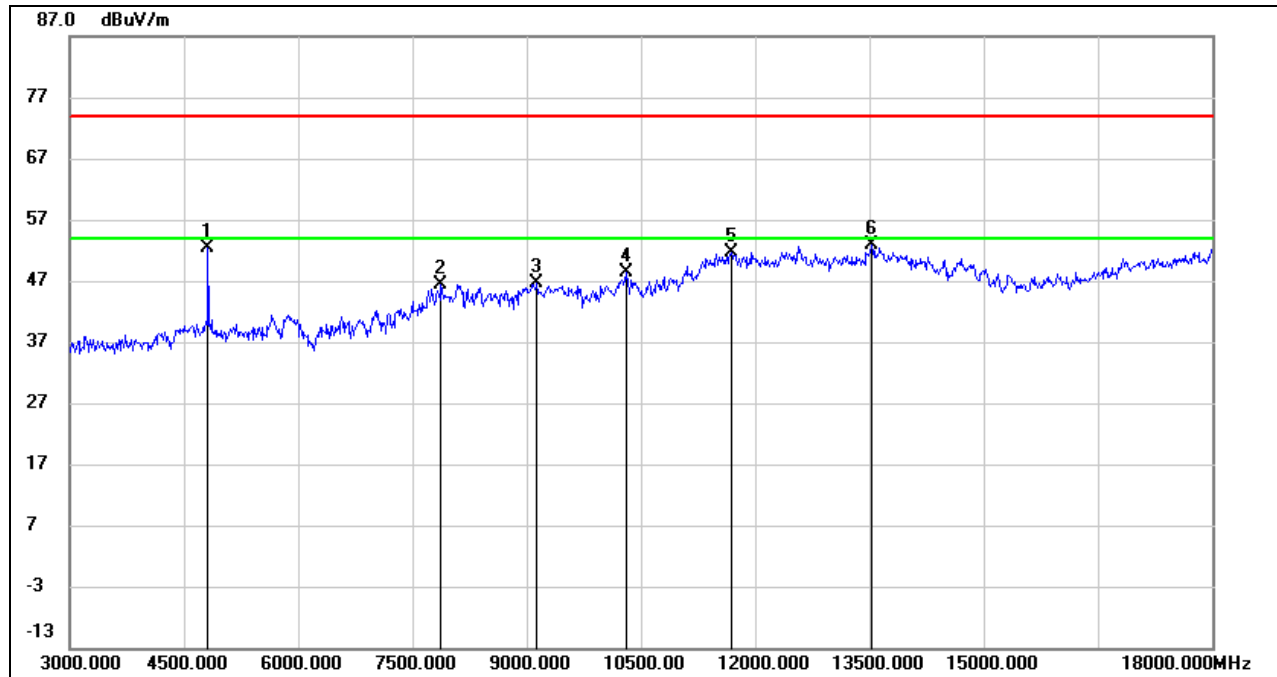

No.	Frequency (MHz)	Reading (dBuV)	Correct (dB/m)	Result (dBuV/m)	Limit (dBuV/m)	Margin (dB)	Remark
1	4824.375	52.26	0.11	52.37	74.00	-21.63	peak
2	7886.250	38.09	8.30	46.39	74.00	-27.61	peak
3	9142.500	36.93	9.66	46.59	74.00	-27.41	peak
4	10308.750	36.12	12.37	48.49	74.00	-25.51	peak
5	11686.875	34.55	17.03	51.58	74.00	-22.42	peak
6	13535.625	33.72	19.16	52.88	74.00	-21.12	peak

- Note:
1. Peak Result = Reading Level + Correct Factor.
  2. If Peak Result complies with AV limit, AV Result is deemed to comply with AV limit.
  3. Peak: Peak detector.
  4. AVG:  $VBW=1/Ton$ , where: Ton is the transmitting duration.
  5. For the transmitting duration, please refer to clause 7.1.
  6. Filter losses were only considered in the spurious frequency bands and the authorized band was not corrected for High Pass Filter losses.
  7. Proper operation of the transmitter prior to adding the filter to the measurement chain.

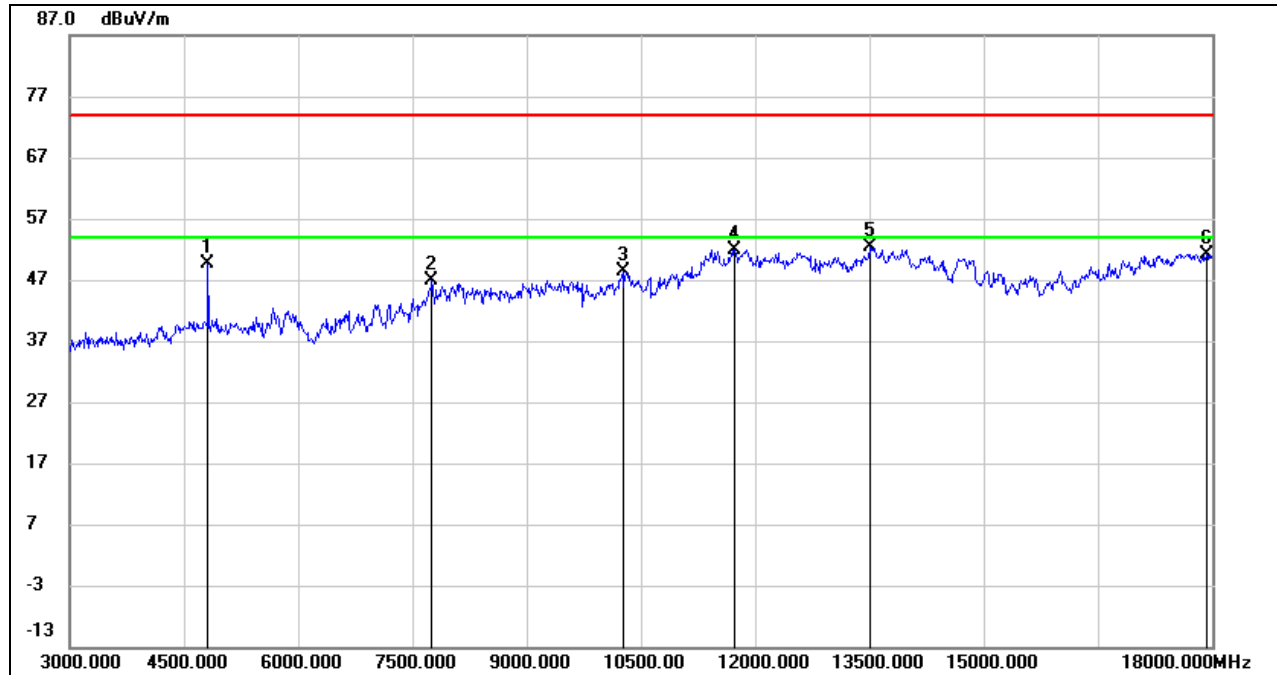
**HARMONICS AND SPURIOUS EMISSIONS (LOW CHANNEL, VERTICAL)**

No.	Frequency (MHz)	Reading (dBuV)	Correct (dB/m)	Result (dBuV/m)	Limit (dBuV/m)	Margin (dB)	Remark
1	4815.000	49.52	0.13	49.65	74.00	-24.35	peak
2	7755.000	38.51	8.29	46.80	74.00	-27.20	peak
3	10260.000	36.09	12.22	48.31	74.00	-25.69	peak
4	11730.000	34.85	17.07	51.92	74.00	-22.08	peak
5	13500.000	33.05	19.22	52.27	74.00	-21.73	peak
6	17925.000	26.72	24.47	51.19	74.00	-22.81	peak

- Note: 1. Peak Result = Reading Level + Correct Factor.  
 2. If Peak Result complies with AV limit, AV Result is deemed to comply with AV limit.  
 3. Peak: Peak detector.  
 4. Filter losses were only considered in the spurious frequency bands and the authorized band was not corrected for High Pass Filter losses.  
 5. Proper operation of the transmitter prior to adding the filter to the measurement chain.

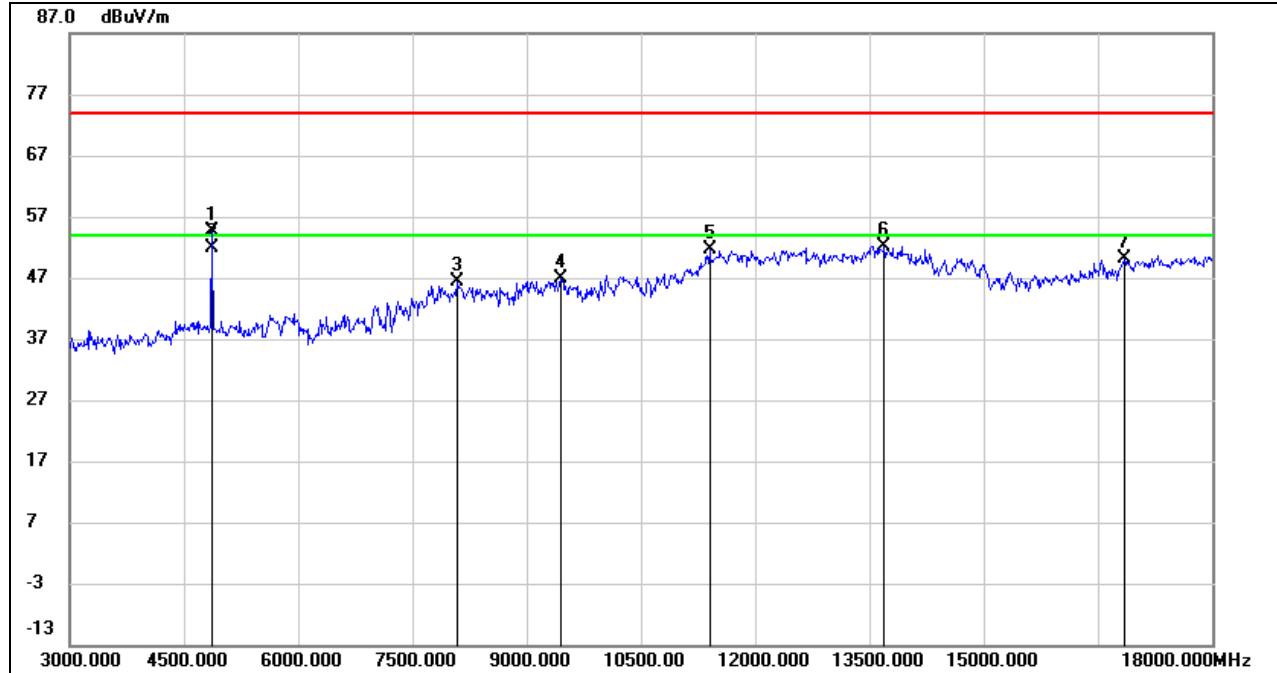
**HARMONICS AND SPURIOUS EMISSIONS (MID CHANNEL, HORIZONTAL)**

No.	Frequency (MHz)	Reading (dBuV)	Correct (dB/m)	Result (dBuV/m)	Limit (dBuV/m)	Margin (dB)	Remark
1	4873.125	54.68	0.02	54.70	74.00	-19.30	peak
2	4873.125	51.96	0.02	51.98	54.00	-2.02	AVG
3	8092.500	37.03	9.44	46.47	74.00	-27.53	peak
4	9455.625	36.30	10.59	46.89	74.00	-27.11	peak
5	11409.375	35.14	16.38	51.52	74.00	-22.48	peak
6	13706.250	32.65	19.49	52.14	74.00	-21.86	peak
7	16845.000	31.01	19.18	50.19	74.00	-23.81	peak

- Note: 1. Peak Result = Reading Level + Correct Factor.  
 2. If Peak Result complies with AV limit, AV Result is deemed to comply with AV limit.  
 3. Peak: Peak detector.  
 4. Filter losses were only considered in the spurious frequency bands and the authorized band was not corrected for High Pass Filter losses.  
 5. Proper operation of the transmitter prior to adding the filter to the measurement chain.

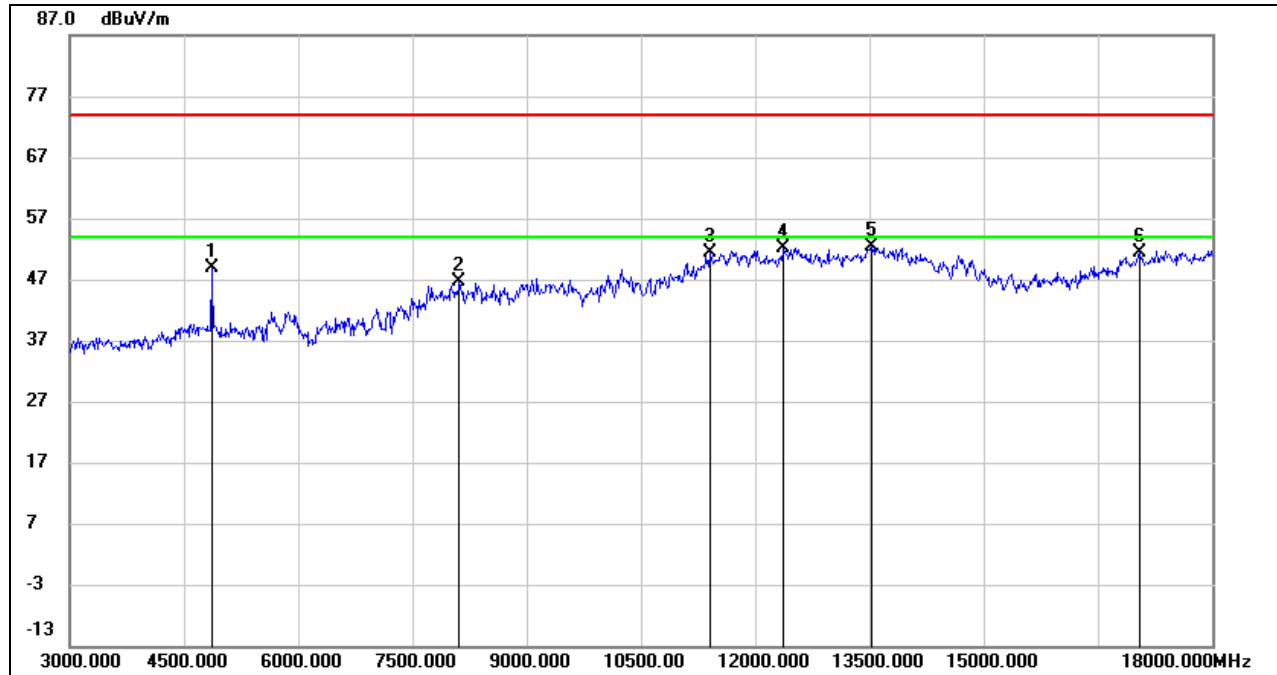
**HARMONICS AND SPURIOUS EMISSIONS (MID CHANNEL, VERTICAL)**

No.	Frequency (MHz)	Reading (dBuV)	Correct (dB/m)	Result (dBuV/m)	Limit (dBuV/m)	Margin (dB)	Remark
1	4873.125	48.90	0.02	48.92	74.00	-25.08	peak
2	8124.375	37.20	9.46	46.66	74.00	-27.34	peak
3	11407.500	34.90	16.38	51.28	74.00	-22.72	peak
4	12384.375	34.82	17.37	52.19	74.00	-21.81	peak
5	13535.625	33.25	19.16	52.41	74.00	-21.59	peak
6	17049.375	31.29	19.97	51.26	74.00	-22.74	peak

Note: 1. Peak Result = Reading Level + Correct Factor.

2. If Peak Result complies with AV limit, AV Result is deemed to comply with AV limit.

3. Peak: Peak detector.

4. Filter losses were only considered in the spurious frequency bands and the authorized band was not corrected for High Pass Filter losses.

5. Proper operation of the transmitter prior to adding the filter to the measurement chain.

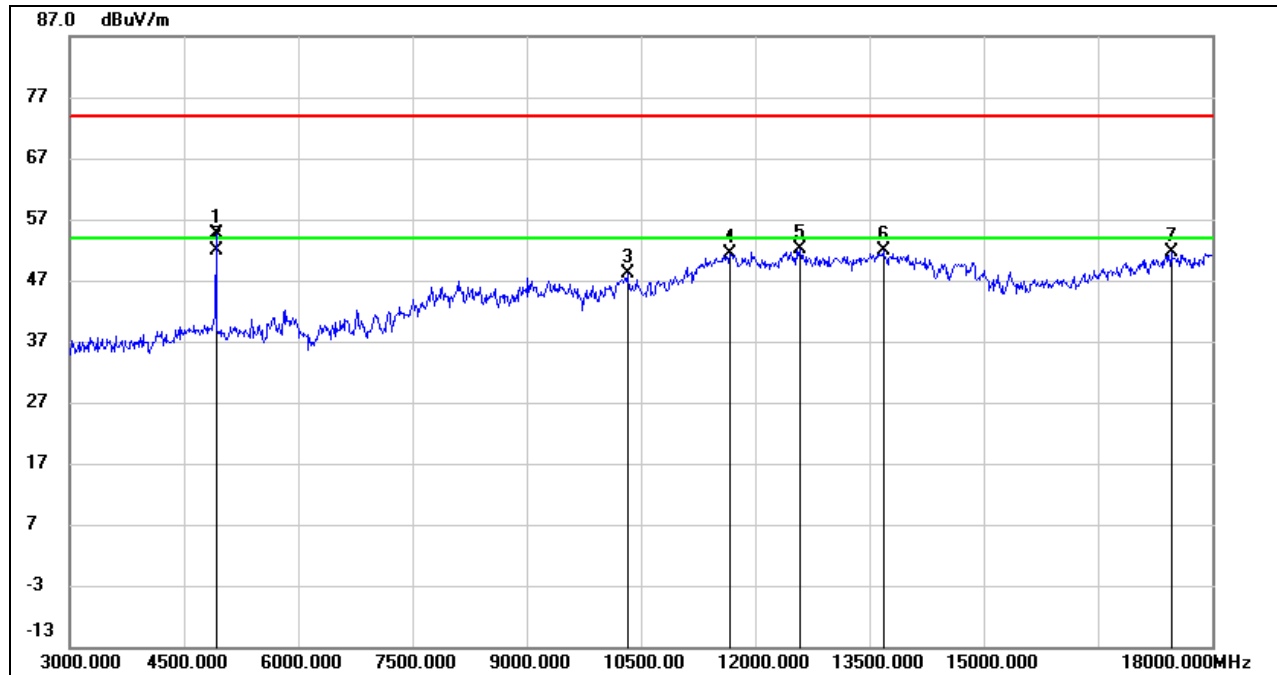
**HARMONICS AND SPURIOUS EMISSIONS (HIGH CHANNEL, HORIZONTAL)**

No.	Frequency (MHz)	Reading (dBuV)	Correct (dB/m)	Result (dBuV/m)	Limit (dBuV/m)	Margin (dB)	Remark
1	4923.750	54.57	0.15	54.72	74.00	-19.28	peak
2	4923.750	51.69	0.15	51.84	54.00	-2.16	AVG
3	10320.000	35.68	12.43	48.11	74.00	-25.89	peak
4	11675.625	34.53	16.96	51.49	74.00	-22.51	peak
5	12594.375	34.94	17.11	52.05	74.00	-21.95	peak
6	13693.125	32.40	19.46	51.86	74.00	-22.14	peak
7	17465.625	30.41	21.21	51.62	74.00	-22.38	peak

Note: 1. Peak Result = Reading Level + Correct Factor.

2. If Peak Result complies with AV limit, AV Result is deemed to comply with AV limit.

3. Peak: Peak detector.

4. Filter losses were only considered in the spurious frequency bands and the authorized band was not corrected for High Pass Filter losses.

5. Proper operation of the transmitter prior to adding the filter to the measurement chain.

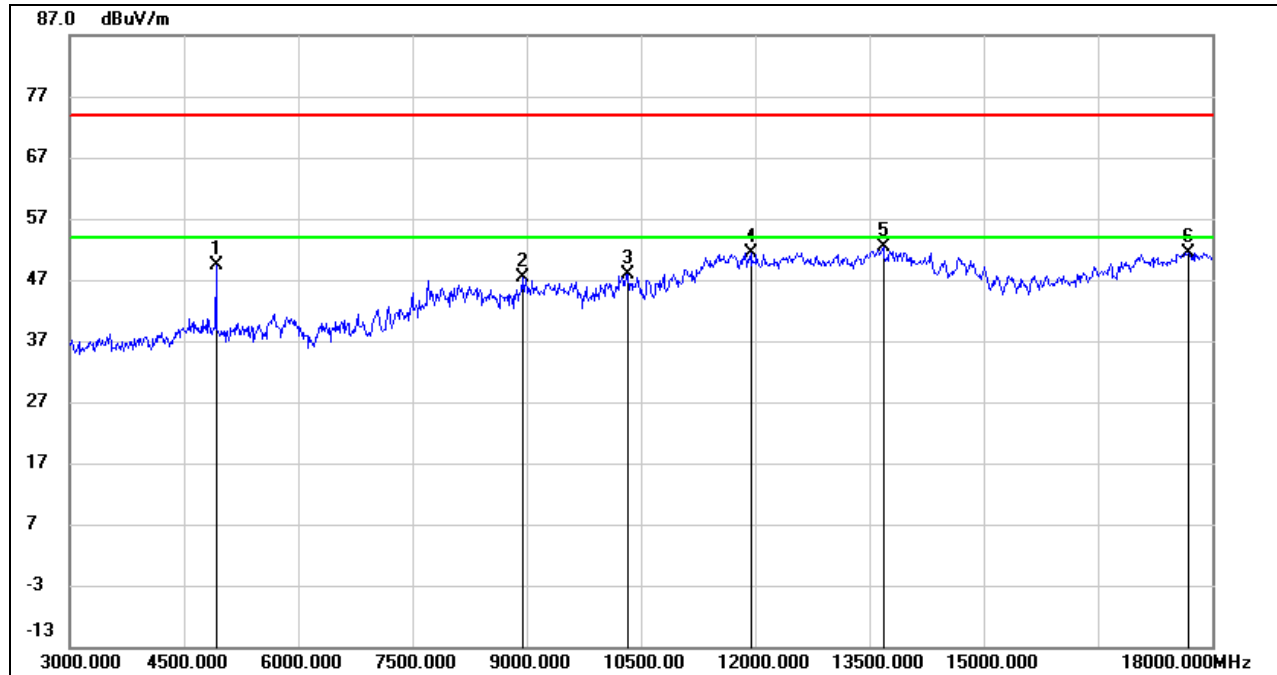
**HARMONICS AND SPURIOUS EMISSIONS (HIGH CHANNEL, VERTICAL)**

No.	Frequency (MHz)	Reading (dBuV)	Correct (dB/m)	Result (dBuV/m)	Limit (dBuV/m)	Margin (dB)	Remark
1	4923.750	49.20	0.15	49.35	74.00	-24.65	peak
2	8949.375	37.48	9.79	47.27	74.00	-26.73	peak
3	10348.125	35.35	12.55	47.90	74.00	-26.10	peak
4	11953.125	34.23	17.25	51.48	74.00	-22.52	peak
5	13683.750	32.88	19.42	52.30	74.00	-21.70	peak
6	17698.125	28.03	23.31	51.34	74.00	-22.66	peak

Note: 1. Peak Result = Reading Level + Correct Factor.

2. If Peak Result complies with AV limit, AV Result is deemed to comply with AV limit.

3. Peak: Peak detector.

4. Filter losses were only considered in the spurious frequency bands and the authorized band was not corrected for High Pass Filter losses.

5. Proper operation of the transmitter prior to adding the filter to the measurement chain.

Note: Both the two antennas had been tested, but only the worst data was recorded in the report.

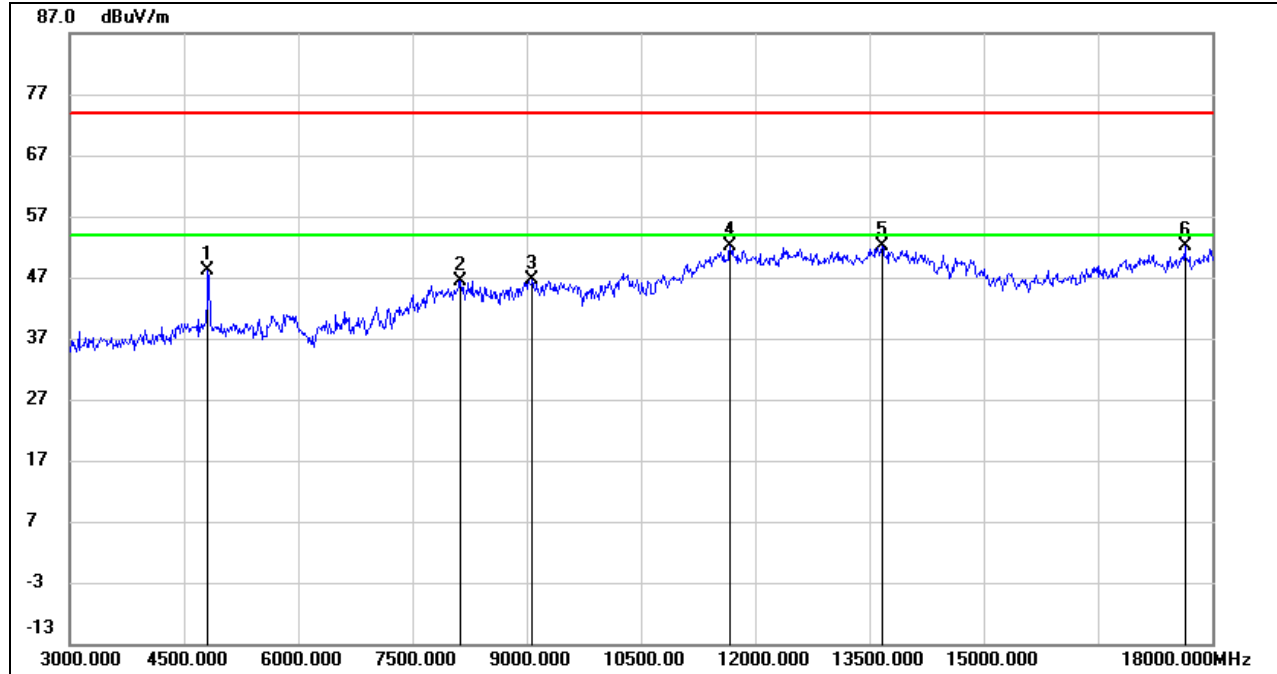
**8.3.2. 802.11g SISO MODE****ANTENNA 2 TEST RESULTS (WORST CASE)****HARMONICS AND SPURIOUS EMISSIONS (LOW CHANNEL, HORIZONTAL)**

No.	Frequency (MHz)	Reading (dBuV)	Correct (dB/m)	Result (dBuV/m)	Limit (dBuV/m)	Margin (dB)	Remark
1	4828.125	48.11	0.11	48.22	74.00	-25.78	peak
2	8131.875	36.95	9.44	46.39	74.00	-27.61	peak
3	9086.250	36.70	9.86	46.56	74.00	-27.44	peak
4	11683.125	35.06	17.01	52.07	74.00	-21.93	peak
5	13674.375	32.66	19.38	52.04	74.00	-21.96	peak
6	17640.000	29.34	22.72	52.06	74.00	-21.94	peak

- Note:
1. Peak Result = Reading Level + Correct Factor.
  2. If Peak Result complies with AV limit, AV Result is deemed to comply with AV limit.
  3. Peak: Peak detector.
  4. AVG:  $VBW=1/Ton$ , where: Ton is the transmitting duration.
  5. For the transmitting duration, please refer to clause 7.1.
  6. Filter losses were only considered in the spurious frequency bands and the authorized band was not corrected for High Pass Filter losses.
  7. Proper operation of the transmitter prior to adding the filter to the measurement chain.

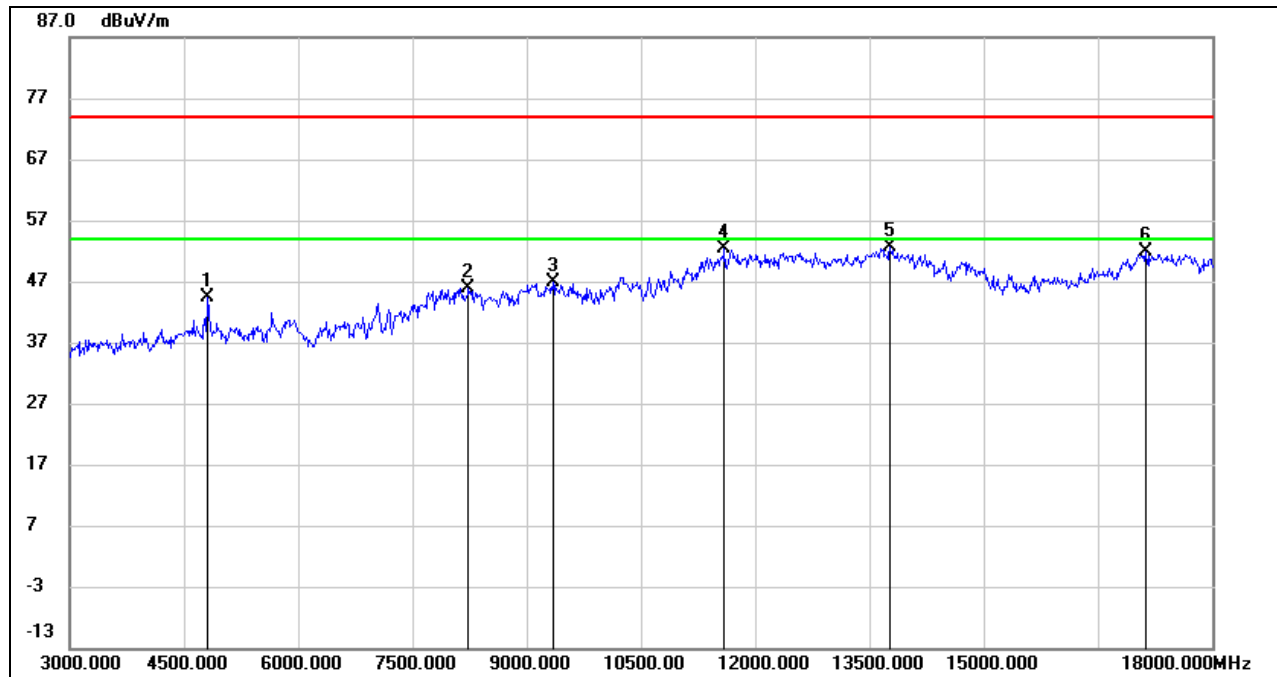
**HARMONICS AND SPURIOUS EMISSIONS (LOW CHANNEL, VERTICAL)**

No.	Frequency (MHz)	Reading (dBuV)	Correct (dB/m)	Result (dBuV/m)	Limit (dBuV/m)	Margin (dB)	Remark
1	4820.625	44.31	0.12	44.43	74.00	-29.57	peak
2	8246.250	36.89	9.10	45.99	74.00	-28.01	peak
3	9345.000	36.35	10.43	46.78	74.00	-27.22	peak
4	11596.875	35.83	16.50	52.33	74.00	-21.67	peak
5	13773.750	33.08	19.44	52.52	74.00	-21.48	peak
6	17133.750	31.36	20.49	51.85	74.00	-22.15	peak

Note: 1. Peak Result = Reading Level + Correct Factor.

2. If Peak Result complies with AV limit, AV Result is deemed to comply with AV limit.

3. Peak: Peak detector.

4. Filter losses were only considered in the spurious frequency bands and the authorized band was not corrected for High Pass Filter losses.

5. Proper operation of the transmitter prior to adding the filter to the measurement chain.

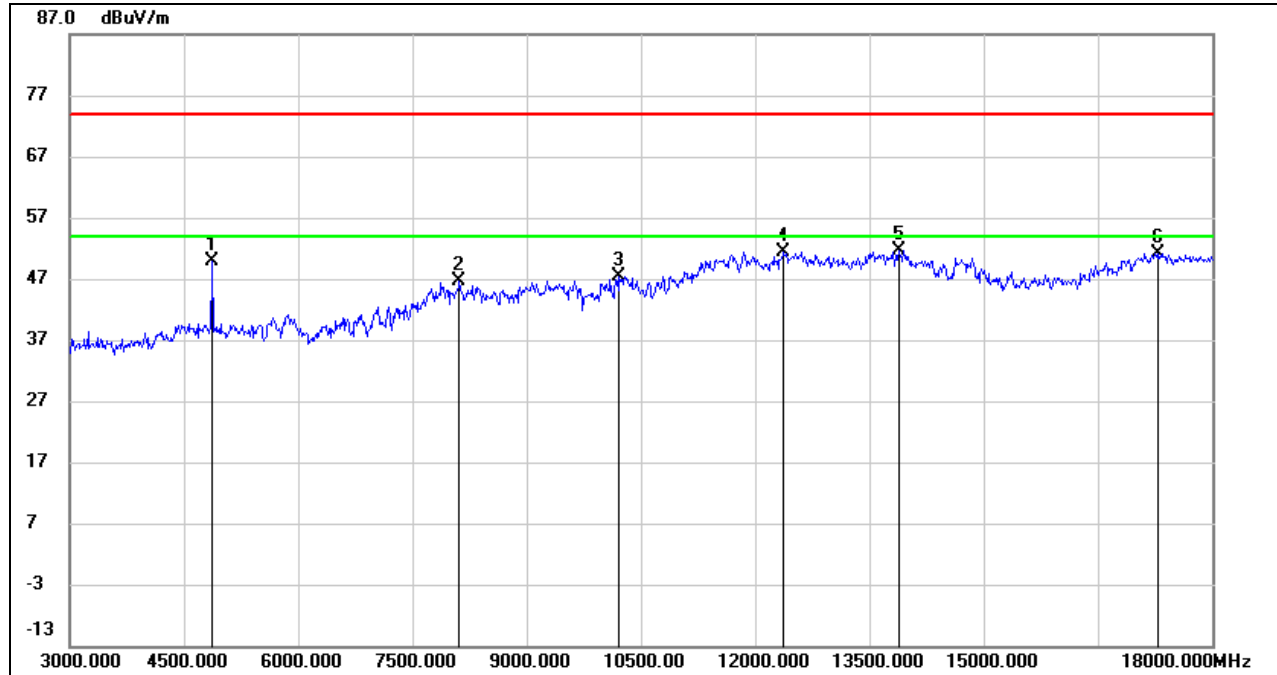

**HARMONICS AND SPURIOUS EMISSIONS (MID CHANNEL, HORIZONTAL)**

No.	Frequency (MHz)	Reading (dBuV)	Correct (dB/m)	Result (dBuV/m)	Limit (dBuV/m)	Margin (dB)	Remark
1	4875.000	49.94	0.02	49.96	74.00	-24.04	peak
2	8122.500	37.09	9.47	46.56	74.00	-27.44	peak
3	10228.125	35.36	12.13	47.49	74.00	-26.51	peak
4	12380.625	33.90	17.37	51.27	74.00	-22.73	peak
5	13890.000	32.45	19.29	51.74	74.00	-22.26	peak
6	17302.500	29.73	21.50	51.23	74.00	-22.77	peak

Note: 1. Peak Result = Reading Level + Correct Factor.

2. If Peak Result complies with AV limit, AV Result is deemed to comply with AV limit.

3. Peak: Peak detector.

4. Filter losses were only considered in the spurious frequency bands and the authorized band was not corrected for High Pass Filter losses.

5. Proper operation of the transmitter prior to adding the filter to the measurement chain.

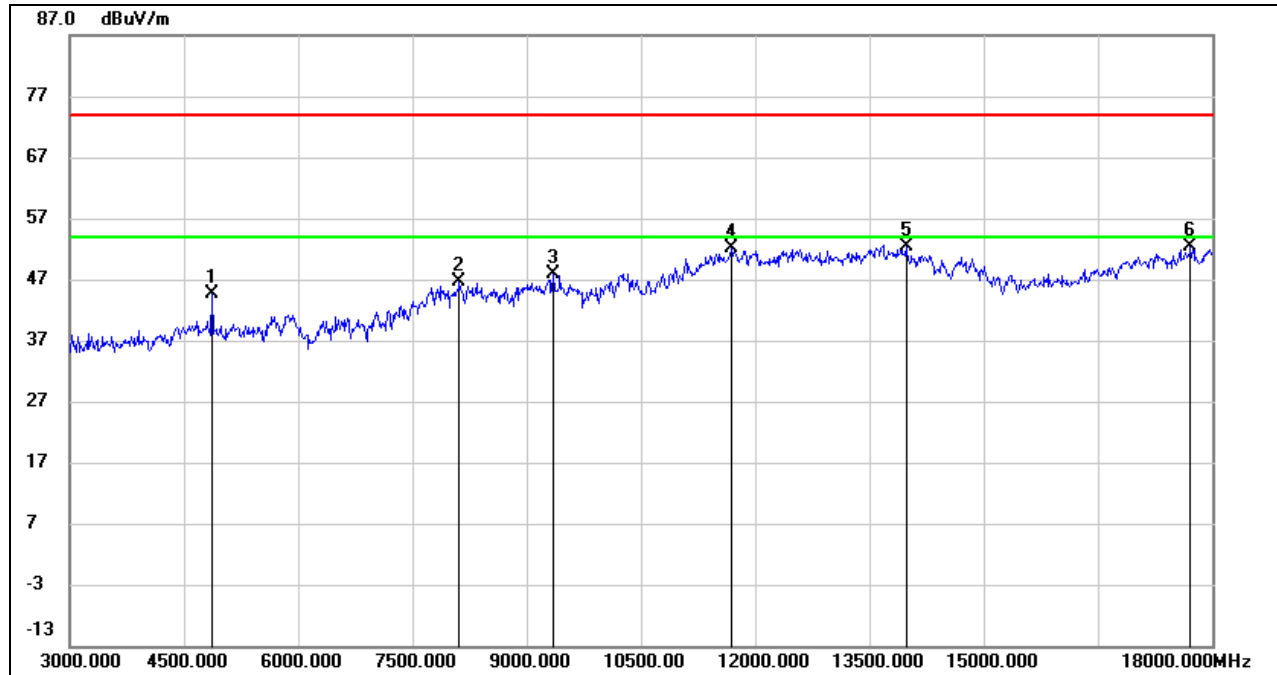
**HARMONICS AND SPURIOUS EMISSIONS (MID CHANNEL, VERTICAL)**

No.	Frequency (MHz)	Reading (dBuV)	Correct (dB/m)	Result (dBuV/m)	Limit (dBuV/m)	Margin (dB)	Remark
1	4873.125	44.56	0.02	44.58	74.00	-29.42	peak
2	8122.500	37.14	9.47	46.61	74.00	-27.39	peak
3	9354.375	37.40	10.49	47.89	74.00	-26.11	peak
4	11688.750	35.05	17.04	52.09	74.00	-21.91	peak
5	13985.625	32.98	19.37	52.35	74.00	-21.65	peak
6	17722.500	28.89	23.53	52.42	74.00	-21.58	peak

- Note: 1. Peak Result = Reading Level + Correct Factor.  
 2. If Peak Result complies with AV limit, AV Result is deemed to comply with AV limit.  
 3. Peak: Peak detector.  
 4. Filter losses were only considered in the spurious frequency bands and the authorized band was not corrected for High Pass Filter losses.  
 5. Proper operation of the transmitter prior to adding the filter to the measurement chain.

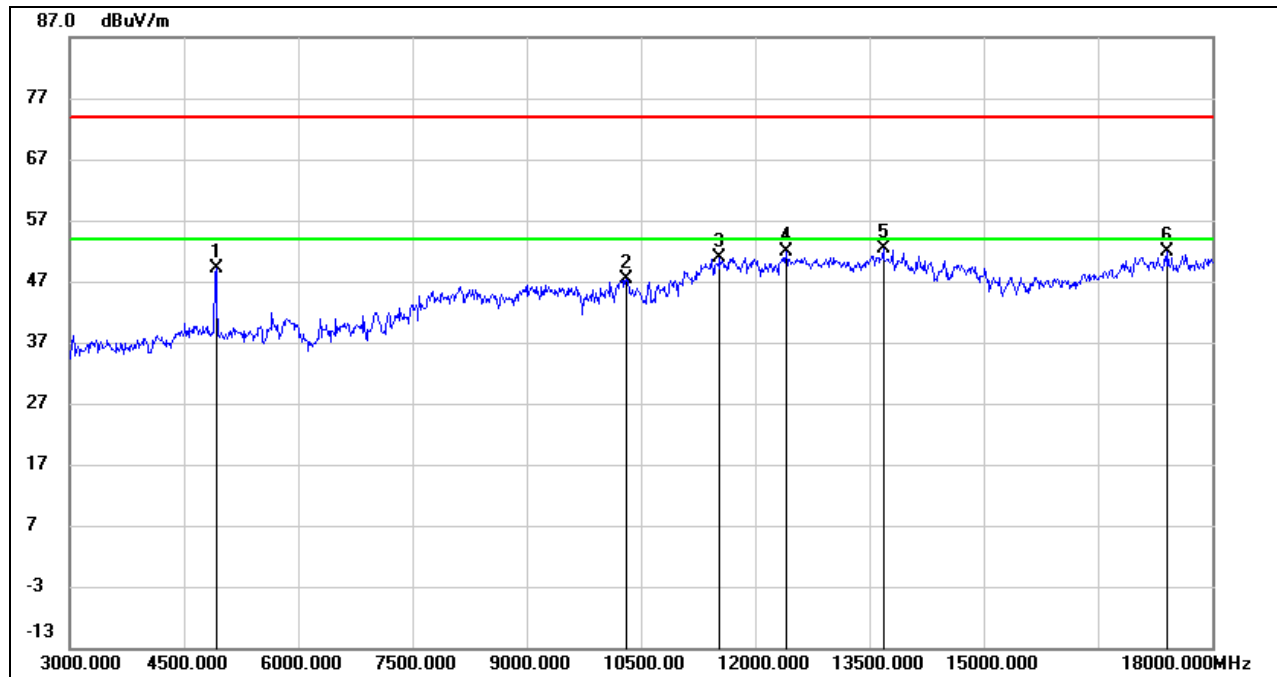
**HARMONICS AND SPURIOUS EMISSIONS (HIGH CHANNEL, HORIZONTAL)**

No.	Frequency (MHz)	Reading (dBuV)	Correct (dB/m)	Result (dBuV/m)	Limit (dBuV/m)	Margin (dB)	Remark
1	4925.625	48.88	0.17	49.05	74.00	-24.95	peak
2	10310.625	35.08	12.39	47.47	74.00	-26.53	peak
3	11548.125	34.46	16.48	50.94	74.00	-23.06	peak
4	12405.000	34.58	17.32	51.90	74.00	-22.10	peak
5	13681.875	32.86	19.41	52.27	74.00	-21.73	peak
6	17426.250	30.86	21.06	51.92	74.00	-22.08	peak

Note: 1. Peak Result = Reading Level + Correct Factor.

2. If Peak Result complies with AV limit, AV Result is deemed to comply with AV limit.

3. Peak: Peak detector.

4. Filter losses were only considered in the spurious frequency bands and the authorized band was not corrected for High Pass Filter losses.

5. Proper operation of the transmitter prior to adding the filter to the measurement chain.

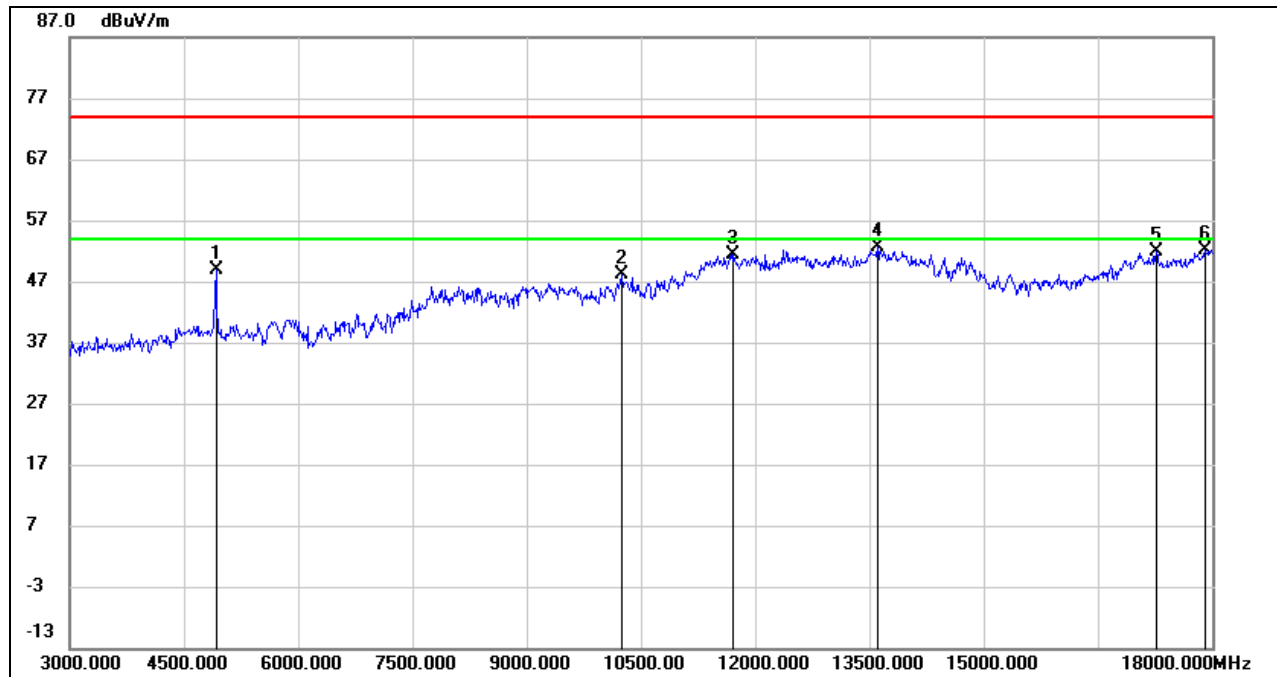
**HARMONICS AND SPURIOUS EMISSIONS (HIGH CHANNEL, VERTICAL)**

No.	Frequency (MHz)	Reading (dBuV)	Correct (dB/m)	Result (dBuV/m)	Limit (dBuV/m)	Margin (dB)	Remark
1	4923.750	48.62	0.15	48.77	74.00	-25.23	peak
2	10250.625	35.88	12.20	48.08	74.00	-25.92	peak
3	11728.125	34.25	17.07	51.32	74.00	-22.68	peak
4	13616.250	33.40	19.11	52.51	74.00	-21.49	peak
5	17265.000	30.64	21.22	51.86	74.00	-22.14	peak
6	17910.000	27.74	24.38	52.12	74.00	-21.88	peak

Note: 1. Peak Result = Reading Level + Correct Factor.

2. If Peak Result complies with AV limit, AV Result is deemed to comply with AV limit.

3. Peak: Peak detector.

4. AVG:  $VBW=1/Ton$ , where: Ton is the transmitting duration.

5. For the transmitting duration, please refer to clause 7.1.

6. Filter losses were only considered in the spurious frequency bands and the authorized band was not corrected for High Pass Filter losses.

7. Proper operation of the transmitter prior to adding the filter to the measurement chain.

Note: Both the two antennas had been tested, but only the worst data was recorded in the report.



### 8.3.3. 802.11n HT20 MIMO MODE

#### HARMONICS AND SPURIOUS EMISSIONS (LOW CHANNEL, HORIZONTAL)

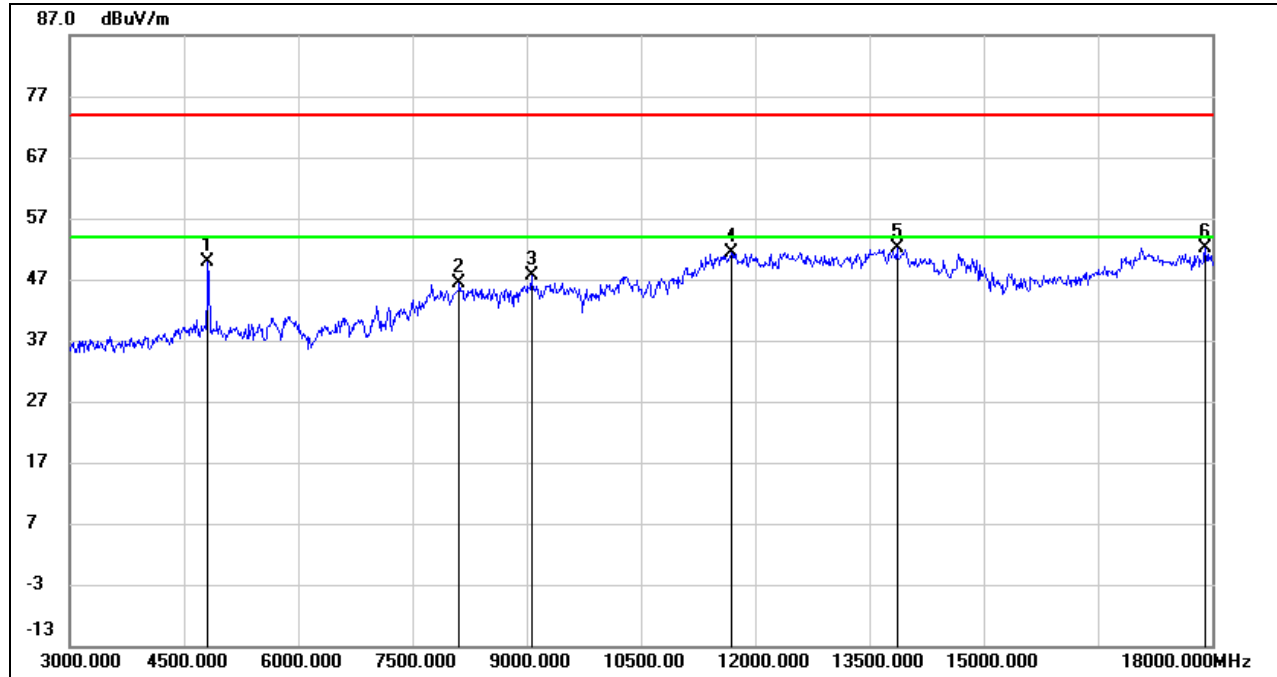

No.	Frequency (MHz)	Reading (dBuV)	Correct (dB/m)	Result (dBuV/m)	Limit (dBuV/m)	Margin (dB)	Remark
1	4824.375	49.66	0.11	49.77	74.00	-24.23	peak
2	8128.125	36.99	9.45	46.44	74.00	-27.56	peak
3	9061.875	37.56	10.12	47.68	74.00	-26.32	peak
4	11696.250	34.28	17.09	51.37	74.00	-22.63	peak
5	13867.500	32.77	19.33	52.10	74.00	-21.90	peak
6	17919.375	27.69	24.44	52.13	74.00	-21.87	peak

- Note: 1. Peak Result = Reading Level + Correct Factor.  
 2. If Peak Result complies with AV limit, AV Result is deemed to comply with AV limit.  
 3. Peak: Peak detector.  
 4. AVG:  $VBW=1/Ton$ , where: Ton is the transmitting duration.  
 5. For the transmitting duration, please refer to clause 7.1.  
 6. Filter losses were only considered in the spurious frequency bands and the authorized band was not corrected for High Pass Filter losses.  
 7. Proper operation of the transmitter prior to adding the filter to the measurement chain.

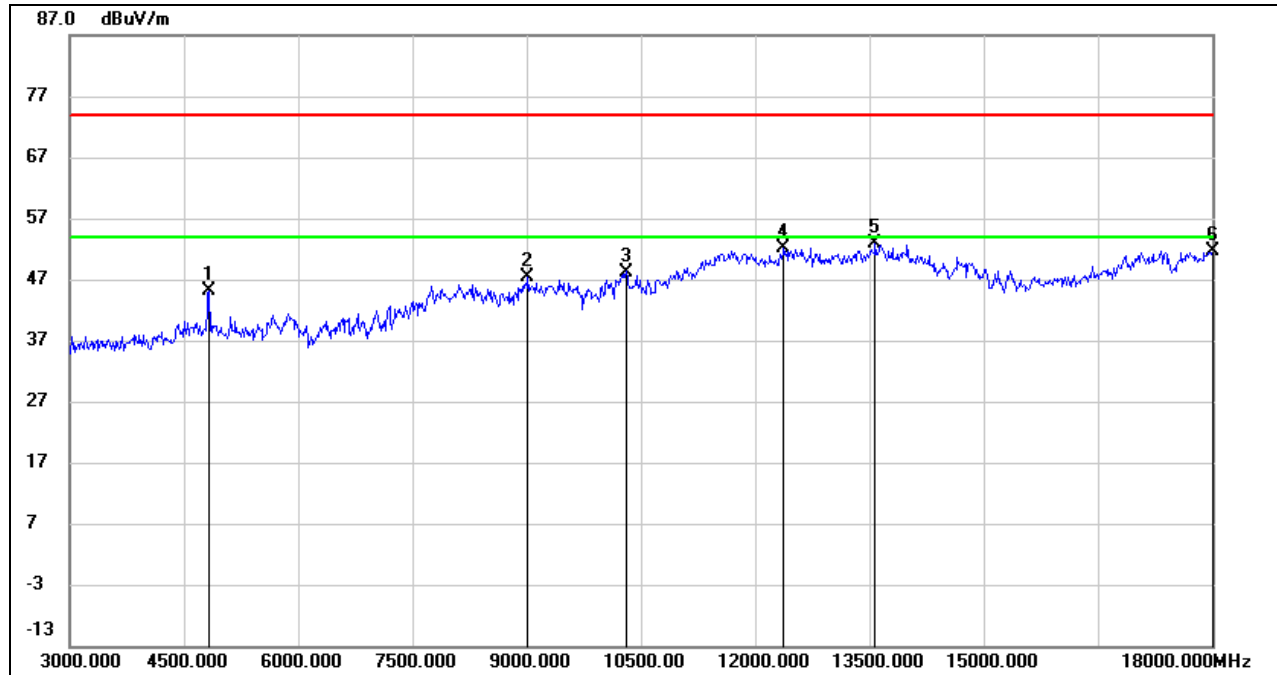
**HARMONICS AND SPURIOUS EMISSIONS (LOW CHANNEL, VERTICAL)**

No.	Frequency (MHz)	Reading (dBuV)	Correct (dB/m)	Result (dBuV/m)	Limit (dBuV/m)	Margin (dB)	Remark
1	4830.000	45.15	0.10	45.25	74.00	-28.75	peak
2	9018.750	36.70	10.57	47.27	74.00	-26.73	peak
3	10305.000	35.88	12.37	48.25	74.00	-25.75	peak
4	12380.625	34.65	17.37	52.02	74.00	-21.98	peak
5	13575.000	33.76	19.08	52.84	74.00	-21.16	peak
6	18000.000	26.60	24.97	51.57	74.00	-22.43	peak

- Note: 1. Peak Result = Reading Level + Correct Factor.  
 2. If Peak Result complies with AV limit, AV Result is deemed to comply with AV limit.  
 3. Peak: Peak detector.  
 4. AVG:  $VBW=1/Ton$ , where: Ton is the transmitting duration.  
 5. For the transmitting duration, please refer to clause 7.1.  
 6. Filter losses were only considered in the spurious frequency bands and the authorized band was not corrected for High Pass Filter losses.  
 7. Proper operation of the transmitter prior to adding the filter to the measurement chain.

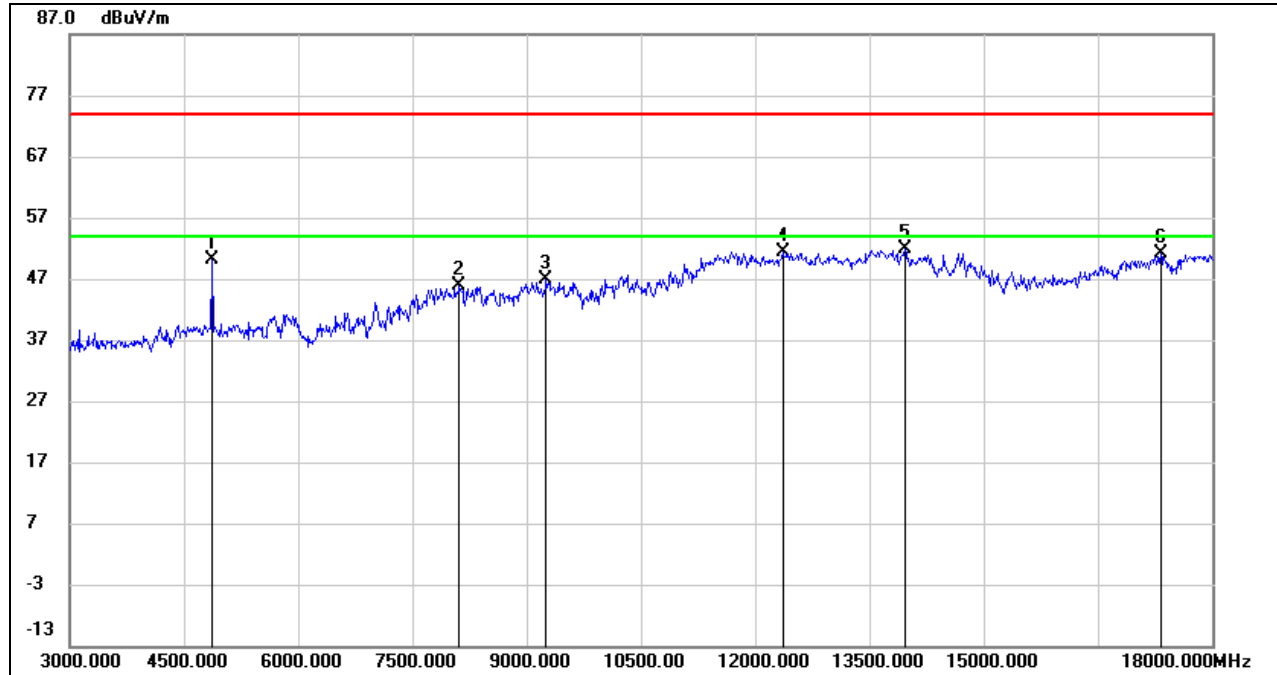
**HARMONICS AND SPURIOUS EMISSIONS (MID CHANNEL, HORIZONTAL)**

No.	Frequency (MHz)	Reading (dBuV)	Correct (dB/m)	Result (dBuV/m)	Limit (dBuV/m)	Margin (dB)	Remark
1	4875.000	50.04	0.02	50.06	74.00	-23.94	peak
2	8122.500	36.37	9.47	45.84	74.00	-28.16	peak
3	9255.000	37.09	9.88	46.97	74.00	-27.03	peak
4	12371.250	34.08	17.40	51.48	74.00	-22.52	peak
5	13965.000	32.61	19.34	51.95	74.00	-22.05	peak
6	17328.750	29.86	21.35	51.21	74.00	-22.79	peak

Note: 1. Peak Result = Reading Level + Correct Factor.

2. If Peak Result complies with AV limit, AV Result is deemed to comply with AV limit.

3. Peak: Peak detector.

4. Filter losses were only considered in the spurious frequency bands and the authorized band was not corrected for High Pass Filter losses.

5. Proper operation of the transmitter prior to adding the filter to the measurement chain.



**HARMONICS AND SPURIOUS EMISSIONS (MID CHANNEL, VERTICAL)**

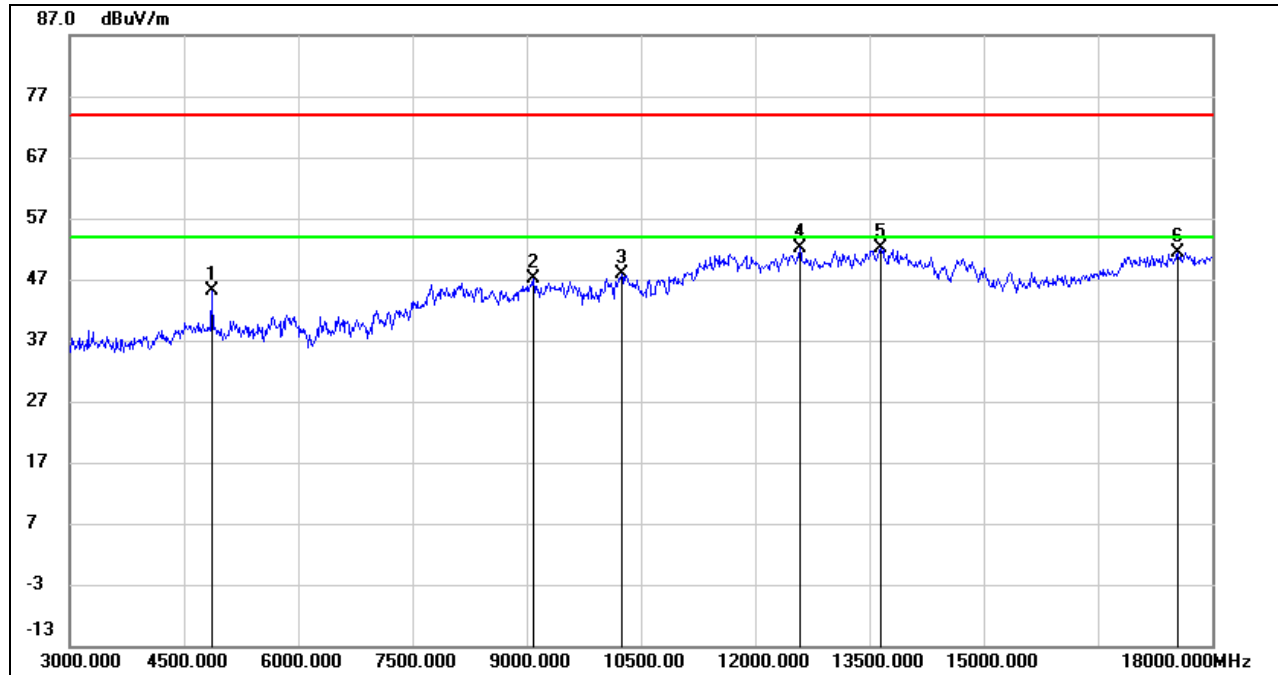

No.	Frequency (MHz)	Reading (dBuV)	Correct (dB/m)	Result (dBuV/m)	Limit (dBuV/m)	Margin (dB)	Remark
1	4869.375	45.14	0.02	45.16	74.00	-28.84	peak
2	9090.000	37.20	9.83	47.03	74.00	-26.97	peak
3	10252.500	35.57	12.21	47.78	74.00	-26.22	peak
4	12594.375	35.12	17.11	52.23	74.00	-21.77	peak
5	13655.625	32.73	19.29	52.02	74.00	-21.98	peak
6	17561.250	29.40	21.94	51.34	74.00	-22.66	peak

- Note: 1. Peak Result = Reading Level + Correct Factor.  
 2. If Peak Result complies with AV limit, AV Result is deemed to comply with AV limit.  
 3. Peak: Peak detector.  
 4. Filter losses were only considered in the spurious frequency bands and the authorized band was not corrected for High Pass Filter losses.  
 5. Proper operation of the transmitter prior to adding the filter to the measurement chain.

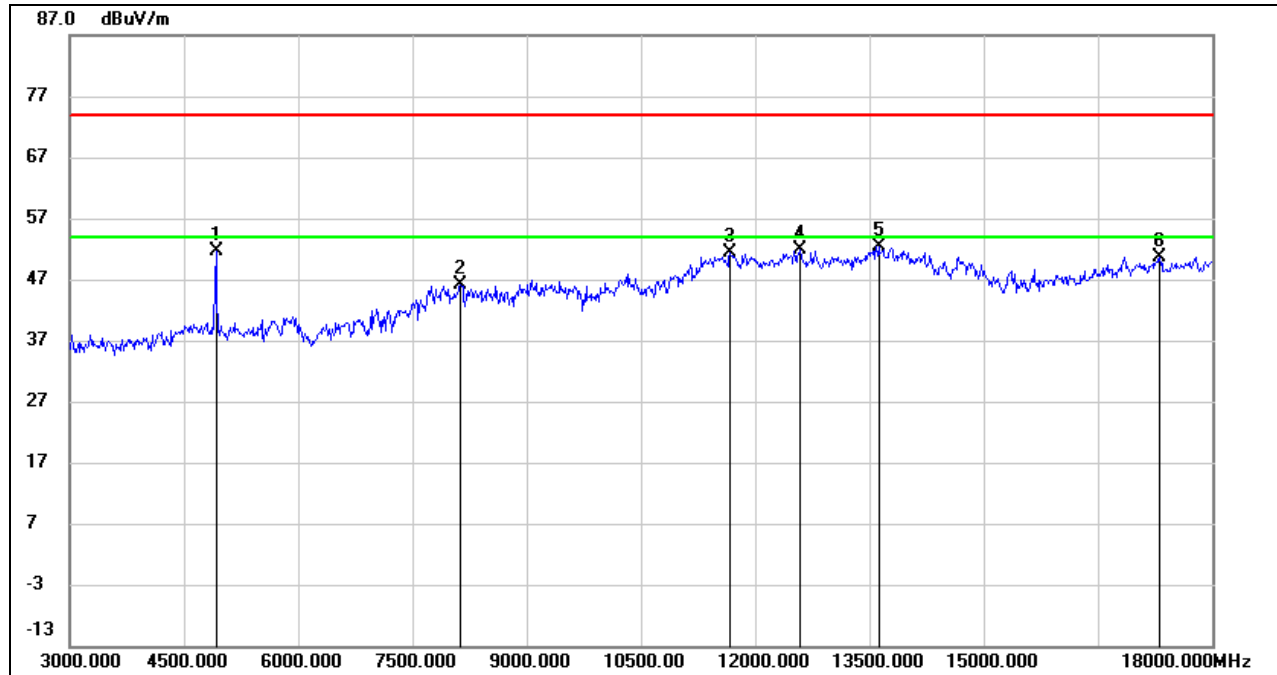

**HARMONICS AND SPURIOUS EMISSIONS (HIGH CHANNEL, HORIZONTAL)**

No.	Frequency (MHz)	Reading (dBuV)	Correct (dB/m)	Result (dBuV/m)	Limit (dBuV/m)	Margin (dB)	Remark
1	4929.375	51.36	0.19	51.55	74.00	-22.45	peak
2	8135.625	36.70	9.43	46.13	74.00	-27.87	peak
3	11681.250	34.51	16.99	51.50	74.00	-22.50	peak
4	12586.875	34.67	17.09	51.76	74.00	-22.24	peak
5	13620.000	33.35	19.12	52.47	74.00	-21.53	peak
6	17310.000	29.19	21.46	50.65	74.00	-23.35	peak

Note: 1. Peak Result = Reading Level + Correct Factor.

2. If Peak Result complies with AV limit, AV Result is deemed to comply with AV limit.

3. Peak: Peak detector.

4. Filter losses were only considered in the spurious frequency bands and the authorized band was not corrected for High Pass Filter losses.

5. Proper operation of the transmitter prior to adding the filter to the measurement chain.

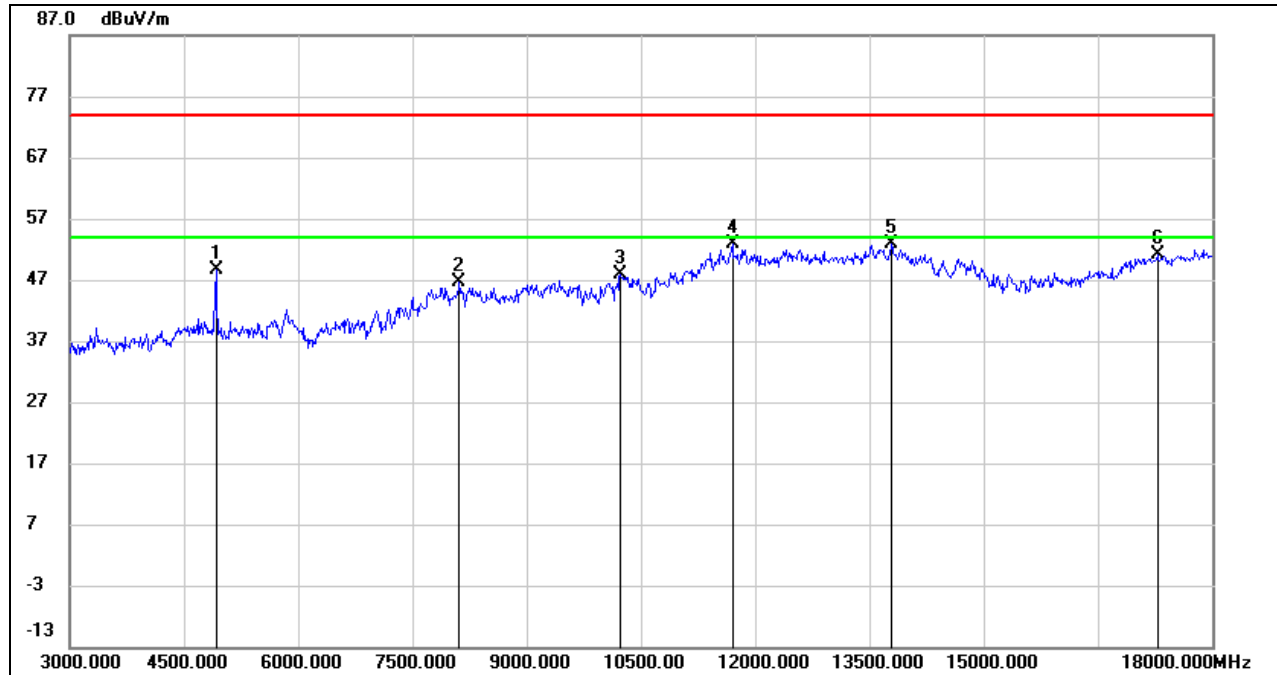
**HARMONICS AND SPURIOUS EMISSIONS (HIGH CHANNEL, VERTICAL)**

No.	Frequency (MHz)	Reading (dBuV)	Correct (dB/m)	Result (dBuV/m)	Limit (dBuV/m)	Margin (dB)	Remark
1	4925.625	48.53	0.17	48.70	74.00	-25.30	peak
2	8118.750	37.15	9.48	46.63	74.00	-27.37	peak
3	10241.250	35.71	12.17	47.88	74.00	-26.12	peak
4	11700.000	35.77	17.11	52.88	74.00	-21.12	peak
5	13788.750	33.46	19.44	52.90	74.00	-21.10	peak
6	17280.000	29.71	21.34	51.05	74.00	-22.95	peak

- Note:
1. Peak Result = Reading Level + Correct Factor.
  2. If Peak Result complies with AV limit, AV Result is deemed to comply with AV limit.
  3. Peak: Peak detector.
  4. AVG:  $VBW=1/Ton$ , where: Ton is the transmitting duration.
  5. For the transmitting duration, please refer to clause 7.1.
  6. Filter losses were only considered in the spurious frequency bands and the authorized band was not corrected for High Pass Filter losses.
  7. Proper operation of the transmitter prior to adding the filter to the measurement chain.



**8.3.4. 802.11n HT40 MIMO MODE**

**HARMONICS AND SPURIOUS EMISSIONS (LOW CHANNEL, HORIZONTAL)**

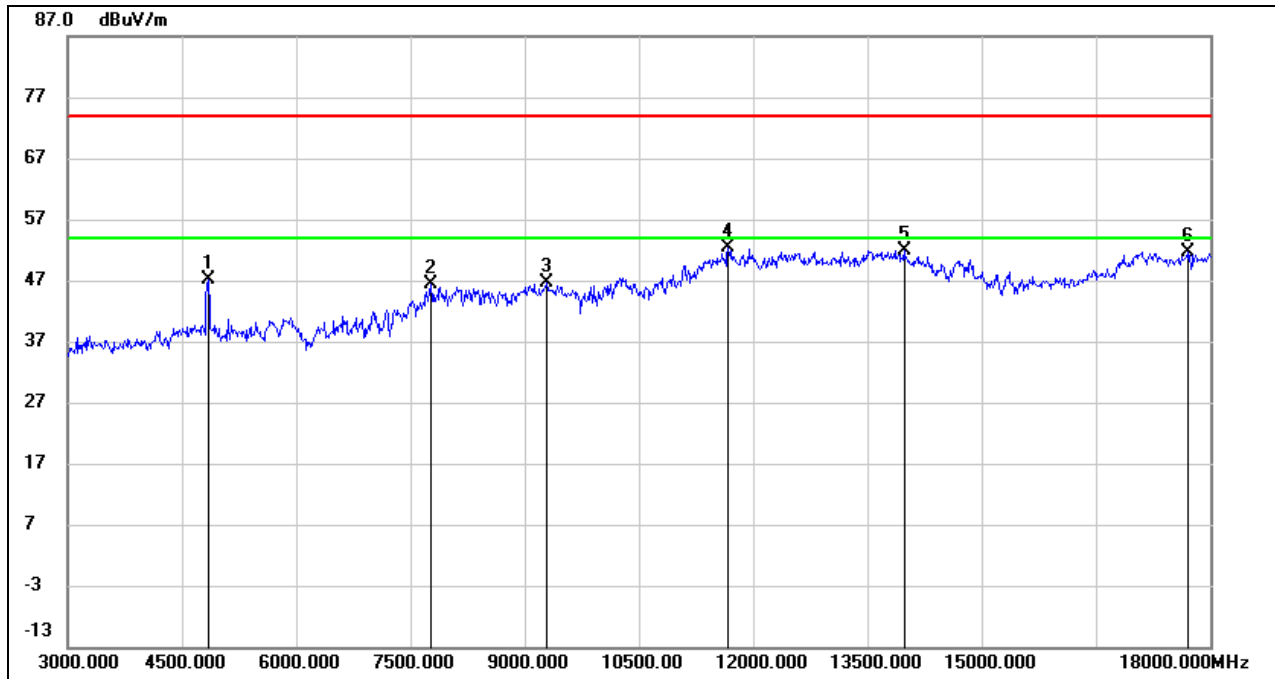

No.	Frequency (MHz)	Reading (dBuV)	Correct (dB/m)	Result (dBuV/m)	Limit (dBuV/m)	Margin (dB)	Remark
1	4846.875	47.06	0.07	47.13	74.00	-26.87	peak
2	7770.000	37.84	8.44	46.28	74.00	-27.72	peak
3	9288.750	36.47	10.07	46.54	74.00	-27.46	peak
4	11681.250	35.51	16.99	52.50	74.00	-21.50	peak
5	13989.375	32.61	19.36	51.97	74.00	-22.03	peak
6	17700.000	28.25	23.33	51.58	74.00	-22.42	peak

- Note: 1. Peak Result = Reading Level + Correct Factor.  
 2. If Peak Result complies with AV limit, AV Result is deemed to comply with AV limit.  
 3. Peak: Peak detector.  
 4. Filter losses were only considered in the spurious frequency bands and the authorized band was not corrected for High Pass Filter losses.  
 5. Proper operation of the transmitter prior to adding the filter to the measurement chain.

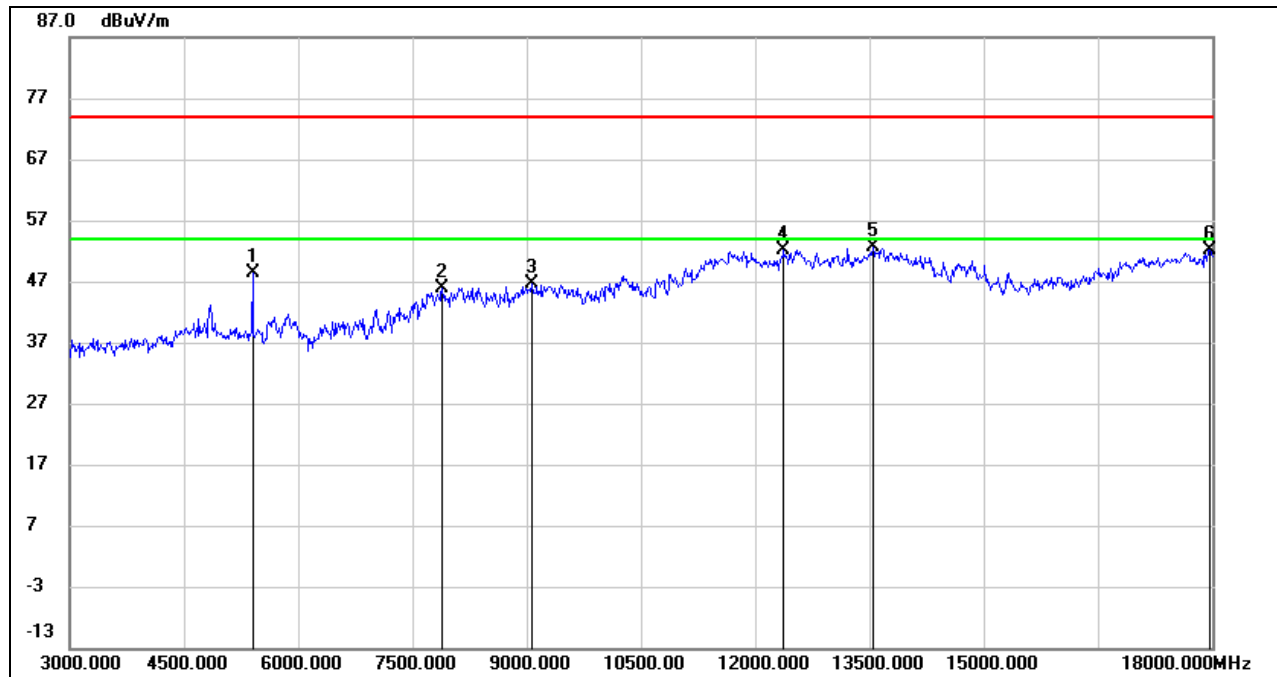
**HARMONICS AND SPURIOUS EMISSIONS (LOW CHANNEL, VERTICAL)**

No.	Frequency (MHz)	Reading (dBuV)	Correct (dB/m)	Result (dBuV/m)	Limit (dBuV/m)	Margin (dB)	Remark
1	5411.250	46.44	1.88	48.32	74.00	-25.68	peak
2	7891.875	37.69	8.28	45.97	74.00	-28.03	peak
3	9084.375	36.74	9.88	46.62	74.00	-27.38	peak
4	12376.875	34.71	17.38	52.09	74.00	-21.91	peak
5	13545.000	33.43	19.13	52.56	74.00	-21.44	peak
6	17975.625	27.36	24.81	52.17	74.00	-21.83	peak

Note: 1. Peak Result = Reading Level + Correct Factor.

2. If Peak Result complies with AV limit, AV Result is deemed to comply with AV limit.

3. Peak: Peak detector.

4. Filter losses were only considered in the spurious frequency bands and the authorized band was not corrected for High Pass Filter losses.

5. Proper operation of the transmitter prior to adding the filter to the measurement chain.

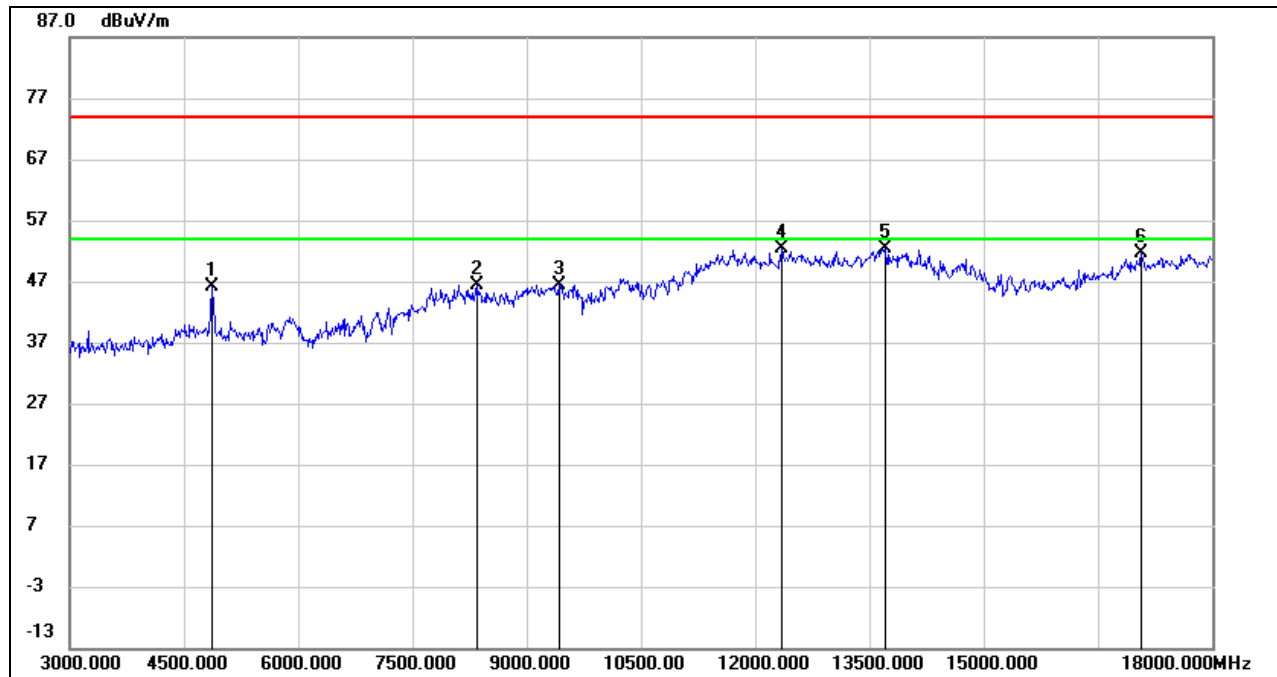
**HARMONICS AND SPURIOUS EMISSIONS (MID CHANNEL, HORIZONTAL)**

No.	Frequency (MHz)	Reading (dBuV)	Correct (dB/m)	Result (dBuV/m)	Limit (dBuV/m)	Margin (dB)	Remark
1	4863.750	46.14	0.03	46.17	74.00	-27.83	peak
2	8341.875	37.56	8.87	46.43	74.00	-27.57	peak
3	9429.375	35.81	10.69	46.50	74.00	-27.50	peak
4	12358.125	34.87	17.43	52.30	74.00	-21.70	peak
5	13710.000	32.85	19.48	52.33	74.00	-21.67	peak
6	17071.875	31.47	20.16	51.63	74.00	-22.37	peak

- Note: 1. Peak Result = Reading Level + Correct Factor.  
 2. If Peak Result complies with AV limit, AV Result is deemed to comply with AV limit.  
 3. Peak: Peak detector.  
 4. Filter losses were only considered in the spurious frequency bands and the authorized band was not corrected for High Pass Filter losses.  
 5. Proper operation of the transmitter prior to adding the filter to the measurement chain.

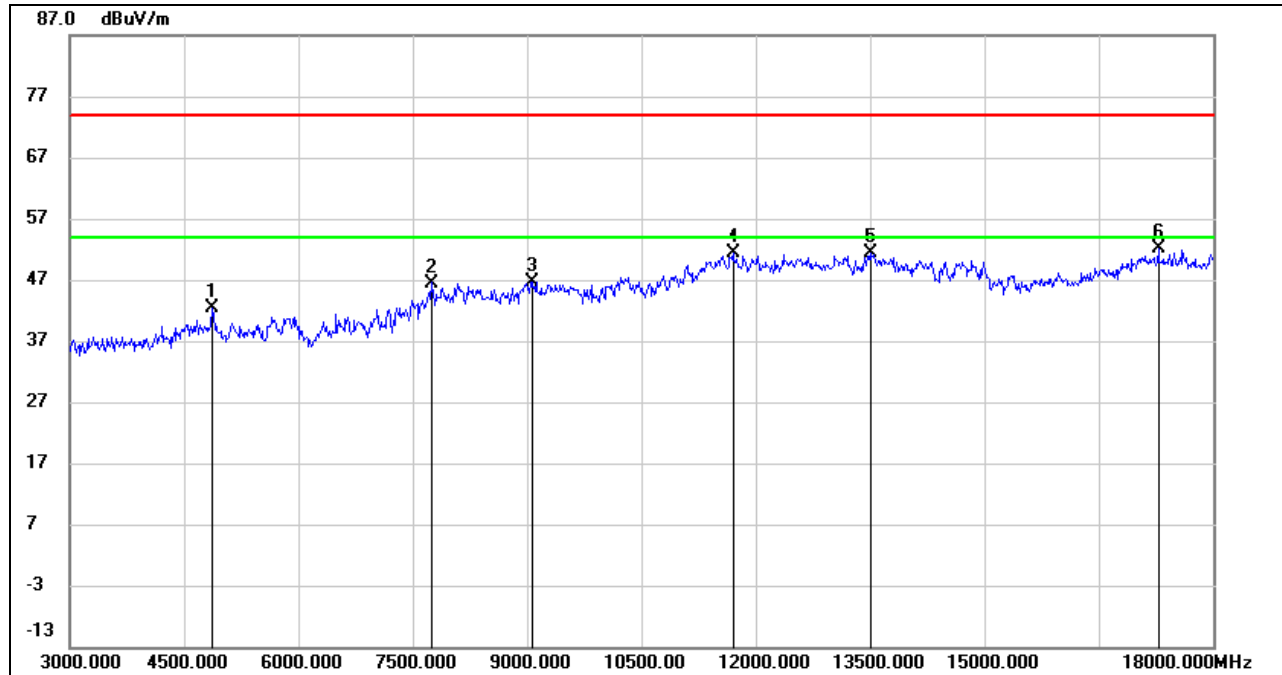
**HARMONICS AND SPURIOUS EMISSIONS (MID CHANNEL, VERTICAL)**

No.	Frequency (MHz)	Reading (dBuV)	Correct (dB/m)	Result (dBuV/m)	Limit (dBuV/m)	Margin (dB)	Remark
1	4867.500	42.43	0.02	42.45	74.00	-31.55	peak
2	7753.125	38.23	8.27	46.50	74.00	-27.50	peak
3	9065.625	36.57	10.08	46.65	74.00	-27.35	peak
4	11711.250	34.22	17.10	51.32	74.00	-22.68	peak
5	13511.250	32.10	19.20	51.30	74.00	-22.70	peak
6	17293.125	30.66	21.45	52.11	74.00	-21.89	peak

- Note: 1. Peak Result = Reading Level + Correct Factor.  
 2. If Peak Result complies with AV limit, AV Result is deemed to comply with AV limit.  
 3. Peak: Peak detector.  
 4. Filter losses were only considered in the spurious frequency bands and the authorized band was not corrected for High Pass Filter losses.  
 5. Proper operation of the transmitter prior to adding the filter to the measurement chain.

**HARMONICS AND SPURIOUS EMISSIONS (HIGH CHANNEL, HORIZONTAL)**

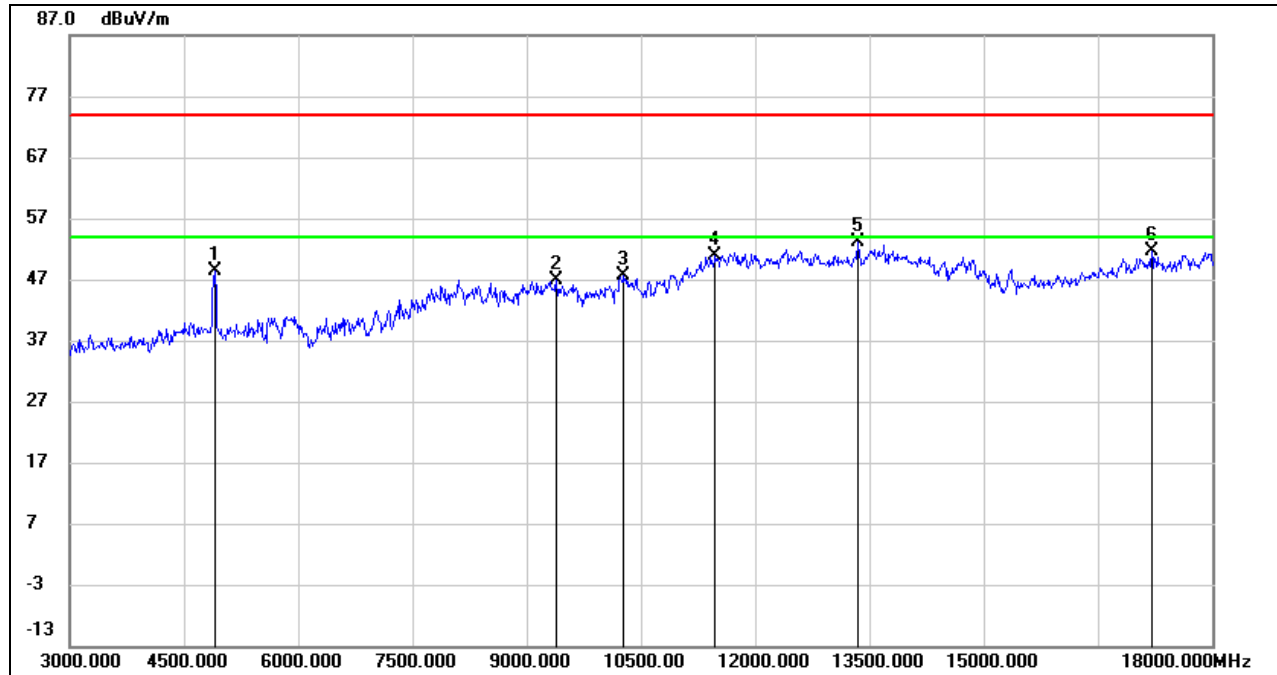

No.	Frequency (MHz)	Reading (dBuV)	Correct (dB/m)	Result (dBuV/m)	Limit (dBuV/m)	Margin (dB)	Remark
1	4908.750	48.41	0.03	48.44	74.00	-25.56	peak
2	9401.250	36.09	10.78	46.87	74.00	-27.13	peak
3	10284.375	35.21	12.30	47.51	74.00	-26.49	peak
4	11480.625	34.35	16.44	50.79	74.00	-23.21	peak
5	13355.625	34.22	18.85	53.07	74.00	-20.93	peak
6	17218.125	30.70	20.84	51.54	74.00	-22.46	peak

- Note: 1. Peak Result = Reading Level + Correct Factor.  
 2. If Peak Result complies with AV limit, AV Result is deemed to comply with AV limit.  
 3. Peak: Peak detector.  
 4. Filter losses were only considered in the spurious frequency bands and the authorized band was not corrected for High Pass Filter losses.  
 5. Proper operation of the transmitter prior to adding the filter to the measurement chain.

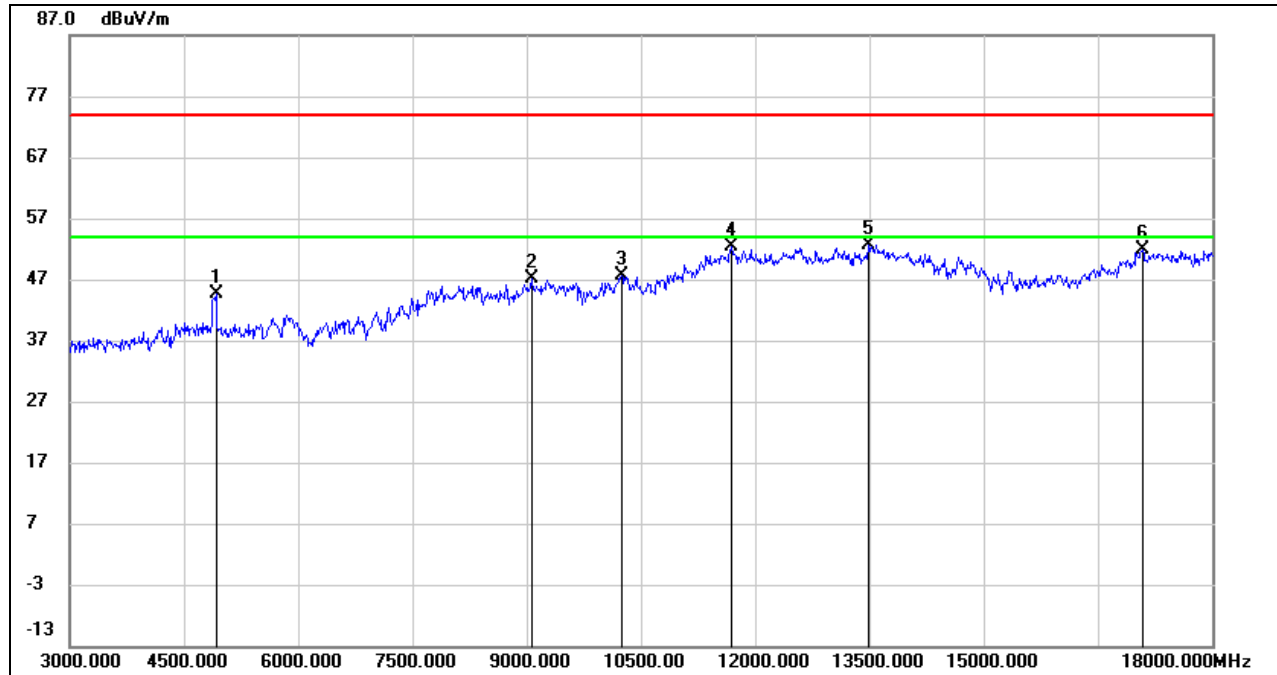
**HARMONICS AND SPURIOUS EMISSIONS (HIGH CHANNEL, VERTICAL)**

No.	Frequency (MHz)	Reading (dBuV)	Correct (dB/m)	Result (dBuV/m)	Limit (dBuV/m)	Margin (dB)	Remark
1	4925.625	44.36	0.17	44.53	74.00	-29.47	peak
2	9067.500	37.09	10.06	47.15	74.00	-26.85	peak
3	10256.250	35.47	12.22	47.69	74.00	-26.31	peak
4	11690.625	35.29	17.05	52.34	74.00	-21.66	peak
5	13498.125	33.48	19.22	52.70	74.00	-21.30	peak
6	17094.375	31.63	20.35	51.98	74.00	-22.02	peak

Note: 1. Peak Result = Reading Level + Correct Factor.

2. If Peak Result complies with AV limit, AV Result is deemed to comply with AV limit.

3. Peak: Peak detector.

4. Filter losses were only considered in the spurious frequency bands and the authorized band was not corrected for High Pass Filter losses.

5. Proper operation of the transmitter prior to adding the filter to the measurement chain.





### 8.5. SPURIOUS EMISSIONS (18 GHz ~ 26 GHz)

#### 8.5.1. 802.11n HT20 MIMO MODE

##### SPURIOUS EMISSIONS (LOW CHANNEL, WORST-CASE CONFIGURATION, HORIZONTAL)

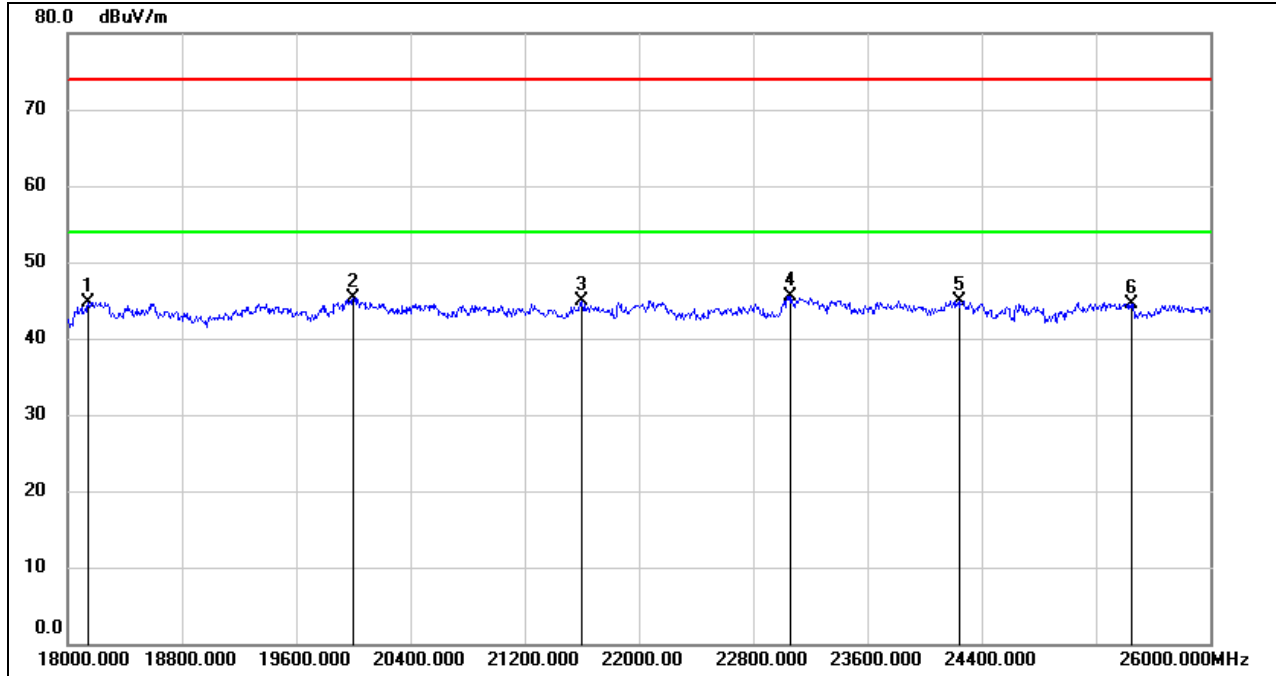

No.	Frequency (MHz)	Reading (dBuV)	Correct (dB/m)	Result (dBuV/m)	Limit (dBuV/m)	Margin (dB)	Remark
1	18144.000	50.27	-5.48	44.79	74.00	-29.21	peak
2	20000.000	50.81	-5.45	45.36	74.00	-28.64	peak
3	21600.000	49.52	-4.54	44.98	74.00	-29.02	peak
4	23064.000	48.99	-3.42	45.57	74.00	-28.43	peak
5	24248.000	47.82	-2.83	44.99	74.00	-29.01	peak
6	25448.000	46.33	-1.76	44.57	74.00	-29.43	peak

- Note: 1. Measurement = Reading Level + Correct Factor.  
 2. If Peak Result complies with AV limit, AV Result is deemed to comply with AV limit.  
 3. Peak: Peak detector.

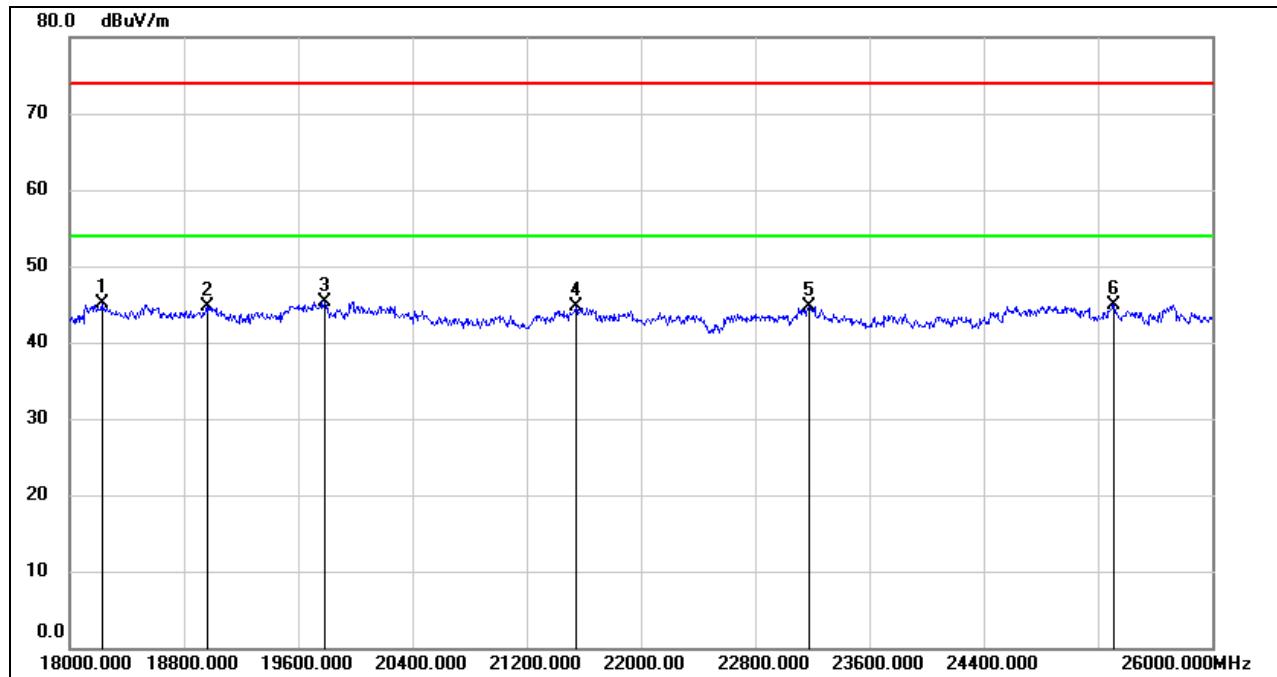
**SPURIOUS EMISSIONS (LOW CHANNEL, WORST-CASE CONFIGURATION, VERTICAL)**

No.	Frequency (MHz)	Reading (dBuV)	Correct (dB/m)	Result (dBuV/m)	Limit (dBuV/m)	Margin (dB)	Remark
1	18224.000	50.58	-5.53	45.05	74.00	-28.95	peak
2	18960.000	50.01	-5.25	44.76	74.00	-29.24	peak
3	19784.000	50.57	-5.28	45.29	74.00	-28.71	peak
4	21544.000	49.26	-4.63	44.63	74.00	-29.37	peak
5	23176.000	48.03	-3.39	44.64	74.00	-29.36	peak
6	25312.000	46.70	-1.70	45.00	74.00	-29.00	peak

- Note: 1. Measurement = Reading Level + Correct Factor.  
 2. If Peak Result complies with AV limit, AV Result is deemed to comply with AV limit.  
 3. Peak: Peak detector.

Note: All modes, channels and antenna have been tested, only the worst data was recorded in the report.

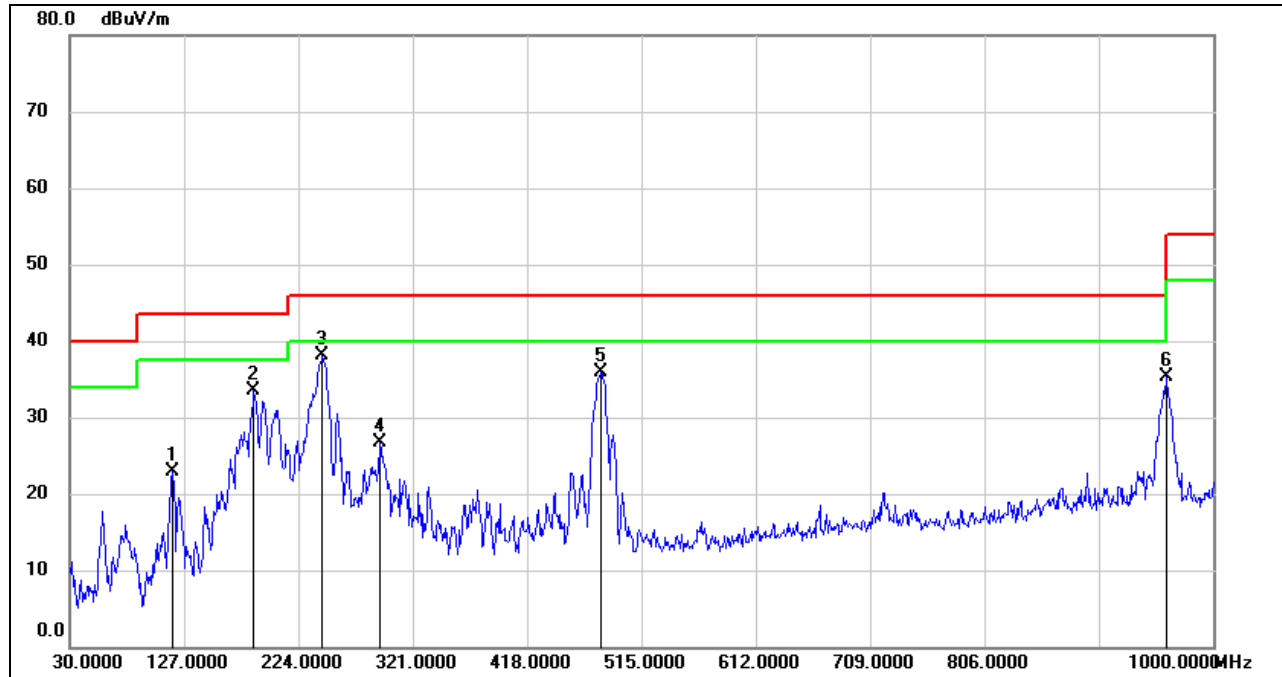
**8.6. SPURIOUS EMISSIONS (30 MHz ~ 1 GHz)****8.6.1. 802.11n HT20 MIMO MODE****ANTENNA 1 TEST RESULTS (WORST CASE)****SPURIOUS EMISSIONS (LOW CHANNEL, WORST-CASE CONFIGURATION, HORIZONTAL)**

No.	Frequency (MHz)	Reading (dBuV)	Correct (dB/m)	Result (dBuV/m)	Limit (dBuV/m)	Margin (dB)	Remark
1	117.3000	42.85	-20.03	22.82	43.50	-20.68	QP
2	186.1700	50.16	-16.72	33.44	43.50	-10.06	QP
3	244.3700	57.26	-19.07	38.19	46.00	-7.81	QP
4	292.8700	42.39	-15.73	26.66	46.00	-19.34	QP
5	480.0800	47.68	-11.79	35.89	46.00	-10.11	QP
6	960.2300	39.77	-4.54	35.23	54.00	-18.77	QP

- Note: 1. Result Level = Read Level + Correct Factor.  
 2. If Peak Result complies with QP limit, QP Result is deemed to comply with QP limit.  
 3. Test setup: RBW: 120 kHz, VBW: 300 kHz, Sweep time: auto.

**SPURIOUS EMISSIONS (LOW CHANNEL, WORST-CASE CONFIGURATION, VERTICAL)**

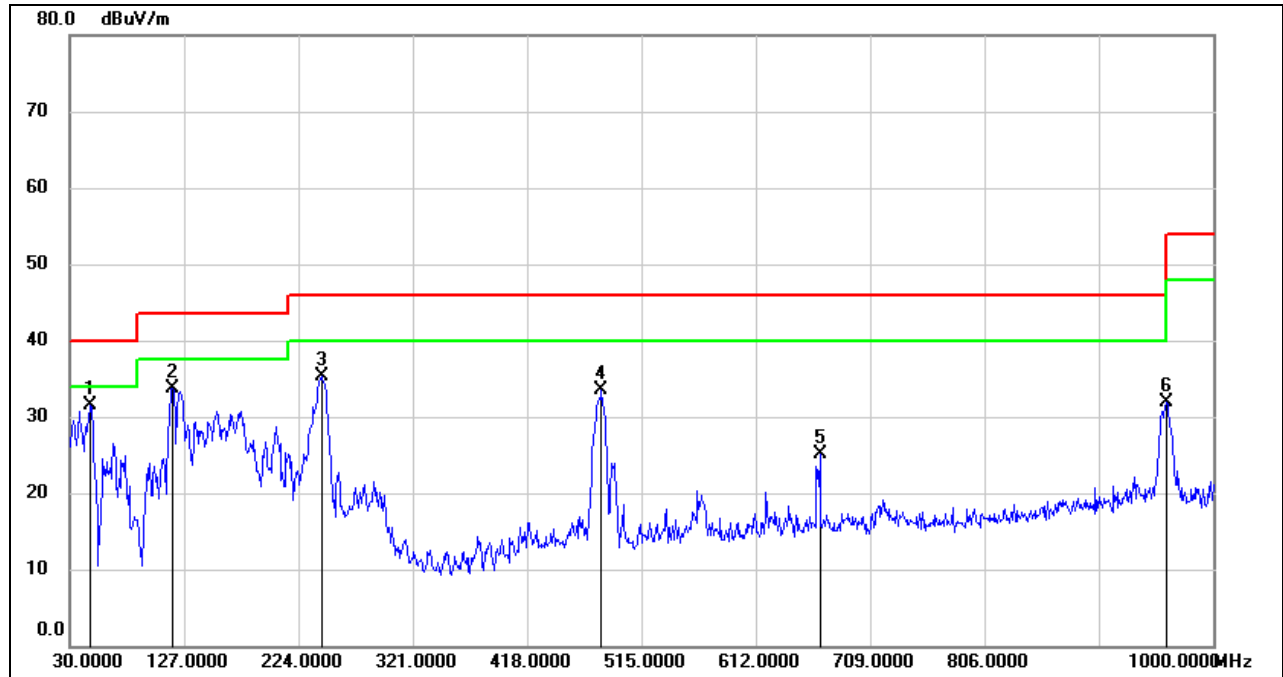

No.	Frequency (MHz)	Reading (dBuV)	Correct (dB/m)	Result (dBuV/m)	Limit (dBuV/m)	Margin (dB)	Remark
1	47.4600	51.96	-20.55	31.41	40.00	-8.59	QP
2	117.3000	53.69	-20.03	33.66	43.50	-9.84	QP
3	243.4000	54.42	-19.08	35.34	46.00	-10.66	QP
4	481.0500	45.19	-11.78	33.41	46.00	-12.59	QP
5	666.3200	33.73	-8.65	25.08	46.00	-20.92	QP
6	960.2300	36.48	-4.54	31.94	54.00	-22.06	QP

- Note: 1. Result Level = Read Level + Correct Factor.  
 2. If Peak Result complies with QP limit, QP Result is deemed to comply with QP limit.  
 3. Test setup: RBW: 120 kHz, VBW: 300 kHz, Sweep time: auto

Note: All modes, channels and antenna have been tested, only the worst data was recorded in the report.



## 8.7. SPURIOUS EMISSIONS BELOW 30 MHz

### 8.7.1. 802.11n HT20 MIMO MODE

#### ANTENNA 1 TEST RESULTS (WORST CASE)

#### SPURIOUS EMISSIONS (LOW CHANNEL, LOOP ANTENNA FACE ON TO THE EUT, WORST-CASE CONFIGURATION)

9 kHz~ 150 kHz

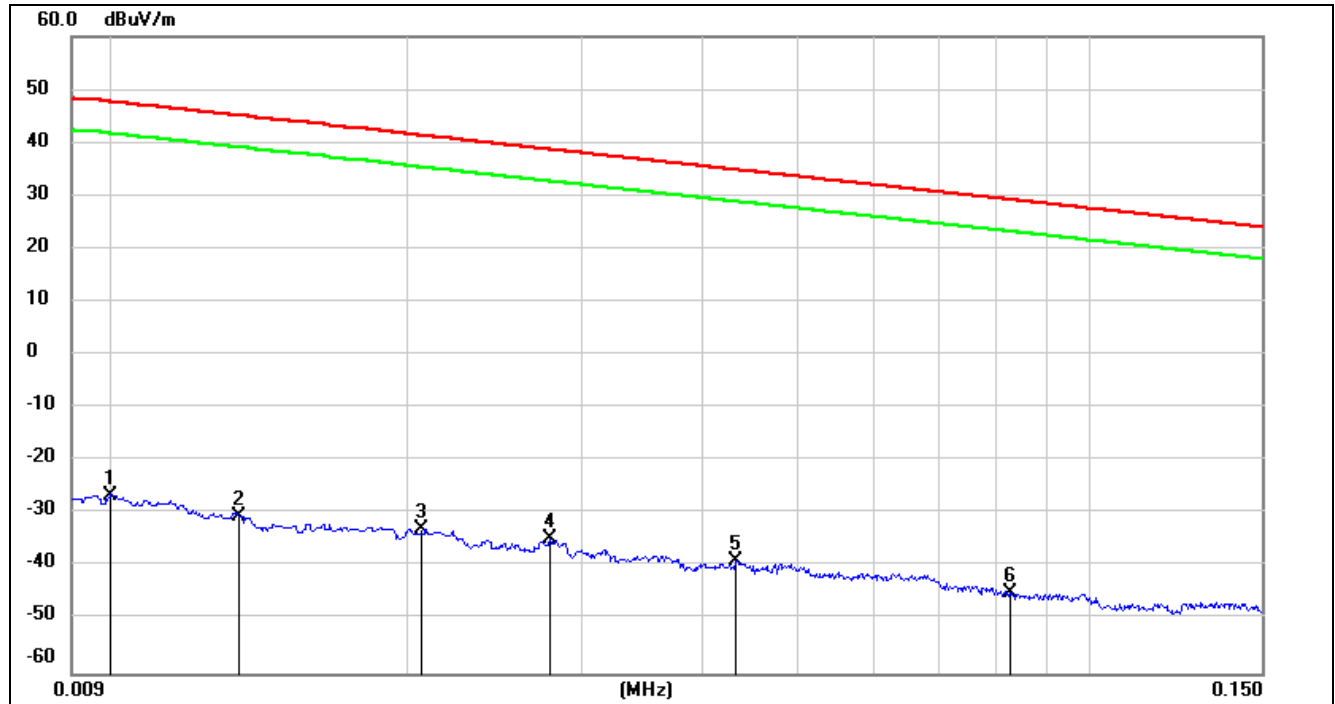

No.	Frequency (MHz)	Reading (dBuV)	Correct (dB/m)	FCC Result (dBuV/m)	FCC Limit (dBuV/m)	ISED Result (dBuA/m)	ISED Limit (dBuA/m)	Margin (dB)	Remark
1	0.0100	74.72	-101.40	-26.68	47.6	-78.18	-3.90	-74.28	peak
2	0.0134	70.84	-101.39	-30.55	45.06	-82.05	-6.44	-75.61	peak
3	0.0206	68.42	-101.35	-32.93	41.32	-84.43	-10.18	-74.25	peak
4	0.0279	66.67	-101.38	-34.71	38.69	-86.21	-12.81	-73.40	peak
5	0.0432	62.57	-101.45	-38.88	34.89	-90.38	-16.61	-73.77	peak
6	0.0826	56.82	-101.65	-44.83	29.26	-96.33	-22.24	-74.09	peak

Note: 1. Measurement = Reading Level + Correct Factor (dBuA/m= dBuV/m- 20Log<sub>10</sub>[120π] = dBuV/m- 51.5).

2. If Peak Result complies with AV and QP limit, AV and QP Result are deemed to comply with AV limit.

3. All 3 polarizations (Horizontal, Face-on and Face-off) of the loop antenna had been tested, but only the worst data recorded in the report.



**150 kHz ~ 490 kHz**

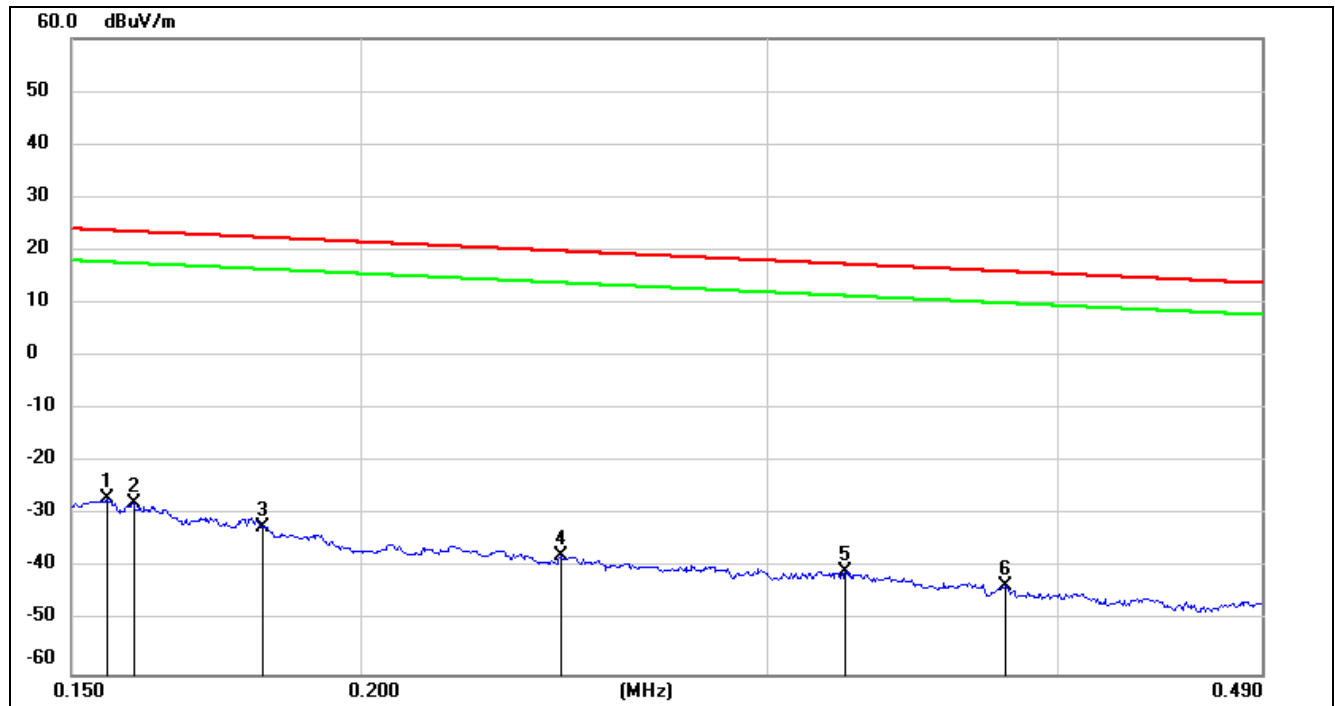

No.	Frequency (MHz)	Reading (dBuV)	Correct (dB/m)	FCC Result (dBuV/m)	FCC Limit (dBuV/m)	ISED Result (dBuA/m)	ISED Limit (dBuA/m)	Margin (dB)	Remark
1	0.1554	74.77	-101.65	-26.88	23.77	-78.38	-27.73	-50.65	peak
2	0.1595	73.86	-101.65	-27.79	23.55	-79.29	-27.95	-51.34	peak
3	0.1816	69.54	-101.68	-32.14	22.42	-83.64	-29.08	-54.56	peak
4	0.2442	64.03	-101.79	-37.76	19.85	-89.26	-31.65	-57.61	peak
5	0.3240	61.37	-101.88	-40.51	17.39	-92.01	-34.11	-57.90	peak
6	0.3800	58.52	-101.94	-43.42	16.01	-94.92	-35.49	-59.43	peak

Note: 1. Measurement = Reading Level + Correct Factor (dBuA/m= dBuV/m- 20Log10[120π] = dBuV/m- 51.5).

2. If Peak Result complies with AV and QP limit, AV and QP Result are deemed to comply with AV limit.

3. All 3 polarizations (Horizontal, Face-on and Face-off) of the loop antenna had been tested, but only the worst data recorded in the report.



490 kHz ~ 30 MHz

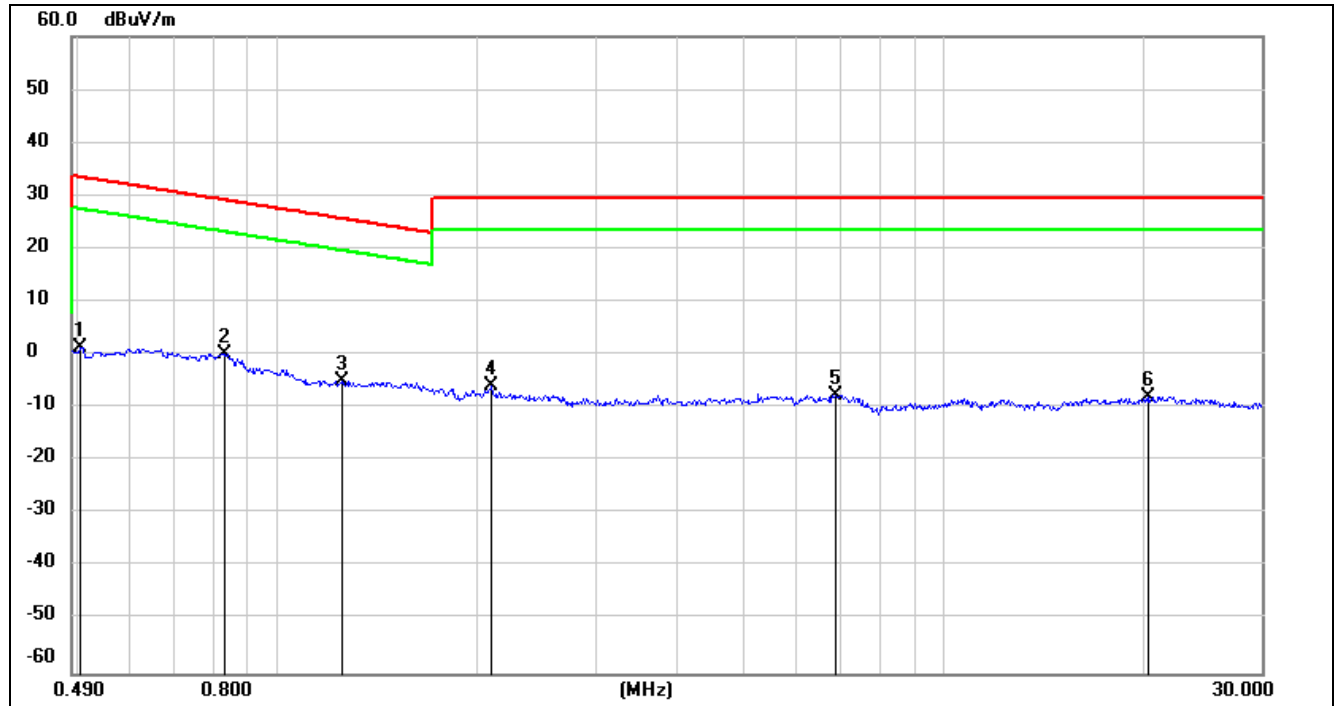

No.	Frequency (MHz)	Reading (dBuV)	Correct (dB/m)	FCC Result (dBuV/m)	FCC Limit (dBuV/m)	ISED Result (dBuA/m)	ISED Limit (dBuA/m)	Margin (dB)	Remark
1	0.5039	63.43	-62.07	1.36	33.56	-50.14	-17.94	-32.20	peak
2	0.8296	62.44	-62.17	0.27	29.23	-51.23	-22.27	-28.96	peak
3	1.2459	57.25	-62.16	-4.91	25.7	-56.41	-25.80	-30.61	peak
4	2.0939	55.89	-61.79	-5.9	29.54	-57.40	-21.96	-35.44	peak
5	6.8936	53.59	-61.22	-7.63	29.54	-59.13	-21.96	-37.17	peak
6	20.3501	52.84	-60.80	-7.96	29.54	-59.46	-21.96	-37.50	peak

Note: 1. Measurement = Reading Level + Correct Factor (dBuA/m= dBuV/m- 20Log10[120π] = dBuV/m- 51.5).

2. If Peak Result complies with AV and QP limit, AV and QP Result are deemed to comply with AV limit.

3. All 3 polarizations (Horizontal, Face-on and Face-off) of the loop antenna had been tested, but only the worst data recorded in the report.

Note: All modes, channels and antenna have been tested, only the worst data was recorded in the report.

## 9. AC POWER LINE CONDUCTED EMISSIONS

### LIMITS

Please refer to CFR 47 FCC §15.207 (a) and ISED RSS-Gen Clause 8.8

FREQUENCY (MHz)	Quasi-peak	Average
0.15 -0.5	66 - 56 *	56 - 46 *
0.50 -5.0	56.00	46.00
5.0 -30.0	60.00	50.00

### TEST SETUP AND PROCEDURE

Refer to ANSI C63.10-2013 clause 6.2.

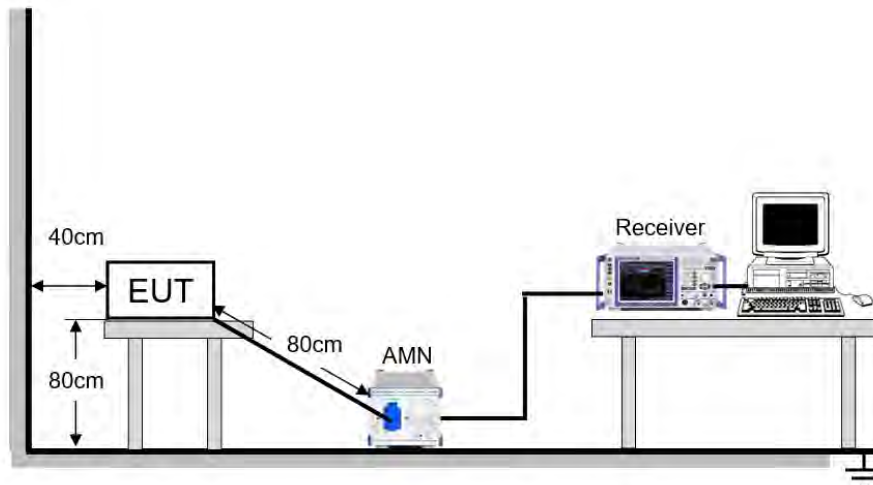

The EUT is put on a table of non-conducting material that is 80 cm high. The vertical conducting wall of shielding is located 40 cm to the rear of the EUT. The power line of the EUT is connected to the AC mains through a Artificial Mains Network (A.M.N.). A EMI Measurement Receiver (R&S Test Receiver ESR3) is used to test the emissions from both sides of AC line. According to the requirements in Section 6.2 of ANSI C63.10-2013. Conducted emissions from the EUT measured in the frequency range between 0.15 MHz and 30 MHz using CISPR Quasi-Peak and average detector mode. The bandwidth of EMI test receiver is set at 9 kHz.

The arrangement of the equipment is installed to meet the standards and operating in a manner, which tends to maximize its emission characteristics in a normal application.

### TEST ENVIRONMENT

Temperature	24.3 °C	Relative Humidity	69.1 %
Atmosphere Pressure	101 kPa	Test Voltage	AC 120 V, 60 Hz

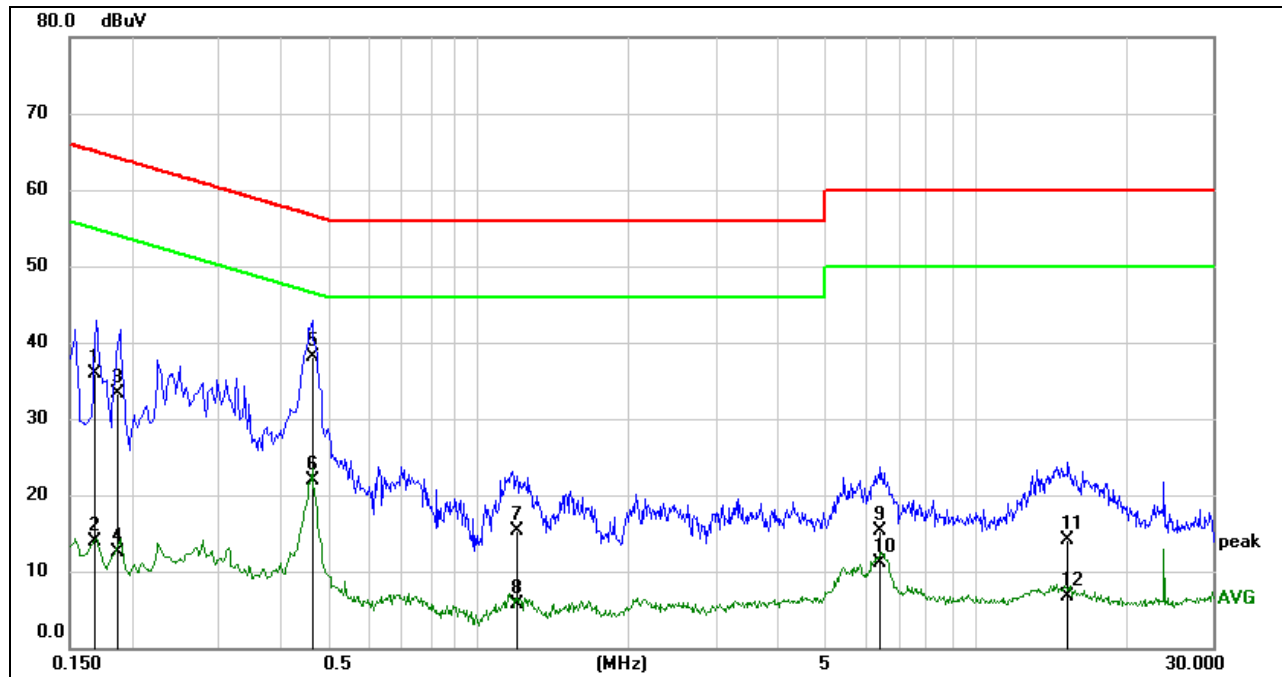

**RESULTS****9.1.1. 802.11n HT20 MIMO MODE****LINE L RESULTS (LOW CHANNEL, WORST-CASE CONFIGURATION)**

No.	Frequency (MHz)	Reading (dBuV)	Correct (dB)	Result (dBuV)	Limit (dBuV)	Margin (dB)	Remark
1	0.1678	26.38	9.59	35.97	65.07	-29.10	QP
2	0.1678	4.29	9.59	13.88	55.07	-41.19	AVG
3	0.1867	23.76	9.59	33.35	64.18	-30.83	QP
4	0.1867	2.92	9.59	12.51	54.18	-41.67	AVG
5	0.4608	28.42	9.60	38.02	56.68	-18.66	QP
6	0.4608	12.38	9.60	21.98	46.68	-24.70	AVG
7	1.1911	5.71	9.61	15.32	56.00	-40.68	QP
8	1.1911	-3.93	9.61	5.68	46.00	-40.32	AVG
9	6.4277	5.61	9.64	15.25	60.00	-44.75	QP
10	6.4277	1.51	9.64	11.15	50.00	-38.85	AVG
11	15.3307	4.35	9.66	14.01	60.00	-45.99	QP
12	15.3307	-3.03	9.66	6.63	50.00	-43.37	AVG

Note: 1. Result = Reading + Correct Factor.

2. If QP Result complies with AV limit, AV Result is deemed to comply with AV limit.

3. Test setup: RBW: 200 Hz (9 kHz ~ 150 kHz), 9 kHz (150 kHz ~ 30 MHz).

4. Step size: 80 Hz (0.009 MHz ~ 0.15 MHz), 4 kHz (0.15 MHz ~ 30 MHz), Scan time: auto.

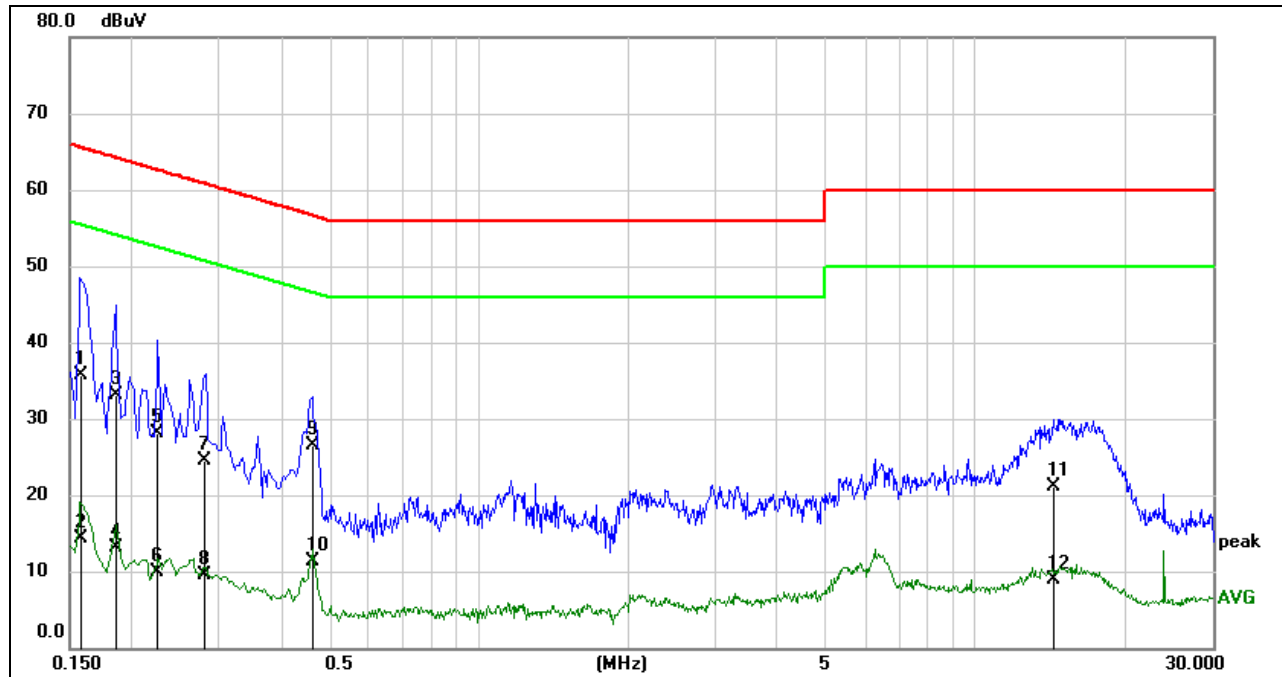
**LINE N RESULTS (LOW CHANNEL, WORST-CASE CONFIGURATION)**

No.	Frequency (MHz)	Reading (dBuV)	Correct (dB)	Result (dBuV)	Limit (dBuV)	Margin (dB)	Remark
1	0.1587	26.11	9.59	35.70	65.53	-29.83	QP
2	0.1587	4.81	9.59	14.40	55.53	-41.13	AVG
3	0.1848	23.57	9.59	33.16	64.27	-31.11	QP
4	0.1848	3.56	9.59	13.15	54.27	-41.12	AVG
5	0.2250	18.55	9.59	28.14	62.63	-34.49	QP
6	0.2250	0.25	9.59	9.84	52.63	-42.79	AVG
7	0.2790	14.96	9.59	24.55	60.85	-36.30	QP
8	0.2790	-0.01	9.59	9.58	50.85	-41.27	AVG
9	0.4617	16.99	9.60	26.59	56.66	-30.07	QP
10	0.4617	1.61	9.60	11.21	46.66	-35.45	AVG
11	14.4092	11.46	9.66	21.12	60.00	-38.88	QP
12	14.4092	-0.71	9.66	8.95	50.00	-41.05	AVG

Note: 1. Result = Reading +Correct Factor.

2. If QP Result complies with AV limit, AV Result is deemed to comply with AV limit.

3. Test setup: RBW: 200 Hz (9 kHz ~ 150 kHz), 9 kHz (150 kHz ~ 30 MHz).

4. Step size: 80 Hz (0.009 MHz ~ 0.15 MHz), 4 kHz (0.15 MHz ~ 30 MHz), Scan time: auto.

Note: All modes, channels and antenna have been tested, only the worst data was recorded in the report.



## 10. ANTENNA REQUIREMENTS

### APPLICABLE REQUIREMENTS

Please refer to FCC §15.203

An intentional radiator shall be designed to ensure that no antenna other than that furnished by the responsible party shall be used with the device. The use of a permanently attached antenna or of an antenna that uses a unique coupling to the intentional radiator shall be considered sufficient to comply with the provisions of this section. The manufacturer may design the unit so that a broken antenna can be replaced by the user, but the use of a standard antenna jack or electrical connector is prohibited.

Please refer to FCC §15.247(b)(4)

The conducted output power limit specified in paragraph (b) of this section is based on the use of antennas with directional gains that do not exceed 6 dBi. Except as shown in paragraph (c) of this section, if transmitting antennas of directional gain greater than 6 dBi are used, the conducted output power from the intentional radiator shall be reduced below the stated values in paragraphs (b)(1), (b)(2), and (b)(3) of this section, as appropriate, by the amount in dB that the directional gain of the antenna exceeds 6 dBi.

### RESULTS

Complies



## 11. Appendix

### 11.1. Appendix A: DTS Bandwidth

#### 11.1.1. Test Result

Test Mode	Antenna	Channel	DTS BW [MHz]	FL[MHz]	FH[MHz]	Limit[MHz]	Verdict
11B	Ant1	2412	9.120	2407.440	2416.560	0.5	PASS
	Ant2	2412	8.160	2407.400	2415.560	0.5	PASS
	Ant1	2437	8.600	2432.400	2441.000	0.5	PASS
	Ant2	2437	9.120	2432.400	2441.520	0.5	PASS
	Ant1	2462	8.160	2457.400	2465.560	0.5	PASS
	Ant2	2462	8.160	2457.400	2465.560	0.5	PASS
11G	Ant1	2412	15.520	2404.400	2419.920	0.5	PASS
	Ant2	2412	15.200	2404.400	2419.600	0.5	PASS
	Ant1	2437	15.200	2429.400	2444.600	0.5	PASS
	Ant2	2437	16.120	2428.800	2444.920	0.5	PASS
	Ant1	2462	15.320	2454.440	2469.760	0.5	PASS
	Ant2	2462	15.200	2454.360	2469.560	0.5	PASS
11N20MIMO	Ant1	2412	15.160	2404.400	2419.560	0.5	PASS
	Ant2	2412	17.000	2403.800	2420.800	0.5	PASS
	Ant1	2437	17.640	2428.160	2445.800	0.5	PASS
	Ant2	2437	15.160	2429.440	2444.600	0.5	PASS
	Ant1	2462	14.520	2455.080	2469.600	0.5	PASS
	Ant2	2462	15.760	2454.400	2470.160	0.5	PASS
11N40MIMO	Ant1	2422	35.280	2404.400	2439.680	0.5	PASS
	Ant2	2422	35.280	2404.400	2439.680	0.5	PASS
	Ant1	2437	35.280	2419.400	2454.680	0.5	PASS
	Ant2	2437	35.280	2419.400	2454.680	0.5	PASS
	Ant1	2452	35.280	2434.400	2469.680	0.5	PASS
	Ant2	2452	35.280	2434.400	2469.680	0.5	PASS

### 11.1.2. Test Graphs

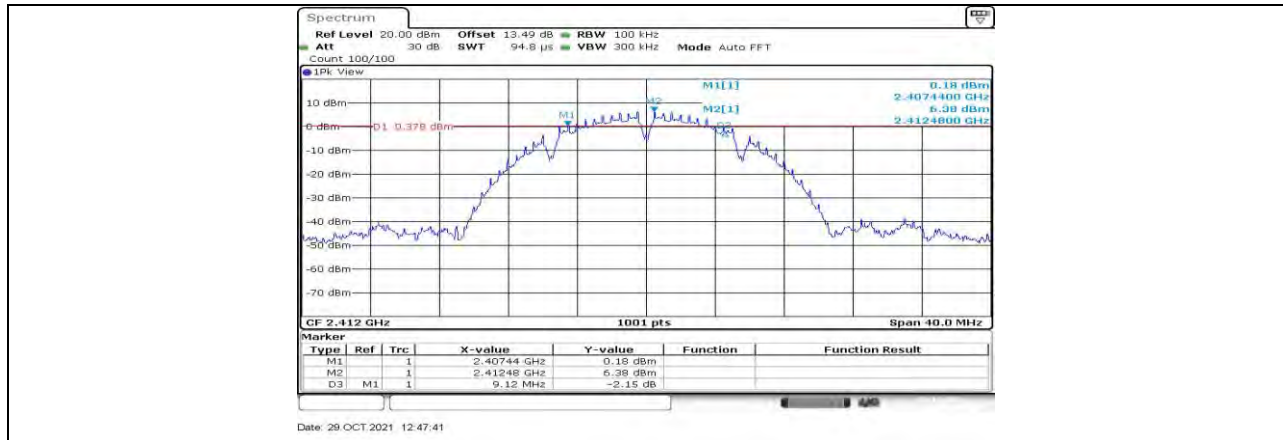

11B Ant1 2412

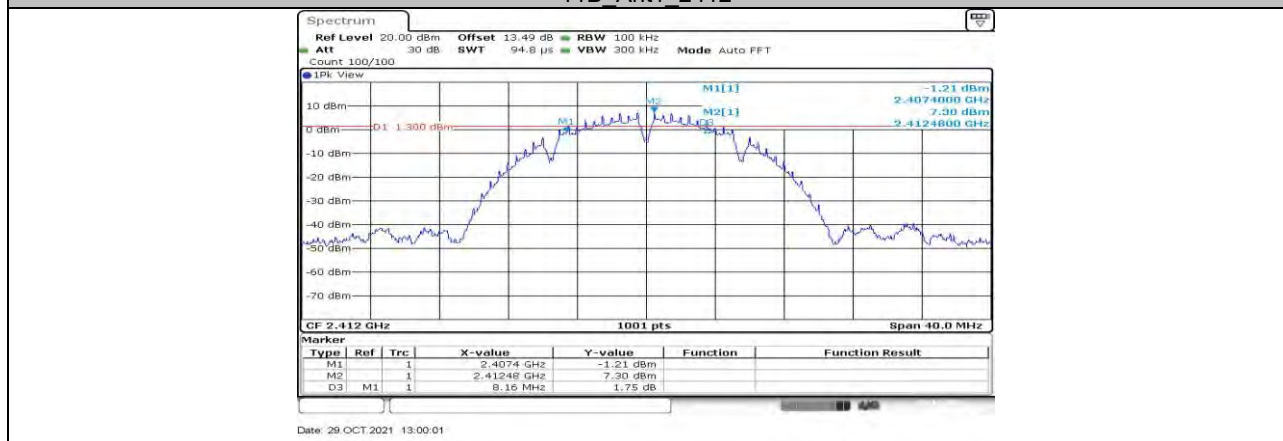

11B Ant2 2412

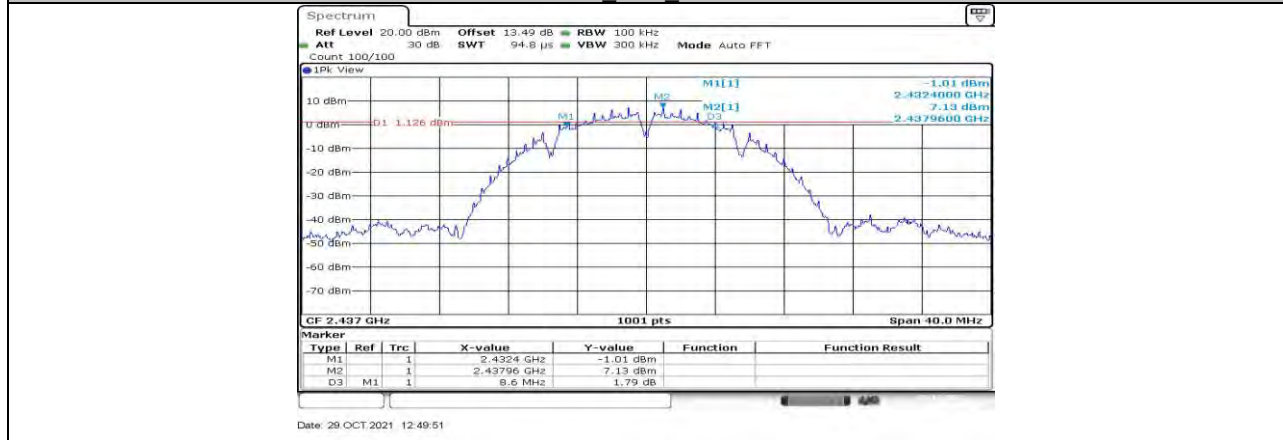

11B Ant1 2437



11B Ant2 2437



11B Ant1 2462

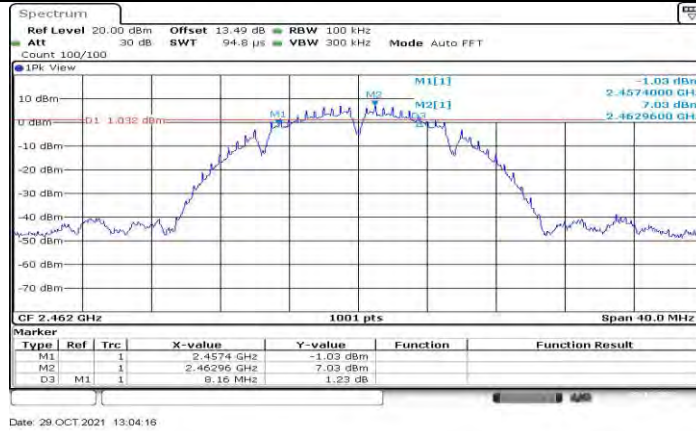

11B Ant2 2462

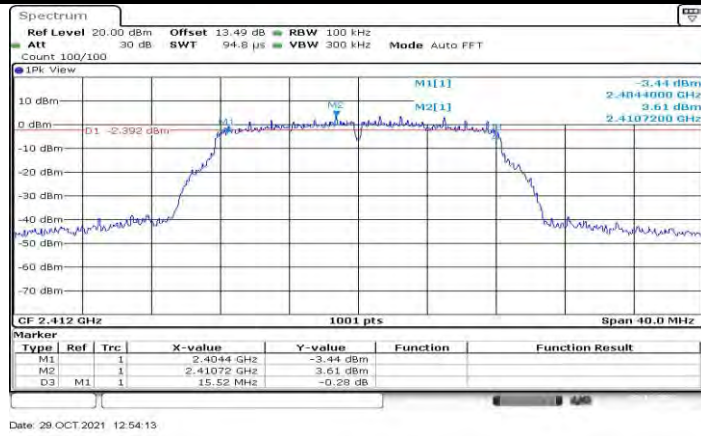

11G Ant1 2412

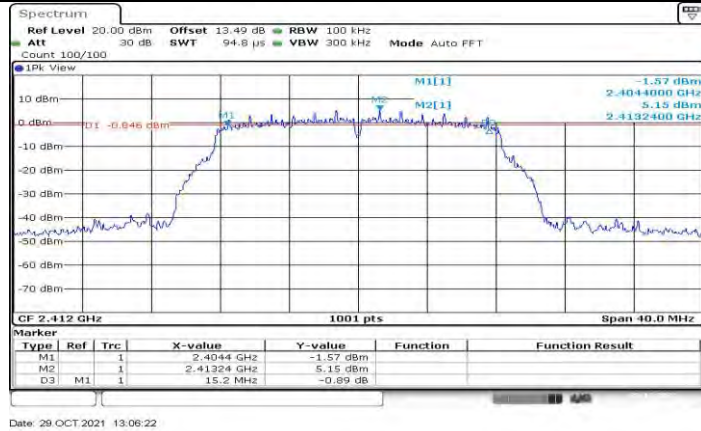

11G Ant2 2412

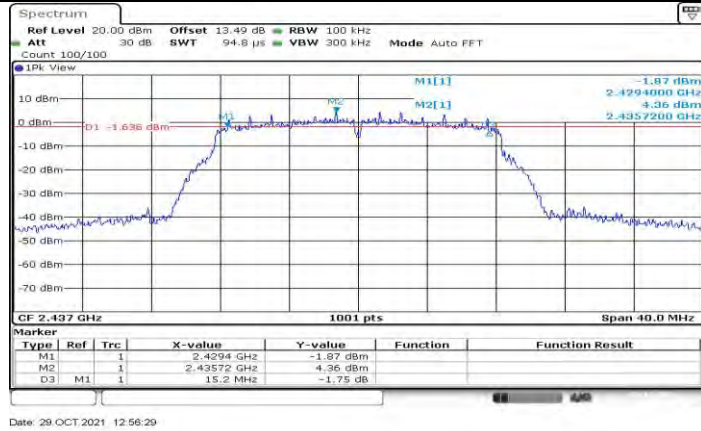

11G Ant1 2437

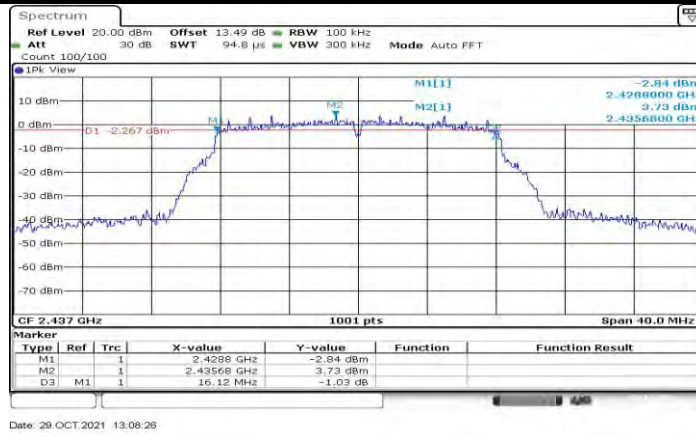

11G Ant2 2437

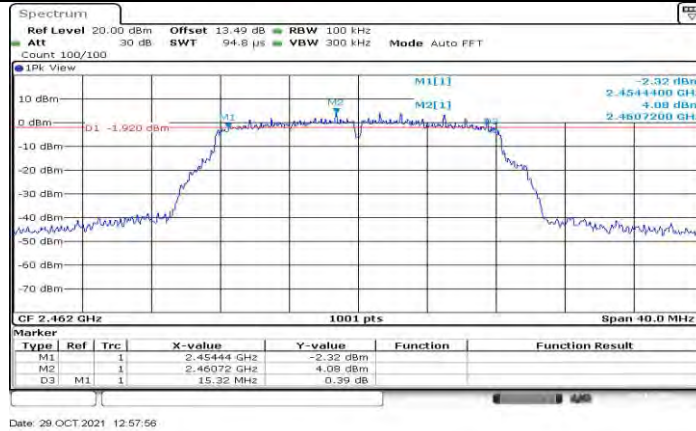

11G Ant1 2462

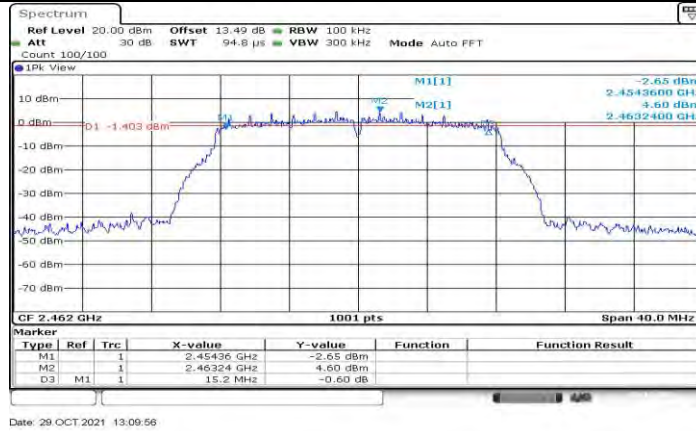

11G Ant2 2462



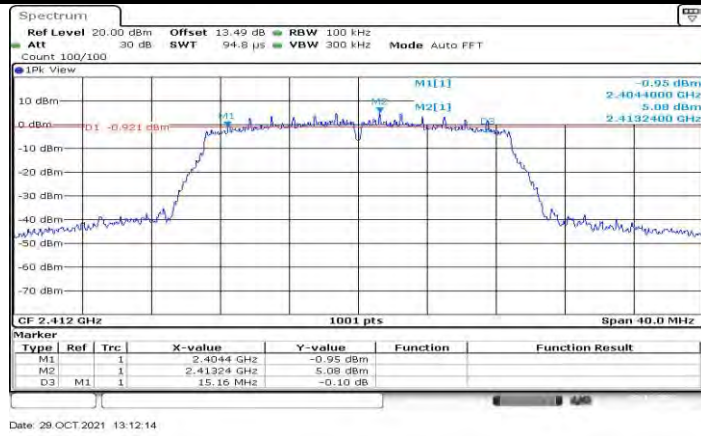

11N20MIMO Ant1 2412

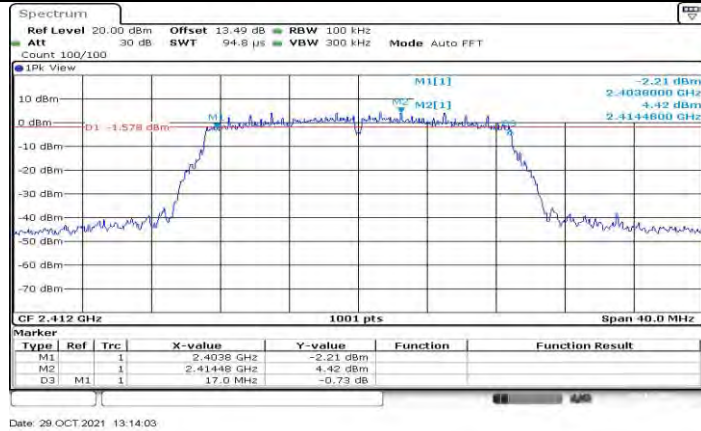

11N20MIMO Ant2 2412



11N20MIMO Ant1 2437

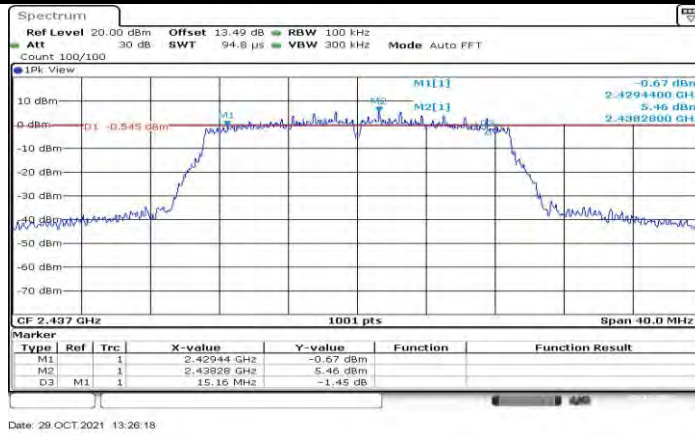

Date: 29 OCT 2021 13:26:18

11N20MIMO Ant2 2437

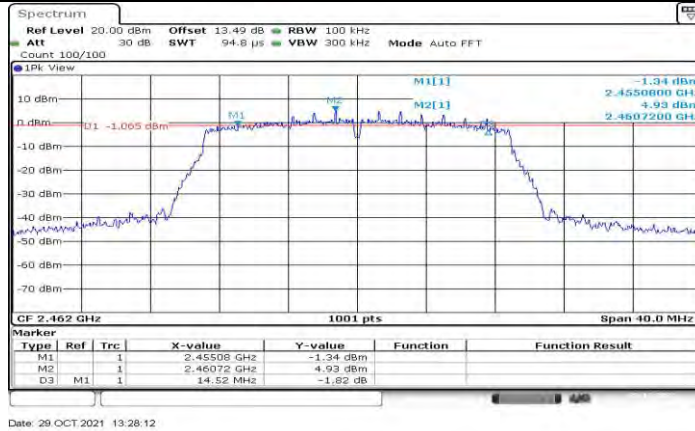

Date: 29 OCT 2021 13:28:12

11N20MIMO Ant1 2462

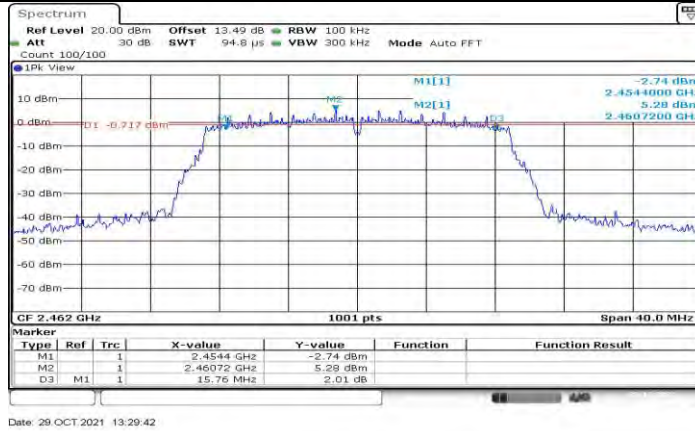

Date: 29 OCT 2021 13:29:42

11N20MIMO Ant2 2462

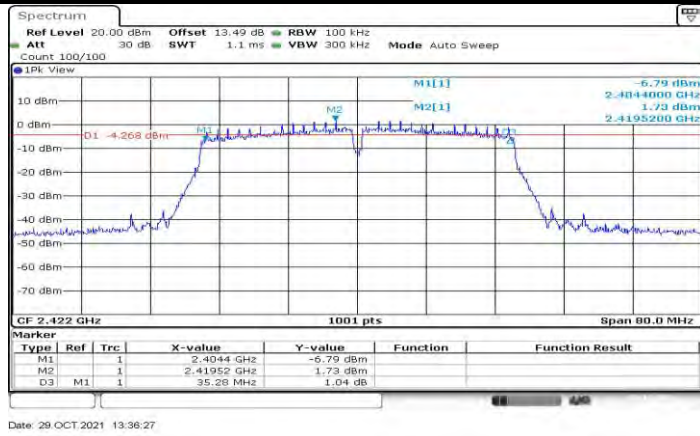

Date: 29 OCT 2021 13:36:27

11N40MIMO Ant1 2422

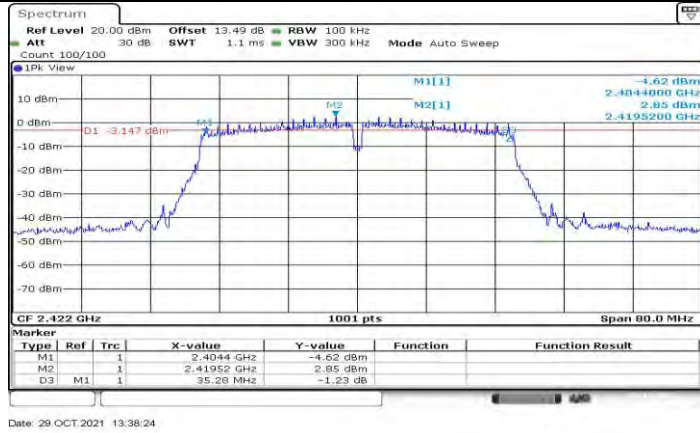

Date: 29 OCT 2021 13:38:24

11N40MIMO Ant2 2422

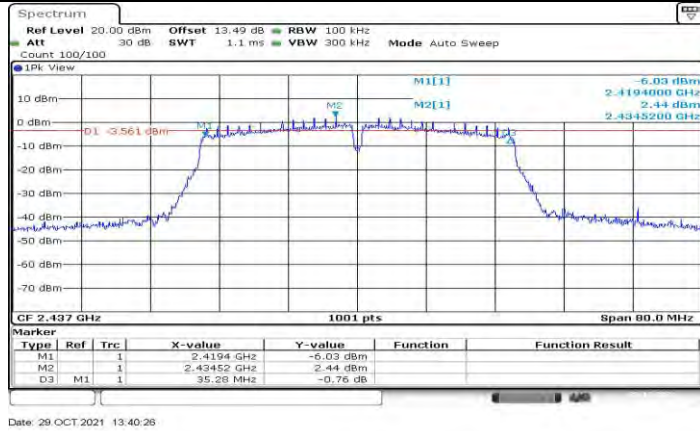

Date: 29 OCT 2021 13:40:28

11N40MIMO Ant1 2437

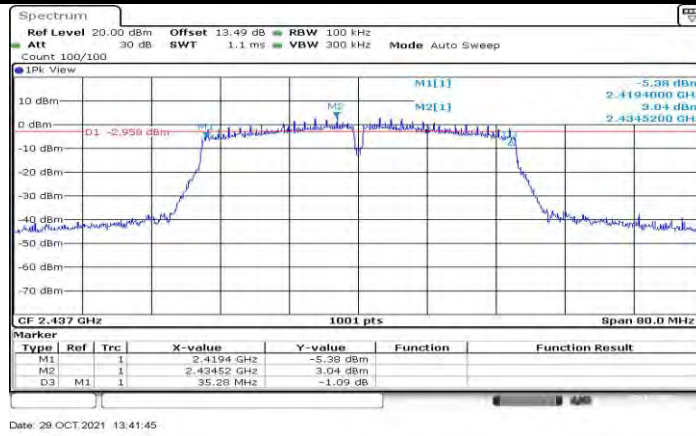

Date: 29 OCT 2021 13:41:45

11N40MIMO Ant2 2437

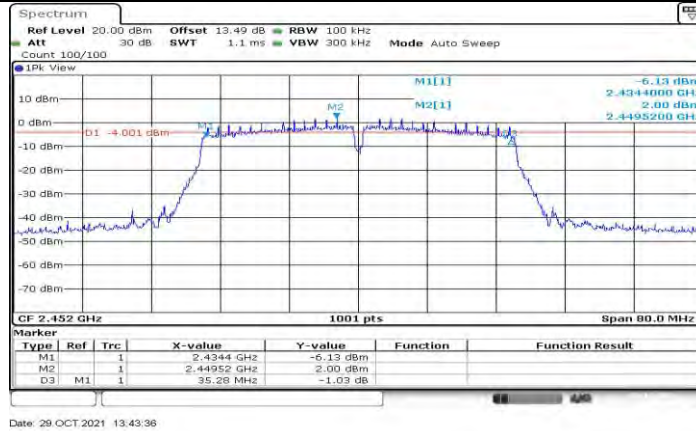

Date: 29 OCT 2021 13:43:36

11N40MIMO Ant1 2452

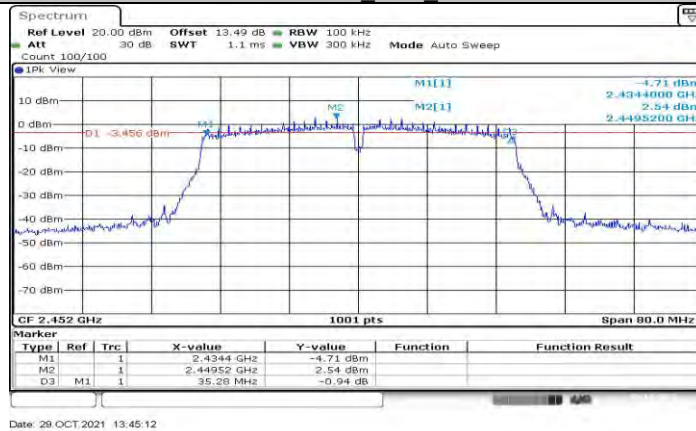

Date: 29 OCT 2021 13:45:12

11N40MIMO Ant2 2452

**11.2. Appendix B: Occupied Channel Bandwidth****11.2.1. Test Result**

Test Mode	Antenna	Channel	OCB [MHz]	FL[MHz]	FH[MHz]	Verdict
11B	Ant1	2412	13.387	2405.327	2418.713	PASS
	Ant2	2412	13.387	2405.327	2418.713	PASS
	Ant1	2437	13.427	2430.287	2443.713	PASS
	Ant2	2437	13.387	2430.287	2443.673	PASS
	Ant1	2462	13.387	2455.287	2468.673	PASS
	Ant2	2462	13.387	2455.287	2468.673	PASS
11G	Ant1	2412	17.023	2403.528	2420.551	PASS
	Ant2	2412	16.943	2403.528	2420.472	PASS
	Ant1	2437	16.943	2428.528	2445.472	PASS
	Ant2	2437	16.943	2428.528	2445.472	PASS
	Ant1	2462	16.863	2453.568	2470.432	PASS
	Ant2	2462	16.903	2453.568	2470.472	PASS
11N20MIMO	Ant1	2412	17.902	2403.049	2420.951	PASS
	Ant2	2412	17.782	2403.129	2420.911	PASS
	Ant1	2437	17.782	2428.129	2445.911	PASS
	Ant2	2437	17.782	2428.129	2445.911	PASS
	Ant1	2462	17.902	2453.009	2470.911	PASS
	Ant2	2462	17.742	2453.129	2470.871	PASS
11N40MIMO	Ant1	2422	36.284	2404.018	2440.302	PASS
	Ant2	2422	36.044	2404.018	2440.062	PASS
	Ant1	2437	36.044	2419.018	2455.062	PASS
	Ant2	2437	36.044	2419.098	2455.142	PASS
	Ant1	2452	36.204	2433.938	2470.142	PASS
	Ant2	2452	36.284	2433.858	2470.142	PASS



### 11.2.2. Test Graphs

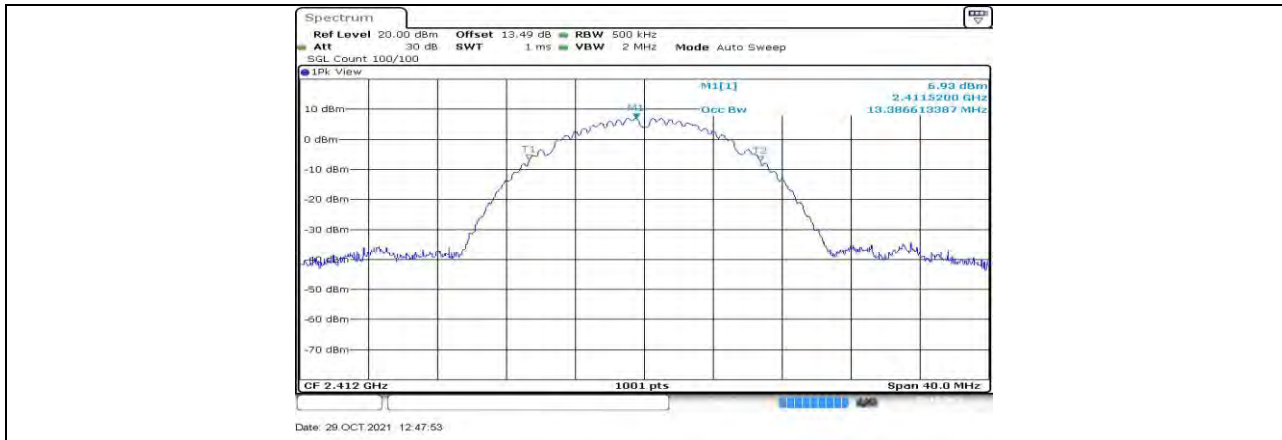

11B Ant1 2412



11B Ant2 2412

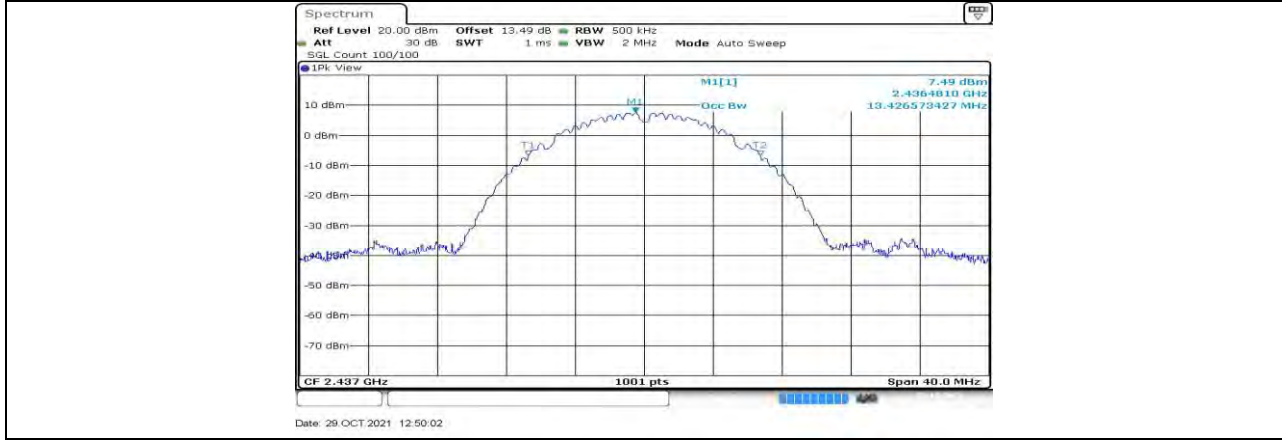

11B Ant1 2437



11B Ant2 2437



11B Ant1 2462



11B Ant2 2462



11G Ant1 2412



11G Ant2 2412

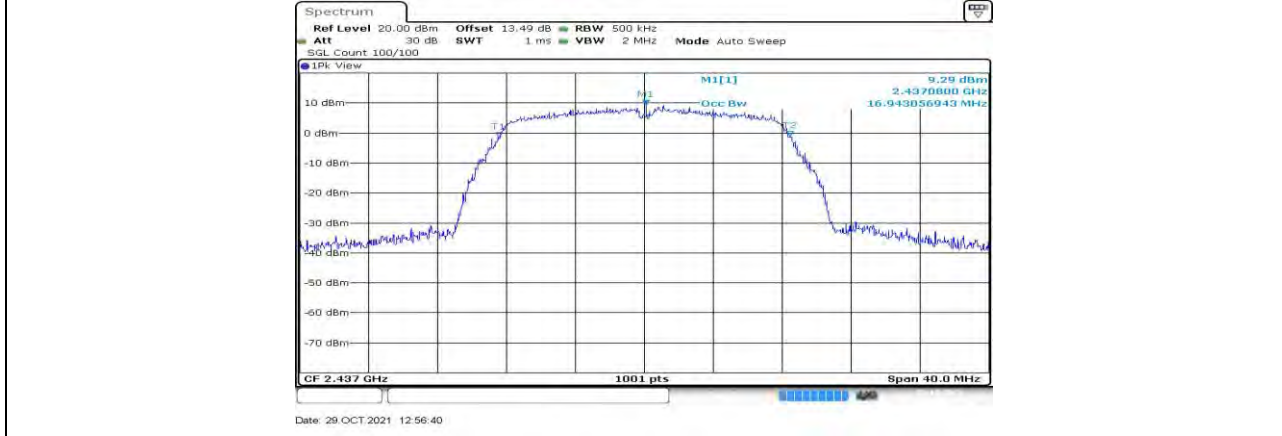

11G Ant1 2437





11G Ant2 2437

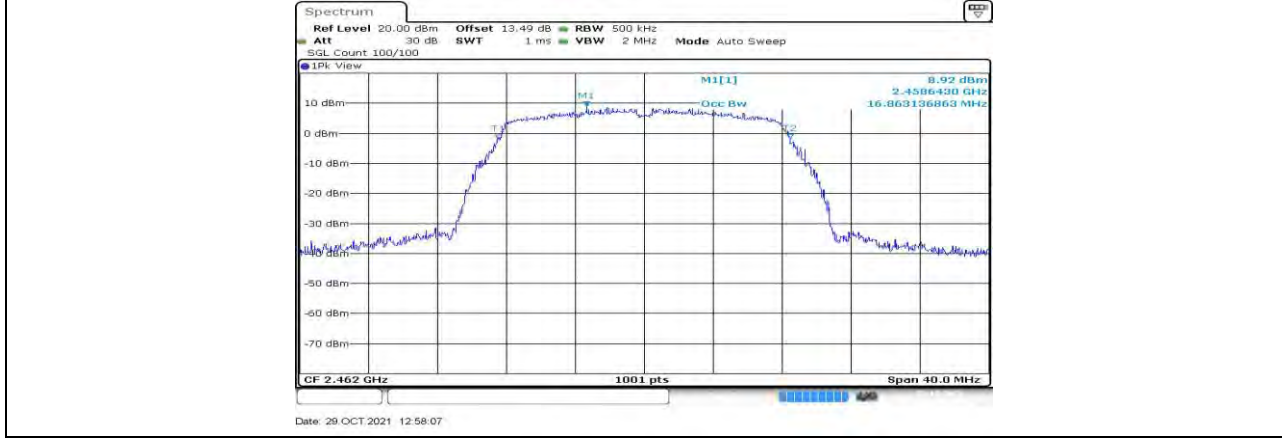

11G Ant1 2462

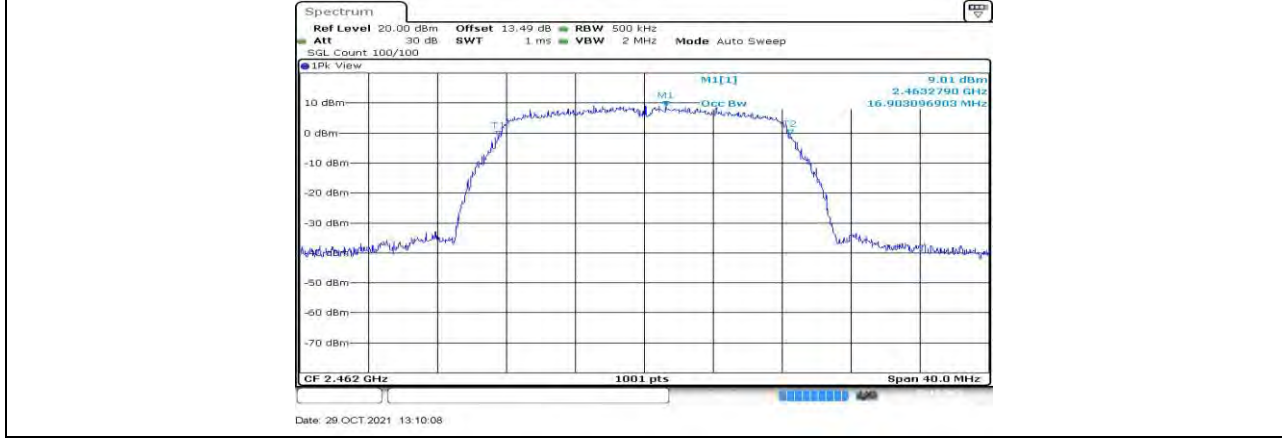

11G Ant2 2462



Date: 29.OCT.2021 13:12:25

11N20MIMO Ant1 2412



Date: 29.OCT.2021 13:14:15

11N20MIMO Ant2 2412



Date: 29.OCT.2021 13:25:03

11N20MIMO Ant1 2437



11N20MIMO Ant2 2437



11N20MIMO Ant1 2462



11N20MIMO Ant2 2462



Date: 29.OCT.2021 13:36:38

11N40MIMO Ant1 2422



Date: 29.OCT.2021 13:38:35

11N40MIMO Ant2 2422



Date: 29.OCT.2021 13:40:38

11N40MIMO Ant1 2437



Date: 29.OCT.2021 13:41:56

11N40MIMO Ant2 2437



Date: 29.OCT.2021 13:43:48

11N40MIMO Ant1 2452



Date: 29.OCT.2021 13:45:23

11N40MIMO Ant2 2452

**11.3. Appendix C: Maximum conducted output power****11.3.1. Test Result**

Test Mode	Antenna	Channel	Result[dBm]	Limit[dBm]	Verdict
11B	Ant1	2412	14.55	≤30	PASS
	Ant2	2412	14.95	≤30	PASS
	Ant1	2437	15.00	≤30	PASS
	Ant2	2437	15.42	≤30	PASS
	Ant1	2462	14.74	≤30	PASS
	Ant2	2462	15.03	≤30	PASS
11G	Ant1	2412	14.30	≤30	PASS
	Ant2	2412	14.95	≤30	PASS
	Ant1	2437	14.42	≤30	PASS
	Ant2	2437	14.90	≤30	PASS
	Ant1	2462	14.35	≤30	PASS
	Ant2	2462	14.81	≤30	PASS
11N20MIMO	Ant1	2412	14.63	≤30	PASS
	Ant2	2412	15.24	≤30	PASS
	total	2412	18.0	≤30	PASS
	Ant1	2437	14.70	≤30	PASS
	Ant2	2437	15.04	≤30	PASS
	total	2437	17.9	≤30	PASS
	Ant1	2462	14.63	≤30	PASS
	Ant2	2462	15.07	≤30	PASS
total	2462	17.9	≤30	PASS	
11N40MIMO	Ant1	2422	14.19	≤30	PASS
	Ant2	2422	14.78	≤30	PASS
	total	2422	17.5	≤30	PASS
	Ant1	2437	14.38	≤30	PASS
	Ant2	2437	14.80	≤30	PASS
	total	2437	17.6	≤30	PASS
	Ant1	2452	14.25	≤30	PASS
	Ant2	2452	14.78	≤30	PASS
	total	2452	17.5	≤30	PASS

Note: 1. Conducted Power=Meas. Level+ Correction Factor

2. The Duty Cycle Factor (refer to section 7.1) had already compensated to the test data.

**11.4. Appendix D: Maximum power spectral density****11.4.1. Test Result**

Test Mode	Antenna	Channel	Result[dBm/3kHz]	Limit[dBm/3kHz]	Verdict
11B	Ant1	2412	-7	≤8	PASS
	Ant2	2412	-5.68	≤8	PASS
	Ant1	2437	-6.75	≤8	PASS
	Ant2	2437	-5.54	≤8	PASS
	Ant1	2462	-7.38	≤8	PASS
	Ant2	2462	-5.33	≤8	PASS
11G	Ant1	2412	-9.1	≤8	PASS
	Ant2	2412	-7.12	≤8	PASS
	Ant1	2437	-8.47	≤8	PASS
	Ant2	2437	-6.93	≤8	PASS
	Ant1	2462	-8.79	≤8	PASS
	Ant2	2462	-7.56	≤8	PASS
11N20MIMO	Ant1	2412	-8.44	≤8	PASS
	Ant2	2412	-7.99	≤8	PASS
	total	2412	-5.20	≤8	PASS
	Ant1	2437	-8.23	≤8	PASS
	Ant2	2437	-8.18	≤8	PASS
	total	2437	-5.19	≤8	PASS
	Ant1	2462	-9.31	≤8	PASS
	Ant2	2462	-7.49	≤8	PASS
total	2462	-5.30	≤8	PASS	
11N40MIMO	Ant1	2422	-11.97	≤8	PASS
	Ant2	2422	-11.72	≤8	PASS
	total	2422	-8.83	≤8	PASS
	Ant1	2437	-11.57	≤8	PASS
	Ant2	2437	-11.52	≤8	PASS
	total	2437	-8.53	≤8	PASS
	Ant1	2452	-11.36	≤8	PASS
	Ant2	2452	-11.83	≤8	PASS
total	2452	-8.58	≤8	PASS	

### 11.4.2. Test Graphs

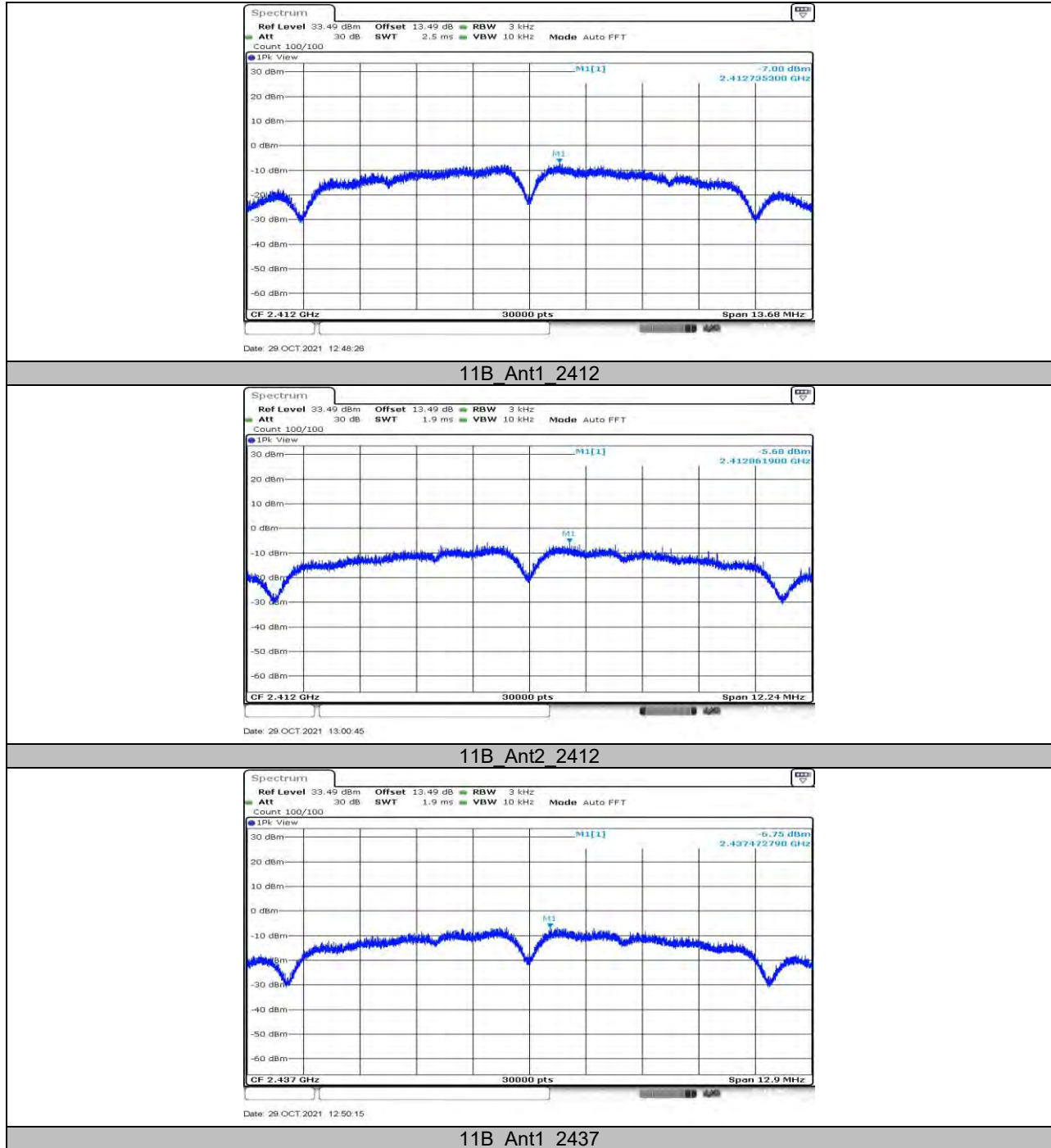



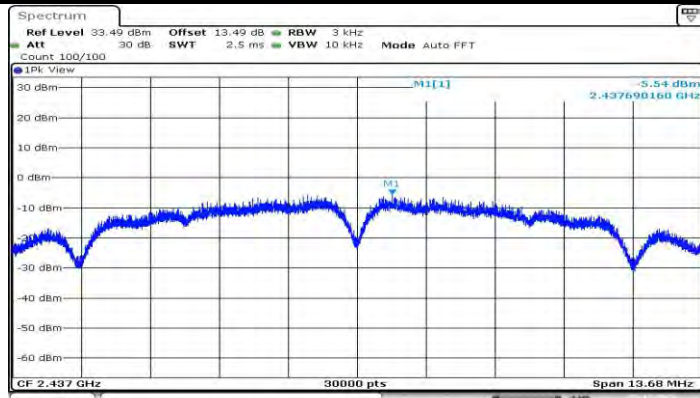

Date: 29 OCT 2021 13:02:48

11B\_Ant2\_2437

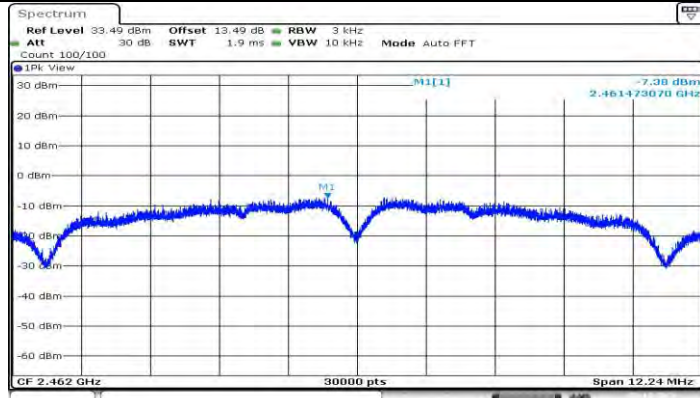

Date: 29 OCT 2021 12:52:08

11B\_Ant1\_2462

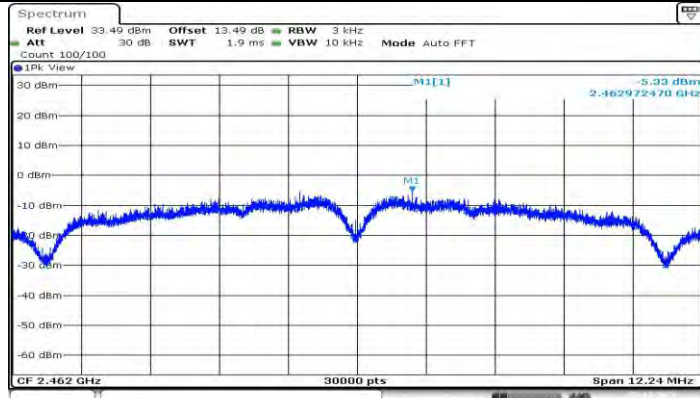

Date: 29 OCT 2021 13:04:54

11B\_Ant2\_2462

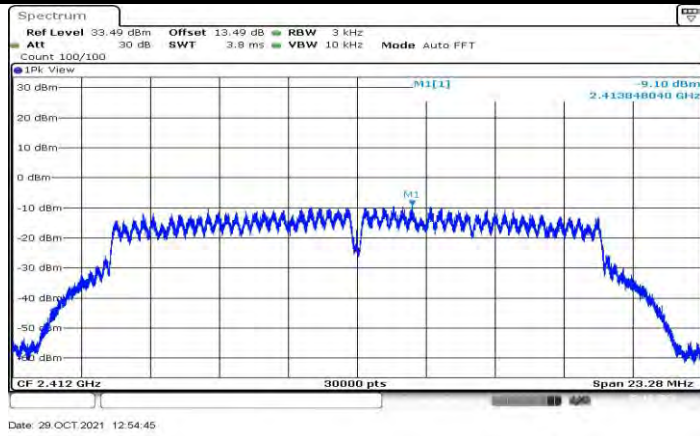

Date: 29.OCT.2021 12:54:45

11G Ant1 2412

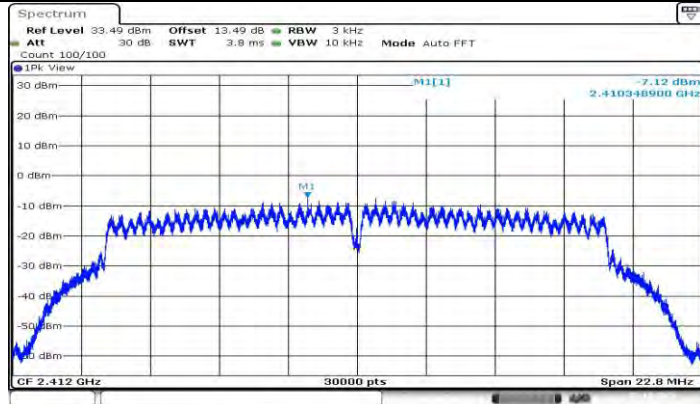

Date: 29.OCT.2021 13:06:54

11G Ant2 2412

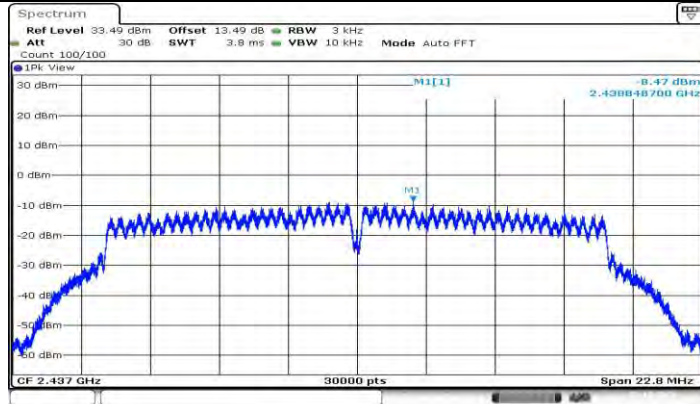

Date: 29.OCT.2021 12:56:53

11G Ant1 2437

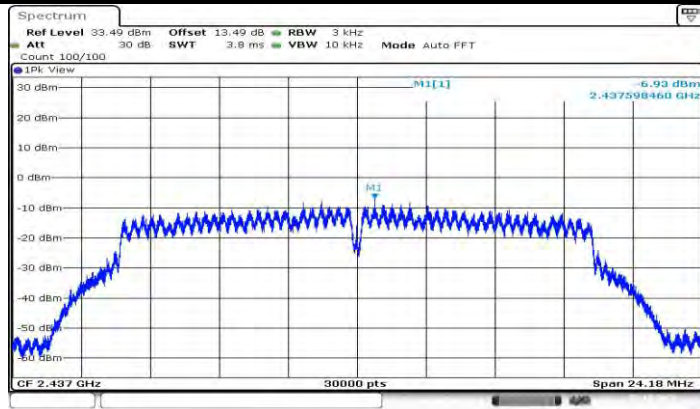

Date: 29 OCT 2021 13:08:50

11G Ant2\_2437

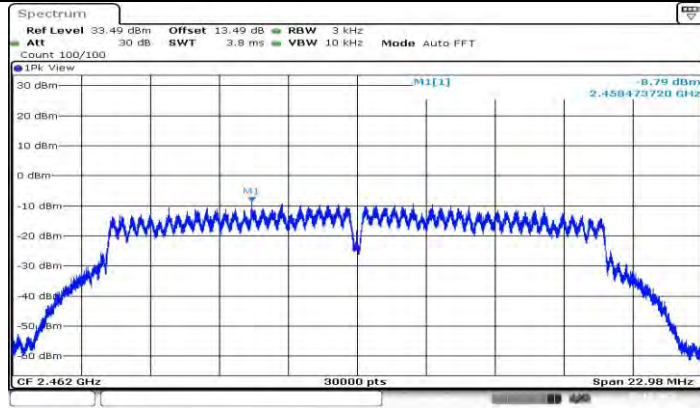

Date: 29 OCT 2021 12:58:27

11G Ant1\_2462

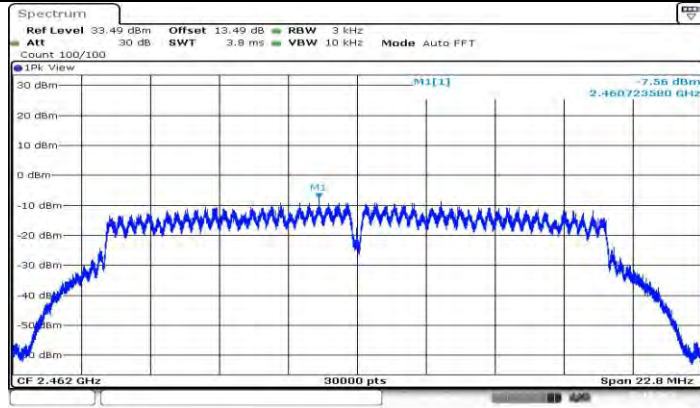

Date: 29 OCT 2021 13:10:28

11G Ant2\_2462

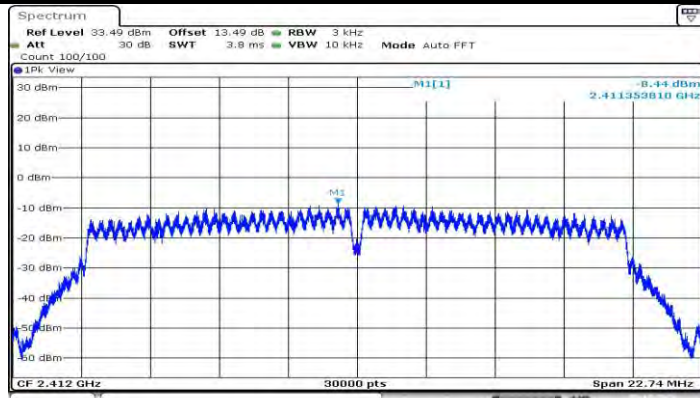

Date: 29.OCT.2021 13:12:46

11N20MIMO Ant1 2412

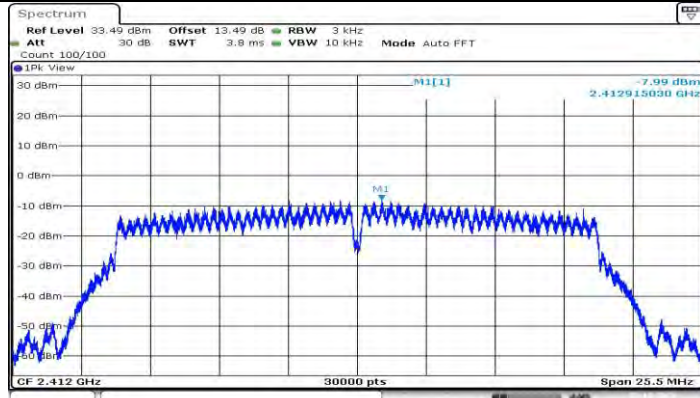

Date: 29.OCT.2021 13:14:36

11N20MIMO Ant2 2412

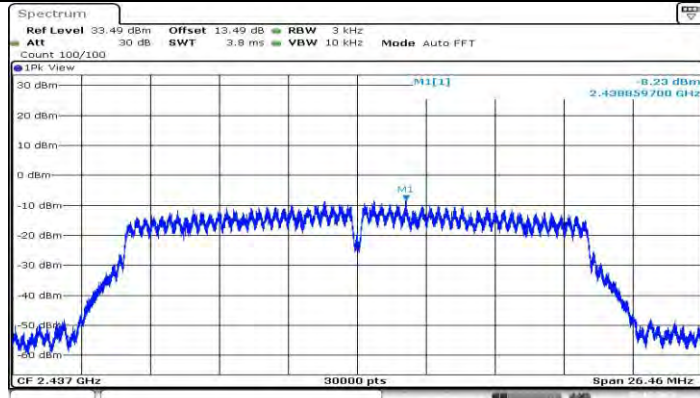

Date: 29.OCT.2021 13:25:16

11N20MIMO Ant1 2437

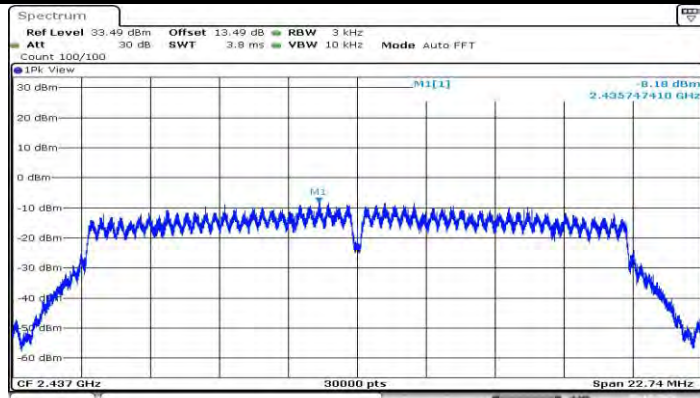

Date: 29 OCT 2021 13:26:50

11N20MIMO\_Ant2\_2437

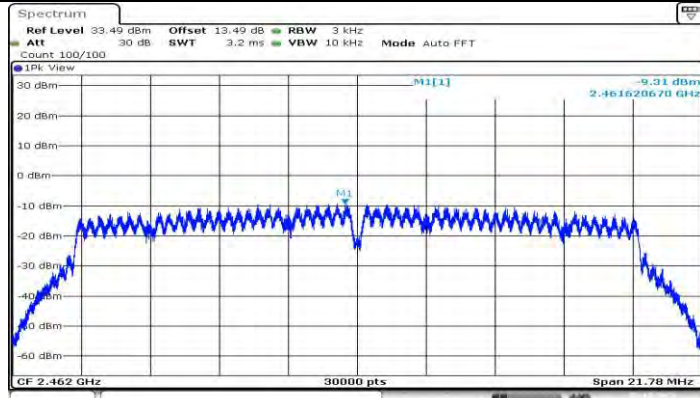

Date: 29 OCT 2021 13:28:44

11N20MIMO\_Ant1\_2462

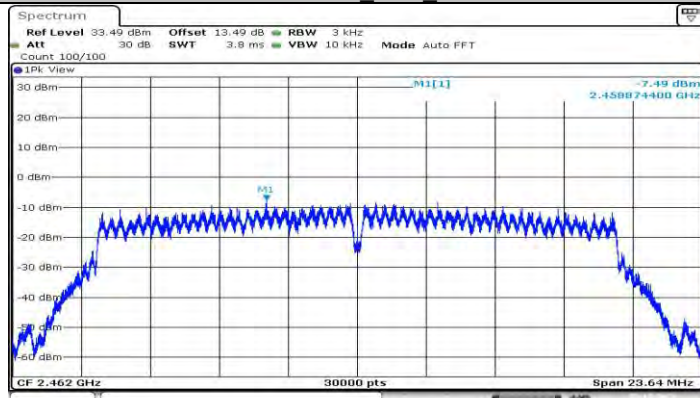

Date: 29 OCT 2021 13:30:14

11N20MIMO\_Ant2\_2462

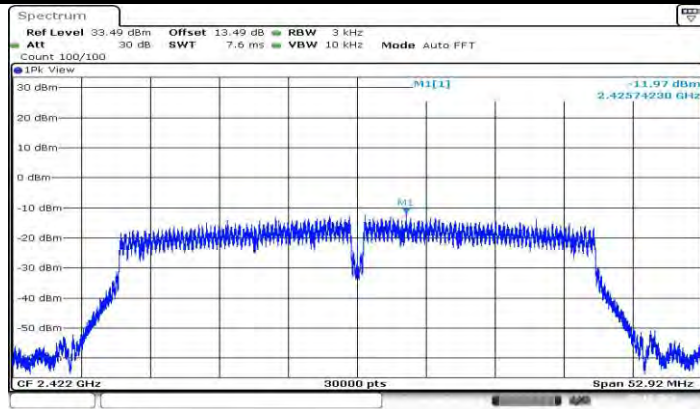

Date: 29 OCT 2021 13:36:59

11N40MIMO Ant1 2422

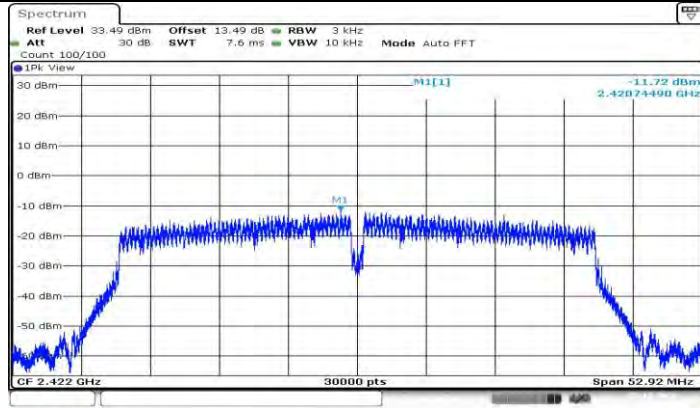

Date: 29 OCT 2021 13:38:56

11N40MIMO Ant2 2422

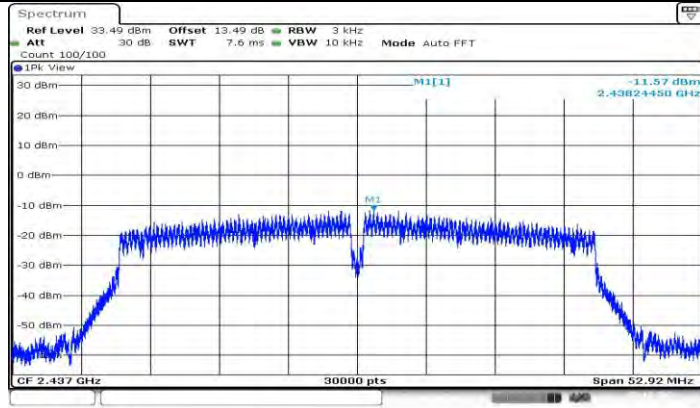

Date: 29 OCT 2021 13:40:51

11N40MIMO Ant1 2437

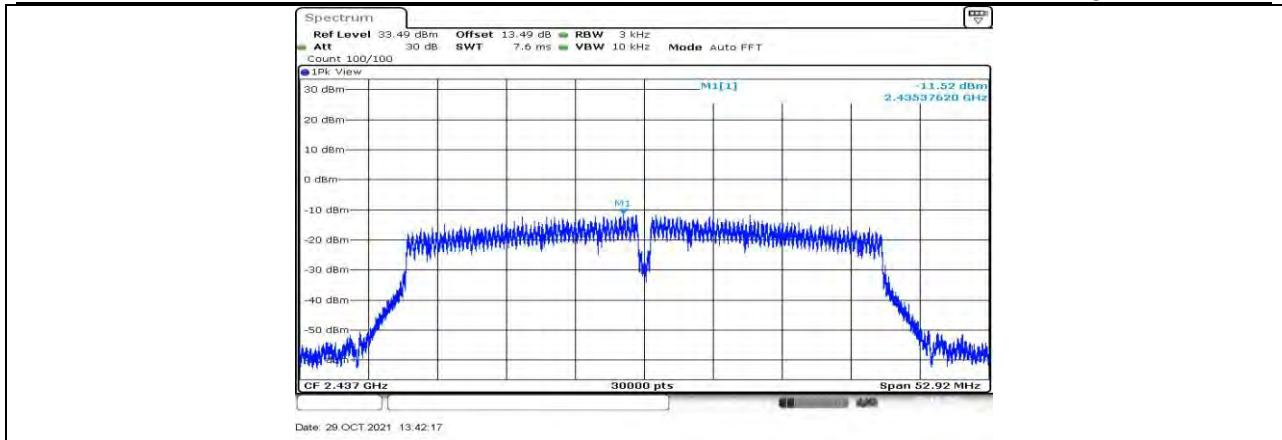

11N40MIMO Ant2 2437

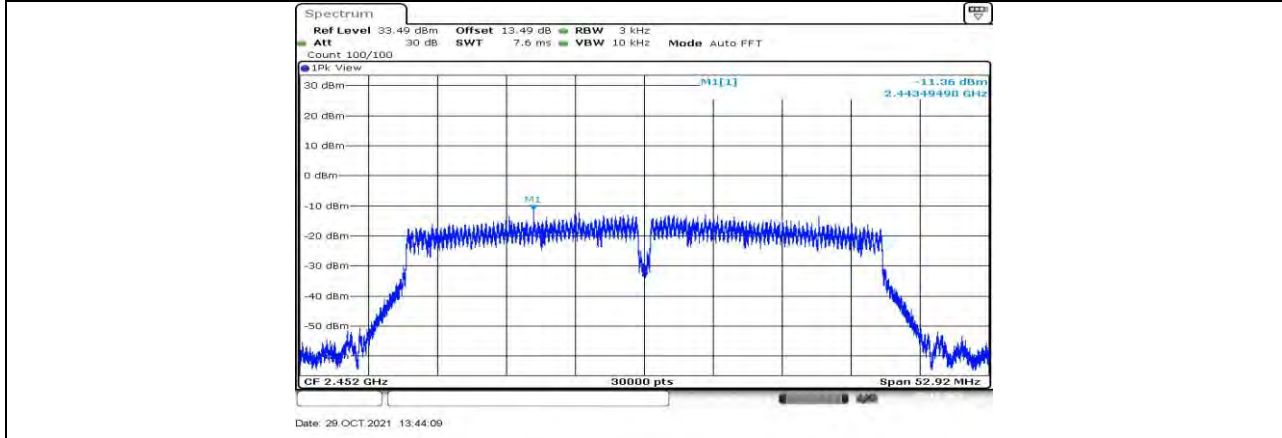

11N40MIMO Ant1 2452

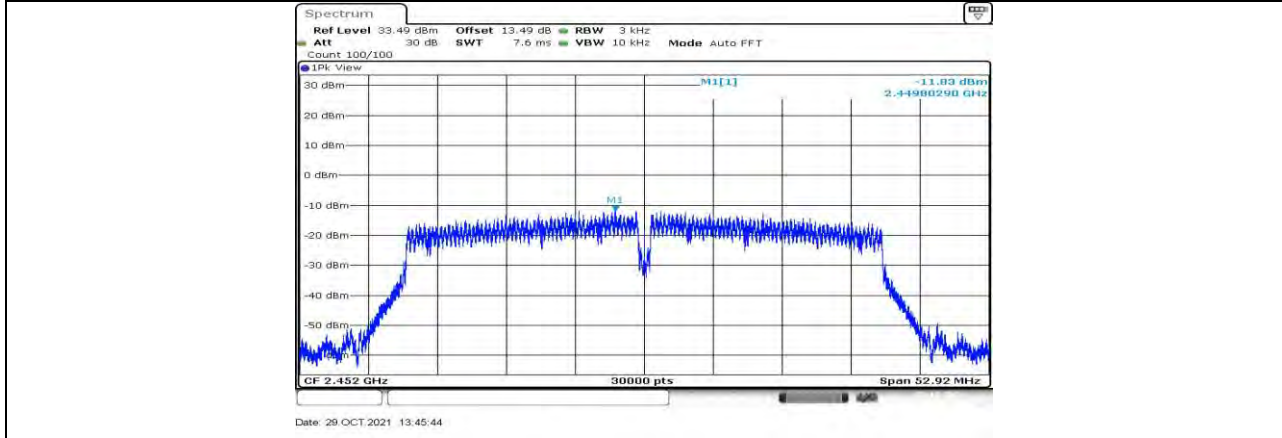

11N40MIMO Ant2 2452



**11.5. Appendix E: Band edge measurements**  
**11.5.1. Test Result**

Test Mode	Antenna	ChName	Channel	RefLevel[dBm]	Result[dBm]	Limit[dBm]	Verdict
11B	Ant1	Low	2412	6.34	-41.23	≤-23.66	PASS
	Ant2	Low	2412	6.75	-41.07	≤-23.25	PASS
	Ant1	High	2462	6.48	-45.55	≤-23.52	PASS
	Ant2	High	2462	7.10	-45.27	≤-22.9	PASS
11G	Ant1	Low	2412	4.56	-38.93	≤-25.44	PASS
	Ant2	Low	2412	5.26	-38.98	≤-24.74	PASS
	Ant1	High	2462	2.92	-44.57	≤-27.08	PASS
	Ant2	High	2462	4.20	-44	≤-25.8	PASS
11N20MIMO	Ant1	Low	2412	5.09	-38.51	≤-24.91	PASS
	Ant2	Low	2412	5.53	-36.35	≤-24.47	PASS
	Ant1	High	2462	5.04	-45.21	≤-24.96	PASS
	Ant2	High	2462	4.93	-43.89	≤-25.07	PASS
11N40MIMO	Ant1	Low	2422	1.55	-36.96	≤-28.45	PASS
	Ant2	Low	2422	1.60	-37.39	≤-28.4	PASS
	Ant1	High	2452	1.35	-43.78	≤-28.65	PASS
	Ant2	High	2452	2.36	-42.17	≤-27.64	PASS





### 11.5.2. Test Graphs

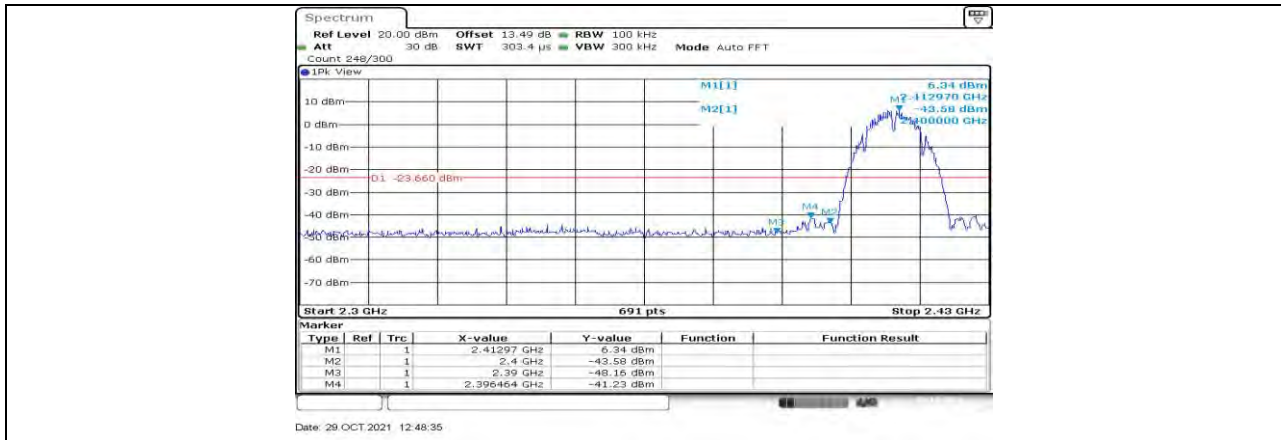

11B Ant1 Low 2412

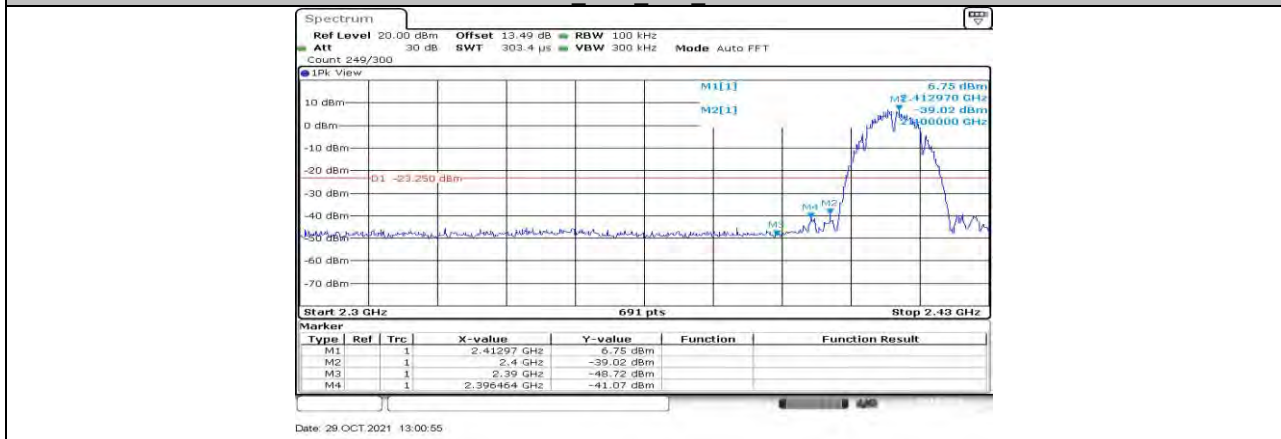

11B Ant2 Low 2412



11B Ant1 High 2462



11B Ant2 High 2462

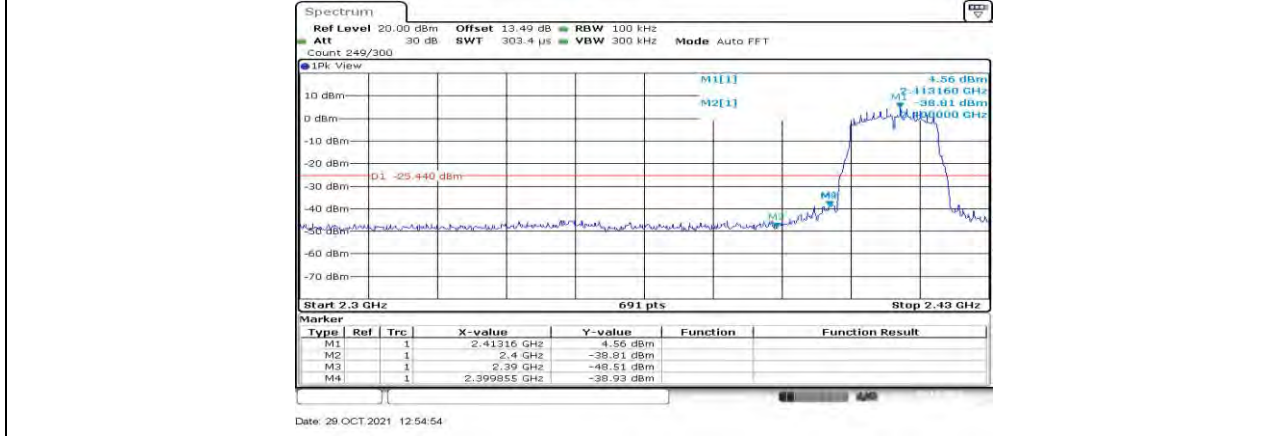

11G Ant1 Low 2412

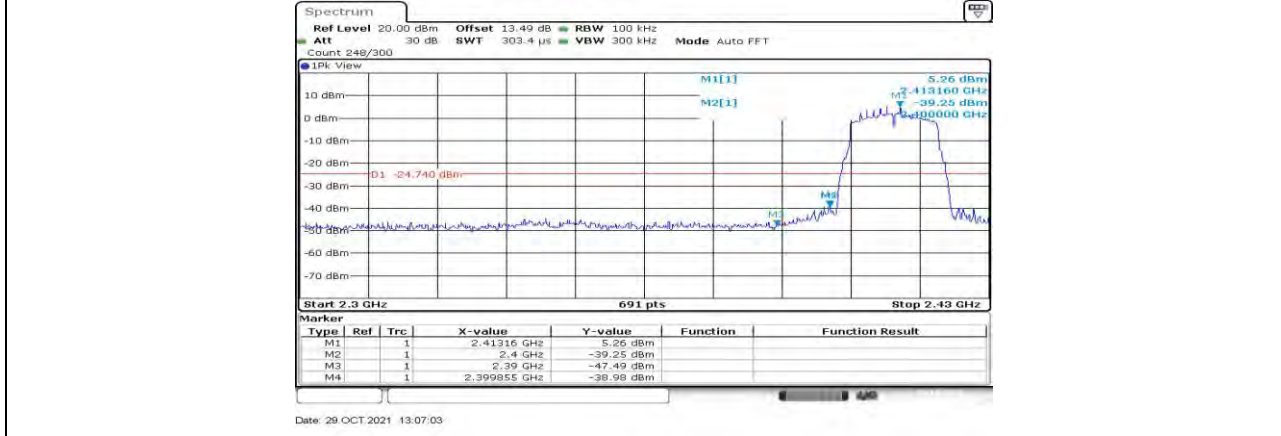

11G Ant2 Low 2412

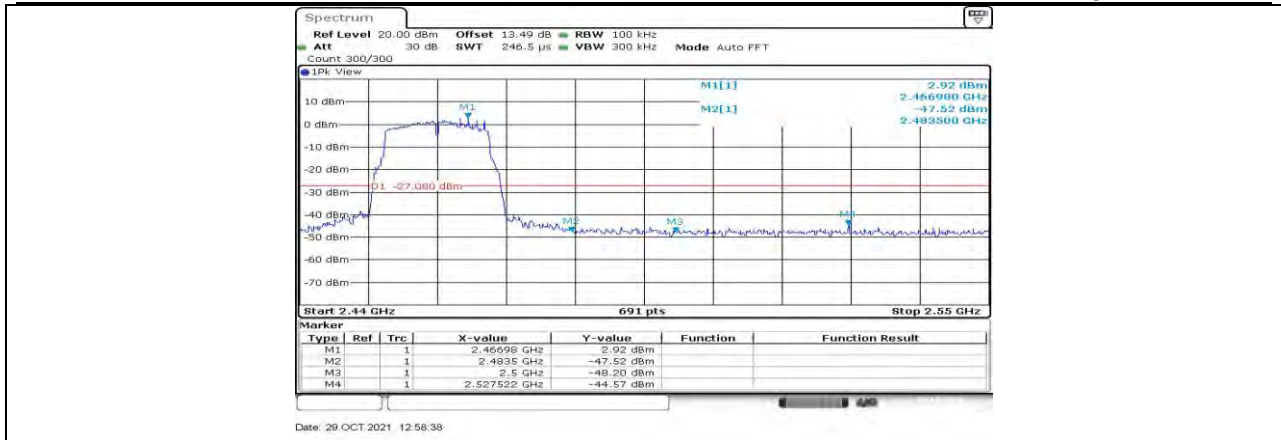

Date: 29 OCT 2021 12:58:38

11G Ant1 High 2462

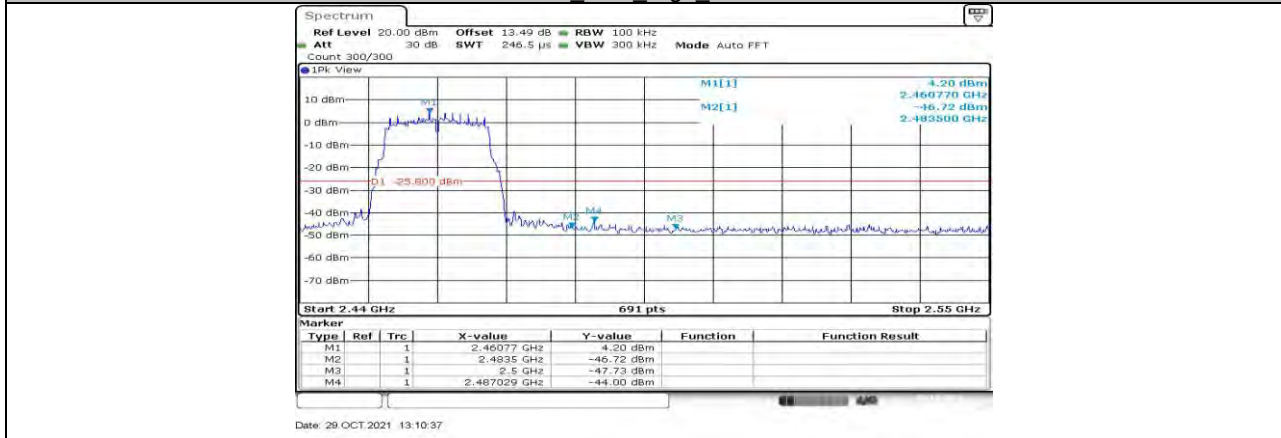

Date: 29 OCT 2021 13:10:37

11G Ant2 High 2462

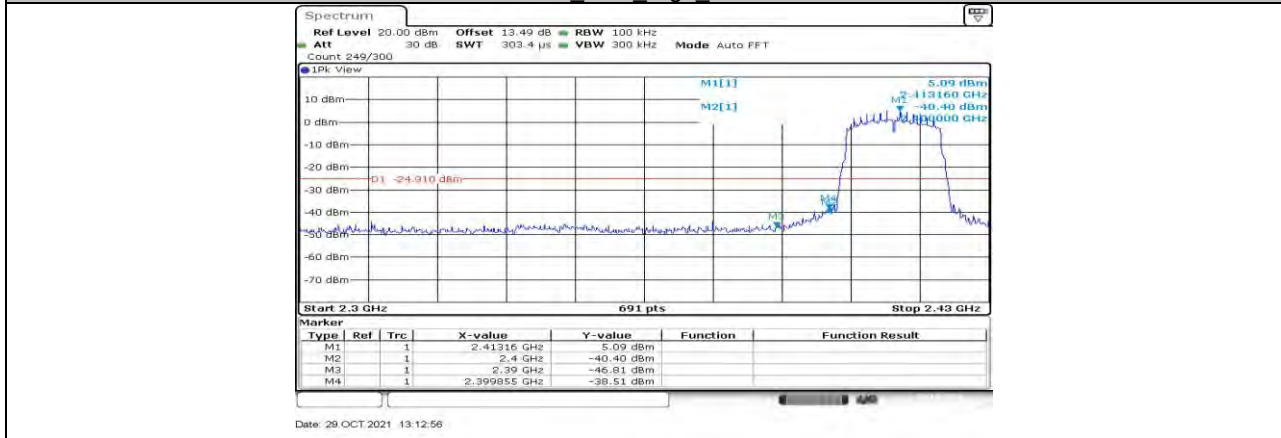

Date: 29 OCT 2021 13:12:56

11N20MIMO\_Ant1\_Low\_2412

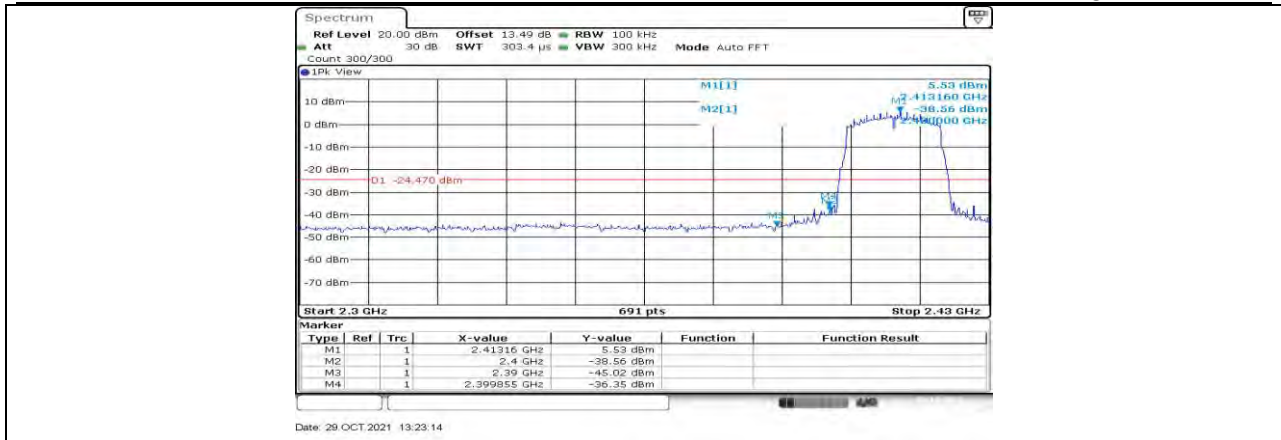

11N20MIMO Ant2 Low 2412

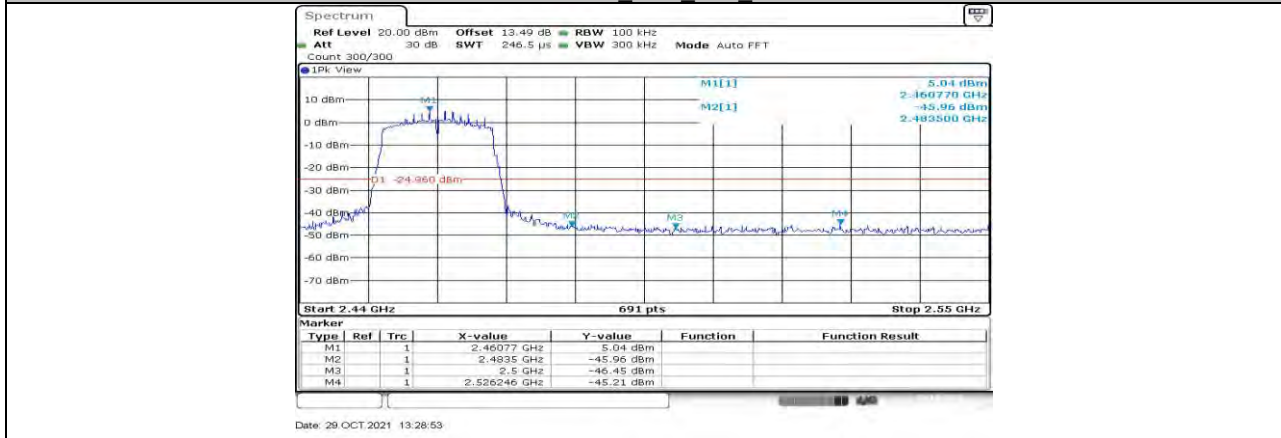

11N20MIMO Ant1 High 2462

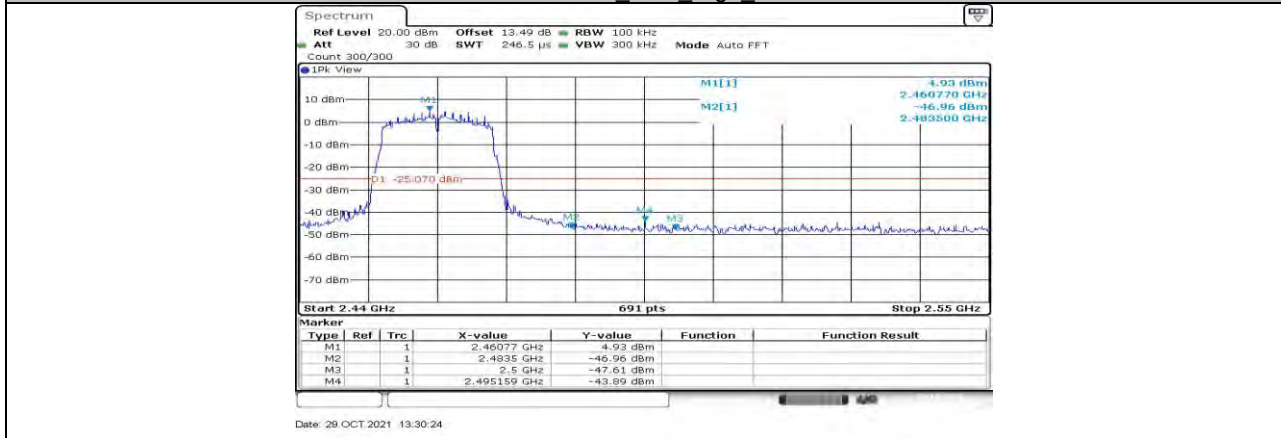

11N20MIMO Ant2 High 2462

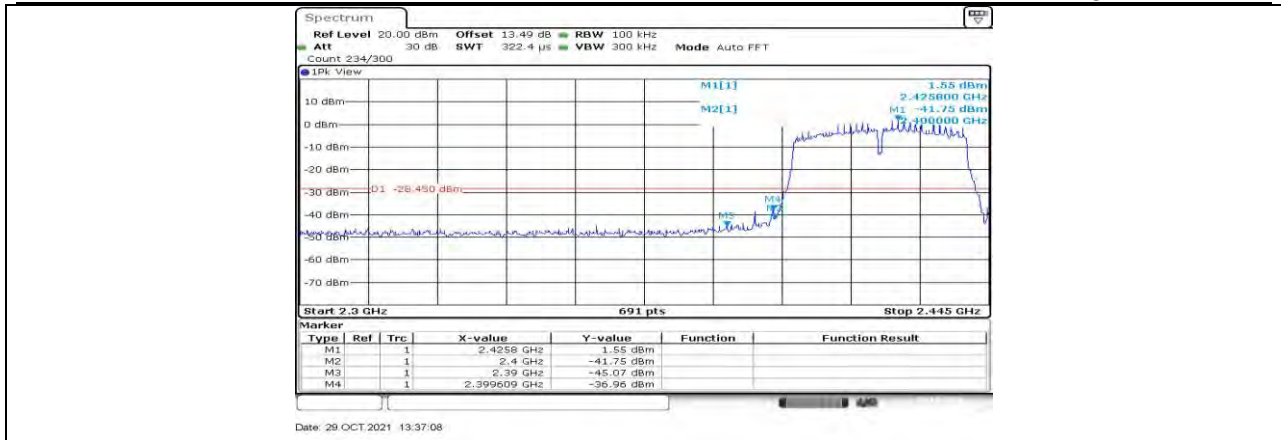

Date: 29 OCT 2021 13:37:08

11N40MIMO Ant1 Low 2422

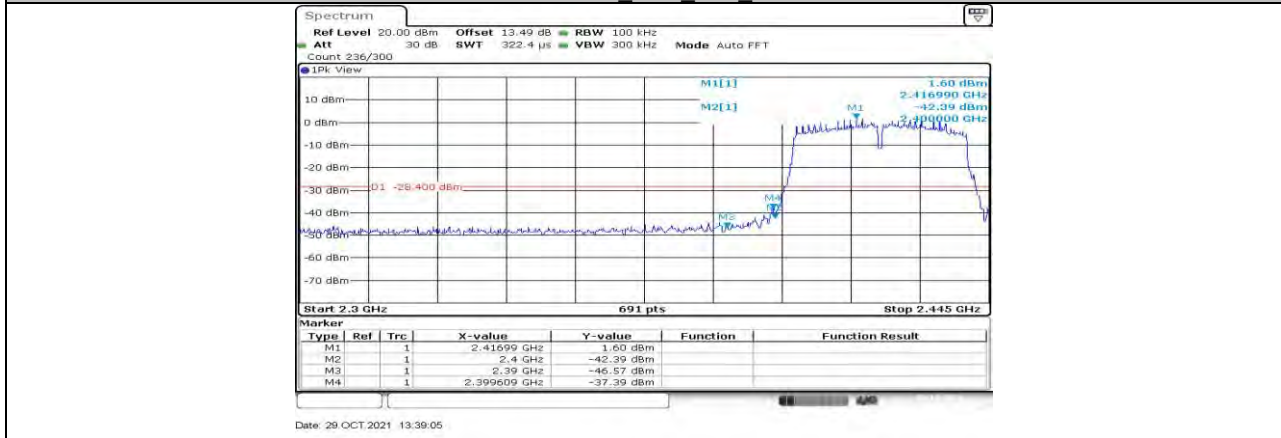

Date: 29 OCT 2021 13:39:05

11N40MIMO Ant2 Low 2422

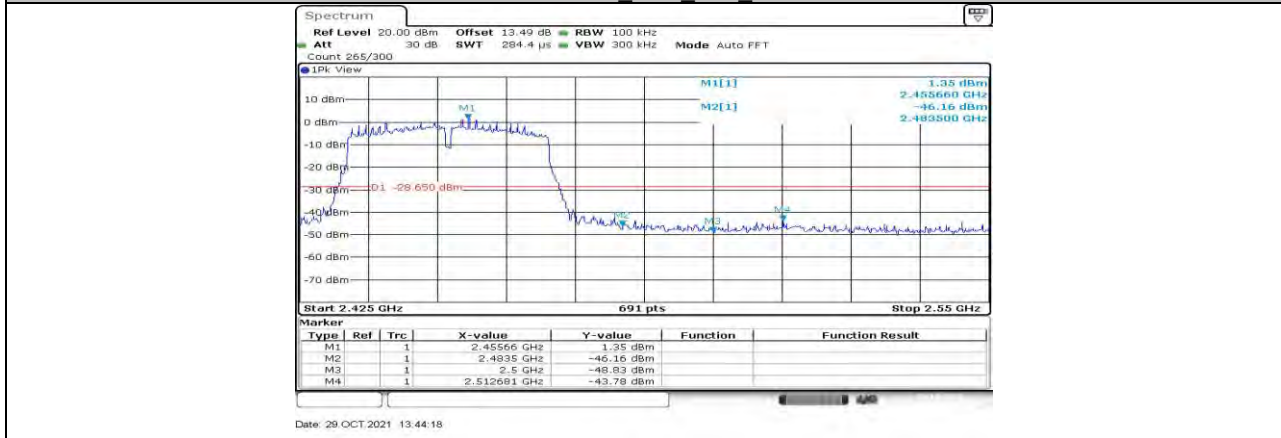

Date: 29 OCT 2021 13:44:18

11N40MIMO Ant1 High 2452

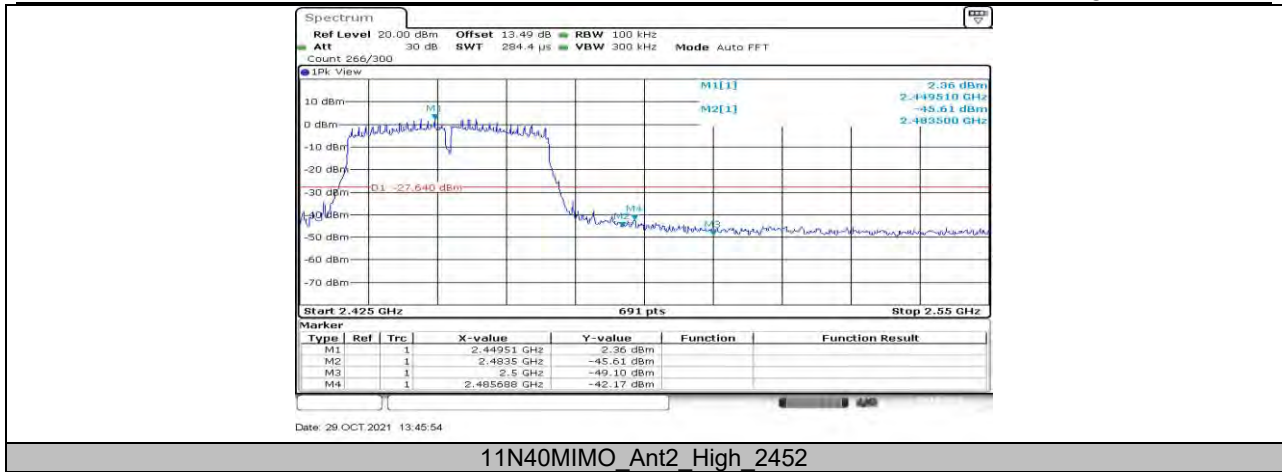

11N40MIMO\_Ant2\_High\_2452

**11.6. Appendix F: Conducted Spurious Emission****11.6.1. Test Result**

Test Mode	Antenna	Channel	FreqRange [Mhz]	Result [dBm]	Limit [dBm]	Verdict
11B	Ant1	2412	Reference	6.40	---	PASS
			30~1000	-54.42	≤-23.6	PASS
			1000~26500	-49.23	≤-23.6	PASS
	Ant2	2412	Reference	7.31	---	PASS
			30~1000	-55.08	≤-22.69	PASS
			1000~26500	-48.91	≤-22.69	PASS
	Ant1	2437	Reference	7.28	---	PASS
			30~1000	-54.42	≤-22.72	PASS
			1000~26500	-49.08	≤-22.72	PASS
	Ant2	2437	Reference	7.82	---	PASS
			30~1000	-53.75	≤-22.18	PASS
			1000~26500	-49.39	≤-22.18	PASS
	Ant1	2462	Reference	7.01	---	PASS
			30~1000	-54.79	≤-22.99	PASS
			1000~26500	-48.51	≤-22.99	PASS
	Ant2	2462	Reference	6.90	---	PASS
			30~1000	-55.03	≤-23.1	PASS
			1000~26500	-48.96	≤-23.1	PASS
11G	Ant1	2412	Reference	4.51	---	PASS
			30~1000	-54.38	≤-25.49	PASS
			1000~26500	-48.57	≤-25.49	PASS
	Ant2	2412	Reference	4.16	---	PASS
			30~1000	-54.3	≤-25.84	PASS
			1000~26500	-49.03	≤-25.84	PASS
	Ant1	2437	Reference	4.73	---	PASS
			30~1000	-54.21	≤-25.27	PASS
			1000~26500	-48.84	≤-25.27	PASS
	Ant2	2437	Reference	4.30	---	PASS
			30~1000	-54.05	≤-25.7	PASS
			1000~26500	-48.95	≤-25.7	PASS
	Ant1	2462	Reference	3.96	---	PASS
			30~1000	-54.61	≤-26.04	PASS
			1000~26500	-49.71	≤-26.04	PASS
	Ant2	2462	Reference	4.96	---	PASS
			30~1000	-54.07	≤-25.04	PASS
			1000~26500	-48.76	≤-25.04	PASS
11N20MIMO	Ant1	2412	Reference	4.27	---	PASS
			30~1000	-54.31	≤-25.73	PASS
			1000~26500	-49.3	≤-25.73	PASS
	Ant2	2412	Reference	5.20	---	PASS
			30~1000	-54.49	≤-24.8	PASS
			1000~26500	-48.19	≤-24.8	PASS
	Ant1	2437	Reference	4.61	---	PASS
			30~1000	-54.58	≤-25.39	PASS
			1000~26500	-48.03	≤-25.39	PASS
	Ant2	2437	Reference	5.24	---	PASS
			30~1000	-54.27	≤-24.76	PASS
			1000~26500	-49.61	≤-24.76	PASS
	Ant1	2462	Reference	5.03	---	PASS
			30~1000	-54.53	≤-24.97	PASS
			1000~26500	-49.4	≤-24.97	PASS
	Ant2	2462	Reference	5.42	---	PASS
			30~1000	-53.98	≤-24.58	PASS
			1000~26500	-49.32	≤-24.58	PASS



11N40MIMO	Ant1	2422	Reference	1.48	---	PASS
			30~1000	-53.99	$\leq -28.52$	PASS
			1000~26500	-49.23	$\leq -28.52$	PASS
	Ant2	2422	Reference	2.65	---	PASS
			30~1000	-54.4	$\leq -27.35$	PASS
			1000~26500	-49.54	$\leq -27.35$	PASS
	Ant1	2437	Reference	2.35	---	PASS
			30~1000	-54.47	$\leq -27.65$	PASS
			1000~26500	-48.67	$\leq -27.65$	PASS
	Ant2	2437	Reference	2.91	---	PASS
			30~1000	-54.66	$\leq -27.09$	PASS
			1000~26500	-48.5	$\leq -27.09$	PASS
	Ant1	2452	Reference	1.81	---	PASS
			30~1000	-54.76	$\leq -28.19$	PASS
			1000~26500	-49.4	$\leq -28.19$	PASS
	Ant2	2452	Reference	2.46	---	PASS
			30~1000	-54.45	$\leq -27.54$	PASS
			1000~26500	-49.67	$\leq -27.54$	PASS



### 11.6.2. Test Graphs



11B\_Ant1\_2412\_0~Reference

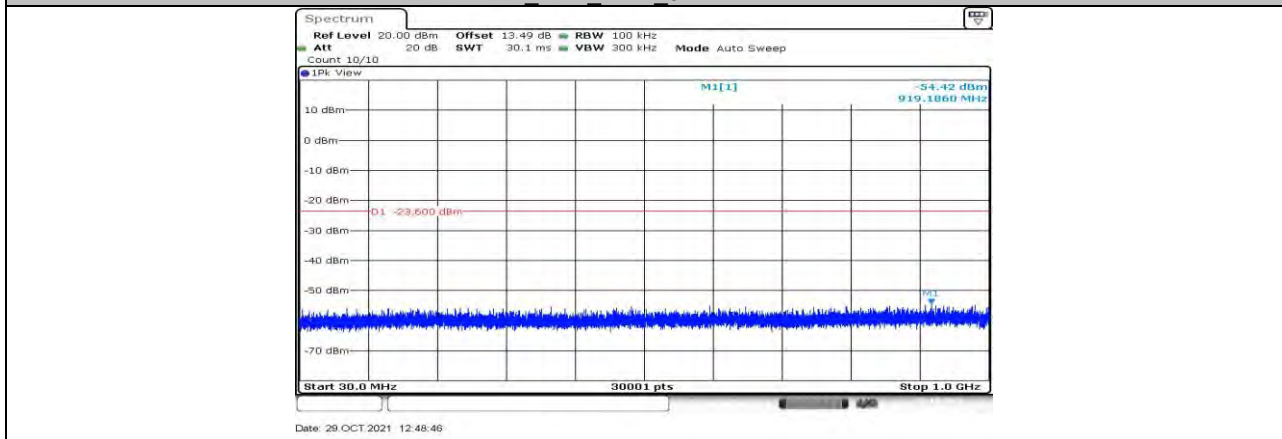

11B\_Ant1\_2412\_30~1000

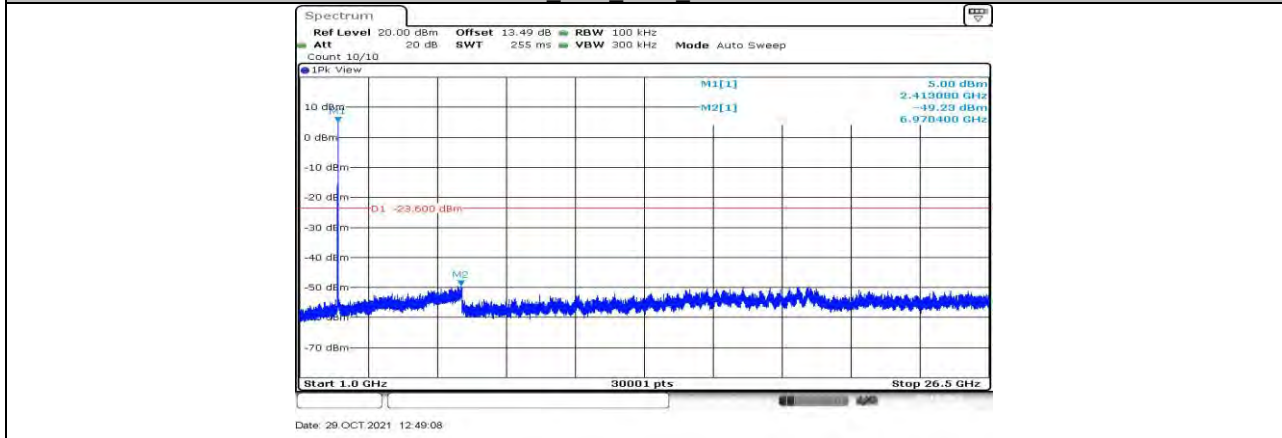

11B\_Ant1\_2412\_1000~26500



Date: 29.OCT.2021 13:01:01

11B\_Ant2\_2412\_0~Reference

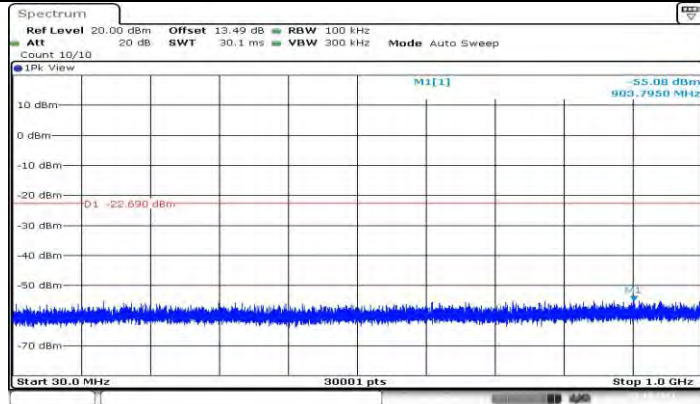

Date: 29.OCT.2021 13:01:06

11B\_Ant2\_2412\_30~1000

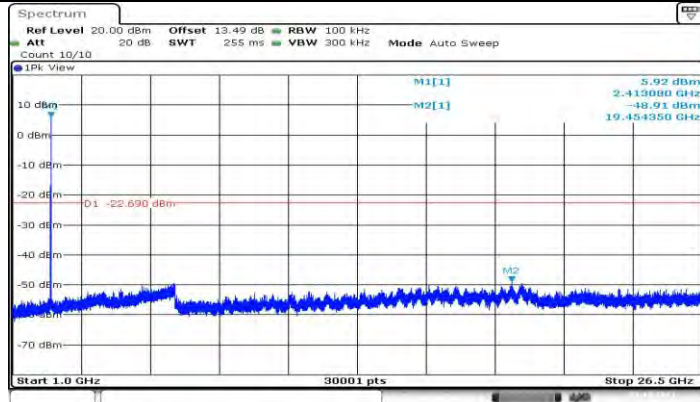

Date: 29.OCT.2021 13:01:27

11B\_Ant2\_2412\_1000~26500



Date: 29 OCT 2021 12:50:22

11B\_Ant1\_2437\_0~Reference

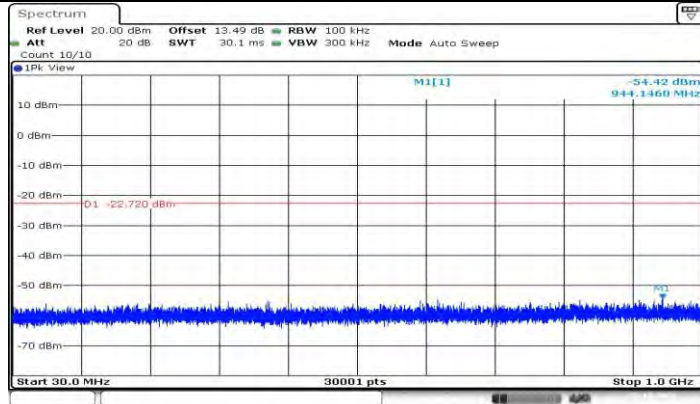

Date: 29 OCT 2021 12:50:28

11B\_Ant1\_2437\_30~1000

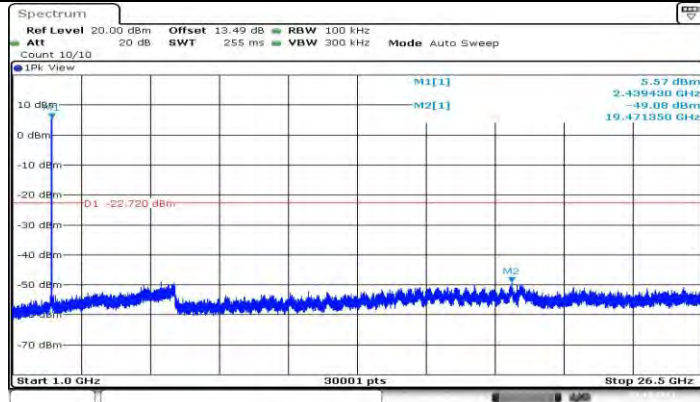

Date: 29 OCT 2021 12:50:47

11B\_Ant1\_2437\_1000~26500



Date: 29 OCT 2021 13:02:54

11B\_Ant2\_2437\_0~Reference

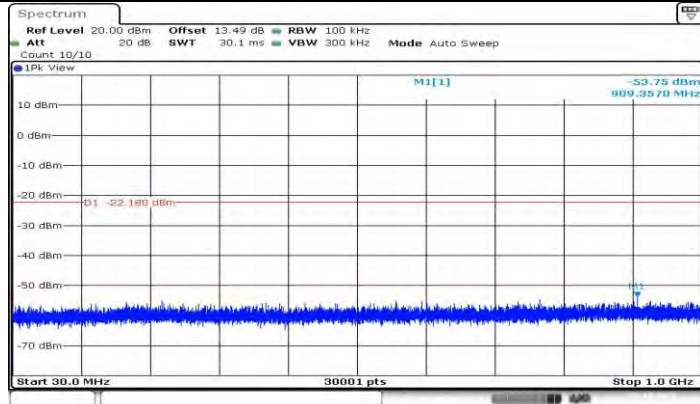

Date: 29 OCT 2021 13:02:59

11B\_Ant2\_2437\_30~1000

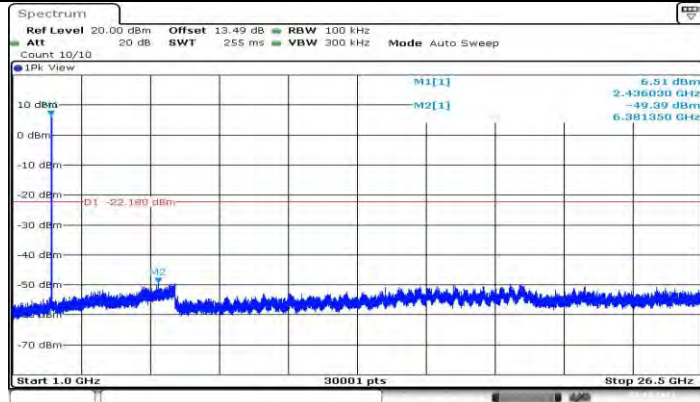

Date: 29 OCT 2021 13:03:20

11B\_Ant2\_2437\_1000~26500

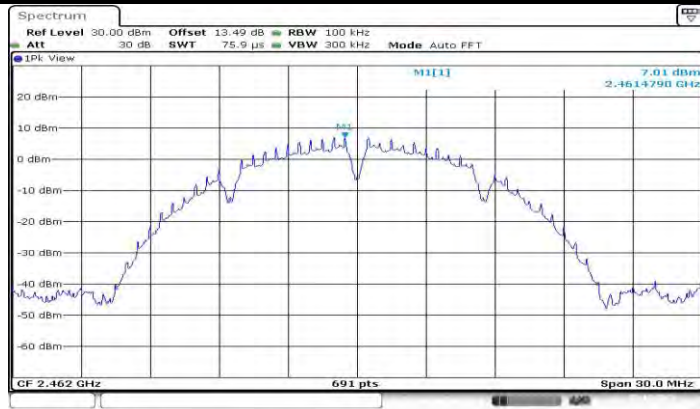

Date: 29.OCT.2021 12:52:24

11B\_Ant1\_2462\_0~Reference

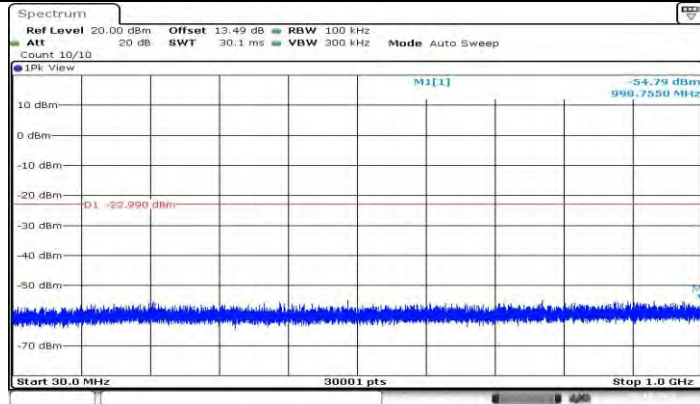

Date: 29.OCT.2021 12:52:29

11B\_Ant1\_2462\_30~1000

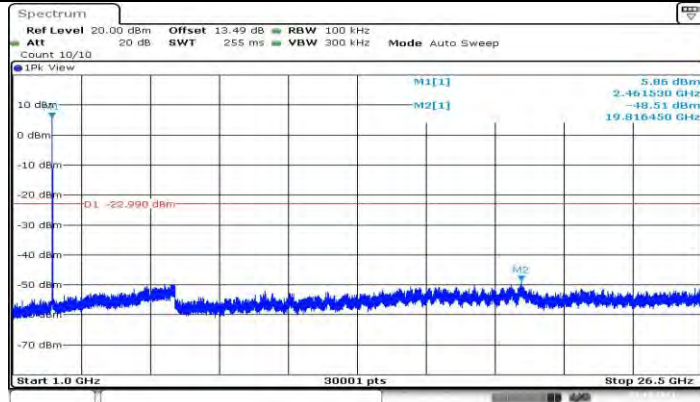

Date: 29.OCT.2021 12:52:50

11B\_Ant1\_2462\_1000~26500



Date: 29.OCT.2021 13:05:10

11B\_Ant2\_2462\_0~Reference

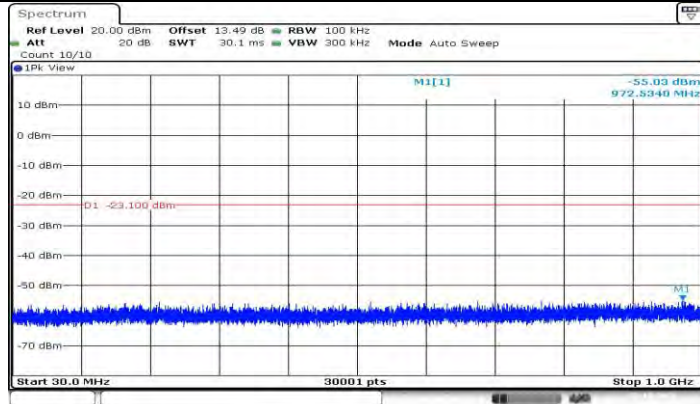

Date: 29.OCT.2021 13:05:14

11B\_Ant2\_2462\_30~1000

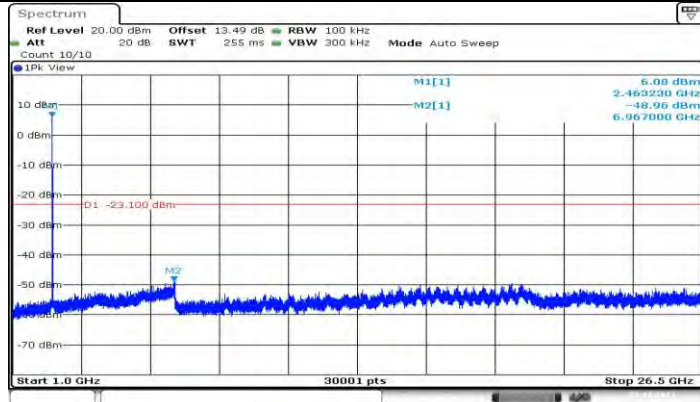

Date: 29.OCT.2021 13:05:35

11B\_Ant2\_2462\_1000~26500

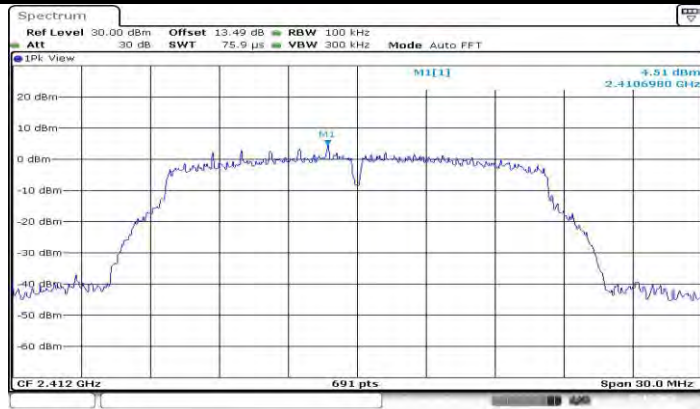

Date: 29.OCT.2021 12:55:01

11G Ant1\_2412\_0~Reference

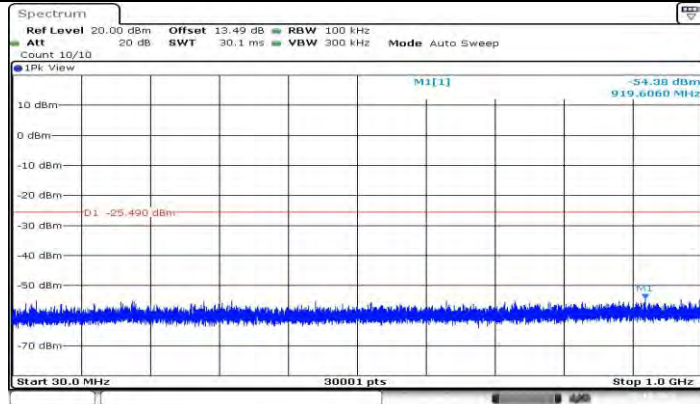

Date: 29.OCT.2021 12:55:05

11G Ant1\_2412\_30~1000

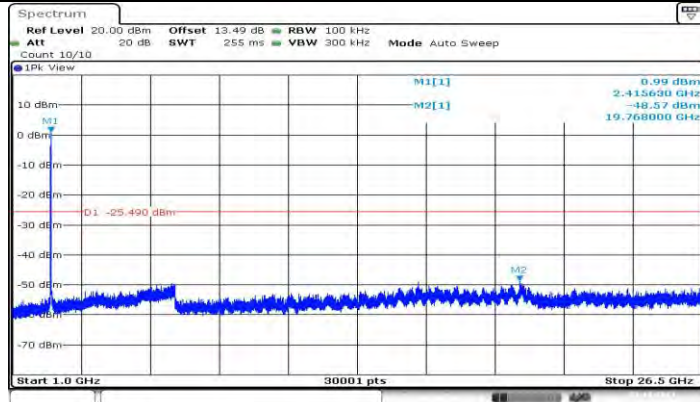

Date: 29.OCT.2021 12:55:28

11G Ant1\_2412\_1000~26500



Date: 29.OCT.2021 13:07:10

11G\_Ant2\_2412\_0~Reference

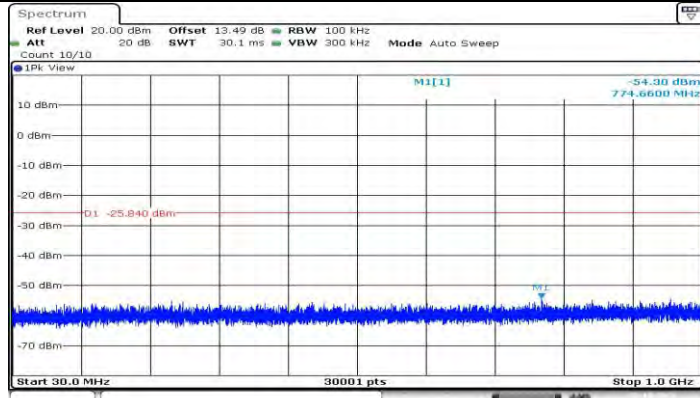

Date: 29.OCT.2021 13:07:14

11G\_Ant2\_2412\_30~1000

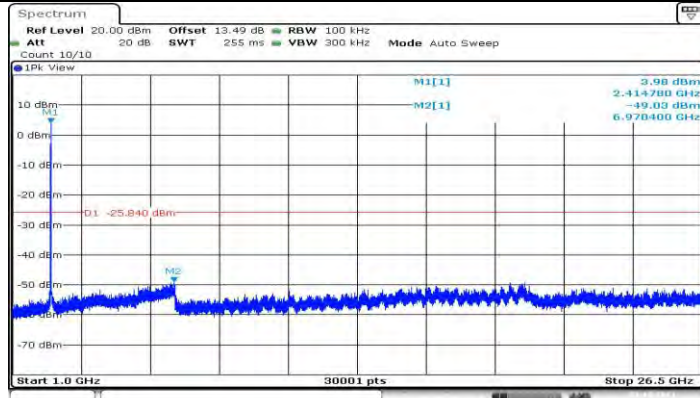

Date: 29.OCT.2021 13:07:38

11G\_Ant2\_2412\_1000~26500





11G Ant1\_2437\_0~Reference

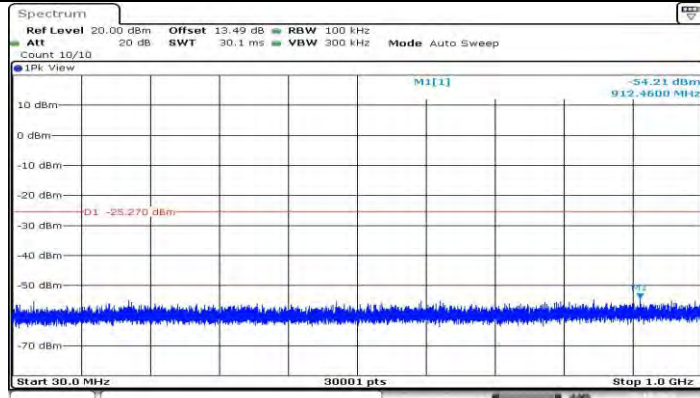

11G Ant1\_2437\_30~1000

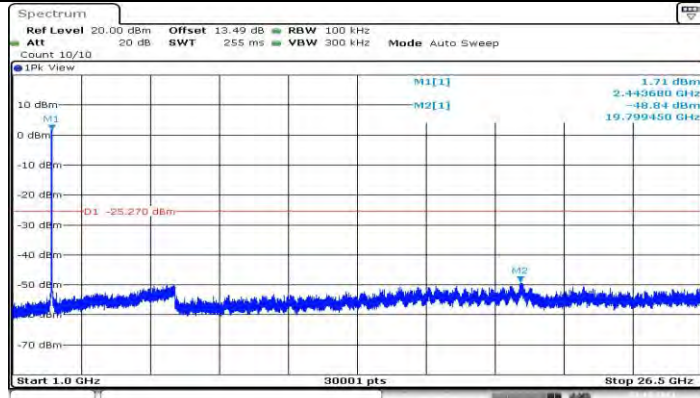

11G Ant1\_2437\_1000~26500



11G\_Ant2\_2437\_0~Reference

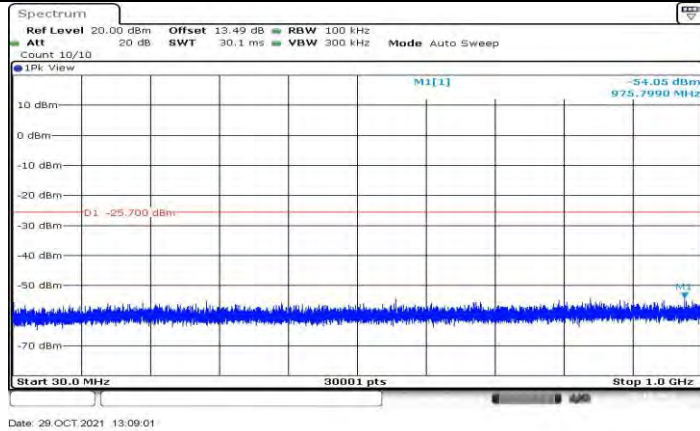

11G\_Ant2\_2437\_30~1000

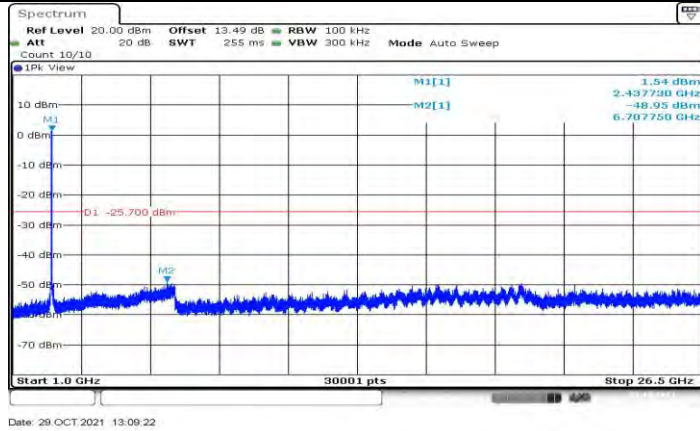

11G\_Ant2\_2437\_1000~26500

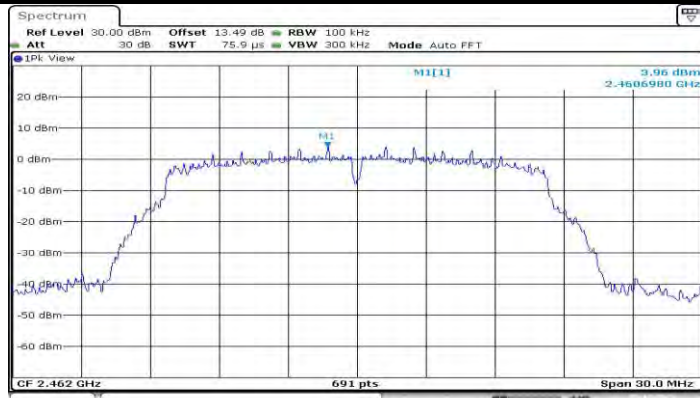

Date: 29.OCT.2021 12:58:44

11G\_Ant1\_2462\_0~Reference

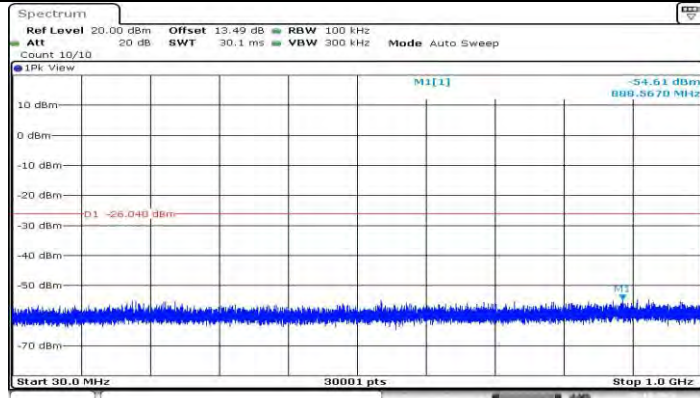

Date: 29.OCT.2021 12:58:48

11G\_Ant1\_2462\_30~1000

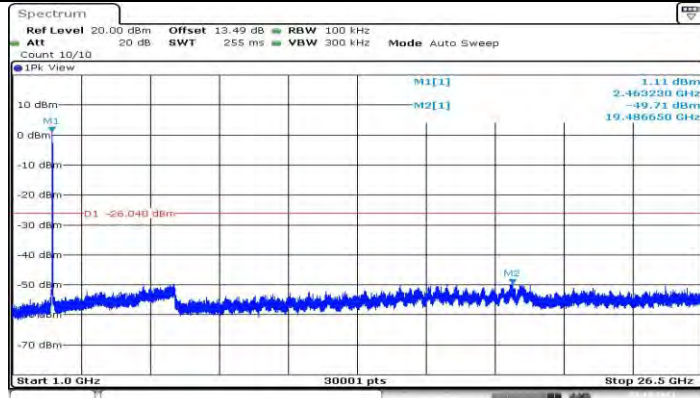

Date: 29.OCT.2021 12:59:10

11G\_Ant1\_2462\_1000~26500



Date: 29.OCT.2021 13:10:44

11G\_Ant2\_2462\_0~Reference

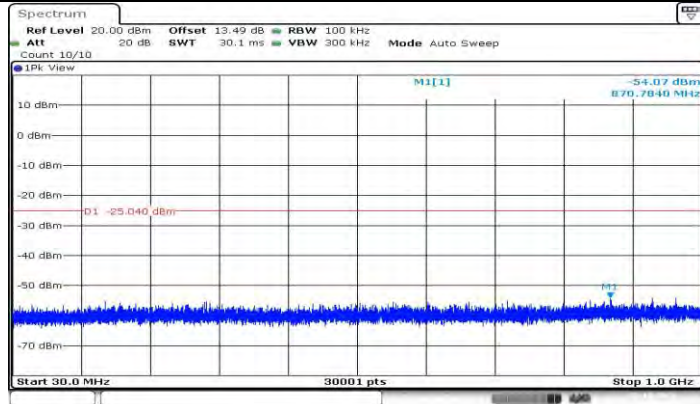

Date: 29.OCT.2021 13:10:48

11G\_Ant2\_2462\_30~1000

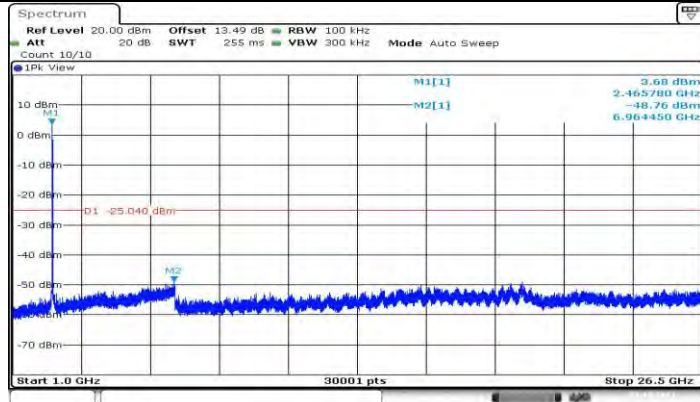

Date: 29.OCT.2021 13:11:09

11G\_Ant2\_2462\_1000~26500

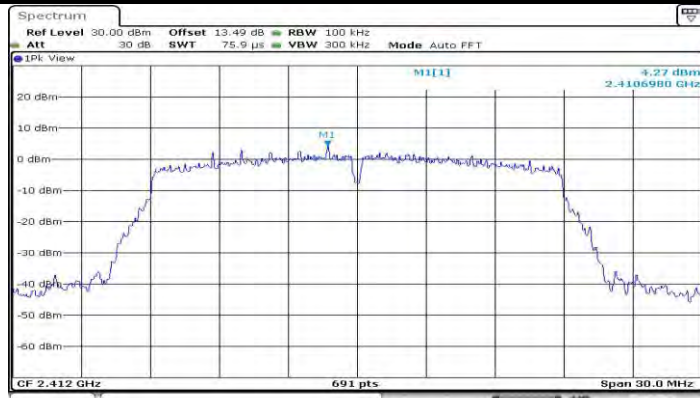

Date: 29.OCT.2021 13:13:02

11N20MIMO\_Ant1\_2412\_0~Reference

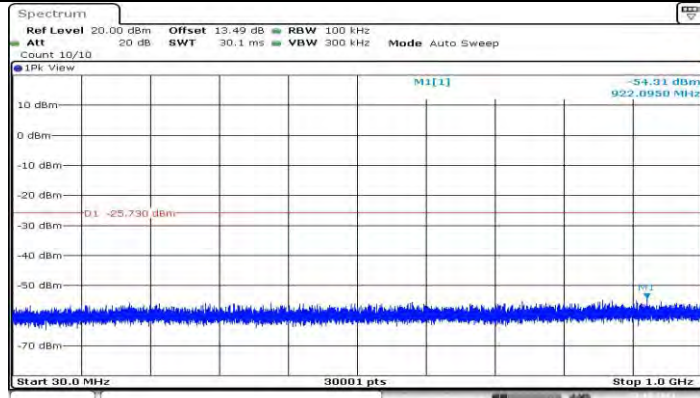

Date: 29.OCT.2021 13:13:06

11N20MIMO\_Ant1\_2412\_30~1000

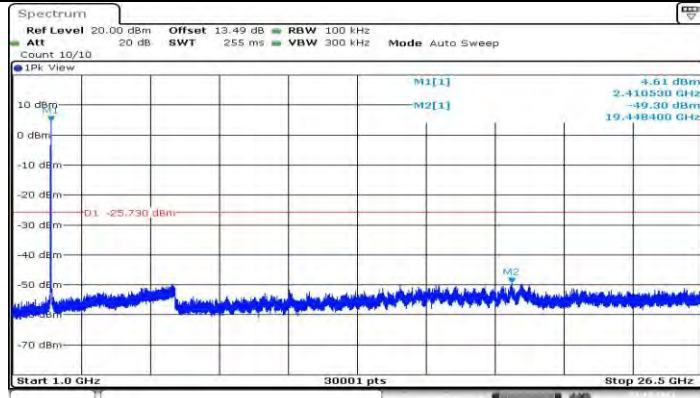

Date: 29.OCT.2021 13:13:28

11N20MIMO\_Ant1\_2412\_1000~26500

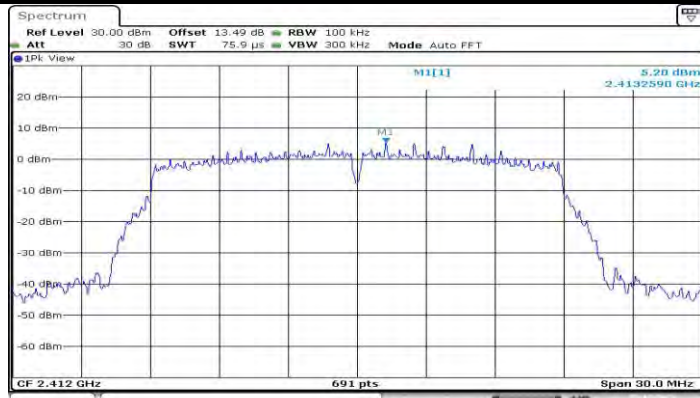

11N20MIMO\_Ant2\_2412\_0~Reference

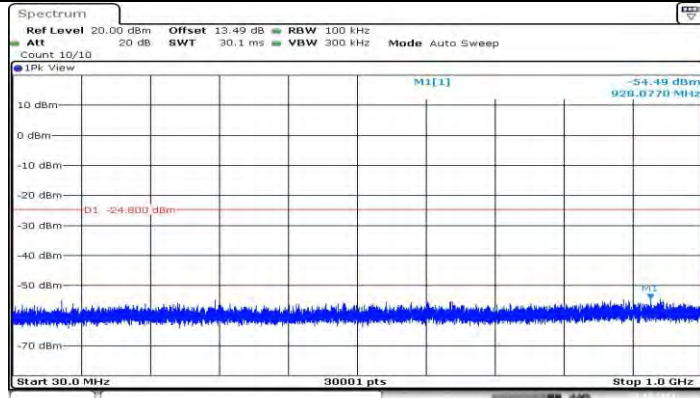

11N20MIMO\_Ant2\_2412\_30~1000

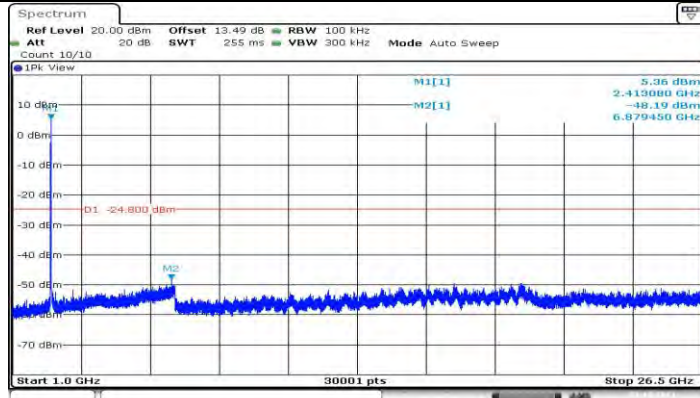

11N20MIMO\_Ant2\_2412\_1000~26500

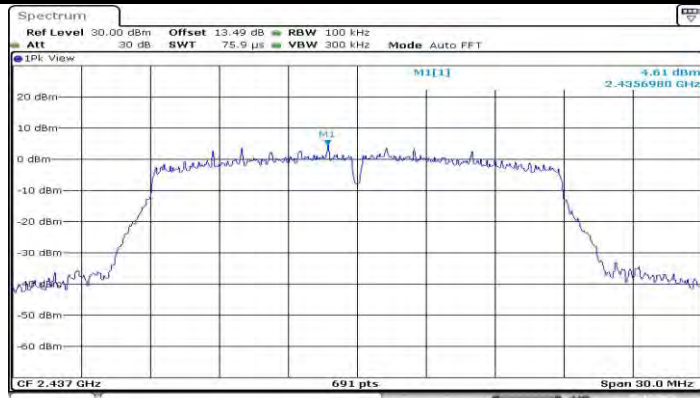

Date: 29 OCT 2021 13:25:22

11N20MIMO\_Ant1\_2437\_0~Reference

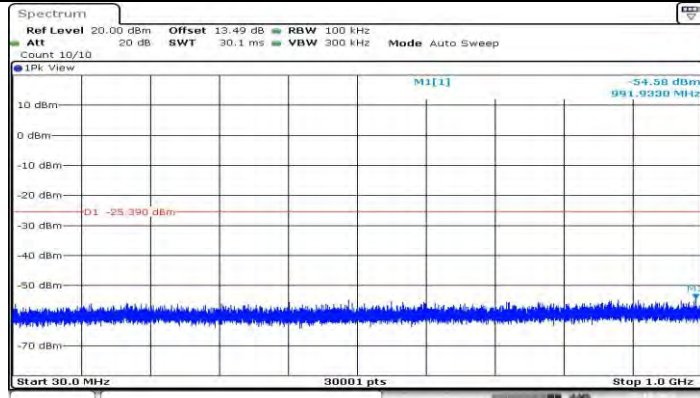

Date: 29 OCT 2021 13:25:26

11N20MIMO\_Ant1\_2437\_30~1000

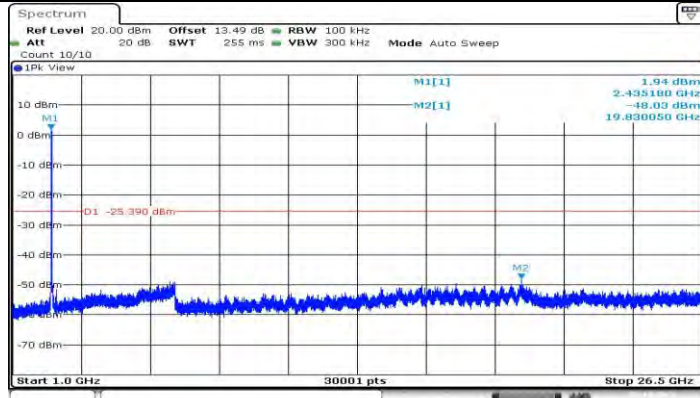

Date: 29 OCT 2021 13:25:48

11N20MIMO\_Ant1\_2437\_1000~26500

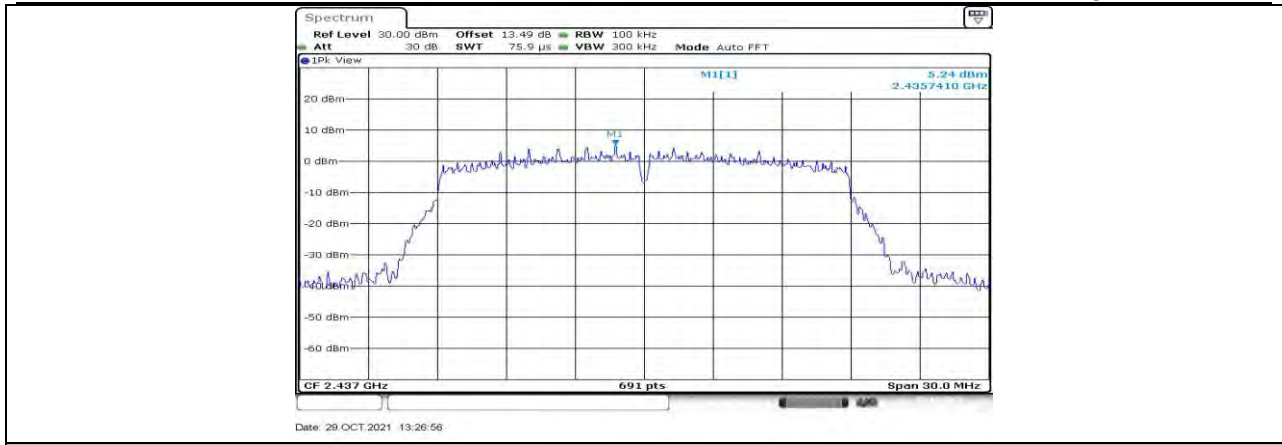

11N20MIMO\_Ant2\_2437\_0~Reference

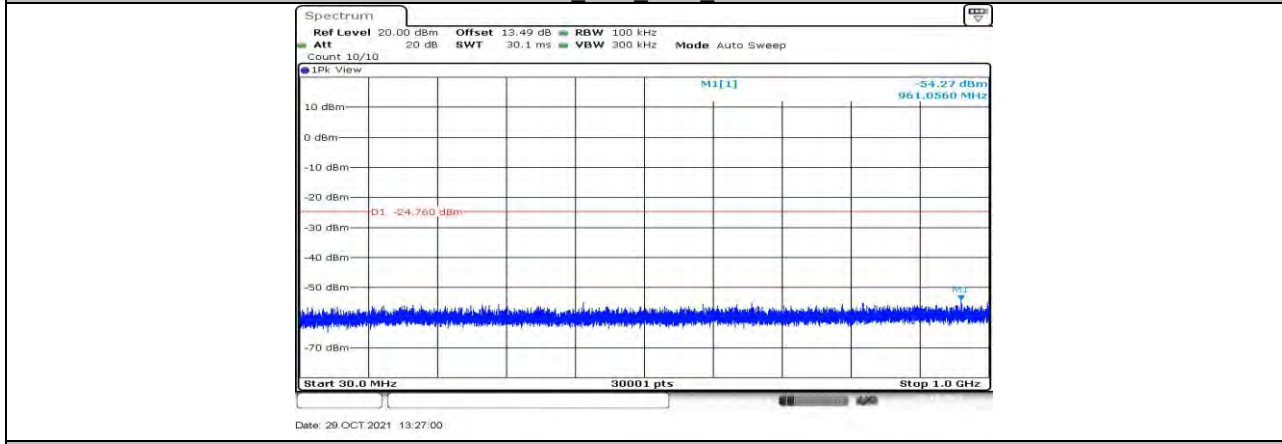

11N20MIMO\_Ant2\_2437\_30~1000

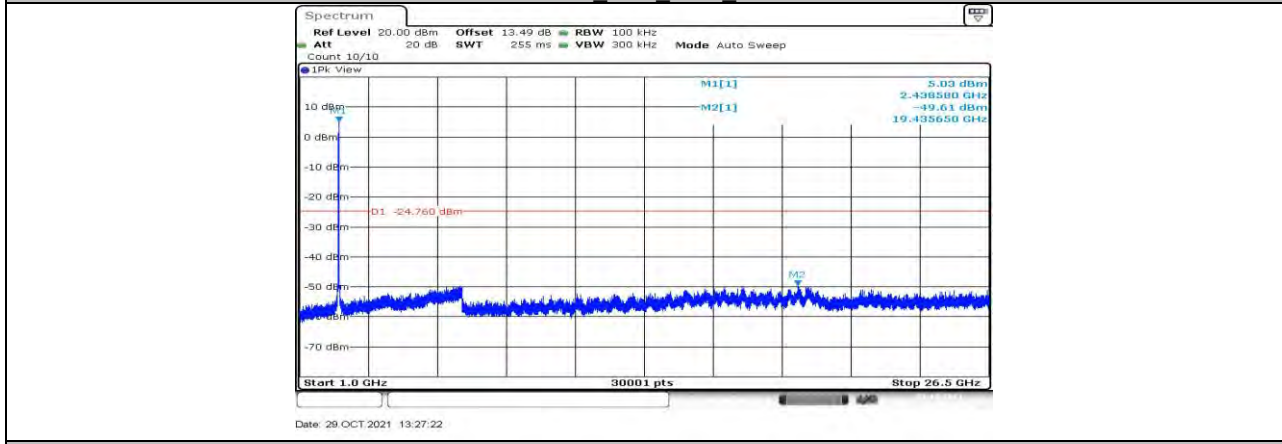

11N20MIMO\_Ant2\_2437\_1000~26500



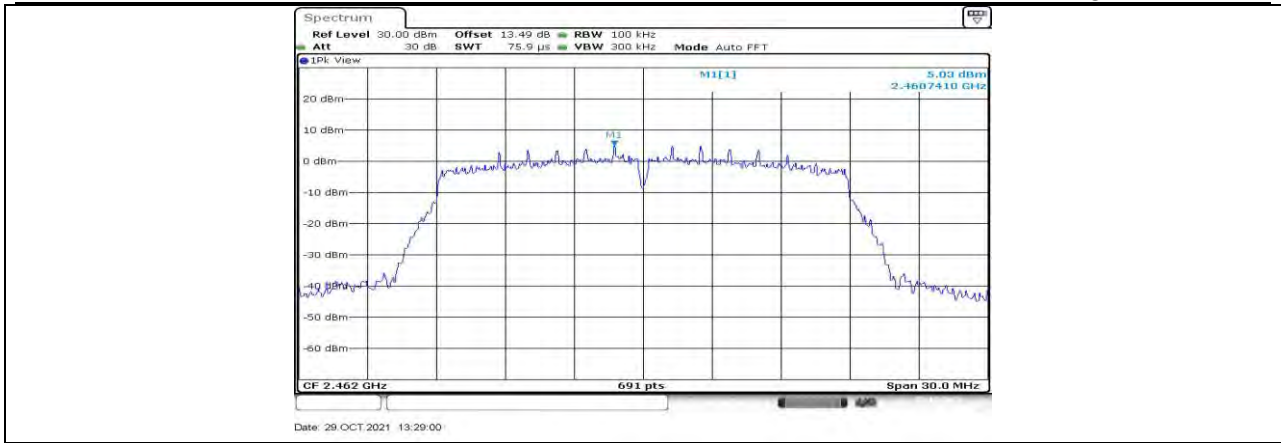

11N20MIMO Ant1\_2462\_0~Reference

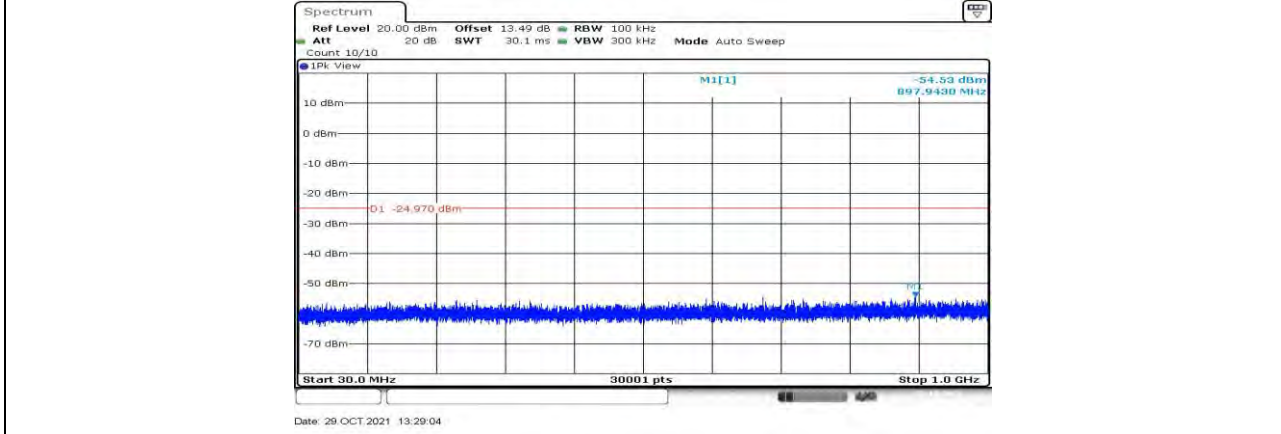

11N20MIMO Ant1\_2462\_30~1000

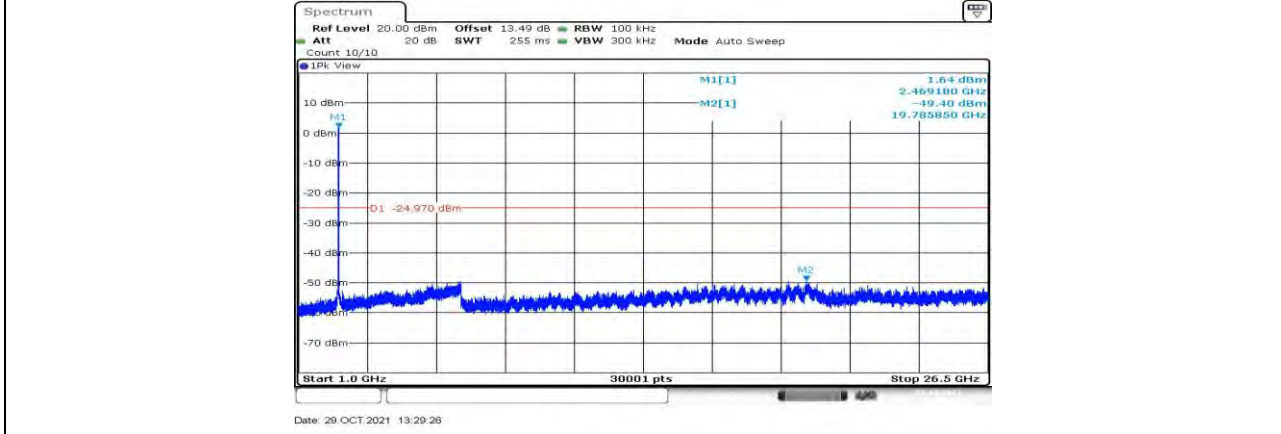

11N20MIMO Ant1\_2462\_1000~26500

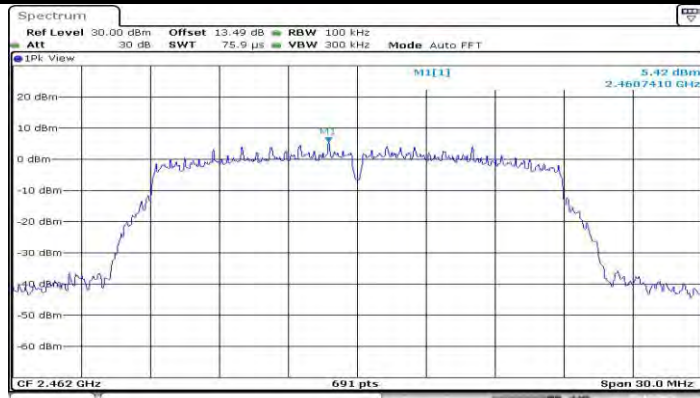

Date: 29.OCT.2021 13:30:30

11N20MIMO\_Ant2\_2462\_0~Reference

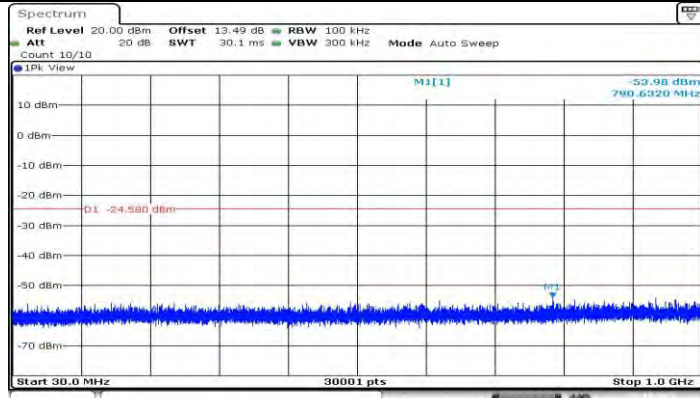

Date: 29.OCT.2021 13:30:35

11N20MIMO\_Ant2\_2462\_30~1000

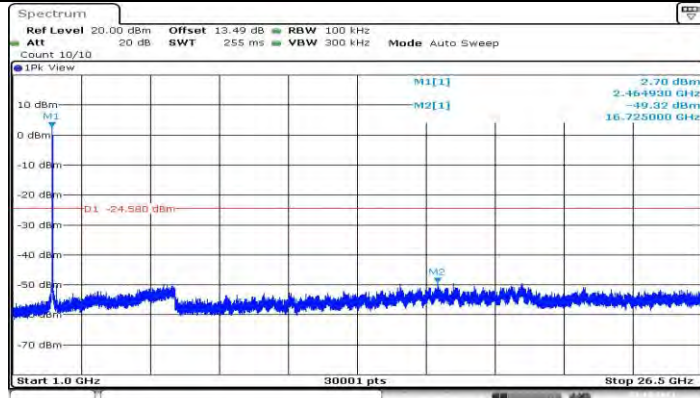

Date: 29.OCT.2021 13:30:58

11N20MIMO\_Ant2\_2462\_1000~26500

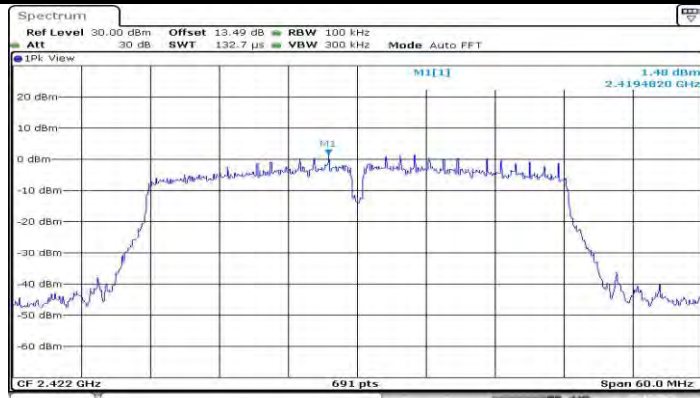

Date: 29.OCT.2021 13:37:15

11N40MIMO\_Ant1\_2422\_0~Reference

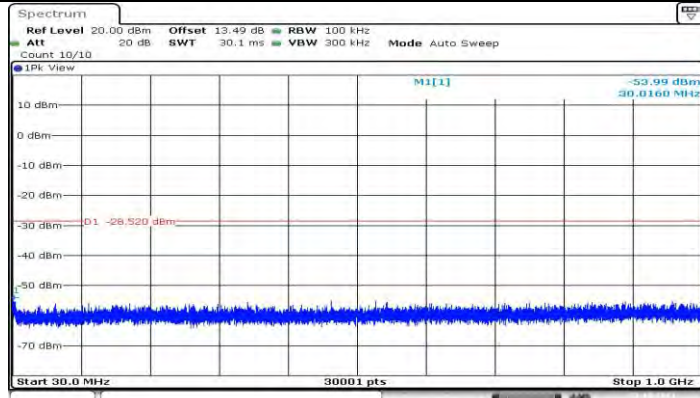

Date: 29.OCT.2021 13:37:19

11N40MIMO\_Ant1\_2422\_30~1000

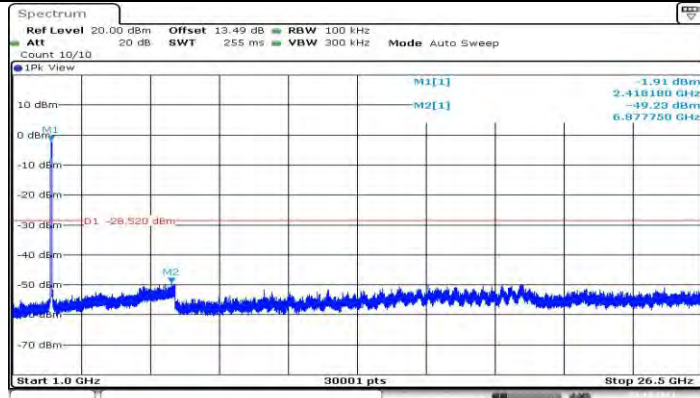

Date: 29.OCT.2021 13:37:40

11N40MIMO\_Ant1\_2422\_1000~26500



11N40MIMO\_Ant2\_2422\_0~Reference

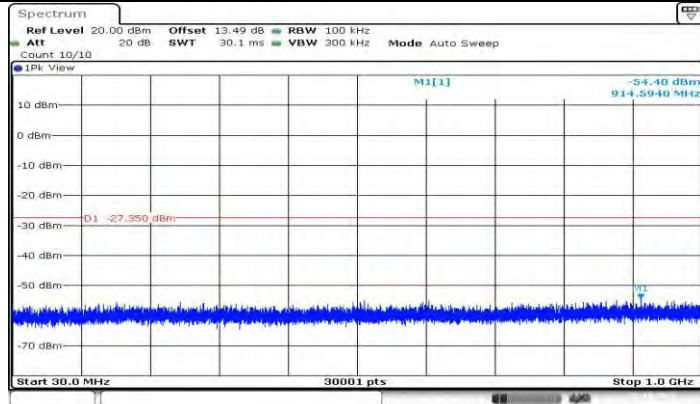

11N40MIMO\_Ant2\_2422\_30~1000

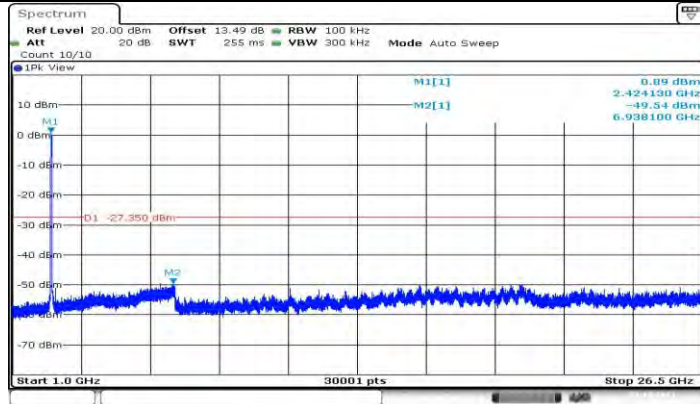

11N40MIMO\_Ant2\_2422\_1000~26500

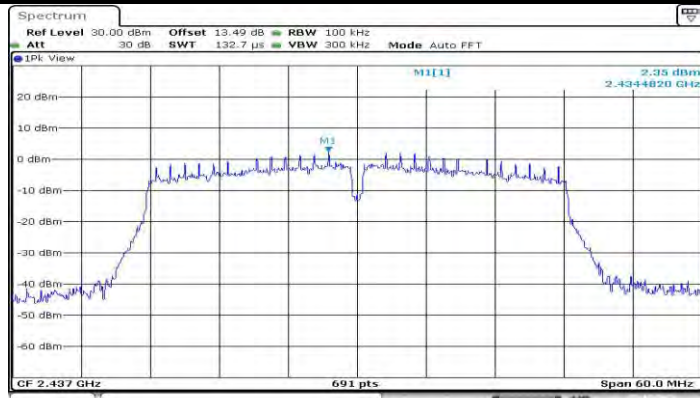

11N40MIMO Ant1 2437 0~Reference

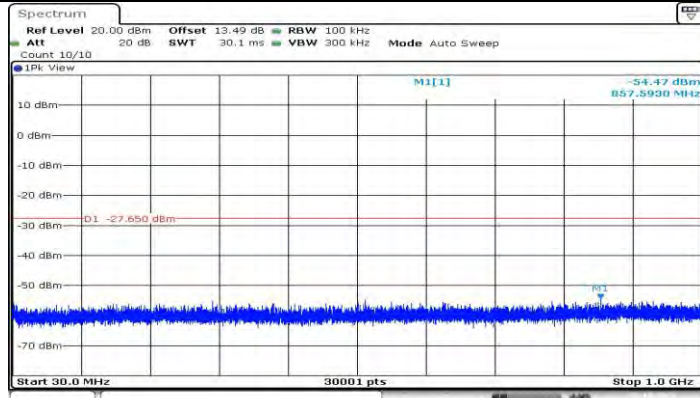

11N40MIMO Ant1 2437 30~1000

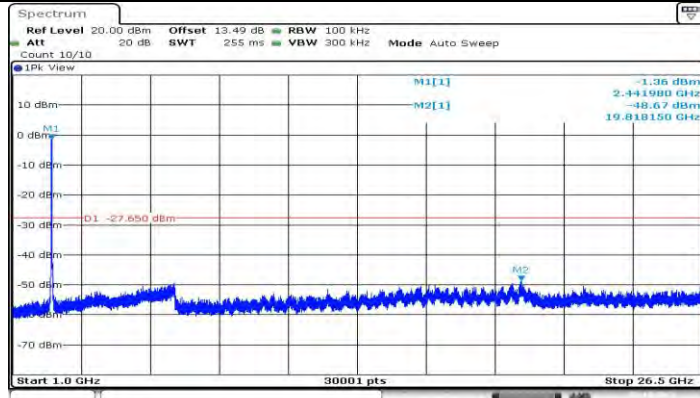

11N40MIMO Ant1 2437 1000~26500

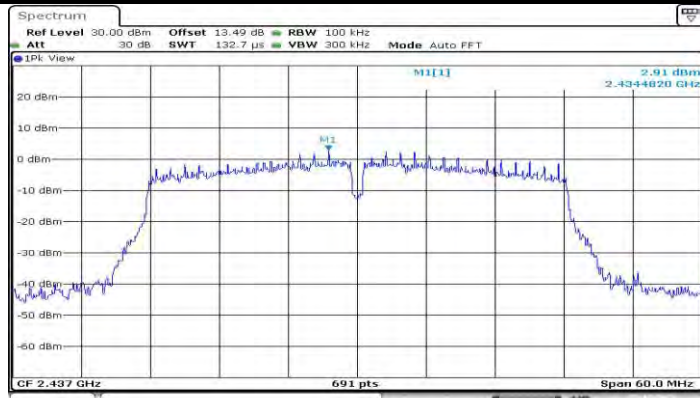

Date: 29 OCT 2021 13:42:24

11N40MIMO\_Ant2\_2437\_0~Reference

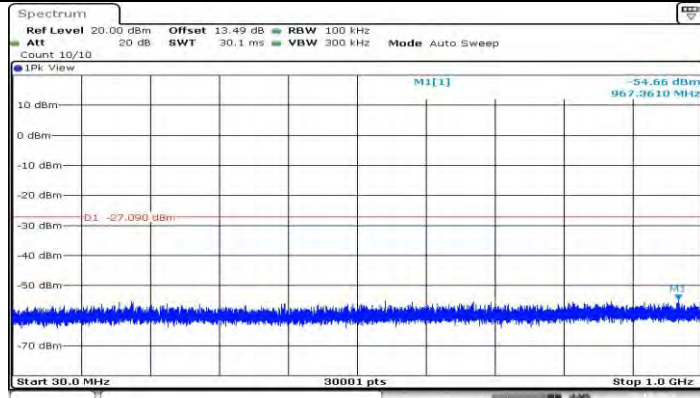

Date: 29 OCT 2021 13:42:28

11N40MIMO\_Ant2\_2437\_30~1000

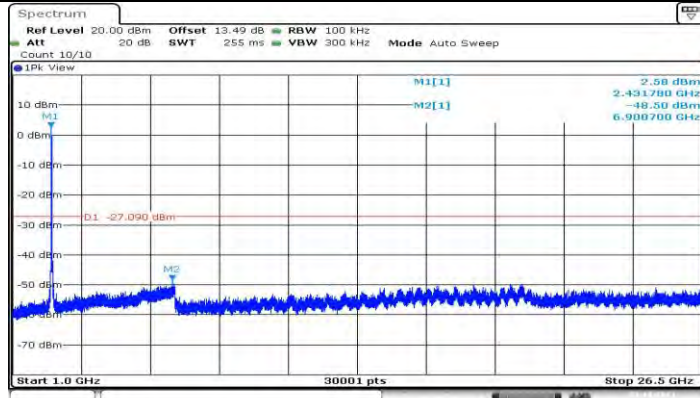

Date: 29 OCT 2021 13:42:50

11N40MIMO\_Ant2\_2437\_1000~26500

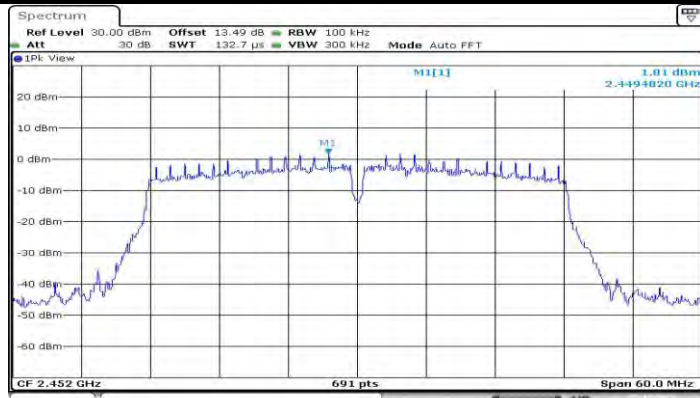

Date: 29 OCT 2021 13:44:24

11N40MIMO\_Ant1\_2452\_0~Reference

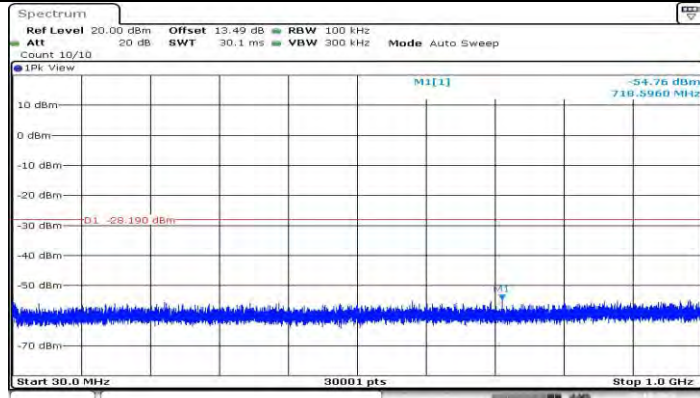

Date: 29 OCT 2021 13:44:29

11N40MIMO\_Ant1\_2452\_30~1000

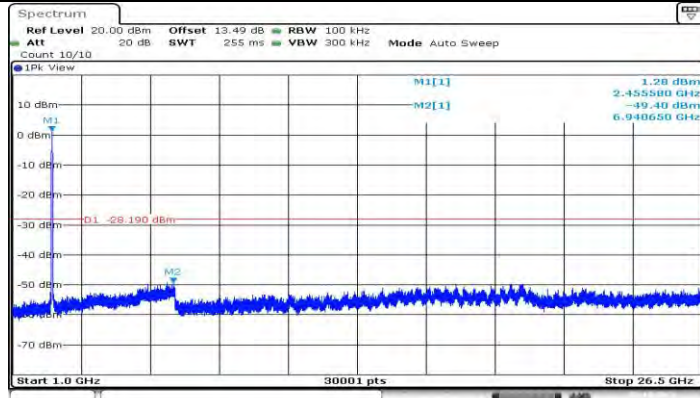

Date: 29 OCT 2021 13:44:50

11N40MIMO\_Ant1\_2452\_1000~26500

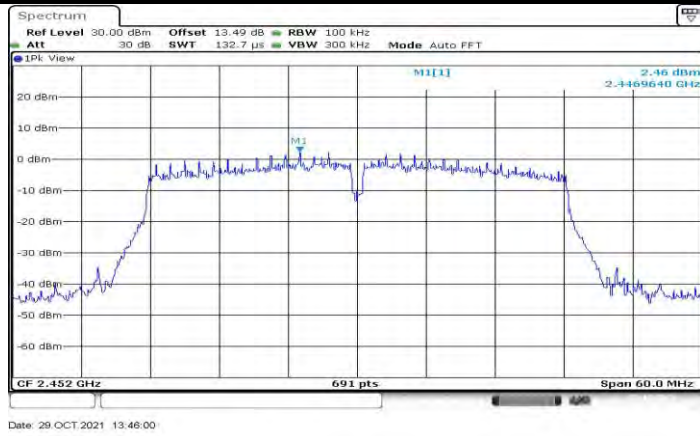

11N40MIMO\_Ant2\_2452\_0~Reference

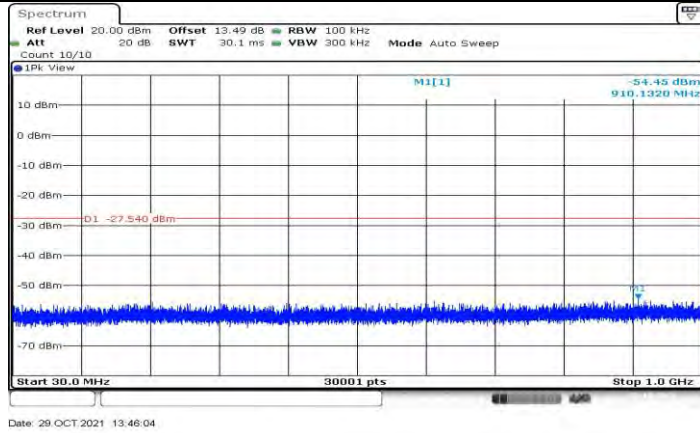

11N40MIMO\_Ant2\_2452\_30~1000

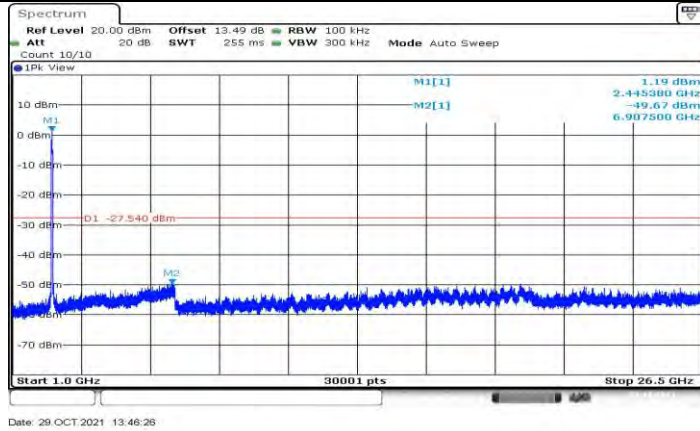

11N40MIMO\_Ant2\_2452\_1000~26500





**11.7. Appendix G: Duty Cycle**  
**11.7.1. Test Result**

Test Mode	On Time (msec)	Period (msec)	Duty Cycle x (Linear)	Duty Cycle (%)	Duty Cycle Correction Factor (dB)	1/T Minimum VBW (kHz)	Final setting For VBW (kHz)
11B	8.36	8.39	0.9964	99.64	0.02	0.12	0.01
11G	1.39	1.43	0.9720	97.20	0.12	0.72	1
11N20MIMO	1.29	1.34	0.9627	96.27	0.17	0.78	1
11N40MIMO	0.64	0.69	0.9275	92.75	0.33	1.56	2

Note:

Duty Cycle Correction Factor=10log (1/x).

Where: x is Duty Cycle (Linear)

Where: T is On Time

If that calculated VBW is not available on the analyzer then the next higher value should be used.

### 11.7.2. Test Graphs

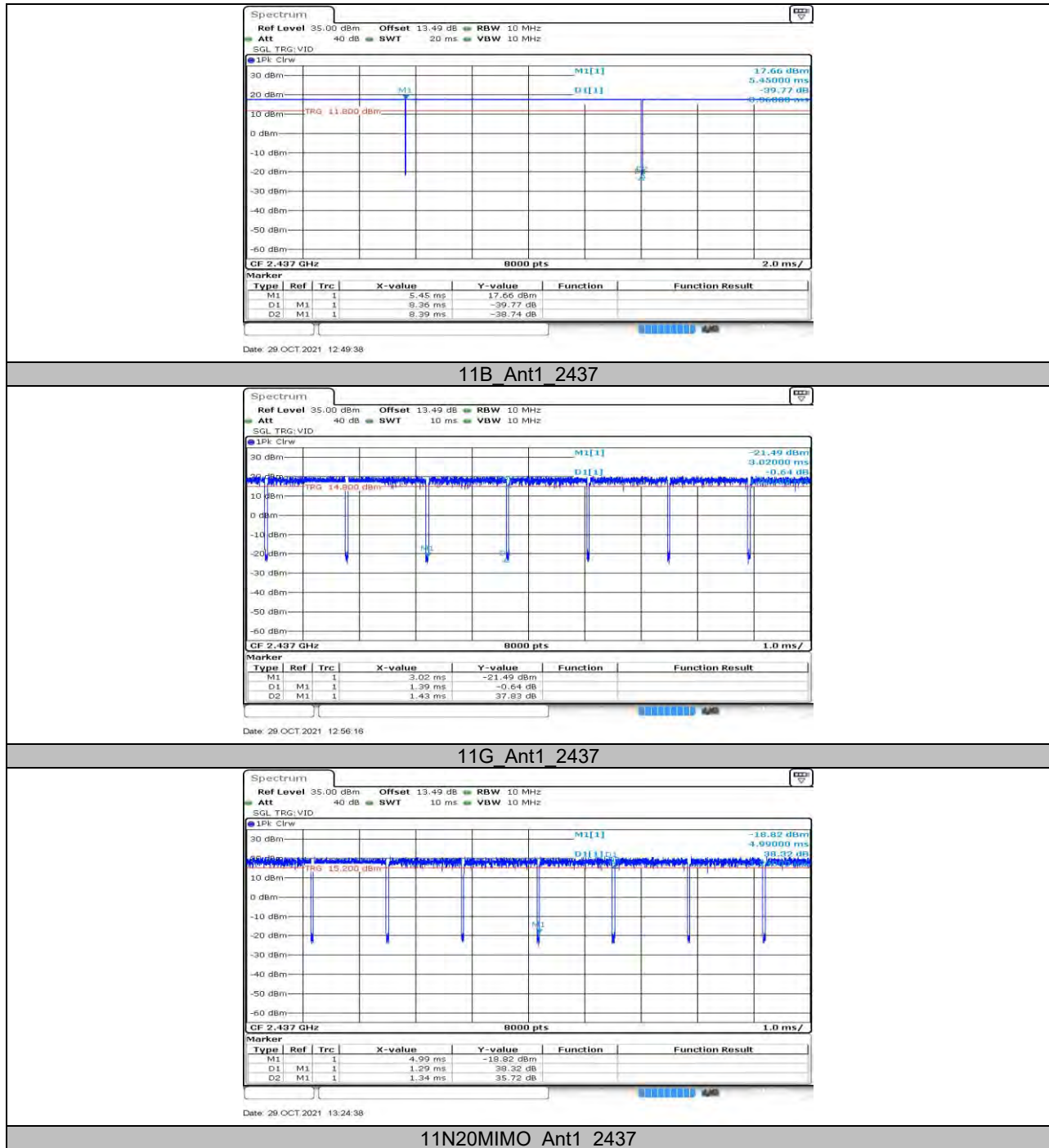

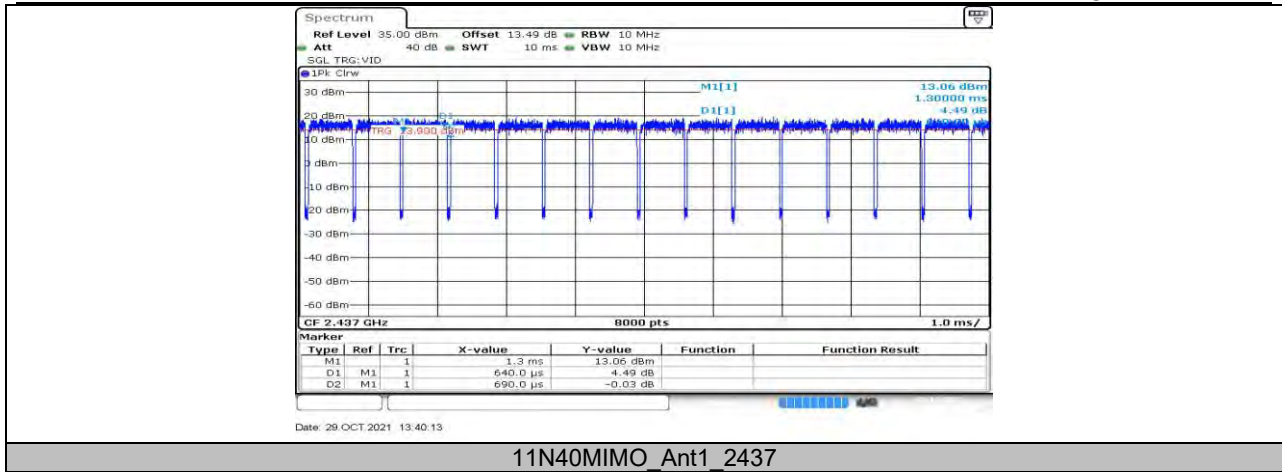

END OF REPORT