



# FCC TEST REPORT

**Report No.:** BUMK-ESH-P20102044B-2

**Product:** Smart Camera

**Test Model:** SC002-WP2

**Received:** Oct.30, 2020

**ISSUED:** Nov.19, 2020

**Applicant:** Zhejiang Tuya Smart Electronics Co., Ltd

**Address:** Room 901, Building 1, Huace Center, Xihu District, Hangzhou,  
Zhejiang Province, China

**Issued By:** BUREAU VERITAS ADT (Shanghai) Corporation

**Lab Location:** No. 829, Xinzhuan Road, Shanghai, P.R.China (201612)

This test report consists of 35 pages in total. It may be duplicated completely for legal use with the approval of the applicant. It should not be reproduced except in full, without the written approval of our laboratory. The client should not use it to claim product certification, approval, or endorsement by A2LA, CNAS, or any government agency. The test results in the report only apply to the tested item. The test results in this report are traceable to the national or international standards.





**BUREAU  
VERITAS**

# Contents

<b>1. TEST PROGRAM .....</b>	<b>3</b>
<b>2. Summary of Test Procedure and Test Results.....</b>	<b>4</b>
<b>3. Test Configuration of Equipment under Test .....</b>	<b>5</b>
3.1 Manufacturer information .....	5
3.2 Feature of Equipment under Test.....	5
3.3 Description of support units.....	5
3.4 Measurement Uncertainty .....	6
<b>4 Test of Conducted Emission.....</b>	<b>7</b>
4.1 Test Limit .....	7
4.2 Test Procedures .....	8
4.3 Typical Test Setup .....	8
4.4 Measurement Equipment.....	9
4.5 Test Result and Data .....	10
4.6 Test Photographs .....	18
<b>5 Test of Radiated Emission .....</b>	<b>19</b>
5.1 Test Limit .....	19
5.2 Test Procedures .....	20
5.3 Typical Test Setup .....	20
5.4 Measurement Equipment.....	21
5.5 Test Result and Data (30MHz ~ 1GHz).....	22
5.6 Test Result and Data (1GHz ~ 18GHz).....	26
5.7 Test Photographs (30MHz ~ 1000MHz).....	30
5.8 Test Photographs (1000MHz ~ 18000MHz).....	31
<b>6 Photographs of EUT .....</b>	<b>32</b>

## 1. TEST PROGRAM

**PRODUCT:** Smart Camera  
**TEST MODEL:** SC002-WP2  
**APPLICANT:** Zhejiang Tuya Smart Electronics Co., Ltd  
**TESTED:** Nov.02 to Nov.18, 2020  
**STANDARDS:** 47 CFR FCC Part15, Subpart B, Class B  
ANSI C63.4:2014

We, BUREAU VERITAS ADT (Shanghai) Corporation, declare that the equipment above has been tested and found compliance with the requirement limits of applicable standards. The test record, data evaluation and Equipment Under Test (EUT) configurations represented herein are true and accurate under the standards herein specified.

**PREPARED BY :** Yuan Zhang , **DATE:** Nov.19, 2020  
Yuan ZHANG  
Project Engineer

**APPROVED BY :** Daniel Sun , **DATE:** Nov.19, 2020  
Daniel Sun  
EMC Lab Manager





**BUREAU  
VERITAS**

## 2. Summary of Test Procedure and Test Results

EMISSION (47 CFR FCC Part15, Subpart B)		
Test Item	Normative References	Test Result
Conducted Emission	47 CFR FCC Part15, Subpart B 15.107	Meets the Class B requirements
Radiated Emission	47 CFR FCC Part15, Subpart B 15.109	Meets the Class B requirements

### 3. Test Configuration of Equipment under Test

#### 3.1 Manufacturer information

Manufacturer : Zhejiang Tuya Smart Electronics Co., Ltd

Address : Room 901, Building 1, Huace Center, Xihu District, Hangzhou, Zhejiang  
Province, China

#### 3.2 Feature of Equipment under Test

<b>Product Name:</b>	Smart Camera
<b>Test Model:</b>	SC002-WP2
<b>Model Discrepancy:</b>	--
<b>EUT Power Rating:</b>	5VDC/1A with adaptor 100-240Vac~, 50/60Hz

Note:

1. Please refer to user manual.

#### 3.3 Description of support units

NO.	PRODUCT	BRAND	MODEL NO.
1	Mobile Phone	Vivo	--
2	Adaptor	Shenzhen Keyu Power Supply Technology Co., Ltd	KA06E-0501000US
3	Adaptor	Shenzhen Teka Technology Co., Ltd	TEKA-UCA10US

### 3.4 Measurement Uncertainty

Where relevant, the following measurement uncertainty levels have been estimated for tests performed on the EUT:

This listed uncertainties are the worst case uncertainty for the entire range of measurement. Please note that the uncertainty values are provided for informational purposes only and are not used in determining the PASS/FAIL results.

<b>Measurement</b>		<b>Value</b>
Conducted emissions		2.55 dB
Radiated emissions	30 MHz ~ 1GHz	3.22 dB
	Above 1GHz	2.89 dB

## 4 Test of Conducted Emission

### 4.1 Test Limit

**TEST STANDARD:**

**CFR 47 FCC Part 15, Subpart B (Section: 15.107)**

FREQUENCY (MHz)	Class A (dB $\mu$ V)		Class B (dB $\mu$ V)	
	Quasi-peak	Average	Quasi-peak	Average
0.15 - 0.5	79	66	66 - 56	56 - 46
0.50 - 5.0	73	60	56	46
5.0 - 30.0	73	60	60	50

- NOTES:**
1. The lower limit shall apply at the transition frequencies.
  2. The limit decreases in line with the logarithm of the frequency in the range of 0.15 to 0.50MHz.
  3. All emanations from a class A/B digital device or system, including any network of conductors and apparatus connected thereto, shall not exceed the level of field strengths specified above.

## 4.2 Test Procedures

1. The EUT was placed on a desk 0.8 meter height from the metal ground plane and 0.4 meter from the conducting wall of the shielding room and it was kept at least 0.8 meters from any other grounded conducting surface.
2. Connect EUT to the power mains through a Artificial Mains Network (AMN).
3. All the support units are connecting to the other AMN.
4. The AMN provides 50 ohm coupling impedance for the measuring instrument.
5. The CISPR states that a 50 ohm, 50 micro-Henry AMN should be used.
6. Both sides of AC line were checked for maximum conducted interference.
7. The frequency range from 150 kHz to 30 MHz was searched
8. Set the test-receiver system to Peak Detect Function and Specified Bandwidth with Maximum Hold Mode.

## 4.3 Typical Test Setup

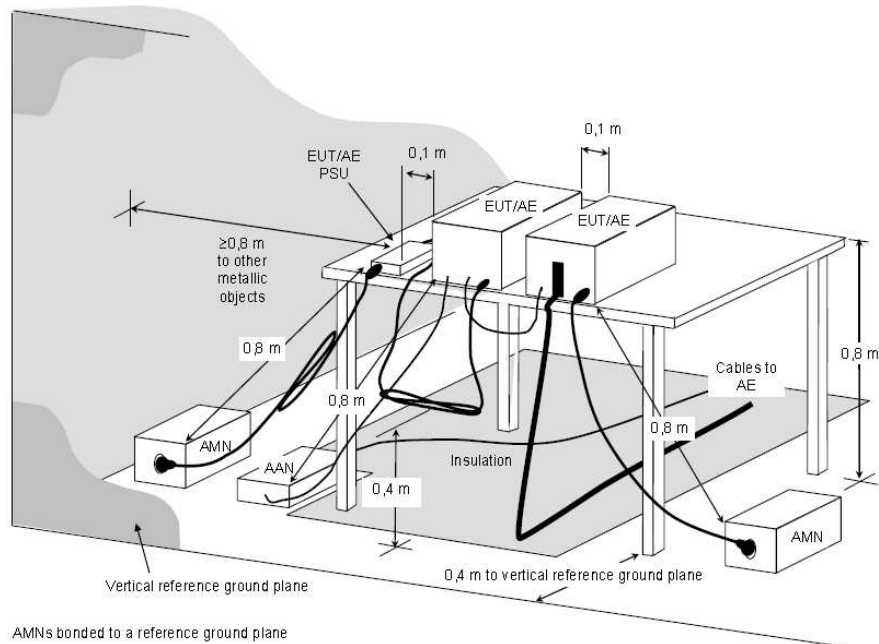

NOTE The 0,8 m distance specified between EUT/AE/PSU and AMN/AAN, is applicable only to the EUT being measured. If the device is AE then it shall be  $\geq 0,8$  m.

**Figure D.2 – Example measurement arrangement for table-top EUT  
(Conducted emission measurement – alternative 1)**





**BUREAU  
VERITAS**

#### 4.4 Measurement Equipment

DESCRIPTION & MANUFACTURER	MODEL NO.	SERIAL NO.	CALIBRATED UNTIL
Test Receiver ROHDE & SCHWARZ	ESCS30	E1R1001	Mar.11, 2021
LISN ROHDE & SCHWARZ	ENV216	E1L1011	Mar.11, 2021
Software ADT	ADT_Cond_V7.3.0	N/A	N/A

## 4.5 Test Result and Data

### Conducted Emission Test Data

For Adaptor 1: KA06E-0501000US

120Vac/60Hz

Phase : LINE

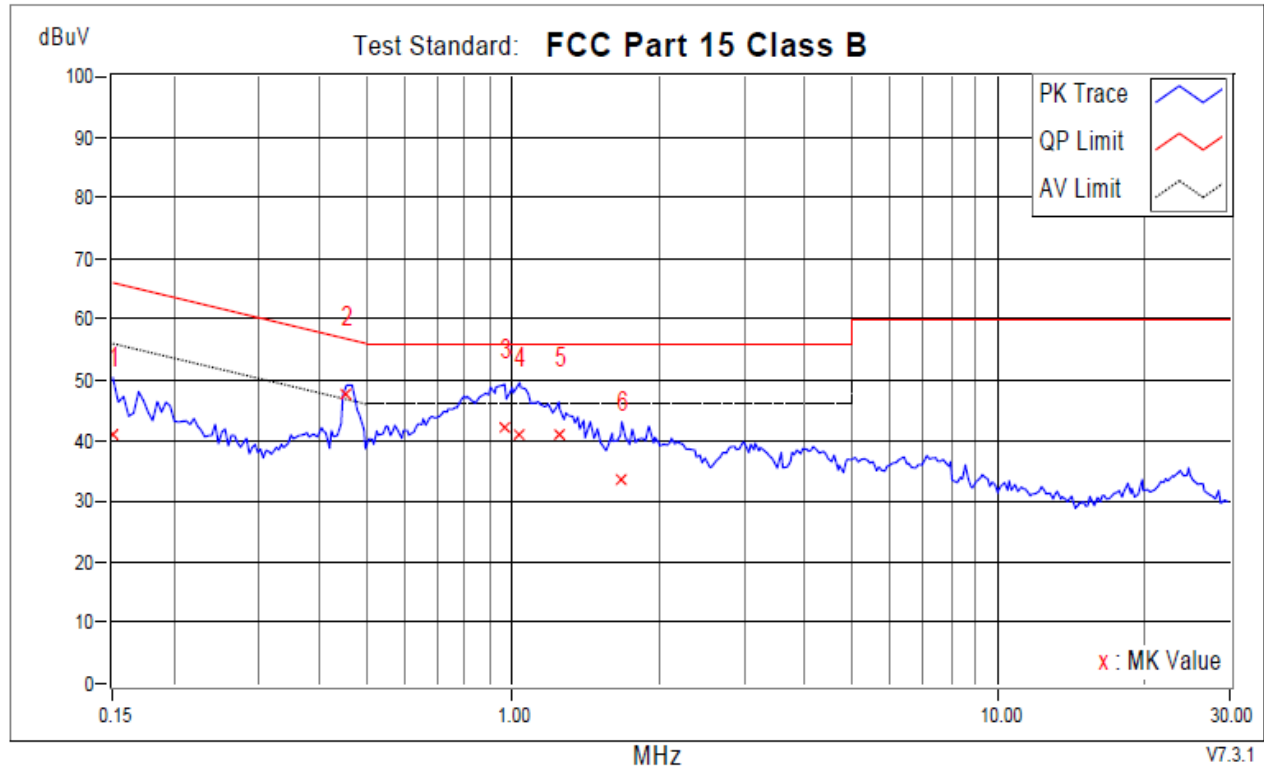

No.	Frequency	Corr. Factor	Reading dBuV		Emission dBuV		Limit dBuV		Margins dB		Notes
	MHz		QP	AV	QP	AV	QP	AV	QP	AV	
1	0.15000	9.87	30.98	13.85	40.85	23.72	66.00	56.00	-25.15	-32.28	
+2	0.45498	9.87	37.66	25.90	47.53	35.77	56.78	46.78	-9.26	-11.02	
3	0.96328	9.91	32.19	17.91	42.10	27.82	56.00	46.00	-13.90	-18.18	
4	1.03519	9.91	31.19	17.35	41.10	27.26	56.00	46.00	-14.90	-18.74	
5	1.24633	9.91	31.10	14.44	41.01	24.35	56.00	46.00	-14.99	-21.65	
6	1.68034	9.92	23.69	10.10	33.61	20.02	56.00	46.00	-22.39	-25.98	

#### REMARKS:

1. Q.P. and AV. are abbreviations of quasi-peak and average individually.
2. The emission levels of other frequencies were very low against the limit.
3. Margin value = Emission level - Limit value
4. Correction factor = Insertion loss + Cable loss
5. Emission Level = Correction Factor + Reading Value.



BUREAU  
VERITAS

Phase : NEUTRAL

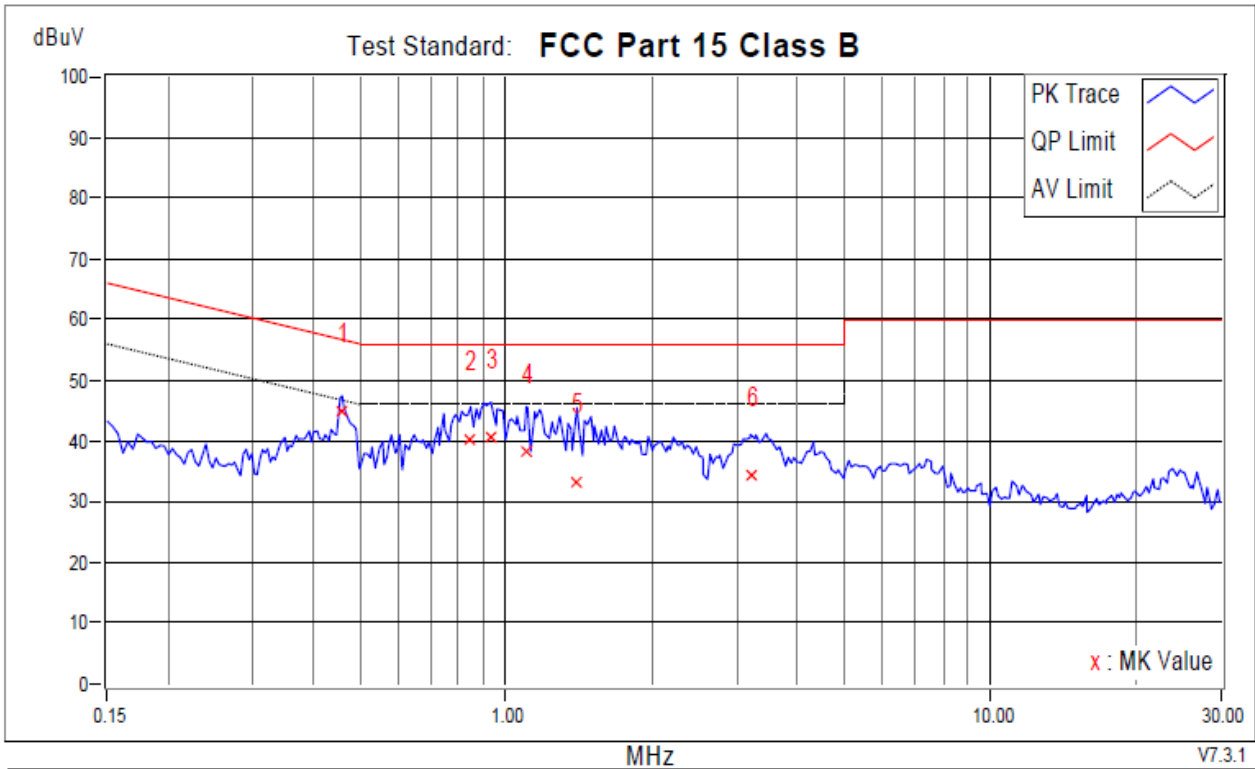

No.	Frequency MHz	Corr. Factor dB	Reading dBuV		Emission dBuV		Limit dBuV		Margins dB		Notes
			QP	AV	QP	AV	QP	AV	QP	AV	
+1	0.45889	9.87	35.12	28.08	44.99	37.95	56.71	46.71	-11.73	-8.77	
2	0.84598	9.90	30.28	16.77	40.18	26.67	56.00	46.00	-15.82	-19.33	
3	0.93200	9.91	30.77	23.35	40.68	33.26	56.00	46.00	-15.32	-12.74	
4	1.10166	9.91	28.52	21.36	38.43	31.27	56.00	46.00	-17.57	-14.73	
5	1.40273	9.92	23.24	10.09	33.16	20.01	56.00	46.00	-22.84	-25.99	
6	3.20133	9.92	24.49	13.23	34.41	23.15	56.00	46.00	-21.59	-22.85	

**REMARKS:**

1. Q.P. and AV. are abbreviations of quasi-peak and average individually.
2. The emission levels of other frequencies were very low against the limit.
3. Margin value = Emission level - Limit value
4. Correction factor = Insertion loss + Cable loss
5. Emission Level = Correction Factor + Reading Value.



BUREAU  
VERITAS

240Vac/50Hz

Phase: LINE

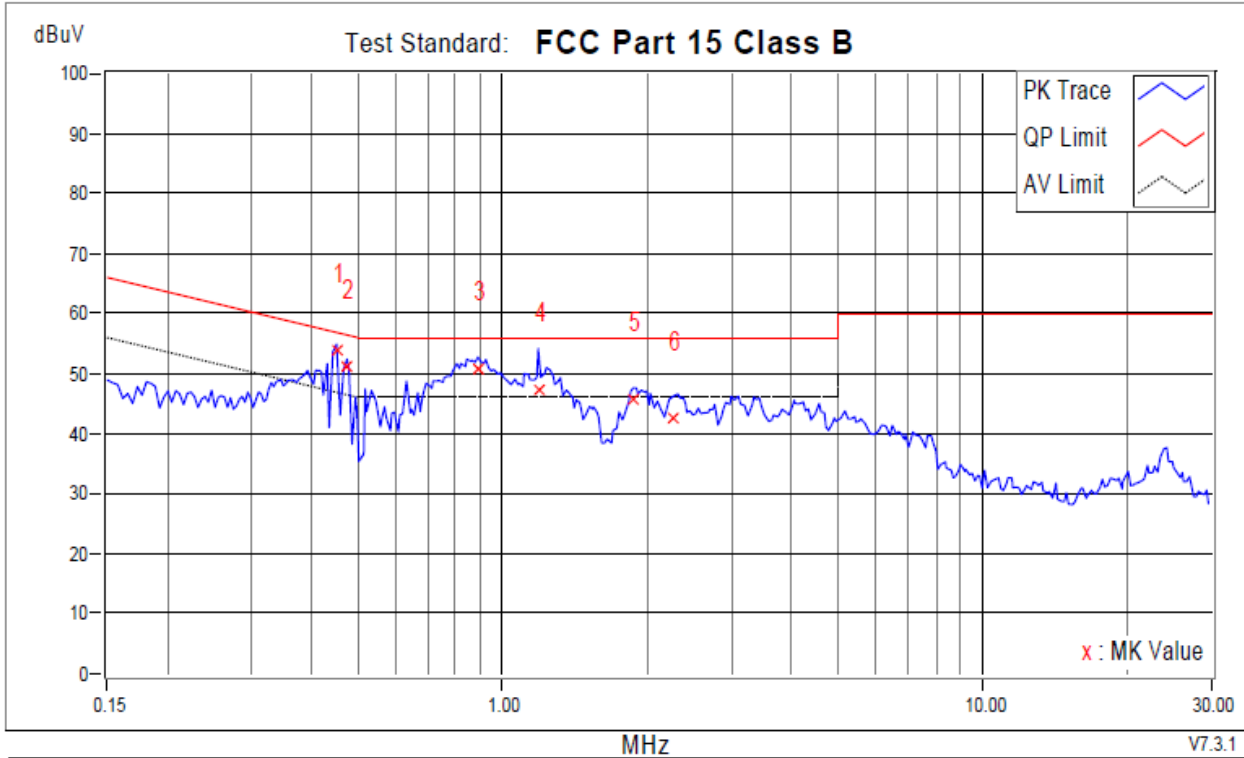

No.	Frequency	Corr. Factor	Reading dBuV		Emission dBuV		Limit dBuV		Margins dB		Notes
	MHz		QP	AV	QP	AV	QP	AV	QP	AV	
+1	0.45107	9.74	44.20	34.32	53.94	44.06	56.86	46.86	-2.92	-2.80	
2	0.47453	9.74	41.43	31.35	51.17	41.09	56.43	46.43	-5.27	-5.35	
3	0.88899	9.60	41.06	29.12	50.66	38.72	56.00	46.00	-5.34	-7.28	
4	1.18768	9.64	37.47	28.41	47.11	38.05	56.00	46.00	-8.89	-7.95	
5	1.87584	9.75	35.85	26.39	45.60	36.14	56.00	46.00	-10.40	-9.86	
6	2.27857	9.78	32.63	19.89	42.41	29.67	56.00	46.00	-13.59	-16.33	

**REMARKS:**

1. Q.P. and AV. are abbreviations of quasi-peak and average individually.
2. The emission levels of other frequencies were very low against the limit.
3. Margin value = Emission level - Limit value
4. Correction factor = Insertion loss + Cable loss
5. Emission Level = Correction Factor + Reading Value.



**BUREAU  
VERITAS**

Phase: NEUTRAL

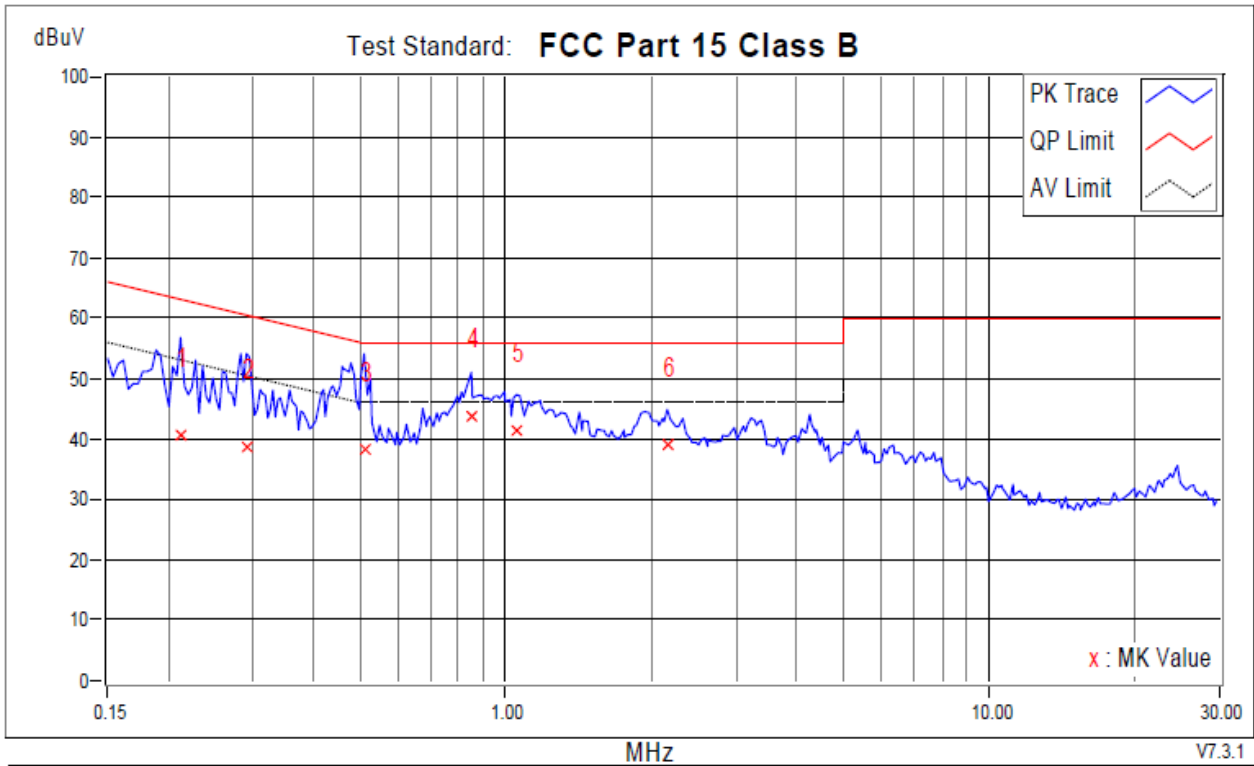

No.	Frequency	Corr. Factor	Reading dBuV		Emission dBuV		Limit dBuV		Margins dB		Notes
	MHz		QP	AV	QP	AV	QP	AV	QP	AV	
1	0.21256	9.83	30.95	18.18	40.78	28.01	63.10	53.10	-22.33	-25.10	
2	0.29076	9.88	28.60	17.39	38.48	27.27	60.50	50.50	-22.02	-23.23	
3	0.50972	9.86	28.58	10.35	38.44	20.21	56.00	46.00	-17.56	-25.79	
+4	0.84989	9.90	33.66	19.31	43.56	29.21	56.00	46.00	-12.44	-16.79	
5	1.05474	9.91	31.48	11.51	41.39	21.42	56.00	46.00	-14.61	-24.58	
6	2.16127	9.94	29.15	16.64	39.09	26.58	56.00	46.00	-16.91	-19.42	

**REMARKS:**

1. Q.P. and AV. are abbreviations of quasi-peak and average individually.
2. The emission levels of other frequencies were very low against the limit.
3. Margin value = Emission level - Limit value
4. Correction factor = Insertion loss + Cable loss
5. Emission Level = Correction Factor + Reading Value.

For Adaptor 2: TEKA-UCA10US

120Vac/60Hz

Phase : LINE

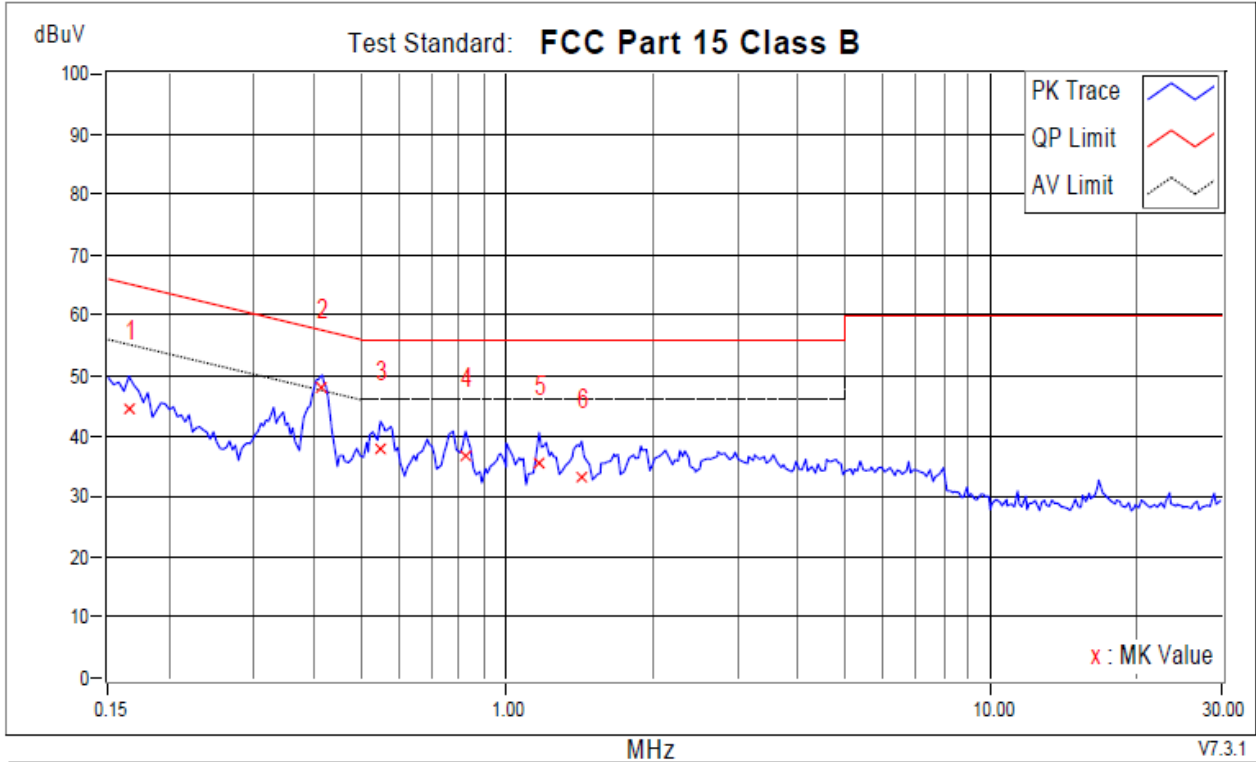

No.	Frequency MHz	Corr. Factor dB	Reading dBuV		Emission dBuV		Limit dBuV		Margins dB		Notes
			QP	AV	QP	AV	QP	AV	QP	AV	
1	0.16564	9.87	34.72	19.70	44.59	29.57	65.18	55.18	-20.59	-25.61	
+2	0.41588	9.73	38.24	29.96	47.97	39.69	57.53	47.53	-9.56	-7.84	
3	0.54882	9.71	28.26	21.06	37.97	30.77	56.00	46.00	-18.03	-15.23	
4	0.82252	9.60	27.30	17.44	36.90	27.04	56.00	46.00	-19.10	-18.96	
5	1.16813	9.64	25.75	16.31	35.39	25.95	56.00	46.00	-20.61	-20.05	
6	1.43010	9.68	23.45	14.55	33.13	24.23	56.00	46.00	-22.87	-21.77	

**REMARKS:**

1. Q.P. and AV. are abbreviations of quasi-peak and average individually.
2. The emission levels of other frequencies were very low against the limit.
3. Margin value = Emission level - Limit value
4. Correction factor = Insertion loss + Cable loss
5. Emission Level = Correction Factor + Reading Value.



BUREAU  
VERITAS

Phase : NEUTRAL

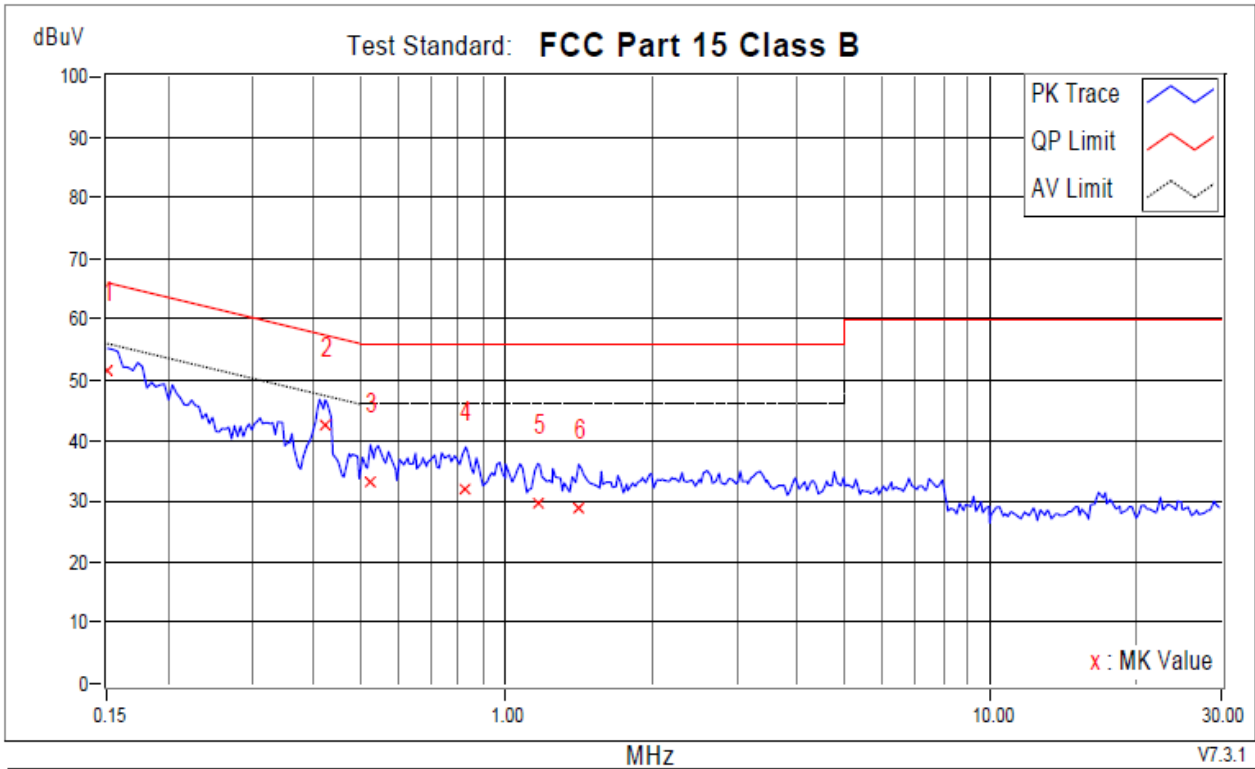

No.	Frequency	Corr. Factor	Reading dBuV		Emission dBuV		Limit dBuV		Margins dB		Notes
	MHz		QP	AV	QP	AV	QP	AV	QP	AV	
1	0.15000	9.87	41.77	24.98	51.64	34.85	66.00	56.00	-14.36	-21.15	
+2	0.42370	9.87	32.88	25.76	42.75	35.63	57.38	47.38	-14.62	-11.74	
3	0.52536	9.85	23.45	16.00	33.30	25.85	56.00	46.00	-22.70	-20.15	
4	0.82643	9.90	22.28	12.38	32.18	22.28	56.00	46.00	-23.82	-23.72	
5	1.16422	9.91	19.69	12.86	29.60	22.77	56.00	46.00	-26.40	-23.23	
6	1.41446	9.92	18.89	11.12	28.81	21.04	56.00	46.00	-27.19	-24.96	

**REMARKS:**

1. Q.P. and AV. are abbreviations of quasi-peak and average individually.
2. The emission levels of other frequencies were very low against the limit.
3. Margin value = Emission level - Limit value
4. Correction factor = Insertion loss + Cable loss
5. Emission Level = Correction Factor + Reading Value.



**BUREAU  
VERITAS**

240Vac/50Hz

Phase: LINE

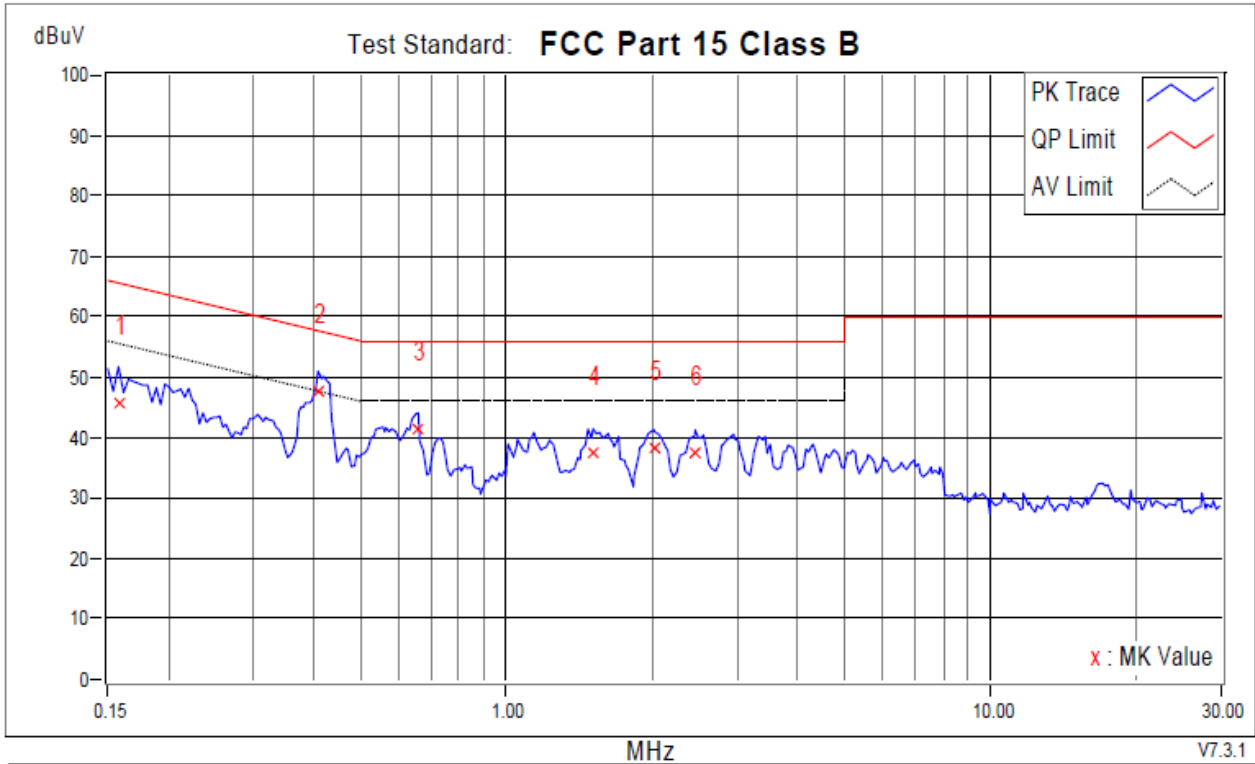

No.	Frequency MHz	Corr. Factor dB	Reading dBuV		Emission dBuV		Limit dBuV		Margins dB		Notes
			QP	AV	QP	AV	QP	AV	QP	AV	
1	0.15782	9.86	35.90	20.27	45.76	30.13	65.58	55.58	-19.81	-25.44	
+2	0.40806	9.73	38.08	30.83	47.81	40.56	57.69	47.69	-9.88	-7.13	
3	0.65830	9.64	31.95	24.57	41.59	34.21	56.00	46.00	-14.41	-11.79	
4	1.51221	9.69	27.90	19.97	37.59	29.66	56.00	46.00	-18.41	-16.34	
5	2.01660	9.77	28.39	20.52	38.16	30.29	56.00	46.00	-17.84	-15.71	
6	2.45843	9.78	27.78	19.98	37.56	29.76	56.00	46.00	-18.44	-16.24	

**REMARKS:**

1. Q.P. and AV. are abbreviations of quasi-peak and average individually.
2. The emission levels of other frequencies were very low against the limit.
3. Margin value = Emission level - Limit value
4. Correction factor = Insertion loss + Cable loss
5. Emission Level = Correction Factor + Reading Value.





BUREAU  
VERITAS

Phase: NEUTRAL

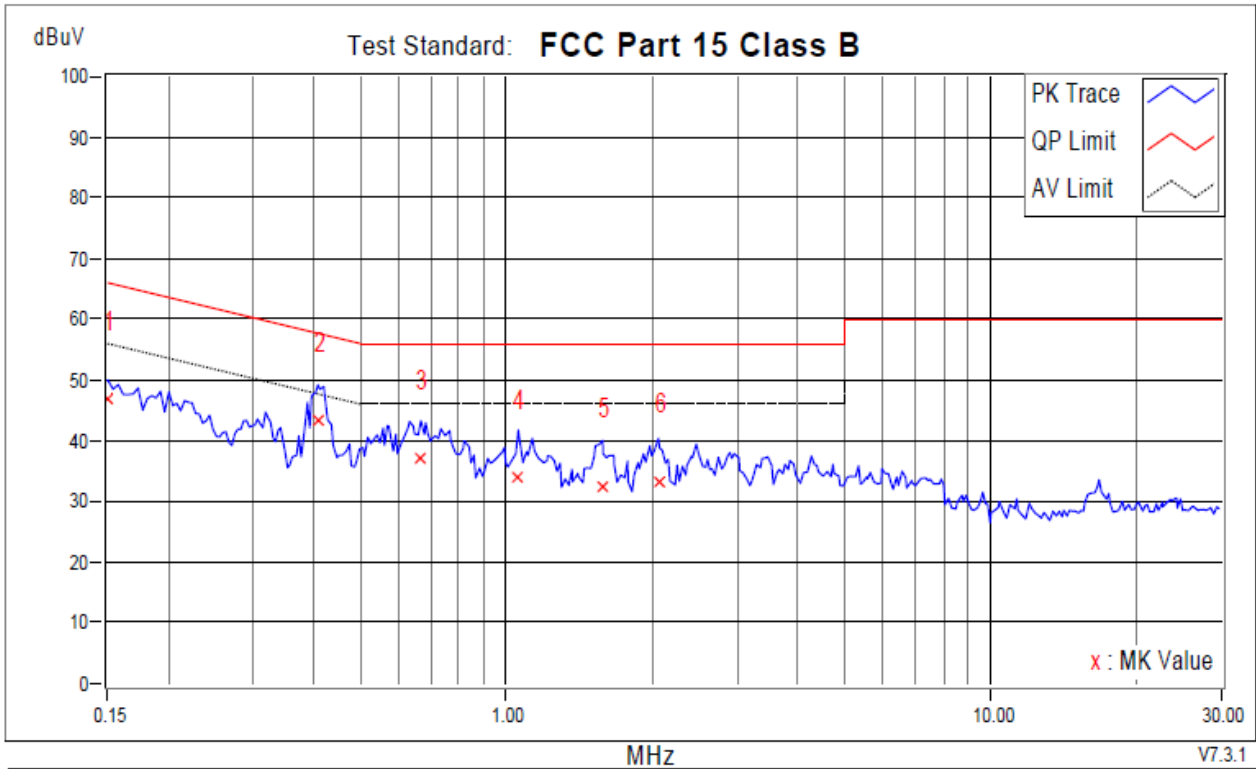

No.	Frequency MHz	Corr. Factor dB	Reading dBuV		Emission dBuV		Limit dBuV		Margins dB		Notes
			QP	AV	QP	AV	QP	AV	QP	AV	
1	0.15000	9.87	36.97	18.29	46.84	28.16	66.00	56.00	-19.16	-27.84	
+2	0.40806	9.87	33.46	25.12	43.33	34.99	57.69	47.69	-14.35	-12.69	
3	0.66612	9.83	27.16	18.15	36.99	27.98	56.00	46.00	-19.01	-18.02	
4	1.05865	9.91	23.97	14.67	33.88	24.58	56.00	46.00	-22.12	-21.42	
5	1.58259	9.92	22.66	14.74	32.58	24.66	56.00	46.00	-23.42	-21.34	
6	2.06352	9.93	23.23	14.31	33.16	24.24	56.00	46.00	-22.84	-21.76	

**REMARKS:**

1. Q.P. and AV. are abbreviations of quasi-peak and average individually.
2. The emission levels of other frequencies were very low against the limit.
3. Margin value = Emission level - Limit value
4. Correction factor = Insertion loss + Cable loss
5. Emission Level = Correction Factor + Reading Value.

## 4.6 Test Photographs

Adaptor 1: KA06E-0501000US



Adaptor 2: TEKA-UCA10US



## 5 Test of Radiated Emission

### 5.1 Test Limit

**TEST STANDARD:**

**CFR 47 FCC Part 15, Subpart B (Section: 15.109)**

### FOR FREQUENCY BELOW 1000 MHz

FREQUENCY (MHz)	Class A (at 10m)		Class B (at 3m)	
	$\mu\text{V/m}$	$\text{dB}\mu\text{V/m}$	$\mu\text{V/m}$	$\text{dB}\mu\text{V/m}$
30 – 88	90	39.1	100	40.0
88 – 216	150	43.5	150	43.5
216 – 960	210	46.4	200	46.0
960 – 1000	300	49.5	500	54.0

### LIMIT OF RADIATED EMISSION OF FCC PART 15, SUBPART B FOR FREQUENCY ABOVE 1000 MHz

FREQUENCY (MHz)	Class A ( $\text{dB}\mu\text{V/m}$ ) (at 3m)		Class B ( $\text{dB}\mu\text{V/m}$ ) (at 3m)	
	PEAK	AVERAGE	PEAK	AVERAGE
Above 1000	80.0	60.0	74.0	54.0

- Note:**
1. The lower limit shall apply at the transition frequencies.
  2. Emission level ( $\text{dB}\mu\text{V/m}$ ) =  $20 \log$  Emission level ( $\mu\text{V/m}$ ).
  3. All emanation from a class A/B digital device or system, including any network of conductors and apparatus connected thereto, shall not exceed the level of field strengths specified above.

## 5.2 Test Procedures

1. The EUT was placed on a rotatable table top 0.8 meter above ground.
2. The EUT was set 3/10 meters from the interference receiving antenna which was mounted on the top of a variable height antenna tower.
3. The table was rotated 360 degrees to determine the position of the highest radiation.
4. The antenna is a half wave dipole and its height is varied between one meter and four meters above ground to find the maximum value of the field strength both horizontal polarization and vertical polarization of the antenna are set to make the measurement.
5. For each suspected emission the EUT was arranged to its worst case and then tune the antenna tower (from 1 M to 4 M) and turn table (from 0 degree to 360 degrees) to find the maximum reading.
6. Set the test-receiver system to Peak Detect Function and specified bandwidth with Maximum Hold Mode.
7. If the emission level of the EUT in peak mode was 3 dB lower than the limit specified, then testing will be stopped and peak values of EUT will be reported, otherwise, the emissions which do not have 3 dB margin will be repeated one by one using the quasi-peak method and reported.

## 5.3 Typical Test Setup

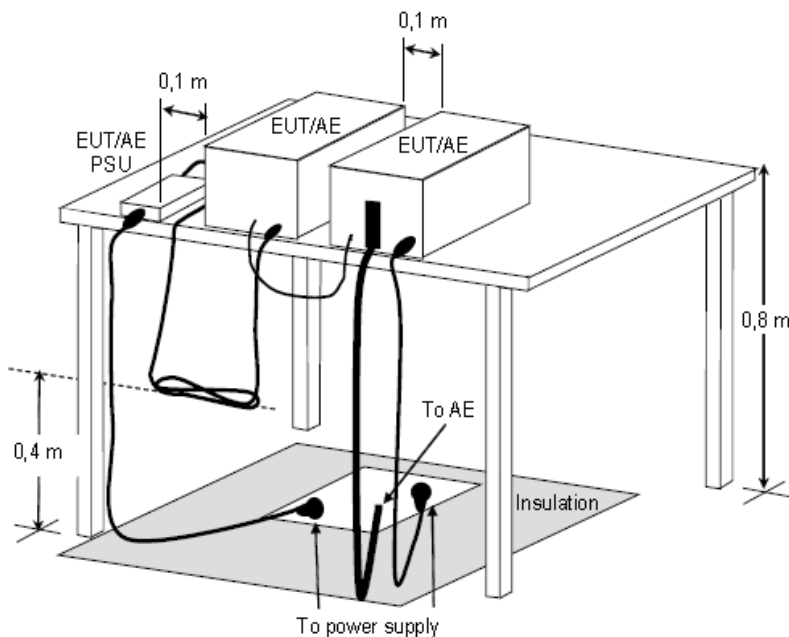

**Figure D.8 – Example measurement arrangement for table-top EUT (Radiated emission measurement)**



**BUREAU  
VERITAS**

## 5.4 Measurement Equipment

DESCRIPTION & MANUFACTURER	MODEL NO.	SERIAL NO.	CALIBRATED UNTIL
EMI Test Spectrum ROHDE & SCHWARZ	ESR7	E1R1005	May.11, 2021
Spectrum Analyzer Keysight	N9030B	E1S1003	Aug.03, 2021
Broad-Band Antenna Schwarzbeck	VULB9168	E1A1012	Jul.27, 2021
Double Riaged Vroadband Horn Antenna Schwarzbeck	BBHA9120D	E1A1017	Jan.25, 2021
Preamplifier Agilent	8447D	E1A2001	Apr.19, 2021
Preamplifier Agilent	EMC051845SE	E1A2009	Jul.05, 2021

## 5.5 Test Result and Data (30MHz ~ 1GHz)

For adaptor 1: KA06E-0501000US

Position: Horizontal

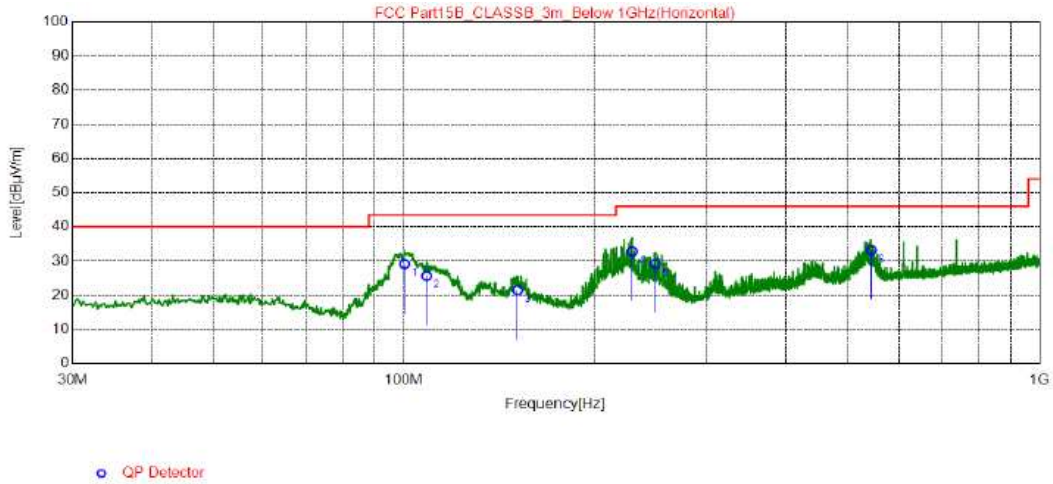

NO.	Freq. [MHz]	QP Reading [dBµV/m]	Factor [dB]	QP Value [dBµV/m]	QP Limit [dBµV/m]	QP Margin [dB]	Height [cm]	Angle [°]	Polarity
1	100.2	44.09	-14.94	29.15	43.50	14.35	200	256	Horizontal
2	108.5	39.55	-13.91	25.64	43.50	17.86	200	101	Horizontal
3	151.0	31.49	-10.01	21.48	43.50	22.02	200	272	Horizontal
4	228.8	44.22	-11.44	32.78	46.00	13.22	200	268	Horizontal
5	249.2	39.78	-10.61	29.17	46.00	16.83	200	113	Horizontal
6	545.6	36.86	-3.76	33.10	46.00	12.90	200	260	Horizontal

### REMARKS:

1. Q.P. is abbreviation of quasi-peak individually.
2. The emission levels of other frequencies were very low against the limit.
3. QP Margin value = QP Limit value – QP value.
4. Factor = Antenna Factor + Amplifier Factor + Cable loss.
5. QP value = Factor + Reading Value.



Position: Vertical

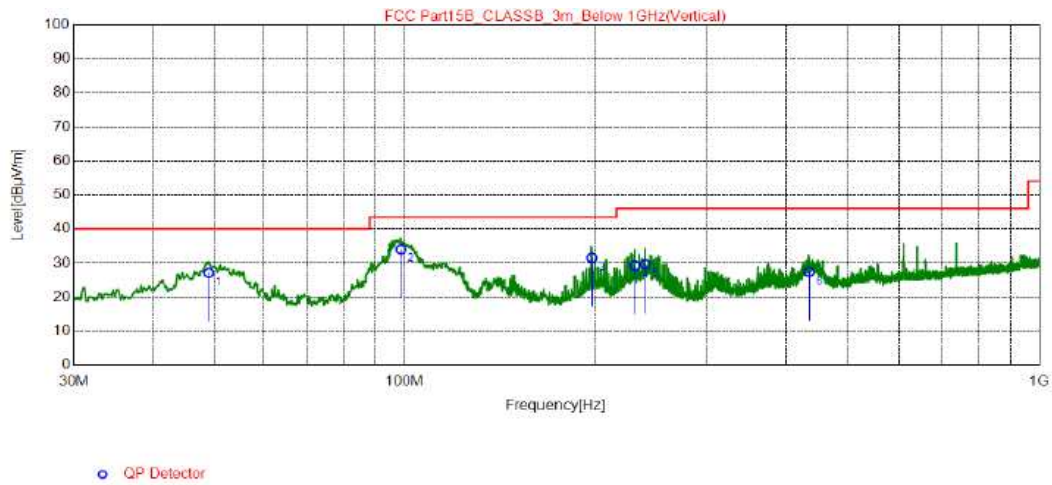

NO.	Freq. [MHz]	QP Reading [dBµV/m]	Factor [dB]	QP Value [dBµV/m]	QP Limit [dBµV/m]	QP Margin [dB]	Height [cm]	Angle [°]	Polarity
1	49.01	36.88	-9.77	27.11	40.00	12.89	100	274	Vertical
2	98.67	49.08	-15.09	33.99	43.50	9.51	100	234	Vertical
3	197.4	43.5	-11.97	31.53	43.50	11.97	100	67	Vertical
4	230.7	40.66	-11.38	29.28	46.00	16.72	100	246	Vertical
5	239.9	40.73	-11.07	29.66	46.00	16.34	100	262	Vertical
6	435.2	32.88	-5.47	27.41	46.00	18.59	100	191	Vertical

REMARKS:

1. Q.P. is abbreviation of quasi-peak individually.
2. The emission levels of other frequencies were very low against the limit.
3. QP Margin value = QP Limit value – QP value
4. Factor = Antenna Factor + Amplifier Factor + Cable loss
5. QP value = Factor + Reading Value.





For adaptor 2: TEKA-UCA10US

Position: Horizontal

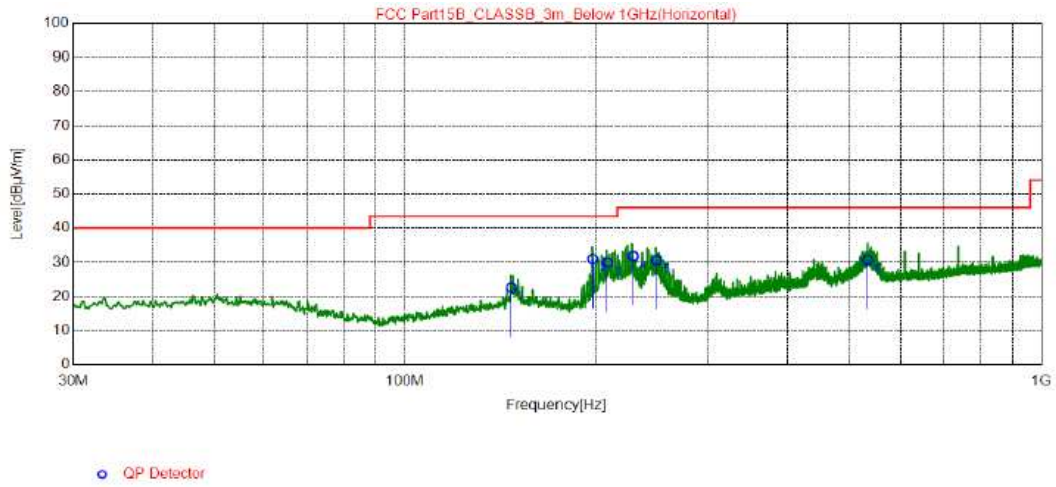

NO.	Freq. [MHz]	QP Reading [dBµV/m]	Factor [dB]	QP Value [dBµV/m]	QP Limit [dBµV/m]	QP Margin [dB]	Height [cm]	Angle [°]	Polarity
1	146.9	32.73	-10.13	22.60	43.50	20.90	200	116	Horizontal
2	197.4	42.9	-11.97	30.93	43.50	12.57	200	89	Horizontal
3	208.2	41.89	-11.97	29.92	43.50	13.58	200	97	Horizontal
4	228.6	43.25	-11.45	31.80	46.00	14.20	200	232	Horizontal
5	249.0	41.24	-10.62	30.62	46.00	15.38	200	120	Horizontal
6	534.9	34.64	-3.95	30.69	46.00	15.31	200	105	Horizontal

**REMARKS:**

1. Q.P. is abbreviation of quasi-peak individually.
2. The emission levels of other frequencies were very low against the limit.
3. QP Margin value = QP Limit value – QP value.
4. Factor = Antenna Factor + Amplifier Factor + Cable loss.
5. QP value = Factor + Reading Value.





Position: Vertical

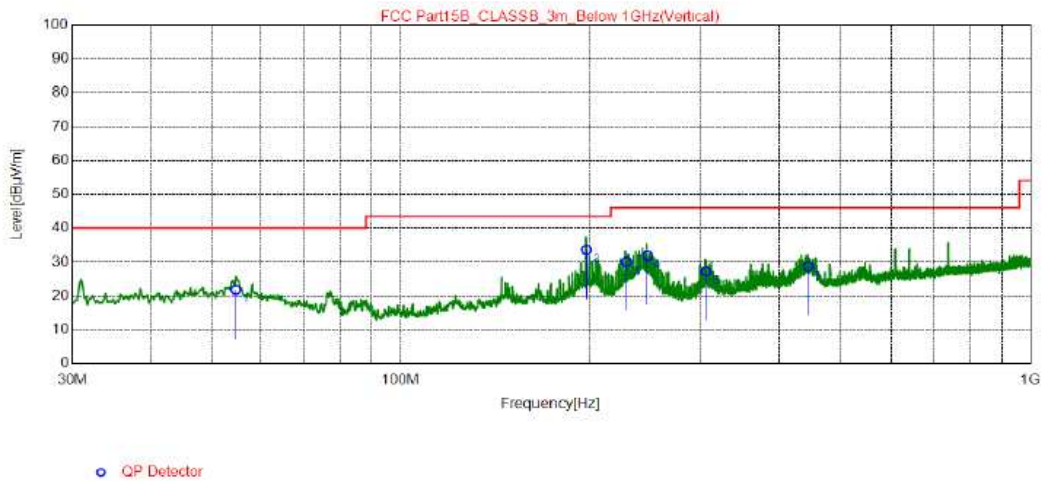

NO.	Freq. [MHz]	QP Reading [dBuV/m]	Factor [dB]	QP Value [dBuV/m]	QP Limit [dBuV/m]	QP Margin [dB]	Height [cm]	Angle [°]	Polarity
1	54.63	31.79	-9.97	21.82	40.00	18.18	100	301	Vertical
2	197.4	45.55	-11.97	33.58	43.50	9.92	100	75	Vertical
3	228.6	41.5	-11.45	30.05	46.00	15.95	100	259	Vertical
4	246.8	42.61	-10.72	31.89	46.00	14.11	100	232	Vertical
5	306.0	35.73	-8.47	27.26	46.00	18.74	100	106	Vertical
6	444.9	33.98	-5.25	28.73	46.00	17.27	100	178	Vertical

**REMARKS:**

1. Q.P. is abbreviation of quasi-peak individually.
2. The emission levels of other frequencies were very low against the limit.
3. QP Margin value = QP Limit value – QP value
4. Factor = Antenna Factor + Amplifier Factor + Cable loss
5. QP value = Factor + Reading Value.



### 5.6 Test Result and Data (1GHz ~ 18GHz)

For adaptor 1: KA06E-0501000US

Position: Horizontal

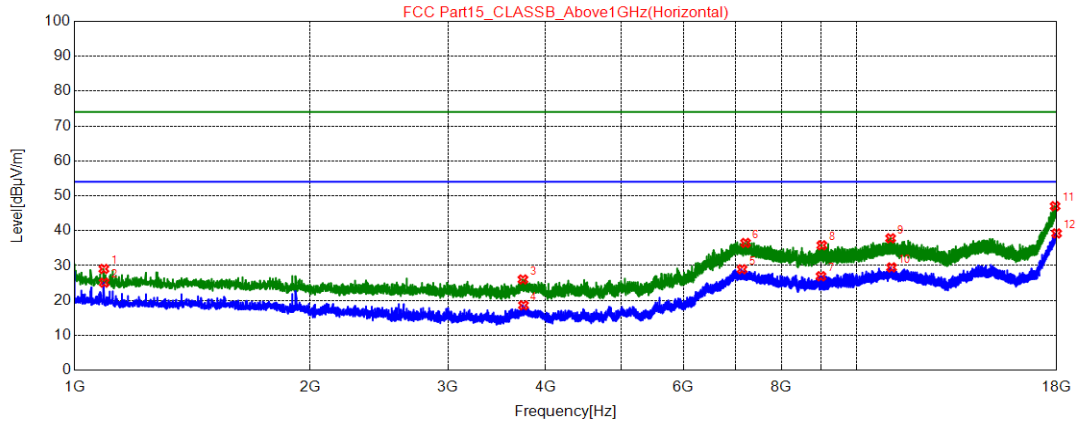

\* AV Detector

NO.	Freq. [MHz]	Reading [dBµV/m]	Level [dBµV/m]	Limit [dBµV/m]	Margin [dB]	Height [cm]	Angle [°]	Polarity	Detector
1	1090.1000	49.25	29.03	74.00	44.97	100	184	Horizontal	PK
2	1090.9500	45.32	25.10	54.00	28.90	100	145	Horizontal	AV
3	3741.2500	38.02	26.01	74.00	47.99	100	184	Horizontal	PK
4	3747.2000	30.60	18.61	54.00	35.39	100	262	Horizontal	AV
5	7129.3500	29.32	28.94	54.00	25.06	100	107	Horizontal	AV
6	7203.3000	37.05	36.48	74.00	37.52	100	184	Horizontal	PK
7	8994.2500	29.33	26.94	54.00	27.06	100	340	Horizontal	AV
8	9014.6500	38.19	35.81	74.00	38.19	100	184	Horizontal	PK
9	11039.350	37.37	37.81	74.00	36.19	100	107	Horizontal	PK
10	11069.100	29.02	29.47	54.00	24.53	100	107	Horizontal	AV
11	17910.750	33.15	47.03	74.00	26.97	100	184	Horizontal	PK
12	17988.950	24.53	39.22	54.00	14.78	100	107	Horizontal	AV

**REMARKS:**

1. The emission levels of other frequencies were very low against the limit.
2. Margin = Limit –Level



Position: Vertical

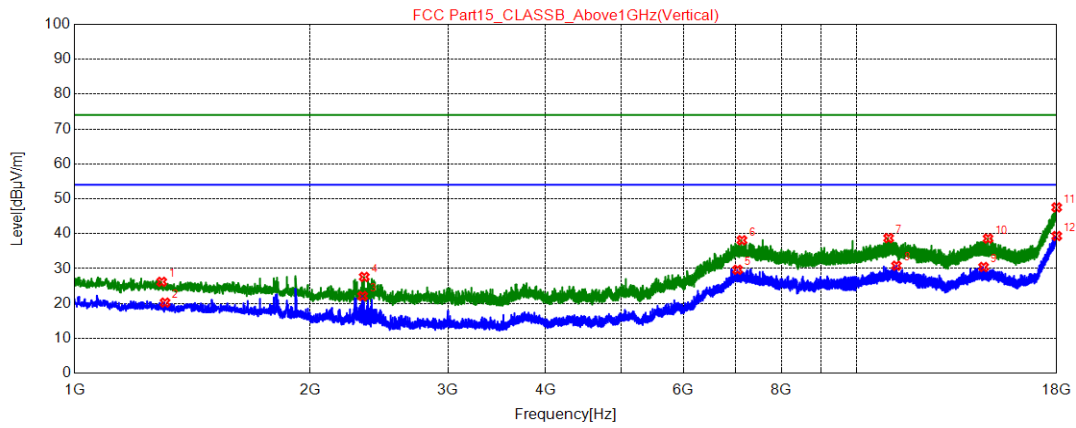

\* AV Detector

NO.	Freq. [MHz]	Reading [dBµV/m]	Level [dBµV/m]	Limit [dBµV/m]	Margin [dB]	Height [cm]	Angle [°]	Polarity	Detector
1	1292.4000	45.74	26.20	74.00	47.80	100	176	Vertical	PK
2	1305.1500	39.74	20.24	54.00	33.76	100	59	Vertical	AV
3	2334.5000	38.14	22.12	54.00	31.88	100	176	Vertical	AV
4	2345.5500	43.58	27.61	74.00	46.39	100	176	Vertical	PK
5	7035.8500	29.80	29.65	54.00	24.35	100	220	Vertical	AV
6	7126.8000	38.50	38.12	74.00	35.88	100	98	Vertical	PK
7	10973.900	38.36	38.73	74.00	35.27	100	59	Vertical	PK
8	11231.450	30.35	30.82	54.00	23.18	100	259	Vertical	AV
9	14512.450	27.27	30.46	54.00	23.54	100	220	Vertical	AV
10	14702.850	35.35	38.60	74.00	35.40	100	176	Vertical	PK
11	17994.050	32.78	47.53	74.00	26.47	100	137	Vertical	PK
12	17999.150	24.52	39.32	54.00	14.68	100	98	Vertical	AV

**REMARKS:**

1. The emission levels of other frequencies were very low against the limit.
2. Margin = Limit –Level



BUREAU  
VERITAS

For adaptor 2: TEKA-UCA10US

Position: Horizontal

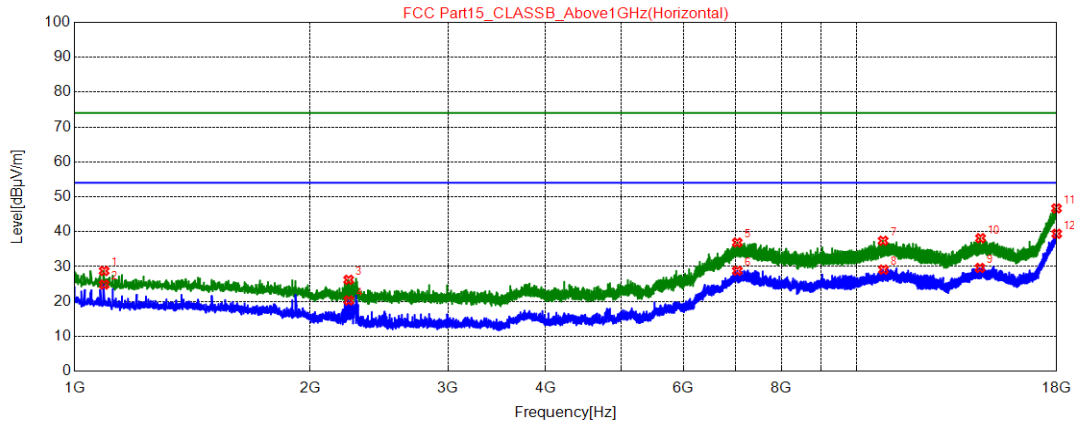

\* AV Detector

NO.	Freq. [MHz]	Reading [dBµV/m]	Level [dBµV/m]	Limit [dBµV/m]	Margin [dB]	Height [cm]	Angle [°]	Polarity	Detector
1	1090.9500	48.97	28.75	74.00	45.25	100	20	Horizontal	PK
2	1090.9500	45.06	24.84	54.00	29.16	100	250	Horizontal	AV
3	2240.1500	42.57	26.21	74.00	47.79	100	174	Horizontal	PK
4	2241.0000	36.64	20.28	54.00	33.72	100	174	Horizontal	AV
5	7029.9000	37.03	36.89	74.00	37.11	100	289	Horizontal	PK
6	7030.7500	28.93	28.79	54.00	25.21	100	250	Horizontal	AV
7	10797.100	37.34	37.39	74.00	36.61	100	250	Horizontal	PK
8	10808.150	29.05	29.12	54.00	24.88	100	98	Horizontal	AV
9	14359.450	26.48	29.60	54.00	24.40	100	174	Horizontal	AV
10	14382.400	34.99	38.13	74.00	35.87	100	250	Horizontal	PK
11	17984.700	32.02	46.67	74.00	27.33	100	20	Horizontal	PK
12	17995.750	24.63	39.40	54.00	14.60	100	59	Horizontal	AV

**REMARKS:**

1. The emission levels of other frequencies were very low against the limit.
2. Margin = Limit –Level



**BUREAU  
VERITAS**

Position: Vertical

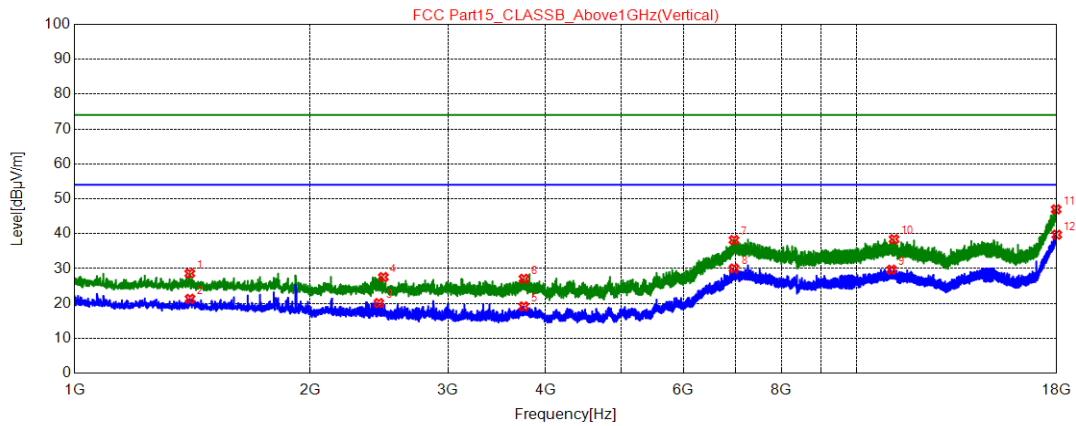

\* AV Detector

NO.	Freq. [MHz]	Reading [dBµV/m]	Level [dBµV/m]	Limit [dBµV/m]	Margin [dB]	Height [cm]	Angle [°]	Polarity	Detector
1	1403.7500	47.79	28.61	74.00	45.39	100	32	Vertical	PK
2	1404.6000	40.50	21.32	54.00	32.68	100	32	Vertical	AV
3	2448.4000	35.71	20.10	54.00	33.90	100	224	Vertical	AV
4	2480.7000	43.05	27.55	74.00	46.45	100	186	Vertical	PK
5	3750.6000	31.13	19.14	54.00	34.86	100	147	Vertical	AV
6	3751.4500	39.05	27.07	74.00	46.93	100	186	Vertical	PK
7	6961.9000	38.53	38.17	74.00	35.83	100	301	Vertical	PK
8	6963.6000	30.36	30.01	54.00	23.99	100	301	Vertical	AV
9	11069.100	29.22	29.67	54.00	24.33	100	186	Vertical	AV
10	11151.550	37.92	38.41	74.00	35.59	100	32	Vertical	PK
11	17964.300	32.52	46.96	74.00	27.04	100	186	Vertical	PK
12	17997.450	24.92	39.70	54.00	14.30	100	109	Vertical	AV

**REMARKS:**

1. The emission levels of other frequencies were very low against the limit.
2. Margin = Limit –Level

## 5.7 Test Photographs (30MHz ~ 1000MHz)

Adaptor 1: KA06E-0501000US



Adaptor 2: TEKA-UCA10US

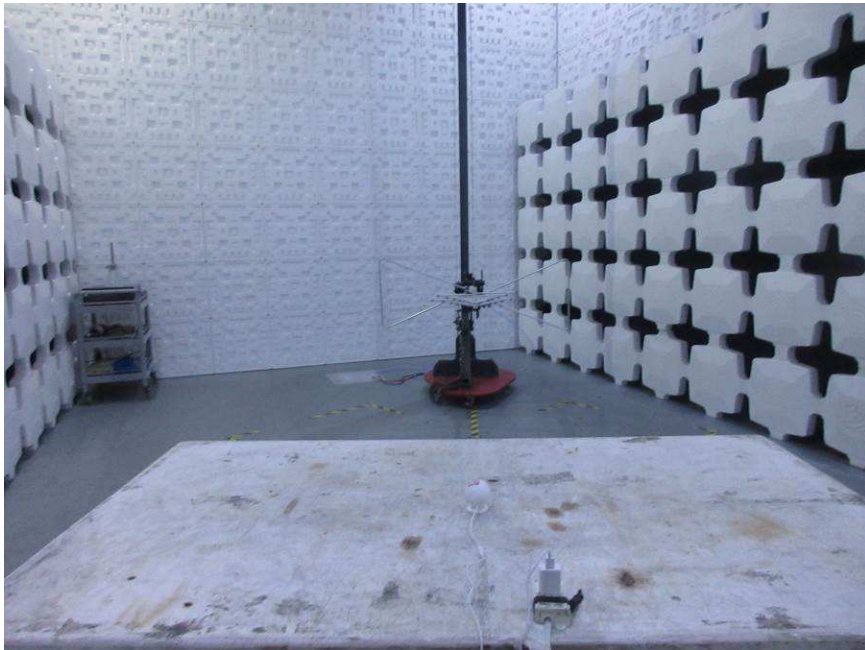





**BUREAU  
VERITAS**

## 5.8 Test Photographs (1000MHz ~ 18000MHz)

Adaptor 1: KA06E-0501000US

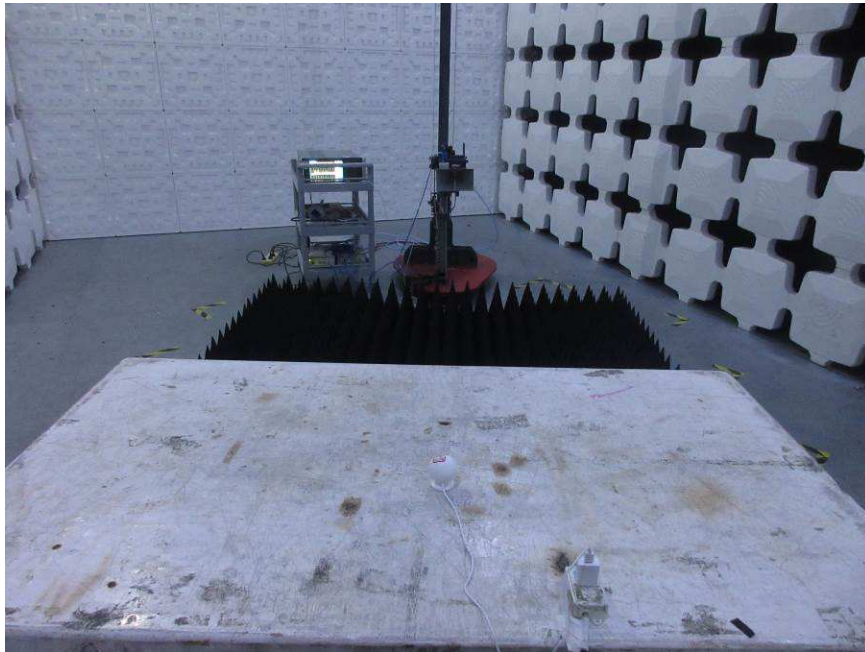

Adaptor 2: TEKA-UCA10US

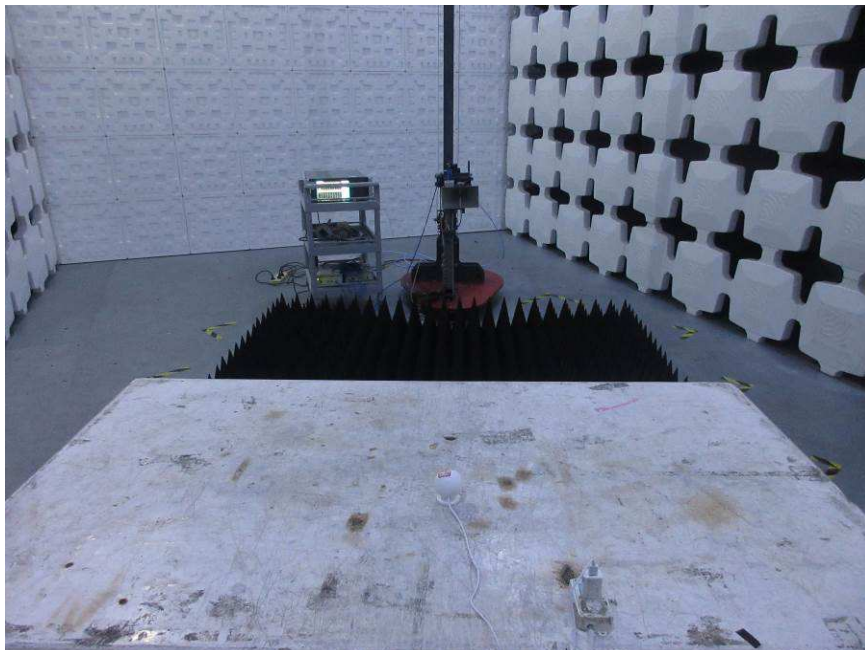

## 6 Photographs of EUT

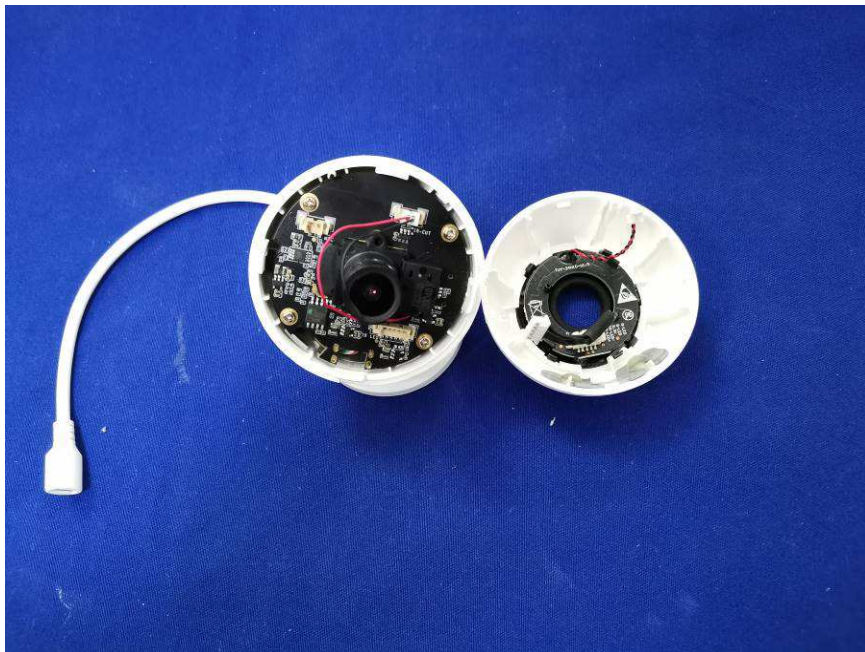





**BUREAU  
VERITAS**

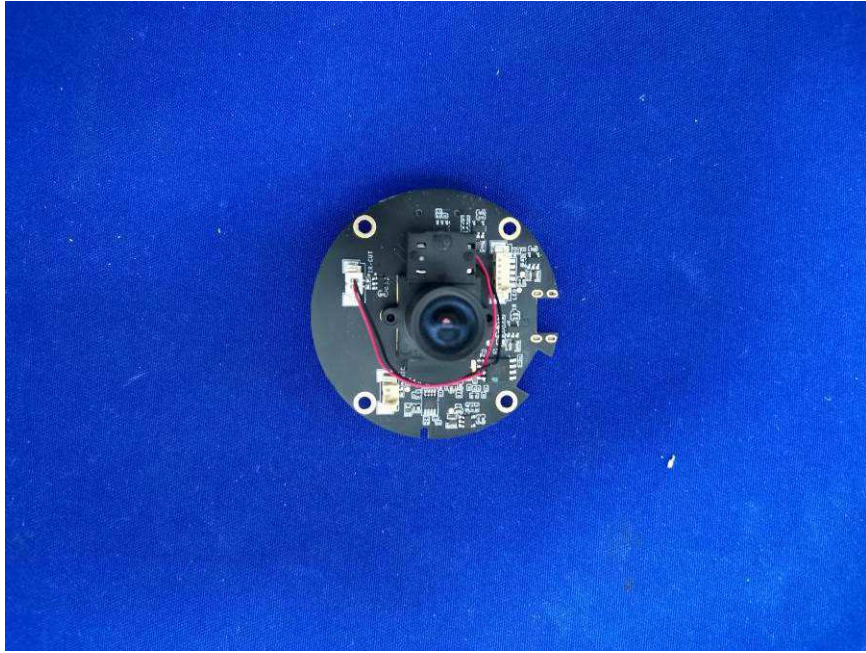



**BUREAU  
VERITAS**

Adaptor: KA06E-0501000US

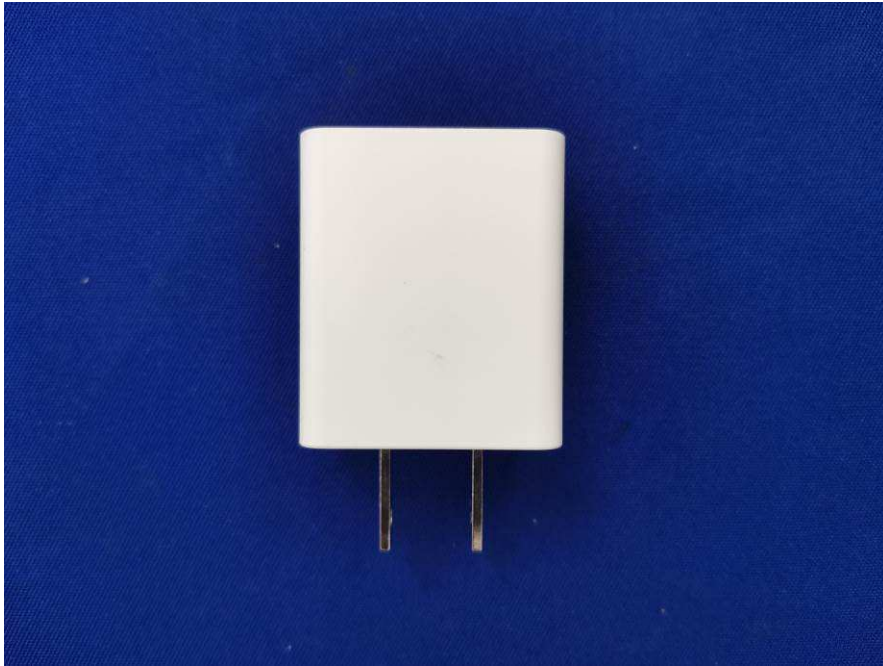



**BUREAU  
VERITAS**

Adaptor: TEKA-UCA10US

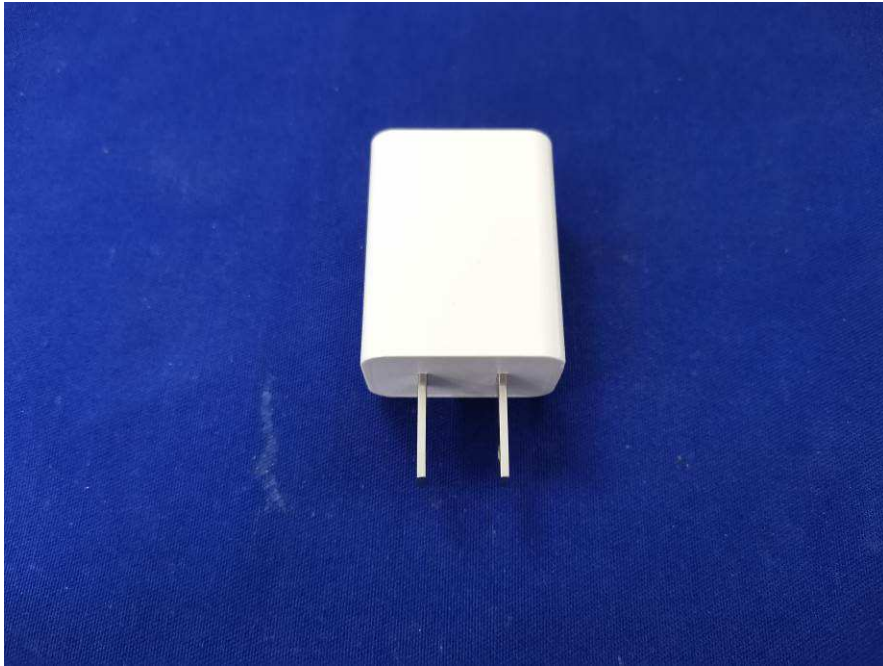

--- END ---