

# FCC RADIO TEST REPORT

**FCC ID: 2AWXK-WKM910K**

**Product :** Wireless keyboard

**Trade Name :** ABKO

**Model Name :**WKM910 (KEYBOARD)

**Series Model :** N/A

**Report No. :** UNIA21012008ER-01

## Prepared for

ABKO CO., LTD  
M Signature 7th floor, 20, Magokjungang 1-ro, Gangseo-gu,  
Seoul, South Korea

## Prepared by

Shenzhen United Testing Technology Co., Ltd.  
2F, Annex Bldg, Jiahuangyuan Tech Park, #365 Baotian 1 Rd, Tiegang  
Community, Xixiang Str, Bao'an District, Shenzhen, China

## TEST RESULT CERTIFICATION

**Applicant's name**.....: ABKO CO., LTD  
Address.....: M Signature 7th floor, 20, Magokjungang 1-ro, Gangseo-gu,  
Seoul, South Korea  
**Manufacturer's Name**.....: ABKO CO., LTD  
Address.....: M Signature 7th floor, 20, Magokjungang 1-ro, Gangseo-gu,  
Seoul, South Korea

### Product description

Product name.....: Wireless keyboard  
Trade Mark.....: ABKO  
Model and/or type reference : WKM910 (KEYBOARD)

**Standards**.....: FCC Rules and Regulations Part 15 Subpart C Section 15.249  
ANSI C63.10: 2013

This device described above has been tested by Shenzhen United Testing Technology Co., Ltd., and the test results show that the equipment under test (EUT) is in compliance with the FCC requirements. And it is applicable only to the tested sample identified in the report.

This report shall not be reproduced except in full, without the written approval of UNI, this document may be altered or revised by Shenzhen United Testing Technology Co., Ltd., personnel only, and shall be noted in the revision of the document.

**Date of Test**..... :  
Date (s) of performance of tests.....: Jan. 15 ~ 25, 2021  
Date of Issue.....: Jan. 25, 2021  
Test Result.....: Pass

Tested by:

*Bob Liao*

Bob liao/Editor

Reviewer:

*Kahn Yang*

Kahn yang/Supervisor

Approved & Authorized Signer:

*Liuze*

Liuze/Manager

Table of Contents

Page

|  |    |
|--|----|
| <b>1. TEST SUMMARY</b>                   | 4  |
| 1.1 TEST PROCEDURES AND RESULTS          | 4  |
| 1.2 TEST FACILITY                        | 4  |
| 1.3 MEASUREMENT UNCERTAINTY              | 4  |
| <b>2. GENERAL INFORMATION</b>            | 5  |
| 2.1 GENERAL DESCRIPTION OF EUT           | 5  |
| 2.2 Carrier Frequency of Channels        | 5  |
| 2.3 Operation of EUT during testing      | 5  |
| 2.5 MEASUREMENT INSTRUMENTS LIST         | 6  |
| <b>3. CONDUCTED EMISSIONS TEST</b>       | 7  |
| 3.1 Conducted Power Line Emission Limit  | 7  |
| 3.2 Test Setup                           | 7  |
| 3.3 Test Procedure                       | 7  |
| 3.4 Test Result                          | 7  |
| <b>4. RADIATED EMISSION TEST</b>         | 8  |
| 4.1 Radiation Limit                      | 8  |
| 4.2 Test Setup                           | 8  |
| 4.3 Test Procedure                       | 9  |
| 4.4 Test Result                          | 9  |
| <b>5. BAND EDGE</b>                      | 14 |
| 5.1 Limits                               | 14 |
| 5.2 Test Procedure                       | 14 |
| 5.3 Test Result                          | 14 |
| <b>6. OCCUPIED BANDWIDTH MEASUREMENT</b> | 16 |
| 6.1 Test Setup                           | 16 |
| 6.2 Test Procedure                       | 16 |
| 6.3 Measurement Equipment Used           | 16 |
| 6.4 Test Result                          | 16 |
| <b>7. ANTENNA REQUIREMENT</b>            | 18 |
| <b>8. PHOTOGRAPH OF TEST</b>             | 19 |

## 1. TEST SUMMARY

### 1.1 TEST PROCEDURES AND RESULTS

| DESCRIPTION OF TEST            | RESULT    |
|--------------------------------|-----------|
| CONDUCTED EMISSIONS TEST       | N/A       |
| RADIATED EMISSION TEST         | COMPLIANT |
| BAND EDGE                      | COMPLIANT |
| OCCUPIED BANDWIDTH MEASUREMENT | COMPLIANT |
| ANTENNA REQUIREMENT            | COMPLIANT |

Remark: "N/A" means Not Applicable

### 1.2 TEST FACILITY

Test Firm : Shenzhen United Testing Technology Co., Ltd.  
 Address : 2F, Annex Bldg, Jiahuangyuan Tech Park, #365 Baotian 1 Rd, Tiegang Community, Xixiang Str, Bao'an District, Shenzhen, China

The testing quality ability of our laboratory meet with "Quality Law of People's Republic of China" Clause 19. The testing quality system of our laboratory meets with ISO/IEC-17025 requirements, which is approved by CNAS. This approval result is accepted by MRA of APLAC.

Our test facility is recognized, certified, or accredited by the following organizations:

CNAS-LAB Code: L6494

The EMC Laboratory has been assessed and in compliance with CNAS-CL01 accreditation criteria for testing Laboratories (identical to ISO/IEC 17025:2017 General Requirements) for the Competence of testing Laboratories.

Designation Number: CN1227

Test Firm Registration Number: 674885

The EMC Laboratory has been registered and fully described in a report filed with the (FCC) Federal Communications commission. The acceptance letter from the FCC is maintained in our files.

A2LA Certificate Number: 4747.01

### 1.3 MEASUREMENT UNCERTAINTY

#### Measurement Uncertainty

|   |               |
|---|---------------|
| Conducted Emission Expanded Uncertainty               | = 2.23dB, k=2 |
| Radiated emission expanded uncertainty(9kHz-30MHz)    | = 3.08dB, k=2 |
| Radiated emission expanded uncertainty(30MHz-1000MHz) | = 4.42dB, k=2 |
| Radiated emission expanded uncertainty(Above 1GHz)    | = 4.06dB, k=2 |

## 2. GENERAL INFORMATION

### 2.1 GENERAL DESCRIPTION OF EUT

|                    |                    |
|--------------------|--------------------|
| Equipment          | Wireless keyboard  |
| Trade Mark         | ABKO               |
| Test Model Name    | WKM910 (KEYBOARD)  |
| Sample ID          | UNIA21012008ER-1#  |
| Serial No.         | N/A                |
| Model Difference   | N/A                |
| FCC ID             | 2AWXK-WKM910K      |
| Antenna Type       | PCB Antenna        |
| Antenna Gain       | 1.8dBi             |
| Frequency Range    | 2403.85-2479.85MHz |
| Number of Channels | 16CH               |
| Modulation Type    | GFSK               |
| Power Source       | DC 1.5V AA Battery |

Table for auxiliary equipment:

| Equipment Description | Manufacturer | Model | Serial Number |
|-----------------------|--------------|-------|---------------|
| N/A                   | N/A          | N/A   | N/A           |

### 2.2 Carrier Frequency of Channels

| Channel List |                 |         |                 |         |                 |         |                 |
|--------------|-----------------|---------|-----------------|---------|-----------------|---------|-----------------|
| Channel      | Frequency (MHz) | Channel | Frequency (MHz) | Channel | Frequency (MHz) | Channel | Frequency (MHz) |
| 00           | 2403.85         | 01      | 2407.85         | 02      | 2414.85         | 03      | 2419.85         |
| 04           | 2422.85         | 05      | 2426.85         | 06      | 2436.85         | 07      | 2439.85         |
| 08           | 2441.85         | 09      | 2445.85         | 10      | 2453.85         | 11      | 2459.85         |
| 12           | 2463.85         | 13      | 2466.85         | 14      | 2473.85         | 15      | 2479.85         |

### 2.3 Operation of EUT during testing

#### Operating Mode

The mode is used: Transmitting mode

Low Channel: 2403.85MHz

Middle Channel: 2414.85MHz

High Channel: 2479.85MHz

Press any button to start transmitting signal



2.5 MEASUREMENT INSTRUMENTS LIST

| Item                            | Equipment                           | Manufacturer  | Model No.   | Serial No.    | Calibrated until |
|---------------------------------|-------------------------------------|---------------|-------------|---------------|------------------|
| <b>CONDUCTED EMISSIONS TEST</b> |                                     |               |             |               |                  |
| 1                               | AMN                                 | Schwarzbeck   | NNLK8121    | 8121370       | 2021.09.05       |
| 2                               | AMN                                 | ETS           | 3810/2      | 00020199      | 2021.09.05       |
| 3                               | EMI TEST RECEIVER                   | Rohde&Schwarz | ESCI        | 101210        | 2021.09.05       |
| 4                               | AAN                                 | TESEQ         | T8-Cat6     | 38888         | 2021.09.05       |
| <b>RADIATED EMISSION TEST</b>   |                                     |               |             |               |                  |
| 1                               | Horn Antenna                        | Sunol         | DRH-118     | A101415       | 2021.09.05       |
| 2                               | BicoNILog Antenna                   | Sunol         | JB1 Antenna | A090215       | 2021.09.05       |
| 3                               | PREAMP                              | HP            | 8449B       | 3008A00160    | 2021.09.05       |
| 4                               | PREAMP                              | HP            | 8447D       | 2944A07999    | 2021.09.05       |
| 5                               | EMI TEST RECEIVER                   | Rohde&Schwarz | ESR3        | 101891        | 2021.09.05       |
| 6                               | VECTOR Signal Generator             | Rohde&Schwarz | SMU200A     | 101521        | 2021.09.05       |
| 7                               | Signal Generator                    | Agilent       | E4421B      | MY4335105     | 2021.09.05       |
| 8                               | MXA Signal Analyzer                 | Agilent       | N9020A      | MY50510140    | 2021.09.05       |
| 9                               | MXA Signal Analyzer                 | Agilent       | N9020A      | MY51110104    | 2021.09.05       |
| 10                              | ANT Tower&Turn table Controller     | Champro       | EM 1000     | 60764         | 2021.09.05       |
| 11                              | Anechoic Chamber                    | Taihe Maorui  | 9m*6m*6m    | 966A0001      | 2021.09.05       |
| 12                              | Shielding Room                      | Taihe Maorui  | 6.4m*4m*3m  | 643A0001      | 2021.09.05       |
| 13                              | RF Power sensor                     | DARE          | RPR3006W    | 15I00041SNO88 | 2021.09.05       |
| 14                              | RF Power sensor                     | DARE          | RPR3006W    | 15I00041SNO89 | 2021.09.05       |
| 15                              | RF power divider                    | Anritsu       | K241B       | 992289        | 2021.09.05       |
| 16                              | Wideband radio communication tester | Rohde&Schwarz | CMW500      | 154987        | 2021.09.05       |
| 17                              | Biconical antenna                   | Schwarzbeck   | VHA 9103    | 91032360      | 2021.09.05       |
| 18                              | Biconical antenna                   | Schwarzbeck   | VHA 9103    | 91032361      | 2021.09.05       |
| 19                              | Broadband Hybrid Antennas           | Schwarzbeck   | VULB9163    | VULB9163#958  | 2021.09.05       |
| 20                              | Horn Antenna                        | Schwarzbeck   | BBHA9120D   | 9120D-1680    | 2021.09.05       |
| 21                              | Active Receive Loop Antenna         | Schwarzbeck   | FMZB 1919B  | 00023         | 2021.09.05       |
| 22                              | Horn Antenna                        | Schwarzbeck   | BBHA 9170   | BBHA9170651   | 2021.09.05       |
| 23                              | Microwave Broadband Preampifier     | Schwarzbeck   | BBV 9721    | 100472        | 2021.09.05       |
| 24                              | Active Loop Antenna                 | Com-Power     | AL-130R     | 10160009      | 2021.09.05       |
| 25                              | Power Meter                         | KEYSIGHT      | N1911A      | MY50520168    | 2021.09.05       |
| 26                              | Frequency Meter                     | VICTOR        | VC2000      | 997406086     | 2021.09.05       |
| 27                              | DC Power Source                     | HYELEC        | HY5020E     | 055161818     | 2021.09.05       |
| <b>Test software</b>            |                                     |               |             |               |                  |
| 1                               | E3                                  | Audix         | 6.101223a   | N/A           | N/A              |

### 3. CONDUCTED EMISSIONS TEST

#### 3.1 Conducted Power Line Emission Limit

For unintentional device, according to § 15.107(a) & RSS-Gen [8.8] Line Conducted Emission Limits is as following

| Frequency<br>(MHz) | Maximum RF Line Voltage(dB $\mu$ V) |      |         |        |
|--------------------|-------------------------------------|------|---------|--------|
|                    | CLASS A                             |      | CLASS B |        |
|                    | Q.P.                                | Ave. | Q.P.    | Ave.   |
| 0.15~0.50          | 79                                  | 66   | 66~56*  | 56~46* |
| 0.50~5.00          | 73                                  | 60   | 56      | 46     |
| 5.00~30.0          | 73                                  | 60   | 60      | 50     |

\* Decreasing linearly with the logarithm of the frequency

For intentional device, according to §15.207(a) Line Conducted Emission Limit is same as above table.

#### 3.2 Test Setup

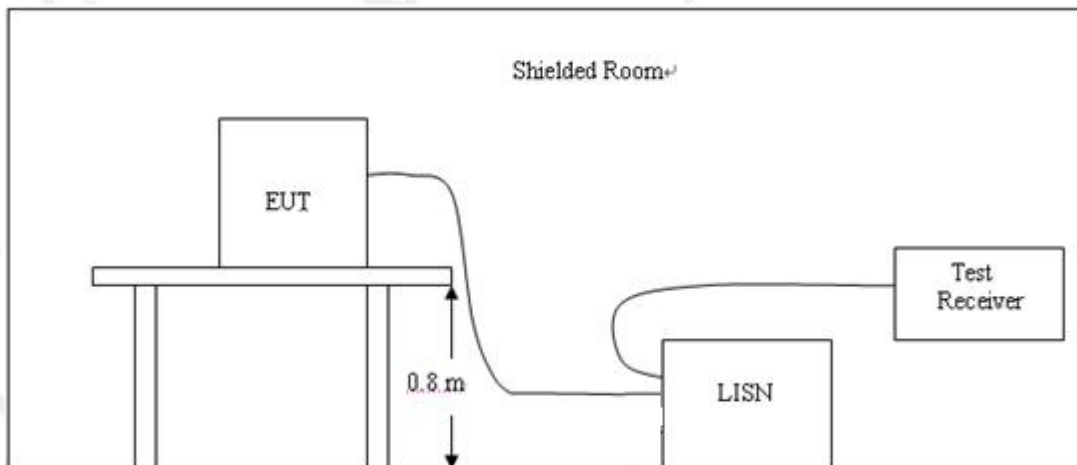

#### 3.3 Test Procedure

- 1, The equipment was set up as per the test configuration to simulate typical actual usage per the user's manual. The EUT is a tabletop system, a wooden table with a height of 0.8 meters is used and is placed on the ground plane as per ANSI C63.10.
- 2, Support equipment, if needed, was placed as per ANSI C63.10.
- 3, All I/O cables were positioned to simulate typical actual usage as per ANSI C63.10.
- 4, If a EUT received DC power from the USB Port of Notebook PC, the PC's adapter received AC120V/60Hz power through a Line Impedance Stabilization Network (LISN) which supplied power source and was grounded to the ground plane.
- 5, All support equipments received AC power from a second LISN, if any.
- 6, The EUT test program was started. Emissions were measured on each current carrying line of the EUT using a spectrum Analyzer / Receiver connected to the LISN powering the EUT. The LISN has two monitoring points: Line 1 (Hot Side) and Line 2 (Neutral Side). Two scans were taken: one with Line 1 connected to Analyzer / Receiver and Line 2 connected to a 50 ohm load; the second scan had Line 1 connected to a 50 ohm load and Line 2 connected to the Analyzer / Receiver.
- 7, Analyzer / Receiver scanned from 150 KHz to 30MHz for emissions in each of the test modes.

#### 3.4 Test Result

N/A

Remark:

The EUT is powered by Battery, no requirements for this item.

## 4. RADIATED EMISSION TEST

### 4.1 Radiation Limit

For unintentional device, according to § 15.109(a) & RSS-247 [5.5], except for Class A digital devices, the field strength of radiated emissions from unintentional radiators at a distance of 3 meters shall not exceed the following values:

| Frequency (MHz) | Distance (Meters) | Radiated (dB $\mu$ V/m) | Radiated ( $\mu$ V/m) |
|-----------------|-------------------|-------------------------|-----------------------|
| 30-88           | 3                 | 40                      | 100                   |
| 88-216          | 3                 | 43.5                    | 150                   |
| 216-960         | 3                 | 46                      | 200                   |
| Above 960       | 3                 | 54                      | 500                   |

For intentional device, according to § 15.209(a), the general requirement of field strength of radiated emissions from intentional radiators at a distance of 3 meters shall not exceed the above table.

### 4.2 Test Setup

#### 1. Radiated Emission Test-Up Frequency Below 30MHz

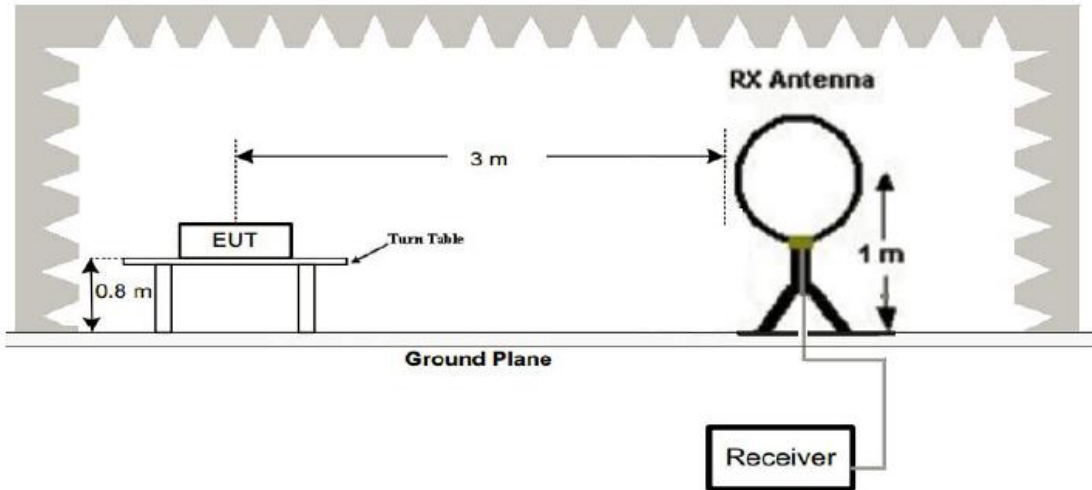

#### 2. Radiated Emission Test-Up Frequency 30MHz~1GHz

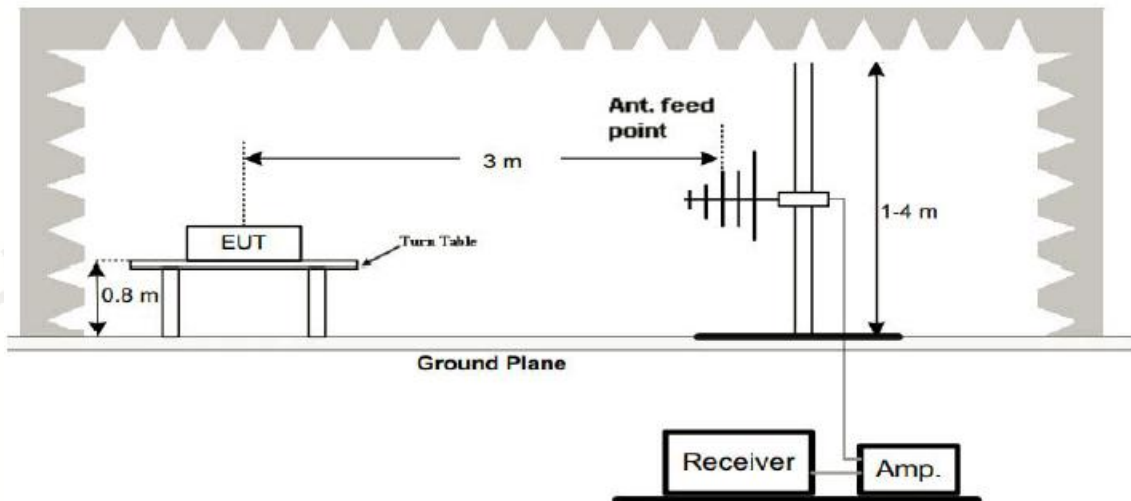



### 3. Radiated Emission Test-Up Frequency Above 1GHz

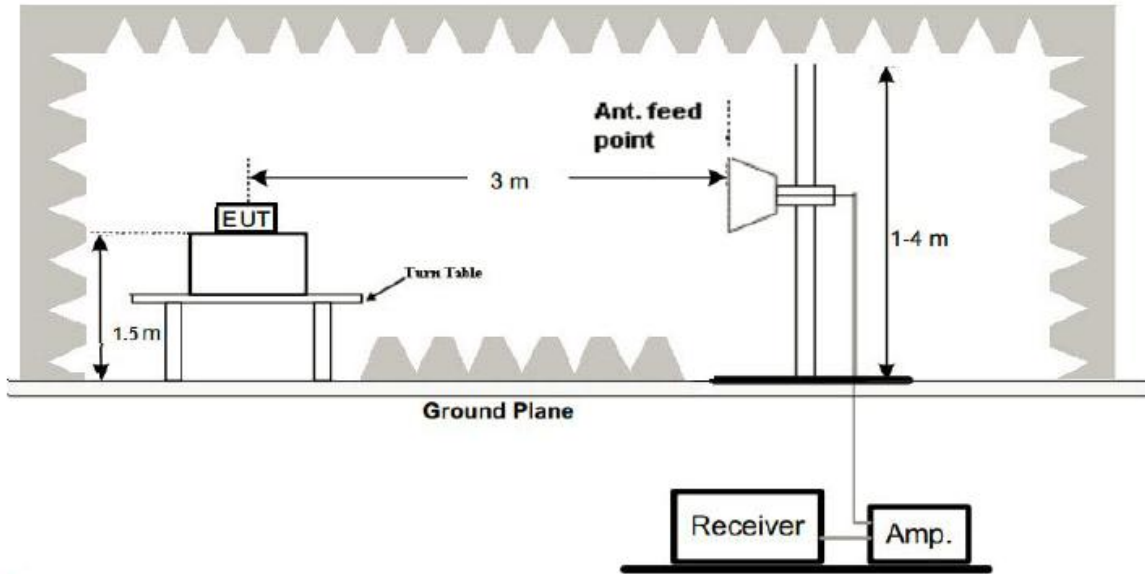

#### 4.3 Test Procedure

1. Below 1GHz measurement the EUT is placed on turntable which is 0.8m above ground plane. And above 1GHz measurement EUT was placed on low permittivity and low tangent turn table which is 1.5m above ground plane.
2. The turntable shall be rotated for 360 degrees to determine the position of maximum emission level.
3. EUT is set 3m away from the receiving antenna, which is varied from 1m to 4m to find out the highest emissions.
4. Maximum procedure was performed on the six highest emissions to ensure EUT compliance.
5. And also, each emission was to be maximized by changing the polarization of receiving antenna both horizontal and vertical.
6. Repeat above procedures until the measurements for all frequencies are complete.
7. The test frequency range from 9KHz to 25GHz per FCC PART 15.33(a).
8. The distance between test antenna and EUT as following table states:

| Test Frequency range | Test Antenna Type   | Test Distance |
|----------------------|---------------------|---------------|
| 9KHz-30MHz           | Active Loop Antenna | 3             |
| 30MHz-1GHz           | Bilog Antenna       | 3             |
| 1GHz-18GHz           | Horn Antenna        | 3             |
| 18GHz-25GHz          | Horn Antenna        | 1             |

**Note:**

For battery operated equipment, the equipment tests shall be performed using a new battery.

#### 4.4 Test Result

PASS  
Remark:

1. We tested at Low, Middle and High channel, recored the worst data at Low channel in the report.
2. By preliminary testing and verifying three axis (X, Y and Z) position of EUT transmitted status, it was found that "Z axis" position was the worst, and test data recorded in this report.
3. Radiated emission test from 9KHz to 10th harmonic of fundamental was verified, and no emission found except system noise floor in 9KHz to 30MHz and not recorded in this report.

Below 1GHz Test Results:

|               |                                      |                    |            |
|---------------|--------------------------------------|--------------------|------------|
| Temperature:  | 22°C                                 | Relative Humidity: | 48%        |
| Test Date:    | Jan. 19, 2021                        | Pressure:          | 1010hPa    |
| Test Voltage: | DC 1.5V                              | Polarization:      | Horizontal |
| Test Mode:    | Transmitting mode of GFSK 2403.85MHz |                    |            |

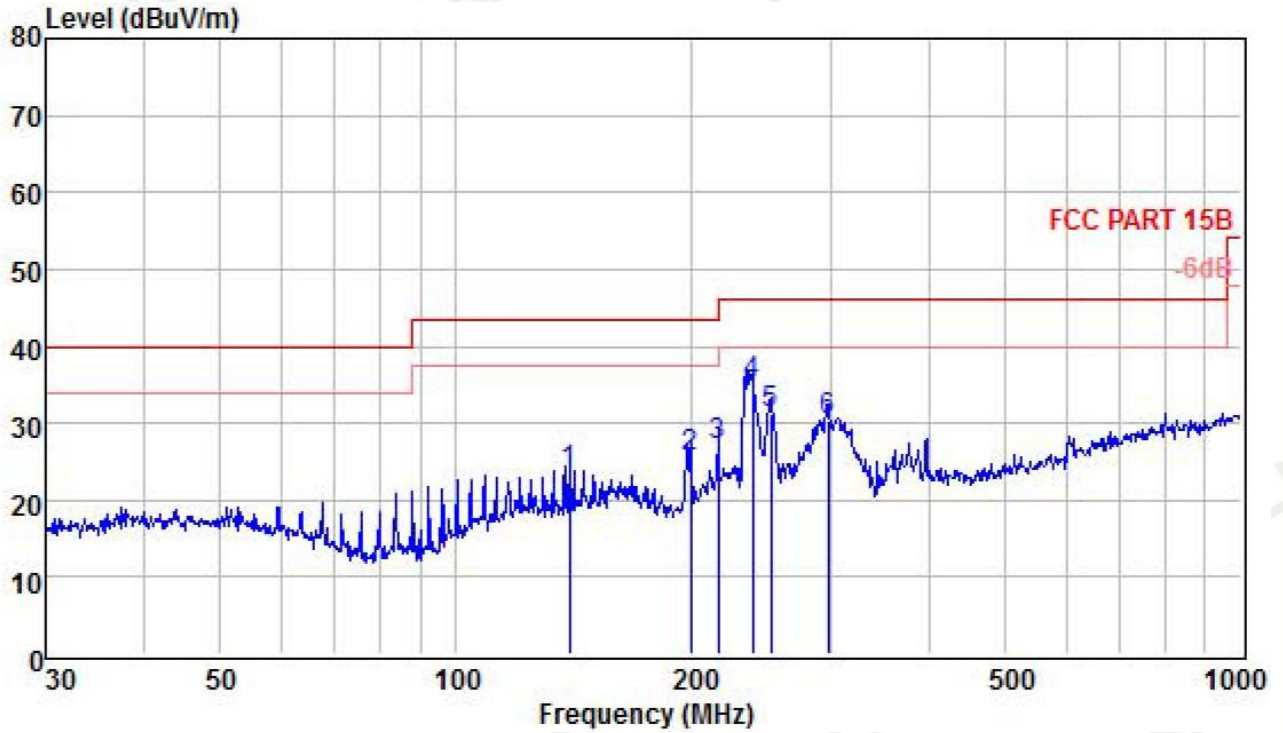

|      | ReadAntenna | Cable  | Limit | Over   |        |       |           |
|------|-------------|--------|-------|--------|--------|-------|-----------|
| Freq | Level       | Factor | Loss  | Level  | Line   | Limit | Remark    |
| MHz  | dBuV        | dB/m   | dB    | dBuV/m | dBuV/m | dB    |           |
| 1    | 139.36      | 8.13   | 14.48 | 0.85   | 23.46  | 43.50 | -20.04 QP |
| 2    | 199.29      | 15.05  | 9.71  | 0.88   | 25.64  | 43.50 | -17.86 QP |
| 3    | 216.02      | 16.15  | 10.11 | 0.87   | 27.13  | 46.00 | -18.87 QP |
| 4    | 238.31      | 23.35  | 10.75 | 0.87   | 34.97  | 46.00 | -11.03 QP |
| 5    | 252.06      | 18.71  | 11.63 | 0.86   | 31.20  | 46.00 | -14.80 QP |
| 6    | 298.27      | 15.77  | 13.85 | 0.85   | 30.47  | 46.00 | -15.53 QP |

Remark: Absolute Level = Reading Level + Factor, Margin = Absolute Level – Limit  
 Factor = Ant. Factor + Cable Loss

|               |                                      |                    |          |
|---------------|--------------------------------------|--------------------|----------|
| Temperature:  | 22°C                                 | Relative Humidity: | 48%      |
| Test Date:    | Jan. 19, 2021                        | Pressure:          | 1010hPa  |
| Test Voltage: | DC 1.5V                              | Polarization:      | Vertical |
| Test Mode:    | Transmitting mode of GFSK 2403.85MHz |                    |          |

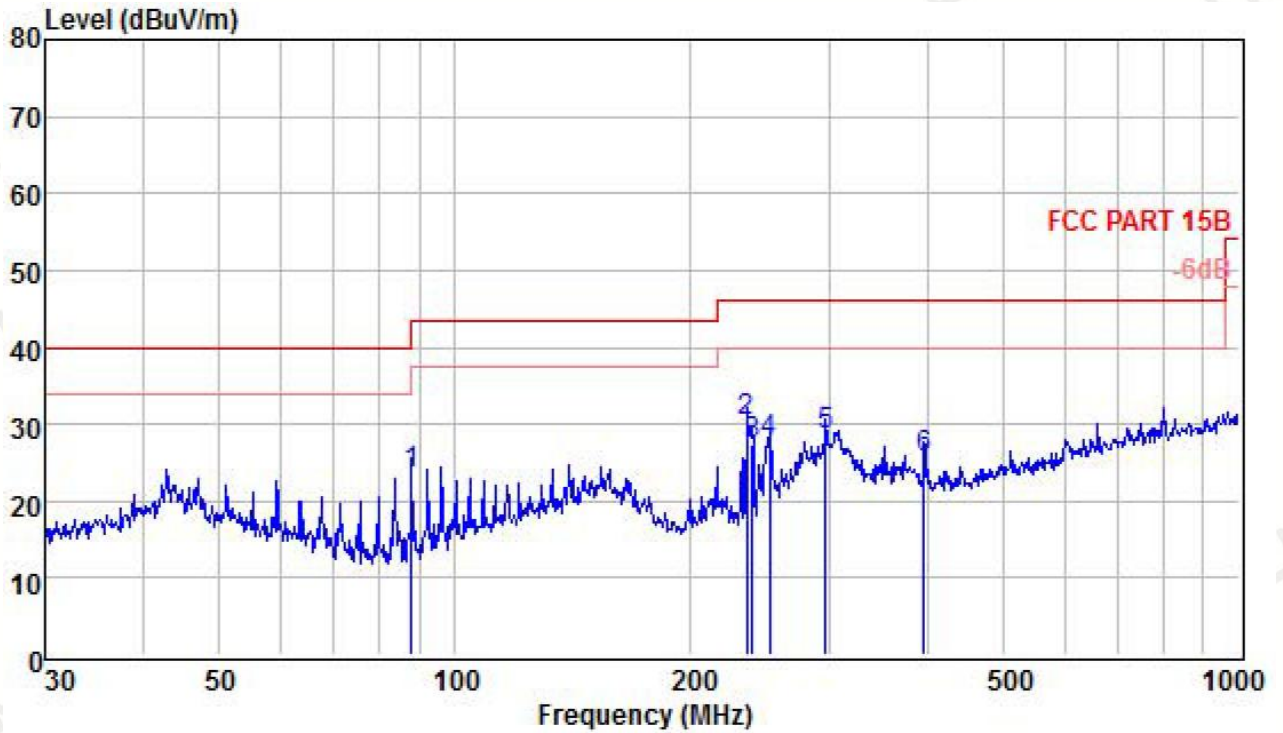

|      | Read   | Antenna | Cable | Limit  | Over   |                 |
|------|--------|---------|-------|--------|--------|-----------------|
| Freq | Level  | Factor  | Loss  | Line   | Limit  | Remark          |
| MHz  | dBuV   | dB/m    | dB    | dBuV/m | dBuV/m | dB              |
| 1    | 88.03  | 13.84   | 8.84  | 0.85   | 23.53  | 43.50 -19.97 QP |
| 2    | 235.82 | 18.69   | 10.68 | 0.87   | 30.24  | 46.00 -15.76 QP |
| 3    | 239.15 | 15.70   | 10.78 | 0.87   | 27.35  | 46.00 -18.65 QP |
| 4    | 252.06 | 15.04   | 11.63 | 0.86   | 27.53  | 46.00 -18.47 QP |
| 5    | 297.22 | 13.83   | 13.82 | 0.85   | 28.50  | 46.00 -17.50 QP |
| 6    | 396.24 | 8.76    | 15.63 | 1.29   | 25.68  | 46.00 -20.32 QP |

Remark: Absolute Level = Reading Level + Factor, Margin = Absolute Level – Limit  
 Factor = Ant. Factor + Cable Loss

Remark:

- (1) Measuring frequencies from 9 KHz to the 1 GHz, Radiated emission test from 9KHz to 30MHz was verified, and no any emission was found except system noise floor.
- (2) \* denotes emission frequency which appearing within the Restricted Bands specified in provision of 15.205, then the general radiated emission limits in 15.209 apply.
- (3) The IF bandwidth of EMI Test Receiver between 30MHz to 1GHz was 120KHz, 1 MHz for measuring above 1 GHz, below 30MHz was 10KHz.



Above 1 GHz Test Results:  
CH Low (2403.85MHz)

Horizontal

| Frequency<br>(MHz) | Reading Result<br>(dBμV) | Factor<br>(dB) | Emission Level<br>(dBμV/m) | Limits<br>(dBμV/m) | Margin<br>(dB) | Detector<br>Type |
|--------------------|--------------------------|----------------|----------------------------|--------------------|----------------|------------------|
| 2403.85            | 111.08                   | -5.84          | 105.24                     | 114.00             | -8.76          | PK               |
| 2403.85            | 83.37                    | -5.84          | 77.53                      | 94.00              | -16.47         | AV               |
| 4807.70            | 62.14                    | -3.64          | 58.50                      | 74.00              | -15.50         | PK               |
| 4807.70            | 51.11                    | -3.64          | 47.47                      | 54.00              | -6.53          | AV               |
| 7211.55            | 58.33                    | -0.95          | 57.38                      | 74.00              | -16.62         | PK               |
| 7211.55            | 48.49                    | -0.95          | 47.54                      | 54.00              | -6.46          | AV               |

Remark: Factor = Antenna Factor + Cable Loss – Pre-amplifier. Margin = Absolute Level – Limit

Vertical

| Frequency<br>(MHz) | Reading Result<br>(dBμV) | Factor<br>(dB) | Emission Level<br>(dBμV/m) | Limits<br>(dBμV/m) | Margin<br>(dB) | Detector<br>Type |
|--------------------|--------------------------|----------------|----------------------------|--------------------|----------------|------------------|
| 2403.85            | 111.81                   | -5.84          | 105.97                     | 114.00             | -8.03          | PK               |
| 2403.85            | 81.65                    | -5.84          | 75.81                      | 94.00              | -18.19         | AV               |
| 4807.70            | 60.17                    | -3.64          | 56.53                      | 74.00              | -17.47         | PK               |
| 4807.70            | 51.26                    | -3.64          | 47.62                      | 54.00              | -6.38          | AV               |
| 7211.55            | 56.69                    | -0.95          | 55.74                      | 74.00              | -18.26         | PK               |
| 7211.55            | 47.83                    | -0.95          | 46.88                      | 54.00              | -7.12          | AV               |

Remark: Factor = Antenna Factor + Cable Loss – Pre-amplifier. Margin = Absolute Level – Limit

CH Middle (2441.85MHz)

Horizontal

| Frequency<br>(MHz) | Reading Result<br>(dBμV) | Factor<br>(dB) | Emission Level<br>(dBμV/m) | Limits<br>(dBμV/m) | Margin<br>(dB) | Detector<br>Type |
|--------------------|--------------------------|----------------|----------------------------|--------------------|----------------|------------------|
| 2441.85            | 112.19                   | -5.84          | 106.35                     | 114.00             | -7.65          | PK               |
| 2441.85            | 82.31                    | -5.84          | 76.47                      | 94.00              | -17.53         | AV               |
| 4883.70            | 62.24                    | -3.64          | 58.60                      | 74.00              | -15.40         | PK               |
| 4883.70            | 52.52                    | -3.64          | 48.88                      | 54.00              | -5.12          | AV               |
| 7325.55            | 56.45                    | -0.95          | 55.50                      | 74.00              | -18.50         | PK               |
| 7325.55            | 47.17                    | -0.95          | 46.22                      | 54.00              | -7.78          | AV               |

Remark: Factor = Antenna Factor + Cable Loss – Pre-amplifier. Margin = Absolute Level – Limit

Vertical

| Frequency<br>(MHz) | Reading Result<br>(dBμV) | Factor<br>(dB) | Emission Level<br>(dBμV/m) | Limits<br>(dBμV/m) | Margin<br>(dB) | Detector<br>Type |
|--------------------|--------------------------|----------------|----------------------------|--------------------|----------------|------------------|
| 2441.85            | 112.15                   | -5.71          | 106.44                     | 114.00             | -7.56          | PK               |
| 2441.85            | 82.42                    | -5.71          | 76.71                      | 94.00              | -17.29         | AV               |
| 4883.70            | 61.33                    | -3.51          | 57.82                      | 74.00              | -16.18         | PK               |
| 4883.70            | 50.27                    | -3.51          | 46.76                      | 54.00              | -7.24          | AV               |
| 7325.55            | 56.22                    | -0.82          | 55.40                      | 74.00              | -18.60         | PK               |
| 7325.55            | 46.71                    | -0.82          | 45.89                      | 54.00              | -8.11          | AV               |

Remark: Factor = Antenna Factor + Cable Loss – Pre-amplifier. Margin = Absolute Level – Limit



CH High (2479.85MHz)

Horizontal

| Frequency<br>(MHz) | Reading Result<br>(dBμV) | Factor<br>(dB) | Emission Level<br>(dBμV/m) | Limits<br>(dBμV/m) | Margin<br>(dB) | Detector<br>Type |
|--------------------|--------------------------|----------------|----------------------------|--------------------|----------------|------------------|
| 2479.85            | 113.82                   | -5.65          | 108.17                     | 114.00             | -5.83          | PK               |
| 2479.85            | 82.12                    | -5.65          | 76.47                      | 94.00              | -17.53         | AV               |
| 4959.70            | 61.81                    | -3.43          | 58.38                      | 74.00              | -15.62         | PK               |
| 4959.70            | 50.37                    | -3.43          | 46.94                      | 54.00              | -7.06          | AV               |
| 7439.55            | 57.25                    | -0.75          | 56.50                      | 74.00              | -17.50         | PK               |
| 7439.55            | 46.29                    | -0.75          | 45.54                      | 54.00              | -8.46          | AV               |

Remark: Factor = Antenna Factor + Cable Loss – Pre-amplifier. Margin = Absolute Level – Limit

Vertical

| Frequency<br>(MHz) | Reading Result<br>(dBμV) | Factor<br>(dB) | Emission Level<br>(dBμV/m) | Limits<br>(dBμV/m) | Margin<br>(dB) | Detector<br>Type |
|--------------------|--------------------------|----------------|----------------------------|--------------------|----------------|------------------|
| 2479.85            | 113.44                   | -5.65          | 107.79                     | 114.00             | -6.21          | PK               |
| 2479.85            | 82.39                    | -5.65          | 76.74                      | 94.00              | -17.26         | AV               |
| 4959.70            | 61.52                    | -3.43          | 58.09                      | 74.00              | -15.91         | PK               |
| 4959.70            | 50.27                    | -3.43          | 46.84                      | 54.00              | -7.16          | AV               |
| 7439.55            | 57.59                    | -0.75          | 56.84                      | 74.00              | -17.16         | PK               |
| 7439.55            | 46.77                    | -0.75          | 46.02                      | 54.00              | -7.98          | AV               |

Remark: Factor = Antenna Factor + Cable Loss – Pre-amplifier. Margin = Absolute Level – Limit

Remark:

- (1) Measuring frequencies from 1 GHz to the 25 GHz.
- (2) "F" denotes fundamental frequency; "H" denotes spurious frequency. "E" denotes band edge frequency.
- (3) \* denotes emission frequency which appearing within the Restricted Bands specified in provision of 15.205, then the general radiated emission limits in 15.209 apply.
- (4) Data of measurement within this frequency range shown "—" in the table above means the reading of emissions are attenuated more than 20dB below the permissible limits or the field strength is too small to be measured.
- (5) The IF bandwidth of EMI Test Receiver between 30MHz to 1GHz was 120KHz, 1 MHz for measuring above 1 GHz, below 30MHz was 10KHz. The resolution bandwidth of test receiver/spectrum analyzer is 1MHz and video bandwidth is 3MHz for peak measurement with peak detector at frequency above 1GHz. The resolution bandwidth of test receiver/spectrum analyzer is 1MHz and video bandwidth is 10Hz for Average measurement with peak detection at frequency above 1GHz.
- (6) When the test results of Peak Detected below the limits of Average Detected, the Average Detected is not need completed. For example: Top Channel at Fundamental 73.16dBuV/m(PK Value) <93.98(AV Limit), at harmonic 53.20 dBuV/m(PK Value) <54 dBuV/m(AV Limit), the Average Detected not need to completed.
- (7) All modes of operation were investigated and the worst-case emissions are reported.

## 5. BAND EDGE

### 5.1 Limits

FCC PART 15.249 Emissions radiated outside of the specified frequency bands, except for harmonics, shall be attenuated by at least 20 dB below the level of the fundamental or to the general radiated emission limits in §15.209, whichever is the lesser attenuation.

### 5.2 Test Procedure

The band edge compliance of RF radiated emission should be measured by following the guidance in ANSI C63.10 with respect to maximizing the emission by rotating the EUT, measuring the emission while the EUT is situated in three orthogonal planes (if appropriate), adjusting the measurement antenna height and polarization etc. Set RBW to 1MHz and VBW to 3MHz to measure the peak field strength and set RBW to 1MHz and VBW to 10kHz to measure the average radiated field strength. The conducted RF band edge was measured by using a spectrum analyzer. Set span wide enough to capture the highest in-band emission and the emission at the band edge. Set RBW to 100 KHz and VBW to 300 KHz, to measure the conducted peak band edge.

### 5.3 Test Result

PASS

Radiated Band Edge Test:

Worst case on  $\pi/4$ DQPSK

Operation Mode: TX CH Low (2403.85MHz)

Horizontal

| Frequency (MHz) | Reading Result (dB $\mu$ V) | Factor (dB) | Emission Level (dB $\mu$ V/m) | Limits (dB $\mu$ V/m) | Margin (dB) | Detector Type |
|-----------------|-----------------------------|-------------|-------------------------------|-----------------------|-------------|---------------|
| 2310            | 53.12                       | -5.81       | 47.31                         | 74.00                 | -26.69      | PK            |
| 2310            | /                           | -5.81       | /                             | 54.00                 | /           | AV            |
| 2390            | 53.34                       | -5.84       | 47.50                         | 74.00                 | -26.50      | PK            |
| 2390            | /                           | -5.84       | /                             | 54.00                 | /           | AV            |
| 2400            | 53.18                       | -5.84       | 47.34                         | 74.00                 | -26.66      | PK            |
| 2400            | /                           | -5.84       | /                             | 54.00                 | /           | AV            |

Remark: Factor = Antenna Factor + Cable Loss – Pre-amplifier.

Vertical

| Frequency (MHz) | Reading Result (dB $\mu$ V) | Factor (dB) | Emission Level (dB $\mu$ V/m) | Limits (dB $\mu$ V/m) | Margin (dB) | Detector Type |
|-----------------|-----------------------------|-------------|-------------------------------|-----------------------|-------------|---------------|
| 2310            | 52.29                       | -5.81       | 46.48                         | 74.00                 | -27.52      | PK            |
| 2310            | /                           | -5.81       | /                             | 54.00                 | /           | AV            |
| 2390            | 53.44                       | -5.81       | 47.63                         | 74.00                 | -26.37      | PK            |
| 2390            | /                           | -5.84       | /                             | 54.00                 | /           | AV            |
| 2400            | 53.24                       | -5.84       | 47.40                         | 74.00                 | -26.60      | PK            |
| 2400            | /                           | -5.84       | /                             | 54.00                 | /           | AV            |

Remark: Factor = Antenna Factor + Cable Loss – Pre-amplifier.

Operation Mode: TX CH High (2479.85MHz)

Horizontal

| Frequency (MHz) | Reading Result (dB $\mu$ V) | Factor (dB) | Emission Level (dB $\mu$ V/m) | Limits (dB $\mu$ V/m) | Margin (dB) | Detector Type |
|-----------------|-----------------------------|-------------|-------------------------------|-----------------------|-------------|---------------|
| 2483.5          | 53.36                       | -5.65       | 47.71                         | 74.00                 | -26.29      | PK            |
| 2483.5          | /                           | -5.65       | /                             | 54.00                 | /           | AV            |
| 2500            | 53.22                       | -5.72       | 47.50                         | 74.00                 | -26.50      | PK            |
| 2500            | /                           | -5.72       | /                             | 54.00                 | /           | AV            |

Remark: Factor = Antenna Factor + Cable Loss – Pre-amplifier.

Vertical

| Frequency (MHz) | Reading Result (dB $\mu$ V) | Factor (dB) | Emission Level (dB $\mu$ V/m) | Limits (dB $\mu$ V/m) | Margin (dB) | Detector Type |
|-----------------|-----------------------------|-------------|-------------------------------|-----------------------|-------------|---------------|
| 2483.5          | 52.54                       | -5.65       | 46.89                         | 74.00                 | -27.11      | PK            |
| 2483.5          | /                           | -5.65       | /                             | 54.00                 | /           | AV            |
| 2500            | 53.19                       | -5.72       | 47.47                         | 74.00                 | -26.53      | PK            |
| 2500            | /                           | -5.72       | /                             | 54.00                 | /           | AV            |

Remark: Factor = Antenna Factor + Cable Loss – Pre-amplifier.

## 6. OCCUPIED BANDWIDTH MEASUREMENT

### 6.1 Test Setup

Same as Radiated Emission Measurement

### 6.2 Test Procedure

1. The EUT was placed on a turn table which is 0.8m above ground plane.
2. Set EUT as normal operation.
3. Based on ANSI C63.10 section 6.9.2: RBW=30KHz, VBW=100KHz, Span=3MHz.
4. The useful radiated emission from the EUT was detected by the spectrum analyser with peak detector.

### 6.3 Measurement Equipment Used

Same as Radiated Emission Measurement

### 6.4 Test Result

PASS

GFSK Modulation:

| Frequency (MHz) | 20dB Bandwidth (MHz) | 99% Bandwidth (MHz) | Result |
|-----------------|----------------------|---------------------|--------|
| 2403.85         | 2.167                | 2.100               | PASS   |
| 2441.85         | 2.125                | 2.098               | PASS   |
| 2479.85         | 2.163                | 2.111               | PASS   |

CH: 2403.85MHz

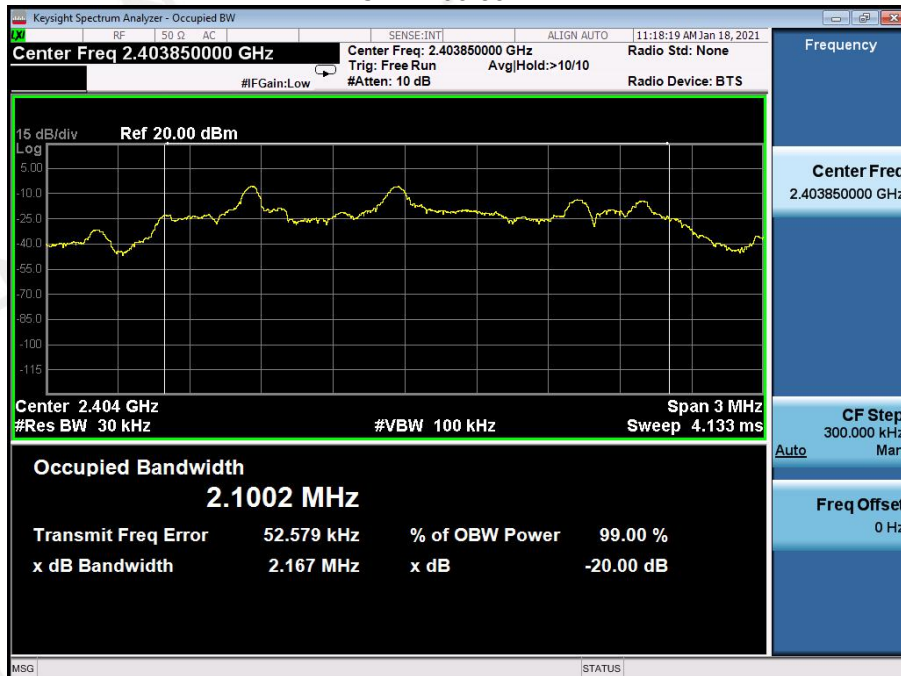



CH: 2441.85MHz

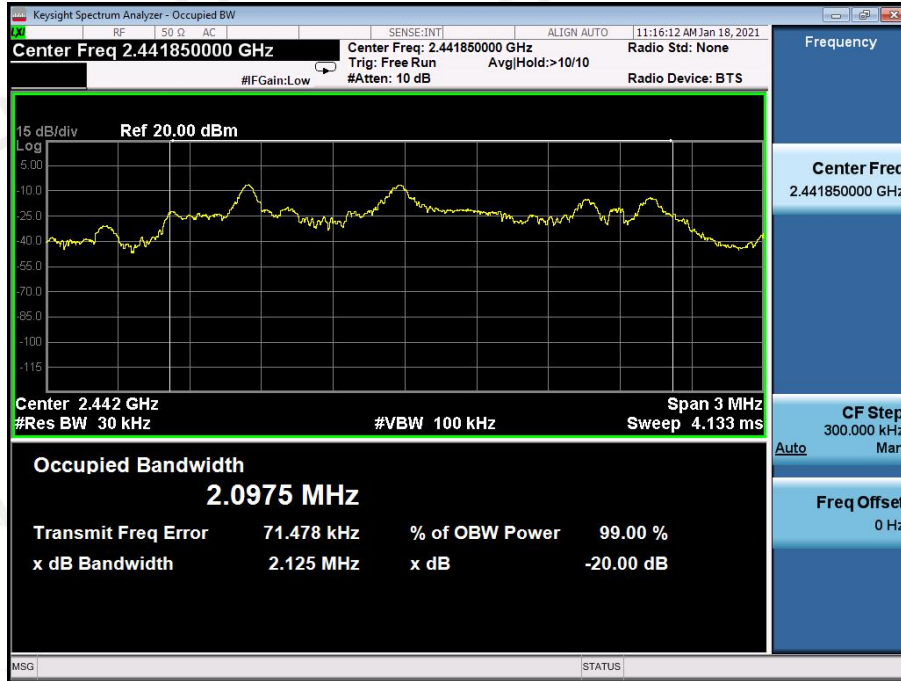

CH: 2479.85MHz

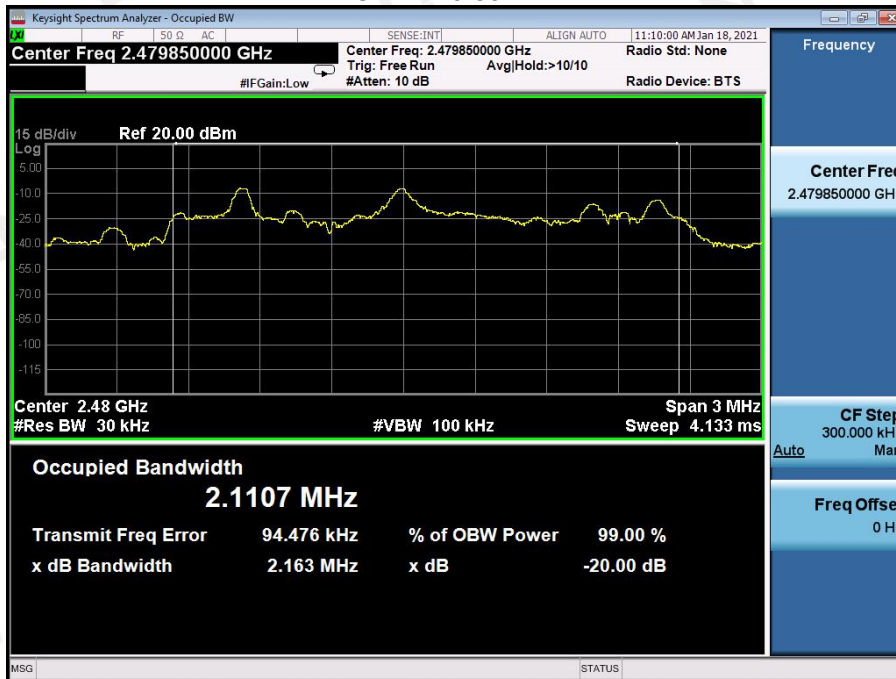

## 7. ANTENNA REQUIREMENT

### Standard Applicable:

For intentional device, according to FCC 47 CFR Section 15.203, an intentional radiator shall be designed to ensure that no antenna other than that furnished by the responsible party shall be used with the device.

### Antenna Connected Construction

The antenna used in this product is an PCB Antenna, The directional gains of antenna used for transmitting is 1.8dBi.

### BT ANTENNA:

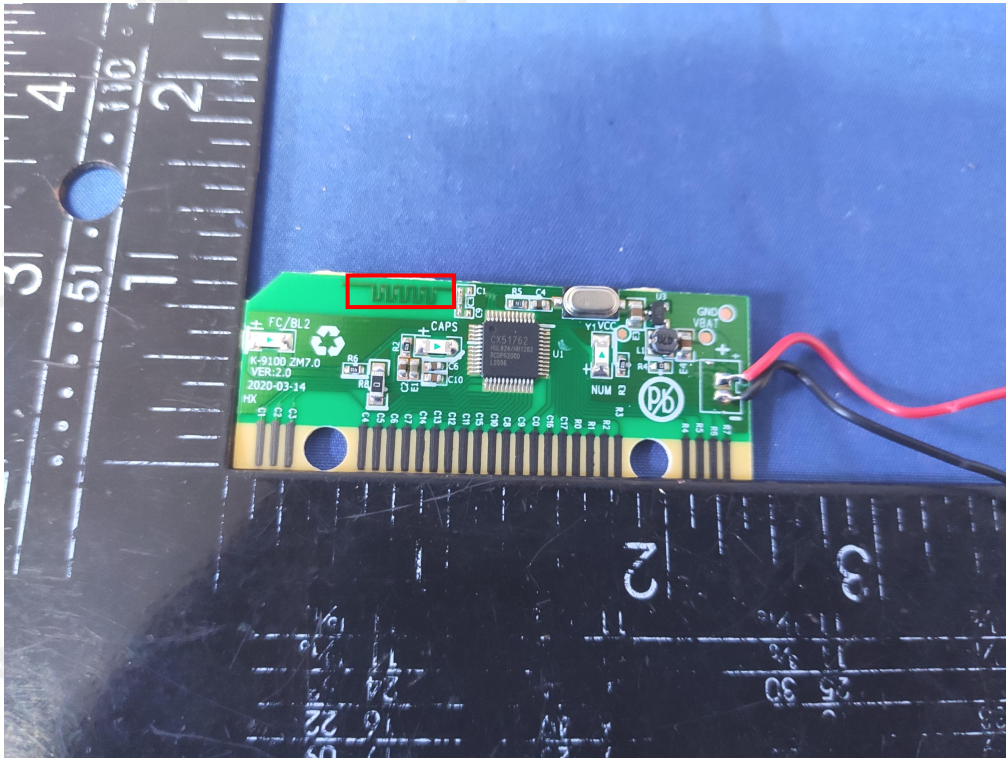

### 8. PHOTOGRAPH OF TEST

**Radiated Emission  
(Below 1G)**



**Radiated Emission  
(Above 1G)**



\*\*\*End of Report\*\*\*