

FCC RADIO TEST REPORT

FCC ID: 2AWXK-WKM810K

Product : Wireless keyboard

Trade Name : ABKO

Model Name :WKM810 (KEYBOARD)

Series Model : N/A

Report No. : UNIA21012009ER-01

Prepared for

ABKO CO., LTD
M Signature 7th floor, 20, Magokjungang 1-ro, Gangseo-gu,
Seoul, South Korea

Prepared by

Shenzhen United Testing Technology Co., Ltd.
2F, Annex Bldg, Jiahuangyuan Tech Park, #365 Baotian 1 Rd, Tiegang
Community, Xixiang Str, Bao'an District, Shenzhen, China

TEST RESULT CERTIFICATION

Applicant's name.....: ABKO CO., LTD
Address.....: M Signature 7th floor, 20, Magokjungang 1-ro, Gangseo-gu,
Seoul, South Korea
Manufacturer's Name.....: ABKO CO., LTD
Address.....: M Signature 7th floor, 20, Magokjungang 1-ro, Gangseo-gu,
Seoul, South Korea

Product description

Product name.....: Wireless keyboard
Trade Mark.....: ABKO
Model and/or type reference : WKM810 (KEYBOARD)

Standards.....: FCC Rules and Regulations Part 15 Subpart C Section 15.249
ANSI C63.10: 2013

This device described above has been tested by Shenzhen United Testing Technology Co., Ltd., and the test results show that the equipment under test (EUT) is in compliance with the FCC requirements. And it is applicable only to the tested sample identified in the report.

This report shall not be reproduced except in full, without the written approval of UNI, this document may be altered or revised by Shenzhen United Testing Technology Co., Ltd., personnel only, and shall be noted in the revision of the document.

Date of Test..... :
Date (s) of performance of tests.....: Jan. 15 ~ 25, 2021
Date of Issue.....: Jan. 25, 2021
Test Result.....: Pass

Tested by:

Bob Liao

Bob liao/Editor

Reviewer:

Kahn Yang

Kahn yang/Supervisor

Approved & Authorized Signer:

Liuze

Liuze/Manager

Table of Contents	Page
1. TEST SUMMARY	4
1.1 TEST PROCEDURES AND RESULTS	4
1.2 TEST FACILITY	4
1.3 MEASUREMENT UNCERTAINTY	4
2. GENERAL INFORMATION	5
2.1 GENERAL DESCRIPTION OF EUT	5
2.2 Carrier Frequency of Channels	5
2.3 Operation of EUT during testing	5
2.5 MEASUREMENT INSTRUMENTS LIST	6
3. CONDUCTED EMISSIONS TEST	7
3.1 Conducted Power Line Emission Limit	7
3.2 Test Setup	7
3.3 Test Procedure	7
3.4 Test Result	7
4. RADIATED EMISSION TEST	8
4.1 Radiation Limit	8
4.2 Test Setup	8
4.3 Test Procedure	9
4.4 Test Result	9
5. BAND EDGE	14
5.1 Limits	14
5.2 Test Procedure	14
5.3 Test Result	14
6. OCCUPIED BANDWIDTH MEASUREMENT	16
6.1 Test Setup	16
6.2 Test Procedure	16
6.3 Measurement Equipment Used	16
6.4 Test Result	16
7. ANTENNA REQUIREMENT	18
8. PHOTOGRAPH OF TEST	19

1. TEST SUMMARY

1.1 TEST PROCEDURES AND RESULTS

DESCRIPTION OF TEST	RESULT
CONDUCTED EMISSIONS TEST	N/A
RADIATED EMISSION TEST	COMPLIANT
BAND EDGE	COMPLIANT
OCCUPIED BANDWIDTH MEASUREMENT	COMPLIANT
ANTENNA REQUIREMENT	COMPLIANT

Remark: "N/A" means Not Applicable

1.2 TEST FACILITY

Test Firm : Shenzhen United Testing Technology Co., Ltd.
 Address : 2F, Annex Bldg, Jiahuangyuan Tech Park, #365 Baotian 1 Rd, Tiegang Community, Xixiang Str, Bao'an District, Shenzhen, China

The testing quality ability of our laboratory meet with "Quality Law of People's Republic of China" Clause 19. The testing quality system of our laboratory meets with ISO/IEC-17025 requirements, which is approved by CNAS. This approval result is accepted by MRA of APLAC.

Our test facility is recognized, certified, or accredited by the following organizations:

CNAS-LAB Code: L6494

The EMC Laboratory has been assessed and in compliance with CNAS-CL01 accreditation criteria for testing Laboratories (identical to ISO/IEC 17025:2017 General Requirements) for the Competence of testing Laboratories.

Designation Number: CN1227

Test Firm Registration Number: 674885

The EMC Laboratory has been registered and fully described in a report filed with the (FCC) Federal Communications commission. The acceptance letter from the FCC is maintained in our files.

A2LA Certificate Number: 4747.01

1.3 MEASUREMENT UNCERTAINTY

Measurement Uncertainty	
Conducted Emission Expanded Uncertainty	= 2.23dB, k=2
Radiated emission expanded uncertainty(9kHz-30MHz)	= 3.08dB, k=2
Radiated emission expanded uncertainty(30MHz-1000MHz)	= 4.42dB, k=2
Radiated emission expanded uncertainty(Above 1GHz)	= 4.06dB, k=2

2. GENERAL INFORMATION

2.1 GENERAL DESCRIPTION OF EUT

Equipment	Wireless keyboard
Trade Mark	ABKO
Test Model Name	WKM810 (KEYBOARD)
Sample ID	UNIA21012009ER-1#
Serial No.	N/A
Model Difference	N/A
FCC ID	2AWXK-WKM810K
Antenna Type	PCB Antenna
Antenna Gain	1.34dBi
Frequency Range	2405-2470MHz
Number of Channels	8CH
Modulation Type	GFSK
Power Source	DC 1.5V AAA Battery

Table for auxiliary equipment:

Equipment Description	Manufacturer	Model	Serial Number
N/A	N/A	N/A	N/A

2.2 Carrier Frequency of Channels

Channel List							
Channel	Frequency (MHz)	Channel	Frequency (MHz)	Channel	Frequency (MHz)	Channel	Frequency (MHz)
00	2405	01	2413	02	2422	03	2430
04	2440	05	2450	06	2460	07	2470

2.3 Operation of EUT during testing

Operating Mode

The mode is used: Transmitting mode

Low Channel: 2405MHz

Middle Channel: 2440MHz

High Channel: 2470MHz

Press any button to start transmitting signal

2.5 MEASUREMENT INSTRUMENTS LIST

Item	Equipment	Manufacturer	Model No.	Serial No.	Calibrated until
CONDUCTED EMISSIONS TEST					
1	AMN	Schwarzbeck	NNLK8121	8121370	2021.09.05
2	AMN	ETS	3810/2	00020199	2021.09.05
3	EMI TEST RECEIVER	Rohde&Schwarz	ESCI	101210	2021.09.05
4	AAN	TESEQ	T8-Cat6	38888	2021.09.05
RADIATED EMISSION TEST					
1	Horn Antenna	Sunol	DRH-118	A101415	2021.09.05
2	BicoNILog Antenna	Sunol	JB1 Antenna	A090215	2021.09.05
3	PREAMP	HP	8449B	3008A00160	2021.09.05
4	PREAMP	HP	8447D	2944A07999	2021.09.05
5	EMI TEST RECEIVER	Rohde&Schwarz	ESR3	101891	2021.09.05
6	VECTOR Signal Generator	Rohde&Schwarz	SMU200A	101521	2021.09.05
7	Signal Generator	Agilent	E4421B	MY4335105	2021.09.05
8	MXA Signal Analyzer	Agilent	N9020A	MY50510140	2021.09.05
9	MXA Signal Analyzer	Agilent	N9020A	MY51110104	2021.09.05
10	ANT Tower&Turn table Controller	Champro	EM 1000	60764	2021.09.05
11	Anechoic Chamber	Taihe Maorui	9m*6m*6m	966A0001	2021.09.05
12	Shielding Room	Taihe Maorui	6.4m*4m*3m	643A0001	2021.09.05
13	RF Power sensor	DARE	RPR3006W	15I00041SNO88	2021.09.05
14	RF Power sensor	DARE	RPR3006W	15I00041SNO89	2021.09.05
15	RF power divider	Anritsu	K241B	992289	2021.09.05
16	Wideband radio communication tester	Rohde&Schwarz	CMW500	154987	2021.09.05
17	Biconical antenna	Schwarzbeck	VHA 9103	91032360	2021.09.05
18	Biconical antenna	Schwarzbeck	VHA 9103	91032361	2021.09.05
19	Broadband Hybrid Antennas	Schwarzbeck	VULB9163	VULB9163#958	2021.09.05
20	Horn Antenna	Schwarzbeck	BBHA9120D	9120D-1680	2021.09.05
21	Active Receive Loop Antenna	Schwarzbeck	FMZB 1919B	00023	2021.09.05
22	Horn Antenna	Schwarzbeck	BBHA 9170	BBHA9170651	2021.09.05
23	Microwave Broadband Preamp	Schwarzbeck	BBV 9721	100472	2021.09.05
24	Active Loop Antenna	Com-Power	AL-130R	10160009	2021.09.05
25	Power Meter	KEYSIGHT	N1911A	MY50520168	2021.09.05
26	Frequency Meter	VICTOR	VC2000	997406086	2021.09.05
27	DC Power Source	HYELEC	HY5020E	055161818	2021.09.05
Test software					
1	E3	Audix	6.101223a	N/A	N/A

3. CONDUCTED EMISSIONS TEST

3.1 Conducted Power Line Emission Limit

For unintentional device, according to § 15.107(a) & RSS-Gen [8.8] Line Conducted Emission Limits is as following

Frequency (MHz)	Maximum RF Line Voltage(dB μ V)			
	CLASS A		CLASS B	
	Q.P.	Ave.	Q.P.	Ave.
0.15~0.50	79	66	66~56*	56~46*
0.50~5.00	73	60	56	46
5.00~30.0	73	60	60	50

* Decreasing linearly with the logarithm of the frequency

For intentional device, according to §15.207(a) Line Conducted Emission Limit is same as above table.

3.2 Test Setup

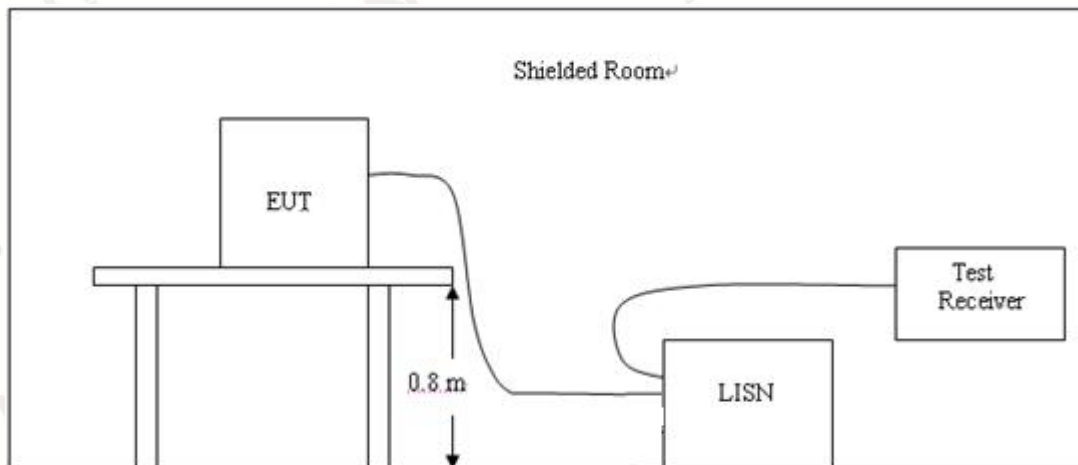

3.3 Test Procedure

- 1, The equipment was set up as per the test configuration to simulate typical actual usage per the user's manual. The EUT is a tabletop system, a wooden table with a height of 0.8 meters is used and is placed on the ground plane as per ANSI C63.10.
- 2, Support equipment, if needed, was placed as per ANSI C63.10.
- 3, All I/O cables were positioned to simulate typical actual usage as per ANSI C63.10.
- 4, If a EUT received DC power from the USB Port of Notebook PC, the PC's adapter received AC120V/60Hz power through a Line Impedance Stabilization Network (LISN) which supplied power source and was grounded to the ground plane.
- 5, All support equipments received AC power from a second LISN, if any.
- 6, The EUT test program was started. Emissions were measured on each current carrying line of the EUT using a spectrum Analyzer / Receiver connected to the LISN powering the EUT. The LISN has two monitoring points: Line 1 (Hot Side) and Line 2 (Neutral Side). Two scans were taken: one with Line 1 connected to Analyzer / Receiver and Line 2 connected to a 50 ohm load; the second scan had Line 1 connected to a 50 ohm load and Line 2 connected to the Analyzer / Receiver.
- 7, Analyzer / Receiver scanned from 150 KHz to 30MHz for emissions in each of the test modes.

3.4 Test Result

N/A

Remark:

The EUT is powered by Battery, no requirements for this item.

4. RADIATED EMISSION TEST

4.1 Radiation Limit

For unintentional device, according to § 15.109(a) & RSS-247 [5.5], except for Class A digital devices, the field strength of radiated emissions from unintentional radiators at a distance of 3 meters shall not exceed the following values:

Frequency (MHz)	Distance (Meters)	Radiated (dB μ V/m)	Radiated (μ V/m)
30-88	3	40	100
88-216	3	43.5	150
216-960	3	46	200
Above 960	3	54	500

For intentional device, according to § 15.209(a), the general requirement of field strength of radiated emissions from intentional radiators at a distance of 3 meters shall not exceed the above table.

4.2 Test Setup

1. Radiated Emission Test-Up Frequency Below 30MHz

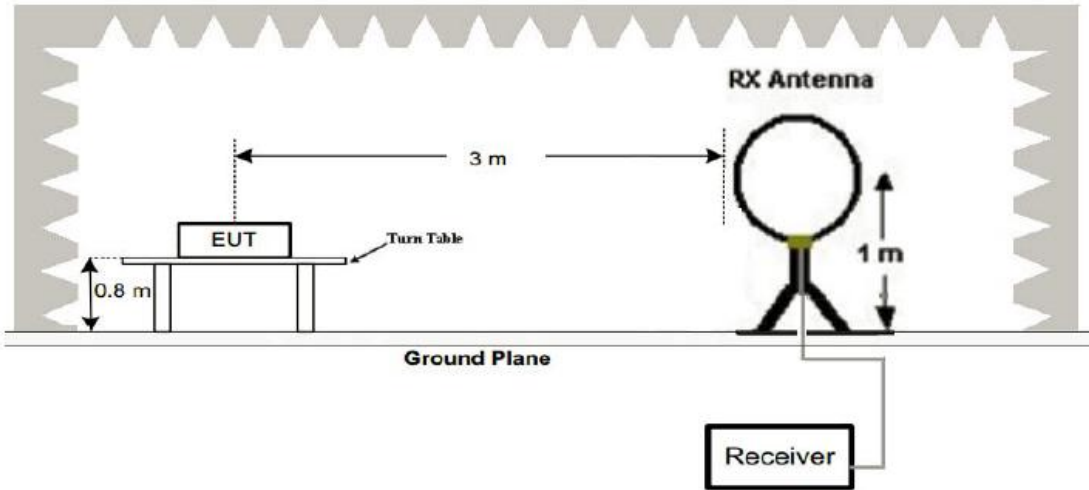

2. Radiated Emission Test-Up Frequency 30MHz~1GHz

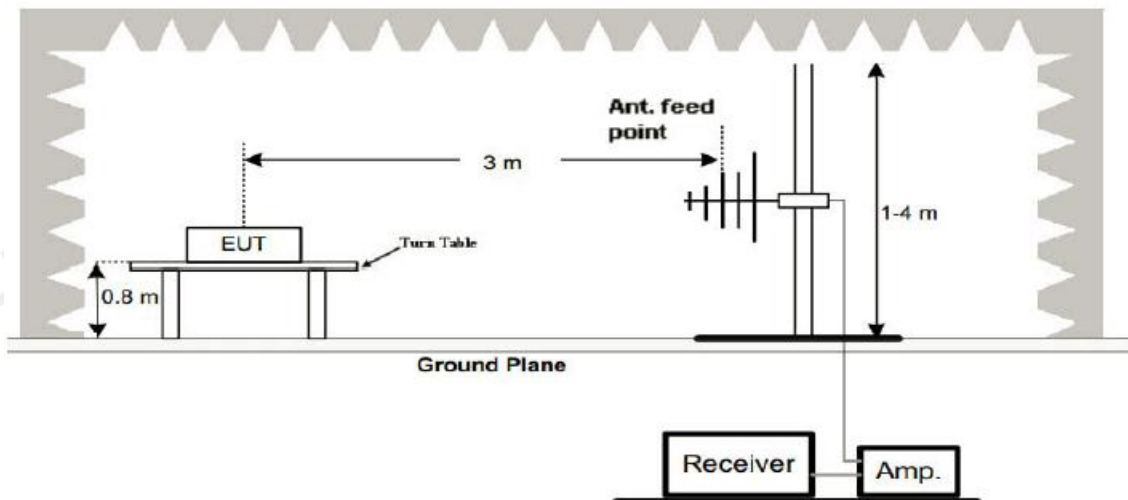

3. Radiated Emission Test-Up Frequency Above 1GHz

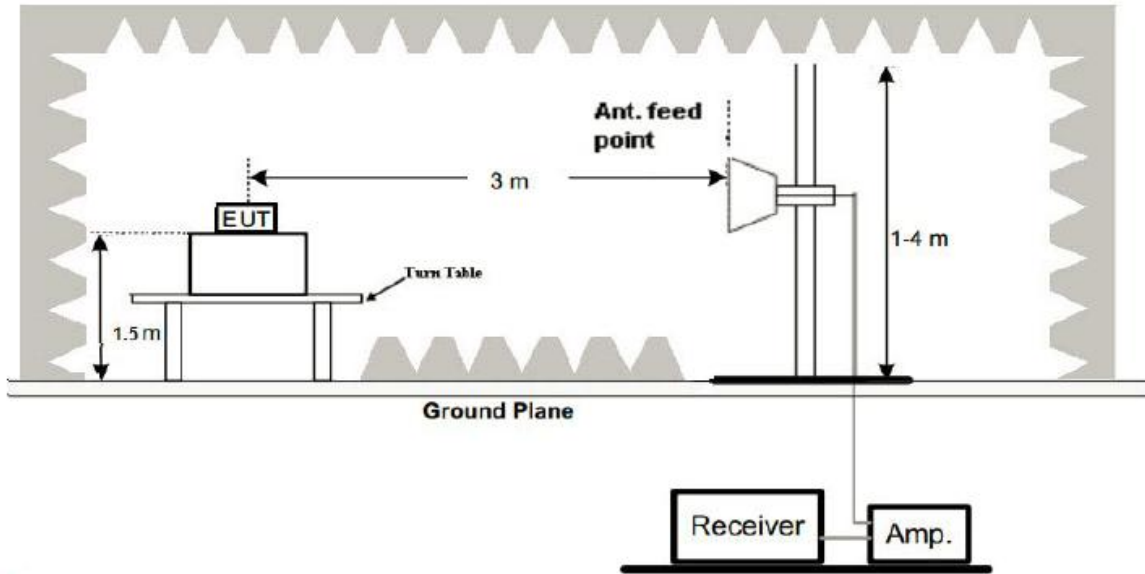

4.3 Test Procedure

1. Below 1GHz measurement the EUT is placed on turntable which is 0.8m above ground plane. And above 1GHz measurement EUT was placed on low permittivity and low tangent turn table which is 1.5m above ground plane.
2. The turntable shall be rotated for 360 degrees to determine the position of maximum emission level.
3. EUT is set 3m away from the receiving antenna, which is varied from 1m to 4m to find out the highest emissions.
4. Maximum procedure was performed on the six highest emissions to ensure EUT compliance.
5. And also, each emission was to be maximized by changing the polarization of receiving antenna both horizontal and vertical.
6. Repeat above procedures until the measurements for all frequencies are complete.
7. The test frequency range from 9KHz to 25GHz per FCC PART 15.33(a).
8. The distance between test antenna and EUT as following table states:

Test Frequency range	Test Antenna Type	Test Distance
9KHz-30MHz	Active Loop Antenna	3
30MHz-1GHz	Bilog Antenna	3
1GHz-18GHz	Horn Antenna	3
18GHz-25GHz	Horn Antenna	1

Note:

For battery operated equipment, the equipment tests shall be performed using a new battery.

4.4 Test Result

PASS
Remark:

1. We tested at Low, Middle and High channel, recored the worst data at Low channel in the report.
2. By preliminary testing and verifying three axis (X, Y and Z) position of EUT transmitted status, it was found that "Z axis" position was the worst, and test data recorded in this report.
3. Radiated emission test from 9KHz to 10th harmonic of fundamental was verified, and no emission found except system noise floor in 9KHz to 30MHz and not recorded in this report.

Below 1GHz Test Results:

Temperature:	22°C	Relative Humidity:	48%
Test Date:	Jan. 19, 2021	Pressure:	1010hPa
Test Voltage:	DC 1.5V	Polarization:	Horizontal
Test Mode:	Transmitting mode of GFSK 2405MHz		

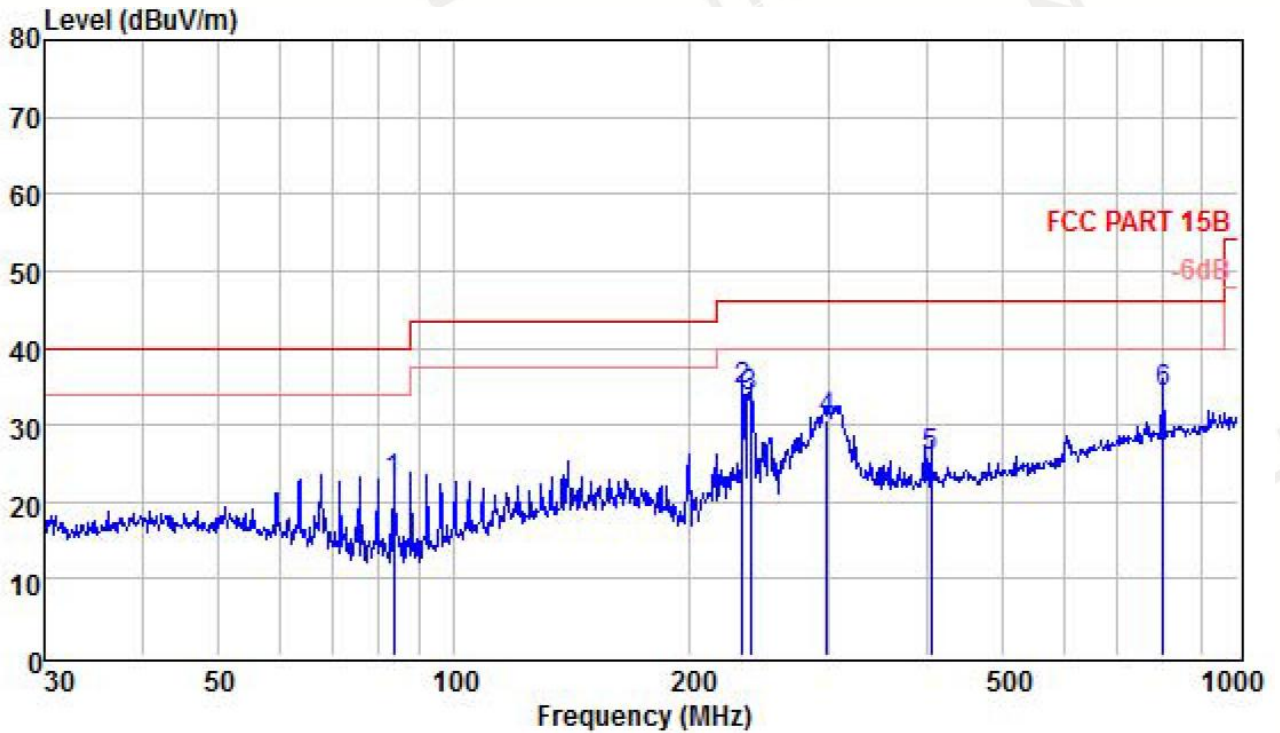

	Read	Antenna	Cable	Limit	Over	
Freq	Level	Factor	Loss	Line	Limit	Remark
MHz	dBuV	dB/m	dB	dBuV/m	dBuV/m	dB
1	83.82	12.93	8.85	0.86	22.64	40.00 -17.36 QP
2	233.35	23.13	10.62	0.87	34.62	46.00 -11.38 QP
3	238.31	21.87	10.75	0.87	33.49	46.00 -12.51 QP
4	299.32	15.79	13.88	0.85	30.52	46.00 -15.48 QP
5	406.09	8.73	15.77	1.32	25.82	46.00 -20.18 QP
6	801.79	10.19	21.73	2.19	34.11	46.00 -11.89 QP

Remark: Absolute Level = Reading Level + Factor, Margin = Absolute Level – Limit
 Factor = Ant. Factor + Cable Loss

Temperature:	22°C	Relative Humidity:	48%
Test Date:	Jan. 19, 2021	Pressure:	1010hPa
Test Voltage:	DC 1.5V	Polarization:	Vertical
Test Mode:	Transmitting mode of GFSK 2405MHz		

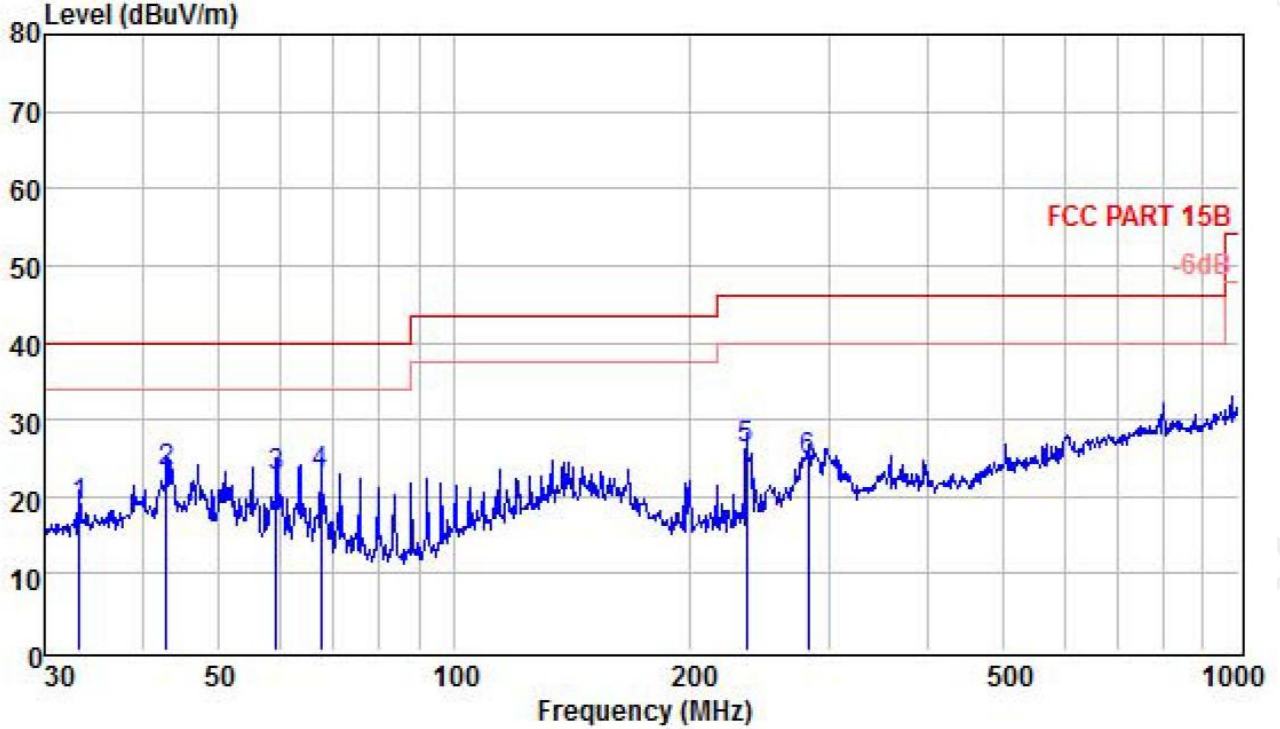

	Read	Antenna	Cable	Limit	Over	
Freq	Level	Factor	Loss	Line	Limit	Remark
MHz	dBuV	dB/m	dB	dBuV/m	dBuV/m	dB
1	33.21	5.88	12.52	0.47	18.87	40.00 -21.13 QP
2	42.90	9.56	13.49	0.27	23.32	40.00 -16.68 QP
3	59.23	10.22	11.98	0.52	22.72	40.00 -17.28 QP
4	67.44	11.67	10.50	0.75	22.92	40.00 -17.08 QP
5	235.82	14.55	10.68	0.87	26.10	46.00 -19.90 QP
6	281.99	10.44	13.45	0.85	24.74	46.00 -21.26 QP

Remark: Absolute Level = Reading Level + Factor, Margin = Absolute Level – Limit
 Factor = Ant. Factor + Cable Loss

Remark:

- (1) Measuring frequencies from 9 KHz to the 1 GHz, Radiated emission test from 9KHz to 30MHz was verified, and no any emission was found except system noise floor.
- (2) * denotes emission frequency which appearing within the Restricted Bands specified in provision of 15.205, then the general radiated emission limits in 15.209 apply.
- (3) The IF bandwidth of EMI Test Receiver between 30MHz to 1GHz was 120KHz, 1 MHz for measuring above 1 GHz, below 30MHz was 10KHz.

Above 1 GHz Test Results:
CH Low (2405MHz)

Horizontal

Frequency (MHz)	Reading Result (dBμV)	Factor (dB)	Emission Level (dBμV/m)	Limits (dBμV/m)	Margin (dB)	Detector Type
2405	112.18	-5.84	106.34	114.00	-7.66	PK
2405	83.97	-5.84	78.13	94.00	-15.87	AV
4810	62.74	-3.64	59.10	74.00	-14.90	PK
4810	51.51	-3.64	47.87	54.00	-6.13	AV
7215	58.39	-0.95	57.44	74.00	-16.56	PK
7215	48.29	-0.95	47.34	54.00	-6.66	AV

Remark: Factor = Antenna Factor + Cable Loss – Pre-amplifier. Margin = Absolute Level – Limit

Vertical

Frequency (MHz)	Reading Result (dBμV)	Factor (dB)	Emission Level (dBμV/m)	Limits (dBμV/m)	Margin (dB)	Detector Type
2405	112.51	-5.84	106.67	114.00	-7.33	PK
2405	81.35	-5.84	75.51	94.00	-18.49	AV
4810	60.57	-3.64	56.93	74.00	-17.07	PK
4810	51.24	-3.64	47.60	54.00	-6.40	AV
7215	56.39	-0.95	55.44	74.00	-18.56	PK
7215	47.33	-0.95	46.38	54.00	-7.62	AV

Remark: Factor = Antenna Factor + Cable Loss – Pre-amplifier. Margin = Absolute Level – Limit

CH Middle (2440MHz)

Horizontal

Frequency (MHz)	Reading Result (dBμV)	Factor (dB)	Emission Level (dBμV/m)	Limits (dBμV/m)	Margin (dB)	Detector Type
2440	113.09	-5.84	107.25	114.00	-6.75	PK
2440	82.33	-5.84	76.49	94.00	-17.51	AV
4880	62.54	-3.64	58.90	74.00	-15.10	PK
4880	52.32	-3.64	48.68	54.00	-5.32	AV
7320	56.55	-0.95	55.60	74.00	-18.40	PK
7320	47.18	-0.95	46.23	54.00	-7.77	AV

Remark: Factor = Antenna Factor + Cable Loss – Pre-amplifier. Margin = Absolute Level – Limit

Vertical

Frequency (MHz)	Reading Result (dBμV)	Factor (dB)	Emission Level (dBμV/m)	Limits (dBμV/m)	Margin (dB)	Detector Type
2440	112.65	-5.71	106.94	114.00	-7.06	PK
2440	82.72	-5.71	77.01	94.00	-16.99	AV
4880	61.35	-3.51	57.84	74.00	-16.16	PK
4880	50.24	-3.51	46.73	54.00	-7.27	AV
7320	56.32	-0.82	55.50	74.00	-18.50	PK
7320	46.61	-0.82	45.79	54.00	-8.21	AV

Remark: Factor = Antenna Factor + Cable Loss – Pre-amplifier. Margin = Absolute Level – Limit

CH High (2470MHz)

Horizontal

Frequency (MHz)	Reading Result (dBμV)	Factor (dB)	Emission Level (dBμV/m)	Limits (dBμV/m)	Margin (dB)	Detector Type
2470	112.32	-5.65	106.67	114.00	-7.33	PK
2470	82.92	-5.65	77.27	94.00	-16.73	AV
4940	61.21	-3.43	57.78	74.00	-16.22	PK
4940	50.34	-3.43	46.91	54.00	-7.09	AV
7410	57.65	-0.75	56.90	74.00	-17.10	PK
7410	46.44	-0.75	45.69	54.00	-8.31	AV

Remark: Factor = Antenna Factor + Cable Loss – Pre-amplifier. Margin = Absolute Level – Limit

Vertical

Frequency (MHz)	Reading Result (dBμV)	Factor (dB)	Emission Level (dBμV/m)	Limits (dBμV/m)	Margin (dB)	Detector Type
2470	115.88	-5.65	110.23	114.00	-3.77	PK
2470	82.89	-5.65	77.24	94.00	-16.76	AV
4940	61.44	-3.43	58.01	74.00	-15.99	PK
4940	50.38	-3.43	46.95	54.00	-7.05	AV
7410	57.55	-0.75	56.80	74.00	-17.20	PK
7410	46.74	-0.75	45.99	54.00	-8.01	AV

Remark: Factor = Antenna Factor + Cable Loss – Pre-amplifier. Margin = Absolute Level – Limit

Remark:

- (1) Measuring frequencies from 1 GHz to the 25 GHz.
- (2) “F” denotes fundamental frequency; “H” denotes spurious frequency. “E” denotes band edge frequency.
- (3) * denotes emission frequency which appearing within the Restricted Bands specified in provision of 15.205, then the general radiated emission limits in 15.209 apply.
- (4) Data of measurement within this frequency range shown “---” in the table above means the reading of emissions are attenuated more than 20dB below the permissible limits or the field strength is too small to be measured.
- (5) The IF bandwidth of EMI Test Receiver between 30MHz to 1GHz was 120KHz, 1 MHz for measuring above 1 GHz, below 30MHz was 10KHz. The resolution bandwidth of test receiver/spectrum analyzer is 1MHz and video bandwidth is 3MHz for peak measurement with peak detector at frequency above 1GHz. The resolution bandwidth of test receiver/spectrum analyzer is 1MHz and video bandwidth is 10Hz for Average measurement with peak detection at frequency above 1GHz.
- (6) When the test results of Peak Detected below the limits of Average Detected, the Average Detected is not need completed. For example: Top Channel at Fundamental 73.16dBuV/m(PK Value) <93.98(AV Limit), at harmonic 53.20 dBuV/m(PK Value) <54 dBuV/m(AV Limit), the Average Detected not need to completed.
- (7) All modes of operation were investigated and the worst-case emissions are reported.

5. BAND EDGE

5.1 Limits

FCC PART 15.249 Emissions radiated outside of the specified frequency bands, except for harmonics, shall be attenuated by at least 20 dB below the level of the fundamental or to the general radiated emission limits in §15.209, whichever is the lesser attenuation.

5.2 Test Procedure

The band edge compliance of RF radiated emission should be measured by following the guidance in ANSI C63.10 with respect to maximizing the emission by rotating the EUT, measuring the emission while the EUT is situated in three orthogonal planes (if appropriate), adjusting the measurement antenna height and polarization etc. Set RBW to 1MHz and VBM to 3MHz to measure the peak field strength and set RBW to 1MHz and VBW to 10kHz to measure the average radiated field strength. The conducted RF band edge was measured by using a spectrum analyzer. Set span wide enough to capture the highest in-band emission and the emission at the band edge. Set RBW to 100 KHz and VBW to 300 KHz, to measure the conducted peak band edge.

5.3 Test Result

PASS

Radiated Band Edge Test:

Operation Mode: TX CH Low (2405MHz)

Horizontal

Frequency (MHz)	Reading Result (dBμV)	Factor (dB)	Emission Level (dBμV/m)	Limits (dBμV/m)	Margin (dB)	Detector Type
2310	52.22	-5.81	46.41	74.00	-27.59	PK
2310	/	-5.81	/	54.00	/	AV
2390	52.19	-5.84	46.35	74.00	-27.65	PK
2390	/	-5.84	/	54.00	/	AV
2400	52.15	-5.84	46.31	74.00	-27.69	PK
2400	/	-5.84	/	54.00	/	AV

Remark: Factor = Antenna Factor + Cable Loss – Pre-amplifier.

Vertical

Frequency (MHz)	Reading Result (dBμV)	Factor (dB)	Emission Level (dBμV/m)	Limits (dBμV/m)	Margin (dB)	Detector Type
2310	52.85	-5.81	47.04	74.00	-26.96	PK
2310	/	-5.81	/	54.00	/	AV
2390	52.63	-5.81	46.82	74.00	-27.18	PK
2390	/	-5.84	/	54.00	/	AV
2400	52.58	-5.84	46.74	74.00	-27.26	PK
2400	/	-5.84	/	54.00	/	AV

Remark: Factor = Antenna Factor + Cable Loss – Pre-amplifier.

Operation Mode: TX CH High (2470MHz)

Horizontal

Frequency (MHz)	Reading Result (dBμV)	Factor (dB)	Emission Level (dBμV/m)	Limits (dBμV/m)	Margin (dB)	Detector Type
2483.5	52.75	-5.65	47.10	74.00	-26.90	PK
2483.5	/	-5.65	/	54.00	/	AV
2500	52.68	-5.72	46.96	74.00	-27.04	PK
2500	/	-5.72	/	54.00	/	AV

Remark: Factor = Antenna Factor + Cable Loss – Pre-amplifier.

Vertical

Frequency (MHz)	Reading Result (dBμV)	Factor (dB)	Emission Level (dBμV/m)	Limits (dBμV/m)	Margin (dB)	Detector Type
2483.5	52.37	-5.65	46.72	74.00	-27.28	PK
2483.5	/	-5.65	/	54.00	/	AV
2500	52.62	-5.72	46.90	74.00	-27.10	PK
2500	/	-5.72	/	54.00	/	AV

Remark: Factor = Antenna Factor + Cable Loss – Pre-amplifier.

6. OCCUPIED BANDWIDTH MEASUREMENT

6.1 Test Setup

Same as Radiated Emission Measurement

6.2 Test Procedure

1. The EUT was placed on a turn table which is 0.8m above ground plane.
2. Set EUT as normal operation.
3. Based on ANSI C63.10 section 6.9.2: RBW=30KHz, VBW=100KHz, Span=3MHz.
4. The useful radiated emission from the EUT was detected by the spectrum analyser with peak detector.

6.3 Measurement Equipment Used

Same as Radiated Emission Measurement

6.4 Test Result

PASS

GFSK Modulation:

Frequency (MHz)	20dB Bandwidth (MHz)	99% Bandwidth (MHz)	Result
2405	2.394	2.275	PASS
2440	2.911	2.619	PASS
2470	2.406	2.302	PASS

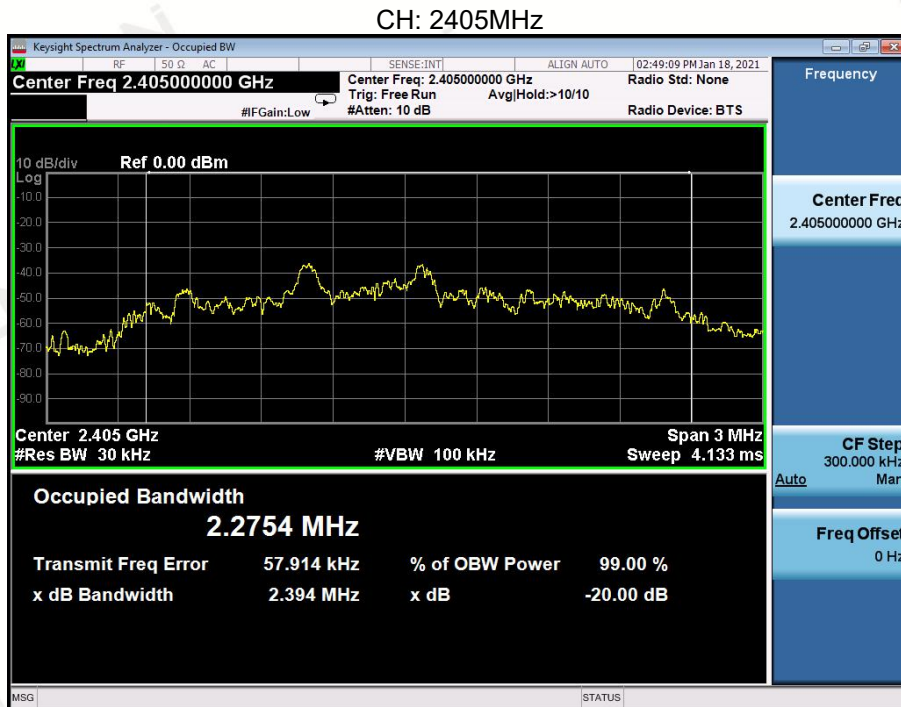

CH: 2440MHz

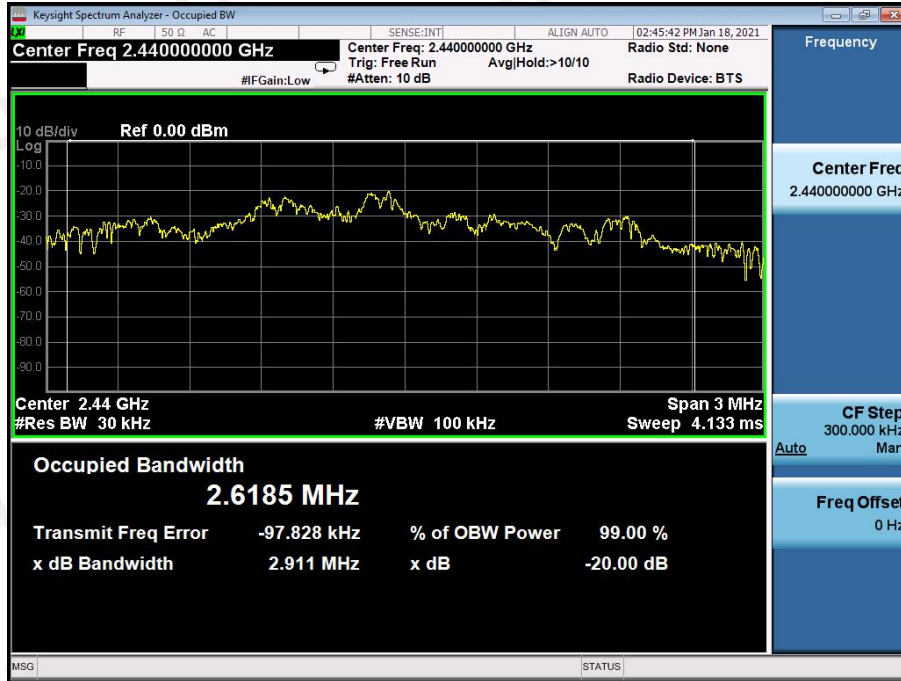

CH: 2470MHz

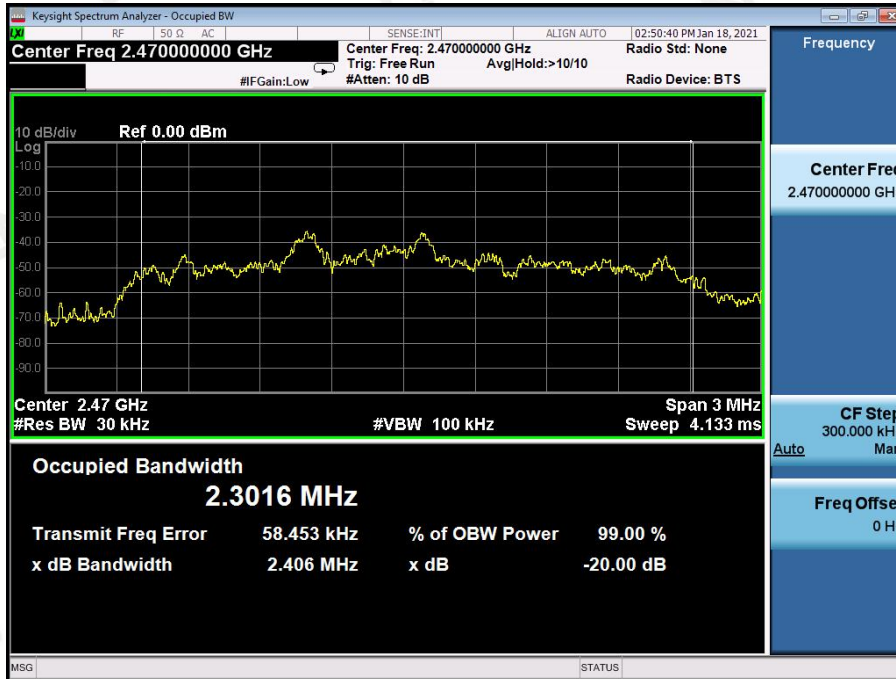

7. ANTENNA REQUIREMENT

Standard Applicable:

For intentional device, according to FCC 47 CFR Section 15.203, an intentional radiator shall be designed to ensure that no antenna other than that furnished by the responsible party shall be used with the device.

Antenna Connected Construction

The antenna used in this product is an PCB Antenna, The directional gains of antenna used for transmitting is 1.34dBi.

BT ANTENNA:

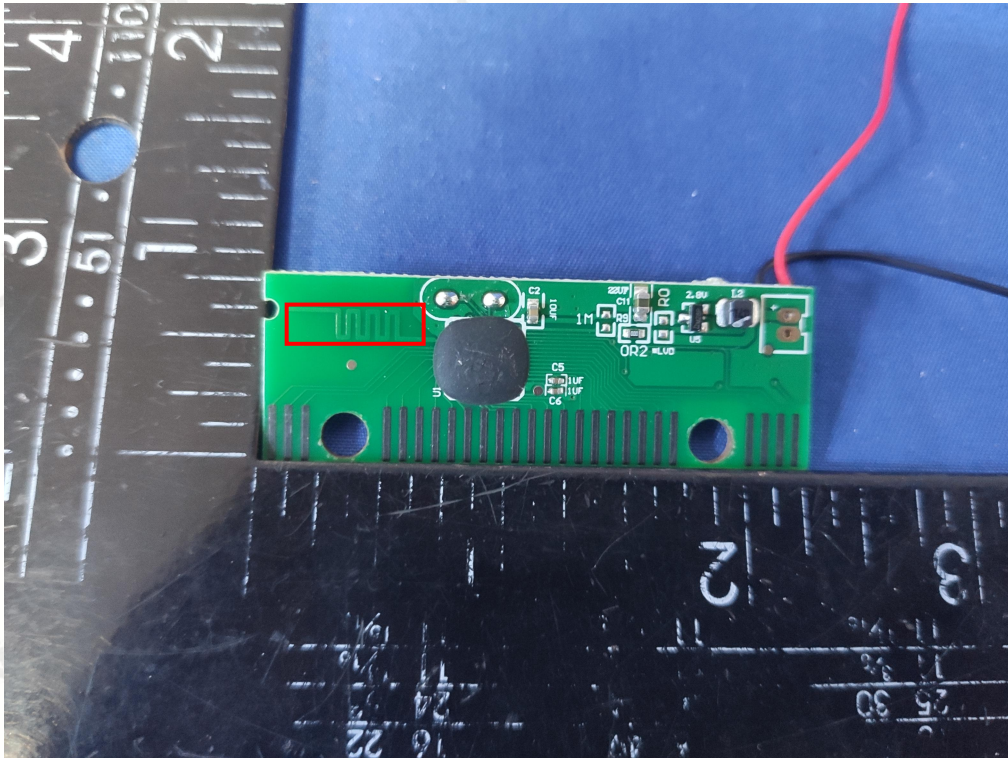

8. PHOTOGRAPH OF TEST

**Radiated Emission
(Below 1G)**



**Radiated Emission
(Above 1G)**



End of Report